

Analog Technology Trends and the Importance of Human Resources Development

—Centered on the New-Era Analog Technology Seen in CMOS High-Frequency LSI—

MINORU NOMURA

Information and Communications Research Unit

1 Introduction

The Third Science and Technology Basic Plan designates and prioritizes 10 strategic sciences and technologies in the field of information and communications. They include “Technology for use with ubiquitous networks that supplement people’s abilities and support their lives.” Wireless communication plays an important role in infrastructure for the creation of ubiquitous networks. Wireless communications in mobile telephones, close-range wireless*¹ devices, and so on are becoming ever more advanced and diverse. Advanced new-era analog technology is necessary in order to realize them.

Advances in LSI miniaturization have brought about the SoC (system on a chip) era, with a single SoC requiring a mixture of digital and analog circuits. The development of analog circuits has come to have a major impact on the development period of LSI as a whole and on product viability. Furthermore, using digital alone, it is becoming increasingly difficult to obtain added value from products. Analog technology is becoming radically more important as a source of added value.

Although analog technology is valuable in these ways, there is a worldwide shortage of analog engineers. Many nations recognize the importance of new-era analog technology and are vigorously promoting R&D as well as human resources development.

This article will focus on “CMOS analog RF

system LSI*²,” an advanced analog technology needed as wireless communication infrastructure, and will discuss what analog technology is, why it is necessary now, trends in its research and development, and issues surrounding it, and will propose necessary policies for improvement.

2 What is analog technology?

2-1 Analog and digital^[1]

Analog information expresses the state of substances, systems, and so on through continuously varying physical values. Familiar things such as temperature, speed, pressure, flow, and human voices, are all analog. Analog data converted to continuous electrical values are analog signals.

Digital information, in contrast, is in discretely countable form. Inside computers and other kinds of electronic equipment, the presence or absence of electrical pulses is interpreted as the two digits “0” and “1” of the binary numerical system, and digital signals expressing digital values are used to achieve electronic function.

2-2 How analog technology is used

Analog technology is in heavy use all around us. This includes, for example, human interface components of displays, speakers, and microphones; analog circuits in wireless components; conversion components at the interface between digital and analog; cameras; and sensors. The analog circuits of mobile telephones, for example, include antennas,

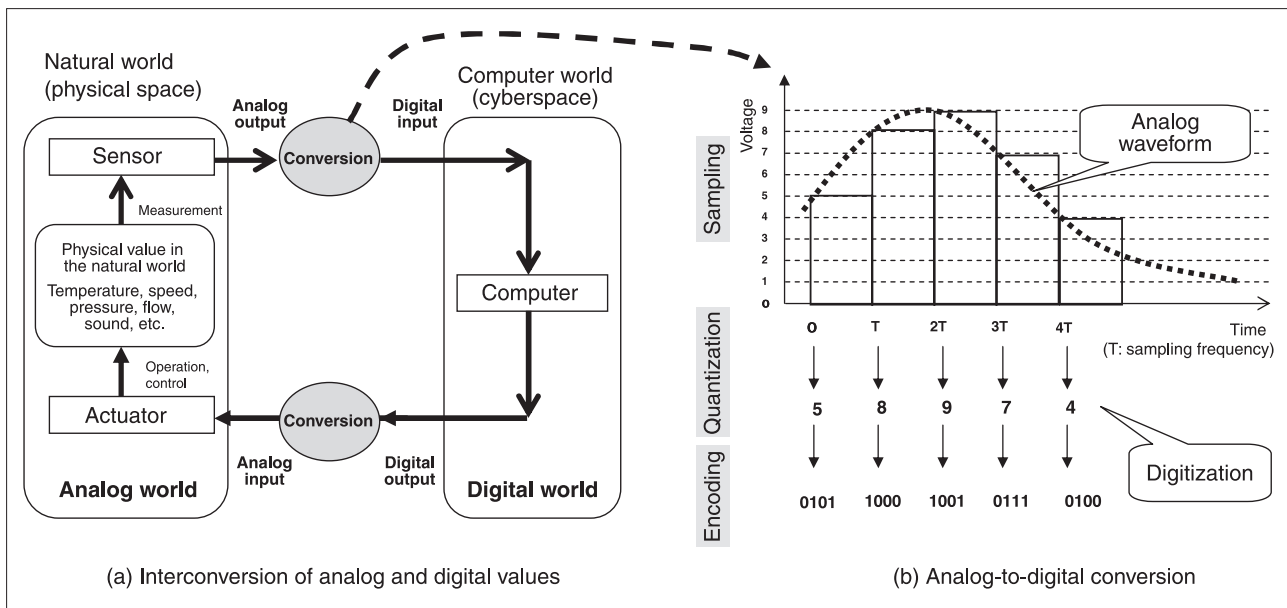

Figure 1 : Interconversion of analog and digital values

Compiled by the STFC based on Reference^[1]

displays, cameras, chargers, telecommunications devices, human interfaces, biometric authentication, telephone functions, and two-way data transmission. On the function side, low-noise and noise-elimination technologies are used because it is easy for noise to mix with the input of fine signals from the outside. For outputs to the outside such as displays and speakers operation, technologies for reproducing true signals without distortion are used^[2].

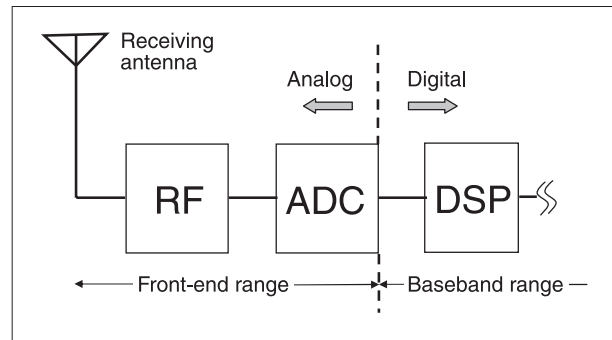

Figure 2 : Receiving circuit structure

Prepared by the STFC based on Reference^[5]

2-3 Examples of analog processing

(1) Analog-to-digital /

digital-to-analog conversion

This article will describe how information from the outside is processed digitally. Figure 1(a) illustrates the interconversion of analog and digital values. For analog signals to be processed in the computer world (cyberspace), they must be translated into data that computers can read. That is, conversion to digital values (analog-to-digital conversion, ADC) is necessary. Then, for the results processed inside computers to return to the analog world outside, conversion from digital signals to analog signals (digital-to-analog conversion, DAC) is necessary.

Figure 1(b) illustrates ADC function. At each sampling time (T), the value of an analog waveform (in this case, a voltage value) is measured, and then digitization takes place to convert the information to binary notation, which

a computer can read. The number of bits that represent a data point is called resolution. For example, digital cameras have a resolution of 10-12 bits, while CDs have 16-bit resolution. DAC is the opposite process.

(2) Analog processing in mobile telephones

Inside mobile telephones, numerous cutting-edge analog technologies are used along with digital technologies. Figure 2 shows the basic receiving circuit structure. The electronic circuit domain can be roughly divided into the front-end range and the baseband range depending on the frequency bands to be handled. RF and ADC to the left of the dotted line belong to the front-end range, while DSP (digital signal processing) to the right of the line belongs to the baseband range (electronic circuit domain where digital processing takes place). In the front-end

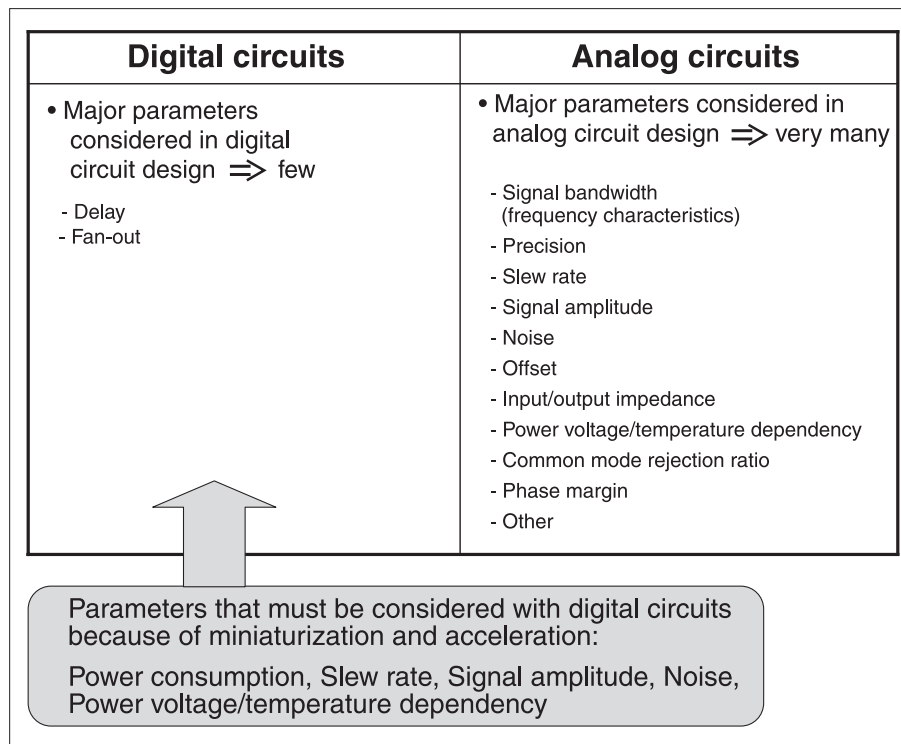

Figure 3 : Complexity in analog circuit design

Compiled by the STFC based on Reference^[9]

range, weak radio waves received by receiving antennas are amplified, and analog technology is used to remove carrier waves from received signals. Transmission circuits are the opposite. In the front-end range, signals must be placed on high-frequency carrier waves and transmitted as radio waves. Analog technology achieves efficient transmission of high-frequency electric power.

2-4 Differences in the design of analog and digital circuits

Here the article will contrast analog and digital circuits.

One example of the education of digital circuit designers is a course on simple gate arrays^[3]. The program begins with Boolean algebra, and over the course of several weeks students acquire the basic ability to assemble logic circuits. With digital circuits, circuits made of transistors and elements are black-boxed, so designers need to think only of logic gates, the macro functions that combine them, and the relationships among their input and output terminals. Understanding of circuit details in gates and macro are therefore not necessarily required. Furthermore, there are not that many different types of gates and flip-flops.

On the other hand, analog circuit design deals with the transistor and element level, so entire circuits must be considered. Moreover, as illustrated in Figure 3, many parameters must be considered in their design. An error in one place will have a major impact on the entire circuit. Designers must consider characteristics such as circuit frequency response^[4] that need not be considered with digital circuits. In analog circuit design, the insistence on solving formulas requires massive calculations, so approximations are common. It is thus necessary for designers to polish their sense of how to use frequencies, element values, and so on to simplify circuit models^[4]. Therefore, acquiring the expertise to develop sophisticated analog circuits requires years of education.

Furthermore, analog LSI design is not merely the design of circuits. Designers must think at the system and block levels and consider the package layout to meet performance requirements. On the manufacturing side, consideration of device technology and process variation is essential. The final step requires that the specified performance is achieved with the packaging and boards. Some say that a person who merely designs circuits is not really an analog designer.

Figure 3 illustrates the fact that with miniaturization and acceleration, digital design also requires consideration of an increasing number of parameters.

2-5 Analog technology in digitization

Analog technology is thus essential for electronic equipment, but it has not been given sufficiently serious consideration in recent years because efforts have focused on digital technology. Osaka University Professor Taniguchi provides a frank discussion of that history and current conditions, stating, "Digital circuits spread explosively during the second half of the 1980s, and many analog circuit engineers were shifted to digital circuit design. It became clear, however, that knowledge of analog circuit design is necessary in order to draw advanced performance from digital circuits. Young engineers have almost no experience with analog circuit design. Very few universities in Japan provide education in CMOS analog circuit design, so there can be no expectation of newcomers"^[5].

While there are currently few Japanese manufacturers who are proficient in analog technology, they do exist. However, many major corporations position digital-type semiconductors as a core business and have shifted design development and production technology to that area. This has been pointed out as related to Japan's increasing weakness in the area of analog semiconductors^[6].

3 Why analog technology now?

3-1 A paradigm shift from PCs to communication: an increase in analog-combination SoC

SoC is used mainly in digital appliances, mobile telephones, automobile electronic equipment, and so on. They are large specialized LSI circuits that concentrate many necessary functions. Their aim is to incorporate complete electronic device systems in silicon LSI. For example, with digital television, semiconductors account for about 50% of the cost structure, about the same as for PCs (personal computers). For electronic equipment as a whole, SoC provides significant benefits in reduced size, advanced performance, and diversified function, as well as lower costs.

Furthermore, SoC is being aggressively pursued as a solution to the problem of electromagnetic radiation leakage between chips in the same package, because it reduces several chips to one chip. Against this background, SoC use is continuously expanding. It is no exaggeration to say that electronic equipment development today is synonymous with SoC development^[7].

Furthermore, the driving force behind semiconductor development is shifting from the PC sector to communications. For the past 20 years, most of the world's semiconductors have been intended for use in the PC sector, but looking at sales percentages in the world semiconductor market, in 2000 the communications sector surpassed the PC sector for the first time. During the PC era, the main semiconductor structural elements were microprocessors and memory, but with the advent of the Internet era, the importance of DSP (digital signal processing) and analog functions has increased significantly^[8]. Therefore, the inclusion of communications functions in SoC development has naturally become important, and demand for combined analog and digital SoC (mixed signal SoC) is increasing. During the first half of 2006, semiconductor sales grew by 8% compared to the previous year. In contrast to a drop in processors for PC use, semiconductors for mobile telephones grew, underlining the shift towards communications^[9].

3-2 The impact of analog circuits on SoC development

When analog circuits are combined with digital circuits in SoC, design of the analog circuit domain has a significant impact on SoC development.

First, it impacts the area of the LSI. Analog circuits cannot be expected to benefit from the CMOS miniaturization effect to the same extent as digital circuits. This is because suitable physical domains are necessary to obtain the needed performance from elements such as inductors and condensers, and it is necessary to secure symmetrical layouts for the differential amps used to amplify weak signals. Layouts that are resistant to noise require a large area.

Second, there is an impact related to the design

automation (EDA: electronic design automation) tools that support analog design. Analog design directly lays out transistors and devices for capacity and resistance, estimates their electrical performance, and simulates the circuits. During the design process, the primitive and painstaking method of using specialized tools to bring the design data near completion is prevalent^[10]. Analog circuit verification conventionally has taken place with analog circuit simulators such as SPICE. Compared to digital circuit verification, this requires a great deal of processing time and a long period of verification. Furthermore, because the parasitic capacitance of wiring and other variables affect circuit characteristics, circuit design and layout design must be repeated through many iterations. This is also a major contributor to long design periods.

In these ways, analog circuit development periods and performance have a major impact on the whole of LSI development and product viability. Because analog circuitry was used separately from LSI in the past, these problems did not surface. With advances in SoC, however, they have become a major focus.

3-3 Securing future product superiority

Design automation has made great progress in the area of digital circuit development. It

has evolved to the point where designers can produce the desired circuits simply by using design description language to specify the LSI functions needed. While some effort is required to verify that an LSI is operating properly, taken to its extreme this means that anyone can create the same product, using digital technology alone, which makes it difficult to establish product superiority. Securing product superiority in the future will require a redirection of conventional vision towards areas such as devising architecture. Analog technology enables greater product differentiation than digital, and is not easy for competitors to imitate. For example, with digital, copying the wiring pattern will obtain roughly similar performance, but with analog, that is not necessarily the case. Analog usually requires other expertise^[11]. In SoC today, analog circuits have come to be combined with digital, becoming a major element in product superiority. Accordingly, analog technology is playing an increasingly important role in securing product superiority.

3-4 The analog business is brisk

Figure 4 shows the Semiconductor Industry Forecast Autumn 2006 of World Semiconductor Trade Statistics (WSTS). According to this forecast, the size of the world semiconductor

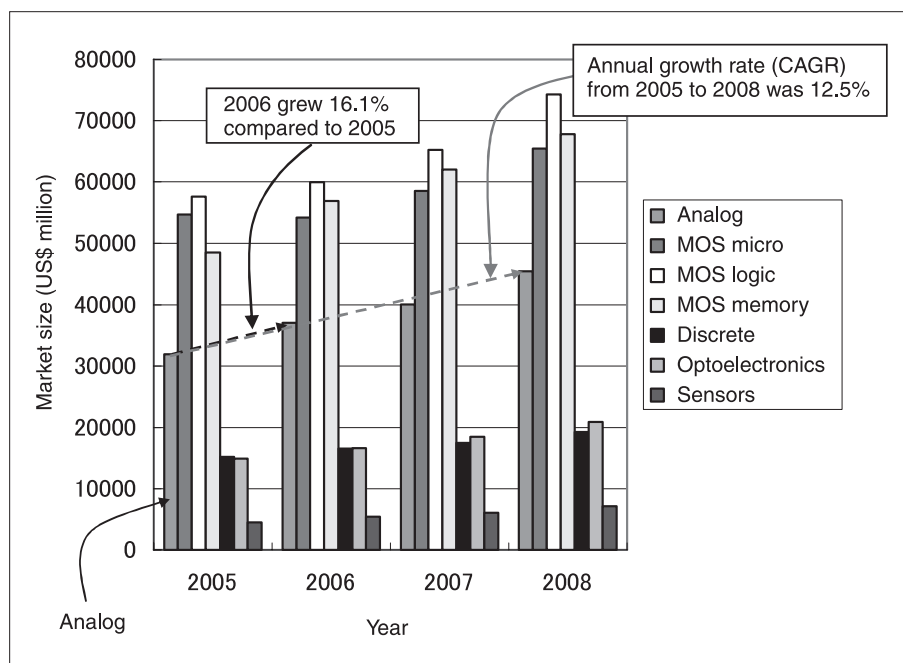

Figure 4 : World Semiconductor Industry Forecast Autumn 2006

Compiled by the STFC based on WSTS October 2006

market in 2006 was expected to grow by 8.5 percent from the previous year, to US \$246.8 billion. By product, the market forecast for IC as a whole in 2006 was an 8.0 percent annual increase, to US \$208.2 billion.

Within this, MOS memory increased significantly, by 17.3 percent to US \$56.9 billion, as did analog, by 16.1 percent to US \$37.1 billion. MOS logic, however, increased only slightly, by 3.9 percent to US \$59.9 billion, while MOS micro decreased by 0.8 percent to US \$54.2 billion. This indicates the overall large growth in analog. Furthermore, sensors, which are heavy users of analog technology, grew by 19.2 percent. Growth rates from 2005 through 2008 were high at 12.5 percent for analog and 16.3 percent for sensors^[12].

Because the above forecast should include combined analog-digital in MOS logic and analog functions in discrete, one may conclude that the actual size of the analog market is even larger. In the future, analog technology will also be used in areas related to extended human interfaces, such as flat panels, digital TV, ultrahigh-speed wireless communications, in-vehicle systems, and robots. Analog technology will be the basis for the creation of new businesses such as sensor networks, services using RFID, context-aware devices, and so on in the coming ubiquitous era.

4

Research and development trends in analog technology centered on analog RF

4-1 Growth of analog research seen in conference presentations

Figure 5 provides an overview of the state of analog-related activity (not limited to analog RF) at the International Solid-State Circuits Conference (ISSCC), where leading-edge semiconductor technology is presented. Whether the proposed circuits have actually been reduced to practice is an important criterion for acceptance of papers at ISSCC, so the conference's presentations provide an insight into trends in working technology. As the chart illustrates, the number of analog-related sessions increased steadily from 1985 to 1995, and again 2005, indicating how much attention analog is receiving. A striking recent trend is the jump in wireless-related applications.

4-2 Research and development trends in various countries

(1) Research and development trends in the USA

The United States of America has many outstanding manufacturers and venture

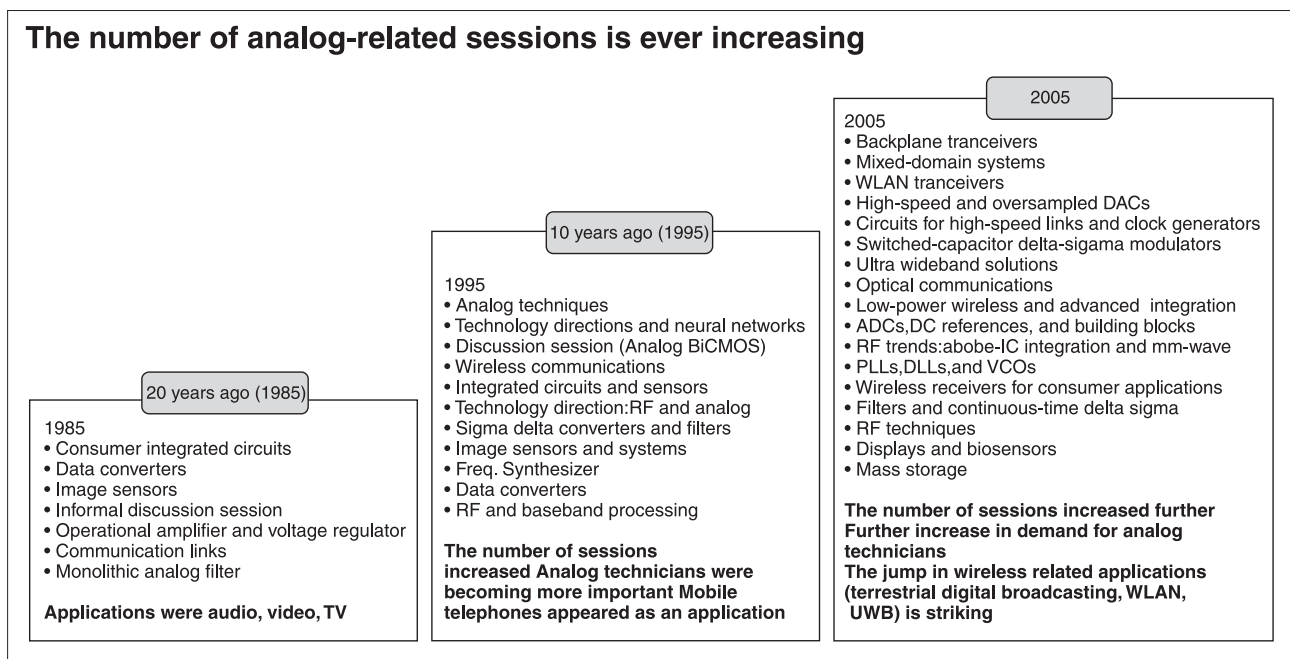

Figure 5 : The number of analog-related sessions at ISSCC

ISSCC: International Solid-State Circuits Conference

Compiled by the STFC based on Reference^[24]

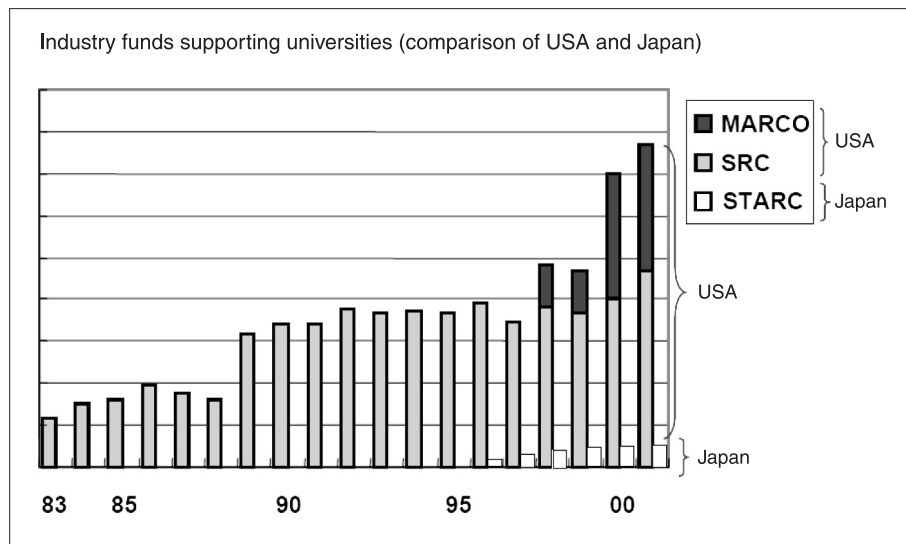

Figure 6 : Industry support for universities

MACRO : Microelectronics Advanced Research Corporation

SRC : semiconductor Research Corporation

STARC : Semiconductor Technology Academic Research Center

Provided by the Semiconductor Technology Academic Research Center

corporations that specialize in analog technology. Analog-related research is flourishing at universities such as UC Berkeley, UCLA, Stanford University, MIT, Oregon State University, the California Institute of Technology, and the University of Florida. UC Berkeley's Wireless Research Center is an example of leading-edge research. Since 2002, it has been carrying out research on 60-GHz CMOS radio systems^[13]. Universities have created many ventures, such as Broadcom Corporation started by UCLA and Atheros Communications started by Stanford University.

As for existing corporations, IBM's forte is high frequency. It has a leading-edge foundry that can handle silicon-germanium and can develop and manufacture high-frequency-related circuits. Texas Instruments (TI) is particularly adept in products using digital signal processing (DSP), especially mobile telephone-related LSI products, and is making advances in the field of high-performance analog products for x-ray CT diagnostic equipment. Intel's core business is microprocessors (MPUs), but it is also strong in wireless-related products, drafting standards for wireless protocols such as Bluetooth and WiMax. In 2004, the general-use analog market accounted for about 6 percent of the entire semiconductor market. The top five companies, including TI, Analog Devices, and National Semiconductor, are American. They account for almost 60 percent of

world market share^[6].

In these ways, both universities and corporations in the USA are very strong in analog research and development. For the past 20 years, industry in the USA has strongly supported universities, in other fields as well as analog. This has become a driving force for university activities. Figure 6 illustrates semiconductor-related support for universities by industry. There is a large gap in Japanese support.

(2) Research and development trends in Europe

Europe also has many corporations with well developed analog technology for communications and industrial uses (e.g., CT scanning). European corporations were at the heart of the creation of standards for communications protocols such as GSM (global system for mobile communications^{*5}) and ADSL (asymmetric digital subscriber line). Major universities or research centers engaged in analog research include the Netherlands' Delft University of Technology, Eindhoven University of Technology, and University of Twente, Belgium's IMEC (Interuniversity Microelectronics Center^{*6}) and KUL (Katholieke Universiteit Leuven), Italy's University of Pavia, Finland's Helsinki University of Technology, and Switzerland's Swiss Federal Institute of Technology (ETH Zurich).

The industry-academia-government project NANOCMOS is one of a number of projects

related to the EU's 6th Framework Program, and capital is being invested in MINATEC*⁷ and IMEC. MINATEC's research on wireless terminals positions CMOS RF and reconfigurable hardware as future key technologies^[14]. The research program of France's LETI (Laboratoire d'Electronique de Technologie de l'Information) takes on wireless technology in leading-edge devices, engaging in RF front-end device development^[15].

(3) Research and development trends in Asia

(i) Research and development trends in Taiwan

Taiwan positioned semiconductor research and development as primary industrial development (Industrial Evolution) from 1980-2000, but shifted it to secondary industrial development in 2001-2020. Taiwan moved to a design-weighted strategy by initiating the Si-Soft project as a driving force for secondary industrial development in 2001. The motivation for setting up Si-Soft was the idea that in the past Taiwan successfully shifted from a labor-intensive to a capital-intensive economy, but in the future it should shift to a knowledge-intensive one. The project's goal is to convert to a powerful industrial structure based on new design methods, design environments, and manufacturing.

Taiwan promoted the NSoC (National SoC) program as an SoC development strategy to strengthen industrial prowess and thereby generate high added-value products. The NSoC program's first phase (2003-2005) promoted five plans, human resources development, product development, platform maintenance, IP (intellectual property), and new-industry development. The result was that after having no papers accepted at ISSCC in 2002, Taiwan experienced a rapid increase, with 3 accepted in 2003, 6 in 2004, 15 in 2005, and 18 in 2006. Furthermore, the number of papers accepted at the International Symposium on Circuits and Systems (ISCAS) rose from 87 in 2003 to 106 in 2004 and 202 in 2005, second only to the USA. Currently, the NSoC program is in the second phase (2006-2010), promoting three plans: innovative SoC product technology, leading-edge SoC design technology, and leading-edge SoC

design environments. Three taskforces have been set up, one of which is RF and Mixed Signal Circuit Design. Research and development of analog RF technology is playing a major role^[16].

Taiwan's government is providing abundant funding for the infrastructure needed for education and research related to LSI design. The National Chip Implementation Center (CIC) is an organization under the umbrella of the National Applied Research Laboratories (NARL). It assists Taiwan's universities and research institutions financially. It supports the maintenance of EDA used for design, trial production of designed LSI, and so on. Trial production services for LSI include testing and measurement^[17].

(ii) Research and development trends in South Korea

A great deal of research on CMOS analog RF is carried out at South Korean universities. Research on CDMA (code division multiple access) began to flourish in the early 1990s. Many universities began research on wireless in 1995, and the number of papers increased. Recently, there have also been presentations covering systems. Looking at the content of presentations at the RF Integrated Circuit Technology Workshop (an annual event; this year's will be the sixth) held in South Korea in September 2006, sessions on mobile communication, automobiles and milliwaves, WPAN/WLAN, reconfigurable RF, and so on were held. Of the 23 presenters, 10 were from corporations, 9 from universities, and the remainder from other research institutions^[18].

4-3 Research and development trends in Japan

Figure 7 shows the number of wireless and analog RF-related papers presented by corporations and universities at the February 2006 ISSCC. Compared to other countries, Japan had very few papers from universities. From 1992 through 2001 as well, the number of papers presented by universities alone or universities in joint research was much lower than for the USA and Europe^[20].

However, one cannot simply blame Japan's universities for this problem. Developing leading-edge analog technology is not at all easy

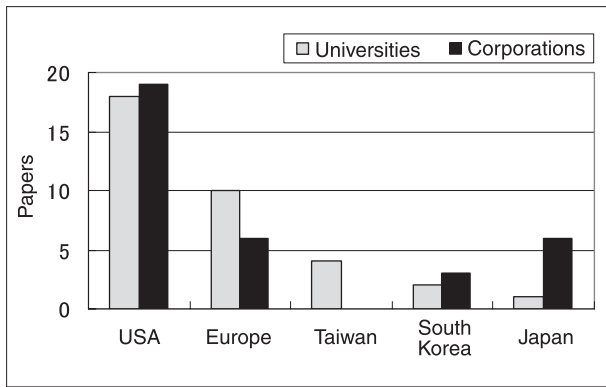

Figure 7 : Number of analog-related papers at ISSCC 2006

Compiled by the STFC based on Reference^[19]

for corporations either. As described above, semiconductor corporations and governments in Europe, the USA, Taiwan, South Korea, and elsewhere have supported universities in this research. This has resulted in leading-edge research, as in the case of UC Berkeley.

Below, this article describes analog technology research and development trends occurring in Japan. The results, however, have not yet manifested themselves in numbers such as those in Figure 7.

(1) Technical committees and groups on analog RF technologies

(activities of academic and other societies)

The Technical Committee on Silicon Analog RF Technologies was established for the period from February 2004 through March 2007. Its members are experts representing Japanese universities and corporations. Its statement of purpose says, "In silicon LSI, RF technology has become important in both wireless applications and digital LSI applications. Aiming towards the realization of microwave circuit technology centered on compound semiconductors with CMOS, the Society will form technical committees and groups including universities along with related corporations that will provide venues for discussion of technology, contributing to the further vitalization of this field and to the holding of international conferences." Research fields span a wide range of analog RF-related areas, including circuit technology, wiring technology, measurement technology, modeling technology, and electromagnetic field simulation technology. The technical committee has met 10

times to date.

(2) Development of textbooks on analog RF by STARC (initiatives in industry-academia collaboration)

Eleven Japanese semiconductor companies provided the funds to start STARC in 1996. In April 2006, it began the "Asuka II Project," a five-year plan. The project's programs include "development of new textbooks through industry-academia collaboration." The analog RF textbooks (basic edition and applied edition) are scheduled for completion by the end of March 2008. Through collaboration among Tokyo Institute of Technology (Professor Akira Matsuzawa), the University of Tokyo/VDEC (VLSI Design and Education Center; Professor Asada), the University of Tokyo (Associate Professor Fujishima), and STARC, the aim is to create practical textbooks based on actual data.

(3) Example of education at universities

Research groups and seminars are forming at several universities^[21]. This article will examine the case of the seminar on high-frequency evaluation technology at Tokyo Institute of Technology as an example. Since August 2006, the institute has offered a class on "Advanced High-frequency Measurement Engineering" in cooperation with an instrumentation company. Its purpose is to teach students basic knowledge in topics related to high frequency. For example, it provides students with an understanding of the characteristics peculiar to microwaves, microwave transmission lines, parameters used with various types of high frequencies, types of devices in high-frequency circuits, noise, and frequency spectrums, teaches them how to use instruments, and provides training on trial production and measurement of high-frequency circuits. Such basic knowledge is essential for students who wish to engage in research on the high-frequency domain, where modulation methods for mobile telephones are diversifying. The course is open, so students from other universities can also attend.

(4) Example of a regional initiative

Regional initiatives are being carried out

by Gunma Prefecture, Fukuoka Prefecture (Kitakyushu City), and others. This article will examine the case of Gunma Prefecture, which has a long history of manufacturing and ranks about 10th in Japan. It has many corporations with technological prowess in the fields of analog integrated circuit design (semiconductor manufacturers), and electronic products (electronics manufacturers) that use the circuits. Collaboration in the electronics field is taking place, centering on Gunma University's Faculty of Engineering. It promotes the Analog Integrated Circuit Society (established in October 2003; its main activity is lectures on technology), joint industry-academia analog-related human resources development (lectures and internships), joint industry-academia research (promoted at the national level), and so on. Centering on alumni in corporations, it promotes the practical education of mid-level engineers for the purposes of analog technology education, transmission of know-how, and consulting. In addition, several Gunma-based electronics manufacturers and Gunma University's Faculty of Engineering are cooperating on activities to strengthen industry, research, and education related to analog circuit technology through the "analog technology-oriented Gunma concept."

(5) Government initiatives

In the Ministry of Economy, Trade and Industry's Technology Strategy Map 2006, the technology map for the information and

communications field, "Technology Roadmap for Semiconductor Field"^[22], indicates (i) conversion of analog technology to intellectual property, high-speed/high-precision simulation, and analog-DFT (2005-2007) and (ii) automated design of analog circuits and design integrated with packaging (2008-2014) as (SoC) design silicon implementation technology.

5 Issues in new-era analog technology

5-1 Increasingly sophisticated technology acquisition

In Section 2-4, this article discussed the differences between analog circuit design and digital circuit design and the difficulty of acquiring analog technology. However, with the miniaturization and acceleration of CMOS, even more advanced analog technology will be necessary in the future.

(1) The necessity of broad knowledge acquisition

Figure 8 depicts the areas of technology essential to the construction of wireless systems. As the chart makes clear, the mastery of an extremely broad range of basic knowledge is required. This knowledge includes silicon device physics, electromagnetics, digital signal processing for circuit design, RF/analog/digital circuit technology, the application of silicon wireless engineering for systemization, and

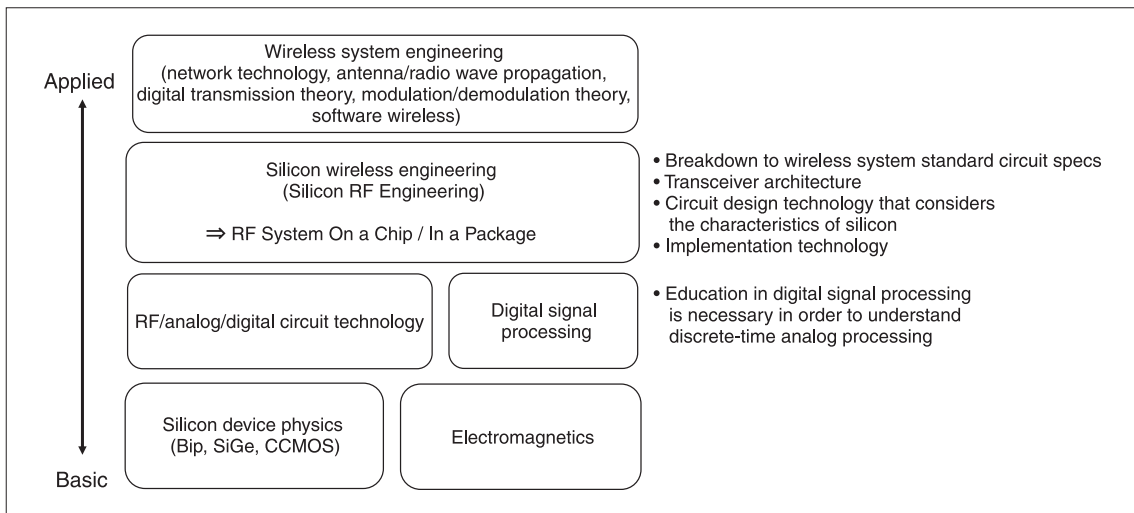

Figure 8 : Essential technology fields for the construction of wireless systems

Compiled by the STFC based on materials provided by Professor Tsuneo Tsukahara of the University of Aizu

wireless system engineering.

In addition to that, it has recently become imperative to be able to respond intelligently to the changes in the frequency bands available for various wireless systems such as mobile telephones and close-range wireless. In product development for the world market in particular, one must bear in mind the differing frequency band allocations in different countries, the various modulation methods, differences in wireless protocols, differences in power voltages and standards, and so on^[23].

(2) The necessity of systematic thinking

In the past, it was acceptable for analog engineers to specialize in a particular type of block (circuit part), but from now on it is desirable that they have a certain amount of technical prowess spanning multiple blocks so that they will be at a higher level and enable the optimization. They will also be required to raise their sights even farther, and to acquire the technical ability to consider architecture that aims to improve overall characteristics^[24]. Regarding the difference between Japan's technical ability and that of other countries, we note the following opinion. "In Japan, when one speaks of being able to design analog circuits, it means the ability to make elemental circuits (parts) such as operational amplifiers. Graduate students in the USA, however, do not just make parts, they can also combine them to make systems. They also have the ability to design from architecture." Training in systematic thinking with awareness of the electronic equipment that will be used in the actual applications is necessary.

(3) Securing venues for experimentation and practice

The analog field requires all-around strength. It is a field where experience is put to use. Practice is important in the acquisition of analog technology, and deep study of the technology involves the integration of practice and theory^[25]. In corporations as well, experimentation and hands-on education are vital, not just classroom instruction^[26]. It is therefore extremely important to prepare environments where such practical

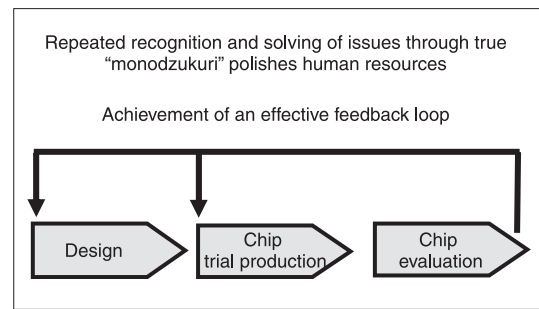

Figure 9 : Flowchart of "monodzukuri" in SoC development

education can take place.

As illustrated in Figure 9, the general flow of "monodzukuri" (skilled hands-on manufacturing) in SoC development proceeds in the order: design, chip trial production, and chip evaluation. In universities, installation of VDEC is steadily improving design automation tools at the design stage and chip trial-production environments. Issues remain, however, at the stage of measuring leading-edge analog LSI prototypes.

In the case of digital circuits, verification results in the design stage are reflected in the quality of the LSI after manufacture. Placing an emphasis on verification during design therefore enables defect-free LSI to be obtained, a major advance in digital LSI technology. With analog circuits, however, judging post-manufacture soundness of LSI requires measurement of waveforms. For wireless-related circuits, even more sophisticated measurement is necessary. To date, however, the provision of measurement environments for analog circuits has been extremely limited. Standards for acceptance of papers at ISSCC and so on emphasize the results of actual circuit operation. VDEC has enabled extensive trial production, but the reason the number of papers accepted by ISSCC has not grown is that there is a bottleneck at the measurement environments. Because leading-edge instruments are expensive, it is difficult for individual universities to obtain them. As measurement technology has become more sophisticated, it has become more difficult to master measurements. Furthermore, universities are unable to retain faculty who will provide human support for measurement and look after it.

(4) The difficulty of reeducation

The analog technology that will be necessary

in the future differs from conventional analog technology. For example, old analog technology was for analog products. Intended for televisions, videocassette players, and so on, it was mainly bipolar. New analog technology is mainly intended for digital products. It is realized through CMOS for digital recording, communications, and networks.

A 1997 ISSCC discussion panel had the following theme:

“RF Designers are from Mars, Analog Designers are from Venus”

In other words, by 1997, there was already awareness of a significant difference between RF/microwave designers and analog designers. Conventional RF/microwave circuit designers work with compound semiconductors as a base, while new-era analog circuit designers work with silicon semiconductors as a base. The academic societies they belong to, their vocabularies, and their ways of thinking differ as well^[27]. Currently, those two different worlds are integrating on the single platform of CMOS, and it is necessary for designers to master both disciplines.

Even if one attempts to reeducate bipolar technology analog engineers in CMOS analog technology, there are practical difficulties. This is because the differences in the technologies mean that their circuit construction methods are very different. Simply replacing bipolar circuits with CMOS circuits causes problems such as dispersion and noise. Because an understanding of the circuits peculiar to CMOS circuits is necessary, engineers brought up with the old analog technology are often unable to follow the logic of the new analog technology^[28].

5-2 Responses to new issues through semiconductor miniaturization

As shown in Figure 2 (receiving circuits), a wave of silicon semiconductorization and CMOS-ization is surging from the baseband side to the front-end side. In the past, analog LSI used compound semiconductors and bipolar technology, while digital LSI was manufactured separately and packaged on printed boards, achieving the desired circuit functions. Regarding silicon semiconductors, there was a time when there was an awareness that from a

performance standpoint, analog circuits were realized with bipolar technology, and MOS (metal oxide semiconductor, CMOS is one type) could not be used for this because of inferior performance. Through the miniaturization of silicon semiconductors, however, even if the RF circuit area is formed with CMOS technology, receiver sensitivity could be raised to the level of previous-generation bipolar technology. This level would be adequate for mobile telephones. At the same time, through efforts to bring down the costs of CMOS manufacture, the design and manufacture of mixed signal SoC began to flourish. Already, there are mobile telephones whose modulation methods are constructed entirely with CMOS.

Silicon semiconductor miniaturization is already entering the era of 65-nm technology nodes (node: one-half of the minimum wiring pitch). A problem accompanying miniaturization is increased power consumption. In response, means are being devised to decrease power voltage. Power voltage is now beginning to drop below 1 volt. In mixed signal SoC, however, it is harder to lower the voltage for analog circuits than for digital ones. It therefore is becoming difficult to further the move to SoC. Various possible solutions are being studied, including once again separating analog chips. With the miniaturization of CMOS processing, the degree of difficulty of analog circuit design has increased dramatically, so further research and development are necessary.

5-3 The analog-type thinking needed for acceleration of digital circuits

Currently, radio carrier wave frequencies use a bandwidth of several GHz, and signal transmission speed inside LSI has also reached several GHz. The development of even higher-speed operation is in progress. Connections among elements in circuit diagrams can be taken as wiring with no resistance value in the low-frequency domain, but they contribute significant resistance in the high-frequency domain. Furthermore, in the high-frequency domain, with two parallel conductors, the influence of parasitic elements (resistance of individual conductors, floating capacitance

generated among conductors, parasitic inductance, mutual inductance, etc.) not in the circuit diagram cannot be ignored. Here the idea of “distributed constant circuit”^{*8} is necessary. The following are examples of phenomena that can occur along with higher frequencies^[29].

- (i) The generation of signal distortion and delays that cause timing errors and malfunctions.
- (ii) The quality of the signal waveforms of digital signals is questioned like analog signals, requiring analog-type analysis.
- (iii) Electromagnetic waves are easily generated.
- (iv) The higher the frequency, the shorter the distance between wires, and the longer that wires run parallel to each other, the greater the crosstalk (signal leakage).
- (v) A skin effect, in which current does not flow except on the surface of a conductor, appears. This increases high-frequency resistance by several powers of 10.

In other words, problems that previously only occurred in signal transmission between chips can now occur within a chip. These phenomena must be considered during design. Therefore, even if one calls it digital, there are cases in which design is impossible without analog-type thinking.

Currently in digital LSI design, DFM (design for manufacturability) is a major issue. Various problems occur due to electrical behavior during high-frequency operation, and their solution requires an understanding of analog technology.

5-4 Underdeveloped design automation tools

The functions of typical EDA tools for analog RF design provided by vendors from the USA include system/circuit diagram entry, linear simulator, harmonic balance, HSPICE simulator, EM simulator, interactive layout, placement and routing, interactive DRC (design rule check), and parasitic element extraction. Design automation tools for analog circuit design center on verification and interactive design. This is very different from digital circuit design, where automation is advanced.

Future issues in verification are, first, circuit modeling. With miniaturization, circuit models are unable to accurately express actual characteristics using conventional methods. Furthermore, simulation of high-frequency environments, formerly required at the packaging development stage, is now necessary during LSI design. In response to new changes, the development and enhancement of new tools is necessary.

6

Measures to improve analog technical ability

In the past, when the number and variety of digital products were growing rapidly, industry needed large numbers of digital circuit designers. It trained design engineers for digital LSI, typified by ASIC (application specific integrated circuit). In universities, VDEC (VLSI Design and Education Center) was established, providing full support for digital circuit designers. Today, however, it is difficult to secure product superiority or added value with digital circuits alone. Analog technology will also play an important role in the new sense of realizing high-speed digital circuits. Undoubtedly, analog technology will play a major role in the future in increasing the added value of Japanese semiconductors, i.e., in improving their quality. Below, this article will discuss measures for improving analog technical ability with an eye to enhancing semiconductor quality.

6-1 Enhancing education and research (proposals for industry and academia)

(1) Awareness of new analog technology

Added value in semiconductor design can be divided into the upstream of architecture and intellectual property, and the downstream of solving sophisticated problems at the physical level. Intermediate work that views only time and worker hours as issues is steadily losing added value. In order to thrive in global competition, personnel who can do work with high added value (or who can add value) are necessary. Analog technology is a source of added value. The first step in enhancing it is to recognize that the analog technology required today is not the same analog technology required in

the past. Even in industry, there are still few executives who recognize this. There is little awareness of the need for reeducation. Second, it is necessary to establish new programs for personnel development and the reeducation of engineers in line with these concepts. Industry and academia should therefore work together to create educational programs and materials. An example of this is the creation of STARC's analog RF textbooks described above.

(2) Implementation of education tailored to those being educated

Human resources development should proceed on two fronts: broadening the base and training the top ranks.

Education to broaden the base should provide more potential researchers and engineers with opportunities not only to acquire basic knowledge, but to deepen their understanding through experimentation and practical training. A broad education from fundamentals to applications is necessary, but universities should first of all provide a thorough basic education. In addition, universities should set development targets and engage in the necessary research and development on elemental technologies and systemization in order to meet them. Universities and industry must actively collaborate in advancing this type of education. Research with industry will refine leading-edge ideas and implementation methods to deal with issues from the front lines of the latest developments in SoC.

How to foster elite human resources is a more difficult problem. Because they must accumulate the necessary knowledge and experience in several technological fields and in management rather than in just one specialized field, it will be difficult to create generalized education programs. If this is neglected, however, Japan will lose its overall superiority in the future. Industry and academia need to cooperate to deepen the discussion of this challenge.

(3) Analog technology education for digital engineers

As discussed in Section 5-3, analog-type thinking will become increasingly necessary with the higher speeds of digital circuits. Development

has already reached a stage where it is difficult to rely on existing design automation tools alone. The usual tools will not by themselves be sufficient to solve the design issues that arise with full automation. There will be many points at which designers conversant with electrical characteristics will be needed. Japan should seek added value and improved quality in semiconductors by training digital engineers in basic analog technology and fostering human resources who understand both analog and digital technology.

(4) Expectations for university research

The field of analog technology is one where victory is determined not by excellence of equipment, but by the abilities of researchers and engineers. European and American universities present many prominent papers at leading international conferences on analog integrated circuits^[30]. Venture businesses started by universities are succeeding in many countries. Through the combination of theory and practice, it is necessary not just to acquire technology, but to grasp research style that will develop it and sophisticated methods to deal with the issues. This is an area in which universities can be very active. Today in Japan, corporate engineers with advanced specialized knowledge are transferring to universities, where they are laying the foundations for leading-edge technology research based on actual development experience.

6-2 Transferring expertise into design automation tools (proposals for universities)

Transferring expertise into design automation tools converts research results into concrete assets. These tools should be improved through use at university research and development sites as well as actual industry development sites, and the process should be linked to human resources development. Development of design automation tools does not require expensive manufacturing equipment. It is a field in which ideas compete. Development of leading-edge design automation tools must begin with theory. In this sense as well, it is a research and development area well suited to universities, so their active involvement

can be expected. The SPICE simulator is a tool developed by a university in the USA. Expectations are particularly high for the following concrete outputs:

(1) Research and development on simulators of high-frequency environments

Through the pursuit of high-speed operation, LSI has come to demand a design level close to the level of the packaging design of conventional packaging and boards. The development of highly accurate, high-speed simulators is expected to improve technological ability in analog circuit design.

(2) Research and development of leading-edge modeling methods

In circuit simulation in LSI design, the key is how accurately transistor models can express actual electrical characteristics. With conventional modeling, circuit models are increasingly failing to match the results of actual LSI measurement. The limits of response to miniaturized processes below 90 nm are becoming visible. Hiroshima University is researching and developing a next-generation MOSFET model called HiSIM. Recognized worldwide for its excellence, it is a finalist in the Compact Model Council's (CMC) selection of the next-generation MOSFET model standard^[31]. Expectations are high that in the future universities will carry out further research and development on this type of model.

(3) Research and development on analog-type design support for digital engineers

Digital circuit design automation tools are becoming more sophisticated, but the state of development for circuit design that requires analog-type thinking is still inadequate. Immediate initiation of research and development to produce better analysis tools and other support tools will enable the securing of LSI product superiority. The number of engineers able to work in the domain of integrated analog and digital will also increase. Expectations for university research in this area are high as well.

6-3 Improvement of measurement environments (proposal for industry, government, and academia)

As a means to improve measurement environments, this paper proposes the establishment of a center that can provide a measurement environment and support ("measurement services") for its joint use by university and corporate engineers. This would solve the problem of the bottleneck in measurement. It should effectively implement feedback utilizing results as depicted in Figure 9. To ensure continued operation, the appropriation of new instruments should be accompanied by support for facilities as well as human support such as maintenance and training. These measurement services must be available to all, without regard to whether the users are universities or corporations. Basic education such as seminars on evaluation technology should also be provided. Universities already supplied with instruments for mixed signal SoC by national or local governments must open them and expand human support. Bases with measurement center functions should be opened in multiple regional universities (or research centers) in order to raise the general standard throughout Japan. They can become sites where analog engineers and other leading-edge LSI development engineers can gather, developing human resources through mutual communication.

7 | **Conclusion**

This article has discussed analog technology trends and the importance of human resources development, focusing on CMOS analog RF SoC, which is wireless communications infrastructure that will play an important role in the coming of ubiquitous network connections and requires new-era analog technology. In order to make improvements for the future, enhanced education, the transfer of expertise into design automation tools and the upgrading of measurement environments as sites for practice are necessary.

For digital circuits as well, the limit of leading-edge, high-speed LSI development for supercomputers, digital appliances, automobile

LSI, and more will inevitably be challenged, so the role of analog technology will become increasingly important. Although this article did not touch on the subject, power circuits are another technologically and industrially important analog technology area requiring future research and development. Analog technology is an area that can be expected to “improve the quality” of Japanese semiconductor products. Its further enhancement is necessary.

Acknowledgments

Professor Akira Matsuzawa of Tokyo Institute of Technology Graduate School of Science and Engineering provided valuable opinions and materials on all aspects of the writing of this article. Professor Haruo Kobayashi of the Department of Electronic Engineering, Faculty of Engineering, Gunma University; Senior Manager Akira Kanuma and Chief Researcher Koichiro Mashiko of the Education Planning Group, Research and Development Department, Semiconductor Technology Academic Research Center; Mr. Hiroshi Nakamura of Jedat Inc.; Mr. Kazuteru Tada of the Electronic Measurement Group, Agilent Technologies; and Dr. Masanori Hirata of the Corporate Planning Division, NEC Electronics Corporation provided valuable advice and materials. President and CEO Katsuhiro Shimohigashi of Semiconductor Technology Academic Research Center; Professor Tsuneo Tsukahara of the University of Aizu; Professor Masao Hotta of the Department of Electronics and Communication Engineering, Faculty of Engineering, Musashi Institute of Technology; and Chief Research Scientist Tetsuro Itakura of the Toshiba Corporate Research and Development Center also provided valuable materials. The author wishes to thank all those involved for their kind assistance.

Glossary

- *1 Close-range wireless is telecommunications utilized over relatively short distances. Wireless LAN, Bluetooth, etc., are commonly used.
- *2 CMOS analog RF (radio frequency) system LSI refers to LSI in which analog circuits such as high-frequency processing and

high-speed ADC/DAC (analog-to-digital/digital-to-analog conversion) that achieve wireless function are components in CMOS technology with mixed analog-digital LSI. This type of system LSI is called SoC (system on a chip).

- *3 A gate array is a semi-customized IC with a master wafer with complete front-end processes prepared in advance.
- *4 Frequency response describes several types of possible changes in output signal that might result from a frequency change in a circuit’s input signal.
- *5 GSM is a wireless communications protocol used with digital mobile telephones. It is utilized in many countries especially in Europe and Asia.
- *6 IMEC is a European semiconductor-related research and development consortium based in Leuven, Belgium. IMEC actively collaborates with the Indian Institute of Science.
- *7 MINATEC (Centre for innovation in micro and nanotechnology) is a project to create an international industry-academia-government research center to carry out research and development in a broad range of fields from microtechnology to nanotechnology. It is led by CNRS (Centre national de la recherche scientifique), CEA-LETI (the French Atomic Energy Commission’s Electronics and Information Technology Laboratory), INPG (Grenoble Institute of Technology), and the regional government agency AEPI (Isère economic development agency).
- *8 Distributed constant circuit: Unlike general electrical circuits (called lumped-constant circuits) where circuit design takes place with circuit elements such as resistance, capacitance, and inductance (coil) concentrated at one point, with a distributed constant circuit, circuit elements cannot be spatially separated and circuit constants are distributed over its entirety. In this case, designs must consider the layout of each part, fully grasping the relationship between transmission line length and wavelength and whether there are connections among transmission lines.

References

- [1] Tatsuo Higuchi, "Analog-digital conversion," Nikkan Kogyo Shimbun, Ltd. (Japanese)
- [2] Yasuo Takemura, "Fundamentals of electronic circuits," Corona Publishing Co., Ltd. (Japanese)
- [3] Masao Hotta, "How can analog circuit engineers be fostered?," the Institute of Electronics, Information and Communication Engineers Society Conference, September 2006 (Japanese)
- [4] Akira Hyogo, "What is the necessary university training for analog circuit engineers?," the Institute of Electronics, Information and Communication Engineers Society Conference, September 2006 (Japanese)
- [5] Kenji Taniguchi, "Introduction to CMOS analog circuits for LSI designers," CQ Publishing Co., Ltd. (Japanese)
- [6] "Measures to restore the international competitiveness of the semiconductor industry)," Development Bank of Japan Survey No. 90, May 2006 (Japanese)
- [7] Akira Matsuzawa, "Electronic equipment and system LSI," 2005 System LSI Technology Outlook (Japanese)
- [8] Dennis D. Buss, "Technology in the Internet Age," ISSCC 2002 Session 1.1
- [9] p. 76, Nikkei Microdevices, November 2006 (Japanese)
- [10] http://www.starc.jp/about/news/STARCNws_s_No29.pdf
- [11] Akira Matsuzawa, "Who will train the engineers?," MATLAB EXPO 2005, December 2005 (Japanese)
- [12] "Semiconductor Industry Forecast Autumn 2006," World Semiconductor Trade Statistics [WSTS] (Japanese)
http://www.ednjapan.com/content/l_news/2006/11/l_news061101_0301.html
- [13] http://bwrc.eecs.berkeley.edu/Research/RF/ogre_project/
- [14] "Trends of the wireless semiconductor industry," Minatec CrossRoads 2006
- [15] L Malier, "Research programs for LETI"
- [16] Che-Yen Chang and Wei Hwang, "Development of National System-on-Chip (NSoC) Program in Taiwan"
- [17] "Combining all-out efforts on fostering Taiwanese engineers to transform LSI development bases," Nikkei Electronics, 5 December 2005 (Japanese)
- [18] 6th RF Integrated Circuit Technology Workshop
- [19] Akira Kanuma, "'Present and future of VLSI design education' design education support activities by industry," the Institute of Electronics, Information and Communication Engineers General Conference, March 2006 (Japanese)
- [20] Gunma University Analog Integrated Circuit Society:
<http://www.ccr.gunma-u.ac.jp/News/200312/News2003120303.html>
- [21] Analog Technology Information Network:
<http://www.analog-technology.com/university.html>
- [22] Technology Strategy Map 2006 (Ministry of Economy, Trade and Industry, April 2006) (Japanese)
- [23] "Analog engineers faced with responding to internationalization," EDN Japan, 21 December 2006 (Japanese)
http://www.ednjapan.com/content/issue/2006/12/globalreport04_01.html
- [24] Tetsuro Itakura, "Profile of desired analog circuit engineers," the Institute of Electronics, Information and Communication Engineers Society Conference, September 2006 (Japanese)
- [25] Haruo Kobayashi, "How can analog circuit engineers be fostered?," the Institute of Electronics, Information and Communication Engineers Society Conference, September 2006 (Japanese)
- [26] Shiro Dosho, "How shall we train analog engineers?," the Institute of Electronics, Information and Communication Engineers Society Conference, September 2006 (Japanese)
- [27] Tsuneo Tsukahara, "Design technology, development examples, outlook for high-frequency RF CMOS analog circuits," October 2006 (Japanese)
- [28] Akira Matsuzawa, "The new analog era and venture corporations and universities," Japan Semiconductor Ventures Association

Magazine, April 2006 (Japanese)

[29] Hiroshi Hasegawa, "Vital points of analog/digital high-frequency circuits and packaging design," Nikkan Kogyo Shimbun, Ltd. (Japanese)

[30] Haruo Kobayashi, "Analog technology supporting the evolution of electronic

equipment, and its human resources development," 2006 Tokyo International Digital Conference, September 2006 (Japanese)

[31] http://www.starc.jp/about/news/STARCNws_No28.pdf (pp. 12-13)



Minoru NOMURA

Information and Communications Research Unit

The author joined NISTEP after working in a private company, where he was in charge of R&D on CAD for computer design, and business development of high performance computing and ubiquitous networking. He is interested in the science and technology trends in information and telecommunication technology, including supercomputing and LSI design.

(Original Japanese version: published in January 2007)
