

# EFFECT OF HIGH TEMPERATURE AND HIGH HUMIDITY TREATMENT ON BENDING PROPERTIES OF WOOD

*Yoshitaka Kubojima\**

Researcher  
E-mail: kubojima@ffpri.affrc.go.jp

*Isao Kobayashi*

Researcher  
E-mail: kobayas@ffpri.affrc.go.jp

*Youki Suzuki*

Researcher  
Forestry and Forest Products Research Institute  
1 Matsunosato, Tsukuba, Ibaraki 305-8687, Japan  
E-mail: youki@ffpri.affrc.go.jp

*Mario Tonosaki*

Director  
Shikoku Research Center  
Forestry and Forest Products Research Institute  
Asakura Nishimachi, Kochi 780-8077, Japan  
E-mail: tonosaki@ffpri.affrc.go.jp

(Received November 2014)

**Abstract.** Japanese cedar (*Cryptomeria Japonica* D. Don) 110 × 110 × 1000-mm green boxed-heart timbers were dried under high temperature (110-140°C) and high humidity (0.01-0.24 MPa gauge pressure) conditions until the weight remained unchanged. Then strength properties were examined. Wood became brittle because of the high temperature and high humidity treatment. We hypothesize that the wood was seriously damaged by hydrolysis because of the long treatment time used in this study and that the large cross-sectional area and high set gauge pressure lengthened the time of water loss from the wood. We considered viscosity and plasticity, rather than elasticity, to be the main factors that contributed to the decrease of work for rupture.

**Keywords:** Cedar, high humidity, high temperature, impact bending, static bending, strength.

## INTRODUCTION

In wood processing, it is important to lower drying costs by quickly drying without inducing damage, such as checks, splits, and honeycombs. Although high-temperature drying can decrease time and cost, traditional and conventional high-temperature drying methods cannot guarantee both speed and high-quality products.

Recently, a high-temperature (greater than 100°C) and high-humidity (greater than atmospheric pres-

sure) treatment has been attracting attention as an improved drying method. In this method, wood is heated in nonsaturated (superheated) water vapor at controlled temperature and humidity. This hinders the formation of checks because the wood is softened while it is dried to some extent (Saito et al 1995; Kobayashi et al 1995, 1996, 1997; Hisada 1998).

To determine the appropriate drying conditions, we should understand not only the wood properties after drying but also those when water is being lost by heating. We measured temporal changes in MC and vibrational properties of

---

\* Corresponding author

green wood under a high temperature and atmospheric pressure condition and high temperature and high humidity (more than atmospheric pressure) one. Specific Young's modulus and loss tangent reached the minimum and maximum, respectively, early in the drying under both heating conditions. The minimum and maximum under the high temperature and high humidity condition were far greater and smaller than those under the high temperature and atmospheric pressure one, respectively. This showed that wood was remarkably softened by the high temperature and the moisture remaining in the wood (Kubojima et al 2002, 2003, 2004, 2005, 2009).

Hence, it was feared that heat treatment under the high temperature and high humidity condition decreased the wood strength more than that under the high temperature and atmospheric pressure condition (Kubojima et al 1998a, b, 2000; Ikeda et al 2009). Although many studies (Stamm et al 1946; Mitchell et al 1953; Inoue et al 1993; Mitchell 1988; Kim et al 1998; Tjeerdma et al 1998; Poncsák et al 2006; Boonstra et al 2007; Esteves et al 2007; Shi et al 2007; Korkut et al 2008; Arnold 2010; Volkmer et al 2014) and several reviews (Esteves and Pereira 2009; Sandberg et al 2013; Xie et al 2013) on the mechanical properties of heat-treated wood exist, there are few studies on the mechanical properties of actual-size timbers heat-treated with monitoring temperature (more than 100°C), water vapor pressure (more than atmospheric pressure), and weight.

In this study, timbers were heat treated under high temperature and high humidity conditions until the weight remained unchanged for the purpose of obtaining basic data for drying under such conditions. We considered that the drying under each heating condition finished when the weight became stable. And then damages to wood were investigated from the aspect of strength.

## MATERIALS AND METHODS

### Specimens

Japanese cedar (*C. Japonica* D. Don) 110 × 110 × 1000-mm green boxed-heart timbers were used

as the specimens. Two boxed-heart timbers were used for each heat treatment condition and controls. The boxed-heart timbers for controls were conditioned at 20°C and 65% RH according to Japanese Industrial Standard (2009) without heating until the weight was constant. The average and standard deviation of initial MC of all boxed-heart timbers were 61.6% and 10.4%, respectively. There was not any form of restraint applied to the wood during drying. After drying under each condition and weighing the oven-dried weight, five or six specimens for static bending tests were cut from a boxed-heart timber whereas five or six specimens for impact bending tests were cut from another boxed-heart timber. Specimens for static bending tests were 20 mm wide (R), 20 mm thick (T), and 320 mm long (L); those for impact bending tests were 20 mm wide (R), 20 mm thick (T), and 300 mm long (L). All bending tests were conducted at 20°C and 65% RH.

### Temperature and MC during Drying

The measuring system was in an airtight chamber (Takahashi Boiler Co., Ltd., Nagoya, Japan), and the thermocouple and load cells were connected to a data logger outside the chamber (Fig 1). This heating chamber comprised two cans; the inner can (chamber) and the outer can (jacket). The chamber was heated by water vapor introduced between the two cans, and superheated water vapor formed inside. Both temperature and pressure were controlled. Because the pressure changed according to the water from the wood and condensation in a pipe connected to the heating instrument, the pressure was controlled by leak and steam valves, respectively. The inner can was 500 mm in diameter and 1500 mm long, whereas the outer can, including the jacket, was 610 mm in diameter and 1600 mm long. The temperature control range was 100–170°C, maximum pressure was 0.98 MPa, and the pressure could be changed in 0.01-MPa increments. The motor for the inner fan was located outside the outer can, and a heat-resistant ground packing was tied around a shaft to prevent water vapor leakage.

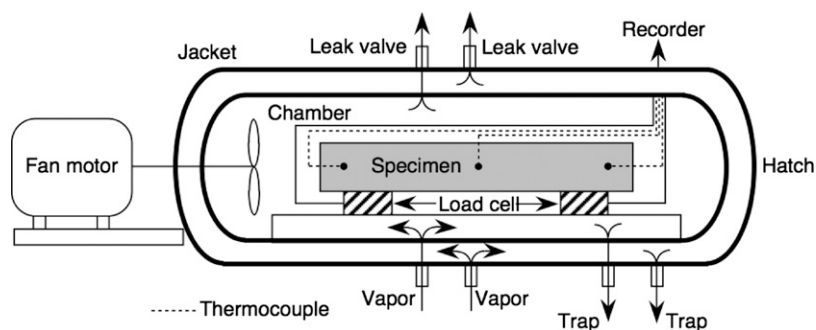

Figure 1. Apparatus for measuring MC during drying under high temperature conditions (Kubojima et al 2013).

As shown in our previous study (Kubojima et al 2009, 2013), to measure temperature in a specimen, a T-type thermocouple was inserted lengthwise at a depth of 50 mm from the central point of the radial-tangential (RT) and longitudinal-tangential (LT) planes. To measure the weight of a specimen, two beam-type load cells for high temperature conditions (LUB-10KBM96, Kyowa Electronic Instruments Co., Ltd., Tokyo, Japan) were used, which supported the specimen at two points.

Table 1 shows the set temperature, set gauge pressure, and set RH. Temperature and weight were measured at intervals of 1 min. When the weight remained unchanged for less than 24 h, the boxed-heart timbers were removed from the chamber and immediately weighed. And then, they were oven-dried at 105°C. MC was calculated based on the oven-dried weight. The Young’s modulus of air-dried wood heat-treated at 120°C for 16 h did not decrease but slightly increased (Kubojima et al 1998a). Hence, we think that wood will not be seriously damaged by drying at 105°C.

**Static Bending Test**

The static bending test was performed using center-point loading across a 280-mm span with the load applied in the tangential direction. The cross-head rate was 5 mm/min. From the load-deflection relationship, the Young’s modulus, bending strength, and work for rupture were obtained.

**Impact Bending Test**

A Charpy-type impact bending machine with a capacity of 29.4 J was used. The span was 240 mm. The absorbed energy in impact bending was obtained by the angle of the hammer when it was in the highest position.

Table 1. Set RH (%) under conditions of set temperature and set gauge pressure used for heat treatment (Kubojima et al 2009).

Gauge pressure (MPa)	Temperature (°C)			
	110	120	130	140
0.01	77.7	—	41.2	30.8
0.02	—	61.1	—	—
0.03	91.6	—	48.6	—
0.04	98.6	71.2	—	39.1
0.05	—	—	—	—
0.06	—	81.3	59.7	—
0.07	—	—	—	—
0.08	—	91.3	—	50.2
0.09	—	96.4	70.8	—
0.10	—	—	—	—
0.11	—	—	78.2	—
0.12	—	—	—	61.2
0.13	—	—	—	—
0.14	—	—	89.3	—
0.15	—	—	—	69.5
0.16	—	—	96.7	—
0.17	—	—	—	—
0.18	—	—	—	—
0.19	—	—	—	80.6
0.20	—	—	—	—
0.21	—	—	—	—
0.22	—	—	—	88.9
0.23	—	—	—	—
0.24	—	—	—	94.4

## RESULTS AND DISCUSSION

Figure 2 shows an example of temporal changes in temperature (eg RT plane), gauge pressure, and MC. Heating time and EMC depended on temperature and humidity conditions because heating was stopped when the weight remained unchanged (Kubojima et al 2009). The heating time in this study is the longest time taken for high temperature and high humidity treatment for actual wood drying.

Wood properties (average [standard deviation]) for the controls are shown in Table 2.

Figures 3-8 show changes in wood properties caused by high temperature and high humidity treatment. Changes in density, Young's modulus, bending strength, work for rupture, and absorbed energy in impact bending were compared with those in our previous studies (Kubojima et al 1998b; Kubojima and Shida 2001), in which Japanese cedar green wood, 25-mm wide (R), 25-mm thick (T), and 350-mm long (L), was dried at 120°C and 160°C under atmospheric pressure.

As shown in Fig 3, density decreased, although it did not show a clear trend. It decreased more compared with our previous study because the density ratio of the heat-treated specimens to the control was 0.97 in our previous study (Kubojima et al 1998b).

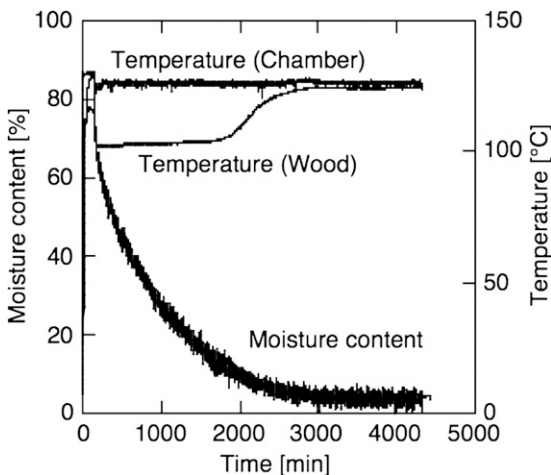

Figure 2. An example of temporal changes in temperature, gauge pressure, and MC (130°C and 0.01 MPa).

Table 2. Wood properties for the controls.<sup>a</sup>

	Density (kg/m <sup>3</sup> )	386 (19.7)
Young's modulus (GPa)	6.82 (0.90)	
Bending strength (MPa)	67.5 (6.43)	
Work for rupture (kJ/m <sup>2</sup> )	20.6 (4.10)	
Absorbed energy in impact bending (kJ/m <sup>2</sup> )	32.4 (3.7)	

<sup>a</sup> Average (standard deviation). The green boxed-heart timbers were conditioned under 20°C and 65% RH without heating. Six specimens were used for the static and impact bending tests, respectively.

As shown in Fig 4, Young's modulus decreased, although it did not show a clear trend. It decreased significantly more compared with our previous study because the Young's modulus ratio of the heat-treated specimens to the control was 1.03 in our previous study (Kubojima et al 1998b).

As shown in Fig 5, bending strength decreased with an increase in the set gauge pressure. It decreased significantly more compared with our previous study because the bending strength ratio of the heat-treated specimens to the control was 1.08 in our previous study (Kubojima et al 1998b). There was not a clear tendency derived from the heating temperature.

As shown in Fig 6, work for rupture decreased with an increase in the set gauge pressure. It decreased significantly more compared with our previous study because the work for rupture ratio of the heat-treated specimens to the control was 1.06 in our previous study (Kubojima et al

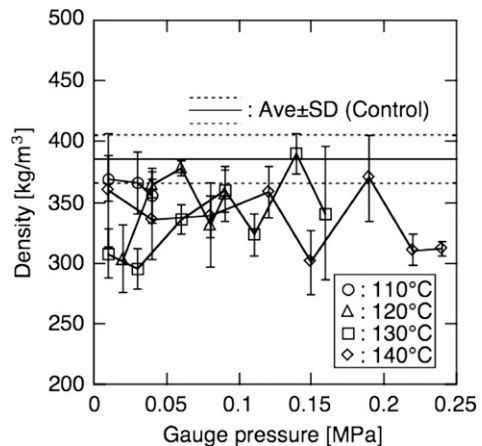

Figure 3. Changes in density caused by high temperature and high humidity treatment.

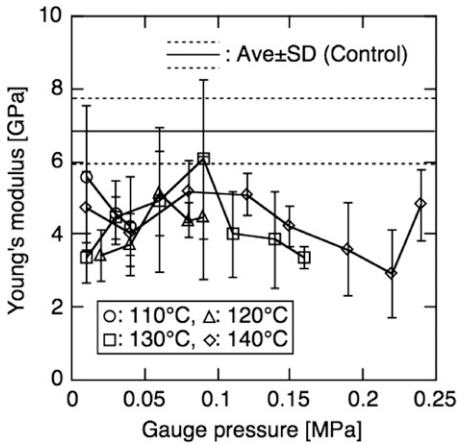

Figure 4. Changes in Young's modulus caused by high temperature and high humidity treatment.

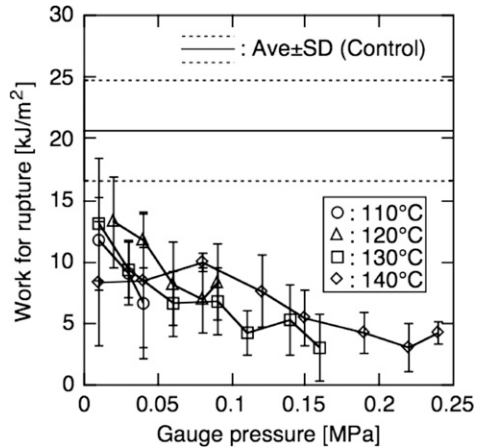

Figure 6. Changes in work for rupture caused by high temperature and high humidity treatment.

1998b). There was not a clear tendency derived from the heating temperature.

Figure 7 shows the changes in each work part of the work for rupture caused by the heat treatment. The work for rupture is the sum of the work in the linear region until the proportional limit ( $W_p$ ) and work in the curved region from the proportional limit to rupture ( $W_{pr}$ ). In this study, the boundary point between the linear region and the curved region could be clearly fixed. The value of  $W_{pr}$  was larger than that of  $W_p$ . The change in  $W_{pr}$  was much greater than that in  $W_p$  and decreased as the set gauge pressure increased, whereas  $W_p$

did not markedly change. Hence, it was thought that heat-treated wood was more brittle in the static bending test than untreated wood because  $W_{pr}$  decreased because of the heat treatment. In addition, the Young's modulus did not decrease with an increase in the set gauge pressure as previously mentioned. Therefore, we considered viscosity and plasticity to be the main factors that contributed to the decrease of work for rupture, rather than elasticity. This was similar to the trend observed in our previous study (Kubojima et al 2000).

As shown in Fig 8, absorbed energy in impact bending decreased with an increase in the set gauge pressure. It decreased significantly more

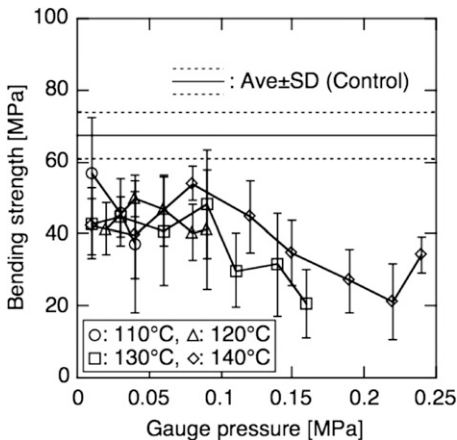

Figure 5. Changes in bending strength caused by high temperature and high humidity treatment.

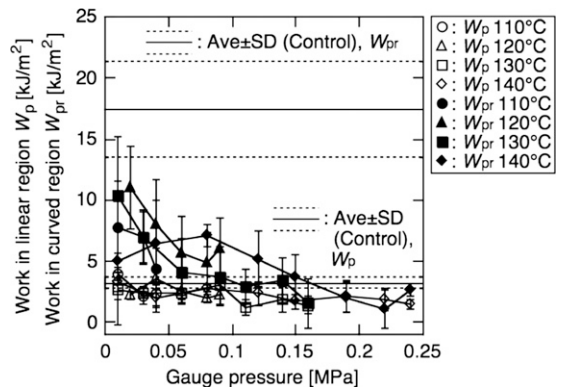

Figure 7. Changes in each work part caused by high temperature and high humidity treatment.

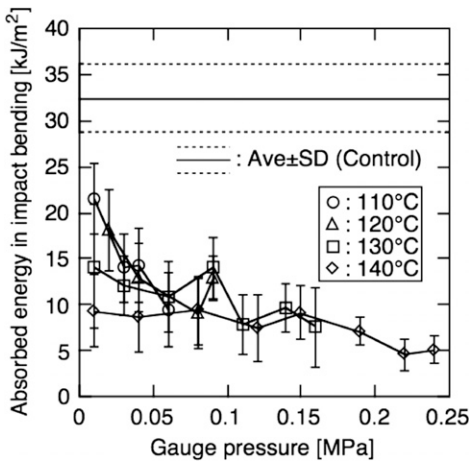

Figure 8. Changes in absorbed energy in impact bending caused by high temperature and high humidity treatment.

compared with our previous study because the ratio of absorbed energy in impact bending for the heat-treated specimens to the control was 0.83 in our previous work (Kubojima and Shida 2001). There was not a clear tendency derived from the heating temperature. Although load-deflection relationships for impact bending tests were not measured, it is reasonable that viscosity and plasticity were the main factors that contributed to the decrease of work for rupture, rather than elasticity (Kubojima et al 2000), as the static bending test as previously mentioned.

It is hypothesized that the significant decreases in the previously mentioned wood properties can be attributed to the much longer heating time used in this study compared with the previous studies; heating times in this study and the previous studies (Kubojima et al 1998b; Kubojima and Shida 2001) were about 2800-33,000 min and 300-750 min, respectively. We think that the wood was seriously damaged by hydrolysis because of the longer time used in this study and that the larger cross-sectional area ( $110^2/25^2 = 19.36$  times) and higher set gauge pressure lengthened the time for water loss from the wood.

The MC of the boxed-heart timber at the time when its weight remained unchanged, ie the EMC, varied based on each heating condition (2.1-28.7%) (Kubojima et al 2009). Hence, the MC in per-

forming the static and impact bending tests depended on each heating condition, and it ranged from 6.4% to 8.4%. The changes in Young's modulus, bending strength, and absorbed energy in impact bending of this study previously mentioned were much larger than those of previous studies in the MC range of 6.4-8.4% (Matsumoto 1962; Küch 1943; Miyajima 1979; Ebihara et al 1985; Urakami and Fukuyama 1985; Sumi et al 1986). Hence, we think that the variation of EMC was not a serious problem in this study.

Because specimens became brittle, the heat treatment under high temperature and high humidity conditions for too long was not adequate for maintaining or improving the bending properties of wood. However, using the high temperature and high humidity treatment at the initial stage of wood drying would be effective (Hisada 1998). Hence, the effect of heating time should be investigated, eg determining if wood properties decrease immediately after heating.

## CONCLUSIONS

Japanese cedar green boxed-heart timbers were heat treated under high temperature and high humidity conditions, and then the bending properties of the treated wood were investigated. The results obtained were as follows:

1. Wood became brittle because of the high temperature and high humidity treatment for a long time.
2. We hypothesize that wood was seriously damaged by hydrolysis because of the longer time used in this study and that the larger cross-sectional area and higher set gauge pressure lengthened the time for water loss from wood.
3. We considered viscosity and plasticity, rather than elasticity, to be the main factors that contributed to the decrease of work for rupture.

## ACKNOWLEDGMENTS

This study was financially supported by the Research grant no. 200005 of the Forestry and Forest Products Research Institute.

## REFERENCES

- Arnold M (2010) Effect of moisture content on the bending properties of thermally modified beech and spruce. *J Mater Sci* 45(3):669-680.
- Boonstra M, Van Acker J, Tjeerdsma B, Kegel E (2007) Strength properties of thermally modified softwoods and its relation to polymeric structural wood constituents. *Ann For Sci* 64(7):679-690.
- Ebihara T, Sumi H, Nakano T (1985) Effect of kiln-drying and moisture content on the impact bending properties of Aodamo and Yachidamo (*Fraxinus* spp.). *Mokuzai Gakkaishi* 31(12):1040-1046.
- Esteves BM, Pereira HM (2009) Wood modification by heat treatment: A review. *BioRes* 4(1):370-404.
- Esteves BM, Velez MA, Domingos I, Pereira H (2007) Influence of steam heating on the properties of pine (*Pinus pinaster*) and eucalypt (*Eucalyptus globulus*) wood. *Wood Sci Technol* 41(3):193-207.
- Hisada T (1998) Pre-treatment to improve the drying speed and drying defects for Sugi (*Cryptomeria Japonica* D. Don) column woods. *Woodworking Machinery* 181:5-8.
- Ikeda K, Yoshida T, Kuroda N, Shida S, Iijima Y (2009) The correlation of kiln drying and strength properties of structural softwood timber—Mainly in the influence of the check and the high temperature processing. *Wood Ind* 64(7):308-313.
- Inoue M, Norimoto M, Tanahashi M, Rowell R (1993) Steam or heat fixation of compressed wood. *Wood Fiber Sci* 25(3):224-235.
- Japanese Industrial Standards Committee (2009) Japanese industrial standard Z 2101 methods of test for woods. Japanese Standards Association, Tokyo, Japan.
- Kim G, Yun K, Kim J (1998) Effect of heat treatment on the decay resistance and the bending properties of radiata pine sapwood. *Mater Organismen* 32(2):101-108.
- Kobayashi I, Saito S, Hisada T (1996) Superheated steam treatment of the boxed heart timber Sugi (*Cryptomeria Japonica* D. Don). Abstracts of the 46th Annual Meeting of the Japan Wood Research Society 159.
- Kobayashi I, Saito S, Hisada T (1997) Superheated steam treatment of the boxed heart timber Sugi (*Cryptomeria Japonica* D. Don) (II)—Use as a pre-treatment and its effects. Abstracts of the 47th Annual Meeting of the Japan Wood Research Society 163.
- Kobayashi I, Saito S, Hisada T, Ikeda M, Ohkita K (1995) Pre-treatment of the boxed heart timber Sugi (*Cryptomeria Japonica* D. Don) with high temperature heating and vacuuming. Abstracts of the 45th Annual Meeting of the Japan Wood Research Society 151.
- Korkut S, Akgül M, Dündar T (2008) The effects of heat treatment on some technological properties of Scots pine (*Pinus sylvestris* L.) wood. *Biores Technol* 99(6):1861-1868.
- Kubojima Y, Kobayashi I, Tonosaki M, Suzuki Y (2009) Equilibrium moisture content of Japanese cedar (*Cryptomeria japonica*) green wood for columns in a high-temperature water vapor environment. *Mokuzai Gakkaishi* 55(5):279-284.
- Kubojima Y, Kobayashi I, Yoshida T, Matsumoto H, Suzuki Y, Tonosaki M (2013) Twisting force during drying of wood. *Eur J Wood Wood Prod* 71(6):689-695.
- Kubojima Y, Okano T, Ohta M (2000) Bending strength and toughness of heat-treated wood. *J Wood Sci* 46(1):8-15.
- Kubojima Y, Okano T, Ohta M (1998a) Vibrational properties of Sitka spruce heat-treated in nitrogen gas. *J Wood Sci* 44(1):73-77.
- Kubojima Y, Shida S (2001) Impact bending and shear properties of high-temperature-dried Sugi (*Cryptomeria japonica* D. Don) wood. *Wood Ind* 56(2):64-68.
- Kubojima Y, Shida S, Okano T (1998b) Mechanical and chromatic properties of high-temperature-dried sugi. *Wood Ind* 53(3):115-119.
- Kubojima Y, Suzuki Y, Tonosaki M (2002) Real-time measurement of vibrational properties of green wood at high temperatures. *Wood Fiber Sci* 34(4):643-650.
- Kubojima Y, Suzuki Y, Tonosaki M (2004) Real-time vibration testing method of wood in superheated water vapor. *Bull For Prod Res Inst* 3(4):335-339.
- Kubojima Y, Suzuki Y, Tonosaki M (2005) Vibrational properties of green wood in high temperature water vapor. *Holzforchung* 59(4):446-450.
- Kubojima Y, Suzuki Y, Tonosaki M, Ishikawa A (2003) Moisture content of green wood in high temperature water vapor. *Holzforchung* 57(6):634-638.
- Küch W (1943) Der Einfluß des Feuchtigkeitsgehaltes auf die Festigkeit von Voll- und Schichtholz. *Holz Roh-Werkst* 6(5/6):157-161.
- Matsumoto T (1962) Studies on the dynamic modulus E and the logarithmic decrement of wood by transverse vibration. *Bull Kyushu Univ For* 36:1-86.
- Mitchell PH (1988) Irreversible property changes of small loblolly pine specimens heated in air, nitrogen, or oxygen. *Wood Fiber Sci* 20(3):320-335.
- Mitchell RL, Seborg RM, Millet MA (1953) Effect of heat on the properties and chemical composition of douglas-fir wood and its major components. *J For Prod Res Soc* 3(4):38-42.
- Miyajima H (1979) Growth and wood quality of aodamo (Japanese ash tree) grown in Hodaka District, Hokkaido. *Res Bull Coll Exp For Hokkaido Univ* 36(2):421-450.
- Poncsák S, Kocaefe D, Bouazara M, Pichette A (2006) Effect of high temperature treatment on the mechanical properties of birch (*Betula papyrifera*). *Wood Sci Technol* 40(8):647-663.
- Saito S, Kobayashi I, Hisada T (1995) Effect of pre-steaming of Sugi (*Cryptomeria Japonica* D. Don) boxed heart square lumber in kiln drying. Abstracts of the 45th Annual Meeting of the Japan Wood Research Society 150.
- Sandberg D, Haller P, Navi P (2013) Thermo-hydro and thermo-hydro-mechanical wood processing: An opportunity for future environmentally friendly wood products. *Wood Mater Sci Eng* 8(1):64-88.
- Shi J, Kocaefe D, Zhang J (2007) Mechanical behaviour of Québec wood species heat-treated using thermowood process. *Holz Roh-Werkst* 65(4):255-259.
- Stamm A, Burr H, Kline A (1946) Staybwood: A heat stabilized wood. *Ind Eng Chem* 38(6):630-634.

- Sumi H, Nakano T, Ebihara T (1986) Breakage of wooden bat and its causes in professional baseball games. *Wood Ind* 42(2):55-60.
- Tjeerdsma B, Boonstra M, Pizzi A, Tekely P, Militz H (1998) Characterisation of thermally modified wood: Molecular reasons for wood performance improvement. *Holz Roh-Werkst* 56(3):149-153.
- Urakami H, Fukuyama M (1985) Effects of size, specific gravity and moisture content on energy absorption of wood during impact bending. *J Soc Mater Sci Jpn* 34(383): 949-954.
- Volkmer T, Lorenz T, Hass P, Niemz P (2014) Influence of heat pressure steaming (HPS) on the mechanical and physical properties of common oak wood. *Eur J Wood Wood Prod* 72(2):249-259.
- Xie Y, Fu Q, Wang Q, Xiao Z, Militz H (2013) Effects of chemical modification on the mechanical properties of wood. *Eur J Wood Wood Prod* 71(4):401-416.