

Electronic Theses and Dissertations, 2004-2019

2017

Calibrating a System Dynamic Model Within an Integrative Framework to Test Foreign Policy Choices

Carlos Kavetsky
University of Central Florida

 Part of the [International and Area Studies Commons](#), and the [Political Science Commons](#)
Find similar works at: <https://stars.library.ucf.edu/etd>
University of Central Florida Libraries <http://library.ucf.edu>

This Masters Thesis (Open Access) is brought to you for free and open access by STARS. It has been accepted for inclusion in Electronic Theses and Dissertations, 2004-2019 by an authorized administrator of STARS. For more information, please contact STARS@ucf.edu.

STARS Citation

Kavetsky, Carlos, "Calibrating a System Dynamic Model Within an Integrative Framework to Test Foreign Policy Choices" (2017). *Electronic Theses and Dissertations, 2004-2019*. 5578.
<https://stars.library.ucf.edu/etd/5578>

CALIBRATING A SYSTEM DYNAMICS MODEL WITHIN AN INTEGRATIVE
FRAMEWORK TO TEST FOREIGN POLICY CHOICES

by

CARLOS J. KAVETSKY
B.A. University of Puerto Rico, 1997
M.A. Webster University, 2009
M.E. University of Central Florida, 2017

A thesis submitted in partial fulfillment of the requirements
for the degree of Master of Science in Modeling and Simulation
in the College of Graduate Studies
at the University of Central Florida
Orlando, Florida

Summer Term
2017

Major Professor: Patricia Bockelman Morrow

© 2017 Carlos J. Kavetsky

ABSTRACT

Political science uses international relations (IR) theory to explain state-actor political behavior. Research suggests that this theoretical framework can inform a predictive model incorporating features of systems dynamics (SD) and agent based (AB) modeling. The Foreign Policy Model (ForPol) herein applies Alexander Y. Lubyansky's (2014) SD model for macro-political behavior to represent behaviors between real systems and mental models. While verifying and validating the resulting SD/AB/IR holistic model requires an extensive comprehensive research agenda, the present work will take a closer examination at input parameter calibration and conducting typical runs of the SD portion of the model as a first step in the testing, verification and validation process of the proposed integrative model. This thesis proposes incorporating an AB paradigm drawn from work by Claudio Cioffi-Revilla (2009), Edward P. MacKerrow (2003), David L. Rousseau (2006), Joshua M. Epstein and Robert Axtell (1996) as a future hybrid extension.

The model applies a SD approach for the modeling of macro-political aggregate behavior. Therefore, the deep analysis of the SD portion of ForPol is modeled and calibrated in Vensim, using empirical data from the 1967 Arab-Israeli Six Day War as a pilot. Interactions within the model actualize Choucri, et. al. (2006), definition of state stability and agent behavior aspects of Cioffi-Revilla's (2009) SimPol polity model. Following calibration results discussion, the present work closes with consideration of future research directions.

ACKNOWLEDGMENTS

First and foremost, I want to thank my Father God for his underserved grace, for bringing me to this point, and for allowing me the opportunity to complete this task. I could not have accomplished this endeavor without the support, patience, encouragement, and, most of all, the love of my wife Suzie—thank you. I am grateful for my son Roy, who in his own way motivates me with his unending joy to be a better person, to not complain and to study harder—you always brighten my day. I thank Dr. Patricia Bockelman-Morrow, my thesis chair and advisor, for always pointing me in the right direction, for her encouragement, for not giving up on my research, and most of all for staying on the train with me until I completed this academic journey. I am grateful for the help of Professor Rachid Ait Maelem Lahcen, UCF PhD candidate in the Engineering department, for assisting me in this transdisciplinary effort, helping to simplify the task and maintaining a positive outlook. I thank Eric Griffin, UCF PhD candidate, for assisting me with coding; I could not have done this without your expertise. Finally, I thank all my thesis advisors, especially Dr. Ilhan Akbas (Florida Polytechnic University), for their support and guidance.

TABLE OF CONTENTS

LIST OF FIGURES.....	ix
LIST OF TABLES.....	xi
LIST OF ACRONYMS (or) ABBREVIATIONS.....	xiii
CHAPTER 1: INTRODUCTION	1
1.1 Research Motivation	1
1.2 Purpose	1
1.3 Problem	2
1.4 Solution	2
1.5 Scope.....	4
1.6 Research Questions.....	5
1.6.1 How can the ForPol SD model input parameters be calibrated?	5
1.6.2 Once the data input is calibrated, will the model behave in a typical way?	5
1.7 Research Objectives	6
1.8 Overview of the 1967 Arab-Israeli Six Day War	6
1.9 Key Accomplishments.....	11
1.10 Thesis Organization	12
CHAPTER 2: LITERATURE REVIEW	13
2.1 Objectives	13
2.2 Review Methodology.....	13
2.2.1 Literature Search.....	14
2.2.2 Screening and Evaluation Criteria	16

2.3 Political Simulations (PS)	16
2.3.1 Purpose.....	16
2.3.2 The Case for Political Simulations	17
2.3.3 Summary and Review.	19
2.4 Hybrid Simulations (HS)	19
2.4.1 Purpose.....	19
2.4.2 The Case for Hybrid Simulations	20
2.4.3 Summary and Review.	21
2.5 Discrete Event Simulations (DES)	22
2.5.1 Purpose.....	22
2.5.2 The Case for Discrete Event Simulations.	22
2.5.3 Summary and Review.	29
2.6 System Dynamics (SD).....	30
2.6.1 Purpose	30
2.6.2 The Case for System-Dynamics Simulation	30
2.6.3 Summary and Review	35
2.7 Agent-Based Simulations (ABS)	40
2.7.1 Purpose.....	40
2.7.2 The Case for Agent-Based Simulations.	40
2.7.3 Summary and Review.	45
2.8 Case Study – 1967 Arab-Israeli Six-Day War	51
2.8.1 Sources	51
2.9 Theoretical Modeling	54

2.9.1 The Inherent Nature of Uncertainty in Politics.....	54
2.9.2 Complexity of the Political Environment.....	55
2.10 “Polity” (State-Actor Modeling).....	56
2.11 System Dynamics Macro-Level of Analysis – Aggregate Behavior.....	64
2.12 Calibrating the System Dynamic Model Input Parameters.....	75
2.12.1 Conflict and Peace Data Bank, 1948–1978.....	76
2.13 Gap Analysis.....	84
2.13.1 Knowledge Gaps.....	84
2.13.2 Approaching a M&S Hybrid Concept.....	87
CHAPTER 3: METHODOLOGY.....	88
3.1 System Dynamic Parameters and Equations.....	88
3.1.1 Saliency of Political Event.....	89
3.1.2 Social Stress.....	90
3.1.3 System Stability.....	92
3.1.4 Policy Choice.....	94
3.1.5 System Description.....	95
3.1.6 – Dashboard Parameter Settings.....	96
3.2 Experimental Design.....	98
3.2.1 Hypothesis 1 – Correlation Analysis for Informational Policy Choice.....	98
3.2.2 Hypothesis 2 – Correlation Analysis for Military Policy Choice.....	101
3.2.3 Hypothesis 3 – Correlation Analysis for Diplomatic Policy Choice.....	104
3.2.4 Hypothesis 4 – Correlation Analysis for Economic Policy Choice.....	108
CHAPTER 4: FINDINGS.....	113

4.1 Experimental Design.....	113
4.2 Inormational Policy Choice.....	113
4.2.1 Hypothesis 1 – Correlation Results for Informational Policy Choice.....	114
4.3 Military Policy Choice	121
4.3.1 Hypothesis 2 – Correlation Results from Military Policy Choice.....	121
4.4 Diplomatic Policy Choice	128
4.4.1 Hypothesis 3 – Correlation Results for Diplomatic Policy Choice	128
4.5 Economic Policy Choice	134
4.5.1 Hypothesis 4 – Correlation Results for Economic Policy Choices	134
CHAPTER 5: CONCLUSION	141
5.1 Summary.....	141
5.2 Discussion.....	142
5.2.1 ForPol SD Input Parameter Calibration and Model Behavior	142
5.3 Achievements	145
5.4 Limitations	146
5.5 Future Work	147
APPENDIX A: COPDAB 1967 ARAB-ISRAELI SIX-DAY WAR	150
APPENDIX B: FORPOL SD LOOPS (STOCKS AND FLOWS)	154
APPENDIX C: CONFLICT AND PEACE DATA BANK.....	159
APPENDIX D: NETLOGO INTERFACE.....	176
APPENDIX E: NETLOGO CODE	178
REFERENCES	187

LIST OF FIGURES

Figure 1 – Integrated Framework (Calibration, Testing, Verification and Validation).....	3
Figure 2 – Case Study: 1967 Arab-Israeli Six-Day War.....	9
Figure 3 – Literature Review Concept Map	15
Figure 4 – System Model Components	26
Figure 5 – Internal Block Diagram of State-Actor Model	57
Figure 6 – System State and Interaction Diagram.....	60
Figure 7 – Comparison of Political Issues and Policy Instrument Categories.....	63
Figure 8 – System Dynamics Causal Structure.....	66
Figure 9 – SD Basic Structure.....	67
Figure 10 – ForPol SD Model of Aggregate Behavior	69
Figure 11 – ForPol SD Model Mathematical representation	70
Figure 12 – ForPol SD Model System Stability Notional Negative Feedback Loop.....	72
Figure 13 – ForPol SD Model Social Stress Notional Negative Feedback Loop.....	73
Figure 14 – ForPol SD Model Social Stress Notional Negative Feedback Loop (Continued).....	73
Figure 15 – ForPol SD Model Policy Choice Notional Positive Feedback Loop.....	74
Figure 16 – ForPol SD Model Policy Choice Notional Positive Feedback Loop (Continued).....	75
Figure 17 – 1967 Arab-Israeli Six-Day War Relative Frequency of Events – By Policy.	79
Figure 18 – 1967 Arab-Israeli Six-Day War Political Event Saliency.....	80
Figure 19 – 1967 Arab-Israeli Six-Day War System Stability Scatter Plot.....	83

Figure 20 – 1967 Arab-Israeli Six-Day War Social Stress Scatter Plot.....	83
Figure 21 – Literature Review Gaps	86
Figure 22 – Vensim 1967 Arab-Israeli Six-Day War Dashboard	96
Figure 23 – Informational Policy Scatter Plot.....	115
Figure 24– ForPol Sim SD Typical Run #1 (Informational)	118
Figure 25– ForPol Sim SD Typical Run #2 (Informational)	119
Figure 26 – Military Policy Scatter Plot	122
Figure 27 – ForPol Sim SD Typical Run #1 (Military).....	125
Figure 28 – ForPol Sim SD Typical Run #2 (Military).....	127
Figure 29– Diplomatic Policy Scatter Plot	129
Figure 30 – ForPol Sim SD Typical Run #1 (Diplomatic).....	131
Figure 31 – ForPol Sim SD Typical Run #2 (Diplomatic).....	133
Figure 32 – Economic Policy Scatter Plot	135
Figure 33– ForPol Sim SD Typical Run #1 (Economic).....	137
Figure 34 – ForPol Sim SD Typical Run #2 (Economic).....	139
Figure 35 – ForPol SD Behavior – Policy Response to System Stability.....	144
Figure 36 – COPDAB International Event Frequency.....	151
Figure 37 – COPDAB International Event Policy Distribution.....	152
Figure 38 – 1967 Arab-Israeli Six-Day War Events Type – 5% > Relative Frequency.	153
Figure 39 – System Dynamics Vensim Model – Salience of Political Event	155
Figure 40 – System Dynamics Vensim Model – Social Stress.....	156
Figure 41 – System Dynamics Vensim Model – System Stability.....	157
Figure 42 – System Dynamics Vensim Model – Policy Choice	158

LIST OF TABLES

Table 1 – Existing DES Software.....	24
Table 2 – Discrete-Event Simulation – Significant Literature	27
Table 3 – System Dynamics Simulation – Significant Literature	33
Table 4 – System Dynamics Simulation – Significant Literature (Continued)	34
Table 5 – Agent-Based Simulation – Significant Literature	42
Table 6 – Agent-Based Simulation – Significant Literature (continued)	43
Table 7 – ABM Literature Review Gaps	44
Table 8 – State-Actor and Non-State Actor Attributes.	59
Table 9 – Instruments of National Power (Policy Choices – Dependent Variables)	62
Table 10 – 1967 Arab-Israeli Six-Day War Policy Type Frequency.....	71
Table 11– COPDAB International Event Interaction Scale Points	77
Table 12– 1967 Arab-Israeli Six-Day War Relative Frequency of Events - By Instrument Type.....	78
Table 13 – 1967 Arab-Israeli Six-Day War Policy Type Frequency.....	81
Table 14– 1967 Arab-Israeli Six-Day War Policy Type Frequency.....	82
Table 15 – Policy Choice Variable Parameter.....	89
Table 16 – Social Stress Variable Parameters.....	91
Table 17 – System Stability Variable Parameters.....	93
Table 18 – Social Stress Variable Parameters.....	94
Table 19 – Statistical Summary	113

Table 20 – Informational Policy Typical Runs	117
Table 21 – Military Policy Typical Runs	124
Table 22 Diplomatic Policy Typical Runs	130
Table 23 – Economic Policy Choice Typical Runs	136
Table 24 – 1967 Arab-Israeli Six-Day War Monthly Event Frequency	151
Table 25 – 1967 Arab-Israeli Six-Day War Policy Distribution.....	152

LIST OF ACRONYMS (or) ABBREVIATIONS

AB – Agent-Based

ABS – Agent-Based Simulations

CAS – Complex Adaptive Systems

CHN - China

COPDAB – Conflict and Peace Data Bank

DE – Discrete Event

DES – Discrete Event Simulations

DIME – Diplomatic, Informational, Military, Economic

DS – Dynamic Systems

DSR – Discrete Sequence Run

EGY – Egypt

EPT – Event Pattern Tool

ForPol – Foreign Policy

FRN – France

GDP – Gross Domestic Product

GPSS – Gordon Programable Simulation System (GPSS)

HS – Hybrid Simulations

ICPSR - International Consortium for Political and Social Research

IR – International Relations

IRN – Iran

ISR – Israel

IRQ – Iraq

JOR – Jordan

LEB – Lebanon

M&S – Model and Simulation

NATO – North Atlantic Treaty Organization

NGO – Non-governmental Organization

OML – Object Oriented Modeling

PAL – Palestine

PAK - Pakistan

POL – Palestinian Liberation Organization

PMESII – Political, Military, Economic, Social, Informational, Infrastructure

PS – Political Simulations

RUS – Russia

SD – System Dynamics

SDS – System Dynamics Simulation

SYR – Syria

TAP – Threat Application Program

TUR – Turkey

UAR – United Arab Republic

UK, UKG – United Kingdom

UML – Unified Modeling Language

UN – United Nations

UNEF – United Nations Emergency Force

USSR – Soviet Union

US – United States

YAR – Yemen Arab Republic

CHAPTER 1: INTRODUCTION

1.1 Research Motivation

The motivation behind this research study is to provide the steps in calibrating a SD model as part of the testing, verification and validation process of an integrative framework that quantitatively analyzes foreign policy problems. This can be achieved by calibrating the model's input parameters and using the calibration results to run the model and observe if the model behaves in a typical way. The political science discipline provides the analyst with IR theoretical models and historical case studies to explain political behavior. However, an integrated framework that goes beyond theory and case study methodologies, which integrates these into a quantitative stochastic model, can be quite challenging, scarce or non-existent. Fine-tuning the SD portion of the model is the first step in addressing this challenge.

1.2 Purpose

Therefore, the purpose of this thesis is to calibrate the ForPol SD model input parameters and use the calibration results to run the model and observe how the model behaves as the first steps in the future verification and validation of a SD/AB hybrid simulation.

1.3 Problem

The problem this project addresses is the challenge with integrating theory, empirical data, and M&S into one framework, to provide policy analysts and decision-makers the ability to analyze the outcomes of political events, including the success or failure of policy choice implementation.

1.4 Solution

The first step in solving this problem is depicted in figure 1 with the orange boxes outlined in red, which consists in (1) fine-tuning the empirical data, input parameters and (2) running the model to determine if the SD ForPol model behaves per Choucir et. al. (2006), state stability principles and Coffi-Revila's (2009) state-actor behavior. The second step after model calibration is the proposed integrative framework depicted in figure 1 with white and gray boxes, which serves as the foundation for future work: system testing, verification and validation. The directional arrows depict the empirical and M&S inputs into each component of the integrative framework.

Consequently, the proposed framework is consistent with, (3) three IR theories political scientists use in comparative politics: realism, liberalism, and constructivism (Cederman, 1997; Kegley Jr., 2009; Nye, 2009), which describe the state of system agent behavior and their interactions within the system. Additionally, this approach is consistent with components of the theory of political uncertainty (Cioffi-Revilla, 1998). (4) The framework will operationalize the 1967 Arab-Israeli Six-Day War (Randolph,

2009). (5) It frames theory and policy modeling into a simulation of a regional political system and attempts to combine two paradigms of M&S—SD and AB—into a hybrid simulation. (6) The Vensim SD model (Ventana Systems, Inc., 2015) provides macro-level modeling of the regional system’s dynamic aggregate political behavior as it evolves over time (Law, 2015). (7) The AB model of SimPol (Cioffi-Revilla & Rouleau, 2009) provides a micro-level architecture modeling of state-actors and political event occurrences. Furthermore, ForPol uses Cioffi-Revilla’s SimPol model to incorporate a policy model for the instruments of national power (Chang, 2004; Department of Defense, 2013; Hillson, 2009; Nye, 2009).

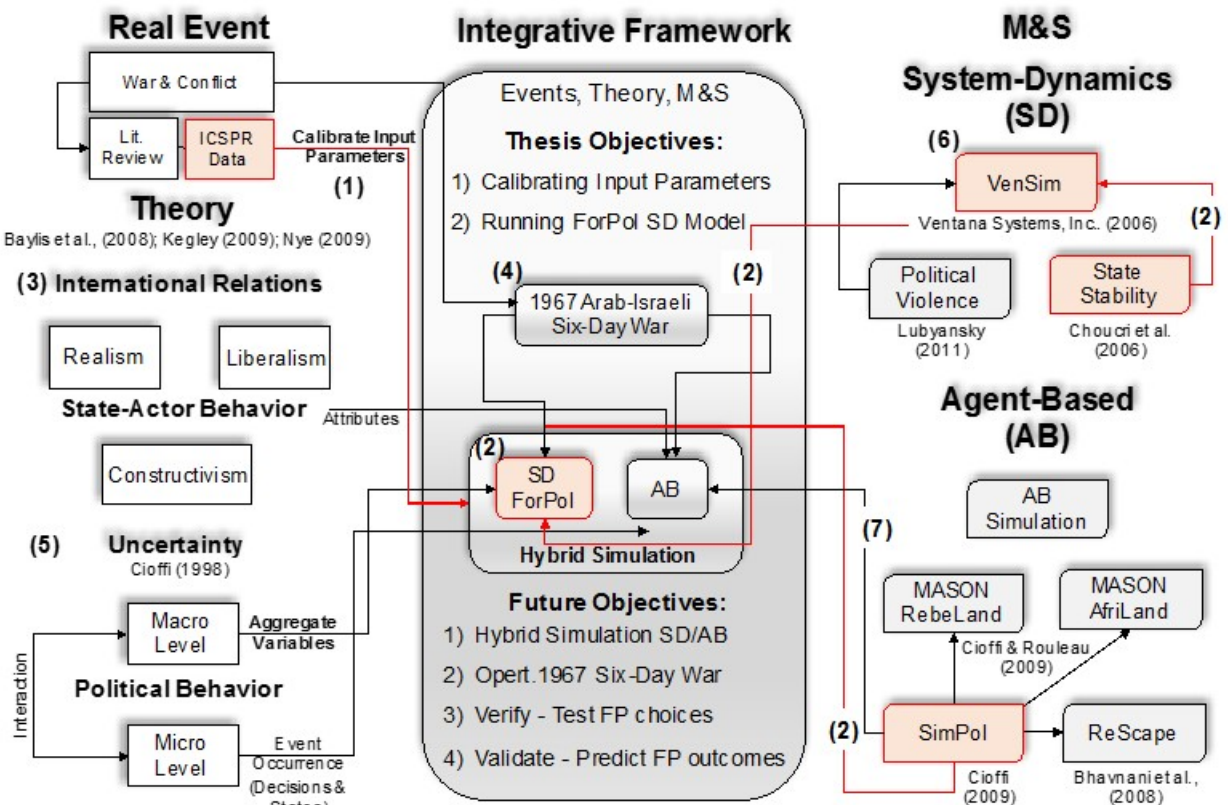

Figure 1 – Integrated Framework (Calibration, Testing, Verification and Validation)

Finally, this framework was not conceptualized in a vacuum. The literary evidence supports the predominant use of M&S from the discrete paradigm for analyzing practical and less abstract problems. Additionally, the literature review uncovered a significant use of this type in the areas of management and business for decision-making, analysis and process optimization purposes (Bapat and Sturrock, 2003; Nordgren, 2003); economic and financial for effectiveness and manufacturing and market analysis purposes (Harrel, 2003; Krahl, 2003; Roher, 2003); services and manufacturing for process-streaming purposes (Concannon, et al., 2003; Harrel, 2003; Krahl, 2003; Roher, 2003); and the medical, engineering and ergonomics (Harrel, 2003; Kelton, Smith and Sturrock, 2014; Krahl, 2003; Roher 2003).

Furthermore, the evidence substantiates the popular use of M&S from the agent-based paradigm for solving abstract problems (figure 21). The literature review demonstrates a persistent use of this types in social and political sciences

1.5 Scope

ForPol SD/AB/IR holistic model will require an extensive and comprehensive research agenda to test, verify and validate. Therefore, the present work will focus on input parameter calibration and conducting typical runs of the ForPol SD portion of the macro-political model, as a first step in the testing, verification and validation process of the proposed integrative framework. Furthermore, the deep analysis of the SD portion of ForPol is developed and calibrated in Vensim (Ventanan System, 2015), using data as

input parameters from the 1967 Arab-Israeli Six-Day War as a pilot (Azar, 1984; Randolph, 2009) .

1.6 Research Questions

1.6.1 How can the ForPol SD model input parameters be calibrated?

To properly, test, verify and validate the proposed hybrid SD/AB/IR simulation, input parameter calibration must be achieved and applied to the SD model to understand if the model is behaving as intended. Then, this critical step can be carried forward as part of a future integration process. Input parameter calibration must be achieved as a first step, if input parameters come from multiple data set sources (Azar, 1984; Bayer, 2006; Blechman, 1998; Chang, 2004; Dutka, Ghosn, Bradley, & Jones, 2005; McClelland, 1978; Sarkees, 2010; Taylor & Jodice, 1983). Therefore, calibration will serve as the process to sort and select accurate input parameters, which will allow the SD model to behave as intended. Additionally, this calibration process is tied to the thesis four hypotheses.

1.6.2 Once the data input is calibrated, will the model behave in a typical way?

This research question is concerned with the SD model's behavior state. Will the resulting calibration input produce behavior commensurate to the concept of state-stability (Choucri et al., 2006) and state-actor political behavior (Cioffi-Revilla, 1990).

This is achieved by running the calibrated input parameters (Azar, 1984) in the ForPol SD model and observing the references modes to see if the model behaves in a typical way: if the weight of a policy choice can overcome the political event salience, stability increases or is sustained; conversely, if the weight of the policy choice cannot overcome the political event salience stability decreases (Choucri et al., 2006).

1.7 Research Objectives

ForPol is a SD model, which aims at explaining macro-political behavior:

1. Calibrating input parameters from the Conflict and Pace Data Bank (COPDAB) (Azar, 1984).
2. Using calibrated input parameters to run the model and determine if the model behaves in a typical way.

1.8 Overview of the 1967 Arab-Israeli Six Day War

The 1967 Arab-Israeli Six-Day War was not an isolated event, but the result of a decade of international and Middle Eastern postcolonial conflict and superpower intrusion (Oren, 2002). Beyond that, it was an event with tentacles that not only shaped Arab-Israeli relationships, but also reached beyond regional conflict, exerting pressure internationally on superpower relations and on a race for regional hegemony. Therefore, one cannot gain an understanding of the causation of this war without contextualizing it accordingly.

Consequently, the origins of the Arab-Israeli conflict (figure 2) can be dated to the end of World War I in 1917, when the United Kingdom (UK) captured Palestine from Syria (SYR) and through the Belfour Declaration shows support for a Jewish state in Palestine (McNamara, 2003), then in 1922 mandated the Palestine state, which more than twenty years later in 1947 the UN votes on Resolution 181 ending the British Mandate by dividing the territory of Palestine into Jewish and Arab sectors, triggering a civil war which in 1948 escalates into the first full scale war between Israel (ISR) and its Arab neighbors known as the Palestinian War or Israeli War of Independence (Oren, 2002),. The Arabs (Egypt, Lebanon, Jordan and SYR) found reason to attack ISR when it declares independence and receives international statehood recognition. SYR and Iraq (IRQ) lead the war, followed by Joran (JOR) and later Egypt (EGY). The Arab's objective was to end UN Resolution 181 and Israel's declaration of independence. The war resulted in Jordan capturing the West Bank, Egypt Gaza and Jerusalem being divided into east and west. However, Israel maintained its territory as established by UN Resolution 181.

A year later in 1949, ISR and its Arab neighbors enter armistice agreements, therefore ending the conflict and establishing lines dividing Israel's West and its Arab neighbors (Oren, 2002). However, regional tensions continued and the armistice was violated a few years later in 1956, when EGY attempts to nationalize the UK and French (FRN) controlled Suez Canal, which resulted in the UK, FRN and ISR invading EGY to liberate the canal, also considered an international asset for free passage (Oren, 2002; Parker, 1993; Randolph, 2009).

The escalation of conflict continues its ascent, from an Arab perspective, when in 1946, Israel devises a water way plan to divert the Jordan river from the north to irrigate the south, reducing Syria's and Jordan's water capacity (Shemesh, 2008). The Arabs considered the establishment of the state of Israel and the water way issue an existential threat to the Arab community. The water way plan in the Arab's view just increased that perceived threat and regional instability (Shemesh).

The ISR water way plan, not only increased tensions, but tensions metastasized into a series of cross-border terrorist attacks against ISR, which were sponsored by EGY and SYR and executed by the Palestinian Liberation Organization (PLO) through al-Fatah from the JOR border (Shemesh, 2008). ISR in turn responded with greater force and in one occasion retaliation received strong international condemnation when in 1966 ISR attacks the city of Samu along the ISR-JOR West Bank in response to an Al-Fatah landmine attack against three Israeli soldiers from JOR territory (Crosbie, 1974; Quandt, 2005; Segev, 2007; Shemesh, 2008). Since the Suez, the Samu attack turned to be the biggest military event and in 1966 the U.S. votes on a UN Resolution 228 condemning ISR unproportioned response and provides JOR with military equipment.

Case Study: 1967 Arab-Israeli Six-Day War

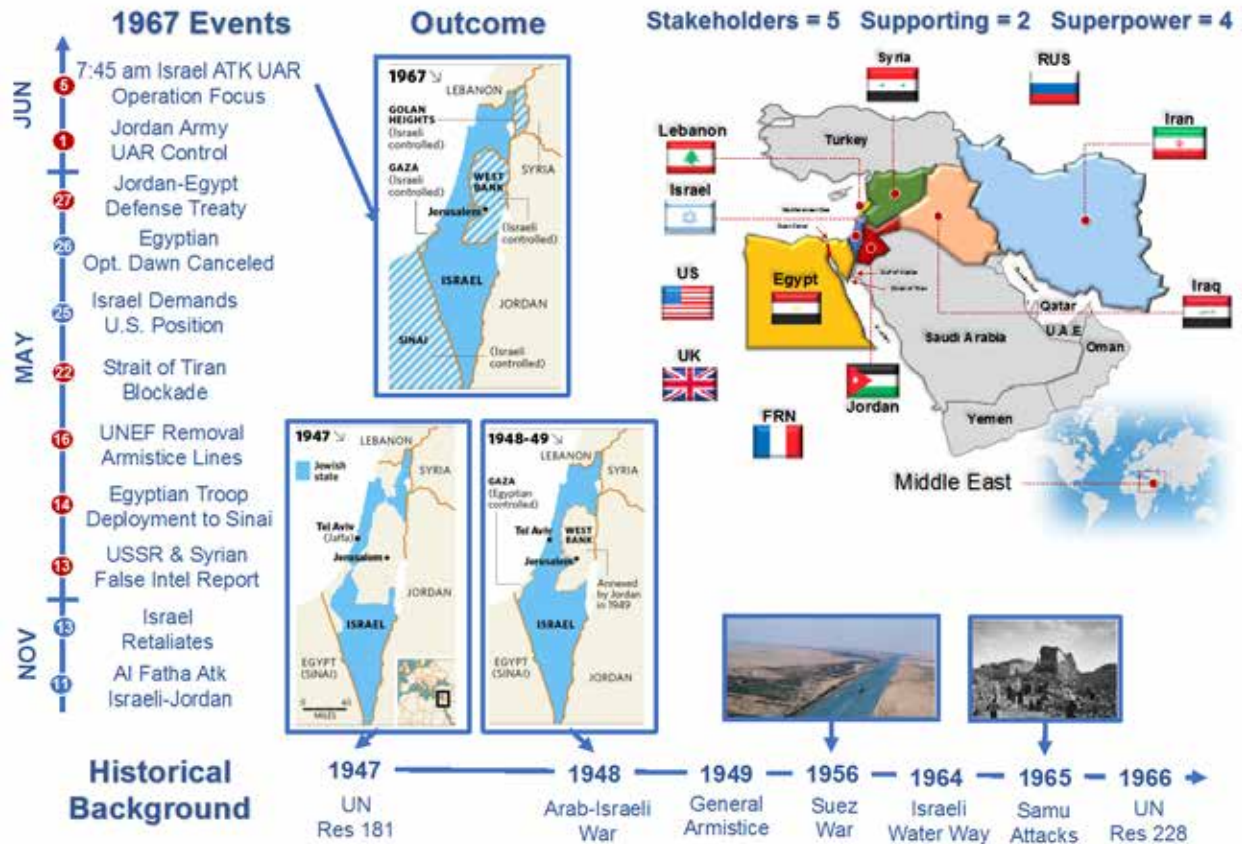

Figure 2 – Case Study: 1967 Arab-Israeli Six-Day War

This decade of regional escalating conflict was a precursor to the second Arab-Israeli war, or what is internationally known as the 1967 Arab-Israeli Six-Day War, which is the thesis pilot. Therefore, not to venture off on a historical exposition of the case, the study will focus specifically on the five primary actors (ISR, EGY, SYR, JOR, PAL) involved in the conflict, two supporting actors (IRQ and Iran) and the five superpowers encroached in the conflict (US, UK, FRN and Russia).

Subsequently, the focus will be the event occurrences of 1967, which in the stakeholder's perspective had the greatest effects, specifically the months of November, May and June, excluding the actual Six-Days of War. Starting the month of November, the highlight this month was the continued cross-border skirmishes between IRS and the PLO along both the SYR and JOR front. However, tensions truly reached a dangerous climax with a series of sequential events that are consider the main factors, which caused the Six-Day War (Randolph, 2009).

The first explanation was the December 31, 1964, Al-Fatah failed terrorist attack against ISR, which intended to provoke ISR retaliation against one of its Arab neighbors.

The second explanation of the war's cause came on May 13, 1967 when Russia (USSR) shared a false intelligence report with EGY about ISR forces amassing along the SYR border (Parker, 1993). The Egyptians believed the USSR report to be credible and failed to verify it, regardless of intelligence reports presented by the US and the UN to discredit these claims, and regardless of ISR request that EGY send a delegation to inspect the border (Parker, 1993; Quandt, 2005; Thant, 1978). Subsequently, EGY response came the next day May 14, 1967 with the deployment of troops to the Sini border west of ISR along United Nations Emergency Forces (UNEF) outposts.

The third possibility occurred on May 16, 1967 with the removal of UNEF from the demarcation line between EGY and ISR in conjunction with additional EGY forces deployed to the Sinai border (Thant, 1978; Segev, 2007).

The fourth possible explanation occurred on May 22, 1967 with Egypt's closure of the Strait of Tiran in the Gulf of Aqaba (Quandt, 2005; Randolph, 2009; Segev, 2007).

However obvious these causes may be, it would be an arbitrary exercise to attribute any one of them as the principal cause of either regional instability or the following war. More plausible would be to assume that the cause could be a combination or disjunction of all or some of these, or that other events less significant played a role as well.

1.9 Key Accomplishments

This thesis contributes in several ways to the M&S profession. The first, and main achievement, was the calibration of input parameters from the COPDAB/1967 Arab-Israeli Six-Day War (Azar, 1984; Randolph, 2009) into a Vensim SD ForPol model, which explains macro-political behavior in terms of system stability. For this purpose, scenarios were generated as part of the calibration process and hypotheses testing. Tied to this achievement, was the production of dynamic reference modes, which display how the model would typically run. These two achievements are initial steps in the future verification and validation process of the proposed hybrid simulation. The second achievement, is the proposal of an AB model for the study of micro-political state-actor behavior as part of a future integrative concept. Annex D shows a NetLogo interface as a conceptual pilot and Annex E, lists the simulation code in its infant state. The third, achievement was a comprehensive literature review, which exposed existing M&S and gaps in the political science discipline. Furthermore, the literature review focused on AB and SD M&S that are used for explaining social and political phenomena.

1.10 Thesis Organization

This thesis is organized into five chapters, starting with chapter one, which sets the foundation for the problem studied, presents the proposed solution, research questions and objectives, scope of the study and achievements. Chapter 2, outlines the M&S literature related to political science and identifies existing M&S and knowledge. Additionally, it describes the causal structure of system stability and social stress from a SD paradigm. Alternatively, from an AB paradigm, state-actors, policy and political event occurrences are modeled. Chapter 3, describes the method by which the empirical data is calibrated against the hypothesis and applied to the SD model to understand how does the model behave. Chapter 4, describes calibration and reference mode results. Chapter 5, summarizes the thesis purpose, achievements, discusses the findings, lists the thesis limitations and future research. Additionally, the thesis includes supporting appendices, which include the bibliography: appendix A includes SD model documentation; appendix B includes event data summaries; appendix C includes a filtered list of the COPDAB data set (Azar, 1984).

CHAPTER 2: LITERATURE REVIEW

2.1 Objectives

This chapter both describes the research methodology used to complete this literature review—choices made in searching, screening, and evaluating sources—and presents relevant research concerning this project, examining the modeling tools available to the political science discipline, and specifically those relevant to political simulations (PS) and hybrid simulations (HS) that incorporate AB and SD for foreign policy development, testing, implementation, and decision-making.

Additionally, this chapter reviews IR theory, political behavior modeling, and existing frameworks for this research that integrate theory and empirical case studies with M&S. Furthermore, it provides a synthesis of varying positions from leading authors on the subject matter, including work by Robert Axtell, Claudio Cioffi-Revilla, David Rousseau, Edward MacKerrow, Joshua Epstein, Mark Rouleau, and Uri Wilensky. Finally, it provides a comparative gap analysis to present conclusions towards the thesis problem statement.

2.2 Review Methodology

This project uses an integrative literature review method (Whittemore & Knaf, 2005) to critically examine both qualitative and quantitative bodies of work, and to discover various simulations used by political scientists for the aforementioned

purposes, keeping this project's primary problem in mind. Furthermore, this review is built on three actions: selecting the key words for the search, searching seven databases for relevant sources, and applying careful screening criteria.

2.2.1 Literature Search

An initial literature search was conducted between June 10, 2016, and July 10, 2016. Initially, four databases were selected from the UCF Political Science database: the PolicyFile database (Policy File Index, 1990), the UCF Engineering database (Engineering: Materials Science and Engineering: Electronic Resources, n.d.), the UCF M&S Dissertation database (UCF Modeling and Simulation Graduate Program, 2002), and Google Scholar (Google Scholar, 2004). The search was extended to the UCF main library and the following online databases: The 2015 Conference for Complex Systems (2015) and the 2016 Social Simulation Conference (2016).

The search terms and number of sources selected were as follows: "political simulation" (PS, n= 10), "hybrid simulation" (HS, n= 5), "agent-based simulation" (ABS, n= 10), "discrete-event simulation" (DES, n= 4), "complex systems" (CS, n= 2), and "simulation software" (SS, n= 9). Each initial key word search in each database produced thousands of sources, so the results were reduced by employing a combination of, or variations of, these key words: "quantitative models AND governance," "quantitative models AND military power," "quantitative models AND economy," "political event AND simulations," "political event AND HS," "political event AND ABS," "political event AND DES," "political event AND SS," "political event AND

CS,” “political AND ABS AND DES,” “PS AND governance,” “PS AND military power,” and “PS AND economy.”

Three tools were used to manage this process: the Mendeley desktop application, version 1.16.1 (© 2008-2016 Mendeley, Ltd.), which managed sources and citations; the MindView software (© 2002-2015 by MatchWare A/S), which helped to conceptualize and synthesize the literature review; and R.J. Torroco’s literature review checklist, presented in his 2005 article “Writing Integrative Literature Reviews: Examples and Guidelines,” which served as a general guide for writing the literature review. The MindView concept map in Figure 1 is a graphical representation of this thesis’ literature review results by key words and the number (n=) of sources.

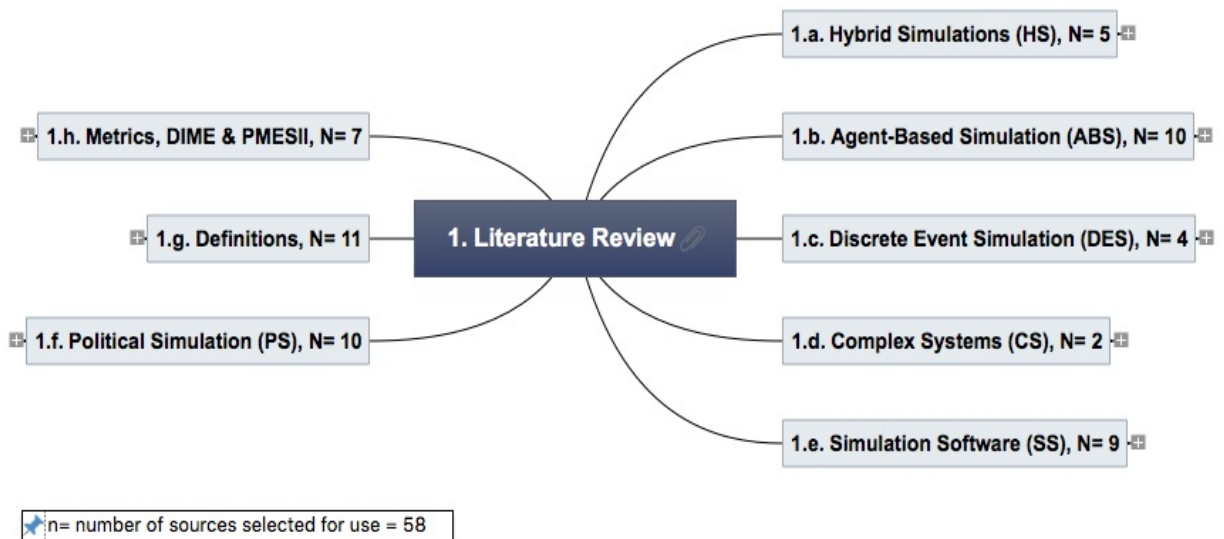

Figure 3 – Literature Review Concept Map

2.2.2 Screening and Evaluation Criteria

58 sources (figure 3) were selected according to the following screening criteria; if all questions could be answered “yes,” the source was included.

- 1) Is the source peer reviewed?
- 2) Is the research question relevant to my problem statement?
- 3) Are definitions transdisciplinary or only shared within a specific discipline?
- 4) Is the source qualitative or quantitative?
- 5) Are the methods and results relevant to my problem statement?
- 6) Are the measurements and variables applicable to my methods?

Each source’s abstract, methodology, and results section was reviewed in light of the screening criteria above and this thesis’ problem statement.

2.3 Political Simulations (PS)

2.3.1 Purpose.

The purpose of this section on political simulations is twofold. First, it explores a subject on which political scientist disagree—the use of theoretical versus computational methods of analysis when solving complex political problems, a choice that can hamper the advancement of simulations as a methodology in the political science discipline. Second, it provides a brief description of the process of policy planning in the United States’ (U.S.) Department of State, which relies mainly on

theoretical models and case studies to solve political problems. It further considers how M&S in the political sciences would be a better choice for solving complex political problems.

2.3.2 The Case for Political Simulations.

Political scientists have failed to solve three main problems in the discipline using established theoretical methods of analysis: how does collective action develop, and how are states formed (Conway, 2013)? Existing theoretical methods fail to explain the complexity of these problems, but computational methods of analysis continue to play a secondary role in solving these political puzzles (Conway, 2013). Why is this so?

One perspective in this argument is that theoretical methods of analysis are better for producing statically replicable results, preferred by the scientific community (Taber & Tipone, 1996). But a contrasting perspective is that computational methods of analysis can help political scientists shift past static theoretical modeling into computational modeling, which better produces probabilistic outcomes and can solve more complex political problems (Cioffi-Revilla, 1998; Lustick, Alcornb, Garces, & Ruvinskyc, 2012). This argument comes from political scientists who believe that utility and game-theoretic methods of analysis are not the best way to develop political policy (Cioffi-Revilla, 1998) because they depend on “rational choice” (Kegley Jr., 2009, p. 50; Kingdon, 1995, p. 77). This method of analysis departs from the premise that uncertainty does not define political decision-making, because uncertainty is part of life and not necessarily part of the political process (Cioffi-Revilla, 1998). However, Cioffi-

Revilla argues that if uncertainty is so pervasive in politics, then general principles of uncertainty must exist. In response, Cioffi-Revilla's (1998) theory of political uncertainty and its probabilistic casualty component argues that computational methods are best for studying complex political scenarios, and can better account for uncertainty than theoretical models of analysis (Cioffi-Revilla).

The dilemma of what methods of analysis to use in solving political problems is clearly displayed in the way the U.S. Department of State applies policy choices to political problems, by way of cumbersome policy agendas, game theory methods, scenario building, and personal judgment—less by computational methods of analysis and technology (Fontain & Burton, 2010; Kegley Jr., 2009). This approach, although popular, poses the danger of cognitive error and bias. The policy maker can find a scenario that fits his or her theory, and through a persuasive argument ignores the complexity of the political problem. In fact, the policy-decision maker may decide on a policy alternative by way of satisfying behavior, the best case, rather than studying several alternatives to more fully understand the political system (Kegley Jr., 2009). In contrast to this approach, computational models of analysis, such as agent-based simulations (ABS), are better suited to manage the complexity of bottom-up processes of policy development and actor-system interactions at a domestic, regional, and international level (Cioffi-Revilla, 2009; Epstein, 1999).

Consequently, several computational methods exist—mainly ABS—that address this complexity and bottom-up approach. In this category, we find a number of models, including MacKerrow's Threat Anticipation Program (TAP) model (MacKerrow, 2003), Rousseau's SharedID model (Rousseau & Van der Veen, 2005), Cioffi-Revilla and

Rouleau's RebeLand (Cioffi-Revilla & Rouleau, 2010), and SimPol (Cioffi-Revilla, 2009). Several simulations of this typology will be described in the ABS section of this chapter.

2.3.3 Summary and Review.

In this review, Cioffi-Revilla (2009) highlights the importance of computational models as a method for studying political systems. He argues that political computational models should incorporate theoretical, statistical, and mathematical methods of analysis as the foundation for an M&S development that can further expand our understanding of real political systems.

2.4 Hybrid Simulations (HS)

2.4.1 Purpose.

This section reviews the literature related to studies that combine one or more M&S paradigms into a hybrid simulation, specifically in the case of combining AB and DE paradigms. The work of Andrei Borshchev and Alexei Filippov, titled *From system Dynamics and Discrete Event to Practical Agent Based Modeling: Reasons, Techniques, Tools* (2004), sheds light on the reasons for and utility of combining different M&S paradigms, and covers existing literature on the combination of different M&S paradigms in the political sciences.

2.4.2 The Case for Hybrid Simulations.

Before attempting to combine more than one M&S paradigm into a hybrid simulation, the purpose of such a step should be considered. If we cannot comprehensively answer this question, a hybrid simulation may not be the answer to the current problem. Konstantinos Mykoniatis's dissertation (2013) explores this question and presents a useful framework that can help determine what M&S combination works best considering the desired simulation end state.

The complexity of a system, and the level of abstraction needed to approximate a realistic model, may require the integration of more than two M&S paradigms—DE, AB, SD, or DS—into a framework that can solve a given problem or explain the system's behavior. This M&S approach is well known and well explained by Borshchev and Filippov (2004) as they compare three simulation methods with respect to the systems methodological approach, and argue that modelers can construct AB from SD and DE models to increase abstraction and enhance the simulation's ability to explain complex agent behavior, relations, and connections, therefore providing a deeper understanding of the system modeled. They compare each paradigm against AB, then build the AB model based on the paradigm selected and on the operationalized case studies to test combinations with the NetLog tool kit (Wilensky, 1999).

Borshchev (2013) studied the dynamics of Hispanic acculturation and behavior by developing an AnyLogic AB and DS model. The model simulated a Hispanic population whose agents' level of acculturation varied dynamically in comparison to the population. They demonstrated that dynamically complex agent behavior emerged in

the population while temporally steady population sections emerged. This methodology used a bottom-up approach to explain dynamic agent and system behavior.

As Borshchev and Filippov (2004) suggest, the literature shows that many disciplines have adopted hybrid M&S frameworks to explain complex problems like these, as in engineering (Dubiel & Tismhoni, 2005; Lee & Berkeley, 1997); healthcare and emergency management (Anagnostou, Nouman, & Taylor, 2013); and social, political, military, and manufacturing fields (Allen, 2011). However, the use of hybrid models that integrate more than two M&S paradigms, seem to be underrepresented in the political sciences. Alexander Lubyansky (2011), for example, in his dissertation proposal, presented a hybrid simulation that combined SDS and ABS to test two theories of political violence: political opportunity and collective action. However, in his dissertation, he used only SD to produce modes of reference to compare against these two theories (Lubyansky, 2014).

2.4.3 Summary and Review.

The above literature demonstrates that using HS to solve complex problems is possible if the problem and methodology is clearly defined (Borshchev & Filippov, 2004). Many simulation tools have been used to combine M&S paradigms, such as AnyLogic (Borshchev, 2013) and NetLogo (Wilensky, 1999). The greatest advantage of HS is that a problem can be explored using two paradigms to increase explanatory power. A second advantage is that researchers can explore problems with two simulation levels: analysis system (macro) and agent (micro) (Cioffi-Revilla, 1998).

Researchers in the political sciences have proven that both levels can be modeled through hybrid methods (Lubyansky, 2011, 2014). The application of this method is relevant to the current thesis, as hybrid simulations can be used to explain the interaction of variables at the system level, and the event occurrences and decisional acts at the agent level (Cioffi-Revilla, 1990). Though the use of HS in exploring political science problems has been limited, so has the use of discrete event simulations (DES).

2.5 Discrete Event Simulations (DES)

2.5.1 Purpose.

This section provides a brief introduction into DE M&S, an overview of existing DE political simulations, and a discussion of the relevance and utility of DES as it relates to political event analysis and foreign policy development. Ultimately, it leaves the reader with an understanding of DES and its significance to the current problem.

2.5.2 The Case for Discrete Event Simulations.

DES as a computational method of analysis dates to the 1960s, when Mr. Geoffrey Gordon, an engineer at IBM, introduced the Gordon Programmable Simulation System (GPSS). Gordon began using continuous simulations as early as 1954, working with MOSAIC (an early computer simulation program) to solve equations for missile trajectory. However, MOSAIC was written in a machine language (Gordon, 1978).

Later, because of both coincidence and need, Gordon (1978) developed the first discrete event simulation in the form of an entities system, processing through a sequencing diagram simulator that consisted of queues, delays, and servers. As a test, he used a supermarket as the system, with people moving through. Soon after, IBM used the GPSS to study teleprocessing systems (Gordon, 1978).

Since Gordon's (1978) contribution, DES have evolved and been used by several disciplines in different settings: science, engineering, healthcare, economics, manufacturing, business, logistics and supply-chain, management, military, telecommunications, emergency response, airports operations, criminal justice, and public sector (Banks, Carson, Nelson, & Nicol, 2004; Kelton, Smith, & Sturrock, 2014; Law, 2015). Table 1 portrays the most prevalent DES available by discipline and industry. As is evident, the use of DES remains minimal in the political sciences, leaving open many possibilities for its use in this area.

Table 1 – Existing DES Software

DES examples from the works of (Banks et al., 2004) were used to draft this table.

DES	Discipline/Field	Type	Purpose	URL	Reference
Arena	Business	Discrete & Continuous	Business process and high-level analysis	www.arenasimulation.com	Bapat and Sturrock, 2003
OpQuest	Business	Discrete & Continuous	Business optimization software	www.arenasimulation.com	Bapat and Sturrock, 2003
SIMIO	Healthcare, Manufacturing, Supply-chain & Mining	Discrete	Simulates discrete systems and processes of all type	www.simio.com	Kelton, Smith and Sturrock, 2014
AutoMod	Economics, Logistics		Manufacturing and Material Handling	www.automod.com	Roher, 2003
Delmia/QUE ST	Economics, Manufacturing	Discrete	Queuing Event Simulation Tool for manufacturing oriented simulations	www.delmia.com www.3ds.com	Roher, 2003
IGRIP	Engineering	Discrete	Robotic simulation and programing, human-based work cells	www.delmia.com	Roher, 2003
ERGO	Ergonomics	Discrete	Ergonomic Analysis	www.delmia.com	Roher, 2003
Extend	Economics, Manufacturing and Business	Discrete & Hybrid	supply-chain dynamics, reliability engineering, pulp and paper processing	www.imaginethatinc.com	Krahl, 2003
Flexsim	Engineering, Management	Discrete, Object Oriented	production efficiencies and reduce operation costs	www.flexsim.com	Nordgren, 2003
Micro Saint	General	Discrete	Network simulation of real process	www.maad.com	Bloechle and Schunk, 2003
ProModel	Economics, Business	Discrete	Simulate manufacturing systems, rule based decision-logic	www.promodel.com	Harrel, 2003
MedModel	Medical	Discrete	Simulate healthcare systems	www.promodel.com	Harrel, 2003
ServiceModel	Services	Discrete	Simulate service systems	www.promodel.com	Harrel, 2003
SIMUL8	Services	Discrete	Modeling of service industries where people process transactions	www.simul8.com	Concannon, Hunter, & Tremble, 2003
WITNESS	Services, Manufacturing	Discrete & Continuous	Modeling of service and manufacturing industries	www.witness-for-simulation.com	Markt & Mayer, 1997

Though real-world political processes appear for the most part stable, while volatile around critical events, outcomes are not expected to change over time (deterministic). Nevertheless, as the political processes evolve over time, a singular event may occur that will change the state of that process (stochastic). The human factor, whether an individual, group, full society, or state-actor, will always inject change and uncertainty into a political process (randomness). In some cases, political events contain DES characteristics when the political process is approached as a system model.

A system model is characterized by three features: its stochastic, dynamic, and discrete-event properties. If a system is represented continuously as it evolves over time, and if the system variables change instantaneously at different points in time, it would be considered a DE system (Law, 2015; Leemis & Park, 2006). Therefore, figure 4 conceptualizes the components of this system model and will later serve as context for a DES political event example. This thesis focuses on stochastic systems that are dynamic, discrete, and continuous, as depicted in Figure 4 (Law, 2015), because political systems are characterized by multiple variables that affect political event occurrence and state-actor behavior in probabilistic and uncertain terms (Cioffi-Revilla, 1998). Alternatively, political systems can also be considered dynamic system that continuously evolves over time (Law, 2015), with some discrete characteristics as the instantaneous occurrence of political events alters system state at specific points in time (Cioffi-Revilla, 1998; Law, 2015).

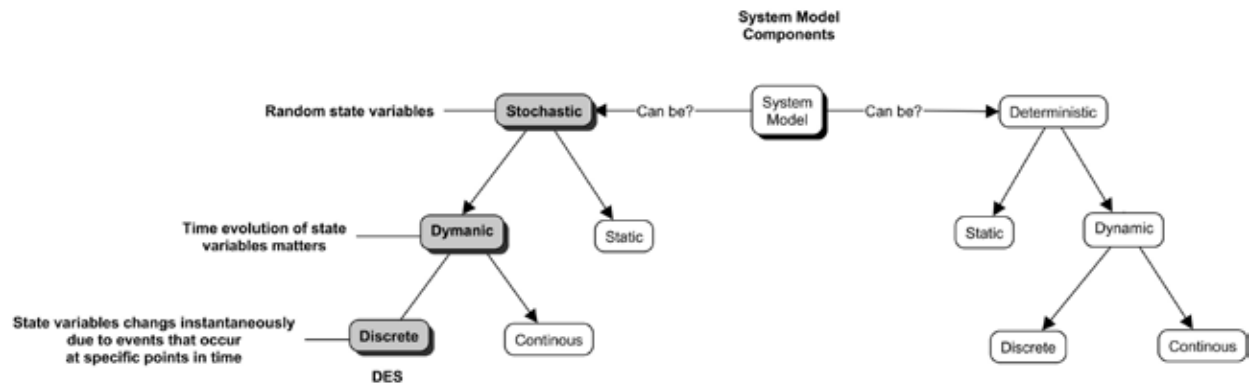

Figure 4 – System Model Components

In summary, political system models can be characterized as stochastic, dynamic, and discrete, because from a modeling perspective, these systems are dynamic and discrete in nature. This is in contrast to static models, which are based on stable processes and are inappropriate in these situations (Pidd, 2004). How, then, do researchers model political systems from a discrete perspective? Can they use this paradigm to model the behavior of agents during a political event, or must they use this model to simulate discrete patterns of political events over time to forecast outcomes? The literature review outlined in Table 1 provides a guide that answers these questions.

Table 2 – Discrete-Event Simulation – Significant Literature

Article	Discipline	Topic	Methodology	Tool(s)	Significance
Hudson, Schrod, & Whitmer (2008)	Political, Social Science	Political Event Modeling Identifying events which follow discrete patterns, which we can model.	Discrete Sequence Rule (DSR) Model Framework, which incorporated the DSR to model political behavior over time and the Event Pattern tool (EPT) to measure specific rules at an aggregate level to demonstrate how patterns of behavior change over time in the Israeli-Palestinian conflict.	DSR-EPT (http://www.nkss.org)	Quantitative analysis for political events over time. The DSR-EPT can help predict how political behavior can change over time when different rules (policy choices) are applied to the model.
Ratkovic & Eng (2009)	Political Science	Political Event Modeling Identifying discrete jumps (events) in political processes.	Smoothing Technique. Smooth + Jump Function. Ratkovic, et al., used this technique to determine the jumps in presidential approval ratings over time.	Gaussian Noise Simulation	The use of algorithm allows a flexible means to model other social and physical processes.
Berge (2015)	Economics		Use of gradient boosting linear and non-linear models to predict exchange rates for different currencies	Non-parametric Algorithm	The simulation recognized the reoccurrence of shorter intervals of intense economic activity (negative GDP growth)

Transdisciplinary scholars have produced extensive literature and DES tools, as evidenced in Table 2 demonstrates. However, in the political science discipline, DE modeling proves scarce. This review found only three authors who explore the use of DES to predict and forecast discrete events and patterns over time. Hudson, Schorodt, and Whitmer, for example, created a Discrete Sequence Rule (DSR) in their article “Discrete Sequence Rule Models as a Social Science Methodology” (2008), as a framework for modeling political behavior over time for the Israeli–Palestinian conflict, using historical event data interposed over agent models of each state-actor to analyze foreign policy choices. The authors employed face-to-face and historical methods to validate the model, then combined the DSR with an Event Pattern Tool (EPT) to measure specific rules (variables) at an aggregate level, demonstrating how patterns of behavior changed over time (Hudson, Schrod, & Whitmer, 2008). Through the operationalization of the Israeli-Palestinian historical event data in a simulation, they uncovered patterns in behavior over time as they applied different sets of rules (foreign policy choices) to the model.

Similarly, Ratkovic and Eng, in “Finding Jumps in Otherwise Smooth Curves: Identifying Critical Events in Political Processes” (2009), demonstrated that the application of discrete statistical modeling, such as the Smoothing Technique (Smooth + Jump Function), can predict jumps in presidential and congressional approval ratings over time. They operationalized it with a Gaussian Noise Simulation to predict these jumps, validating the simulation against a large historical presidential and congressional approval data set. The significance of their results is that the smooth + jump statistical function not only applies to this case, but also to several other political processes in

which critical events occur. The methodology is flexible enough to provide a means to model other social and physical processes in which a smooth curve is present with an occasional discreet jump (Ratkovic & Eng, 2009).

Finally, Travis J. Berge, in his doctoral dissertation *Forecasting and Evaluating Discrete Events in Macroeconomics and International Macroeconomics* (2015), argued that the traditional models of predicting extreme economic events are inappropriate when applied to different currency exchange rates. Berge used a gradient boosting method of linear and non-linear models, combined with algorithms that forecast spikes in extreme economic activity (Gross Domestic Product–GDP) over time, and discovered that—contrary to current thought—extreme economic activity reoccurs at shorter time intervals.

2.5.3 Summary and Review.

Drawing from the evidence and examples above, as well as the material Anagnostou et al. present in *Distributed Hybrid Agent-Based Discrete Event Emergency Medical Services Simulation* (2013), Cioffi-Revilla's PolSim polity model (Cioffi-Revilla, 2009), and the integration of DES and ABS found in Dubiel and Tishmoni's *Integrating agent based modeling into a discrete event simulation* (2005), a similar DES framework can be developed to model the international system. It can be considered a stable system only until the occurrence of a political event at a specific point in time destabilizes it. Although some ABS elements are present within this framework, this discussion will be focused on DES.

In summary, this framework conceptually demonstrates that a DES can be useful to model specific random events over time as inputs into an agent behavior paradigm. In Chapter 3, the 1967 Arab-Israeli Six-Day War (Randolph, 2009) will be operationalized in order to test the validity of this framework. In the next section, SD is discussed in detail as a possible model for political behavior and for interaction with DE models.

2.6 System Dynamics (SD)

2.6.1 Purpose

This section makes the case for the relevance of SD as it relates to the study of foreign policy development and political aggregate behavior, by providing a summary and review of the relevant SD and SDS literature. Ultimately, the gap analysis provided creates a link to this thesis' problem statement.

2.6.2 The Case for System-Dynamics Simulation

The SD M&S paradigm is widely used to study complex systems in the physical and social sciences, as well as for the modeling of economic systems, industrial supply chains, policy, and decision-making (Angerhofer & Angelides, 2000). Jay Forrester invented this paradigm in 1958 with the purpose of modeling complex system in terms of stocks, flows, and information links to explain behavior at the system level (Law,

2015). The paradigm explains the interaction between stocks and flows in terms of feedback loops between system variables (Sterman, 2000). In short, SD looks at a problem from an aggregate perspective to model and make strategic decisions. Several SD software tools exist, such as AnyLogic (Borshchev, 2013), iThink (Richmond, Peterson, Chichakly, Liu, & Wallis, 2004), PowerSim (PowerSim, 2003), and Vensim (Ventana Systems, Inc., 2015), for the dynamic modeling and analysis of systems.

SD M&S has been used for many purposes (table 3), including in the social and political sciences. Scholars have used SD M&S to model policy networks, dynamically comparing them with empirical policy networks (Stokman & Zeggelink, 1996) for several reasons: to explain the relationships between greed, grievance, mobilization, and civil war (Keen, 2012; Regan, 2005), to model the stability of states in a political system and explain the possible factors for state failure (Choucri et al., 2006; Goldsmith, Madnick, Mistree, Morrison, & Siegel, 2007), to model the dynamic relationship between ethnicity and conflict (Wimmer, Cederman, & Min, 2009), and to compare theories of violence (Lubyansky, 2011). SD is the best approach for modeling the aggregate behavior of complex system because it provides the flexibility to apply conceptual models and empirical data gathering (Choucri et al., 2006). Humans, for example, hold a basic mental model of the political systems around them and their components, information about the system at discrete points in time, and the policies that govern decisions made about the system. SD modeling converts these mental model components into mathematical equations that then return empirical feedback, helping researchers explain the interactions between the system's components (Choucri et al., 2006; Goldsmith et al., 2007; Sterman, 2000). Table 3, below, summarizes the existing SD

model and SDS and serves as guide for the literature review and its significance to the problem statement.

Table 3 – System Dynamics Simulation – Significant Literature

Article/Book	SD Model /SDS	Type	Methodology	Gap
(Stokman & Zeggelink, 1996)	Power & Policy Access Model	Dynamic	Use of two dynamic access models to explain the nature of politics: 1) Power 2) Policy	1) Policy models do not approximate to real policy networks. 2) The model needs to include parameters from real networks.
(Regan, 2005) (Keen, 2012)	Grievance, Rebellion & Civil War Model	Dynamic	Use of logistics regression to test three variables: 1) Protest 2) Rebellions 3) Civil War	1) Other variables exist such as religion, ideology, extremism, which could change the predicted outcome. 2) The variables are categorical and not continuous. 3) Each variable is independent from each other; they do not interact with one another. 4) The model lacks predictive power because it's not a system dynamic model.
(Choucri et al., 2006) (Goldsmith et al., 2007)	State Stability and Failure Model	System Dynamics	Use of SD to model: 1) Insurgency and recruitment for two countries 2) Policy to reduce or remove insurgency	1) The SD model excludes other variables
(Wimmer et al., 2009)	Ethnic Politics Model of Conflict	Dynamic	Use of logit multinomial regression to test: 1) Rebellion 2) Civil War 3) Secession Against the Ethnic Power Relations Data Set (EPR)	

Table 4 – System Dynamics Simulation – Significant Literature (Continued)

Article/Book	SD Model /SDS	Type	Methodology	Gaps
(Lubyansky, 2011)	Theories of Political Violence	SDS & ABS (NetLogo)	Combining SD & ABS to: 1) Compare and test three theories of violence 2) Develop a dynamic hypothesis 3) Operationalize theories in a simulation	1) The proposal does not address data sources, how data will be included in the model. 2) The proposal does not explain the interaction between the SD model and AB model.
(Lubyansky, 2014)	Theories of Violence	System Dynamics	Use of SD to Model: 1) Theories of Violence 2) Generate and test reference modes Use of data to test reference modes	1) The referent models are not quantitative. 2) The literature review is not exhaustive. 3) Only models three theories of political violence. 4) The dynamic hypotheses do not include all the variables. 5) The SD models output is descriptive and qualitative in nature.

2.6.3 Summary and Review

Stockman and Zeggelink's work is one of the first publications on the dynamics of policy networks and the impact of decisional outcomes (1996). Their dynamic access models (with access to the most powerful decisional actors), resulted in policy models that performed better than power models, because they considered network diversity and produced better decisions and outcomes. The advantage of this dynamic approach to policy and power is that it demonstrates that aggregate political behavior is a dynamic process in which policy process has a greater impact (Stokman & Zeggelink, 1996).

However, while Stokman and Zeggelink's work demonstrated a dynamic approach to policy and power, their model did not achieve realism, and the networks generated in their model did not approximate to empirical or real policy networks (Stokman & Zeggelink, 1996). This is where the use of a SD approach could integrate real world parameters into a power and policy model (as stocks and flows), and possibly produce realistic results that match empirical policy models.

This work is relevant to the proposed ForPol model of political behavior, because it shows that policy choice models have a better outcome than power models (Stokman & Zeggelink, 1996). It also shows that using SD to model policy at the macro-political level can better explain the dynamic effects of policy choice on aggregate behavior.

Regan (2005) and Keen (2012) explore the dynamic effects of social grievance on protest, mobilization, rebellion, and civil war. They use a logistic regression model to test these three variables and attain the following results: first, autocratic governments demonstrate lower probabilities for rebellion, but probabilities increase as popular

inclusiveness increases (Regan, 2005); second, democratic governments demonstrate lower levels of rebellion; third, distribution of resources is a factor in the onset of violence; fourth, state repression is a factor in reducing grievance, but also in increasing mobilization to violence; and fifth, the type of resources available to mobilize against the state have no impact on the onset of civil war (Regan, 2005). Contrary to the expected result that specific resources like precious metals and narcotic resources would be a factor, the test demonstrated the opposite. However, resource distribution is a factor for the sustainment of a civil war, and a strong factor for the onset of violence in all three models (Regan, 2005). Another significant factor in terms of mobilization is state repression, which, though it may reduce levels of grievance, remains a factor for social and political mobilization.

The advantage of using a logistic regression method is that it theoretically predicts the outcome of a single variable (Diez, Barr, & Cetinkaya-Rundel, 2015)—such as protest, rebellion, mobilization, and civil war—against several independent variables, including resources, state repression, and social grievance (Regan, 2005).

The disadvantage to using logistic regression is that it is not useful if the independent variables are selected incorrectly. Consequently, on a categorical basis, logistics regression works for discrete variables and not when variables are continuous (Diez et al., 2015). One can, for example, theoretically explain the onset of rebellion, but not a real case of rebellion, which is continuous over time. Logistic regression is not a good method for measuring the continuous variables involved. Another disadvantage is that each variable is independent from the variable under observation; in social research, multiple observations are required to attain valid results.

Regan could have used a SD model to study the causality for each system and to explore the complexity and range of other variables that could affect each. Furthermore, he could have nested all three models into one to uncover the dependence of each variable on the rest.

Choucri et al. and Goldsmith et al. (2006) use SD to create a model of state stability and failure to test which variable—insurgency or recruitment—has the greater effect on the onset of civil war. They consider two fictitious countries, seeking how best to apply policy options that reduce insurgent population and recruitment (Choucri et al., 2006; Goldsmith et al., 2007). The SD study demonstrated that the propensity for civil war decreases as state resilience increases, and insurgency increases as state capacity decreases. Finally, from a policy application perspective, they discovered that a regime anti-insurgency message is more effective than suppression in reducing insurgency and increasing resiliency (Choucri et al., 2006; Goldsmith et al., 2007).

The advantage of the SD model of stability is that the interactions between the variables in the model produce predictive outputs that allow for the successful application of policies that combat insurgency and recruitment. The SD model helps researchers understand the second and third order effects of the variables on state stability by simplifying the system's complexity. The last advantage of this model is that it incorporates data regarding social indicators for computational purposes (Choucri et al., 2006; Goldsmith et al., 2007).

The relevance of this study to the current thesis is that that their definition of state stability can be adapted to the current model, since in this model the onset of the 1967 Arab-Israeli Six Day War may have resulted from similar sources of instability, such as

social stress, salience of the referent political event, and the capabilities of actors as decisional acts. Choucri et al. and Goldsmith et al. (2006) research also indicates that a SD quantitative model can be developed with existing data sets.

Wimmer and Cederman, in *Ethnic Politics and Armed Conflict* (2009), use a multinomial regression method (Diez et al., 2015) to model rebellion, civil war, and secession, and to test these models using empirical data from the Ethnic Relations Power Data Set (Wimmer et al., 2009). The purpose was to determine the factors of state power that can lead to ethnic conflict. Their method produced the following results: first, that the exclusion of large ethnic populations results in armed rebellion against the state; second, that power sharing among significant numbers of elites results in an increase of violence; and third, that states with weak and little governance experience secession conflict. This study is different from Keens and Regan's because it considers ethnic exclusion and discrimination as a variable with effects on political violence, as opposed to grievance and mobilization due to resources allocation.

Alexander Lubyansky, in his dissertation proposal *titled A System Dynamics and Agent-Based Simulation Approach to Test Group-Level Theories of Political Violence* (2011), used a hybrid approach: the combination of SD & AB into NetLogo (Wilensky, 1999) to compare, model, and simulate two theories of political violence. In his proposal, Lubyansky developed a dynamic hypothesis of causality regarding these theories of violence: political opportunity and collective action. His SD model attempts to quantify the theories. The AB model then incorporates the Vensim SD model. ABS agents are heterogeneous and random, their aggregate behavior matches the aggregate behavior of the SD model, so the ABS model provides the capability to test

the SD model. In his dissertation, *A Feedback Loop of Contentious Politics* (Lubyansky, 2014), he excludes the ABS model initially proposed and uses only the SD approach to test empirical data against reference modes of three other theories of political violence: relative deprivation, resource mobilization, and political opportunity.

The advantages of this SD model of political violence is that it can be adapted or extended to other projects in the social and political sciences. For example, the SD mental model of political opportunity and collective action may apply not only to the case of isolated states, but also to international or regional political systems. At the state level, the term used is “grievance,” as it is the social reaction to state repression (Lubyansky, 2011). Alternatively, at the international or regional level, the term could be “social stress,” as a reaction to a policy issue or political event (Cioffi-Revilla, 1998).

The disadvantages of Lubyansky’s work revolve around his methodology. His SD model, for example, does not approach model formulation from a quantitative perspective but from a qualitative perspective, and does not provide a component for the formulation and testing of policy (Lubyansky, 2014). He states that the challenge with SD models that are quantitative and predictive in nature is the availability and accuracy of data on the social indicators for the model, since there is no general agreement among scholars in the social or political sciences on the indicators of conflict or violence, or on the agent attributes and their definitions (Lubyansky, 2014).

The relevance of Lubyansky’s (2014) work to the current project is in its replicability, which can be extended by converting it into a broader model that can explain other theories such as uncertainty (Cioffi-Revilla, 1998), that can quantify data input, that can test policy choices, and that can make predictions.

2.7 Agent-Based Simulations (ABS)

2.7.1 Purpose.

This section makes the case for the relevance of AB M&S as it relates to international political analysis and foreign policy development, by providing a summary and review of existing ABM and ABS literature. The following gap analysis provides a link to this thesis' problem statement.

2.7.2 The Case for Agent-Based Simulations.

Averill M. Law, in *Simulation Modeling and Analysis* (2015), states that there is no consensus on a universal definition accepted by computational scientists for ABS. However, through reviewing the literature, ABS *can* be defined as a model, in which entities and their agents can sense other entities and agents in the environment and make decisions based on informational input. These entities and agents conduct themselves by a set of rules that determine their behavior, and they can adapt to the input, changing their behavior over time (Law, 2015). Consequently, ABS are in the family of DES, because as the entities and agents interact in the system environment, they change the state of the system instantaneously at countable points in time. Definitions differ, however, according to ABS application domain and discipline, as each determines agent attributes and characteristics for the simulation's purpose. Still, one

characteristic remains constant across all ABS definition: universal behavior does not define the system—the agents' decentralized behavior do (Borshchev & Filippov, 2004). Table 5 and 6 below, summarize the existing ABS and serves as a venue to review the literature and its significance to this project.

Table 5 – Agent-Based Simulation – Significant Literature

Article/Book	ABM/ABS	Type	Methodology	Results
MacKerrow, 2003	TAP	Single-Agent	Incorporates: Theory Algorithms ABS	Generation of multiple scenarios susceptible to policy, media and economic variations for statistically analysis and decision-making
Doran, 2005	Iruba	Single-Agent	Incorporates: Guerrilla warfare case studies Geographical regions ABS	Increasing number of insurgents lead to the success of an insurgency, population support and recruitment
Rousseau, 2006	SharedID	Single-Agent	Incorporates: CAS Theory ABS	<ol style="list-style-type: none"> 1) Correlation in oneself and collective view with shared identity 2) Unstable environments encourage the emergence of shared identity 3) Leadership decreases shared identity 4) Complexity, stability and leadership interaction polarizes a society
Bhavnani, Miodownick, & Nart, 2008	REsCape	Single-Agent	Incorporates: CAS Theory ABS	<p>Onset and duration of civil war is directly related to three variables:</p> <ol style="list-style-type: none"> 1) Economic Resources 2) Ethnicity Polarization or Salience
Bennett, 2000	Insurgency	Single-Agent	Incorporates: ABS	<ol style="list-style-type: none"> 1) Insurgency is defeated by counterattacks that are accurate not effective 2) Counter-insurgency is difficult when the population perceives the government as the insurgent 3) The range of accuracy determines the duration of an insurgency

Table 6 – Agent-Based Simulation – Significant Literature (continued)

Article/Book	ABM/ABS	Type	Methodology	Results
Cioffi-Revilla, 2009	SimPol	Single-Agent Multi-Agent	Incorporates: 1) Use of OML 2) Use of UML 3) CAS Theory 4) Lakatosian Research Model	1) Low resolution state-actor model can reveal dynamics obscured by real conditions of a political system 2) High resolution state-actor model can reveal real key properties in political systems
Cioffi-Revilla and Rouleau, 2009	AfriLand	Multi-Agent	Incorporates: 1) SimPol Model 2) RebeLand Model 2) ABS 3) CAS Theory	Socio-cultural and environmental dynamics that transcend boundaries: 1) Refugee flows 2) Transnational conflict 3) Crime 4) Natural hazards
Cioffi-Revilla and Rouleau, 2010	MASON RebeLand	Multi-Agent	Incorporates: 1) SimPol Model 2) ABS 3) CAS Theory	1) Overall resiliency of a polity is a dependent variable 2) State-actors experience system failure by combination of large sets of stressful issues not just one or a few
Cusack, 1994	EARTH	Multi-Agent	Incorporates: 1) IR Theory: Realism 2) ABS	1) Collective security equals system endurance 2) Collective security principles survive in a realist world 3) Collective security principles do not survive when state-actors operate per realist principles
Cederman, 2010 Cederman & Girardin, 2007	GeoSim	Multi-Agent	Incorporates: 1) Power Law Theory 2) CAS Theory 3) ABS	1) Self-organizing behavior dependent on a technological change process 2) State-actor decision to wage war is dependent stochastic events

Table 7 – ABM Literature Review Gaps

Article/Book	ABM/ABS	Gaps
MacKerrow, 2003	TAP	1) TAP does not no predictive or produce probabilistic output 2) Not a multi-agent ABS
Doran, 2005	lruba	1) lruba does not include inter-agent communication and cognition 2) lruba does not include all possible range of parameters and different combinations the model components 3) Not a multi-agent ABS
Rousseau, 2006	SharedID	Model does not account for: 1) Image Complexity 2) Environment volatility 3) Leader Attributes 4) Not a multi-agent ABS
Bhavnani, et. Al., 2008	REsCape	1) Does not provide predictive or probabilistic output 2) No GIS lacks country specific landscape 3) No empirical data for application to model 4) Not a multi-agent ABS
Bennett, 2000	Insurgency	1) Does not provide a predictive or probabilistic output 2) Only explains insurgency dynamics 3) Not a multi-agent ABS
Cioffi-Revilla, 2009	SimPol	1) The lack of models which combine both theory and real case studies are lacking 2) Only explains in theory the operation of a polity does not explain a real polity
Cioffi-Revilla and Rouleau, 2009	AfriLand	1) Does not provide a predictive or probabilistic output 2) Only explains socio-cultural dynamics across territorial boundaries
Cioffi-Revilla and Rouleau, 2010	RebeLand	1) Does not use Poisson distributions to replicate political events 2) Does not use Weibull distributions to measure frequency of political events 3) Results do not provide valuable policy recommendations
Cusack, 1994	EARTH	1) Does not provide a predictive or probabilistic output 2) Only explains state-actor collective security as it relates to IR theory realism
Cederman, 2010 Cederman & Girardin, 2007	GeoSim	1) Does not provide a predictive or probabilistic output 2) Only explains state-actor collective security as it relates to IR theory realism

2.7.3 Summary and Review.

Edward MacKerrow (2003) developed the Threat Anticipation Program (TAP) to answer one central question: how does social discontent diffuse across Islamic terrorist networks? The TAP model contains a diversity of agents, which it divides into two groups: those drawn to terrorism and those recruiting terrorists. Both groups behave according to their social environment or network, and the model assumes that there is a greater probability of interaction between agents in networks with similar ideologies, rather than at random (MacKerrow, 2003). These networks are a conglomeration of agents associated by a given relationship. Therefore, TAP simulates social networks and their impact on individual agent interactions over time.

Mackerrow's (2003) methodology was to combine IR theories of liberalism and constructivism (Nye, 2009) into a framework of algorithms, which produced a range of terrorism models and scenarios susceptible to policy, social media, and economic variations when operationalized into ABS. Although the results are not actually predictive, the policy-maker can use the model's quantitative analysis and statistical output for the purposes of predictions and decision-making. ForPol integrates the three IR worldviews: realism, liberalism, and constructivism (Kegley Jr., 2009) into one framework just as MacKerrow's methodology. However, Mackerrow's methodology is different from ForPol, because it proposes that the application of policy choice variables produces probabilistic outcomes to political events.

TAP provides the user with two main advantages for the study of terrorist networks. First, the agents can develop negative sentiments towards oppressive actors,

or learn with which other agents they should or should not associate. Second, TAP can quantitatively explain the political question of how state-actors in a political system develop collective action. This is an advantage of the ForPol proposed methodology because it can provide (Barabasi, 2013).

However, TAP has one significant disadvantage: it is not intended to provide predictive or probabilistic outputs. It only simulates agent-network interactions in a multi-scenario environment, which can help policy-makers understand the diffusion of social grievances across networks to predict the emergence of regional terrorism (MacKerrow, 2003). ForPol can adapt this aspect of the TAP methodology by modeling the state-actors as a network whose interactions are the policy choices and outcomes regarding political events in an international system (Barabasi, 2013).

Doran's (2005) Iruba model is like MacKerrow's TAP model, however it models and operationalizes guerrilla warfare from a bottom up approach; it aims to understand the success or failure of a guerrilla movement based on population and band size. Doran (2005) uses historical case studies as the building blocks for a generic but realistic model of guerrilla warfare, coupled with ABS, to provide insight for the policy-maker into the dynamics of guerrilla warfare. Consequently, the agents in the Iruba model operate within a network of independent regions which vary in population size and terrain (Doran, 2005).

The Iruba ABM provides one significant advantage to the user; it can operationalize empirical data. For example, Doran (2005) uses a guerrilla database with data from between the years of 1917–1959, which includes conflicts that occurred in Ireland, Cuba, and Turkey, to produce a realistic guerrilla ABM. This aspect of the Iruba

model can be an advantage to the ForPol proposed methodology of operationalizing historical case studies.

The model's main disadvantage is its limited ability to model complexity. For example, the model excludes significant realities relevant to guerrilla warfare, such as the use of an assortment of attack types (e.g., terrorist or assassination), differences in attack outcomes (e.g., death or injury), population displacements, foreign interventions, and political affiliations. Another limitation is that it cannot account for the more abstract realities of guerrilla warfare, such as the effects of leadership (Doran, 2005). ForPol uses the SimPol state-actor model as an extension to account for the complexity and abstraction of political events in an international system.

Rousseau and Van der Veen's (2005) SharedID model is a process analysis model that bridges three levels of analysis: individual, domestic, and international. SharedID attempts to answer: how does self-perception diffuse across societies? This considers how individuals construct their ideas of self and society by interacting with their society, diffusing ideas domestically and internationally among collective groups separated by borders (Rousseau & Van der Veen, 2005). Rousseau and Van der Veen integrate the IR theories of constructivism and liberalism to frame agent behavior and to operationalize it with ABS. The model's results demonstrate four facts: first, that shared identity is an outcome of relationships between one's self-perception and that of others; second, that shared identity is highly susceptible to unstable, rather than stable, environments; third, that political leaders diminish shared identity within the governed society, and fourth, that interactions between complexity, stability, and leadership produce diverged societies (Rousseau & Van der Veen, 2005).

Cioffi-Revilla's (2009) SimPol models a polity (state-actor with political system) at different levels of complexity, from simple to real forms of a political system, for use in creating a real model for understanding a state-actor's form of government, and how understand nation-states operate in the real world. The main purpose of this model is to quantitatively explain how a political system operates, and how state-actors are formed and governed, using object-oriented modeling (OML) and the Unified Modeling Language (UML). This model derives the abstract conditions of a political system, quantitatively models it, and operationalizes it into a simulation in both its simple and complex forms (Cioffi-Revilla, 2009).

Furthermore, SimPol affords the policy analyst several advantages. SimPol, for example, allows the user to establish the entities, attributes, and interactions within a system initially, but to later also add variables, algorithms, and equations. It provides a computational language that can represent complex social and political systems and that can also handle multiple agents and system states. Additionally, SimPol provides a "high resolution model" (Cioffi-Revilla, 2009, p. 14) capable of modeling the complexity of real state-actors and policy with more realism, providing greater theoretical understanding for political events. Furthermore, SimPol illuminates the kinetic properties that real conditions of a political event may shadow. It provides an alternative to theoretical models for understanding political systems, because it can model real state-actors and explain why the state-actor and its policies endure over time.

SimPol provides the proposed framework for use with the elements of a complex adaptive system: 1) researchers can model state-actor and international system emergent behavior, 2) they can decentralize state-actor local interaction, rather than

centrally control it, 3) they can model a significant number of state-actors (multi-state model) 4) and they can study how state-actors adapt their behavior over time and how this affects system adaptation and performance (Cederman, 1997). SimPol is a flexible tool for computationally quantifying an international system and its components in its most complex form.

SimPol does have some disadvantages. It will not work, for example, for political scientists unfamiliar with OML and UML. Additionally, it is a model for the study of domestic policy and not foreign policy, and the model cannot account for the state-actor attribute of governance as it relates to a political issue. Further, the model in its simple form cannot explain the state-actor performance of stable states, which endure through periods of instability under real conditions. However, SimPol can progress a model from its simple to complex form, and this led Cioffi-Revilla and Rousseau to develop RebeLand, which models a simple political system and the interaction of rebel and government entities, and which can help to predict civil unrest and resultant state failure. This simulation can quantitatively explain how agents develop networks.

David Rousseau's MASON RebeLand ABM models simple and abstract state-actors' behavior, and was designed to highlight the essential and recognizable features of socio-natural complexity required to generate bottom-up civil unrest that leads to state failure. It provides more advantages than the other three ABM simulations. For example, the model situates agents and actors in space and time; it provides government systems, which obey political science concepts; it enables agent and actor interaction from a bottom-up approach; it provides environmental and political

components; it resembles both a semi-democracy and autocracy; it allows state-actor stability or failure; and it provides the best early warning and prediction capability.

Bhavnani et al.'s (2008) REsCape ABS model explores the relationships between three variables—ethnic division, significance, and civil war—to understand how ethnicity and resources affect an ethnic group's disposition towards civil violence. Therefore, one of the advantages REsCape can provide a policy-maker is that the model allows for complex experimentation strategies for which empirical data cannot be easily attained. The model's framework provides the policy-maker with the flexibility to add empirical data and experiment with case studies (Bhavnani et al., 2008).

ABM simulations are more effective at the micro-political level because most ABM simulations build from an individual, to domestic, to international political level of analysis (Cioffi-Revilla, 1998); the SharedID (Rousseau, 2006) ABM, for instance, bridges the three. This means that individuals in a society will create their own ideas and interact with other actors, building domestic identities or beliefs, and later diffusing those ideas internationally. The SharedID model has more advantages than disadvantages, and the advantages outweigh the risks of not using the simulation.

The policy maker should apply ABM simulations to micro-political events only, because macro-political events and warfare have global impact, which occur over centuries and millennia, placing a higher computational demand and complexity on the ABM simulation (Cioffi-Revilla, 2000). The policy maker may want to address contemporary or future political events and conflicts that occur at the micro-political level because they are more prevalent in the international environment, they are less complex, and they occur regionally over shorter periods of time (Cioffi-Revilla, 2000).

Furthermore, the SimPol polity model, which Cioffi-Revilla designed to model simple to complex political systems at the micro-political level (Cioffi-Revilla, 1998), provides us with the flexibility to model any type of state actor with consistent attributes.

2.8 Case Study – 1967 Arab-Israeli Six-Day War

2.8.1 Sources

The sources to set an unbiased case of the 1967 Arab-Israeli Six-Day War (Randolph, 2009) will include select historical perspectives from each of the state-actors and non-governmental organizations (NGO) involved in the war.

For a nonpartisan contemporary perspective, Michael B. Oren's *Six Days of War: June 1967 and the Making of the Modern Middle East* (2002) demonstrates the causation of the Six-Day War, from context to onset, and how human interaction produced uncertain outcomes that changed the fortunes of a nation, region, and international community.

The work of Moshe Shemesh, *Arab Politics, Palestinian Nationalism and the Six Day War* (2008), and the work of Richard B. Parker, *Politics of Miscalculation in the Middles East* (1993), provide an EGY perspective. They present the EGY failed policy choices (miscalculations) that lead Israel to preemptively attack Egypt, and that lead Syria and Jordan to enter the war.

Moshe Shemesh's *Arab Politics, Palestinian Nationalism and the Six Day War* (2008) provides a SYR perspective. A JOR perspective can be found in Samir A.

Mutawi's *Jordan in the 1967 War* (1987), which provides insights into the Jordanian decision-making and FP process, as well as in Moshe Shemesh's *Arab Politics, Palestinian Nationalism and the Six Day War* (2008). Tom Segev's *1967: Israel, The War, and the Year That Transformed the Middle East* (2007) provides a contemporary analysis of the war from an ISR perspective.

For the perspective of the US, three sources are key. First is William B. Quant's *Peace Process, American Diplomacy and The Arab-Israeli Conflict Since 1967*, (2005), which provides an overview of the US's accounts, goals, and policy choices from an executive perspective. This source is particularly interesting, because it explains options the Johnson administration considered but never applied, given the perceived adverse outcomes. Second is material found in *Foreign Relations of the United States, 1964–1967, Volume 18: Arab-Israeli Crisis and War, 1967* (Schwar & Keefer, 2004). Third is material provided by the U.S. State Department and the Office of the Historian (Randolph, 2009), which provides an account of the facts from an executive and U.S. State Department perspective.

For a UK perspective, consider Robert McNamara's *Britain, Nasser and the Balance of Power in the Middle East, 1952–1967* (2003), which highlights the UK's diminishing influence in the Middle East as it lost its foothold in Egypt a decade prior to the Six-Day War, and how this affected Egypt's policy towards Western power and Israel. For a USSR perspective, the work of Richard B. Parker, *Politics of Miscalculation in the Middles East* (1993), provides a detailed account of the USSR's policy choices, which lead Israel to preemptively attack EGY, and to JOR entering the war.

Sylvia K. Crosbie's *A tacit alliance, France and Israel from Suez to the Six Day War* (1974), provides FRN perspective, and sheds light into the Middle East's super-power relationships—specifically, the tacit Franco-Israeli alliance, and the internationally recognized Franco-Egyptian, decade-long alliance—preceding the Six-Day War in the form of diplomatic and military support. Crosbie also contextualizes, superpower relations in the Middle East as the dividing factor for an enduring, unresolved conflict, with Cold and Vietnam War ties, which threw the Middle East into conflict and drew world superpowers into the fray.

For a UN perspective, the work of U Thant, *View from the UN* (1978), provides a personal account from the UN Secretary General of the events which led the Six-Day War, specifically focused on Egypt's request to remove the UNEF from its borders, and its deployment of forces to the demarcation line.

From an Al-Fatah perspective, the work of Moshe Shemesh, *Arab Politics, Palestinian Nationalism and the Six Day War* (2008) outlines the role of the terrorist organization in contributing towards the Six-Day War, and outlines the terrorist organization's regional goals.

2.9 Theoretical Modeling

2.9.1 The Inherent Nature of Uncertainty in Politics.

Foreign policy makers must apply policy choices in light of the uncertain and complex nature of the international system, especially now that actors (state or non-state) in the international system have become more interconnected and interdependent (Cioffi-Revilla & O'Brien, 2007) through the power of technology (transportation, communications and internet) and information (social media), which have literally rendered state-actor geographical borders ineffective in controlling the entry and exit of individuals and information into their territory (Freedman, 2006). Consequently, this phenomenon adds greater complexity and unpredictability to the international system (Cioffi Revilla & O'Brien, 2007). Politics are uncertain because they affect social behavior and state governance in unpredictable ways (Cioffi-Revilla, 1998).

However, since the invention of computers in the 1960s, policy makers have used computational methods of analysis to build on mathematical and statistical methods of analysis (Cioffi-Revilla & O'Brien, 2007), testing and apply policy choices to international conflict and managing the complexity and unpredictability of the contemporary international system. The use of stochastic methods of analysis to predict state actor behavior within the uncertain conditions of the international and political environment has significantly added to the understanding of politics (Cioffi-Revilla, 1998).

Consequently, uncertainty is also inherent in conflict, and specifically in warfare. Therefore, the policy maker must also consider its implications from both micro and macro-political levels of analysis (Cioffi-Revilla, 1998). As Cioffi-Revilla (1998) demonstrates, politics and uncertainty of war at the macro-political level considers the implications of war for state-actors in the international system, and for each actor's origins (centuries or millennia ago) until present. Conversely, war at the micro-political level considers the implications of war for state-actors in a localized system, bearing in mind the history of one war to the next over a short timeline (Cioffi-Revilla, 1998).

2.9.2 Complexity of the Political Environment.

The international political system can be considered a Complex Adaptive System (CAS) because it is non-linear in nature, consisting of a network of finite agents locally interacting with each other in a disorderly fashion, without a central authority to govern their decisional-outcomes (Bak, 1996). Consequently, this uncertain but complex agent interaction gives rise to new adaptive behavior that alters the original system state. This complex state-actor interaction creates infinite possibilities that may affect the international system in a dynamic way by permitting the system to self-organize, and by permitting its agents to advantageously adapt to the environment (Bak, 1996; Cederman, 1997; Richards, 2000; Waldrop, 1992).

However, despite the uncertainty of the international political environment, complexity does not equate to chaos. This CAS can operate in orderly fashion to an

end, while retaining many variables that result in a myriad of uncertain behaviors and outcomes (Morgan & Henrion, 1990). Considering the international political system as a CAS opens this study of the system to many possibilities, including computationally-performed controlled experiments and modeling of collective behavior (Cederman, 1997).

Finally, four things about modeling can be concluded from viewing an international political system as a CAS: 1) we can study state-actor and international system emergent behavior, 2) we can decentralize state-actor local interaction, rather than centrally control it, 3) we can model a significant number of state-actors, and 4) we can study how state-actors adapt their behavior over time and how this affects system adaptation and performance (Cederman, 1997).

2.10 “Polity” (State-Actor Modeling)

The first step is to use SysML to conceptually model the entities and attributes of the system using a block and sequence model, to understand the component and variable interactions and how they would change the system state over time (discrete or continuous) (Law, 2015). Additionally, this project will use an existing model called SimPol, which Cioffi-Revilla designed to model simple to complex political systems at the micro-political level of analysis (Cioffi-Revilla, 1998; Cioffi-Revilla, 2009). However, for this simulation, the model will be modified and adapted to a high-resolution regional political system. The low-resolution model in figure 5 represents the system’s entities and some of their attributes. Regardless of the system, domestic or international, the

state-actor is composed of a society and a government, and the state-actor would not exist without a government. The society, however, *can* exist without the government.

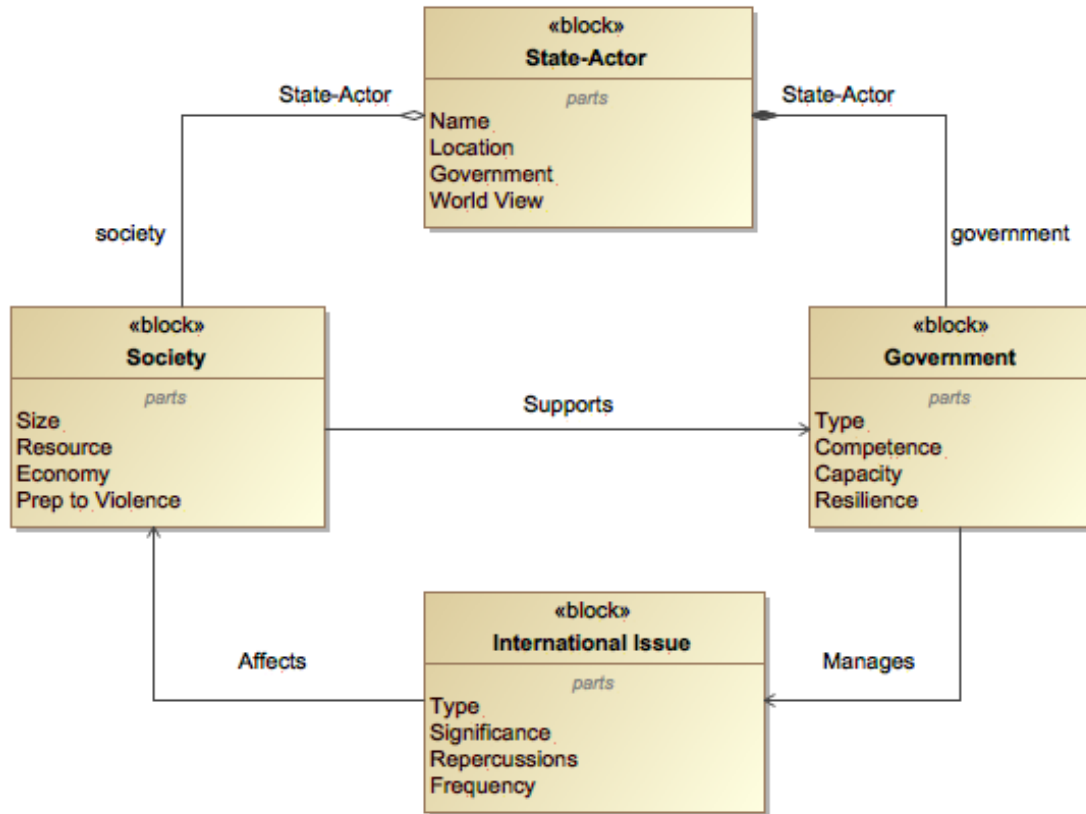

Figure 5 – Internal Block Diagram of State-Actor Model

Source: Model adapted from figure 1 in *Simplicity and Reality in Computational Modeling of Politics* (p. 33), by Cioffi-Revilla, 2009, New York, NY, Springer Link. Copyright (2008) by Springer Science & Business Media, LLC.

Retrospectively, the state-actor can exist in an international system, but the international system cannot exist without the state actor. Therefore, ForPol proposed AB model assumes an international system that is anarchic in nature, without a central authority to govern agent interaction regardless of their IR worldview. The agents behave according to their governmental constitution and the three IR worldviews:

realism, liberalism, and constructivism (Baylis et al., 2008; Kegley Jr., 2009; Nye, 2009). ForPol model's initial state is of stability, but it changes to instability when an international issue creates stress within an agent's society; it does not return to a stable state until the agent's government applies a policy issue that relieves social stress (Cioffi-Revilla, 2009). Furthermore, ForPol AB model will be like Cioffi-Revilla and Rouleau's AfriLand and RebeLand polity models (2009, 2010), which were single- and multi-polity models that incorporated regional systems with territorial borders.

ForPol international system includes two types of agents in this AB model: state-actors and non-state actors (table 8) that behave according to the same SimPol model and interactions included in the RebLand (Cioffi-Revilla & Rouleau, 2010) and AfriLand (Cioffi-Revilla & Rouleau, 2009) models. State-actors have sovereignty and territorial borders, and consist of four components: a state, a government, a society, and an international issue that affects the population and government. Each component consists of several attributes tabulated below, which may vary depending on the system modeled. The state-actor is sufficiently capable of resolving any international issue within its state capacity (diplomatic, informational, military, or economic) and the limits of its constitutional governance.

Table 8 – State-Actor and Non-State Actor Attributes.

Component	Attributes	Component	Attributes
State	· name	Governance	· name · maximum-capability
Society	· social-stress	International Issue	· government-action · weighted-action • type: D, I, M, E • salience
Trans-Actor	· name · salience	NGO	· name: String · salience

There are two types of non-state-actor agents: transnational actors (Trans-Actor), such as Al-Fatah and the PLO; and non-governmental organizations (NGO) such as the UN and NATO. These agents may lack some state-actor attributes, such as governance and military force, but they may also have greater capabilities than state-actors to influence change in the system. These actors may or may not be governed by a state-actor agent, but may act within or outside the territorial borders of state-actors regardless of their origin (Nye, 2009).

ForPol AB model assumes that all agents in this system interact continuously, cohesively, independently, or in opposition to one another, with no higher government or central entity above them to control or rule the political actions or decisions agents may take against each other, or in coalition, to change the state of other agents or the system (Nye, 2009). Figure 6, below, visually describes the sequence of interaction for the agent based model.

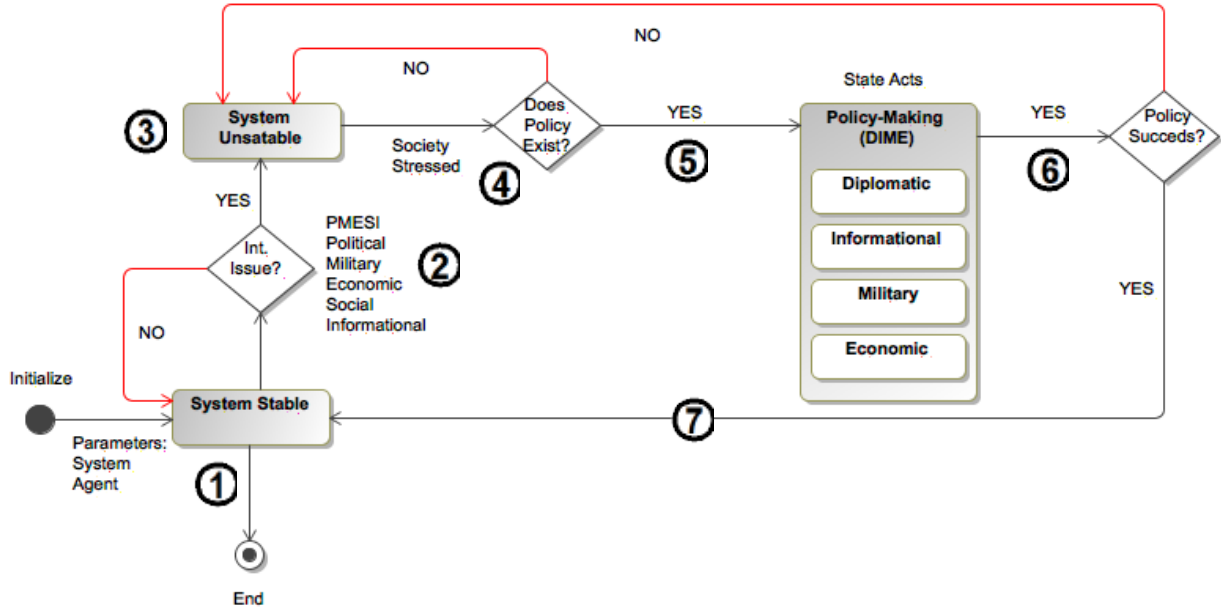

Figure 6 – System State and Interaction Diagram

Source: Sequence adapted and figure reconstructed from *Simplicity and Reality in Computational Modeling of Politics* (p.34), by Cioffi-Revilla, 2009, New York, NY, Springer Link. Copyright (2008) by Springer Science & Business Media, LLC.

(1) The system is assumed to be in an initial state of stability. (2) A political event (issue) occurs in the form of a political, military, economic, social, or informational (PMESI) outcome (Department of Defense, 2013; Hillson, 2009). (3) The system changes to a degree of instability. (4) This results in a degree of social stress, caused by the salience of the political event and the nonexistence of a government policy to solve the issue. (5) In turn, the society demands that the government act. (6) The government applies its capabilities and makes policy decisions by applying instruments of national power: diplomatic, informational, military, and economic (DIME) in response to the issue (Department of Defense, 2013; Hillson, 2009; Nye, 2009). (7) This triggers outcomes that are political, military, economic, social, informational, and infrastructure-

based (PMESII) (Department of Defense, 2013; Hillson, 2009), which may return the state-actor's society and international system back to a state of stability.

Although the above sequence of interactions may seem complex, and quantifying the variables grouped in the factors described in Table 9 even more challenging, it is not impossible. Chin-Lung Chang's equation of national power, found in his *A Measure of National Power*, can be used to simplify such abstraction and better quantify these attributes for measurement purposes. He also discusses the instruments of national power (capability) available to a state-actor for application to a given political event. Table 9, below, outlines the variables' names, their definitions, their parameters, their values, and their probabilistic equations. This will serve as input for the SimPol agent-based model.

Table 9 – Instruments of National Power (Policy Choices – Dependent Variables)

Dependent Variable (FP Choice)	Definition (Brecher, 1969; Hermann et al., 1977)
Diplomatic	State-Actor(s) diplomatic capability resources available (treaties, trade agreements, embassies and consulates) to support, or not support, his, or other state-actor political choices. More capability increases the probability to affect a political event or system stability; less capability decreases the probability to affect a political event or system stability
Informational	State-Actor(s) total informational resource capability for external behavior to communicate data about the political environment by mass media (press, radio, television, propaganda) or face-to-face contact (govt. envoy or diplomat). More capability increases the probability to affect a political event or system stability; Less capability decreases the probability to affect a political event or system stability
Military	State-actor(s) agent capability (Manpower, Weaponry, technology & defense spending) to use, threaten, control or deter violence (war) in the name of the state-actor towards other state-actors(s)/agents. More capability increases the probability to affect a political event or system stability; less capability decreases the probability to affect a political event or system stability
Economic	State-Actor(s) total human and material capability (fiscal, economic, financial capital, industrial and agricultural resources) available for external behavior. More capability increases the probability to affect a political event or system stability; less capability decreases the probability to affect a political event or system stability

The instruments of national power in Table 9 are considered policy categories for the purposes of this project, in which each group a list of variables. Edward E. Azar categorizes these in a similar fashion, by empirical observation, in his study titled *Conflict and Peace Data Bank (COPDAB), 1948–1978* (1984), which includes political issues (events or decisional acts) by actor-target from the 1967 Arab-Israeli Six Day War (Randolph, 2009). Azar uses nine relational categories to group the variables, and four of these categories align with the instruments of national power listed in the Department of Defense’s *Joint Operational Planning Publication, JP 5-0* (2011). Azar (1984) notes that the COPDAB categories are not arbitrary, and encourages the data user to rearrange the categories as required. Figure 7, below, depicts the

rearrangement of the four categories that best fit the DIME model. COPDAB relational categories one and seven align with the diplomatic instrument, relational category two aligns with the economic instrument, relational category 3 aligns with the military instrument, and some variables of each of the categories align with the informational instrument.

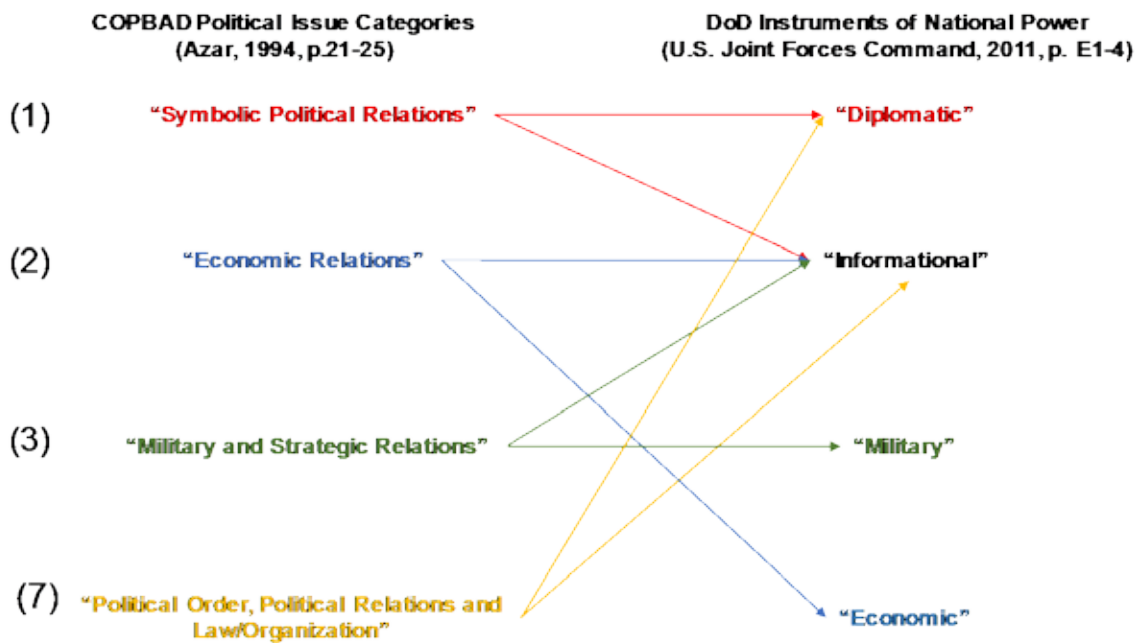

Figure 7 – Comparison of Political Issues and Policy Instrument Categories

2.11 System Dynamics Macro-Level of Analysis – Aggregate Behavior

This section briefly presents the axioms of Cioffi-Revilla's theory of uncertainty, which operate at two levels of analysis: the macro- and micro-political (1998). The first axiom states that at the macro-political level of analysis, uncertainty derives from the interaction of variables, and this explains aggregate political behavior. At the micro-political level of analysis, uncertainty derives from political events, which cause the event to define the key terms a policy analyst will require to model political behavior and events

To begin the modeling process of a political system, the researcher must first define the meaning of politics. For the purposes of this project, politics is the "macro-behavior of aggregate political variables and the micro-occurrence of related events" (Cioffi-Revilla, 1998, p. 26, 30). This definition implies two levels of political analysis: the macro-political and the micro-political (along with their respective terms).

At the macro-political level of analysis, political behavior is defined by variables. One can define political behavior in terms of dependent and independent variables, a critical act for the formation of an enduring and valid model, and specifically for the understanding of probabilistic causality inherent in political behavior (Cioffi-Revilla, 1998). In politics, the dependant variable is the aggregate political behavior (i.e., the policy mode or choices), and the independent variable is the cause (i.e., a crisis or war) or a state of nature (i.e., regional stability or instability) (Cioffi-Revilla).

At the micro-political level of analysis, a political event is defined as "a state of the world, which includes a combination of occurrences, or a set of more elemental real-

world events (sample points) from the sample space of decisional outcomes or states of nature” (Cioffi-Revilla, 1998, p. 142). Therefore, a political event is defined by a cause, or the combination of observable occurrences which triggered the event. Consequently, political occurrences are only possible if this set of more elemental real-world events are causally linked by some functioning procedures in a sequential, conditional, or combined fashion, which explains the causality of a political event.

But what is the relationship and difference between these two levels of analysis for the purposes of modeling political behavior? At the macro-level of analysis, variables take the form of values in a set, such as decisional outcomes or states of nature; at the micro-level of analysis, causality is explained by the occurrence of political events from all possible states of nature of a sample space (Cioffi-Revilla, 1998). At the macro-level, variables only explain political behavior, and at the micro-level, political occurrences only explain causality of political events.

Understanding both levels of analysis is critical for the modeling of any political system. However, the scope of this thesis will be the macro-political level of analysis and the proposed method to do this is SD modeling. Therefore, this thesis uses John D. Sterman’s Feedback Loop, explained in his work *Dynamics: Systems Thinking and Modeling for a Complex World* (2000, p. 19) for the dynamic modeling of aggregate political behavior. He proposes that real-world feedback can trigger mental model changes in those tasked to develop policy to resolve problems. However, this type of shift requires an understanding or reshaping of the current situation, which in turn feeds back renewed understanding, resulting in more informed decision-making and rules. The figure below depicts this dynamic system concept.

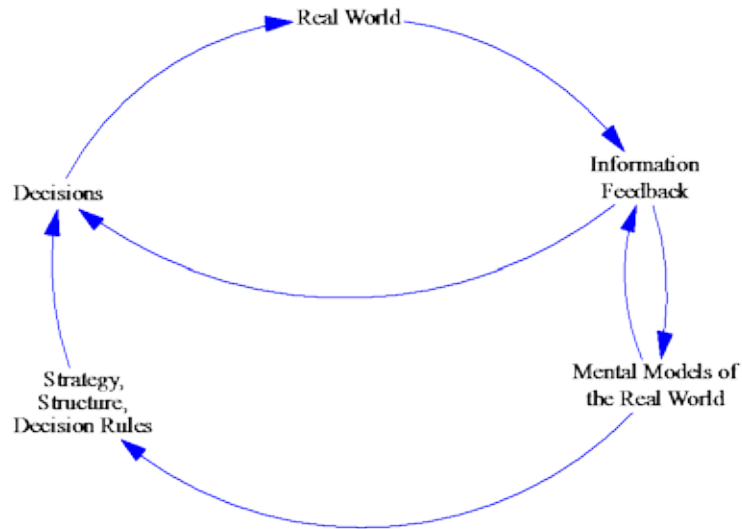

Figure 8 – System Dynamics Causal Structure

Source: Adapted and reconstructed from figure 1-11 in *Business Dynamics: Systems Thinking and Modeling of a Complex World* (p.19), by Sterman, 2000, Massachusetts, Jeffrey J. Shelstad, Inc. Copyright (1998) by the MacGraw-Hill Companies, Inc. Copyright.

Hence, the first step in modeling is understanding the basic structure of SD: stocks, flows and their dynamic feedback. Figure 9 sketches the basic structure of SD, starting with stocks, represented by a rectangles (container), which serve to accumulate an item or a system state that when prompted provides feedback for decision-making (Sterman, 2000). The first piped arrow represents an inflow (adding) to the stock and the second piped arrow (subtracting) and outflow from the stock. The valves located on the pipes regulate the flow that goes in and out of the stock. The clouds represent the sources and sinks or external stocks entering or exiting the model (Sterman, 2000).

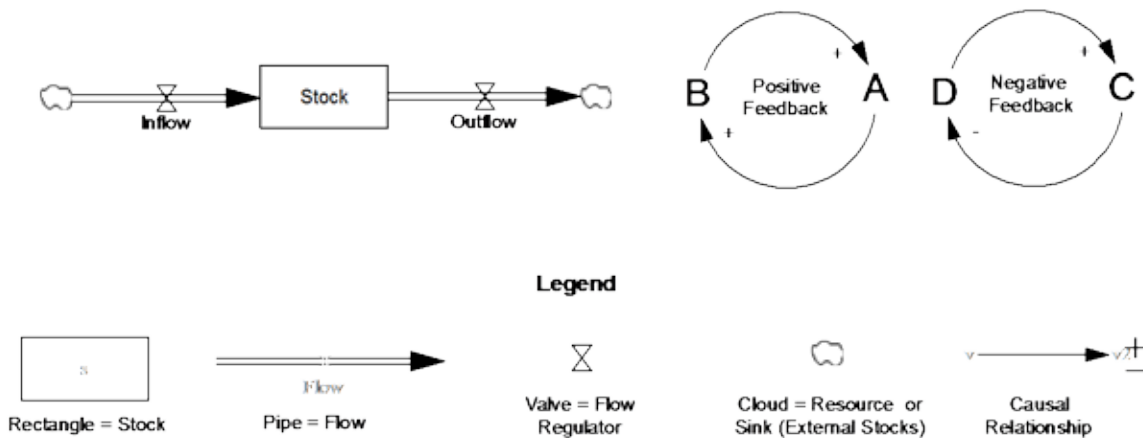

Figure 9 – SD Basic Structure

Source: Adapted and reconstructed from figure 6-1 in *Business Dynamics: Systems Thinking and Modeling of a Complex World* (p.193), by Sterman, 2000, Massachusetts, Jeffrey J. Shelstad, Inc. Copyright (1998) by the MacGraw-Hill Companies, Inc. Copyright.

This basic SD structure can be applied to a political system, since the main factor for political uncertainty hinges upon the dynamic relationships between aggregate political behavior at the macro-level of analysis and the micro occurrence of political events (Cioffi-Revilla, 1998). Therefore, ForPol was constructed using the VenSim software (Ventana Systems, Inc., 2015) to dynamically model the interactions between four stocks (dependent variables) depicted in the feedback loops in figure 10 by using the 1967 Arab-Israeli Six-Day War and the COPDAB empirical data set (Azar, 1984) to test the dynamic hypothesis. These four stocks are sensitive to the external behavior of state-actors and states of nature (Cioffi-Revilla). In this dynamic, when political event salience supersedes a state-actor's policy choice power and social stress levels, the system is unable to maintain maximum stability (Choucri et al., 2006).

Furthermore, ForPol adapts Alexander Lubyanskys, SD model of political violence in his dissertation, *A Feedback View of Theories of Contentious Politics* (2014) as the framework to understand the impact of state-actor policy choice interactions in the causality of the 1967 Arab-Israeli Six-Day War by dynamically modeling macro-political behavior in three causality loops and four stocks. ForPol borrows, the stability loop from the work of Choucri, et al., *Understanding & Modeling State Stability: Exploring System Dynamics* (2005). However, ForPol extends this concept to a regional system to understand causality in terms of system stability by the effects of political events and policy choices. ForPol also borrows, the Social stress and policy choice loop from the work of Cioffi-Revilla, *Simplicity and Reality in Computational Modeling* (2009). ForPol adapts Cioffi's polity model to dynamically study state-behavior.

Figure 10 represents a notional abstraction of ForPol relationships between, it's three causality loops and four stocks. First, the stability loop includes the system stability stock depicted by a red rectangle labeled "y" and the political event stock depicted by a blue rectangle labeled "x". Second, the social stress loop includes the political event stock and the social stress stock depicted by a green rectangle labeled "z". Third, the policy choice loop includes social stress and policy choice depicted by a gray rectangle labeled "r".

In ForPol, the negative feedback loops 1 (stability) and 2 (social stress) encourage a society to pursue government action and the positive feedback loop 3 (policy choice) initially allows the government to overcome the event salience and maintain system stability. For example, in the stability loop, a political event functions as a negative force causing system instability (blue arrow) and system stability affects the

political event in a positive way (red arrow). In the social stress loop, a political event also functions as a negative force causing social stress (blue arrow), which affects the political event in a positive way (green arrow). Finally, in the policy choice loop, social stress functions as positive force on policy choice (green arrow) by causing the government to apply a policy choice to the political event (gray arrow), and the policy choice returns a positive feedback (gray arrow) to relax society.

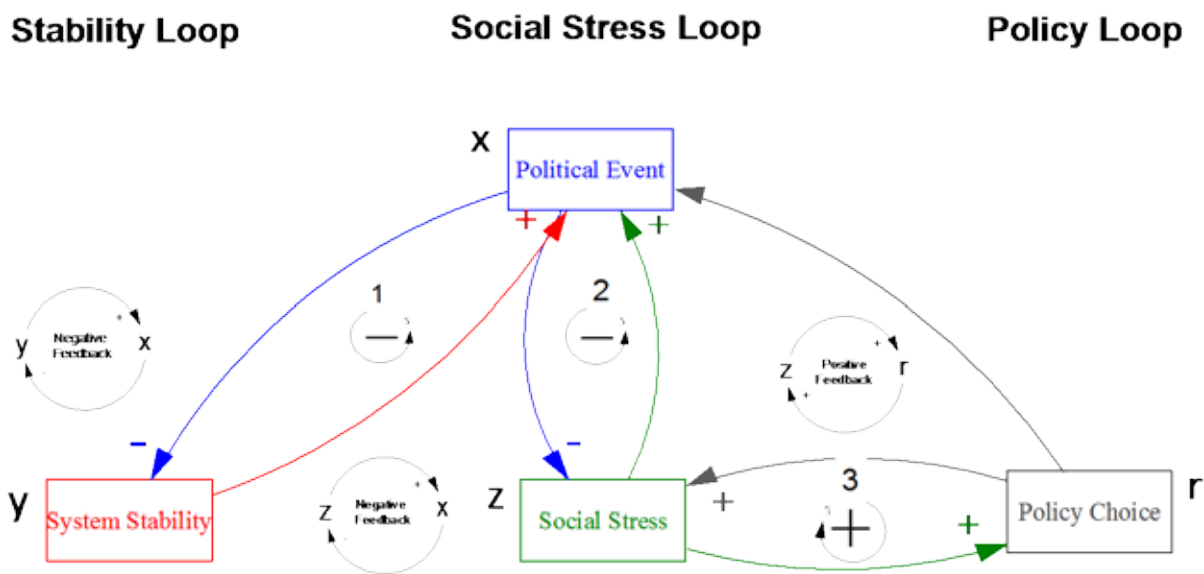

Figure 10 – ForPol SD Model of Aggregate Behavior

Source: Figure constructed using Vensim 7.0 Software by *Ventana Systems Inc.*, Copyright (2015) <http://vensim.com/vensim-software/>.

This notional abstraction can also be represented mathematically, by a set of differential equations as depicted in figure 11. The rectangles are both stocks and variables from a differential equation perspective, in which the arrows going to the boxes model how the differential equations would be updated, but also as a derivative of the variable. ForPol makes these equations a function of time.

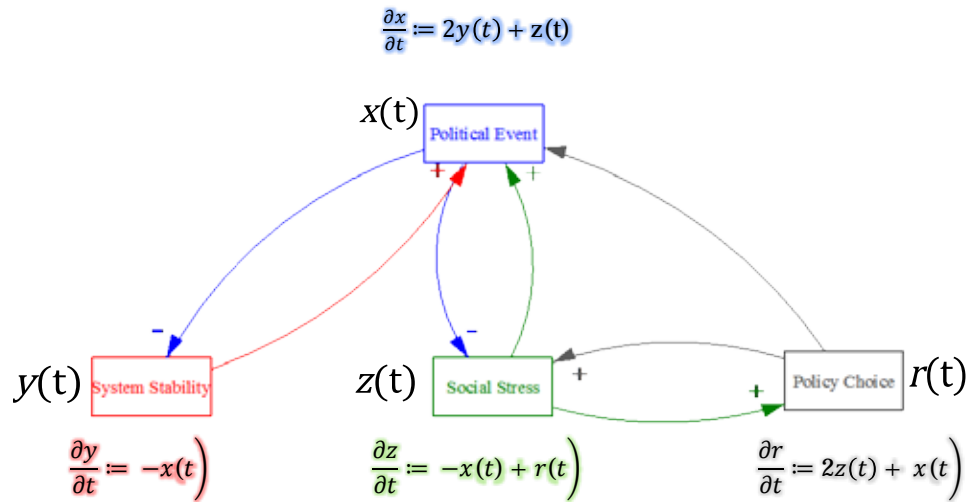

Figure 11 – ForPol SD Model Mathematical representation

The notional differential equations overlaid on ForPol in figure 11 are expressed as follows:

Political Event (t) =

$$\frac{\partial \text{Pol Event}}{\partial t} := 2 \text{ Sys Stability}(t) + \text{Soc Stress}(t) \quad (1)$$

System Stability (t) =

$$\frac{\partial \text{Sys Stability}}{\partial t} := -\text{Pol Event}(t) \quad (2)$$

Social Stress (t) =

$$\frac{\partial \text{Soc Stress}}{\partial t} := -\text{Pol Event}(t) + \text{Policy}(t) \quad (3)$$

Policy Choice (t) =

$$\frac{\partial \text{Pol Choice}}{\partial t} := 2 \text{ Soc Stress}(t) + \text{Pol Event}(t) \quad (4)$$

Subsequently, to understand how ForPol functions would work when operationalizing the 1967 Arab-Israeli Six-Day War a notional scenario is given as example using the COPDAB data set in table 10. It is important to note, that although this scenario walkthrough may seem discrete and sequential, the system behavior is dynamic in nature, some things happen simultaneously and time is discrete.

Table 10 – 1967 Arab-Israeli Six-Day War Policy Type Frequency

State-Actor/ Stock(s)	Mo	Day	Activity	Pol Type	Stock Parameter(s) Variations					Var
					Poli_E vent	Pol_Choice	Other_Govt_Policy_Choice	Sys_Stab	Soc_Stress	
RUS	5	13	REPORT ISR GROUND-AIR ATTACK ALONG SYR BORDER	I	0.43	0	0	0.8	0.81	1
RUS	5	14	AGGRESSIVE ACTIONS-COMMUNIQUE WITH TROOPS NEAR ISR BORDER	I	0	0.16	0	0.67	0.69	1
SYR	5	15	EFFORT UNO SG MAINTAIN PEACE IN MIE	M	0	0	0.28	0.73	0.75	1
US	5	15	UNEF TROOPS WITHDRAW	D	0.05	0	0	0.47	0.5	2
EGY	5	16	REQUEST UAR NOT TO WITHDRAW UNEF PATROL	M	0	0.28	0	0.73	0.75	1
US	5	17	ASSUME COMBAT READINESS AGAINST ISR BROWN UNEF	M	0	0	0.16	0.67	0.69	2
EGY	5	17	WITHDRAWAL FROM UAR	M	0.28	0	0	0.73	0.75	3
UK	5	18	MOBILIZATION FOR SUPPORT OF UAR	M	0	0.16	0	0.67	0.69	3
JOR	5	19	PARTIAL TROOP OPERATIONS JOR BORDER	M	0	0	0.1	0.4	0.44	3
ISR	5	20	STRAIT OF TIRAN	M	0.28	0	0	0.73	0.75	1
EGY	5	23	US UNK FRN USR CONF ON MIE CRISIS	M	0	0.43	0	0.8	0.81	4
FRN	5	24		D	0	0	0.05	0.47	0.5	4

D = Diplomatic I = Informational M = Military E = Economic

(1) As narrated in chapter 1 (table 10), on May 13, 1967 (blue outline), USSR shared a false intelligence report with EGY and SYR on ISR forces massing along the SYR border (Parker, 1993). Furthermore, per the COPDAB, this political event had a salience weight of 0.43 (blue outline), which cause a negative feedback in stability, more being worse and less being better. The differential equation is updated and the stock accumulates the value.

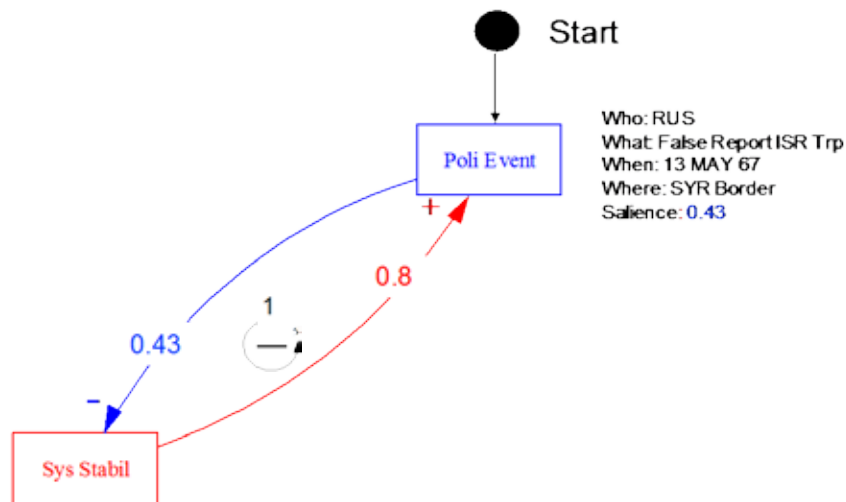

Figure 12 – ForPol SD Model System Stability Notional Negative Feedback Loop

(2) Dynamically, the political event salience also exerts a load on society state-actor societies, which are depicted on figure 12 and table 10 with blue arrows, then the stock updates stress value of 0.75 for each of the countries in the scenario (table 10 green arrows).

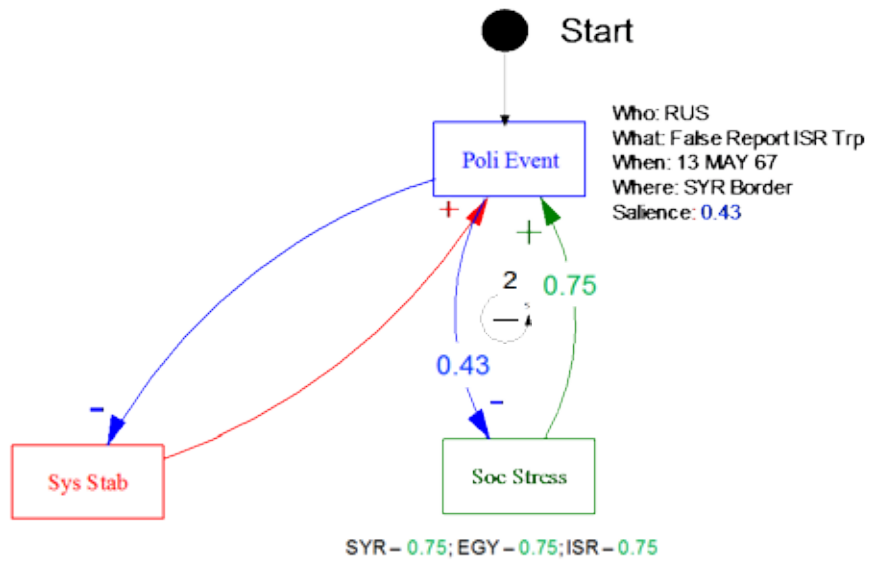

Figure 13 – ForPol SD Model Social Stress Notional Negative Feedback Loop

(3) The social stress feedback creates a positive load (figure 13), which prompts the involved state-actor societies to demand their governments to respond to the event (green arrow).

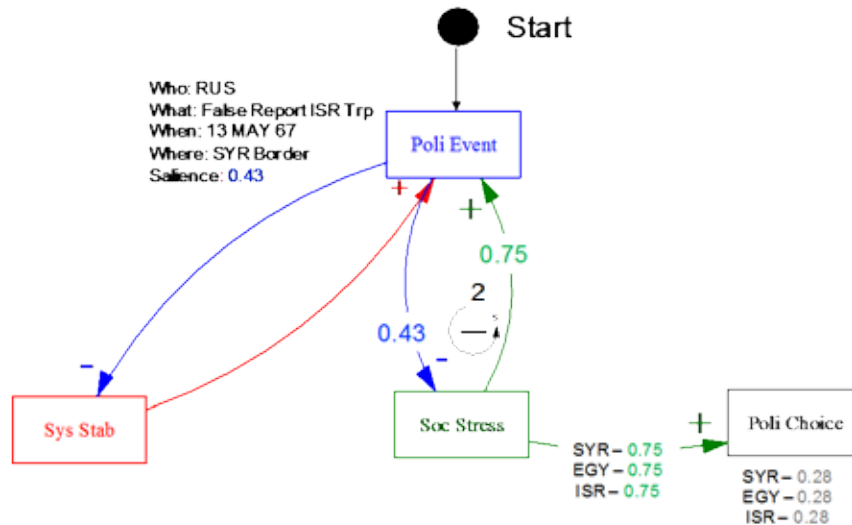

Figure 14 – ForPol SD Model Social Stress Notional Negative Feedback Loop (Continued)

(4) In turn, ISR, EGY and SYR develop policy choices (diplomatic, informational, military and economic) to respond to the initial event (figure 14). In this scenario, SYR deploys troops to the ISR border, EGY requests the UN to remove UNEF from armistice lines (table 10 red arrow), in turn ISR partially deploys troops to the JOR border (table 10 yellow arrow).

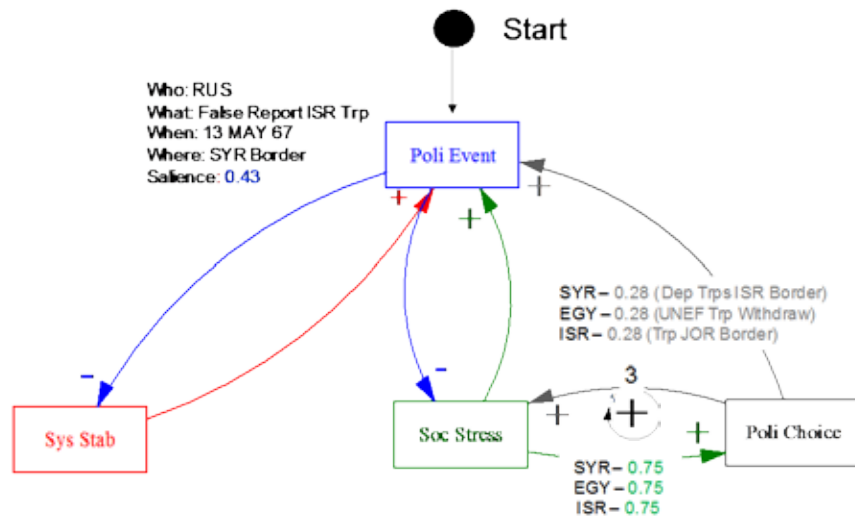

Figure 15 – ForPol SD Model Policy Choice Notional Positive Feedback Loop

(5) Figure 15 and 16 depict how the state-actor policy choices will have positive effects on political event salience returning a notional salience value of “x” (blue arrow) to both the system stability and social stress stocks, consequently updating stability with notional “y” value (red arrow) and society with a notional “z” value (green arrow). Once system stability is updated the run ends.

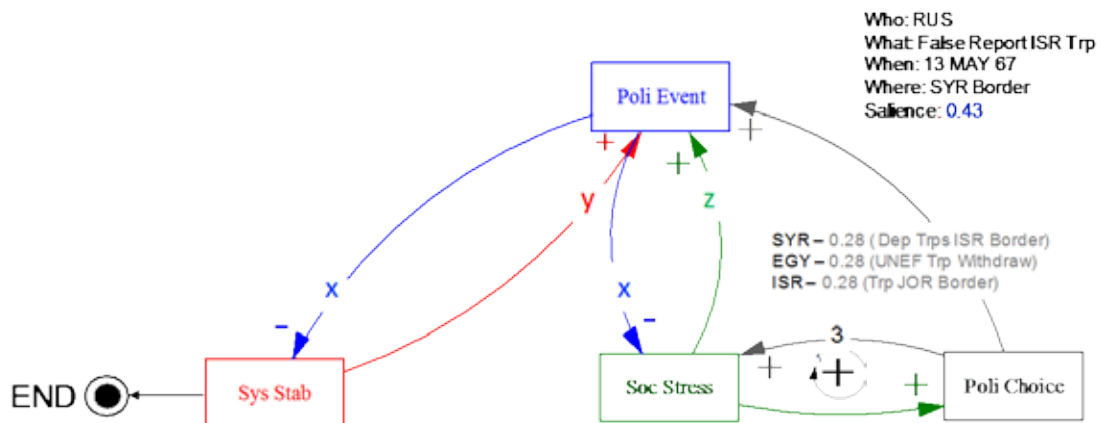

Figure 16 – ForPol SD Model Policy Choice Notional Positive Feedback Loop (Continued)

2.12 Calibrating the System Dynamic Model Input Parameters

This section will describe how the empirical data was collected, sorted, fitted to the model and whether the data corresponds to the SD reference mode. The empirical data collected to calibrate the ForPol model input parameters comes from the open source Inter-University Consortium for Political and Social Research (“ICPSR Find & Analyze Data,” 2017) data bank (<https://www.icpsr.umich.edu/icpsrweb/ICPSR/>), which is the largest existing source on social science data. This organization archives and distributes empirical research data and code sets for comparative and analytical purposes, which are discussed in the following sections. The data set selected was the 1948-1978 Conflict and Peace Data Bank (COPDAB) generated by Edward E. Azar, which is discussed in the next subsection.

2.12.1 Conflict and Peace Data Bank, 1948–1978

The purpose of this data set is to examine the dynamic event interactions from the 1967 Arab-Israeli Six-Day War's (Azar, 1984; Randolph, 2009) empirical COPDAB 1948–1978 data set. However, prior to describing this data we must make note of some limitations and changes made to the data set. Although the data set contains errors and limitations it is the most useful source of empirical data available to test against the SD model. Chapter 5 will discuss data limitations in more detail. As aforementioned, Azar notes that the COPDAB categories and scale are not arbitrary, and encourages the data user to rearrange the data as required (Azar, 1984). Following this guideline, the COPDAB international weight scale is altered to differentiate between event weight values in the data set that corresponds with the reference modes.

The COPDAB assigns scaled values according to a list of qualitative statements about the event interaction data, which allows the user to categorize these events by salience (Azar, 1984). If the researcher observes the scale values, they will find that as a political event or act surpasses the neutral point, it becomes a source of conflict and instability (Choucri et al., 2006), creating social stress. Alternatively, if the salience of a political event or act remains below the neutral point, the system is absent of social stress or instability. However, what the scale lacks is a measure by which to weigh the salience of political events or acts listed in the point scale. Therefore, the COPDAB assigns weighted values to the point scale, which international relation scholars determined based on the relationship between cooperation or conflict and the neutral

point at a value of 1 (Azar, 1984). Figure 11, below, graphically displays the COPDAB weighted by degree of cooperativeness or conflict from the neutral point.

The challenge with this scale is that all the weighted values are positive values above and below the neutral point. This array would not provide an appropriate response when tested against the reference modes. For example, there would be no way to know the difference between an event with a weight value of 6 in the conflict scale and an event with a weight value of 6 in the cooperative scale (table 11).

Table 11– COPDAB International Event Interaction Scale Points

	Scale Point	Weighted Value	Description
Conflict	15	102	Extreme War Acts w/death, dislocation or high strategic costs
	14	65	Limited War Acts
	13	50	Small Scale Military Acts
	12	44	Political-Military Hostility
	11	29	Diplomatic-Economic Hostility
	10	16	Strong verbal expressions of Hostility
	9	6	Mild Verbal Expressions of Discord
NP	8	1	Neutral, Non-significant acts
Cooperation	7	6	Minor Official Exchanges, Policy Expressions
	6	10	Official Verbal Support-Goals, Values, Regime
	5	14	Cultural-scientific Agreement or Support
	4	27	Economic, Tech & Industrial Agreements
	3	31	Military & Economic Support
	2	47	Alliances
	1	92	Nation Unification

Therefore, to overcome this challenge, the scale is altered to differentiate the weight values by dividing the scale point by the largest weighted number to give you an adjusted weight of all positive values without duplicating. Additionally, the neutral point

category was eliminated and for weighted value in the 7-point scale was changed from six to five.

The COPDAB contains more than 10,000 events for input into the SD model. The data was filtered to capture all events that occurred in the year 1967 and sorted to only select events related to the Six-Day War and state-actors involved in the conflict (Appendix C). In Appendix A, the Six-Day War event interaction data has been tabulated for nine Middle Eastern state-actors, one non-state actor, two NGOs, and five superpowers encroached in the war, resulting in 439 event interactions (Azar, 1984). Table 24 appendix A displays the actor-target interactions and table 25 in appendix A tabulates the policy choice interactions.

As mentioned above, the COPDAB scales and weighs events as cooperative and conflictive. Departing from this, table 12 displays the relative frequency of the total number of events by policy, demonstrates that approximately 44% of the event frequency is diplomatic, followed by military events with 43% of the distribution.

Table 12– 1967 Arab-Israeli Six-Day War Relative Frequency of Events - By Instrument Type

Policy	Number of Events	Relative Frequency of Events by Instrument
Diplomatic	191	43.51%
Informational	34	7.74%
Military	189	43.05%
Economic	25	5.69%
All types	439	100.00%

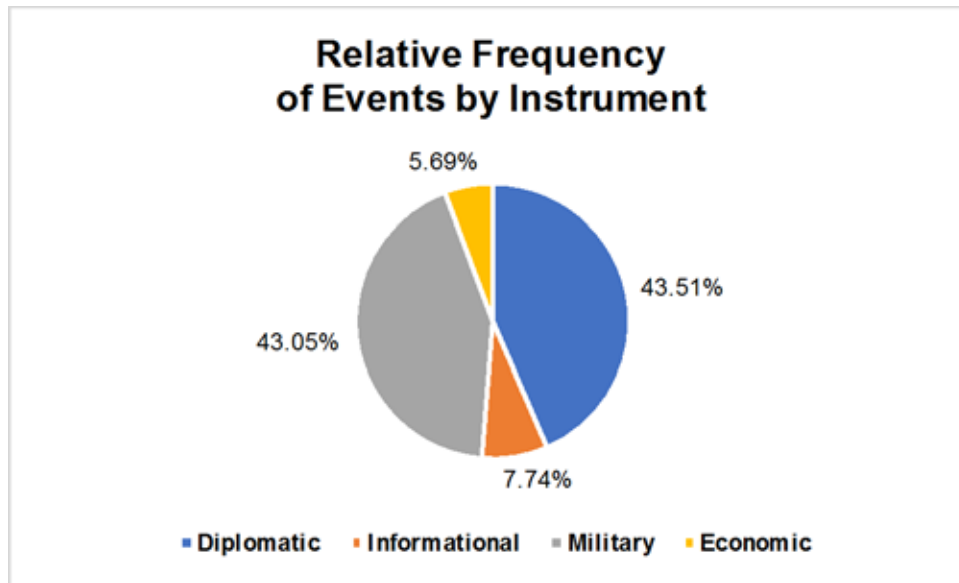

Figure 17 – 1967 Arab-Israeli Six-Day War Relative Frequency of Events – By Policy

Event-wise, this means that decisional acts or outcomes were predominantly military and diplomatic (figure 17). Nevertheless, this information alone does not speak to the effects of these interactions on social stress and system stability, or demonstrate which has a lesser or greater effect. However, when the event data is fitted to a polynomial distribution which accounts for the event weights assigned by the COPDAB international weighted scale (Azar, 1984) a different behavior is revealed (figure 19). The data demonstrates that regardless of the policy type most events are in the unstable category of the plot.

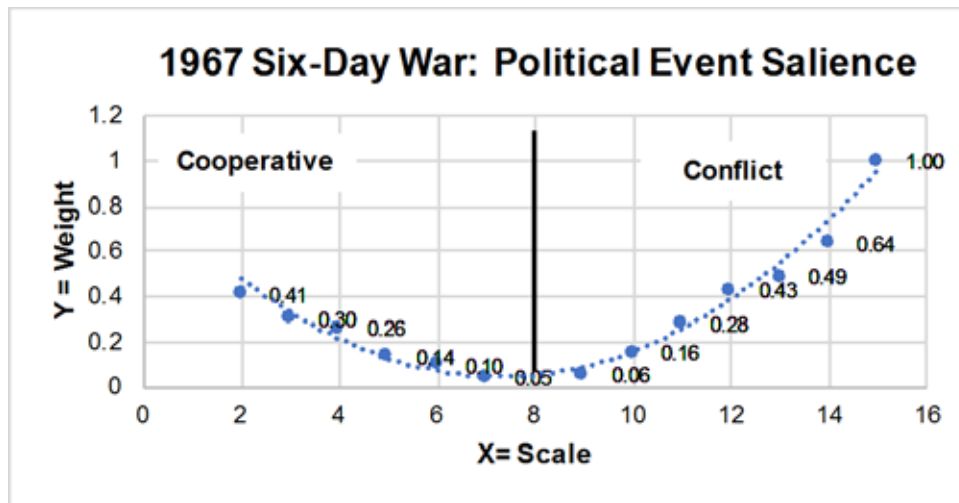

Figure 18 – 1967 Arab-Israeli Six-Day War Political Event Salience

Furthermore, table13 represents the frequency of weighted events. The table categorizes four factors, diplomatic, informational, military and economic policy events or acts (Brecher, Steinberg, & Stein, 1969; Department of Defense, 2013). The table provides empirical evidence of the possible causality of the Six-Day War based on the weighted policy events. Table 13 depicts that in the 1.0-point weight scale there are 25 military, followed by four informational policy events or acts. According to the COPDAB scale these type 3 events or acts of extreme war resulted in death, dislocation or strategic loss (Azar, 1984). Then, in the 0.64-point weight scale we find 5 military events or acts; per the COPDAB international scale, these type 3 events and acts of limited war had similar results. In the 0.49-point weight scale, there are 19 military type 3 events or small-scale acts of war and two diplomatic events. Table 13 also shows that, regardless of the diplomatic and economic efforts conducted by state-actors, the military and informational events, or acts of extreme and limited war, could have caused social stress and system instability. Finally, the empirical data provides some evidence that

shows that the preponderance of events were conflictive (destabilizing) for a total of 252.

Table 13 – 1967 Arab-Israeli Six-Day War Policy Type Frequency

Evt. Wgt.	D	I	M	E	Total
1.00	0	4	21	0	25
0.64	0	0	5	0	5
0.49	2	0	19	0	21
0.43	4	2	16	0	22
0.28	6	3	22	5	36
0.16	62	17	28	1	108
0.06	18	2	12	3	35
0.05	63	1	22	6	92
0.10	20	4	19	6	49
0.14	11	0	3	0	14
0.26	1	0	2	4	7
0.30	2	1	15	0	18
0.46	0	0	4	0	4
Total	189	34	188	25	436
Instab.	92	28	123	9	252
Stab	97	6	65	16	184

This weighted measurement is a suitable way to assess salience of political events or acts (Wlezien, 2005) in relation to system stability or instability (Choucri et al., 2006). Azar suggests that the best way to use the COPDAB event interaction data is to aggregate it over time or continuously (Azar, 1984), making the COPDAB data useful for the SD model. Conducting an analysis of the state-actor interaction frequency of these events and salience as a function of instability, on the international scale, this project can provide evidence that can inform a theory of the causality of a political event. The weighted scale will serve as input into the SD model. Finally, the table below lists the parameters for the SD model in terms of stocks and flows.

Another adaptation to the data set was calculating the stability and stress values. The method to produce the stability values was to take the political event salience scaled point values and divide each by the highest point value. The resulting values are depicted in table 14. The method to produce the social stress values was to arbitrarily assign scale point values one value higher than the political event salience scaled point values and divide each by 1.5. The resulting values are also depicted in table 14, figure 19 and 20.

Table 14– 1967 Arab-Israeli Six-Day War Policy Type Frequency

Salience		Stability		Stress	
ScI	Wgt	Scale	Weight	Scale	Weight
102	1.00	15	1.00	16	1.00
65	0.64	14	0.93	15	0.94
50	0.49	13	0.87	14	0.88
44	0.43	12	0.80	13	0.81
29	0.28	11	0.73	12	0.75
16	0.16	10	0.67	11	0.69
6	0.06	9	0.60	10	0.63
5	0.05	7	0.47	8	0.50
10	0.10	6	0.40	7	0.44
14	0.14	5	0.33	6	0.38
27	0.26	4	0.27	5	0.31
31	0.30	3	0.20	4	0.25
47	0.46	2	0.13	3	0.19
92	0.90	1	0.07	2	0.13

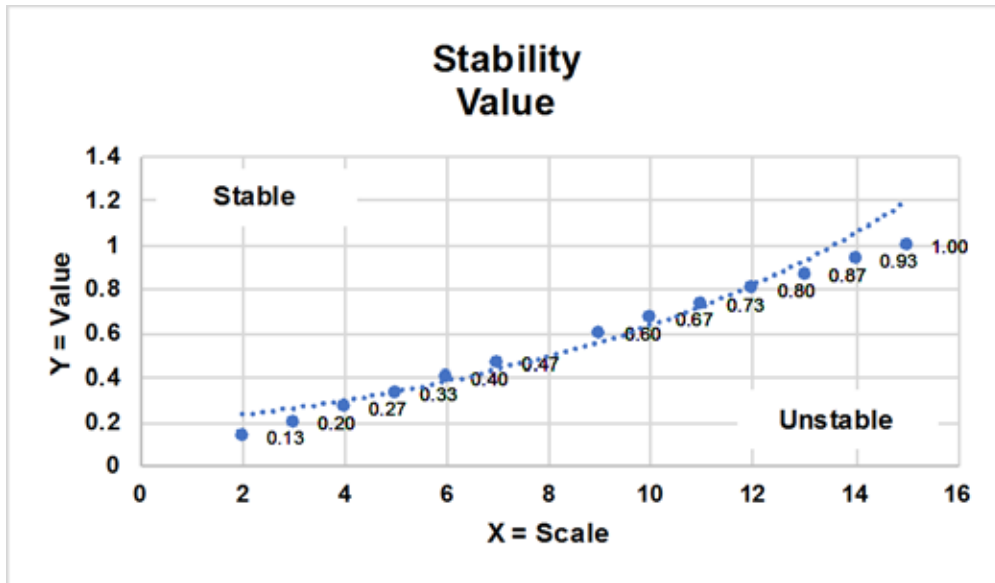

Figure 19 – 1967 Arab-Israeli Six-Day War System Stability Scatter Plot

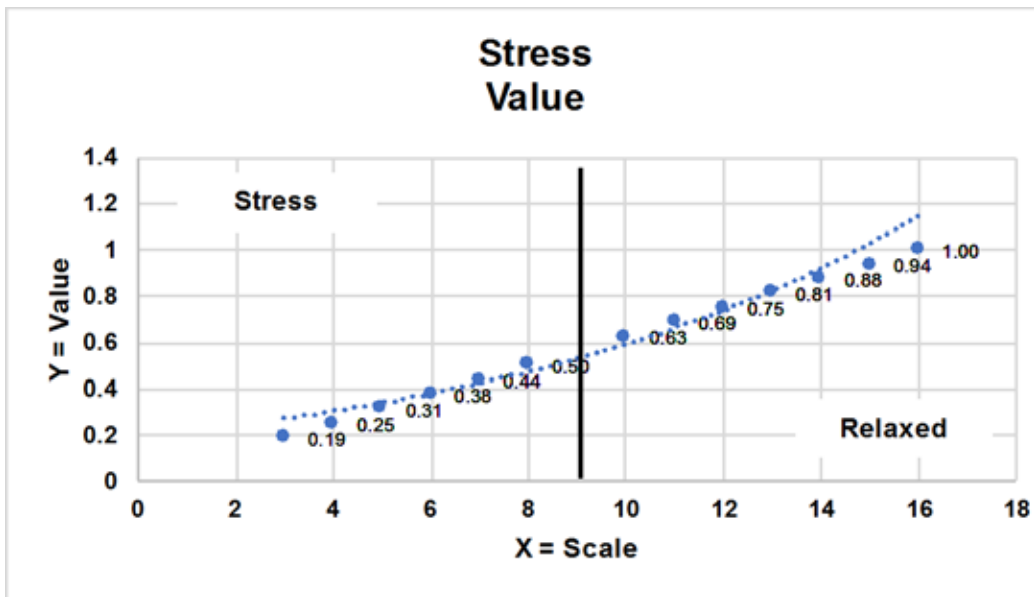

Figure 20 – 1967 Arab-Israeli Six-Day War Social Stress Scatter Plot

2.13 Gap Analysis

2.13.1 Knowledge Gaps

After an extensive literature review, four significant knowledge gaps can be identified, illustrated in Figure 21 below. First, DES are predominantly used in disciplines with quantifiable processes, concepts, information, and data, such as economics, business, engineering, manufacturing, and services (figure 21-1). These systems are used minimally or not at all to study problems in the social and political sciences.

Second, HS & SD are predominantly used to solve complex transdisciplinary problems (figure 21-2) across the spectrum scientific, social and political fields (Dubiel & Tismhoni, 2005; Lee & Berkeley, 1997; Lubyansky, 2011, 2014). The greatest advantage SD provides the user is its power to change a given mental model once the model returns its feedback (Sterman, 2000). The ability of SD to model feedback and analyze nonlinear systems in a stock and flow dynamic makes it a M&S paradigm suitable for the modeling of aggregate behavior (Lubyansky, 2011). SD's greatest disadvantage in any modeling endeavor, however, hinges on the fact it cannot represent a system's heterogeneous agents and their many attributes (Lubyansky, 2011). The best use of SD is at the macro-political level of analysis (Cioffi-Revilla, 1998), because this research attempts to model the dynamic variables in relation to agent aggregate behavior independent of agent heterogeneity.

Third, ABS is predominantly used in the social and political science disciplines (Figure 21-3) to understand complex systems from a bottom up perspective (Law, 2015)

and to address a diversity of agents with different decision-making mental models (Lubyansky, 2011). Many of the existing M&Ss, such as RebLand, AfriLand, and SimPol, are only interested in the testing of theories, such as the onset of rebellion, the influence of resources on social cultural dynamics, the modeling of state-actors, and the modeling of political violence.

Fourth, and most critical, these AB M&Ss are predominantly used for experimental purposes, and they are regional single-agent models, very few are multi-agent and most lack probabilistic or predictive capabilities, and cannot incorporate empirical case studies or test existing data (Lubyansky, 2011).

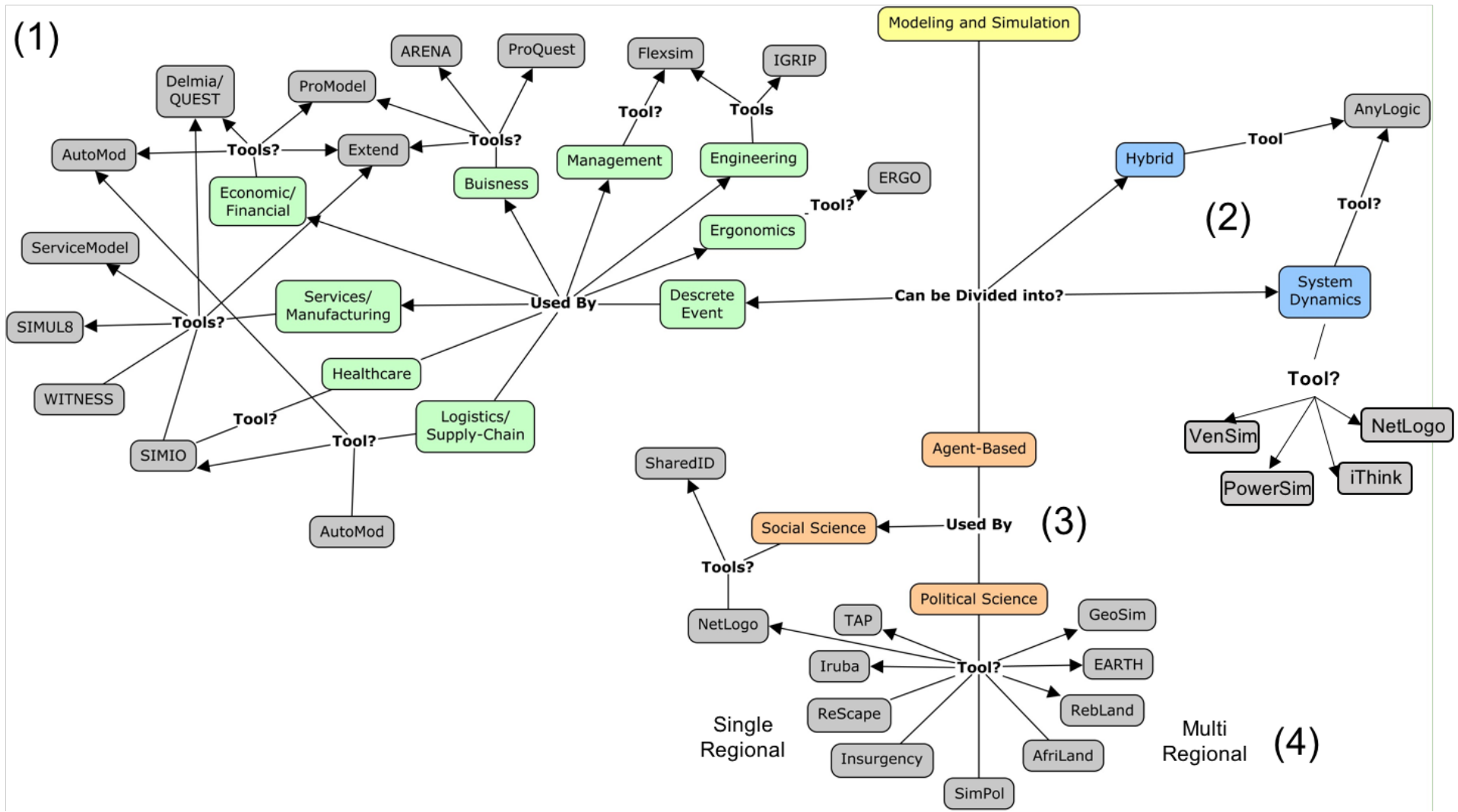

Figure 21 – Literature Review Gaps

Source: Constructed using CmapTool v6.02 Software by *CmapTools: A Knowledge Modeling and Sharing Environment* (p.125), by Canas et al., 2004, Spain, The First International Conference on Concept Mapping. Copyright (2014) by Institute for Human-Machine Cognition.

2.13.2 Approaching a M&S Hybrid Concept

Although, approaching this problem will require a comprehensive research agenda, to address these four critical knowledge gaps, this project approaches the problem of explaining the causality of the Arab-Israeli Six-Day War from a macro-level perspective using SD modeling, and from a micro-level perspective using AB modeling. As mentioned, a SD methodology will explain causality of aggregate political behavior (Cioffi-Revilla, 1998) by modeling the dynamic interaction of independent (random) variables at the macro-political level. Alternatively, an AB methodology will explain the behavior of heterogeneous state-actors, their decisional acts, and political event occurrence (Cioffi-Revilla, 1998). This hybrid methodology will also provide the flexibility to go beyond the current trends of explanatory modeling and provide a platform to operationalize theory, an empirical case study, and its available data. The VenSim SD software (Ventanan System, 2015) was selected because it was successfully used to model theory and incorporate data (Lubyansky, 2011). The SD model will integrate behaviors of the SimPol model of a state-actor (Claudio Cioffi-Revilla, 2009), which has been used in the past by social and political scientists to successfully model theoretical concepts, and state and regional systems (Bhavnani et al., 2008; Cioffi-Revilla & Rouleau, 2009; Cioffi-Revilla & Rouleau, 2010; Rousseau & Veen, 2005). However, this approach is not considered in this thesis. The SD component is the only aspect of this concept that was developed and subject to calibration for future verification and validation as part of this hybrid concept.

CHAPTER 3: METHODOLOGY

This section provides a detailed description of the Vensim SD model and a functionality example to demonstrate how the model works: from data input, dynamic interactions and resulting data output. The SD model also describes the method by which each SD reference mode (dependent variable) was generated. Furthermore, the experimental design section outlines the method by which four dynamic hypotheses are correlated with system stability and input parameters from the 1967 Arab-Israeli Six-Day War data are calibrated with the ForPol model. Additionally, the section describes the collection and sorting method used to generate the empirical data set and a description of the same for contextual purposes. However, experimental and testing results are described in chapter 4.

3.1 System Dynamic Parameters and Equations

This section defines and tabulates the SD model parameter variables. Furthermore, this project considers the SD parameters from the research of Lubyansky (2011, 2014), Choucri (2006, 2007) and Azar (1984).

3.1.1 Saliency of Political Event

ForPol assumes that saliency is the importance a state actor and its society attribute to a political event or decisional act, or the degree to which it becomes a problem (Wlezien, 2005), affecting the society's stress level and system stability. However, the focus is on the second component, the degree of saliency. Consequently, the adapted COPDAB international scale is used to measure the saliency of events or decisional acts, providing a weighted measure of the interactions between state-actors in terms of cooperativeness or degree of conflict. In the adapted version (table 13) values range between 1.0 and 0.46, with 0.46 being the most cooperative and 1.0 the most conflicted interaction among state-actors (Azar, 1984).

3.1.1.1 Political Event Parameters

Table 15 – Policy Choice Variable Parameter

Dependent Variable	Parameter(s)	Value/ Range	Reference
	Initial_Political_Event	0.90 to 1	
	Soc_Stress_From_Policy_Choice_Failure	0.13 to 1	
Political Event	Govt_Applies_Poilicy_Choice	0.90 to 1	(Azar, 1984; Lubyansky, 2014)
	Max_Saliency	1	
	Min_Saliency	0.90	
	Saliency_Decay_Time	5	

3.1.1.2 Political Event Equations

- $Saliency_Of_Political_Event =$
"Sys_Stability_Increase"*("Policy_Choice"³)*"Govt_Applies_Policy_Choice"
- Flow: $Saliency_Increase = \text{MIN} ("Sys_Stability_Decrease", "Saliency_Incr")$
- Stock: $Political_Event = \text{INTG} ("Saliency_Increase" - "Saliency_Decrease")$
- Flow: $Saliency_Decrease = "Political_Event"/"Saliency_Decay_Time"$
- $Saliency_Incr = ("Max_Saliency" - "Political_Event") /$
"Min_Saliency"+"Max_Saliency"
- $Policy_Choice = "Eff_Of_Political_Choice" = "Initial_Policy_Choice"$
- $Sys_Stability_Decrease =$
"Social_Stress"*"Soc_Stress_From_Policy_Choice_Failure"
- $Sys_Stability_Increase =$
"Social_Stress"*"Political_Event"*"Govt_Applies_Policy_Choice"
- $Social_Stress = "Social_Stress_Increase" - "Social_Stress_Decrease" =$
"Initial_Stress"

3.1.2 Social Stress

Cioffi-Revilla, in "Simplicity and Reality in Computational Modeling of Politics" (2009), introduces social stress as a function of a political issue, in which salience changes the state of society from relaxed to stressed, in the absence of government policy. It can be inferred from this that social stress is proportional to the degree of

salience of a political event or acts exerted on a society (Wlezien, 2005). The stress values in table 14 are used as inputs into the SD model. Finally, the table below lists the social stress parameters for the SD model in terms of stocks and flows.

3.1.2.1 Social Stress Parameters

Table 16 – Social Stress Variable Parameters

Dependent Variable	Parameter(s)	Value/Range	Reference
Social Stress	Intial_Stress	1.0 to 0.13	
	Effect_Of_Pol_Choice_On_Soc_Stress	1.0 to 0.13	
	Soc_Stress_Per_Response	0.2	(Cioffi-Revilla, 1998)
	Normal_Stress_Time	1	(Lubyansky, 2011)
	Max_Soc_Stress	1.0	(Lubyansky, 2014)
	Min_Soc_Stress_Adj_Time	0.5	
	Max_Response	1.0	
	Nrm_Social_Stress_Decay_Time	1	

3.1.2.2 Social Stress Equations

- Flow: Social_Stress_Increase=
MIN("Soc_Stress_Incr_From_Response", "Max_Soc_Stress_Increase")
- Stock: Social_Stress_Decrease= "Social_Stress"/"Soc_Stress_Decay_Time"
- Soc_Stress_Incr_From_Response=
"Soc_Stress"*"Soc_Stress_Per_Response"+"Stress_Reinforcement_Rate"+
Effect_Of_Pol_Choice_On_Soc_Stress"

- $\text{Stress_Reinforcement_Rate} = \frac{\text{Social_Stress}}{\text{Normal_Stress_Time}}$
- $\text{Max_Soc_Stress_Increase} = \frac{(\text{Max_Soc_Stress} - \text{Social_Stress})}{\text{Min_Soc_Stress_Adj_Time} + \frac{\text{Max_Soc_Stress}}{\text{Soc_Stress_Decay_Time}}}$
- $\text{Soc_Stress_Decay_Time} = \text{MAX}(\frac{\text{Nrm_Social_Stress_Decay_Time}}{(\frac{\text{Soc_Stress}}{\text{Max_Response}})}, \text{Min_Soc_Stress_Adj_Time})$

3.1.3 System Stability

ForPol assumes that the system is one of stability and instability, which is a process Choucri, et al. define in their article *Understanding & Modeling State Stability: Exploiting System Dynamics* as “a state being stable to the extent that its resilience (capabilities) is greater than the load (or pressures) exerted upon it” (Choucri, et al., p.2). This means that agents in this model can be at different stages of stability over time and exposed to different stresses (e.g. political events or actor policy choices), resulting in a degree of instability. An alternate way of stating this is that, in this process, instability is the absence of certain degree of stability. Therefore, stability or instability is measured as a function of salience of political event or act (Wlezien, 2005). Finally, the table below lists the system stability parameters for the SD model in terms of stocks and flows.

3.1.3.1 System Stability Parameters

Table 17 – System Stability Variable Parameters

Dependent Variable	Parameter(s)	Value/ Range	Reference
System Stability	Initial_System_Stability	1.0 to 0.07	(Choucri et al., 2006)
	Max_System_Stability	1.0	
	System_Stability_Reset_Time	1.0	
	Min_System_Stability_Adj_Time	0.5	
	TIME_STEP	0.125	
	Government_Response_To_Stress	1.0 to 0.90	
	Policy_Choice_Eff_On_Sys_Stability	0.28	

3.1.3.2 System Stability Equations

- Flow: System_Stability_Increase= (“Max\System_Stability”- “System_Stability”)/“System_Stability_Reset_Time”
- Stock: System_Stability= “System_Stability_Increase”- “System_Stability_Decrease”= “Initial_System_Stability”
- Flow: System_Stability_Decrease= MIN(“Salience_Of_Political_Event”*“Max_Sys_Stability_Decr”, “Sys_Stability_Decr_From_Policy_Choice”)
- Salience_Of_Political_Event= IF THEN ELSE(“System_Stability”>0 , “Political_Event”/“System_Stability”, 1)
- Max_Sys_Stability_Decr= “System_Stability”/“Min_System_Stability_Adj_Time”

- Soc_Stress= “System_Stability”*”Government_Response_To_Stress”
- Sys_Stability_Decr_From_Policy_Choice=
“Success_Of_Policy_Choice”*”Policy_Choice_Eff_On_Sys_Stability”
- Success_Of_Policy_Choice= IF THEN ELSE(“System_Stability”>0 ,
“Political_Event”/“System_Stability”, 1)

3.1.4 Policy Choice

ForPol assumes that the state-actor’s government possess policy choices that are diplomatic, informational, based on military capabilities, and based on economic resources used as decisional acts. These variables are known as instruments of national power (Department of Defense, 2013), which are available to an actor for application towards resolving a political issue (Table 9) in response to social stress or system instability. defines and assigns values, measurements, and probabilities.

3.1.4.1 Policy Choice Parameters

Table 18 – Social Stress Variable Parameters

Dependent Variable	Parameter(s)	Value/ Range	Reference
Policy Choice	Initial_Policy_Choice	1.0 to 0.90	
	Effectiveness_Of_Policy_Choice_By_State_Actor	1.0 to 0.90	(Azar, 1984)
	Failure_Pol_Choice_Time	2	

3.1.4.2 Policy Choice Equations

- Flow: Eff_Of_Political_Choice= (“Success_Of_Policy_Choice”- “Policy_Choice”)/“Failure_Po\ Choice_Time”+”Effectiveness_Of_Policy_Choice_By_State-Actors”
- Stock: Policy_Choice= “Eff_Of_Political_Choice” = “Initial_Policy_Choice”
- Success_Of_Policy_Choice= IF THEN ELSE(“System_Stability”>0 , “Political_Event”/“System_Stability”, 1)
- System_Stability= “System_Stability_Increase”-“System_Stability_Decrease” = “Initial_System_Stability”
- Political_Event= “Salience_Increase”-“Salience_Decrease” = “Initial_Political_Event”

3.1.5 System Description

The 1967 Arab-Israeli Six-Day War Vensim model provides the user with a dashboard, from which to control the reference mode parameters and data input values. As depicted in figure 22, the dash board displays the parameters that will control the model’s behavior over time. This dashboard will also serve as the control panel for experimentation and input parameter calibration.

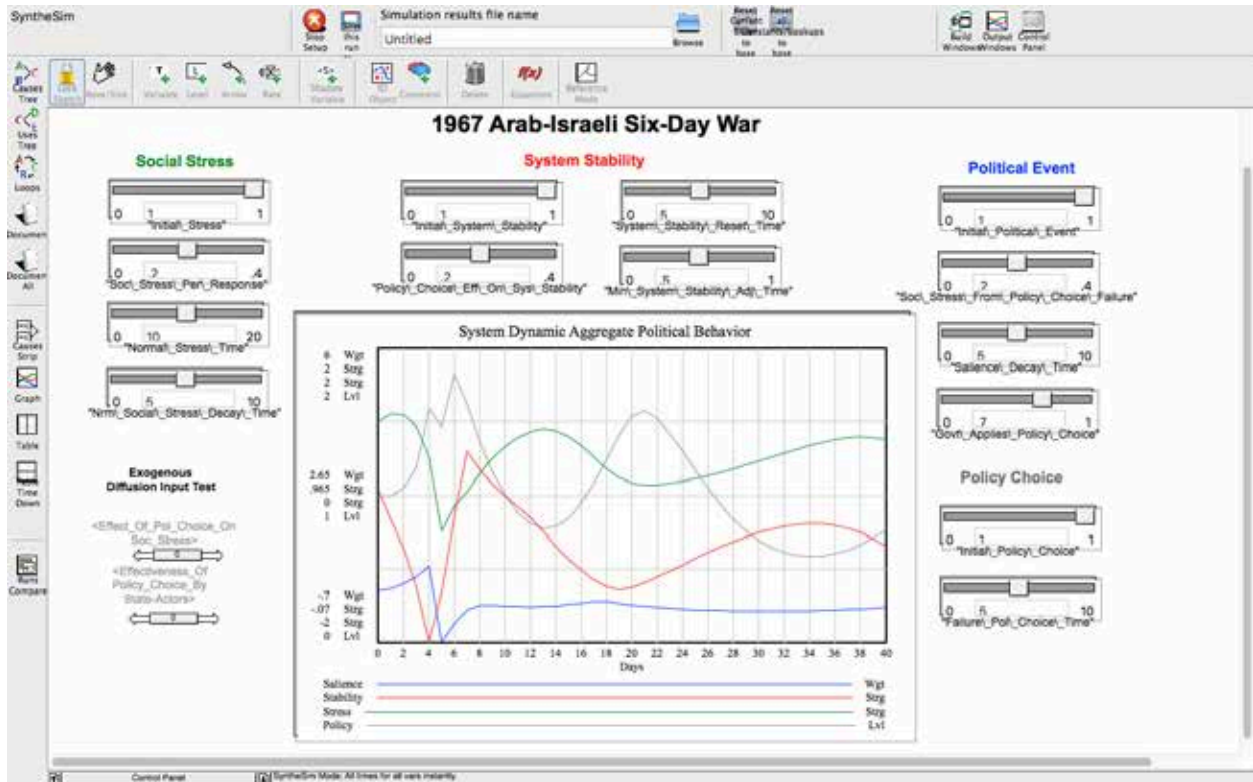

Figure 22 – Vensim 1967 Arab-Israeli Six-Day War Dashboard

3.1.6 – Dashboard Parameter Settings

Stability Stock	Value
Initial_System_Stability (0.90 to 1.00):	0
Policy_Choice_Eff_On_Sys_Stability (0.07 to 1.00):	0
System_Stability_Reset_Time (1 to 31):	1
Min_System_Stability_Adj_Time (1 to 31):	0.5
Max_System_Stability (0.07 to 1.00):	1
TIME_STEP (dt):	0.125
Government_Response_To_Stress (0.90 to 1.00)	0

<u>Social Stress Stock</u>	<u>Value</u>
· Initial_Stress (0.13 to 1.00):	0
· Soc_Stress_Per_Response (0.13 to 1.00):	0.2
· Normal_Stress_Time (days):	2
· Effect_Of_Pol_Choice_On_Soc_Stress (0.90 to 1.00):	0
· Nrm_Social_Stress_Decay_Time (1 to 31):	1.0
· Max_Soc_Stress (0.13 to 1.00):	1.0
· Min_Soc_Stress_Adj_Time (1 to 31):	0.3
· Max_Response (0.90 to 1.00):	1.0

<u>Political Event Stock</u>	<u>Value</u>
· Initial_Political_Event (0.90 to 1.00):	0
· Soc_Stress_From_Policy_Choice_Failure (0.13 to 1.00):	0.2
· Govt_Applies_Poolicy_Choice (0.90 to 1.00):	0
· Max_Salience (0.06 to 1.00):	1.0
· Min_Salience (0.05 to 0.90):	0.90
· Salience_Decay_Time (1 to 31):	2

<u>Policy Choice Stock</u>	<u>Value</u>
· Initial_Policy_Choice (0.90 to 1.00):	0
· Effectiveness_Of_Policy_Choice_By_State_Actor (0.90 to 1.00):	0
· Failure_Pol_Choice_Time (1 to 31):	1

3.2 Experimental Design

This section describes the ForPol model's input parameter calibration method used to observe how policy choices will typically behave within the SD model. The statistical software RStudio & RcmdrPlugin is used to correlate the policy choices and the Vensim SD software is used as the platform to run the model.

3.2.1 Hypothesis 1 – Correlation Analysis for Informational Policy Choice

What this hypothesis is concerned with is how informational policy choices correlate to system stability. The data used is the 1967 Arab-Israeli War COPDAB (Azar, 1984) for Informational policy choices preceding the war.

(1) Null Hypothesis (H_0). Informational policy choices do not correlate with system stability.

(2) Alternate Hypothesis (H_A). Informational policy choices correlate with system stability.

(3) Expected Outcome. Informational policy choices correlate with system stability.

3.2.1.1 Hypothesis 1 – ForPol SD Typical Run Input Parameter Settings

(1) A Pearson's Product-Moment Correlation analysis is conducted for the informational policy choice data set.

(2) ForPol (Vensim) – Informational Policy Typical Run #1 Parameter Settings:

a. Political_Event:

- 13 MAY, EGY - Initial_Political_Event (0.90 to 1.00) = 0.43.
- 23 MAY, SYR – Govt_Applies_Policy_Choice (0.90 to 1.00) = 0.10.
- Max_Salience (0.90 to 1.00) = 1.0.
- Min_Salience (0.90 to 1.00) = 0.90.
- Salience_Decay_Time (1 to 31) = 2.

b. Political_Choice:

- 20 MAY, EGY – Initial_Policy_Choice (0.90 to 1.00) = 0.28.

c. System_Stability:

- Gov_Response_To_Social_Stress (0.90 to 1.00) = 0.81.

d. Social_Stress:

- Max_Response (0.13 to 1.00) = 0.81.

e. External Input:

- 5 JUN, ISR - Eff_Of_Policy_Choice_By_State_Actors (0.90 to 1.00) = 1.00.
- Eff_Of_Pol_Choice_On_Soc_Stress (0.90 to 1.00) = 1.00.

(3) ForPol (Vensim) – Informational Policy Typical Run #2 Parameter Settings:

a. Political_Event:

- 14 MAY, RUS - Initial_Political_Event (0.90 to 1.00) = 0.16.
- 27 MAY, US – Govt_Applies_Policy_Choice (0.90 to 1.00) = 0.06.

b. Political_Choice:

- 25 MAY, FRN – Initial_Policy_Choice (0.90 to 1.00) = 0.05.

c. System_Stability:

- Gov_Resposne_To_Social_Stress (0.90 to 1.00) = 0.69.

d. Social_Stress:

- Max_Response (0.13 to 1.00) = 0.69.

e. External Input:

- 28 MAY, SYR - Eff_Of_Policy_Choice_By_State_Actors (0.90 to 1.00)
= 0.30.
- Eff_Of_Pol_Choice_On_Soc_Stress (0.90 to 1.00) = 0.30.

3.2.2 Hypothesis 2 – Correlation Analysis for Military Policy Choice

What this hypothesis is concerned with is how military policy choices correlate to system stability. The data used is the 1967 Arab-Israeli War COPDAB for military policy choices preceding the war.

- (1) H_0 . Military policy choices do not correlate with system stability.
- (2) H_A . Military policy choices correlate with system stability.
- (3) Expected Outcome. Military policy choice correlates with system stability.

3.2.2.1 Hypothesis 2 – ForPol SD Typical Run Input Parameter Settings

(1) A Pearson's Product-Moment Correlation analysis is conducted for the military policy choice data set.

(2) ForPol (Vensim) – Military Policy Typical Run #1 Parameter Settings:

a. Political_Event:

- 28 MAY, EGY - Initial_Political_Event (0.90 to 1.00) = 0.64.
- 05 JUN, ISR – Govt_Applies_Policy_Choice (0.90 to 1.00) = 1.00.
- Soc_Stress_From_Policy_Choice_Faiure (0.13 to 1.00) = 0.94.
- Max_Salience (0.90 to 1.00) = 1.0.
- Min_Salience (0.90 to 1.00) = 0.90.

b. Political_Choice:

- 02 JUN, SYR – Initial_Policy_Choice (1.0 to 0.90) = 0.49.

- Effectiveness_Of_Policy_Chocie_By_State-Actors (0.90 to 1.00) = 0.43.
- Failure_Pol_Choice_Time (1 to 31) = 1.5.

c. System_Stability:

- Initial_System_Stability (0.07 to 1.00) = 0.93.
- Policy_Choice_Eff_On_Sys_Stability (0.90 to 1.00) = 0.49.
- System_Stability_Reset_Time (1 to 31) = 1.5.
- Max_System_Stability = 0.67.
- Min_System_Stability_Adj_Time (1 to 31) = 1.5.
- Gov_Resposne_To_Social_Stress (1.0 to 0.90) = 0.64.
- <TIME STEP> (dt) = 0.125.

d. Social_Stress:

- Initial_Stress (0.13 to 1.00) 0.94.
- Effect_Of_Pol_Choice_On_Soc_Stress (0.90 to 1.00) = 0.43.
- Soc_Stress_Per_Response (0.13 to 1.00) = 0.20.
- Max_Response (0.13 to 1.00) = 0.94.
- Normal_Stress_Time (1 to 31) = 2.
- Max_Soc_Stress (0.13 to 1.00) = 0.69.
- Min_Soc_Stress_Adj_Time (1 to 31) = 0.3.
- Nm_Social_Stress_Decay_Time (1 to 31) = 1.

e. External Input:

- 05 JUN, RUS - Eff_Of_Policy_Choice_By_State_Actors (0.90 to 1.00) = 0.43.
- Eff_Of_Pol_Choice_On_Soc_Stress (0.90 to 1.00) = 0.43.

(3) ForPol SD (Vensim) – Military Typical Run #2 Parameter Settings:

a. Political_Event:

- 18 MAY, ISR - Initial_Political_Event (0.90 to 1.00) = 0.28.
- 23 MAY, IRQ – Govt_Applies_Policy_Choice (0.90 to 1.00) = 0.46.
- Soc_Stress_From_Policy_Choice_Faiure (0.13 to 1.00) = 0.63.
- Max_Salience (0.90 to 1.00) = 1.0.
- Min_Salience (0.90 to 1.00) = 0.90.
- Salience_Decay_Time (1 to 31) = 1.

b. Political_Choice:

- 18 MAY, EGY – Initial_Policy_Choice (0.90 to 1.00) = 0.06.
- Effectiveness_Of_Policy_Choice_By_State-Actors (0.90 to 1.00) = 0.43.
- Failure_Pol_Choice_Time (1 to 31) = 4.

c. System_Stability:

- Initial_System_Stability (0.07 to 1.00) = 0.73.
- Policy_Choice_Eff_On_Sys_Stability (0.90 to 1.00) = 0.06.
- System_Stability_Reset_Time (1 to 31) = 1.5.
- Max_System_Stability (0.07 to 1.00) = 0.67.
- Min_System_Stability_Adj_Time (1 to 31) = 1.5.

- Gov_Responsne_To_Social_Stress (0.07 to 1.00) = 0.63.

- <TIME STEP> (dt) = 0.125.

d. Social_Stress:

- Initial_Stress (0.13 to 1.00) 0.75.

- Effect_Of_Pol_Choice_On_Soc_Stress (0.90 to 1.00) = 0.63.

- Soc_Stress_Per_Response (0.13 to 1.00) = 0.20.

- Max_Response (1.0 to 0.13) = 0.75.

- Normal_Stress_Time (1 to 31) = 0.5.

- Max_Soc_Stress (0.13 to 1.00) = 0.75.

- Min_Soc_Stress_Adj_Time (1 to 31) = 0.5.

- Nm_Social_Stress_Decay_Time (1 to 31) = 0.5.

e. External Input:

- 23 MAY, UKG - Eff_Of_Policy_Choice_By_State_Actors (0.90 to 1.00) = 0.16.

- Eff_Of_Pol_Choice_On_Soc_Stress (0.90 to 1.00) = 0.16.

3.2.3 Hypothesis 3 – Correlation Analysis for Diplomatic Policy Choice

What this hypothesis is concerned with is how diplomatic policy choices correlate to system stability. The data used is the 1967 Arab-Israeli War COPDAB for diplomatic policy choices preceding the war.

(1) H₀. Diplomatic policy choices do not correlate with system stability.

(2) H_A. Diplomatic policy choices correlate with system stability.

(3) Expected Outcome. Diplomatic policy choice correlates with system stability.

3.2.3.1 Hypothesis 3 – ForPol SD Typical Run Input Parameter Settings

(1) A Pearson's Product-Moment Correlation analysis is conducted for the diplomatic policy choice data set.

(2) ForPol (Vensim) – Diplomatic Policy Typical Run #1 Parameter Settings:

a. Political_Event:

- 18 MAY, ISR - Initial_Political_Event (0.90 to 1.00) = 0.05.
- 28 MAY, US – Govt_Applies_Policy_Choice (0.90 to 1.00) = 0.10.
- Social_Stress_From_Policy_Choice_Failure (0.13 to 1.00) = 0.63
- Max_Salience (0.90 to 1.00) = 1.0.
- Min_Salience (0.90 to 1.00) = 0.90.
- Salience_Decay_Time (1 to 31) = 2.

b. Political_Choice:

- 23 MAY, EGY – Initial_Policy_Choice (0.90 to 1.00) = 0.06.
- Effectiveness_Of_Policy_Choice_By_State-Actors (0.90 to 1.00) = 0.14.
- Failure_Pol_Choice_Time (1 to 31) = 5.

c. System_Stability:

- Initial_System_Stability (0.07 to 1.00) = 0.73

- Policy_Choice_Eff_On_Sys_Stability (0.90 to 1.00) = 0.06.
- System_Stability_Reset_Time (1 to 31) = 1.5.
- Gov_Response_To_Social_Stress (0.90 to 1.00) = 0.05.
- Max_System_Stability (0.07 to 1.00) = 0.67.
- Min_System_Stability_Adj_Time (1 to 31) = 1.5.
- <TIME_STEP> (dt) = 0.125.

d. Social_Stress:

- Initial_Stress (0.13 to 1.00) = 0.75.
- Effect_Of_Pol_Choice_On_Soc_Stress (0.90 to 1.00) = 0.44.
- Soc_Stress_Per_Response (0.13 to 1.00) = 0.20.
- Max_Response (0.13 to 1.00) = 0.50.
- Normal_Stress_Time (1 to 31) = 1.5.
- Max_Soc_Stress (0.13 to 1.00) = 0.75.
- Min_Soc_Stress_Adj_Time (1 to 31) = 0.5.
- Nm_Social_Stress_Decay_Time (1 to 31) = 0.5.

e. External Input:

- 02 JUN, UKG - Eff_Of_Policy_Choice_By_State_Actors (0.90 to 1.00) = 0.14.
- Eff_Of_Pol_Choice_On_Soc_Stress (0.90 to 1.000) = 0.14.

(3) ForPol (Vensim) – Diplomatic Policy Typical Run #2 Parameter Settings:

f. Political_Event:

- 09 MAY, ISR - Initial_Political_Event (0.90 to 1.00) = 0.49.

- 28 MAY, EGY – Govt_Applies_Policy_Choice (0.90 to 1.00) = 0.28.
- Social_Stress_From_Policy_Choice_Failure (0.13 to 1.00) = 0.69.
- Max_Salience (0.90 to 1.00) = 1.0.
- Min_Salience (0.90 to 1.00) = 0.90.
- Salience_Decay_Time (1 to 31) = 10.

g. Political_Choice:

- 13 MAY, ISR – Initial_Policy_Choice (0.90 to 1.00) = 0.06.
- Effectiveness_Of_Policy_Choice_By_State-Actors (0.90 to 1.00) = 0.14.
- Failure_Pol_Choice_Time (1 to 31) = 5.

h. System_Stability:

- Initial_System_Stability (0.07 to 1.00) = 0.73
- Policy_Choice_Eff_On_Sys_Stability (0.90 to 1.00) = 0.06.
- System_Stability_Reset_Time (1 to 31) = 3.5
- Gov_Response_To_Social_Stress (0.90 to 1.00) = 0.16.
- Max_System_Stability (0.07 to 1.00) = 0.87
- Min_System_Stability_Adj_Time (1 to 31) = 0.5
- <TIME_STEP> (dt) = 0.125.

i. Social_Stress:

- Initial_Stress (0.13 to 1.00) = 0.88.
- Effect_Of_Pol_Choice_On_Soc_Stress (0.90 to 1.00) = 0.88.
- Soc_Stress_Per_Response (0.13 to 1.00) = 0.20.

- Max_Response (0.13 to 1.00) = 0.88.
- Normal_Stress_Time (1 to 31) = 1.5.
- Max_Soc_Stress (0.13 to 1.00) = 0.69.
- Min_Soc_Stress_Adj_Time (1 to 31) = 0.5.
- Nm_Social_Stress_Decay_Time (1 to 31) = 0.5.

j. External Input:

- 05 JUN, SYR - Eff_Of_Policy_Choice_By_State_Actors (0.90 to 1.00) = 0.43.
- Eff_Of_Pol_Choice_On_Soc_Stress (0.90 to 1.00) = 0.81.

3.2.4 Hypothesis 4 – Correlation Analysis for Economic Policy Choice

What this hypothesis is concerned with is how economic policy choices correlate to system stability. The data used is the 1967 Arab-Israeli War COPDAB for diplomatic policy choices preceding the war.

- (1) H_0 . Economic policy choices do not correlate with system stability.
- (2) H_A . Economic policy choices correlate with system stability.
- (3) Expected Outcome. Economic policy choice correlates with system stability.

3.2.4.1 Hypothesis 4 – ForPol SD Typical Run Input Parameter Settings

(1) A Pearson's Product-Moment Correlation analysis is conducted for the economic policy choice data set.

(2) ForPol (Vensim) – Economic Policy Typical Run #1 Parameter Settings:

a. Political_Event:

- 28 MAY, US - Initial_Political_Event (1.0 to 0.90) = 0.05.
- 04 JUN, EGY – Govt_Applies_Policy_Choice (1.0 to 0.90) = 0.10.
- Max_Salience (1.0 to 0.90) = 1.0.
- Min_Salience (1.0 to 0.90) = 0.90.
- Salience_Decay_Time (1 to 31) = 2.
- Social_Stress_From_Policy_Choice_Failure (0.13 to 1.00) = 0.63.

b. Political_Choice:

- 04 JUN, ISR – Initial_Policy_Choice (0.90 to 1.00) = 0.06.
- Effectiveness_Of_Policy_Choice_By_State-Actors (0.90 to 1.00) = 0.28.
- Failure_Pol_Choice_Time (1 to 31) = 0.5.

c. System_Stability:

- Initial_System_Stability = (0.07 to 1.00) = 0.81.
- Gov_Response_To_Social_Stress (1.0 to 0.90) = 0.81.
- Policy_Choice_Eff_On_Sys_Stability (0.90 to 1.00) = 0.28.
- Max_System_Stability (0.07 to 1.00) = 0.80.

- Min_System_Stability_Adj_Time (1 to 31) = 0.5.
- System_Stability_Reset_Time (1 to 31) = 1.
- <TIME_STEP> = 0.125 (dt).

d. Social_Stress:

- Initial_Stress (0.13 to 1.00) = 0.81.
- Effect_Of_Pol_Choice_On_Sos_Stress (0.90 to 1.00) = 0.43.
- Social_Stress_Per_Response (0.13 to 1.00) = 0.20.
- Max_Response (0.13 to 1.00) = 0.05.
- Max_Soc_Stress (0.13 to 1.00) = 0.50.
- Min_Soc_Stress_Adj_Time (1 to 31) = 0.5.
- Normal_Stress_Time (1 to 31) = 1.5.
- Nrm_Social_Stress_Decay_Time (1 to 31) = 0.50.

e. External Input:

- 06 JUN, IRQ - Eff_Of_Policy_Choice_By_State_Actors (1.0 to 0.90) = 0.28.
- Eff_Of_Pol_Choice_On_Soc_Stress (1.0 to 0.90) = 0.75.

(3) ForPol (Vensim) – Economic Policy Typical Run #2 Parameter Settings:

a. Political_Event:

- 12 MAY, UKG - Initial_Political_Event (1.0 to 0.90) = 0.16.
- 24 MAY, US – Govt_Applies_Policy_Choice (1.0 to 0.90) = 0.06.
- Max_Salience (1.0 to 0.90) = 1.0.
- Min_Salinece (1.0 to 0.90) = 0.90.

- Saliency_Decay_Time (1 to 31) = 2.
- Social_Stress_From_Policy_Choice_Failure = 0.69.

b. Political_Choice:

- 23 MAY, EGY – Initial_Policy_Choice (1.0 to 0.90) = 0.05.
- Effectiveness_Of_Policy_Choice_By_State-Actors = 0.30.
- Failure_Pol_Choice_Time (1 to 31) = 1.0.

c. System_Stability:

- Initial_System_Stability (0.07 to 1.00) = 0.27.
- Gov_Resposne_To_Social_Stress (1.0 to 0.90) = 0.16.
- Policy_Choice_Eff_On_Sys_Stability (0.90 to 1.00) = 0.16.
- Max_System_Stability (0.07 to 1.00) = 0.26.
- Min_System_Stability_Adj_Time (1 to 31) = 0.5.
- System_Stability_Reset_Time (1 to 31) = 1.5.
- <TIME_STEP> = 0.125 (dt).

d. Social_Stress:

- Initial_Stress (0.13 to 1.00) = 0.31.
- Social_Stress_Per_Response (0.13 to 1.00) = 0.20.
- Max_Response (0.13 to 1.00) = 0.16.
- Max_Soc_Stress (0.13 to 1.00) = 0.31.
- Min_Soc_Stress_Adj_Time (1 to 31) = 0.50.
- Normal_Stress_Time (1 to 31) = 0.2.
- Nrm_Social_Stress_Decay_Time (1 to 31) = 0.5.

e. External Input:

- 02 JUN, FRN - Eff_Of_Policy_Choice_By_State_Actors (1.0 to 0.90) = 0.30.
- Eff_Of_Pol_Choice_On_Soc_Stress (1.0 to 0.90) = 0.30.

CHAPTER 4: FINDINGS

This section provides a statistical summary of the data, then reports the COPDAB input parameter calibration results and the results from the ForPol SD typical runs. To do this, the data was divided into four separate policy categories: diplomatic, informational, military and economic. For each of the hypothesis a Pearson's product-moment correlation analysis was conducted to determine the strength of the linear relationship between the two quantitative variables: policy weight and system stability, by the resulting covariance coefficients and that these variables correlated as expected. Finally, the calibrated input parameters are used to run the model, which produce reference modes for observational purposes, to determine if the model behaves in a typical way.

4.1 Experimental Design

The numerical statistics below (table 19) summarize the input parameters for each of the four policy categories.

Table 19 – Statistical Summary

Variable	Count	Mean	Standard Deviation	Standard Error	Coefficient Variance	Skewness	Kurtosis	IQR	Quantiles				
	n	μ	σ	σ_x	C_v				$Q_1 - Q_3$	Q_0	Q_1	Q_2	Q_3
Informational	34	0.66	0.18	0.03	0.27	-0.15	1.03	0.05	0.20	0.67	0.67	0.72	1.00
Military	188	0.64	0.24	0.02	0.38	-0.33	-0.79	0.33	0.13	0.47	0.67	0.80	1.00
Diplomatic	189	0.55	0.13	0.01	0.24	-0.05	-0.73	0.20	0.20	0.47	0.47	0.67	0.87
Economic	25	0.50	0.16	0.03	0.32	0.24	-1.07	0.20	0.27	0.40	0.47	0.60	0.73
Total n	436												

4.2 Informational Policy Choice

4.2.1 Hypothesis 1 – Correlation Results for Informational Policy Choice

(1) Results. The Pearson's Product-Moment Correlation analysis demonstrate that the two variables, informational policy and system stability are strongly correlated: $t = 6.5269$, $r(32) = 0.7556788$, $p = 2.382e-07$.

(2) H_A is true, correlation does not equal 0, hence, information policy choices correlate to system stability within a 95% confidence interval of 0.5608304 and 0.8712112.

(3) H_0 is rejected.

The scatter plot below depicts numbers on the “y” axis, which represent the minimum and maximum for the system stability variable and numbers on the “x” axis, which also represent the minimum and maximum for the policy choice variable. The values on both axis' have been rescaled between 0 and 1 for plotting purposes. The green fitted line that runs through the points shows a moderate linear relationship between the stability (response) and the policy variable based on clustering of plots along the line. The graph also seems to show a strong positive correlation between informational policy choices and system stability values meaning that the correlation between the variables is strong, with a correlation coefficient value of about 0.8. This means that as the informational policy variable value increases so does the system stability value, which is consistent with the COPDAB scale (Azar, 1984).

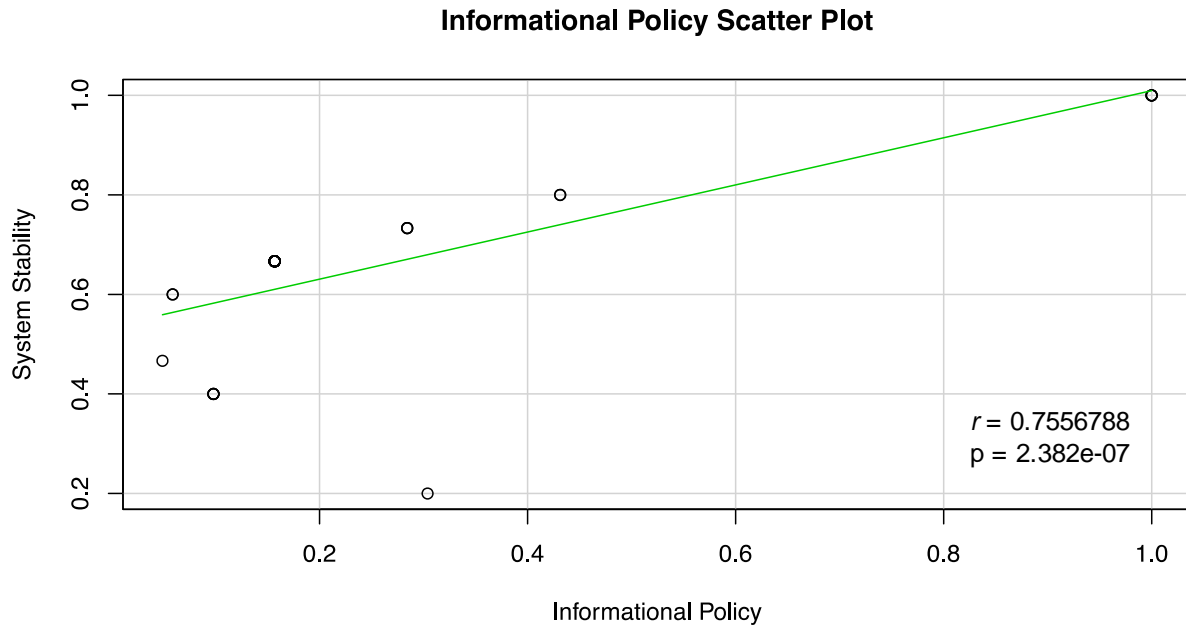

Figure 23 – Informational Policy Scatter Plot

However, the resulting p-value will tell us if correlation between the variables truly exists, which will show if the correlation coefficient is significantly different from zero. As figure 23 depicts the $p = 2.382e-07$ is less than the significance level, meaning that correlation is different than 0. The data below depicts the variable intercept values along the plot's fitted line, which are used for the informational typical runs:

Political Event	System Stability
1.00	1.00
0.43	0.80
0.28	0.73
0.16	0.67
0.06	0.60
0.05	0.47
0.10	0.40
0.30	0.20

4.2.1.1 Hypothesis 1 – ForPol SD Typical Run Reference Mode Informational

(1) ForPol SD Typical Runs. Table 20 depicts calibrated parameter values, which served as inputs for two typical runs of informational policy choices. The table's far left, outlines a state-actor associated with a political event or decisional act, followed by the day and month of occurrence. The table's center, outlines the event stock parameter values, which are representative of the correlation analysis. The table's far right lists the vents used for each of the typical runs.

Table 20 – Informational Policy Typical Runs

State-Actor/ Stock(s)	Mo	Day	Political Event Decisional Act	Pol Type	Stock Parameter(s)				Typical Run#
					Poli_Event	Pol_Choice	Other_Govt_Policy_Choice	Sys_Stab	
EGY	5	13	REPORT ISR GROUND-AIR ATTACK ALONG SYR BORDER	I	0.43	0.00	0.00	0.80	1
EGY	5	20	STATE OF EMERGENCY- GAZA STRIP	I	0.00	0.28	0.00	0.73	1
SYR	5	23	STATEMENT- FULL SUPPORT UAR CLOSING GULF	I	0.00	0.00	0.10	0.40	1
ISR	6	5	AQUABA ISR DECLARE WAR	I	0.00	0.00	1.00	1.00	1
RUS	5	14	AGGRESSIVE ACTIONS- COMMUNIQUE WITH UAR	I	0.16	0.00	0.00	0.67	2
FRN	5	25	NOT TO TEST STRAITS OF TIRAN	I	0.00	0.05	0.00	0.47	2
US	5	27	BLOCKADE AGAINST ANY UNILATERAL ACTION	I	0.00	0.00	0.06	0.60	2
SYR	5	28	RADIO-SYR- IRQ BILATERAL MILITARY AGREEMENT	I	0.00	0.00	0.30	0.20	2
D = Diplomatic		I = Informational		M = Military		E = Economic			

The reference modes that follows, show the results from the first informational policy typical run, using the input parameters tabulated in chapter 3, section 2 and table 20. The reference modes depict numbers on the “y” axis, which represent the minimum and maximum for each of the variables observed and numbers on the “x” axis, which represent variable performance over time in unit days. The values on the “y” axis have

been rescaled between 0 and 1 for plotting purposes. The blue line represents the political salience variable; the red line represents the system stability variable; the green line represents the social stress variable and the gray line represents the policy choice variable.

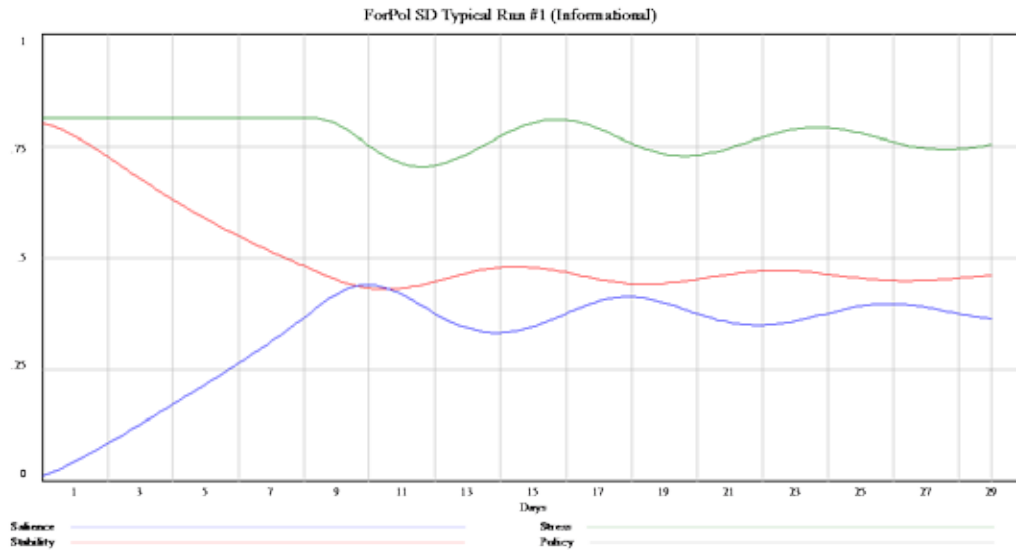

Figure 24– ForPol Sim SD Typical Run #1 (Informational)

The reference mode in figure 24 shows how the informational policy choice (gray line) affects system stability (red line), political event salience (blue line) and social stress (green) line. The political salience for the events on table 20, typical run one, seem to gradually escalate to a maximum, while simultaneously system stability decreases to its minimum, both converging at a value of 0.48. However, after day 14, the effects of policy drive salience to a low of 0.35 and stability to a high of 0.47. From that point forward both seem to undulate respectively, as salience increases, system stability decreases and vice versa. The effects of policy seem to affect salience and stability as expected (Choucri et al., 2006). Alternatively, social stress, remains high, but

on day 11 decreases to 0.71 and continues undulating with the other two variables. Social stress seems to behave as system stability does, when salience goes up social stress goes down, however, that is not the expected social stress behavior, which should be the opposite, as salience increases, so does social stress and vice versa (Cioffi-revilla, 2011).

The next reference mode (figure 25), also show the results from the second typical run for informational policy using the input parameters tabulated in chapter 3, section 2 and table 20. The reference modes depict numbers on the “y” axis, which represent the minimum and maximum for each of the variables observed and numbers on the “x” axis, which represent variable performance over time in unit days. The values on the “y” axis have been rescaled between 0 and 1 for plotting purposes. The blue line represents the political salience variable; the red line represents the system stability variable; the green line represents the social stress variable and the gray line represents the policy choice variable.

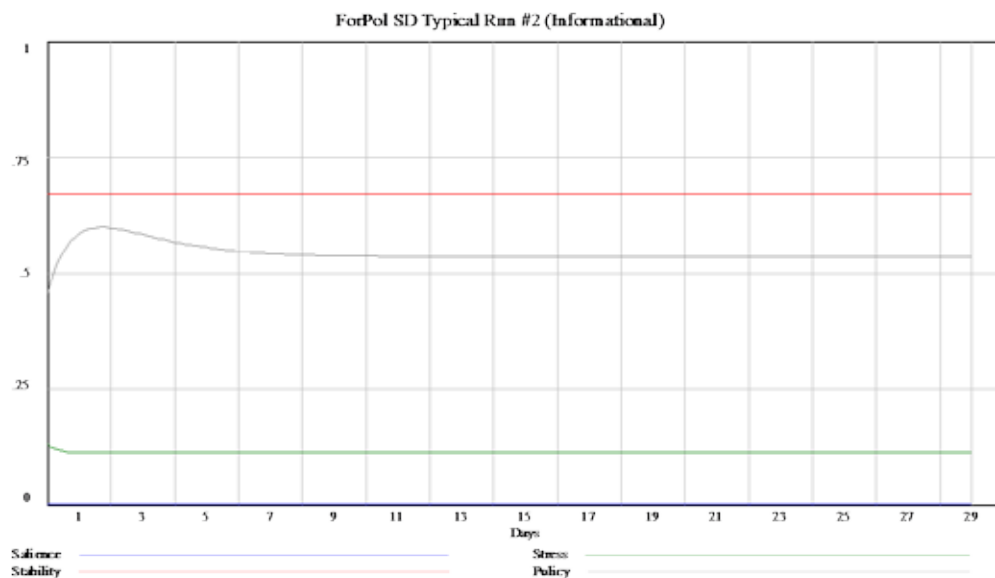

Figure 25– ForPol Sim SD Typical Run #2 (Informational)

The reference mode in figure 25 shows how the informational policy choice (gray line) affects system stability (red line), political event salience (blue line) and social stress (green) line. The political salience for the events on table 20, typical run two, seem to remain constant on different locations of the reference mode. Starting with political salience at a value of 0.16, however remaining constant throughout the run. This behavior results from the effect of policy choice, which increase to a max of 0.58 by day two, then slightly decreases to 0.54 on day 4, remaining constant throughout the run, thus, allowing system stability to remain constant at a maximum of 0.67 throughout the run. As in the first typical run, policy seem to affect salience and stability as expected (Choucri et al., 2006). Alternatively, social stress behaves differently in this run, located right above salience at a low 0.11, but below system stability and policy choice. This typical run shows social stress behaving as expected, the effect of policy on event salience causes it to decrease, therefore, social stress also decreases and stability is maintained. (Choucri et al., 2006; Cioffi-revilla, 2011).

4.3 Military Policy Choice

4.3.1 Hypothesis 2 – Correlation Results from Military Policy Choice

(1) Results. The Pearson's Product-Moment Correlation analysis demonstrate that the two variables, military policy and system stability were strongly correlated: $t = 12.45$, $r(186) = 0.6742125$, $p < 2.2e-16$.

(2) H_A is true, correlation does not equal 0, hence, military policy choices correlate to system stability within a 95% confidence interval of 0.5878190 and 0.7454014.

(3) H_0 is rejected.

The scatter plot below (figure 26) depicts numbers on the “y” axis, which represent the minimum and maximum for the system stability variable and numbers on the “x” axis, which also represent the minimum and maximum for the military policy choice variable. The values for both axis' have been rescaled between 0 and 1 for plotting purposes. The green fitted line that runs through the points shows a moderate relationship between the stability (response) and the policy variable based on clustering of plots along the line. The graph shows a strong positive correlation between the military policy choice and system stability values, with a correlation coefficient of about 0.7. This means that as the value for the military policy variable increases so does the value for the system stability variable.

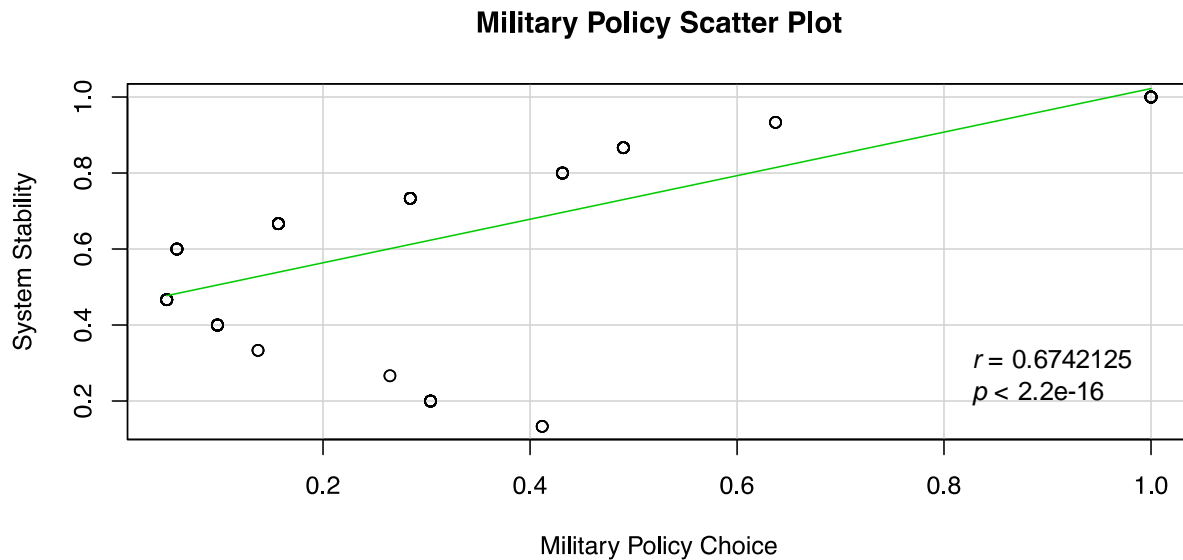

Figure 26 – Military Policy Scatter Plot

However, the resulting p-value will tell us if correlation between the variables truly exists, which will show if the correlation coefficient is significantly different from zero. As figure 26 depicts the $p < 2.2e-16$ is less than the significance level, meaning that correlation is different than 0. The data below depicts the variable intercept values along the plots fitted line, which are used for the informational typical runs:

Military	System Stability
1.00	1.00
0.64	0.93
0.49	0.87
0.43	0.80
0.28	0.73
0.16	0.67
0.06	0.60
0.46	0.13

4.3.1.1 Hypothesis 2 – ForPol SD Typical Run Reference Mode Military

(1) ForPol SD Typical Runs. Table 21 depicts calibrated parameter values, which served as inputs for two typical runs of informational policy choices. The table's far left, outlines a state-actor associated with a political event or decisional act, followed by the day and month of occurrence. The table's center, outlines the event stock parameter values, which are representative of the correlation analysis. The table's far right lists the vents used for each of the typical runs.

Table 21 – Military Policy Typical Runs

State-Actor/Stock(s)	Mo	Day	Activity	Pol Type	Stock Parameter(s)				Typical Run#
					Poli_Event	Pol_Choice	Other_Govt_Policy_Choice	Sys_Stab	
EGY	5	28	ACROSS GAZA BORDER KILL 2 ISR	M	0.64	0.00	0.00	0.93	1
SYR	6	2	SOLDIERS IN CLASH	M	0.00	0.49	0.00	0.87	1
ISR	6	5	ATTACK GAZA TRAIL GUIDED MISSILE DESTROYER 381-AMERICA	M	0.00	0.00	1.00	1.00	1
RUS	6	5	REFUSE TO PERMIT UNEF STATIONED IN ISR	M	0.28	0.00	0.00	0.73	2
EGY	5	18	REQUEST UN WITHDRAW EMERGENCY FORCE SEPARATING TROOPS	M	0.00	0.06	0.00	0.60	2
IRQ	5	23	DECIDE UNITE MILITARY-POLITICAL-ECON FORCES REACT UNFAVORABLY TO UAR	M	0.00	0.00	0.46	0.13	2
UKG	5	23	CLOSING OF STRAITS OF TIRAN	M	0.00	0.00	0.16	0.67	2

D = Diplomatic I = Informational M = Military E = Economic

The reference mode that follows (figure 27), show the results from the first military policy typical run, using the input parameters tabulated in chapter 3, section 2 and table 21. The reference modes depict numbers on the “y” axis, which represent the minimum and maximum for each of the variables observed and numbers on the “x” axis, which represent variable performance over time in unit days. The values on the “y” axis have been rescaled between 0 and 1 for plotting purposes. The blue line represents the

political salience variable; the red line represents the system stability variable; the green line represents the social stress variable and the gray line represents the policy choice variable.

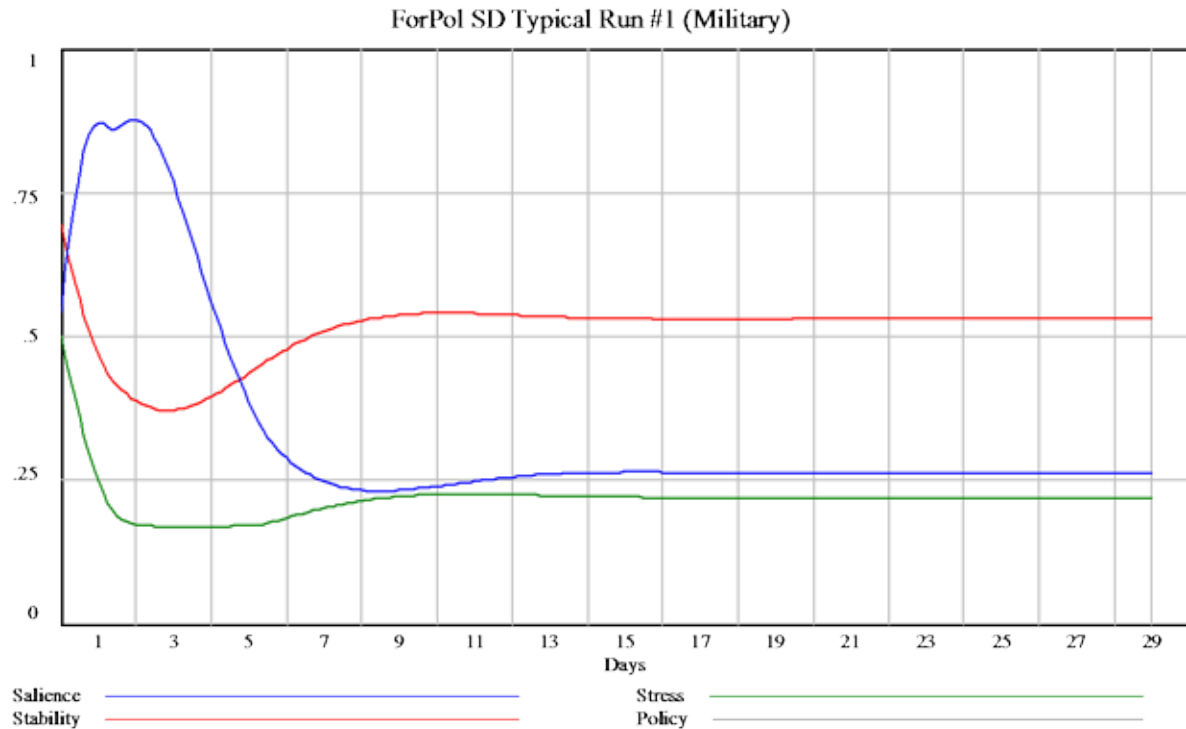

Figure 27 – ForPol Sim SD Typical Run #1 (Military)

The reference mode in figure 27 shows how the military policy choice (gray line) affects system stability (red line), political event salience (blue line) and social stress (green) line. The political salience for the events on table 21, typical run one, seem to gradually escalate to a maximum, while simultaneously system stability decreases to its minimum, both converging at a value of 0.41 on day five. Then, both curves invert on day six, with the highest curve for system stability at a value of 0.44, progressing at a constant rate of 0.53 thereafter. Salience yielded the second highest curve at a value of

0.39, decreasing to a 0.25 thereafter. The third and lowest curve was for social stress, which displays a decrease to a value of 0.17 around day 3, then spikes to a value of 0.22 remaining constant thereafter. The effects of policy which are at its highest of 1.00, remain consistent across time. This run seems to behave according to stability and state-actor principles (Choucri et al., 2006; Claudio Cioffi-Revilla, 2009). The state-actor policy choice, overcomes the event salience, therefore increasing stability and decreasing social stress.

The reference mode that follows, show the results from the second military policy typical run, using the input parameters tabulated in chapter 3, section 2 and table 21. The reference modes depict numbers on the “y” axis, which represent the minimum and maximum for each of the variables observed and numbers on the “x” axis, which represent variable performance over time in unit days. The values on the “y” axis have been rescaled between 0 and 1 for plotting purposes. The blue line represents the political salience variable; the red line represents the system stability variable; the green line represents the social stress variable and the gray line represents the policy choice variable.

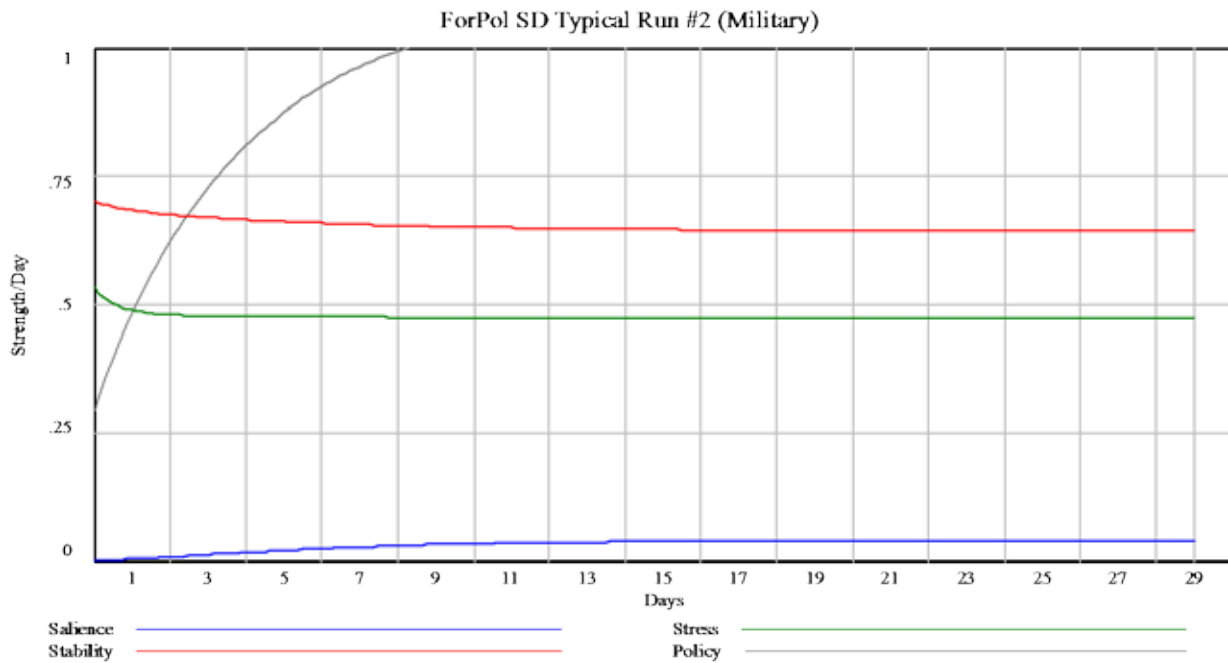

Figure 28 – ForPol Sim SD Typical Run #2 (Military)

The reference mode in figure 28 shows how the military policy choice (gray line) affects system stability (red line), political event salience (blue line) and social stress (green) line. The policy choice effectiveness gradually escalates over time to a value of 0.57 by day one after event occurrence to a maximum value of 1.00 by day 8. Therefore, policy effectiveness has a positive effect on event salience curving it to a minimal value of 0.06, which remains constant thereafter. Furthermore, policy effectiveness also has a positive effect on system stability and social stress with consistent values five of 0.67 and 0.48 respectively. Similarity to run one, this run seems to behave per stability and state-actor principles (Choucri et al., 2006; Claudio Cioffi-Revilla, 2009). The state-actor policy choice, overcomes the event salience, therefore increasing stability and decreasing social stress.

4.4 Diplomatic Policy Choice

4.4.1 Hypothesis 3 – Correlation Results for Diplomatic Policy Choice

(1) Results. The Pearson's Product-Moment correlation analysis demonstrate that the two variables, diplomatic policy and system stability were strongly correlated: $t = 8.9141$, $r(187) = 0.5460865$, $p = 4.398e-16$.

(2) H_A is true, correlation does not equal 0, hence, diplomatic policy choices correlate to system stability within a 95% confidence interval of 0.4374526 and 0.6390104.

(3) H_0 is rejected.

The scatter plot below depicts the numbers on the “y” axis, which represent the minimum and maximum for the diplomatic policy choice variable and numbers on the “x” axis, which also represent the minimum and maximum for the stability variable. The values have been rescaled between 0 and 1 for plotting purposes. The green fitted line that runs through the points shows a moderate relationship between the stability (response) and the policy variable based on clustering of plots along the line. The graph shows a strong positive correlation between diplomatic policy choices and system stability values, with a correlation coefficient of 0.5. This means that as the value for the diplomatic policy variable increases so does the value system stability variable.

Diplomatic Policy Scatter Plot

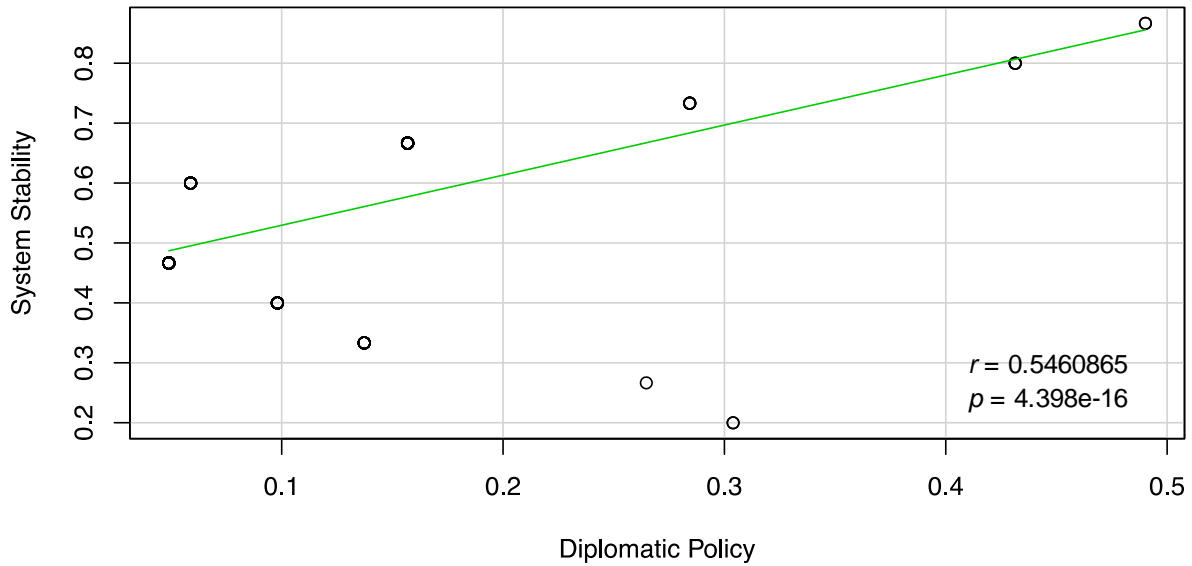

Figure 29– Diplomatic Policy Scatter Plot

However, the resulting p-value will tell us if correlation between the variables truly exists, which will show if the correlation coefficient is significantly different from zero. As figure 29 depicts the $p = 4.398e-16$, less than the significance level, meaning that correlation is different than 0. The data below depicts the variable intercept values along the plots fitted line, which are used for the informational typical runs:

Diplomatic	System Stability
0.49	0.86
0.43	0.80
0.28	0.73
0.16	0.67
0.14	0.33
0.10	0.40
0.06	0.60
0.05	0.47

4.4.1.1 Hypothesis 3 – ForPol SD Typical Run Reference Mode Diplomatic

Table 22 Diplomatic Policy Typical Runs

State-Actor/ Stock(s)	Mo	Day	Political Event Decisional Act	Pol Type	Stock Parameter(s)				Typical Run#
					Poli_ Event	Pol_ Choice	Other_Govt_ Policy_Choice	Sys_ Stab	
ISR	5	18	U THANT + UN REPRESENTATIVE	D	0.05	0.00	0.00	0.47	1
EGY	5	23	REJECT LBJ 5 POINT PEACE PLAN	D	0.00	0.06	0.00	0.60	1
US	5	28	UN RESOLUTION ON MIE	D	0.00	0.00	0.10	0.40	1
UKG	6	2	LBJ + WILSON MEET ON AQABA BLOCKADE	D	0.00	0.00	0.14	0.33	1
ISR	5	9	BORDER RAIDS NORTH OF AMMIAD	D	0.49	0.00	0.00	0.87	2
ISR	5	13	ESHKOL- FORCED TO TAKE RETALIATORY MEASURES	D	0.00	0.16	0.00	0.67	2
EGY	5	28	ATTEMPT STOP IRN OIL SUPPLIES TO ISR	D	0.00	0.00	0.28	0.73	2
SYR	6	5	SEND TROOPS TO UAR	D	0.00	0.00	0.43	0.80	2

D = Diplomatic I = Informational M = Military E = Economic

The reference mode that follows (figure 30), show the results from the first diplomatic policy typical run, using the input parameters tabulated in chapter 3, section 2 and table 22. The reference mode depicts numbers on the “y” axis, which represent the minimum and maximum for each of the variables observed and numbers on the “x” axis, which represent variable performance over time in unit days. The values on the “y” axis have been rescaled between 0 and 1 for plotting purposes. The blue line

represents the political salience variable; the red line represents the system stability variable; the green line represents the social stress variable and the gray line represents the policy choice variable.

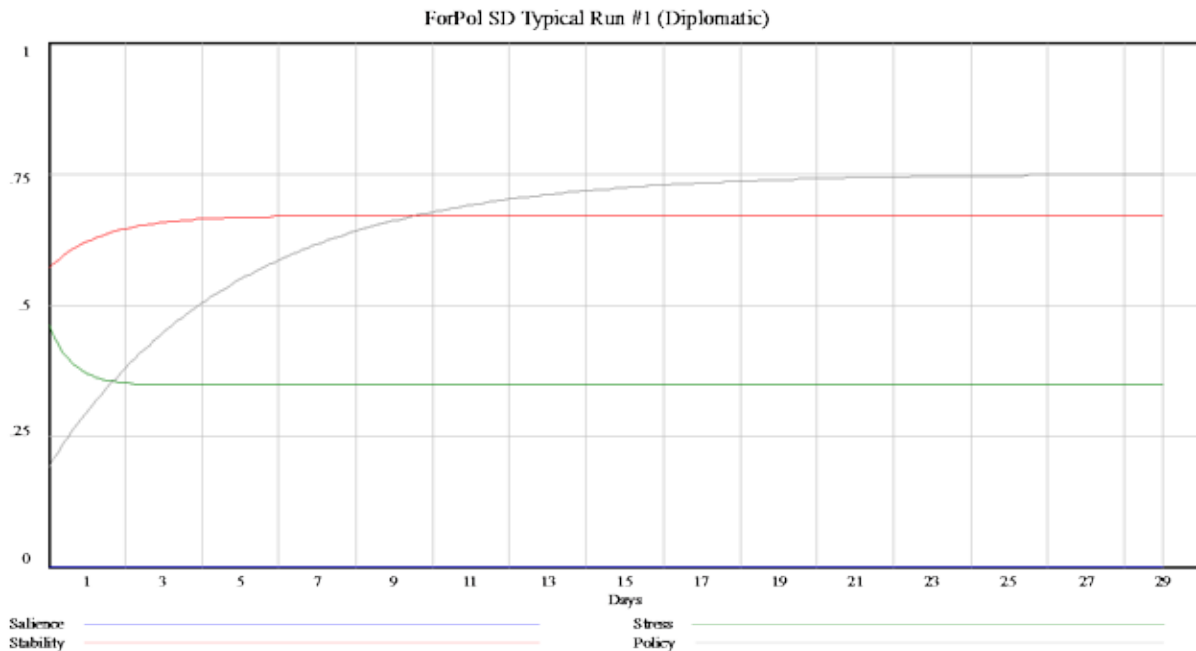

Figure 30 – ForPol Sim SD Typical Run #1 (Diplomatic)

The reference mode in figure 30 shows how the diplomatic policy choice (gray line) affects system stability (red line), political event salience (blue line) and social stress (green) line. The policy choice effectiveness gradually escalates over time to a value of 0.50 by day four after event occurrence to a maximum value of 0.74 by day 13 remaining constant thereafter. Therefore, policy effectiveness had a positive effect on event salience curving it to minimal value of almost 0.03, which remains constant thereafter. Furthermore, policy effectiveness also has a positive effect on system stability and social stress with consistent values of 0.35 after day 3 and 0.67 after day 5

respectively. This diplomatic run seems to behave per stability and state-actor principles (Choucri et al., 2006; Claudio Cioffi-Revilla, 2009). The state-actor policy choice, overcomes the event salience, therefore increasing stability and decreasing social stress. Additionally, per the COPDAB these values seem to be on the cooperative side of the scale (Azar, 1984).

The reference mode that follows (figure 31), show the results from the second diplomatic policy typical run, using the input parameters tabulated in chapter 3, section 2 and table 22. The reference mode depicts numbers on the “y” axis, which represent the minimum and maximum for each of the variables observed and numbers on the “x” axis, which represent variable performance over time in unit days. The values on the “y” axis have been rescaled between 0 and 1 for plotting purposes. The blue line represents the political salience variable; the red line represents the system stability variable; the green line represents the social stress variable and the gray line represents the policy choice variable.

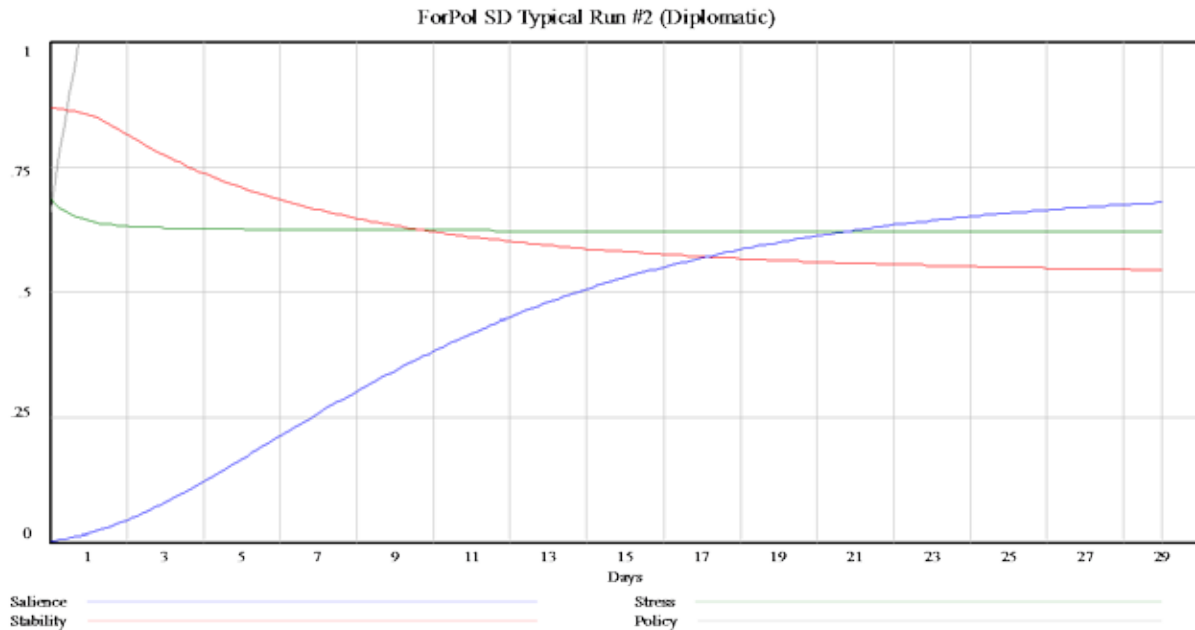

Figure 31 – ForPol Sim SD Typical Run #2 (Diplomatic)

The reference mode in figure 31 shows how the military policy choice (gray line) affects system stability (red line), political event salience (blue line) and social stress (green) line. The policy choice effectiveness gradually escalates over time from a value of 0.66 to a value of 1.00 on day one after event occurrence. In this case, the policy seems ineffective and has a negative effect on event salience causing it to gradually increase over time to 0.25 by day 7, intersecting with system stability at 0.53. Simultaneously, stability decreases from a 0.87 to a 0.53 where it intersects with the system event salience curve, at which point both curves invert and stability continues the decrease and salience on the increase. Alternatively, social stress slightly degrades to a constant value of 0.63 thereafter, as salience spikes and system stability deteriorates. Once more, this run seems to behave per stability and state-actor principles (Choucri et al., 2006; Claudio Cioffi-Revilla, 2009). The state-actor policy

choice, could not overcome the event salience, therefore degrading stability and increasing social stress.

4.5 Economic Policy Choice

4.5.1 Hypothesis 4 – Correlation Results for Economic Policy Choices

(1) Results. The Pearson's product-moment correlation analysis demonstrate that the two variables, economic policy and system stability were strongly correlated: $t = 0.93963$, $r(23) = 0.1922712$, $p = 0.3572$.

(2) H_A is true, correlation does not equal 0, hence, economic policy choices correlate to system stability within a 95% confidence interval of -0.2195386 and 0.5459268.

(3) H_0 is rejected.

The below scatter plot (figure 32) depicts numbers on the “y” axis, which represent the minimum and maximum for the economic policy choice variable and numbers on the “x” axis, which also represent the minimum and maximum for the system stability variable. The values have been rescaled between 0 and 1 for plotting purposes. The green fitted line that runs through the points shows a moderate relationship between the stability (response) and the policy variable based on clustering of plots along the line. The graph shows a low positive correlation between economic policy choices and system stability values, with a correlation coefficient of about 0.2.

The correlation coefficient of variance shows that as the value for economic policy variable increases so does the value for the system stability variable.

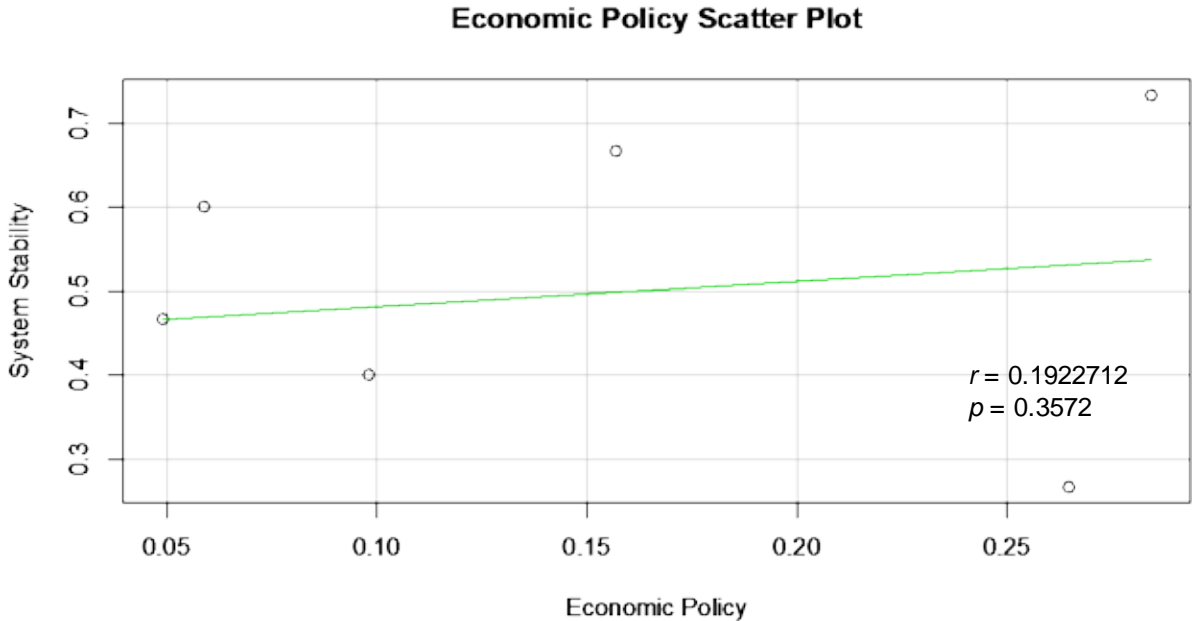

Figure 32 – Economic Policy Scatter Plot

However, the resulting p-value will tell us if correlation between the variables truly exists, which will show if the correlation coefficient is significantly different from zero. As figure 32 depicts the $p = 0.3572$, more than the significance level, meaning that correlation is different than 0, but it's is not statistically significant to establish correlation. The data below depicts the variable intercept values along the plots fitted line, which are used for the informational typical runs:

Diplomatic	System Stability
0.28	0.73
0.26	0.27
0.16	0.67
0.10	0.40
0.06	0.60
0.05	0.47

4.5.1.1 Hypotheses 4 – ForPol SD Typical Run Reference Mode Economic

Table 23 – Economic Policy Choice Typical Runs

State-Actor/ Stock(s)	Mo	Day	Political Event Decisional Act	Pol Type	Stock Parameter(s)				Typical Run#
					Poli_Event	Pol_Choice	Other_Govt_Policy_Choice	Sys_Stab	
US	5	28	THAT USAMAINAIN IMPORTS-IF REFRAIN ACTION	E	0.05	0.00	0.00	0.47	1
ISR	6	4	TO FLOAT LOANS HOME AND ABROAD	E	0.00	0.06	0.00	0.60	1
EGY	6	4	WITH 7 ARAB STATE TO STOP OIL TO USA & UNK	E	0.00	0.00	0.10	0.40	1
IRQ	6	4	WITH SEVEN ARAB STATES TO STOP OIL TO US + UNK	E	0.00	0.00	0.28	0.73	1
UKG	5	12	INCREASE ANNUAL LOAN LL100,000 FOR PROJECTS	E	0.26	0.00	0.00	0.27	2
EGY	5	23	IRN-SHIPS CARRYING IRN OIL TO ISR-NOT ALLOWED	E	0.00	0.16	0.00	0.67	2
US	5	24	SEAMEN REFUSE CARRY CARGO TO UAR BECAUSE OF BLOCKADE	E	0.00	0.00	0.28	0.73	2
FRN	6	2	ON OPENING AQABI GULF TO INTERNATIONAL TRADE	E	0.00	0.00	0.06	0.60	2
D = Diplomatic			I = Informational		M = Military			E = Economic	

The reference mode that follows (figure 33), show the results from the first economic policy typical run, using the input parameters tabulated in chapter 3, section 2 and table 23. The reference mode depicts numbers on the “y” axis, which represent the minimum and maximum for each of the variables observed and numbers on the “x” axis, which represent variable performance over time in unit days. The values on the “y” axis have been rescaled between 0 and 1 for plotting purposes. The blue line represents the political salience variable; the red line represents the system stability variable; the green line represents the social stress variable and the gray line represents the policy choice variable.

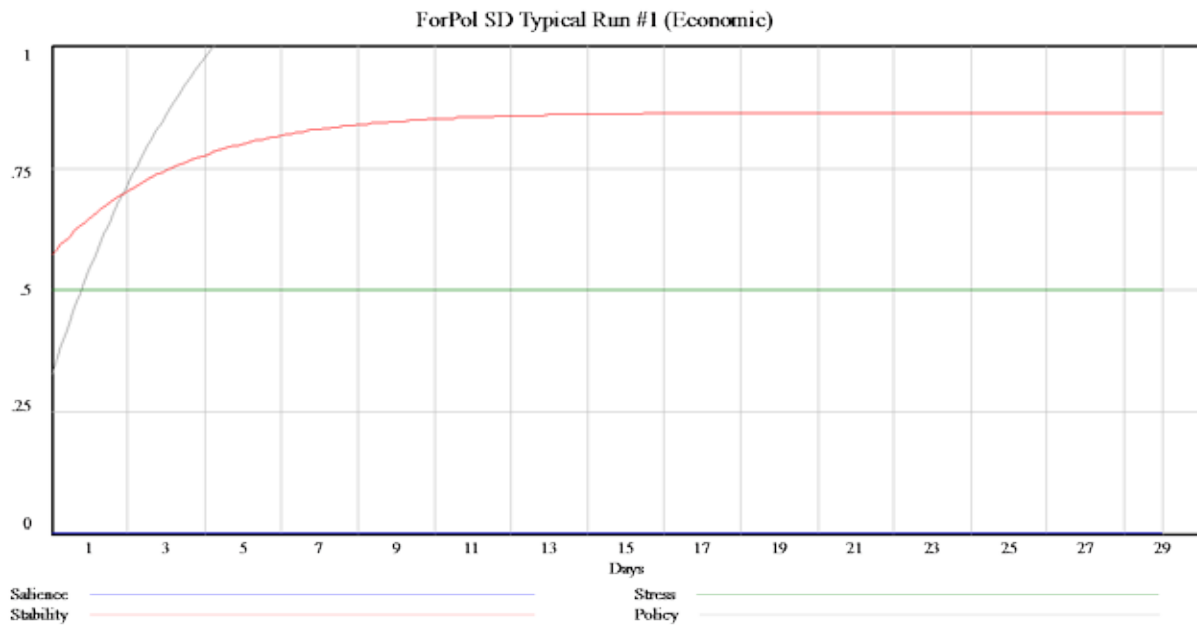

Figure 33– ForPol Sim SD Typical Run #1 (Economic)

The reference mode in figure 33 shows how the diplomatic policy choice (gray line) affects system stability (red line), political event salience (blue line) and social

stress (green) line. The policy choice effectiveness gradually escalates over time to a value of 0.74 by day one after event occurrence to a maximum value of 1.00 by day 5. Therefore, policy effectiveness had a positive effect on event salience curving it to minimal value of almost 0.07, which remains constant thereafter. Furthermore, policy effectiveness also has a positive effect on system stability, with a gradual increase from 0.65 to a constant of 0.85 after day 8. Additionally, social stress remains at a constant value of 0.50. This economic run seems to behave per stability and state-actor principles (Choucri et al., 2006; Claudio Cioffi-Revilla, 2009). The state-actor policy choice, overcomes the event salience, therefore increasing stability and maintaining social stress constant. Additionally, per the COPDAB these values seem to be on the cooperative side of the scale (Azar, 1984).

The reference mode that follows (figure 34), show the results from the second economic policy typical run, using the input parameters tabulated in chapter 3, section 2 and table 23. The reference mode depicts numbers on the “y” axis, which represent the minimum and maximum for each of the variables observed and numbers on the “x” axis, which represent variable performance over time in unit days. The values on the “y” axis have been rescaled between 0 and 1 for plotting purposes. The blue line represents the political salience variable; the red line represents the system stability variable; the green line represents the social stress variable and the gray line represents the policy choice variable.

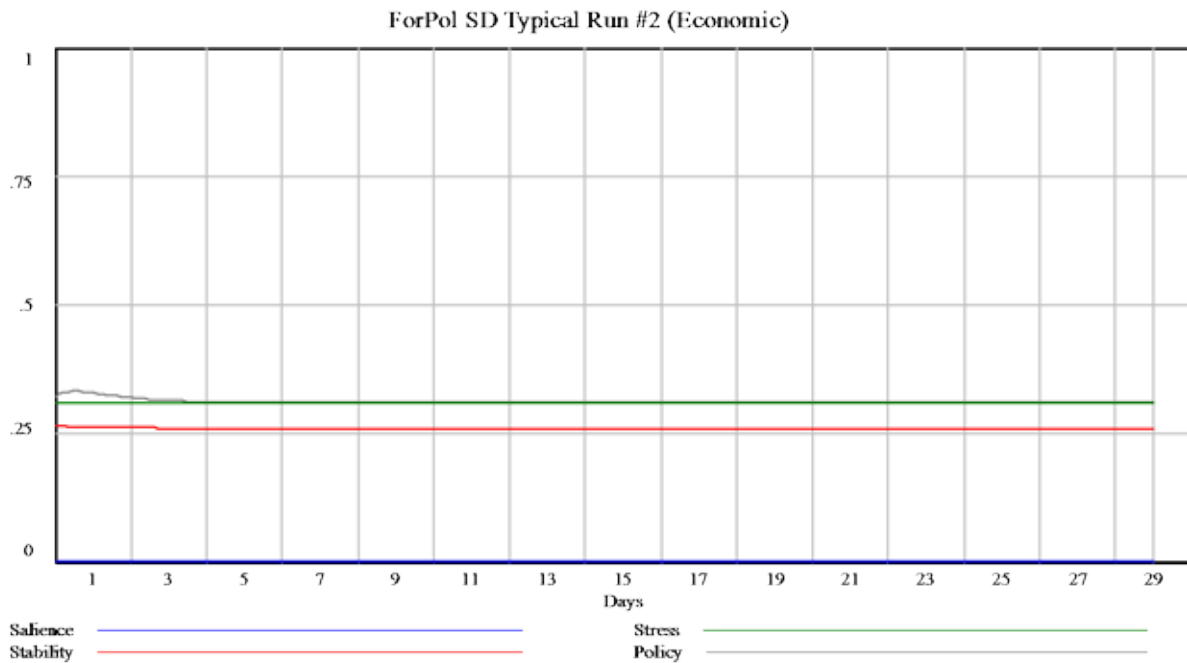

Figure 34 – ForPol Sim SD Typical Run #2 (Economic)

The reference mode in figure 34 shows how the economic policy choice (gray line) affects system stability (red line), political event salience (blue line) and social stress (green) line. This reference mode displays a flat pattern, without spikes or changes in value. Consequently, the policy choice effectiveness remains consistent above all variables with a value of 0.31 and overlaid on social stress with the same value of 0.31, followed by system stability with a consistent value of 0.26, followed by event salience with a value of 0.07. Policy effectiveness also has a positive effect by sustaining system stability and significantly lowering event salience to almost 0. However, social stress is not changing to the effects of policy. This economic run seems to behave per stability principles but not state-actor principles (Choucri et al., 2006; Claudio Cioffi-Revilla, 2009). The state-actor policy choice, overcomes the event

salience, therefore increasing stability but social stress does not decrease. Additionally, per the COPDAB these values seem to be on the cooperative side of the scale (Azar, 1984).

CHAPTER 5: CONCLUSION

This chapter summarizes the purpose, research achievements and limitations. Additionally, results and significance are discussed including gaps and future work.

5.1 Summary

This thesis focused on calibrating input parameter for a SD model called ForPol by correlating select data from the 1967 Arab-Israeli Six-Day War (Azar, 1984) to examine the relationship between the response variable, system stability and four types of policy choices: diplomatic, information, military and economic. Several input sources exist, however the ICPSR COPDAB was selected for input parameter calibration. Furthermore, the correlation analysis output was used as parameter inputs to run the Vensim SD ForPol model to understand if the model behaved in a typical way: per system-stability and state-actor behavior principles (Choucri et al., 2006; Claudio Cioffi-Revilla, 2009).

However, these important steps are the first for a future research agenda, which tests, verifies and validates an integrative framework for a hybrid SD/AB/IR simulation for the analysis, testing and application of foreign policy. The AB extension of this integrated framework is informed by the work of Claudio Cioffi-Revilla, Edward P. MacKerrow, David L. Rousseau, Joshua M. Epstein, and Robert Axtell.

Although, the ForPol SD model applies a SD approach for the modeling of macro-political aggregate behavior, it was not developed in a vacuum, since it applies

Alexander Y. Lubyansky's SD model of political behavior, which represent behaviors between political systems and mental models. Interactions within the ForPol SD model actualize Choucrist, et al., (2006), definition of state stability and agent behavior aspects of Cioffi-Revilla's SimPol polity model (2009).

Furthermore, ForPol accounts for the salience of political events, social stress and policy choices, by combining these in three causality loops, which represent the ForPol macro-political behavior. The stability loop was informed by the work of Choucrist et al., (2006), which explains the propensity towards conflict in terms of a state-actor's capability to overcome the weight of a political event. If the state-actor can overcome the weight within its capabilities, stability is maintained, if not the system is unstable. The social stress and political event loops are informed after, Cioffi-Revilla's (2009) SimPol polity model, which explains state actor behavior as a function of stress and societies demand for political action.

5.2 Discussion

5.2.1 ForPol SD Input Parameter Calibration and Model Behavior

The hypotheses in this study focused on the relationship between two variables: policy choices and system stability. Therefore, a correlation analyses was conducted on the input parameters to understand if significant correlation existed between diplomatic, informational, military and economic policy choices with system stability. The results on chapter 4 demonstrate that correlation does exist. The resulting input parameter

calibration was used to run ForPol SD model and observe if it behaved in a typical way: if the weight of a policy choice can overcome the political event salience, stability increases or is sustained; conversely, if the weight of the policy choice cannot overcome the political event salience stability decreases (Choucri et al., 2006). The reference modes are used as observational reference points, without any predictive reference or claims of truth, since verification and validation were not the scope of the thesis.

Therefore, as a takeaway, figure 35 summarizes into one reference mode the resulting eight typical runs conducted in chapter 4. The reference mode depicts numbers on the “y” axis, which represents the minimum and maximum for each of the variables observed and numbers on the “x” axis, which represent variable performance over time in day units. The values on the “y” axis have been rescaled between 0 and 1 for plotting purposes. The curves represent the system stability response over time for each policy type. The turquoise blue and orange curves represent informational policy typical runs; the gray and yellow lines represent informational policy typical runs; the baby blue and green line represent military policy typical runs; the navy blue and brown curves represent economic policy typical runs.

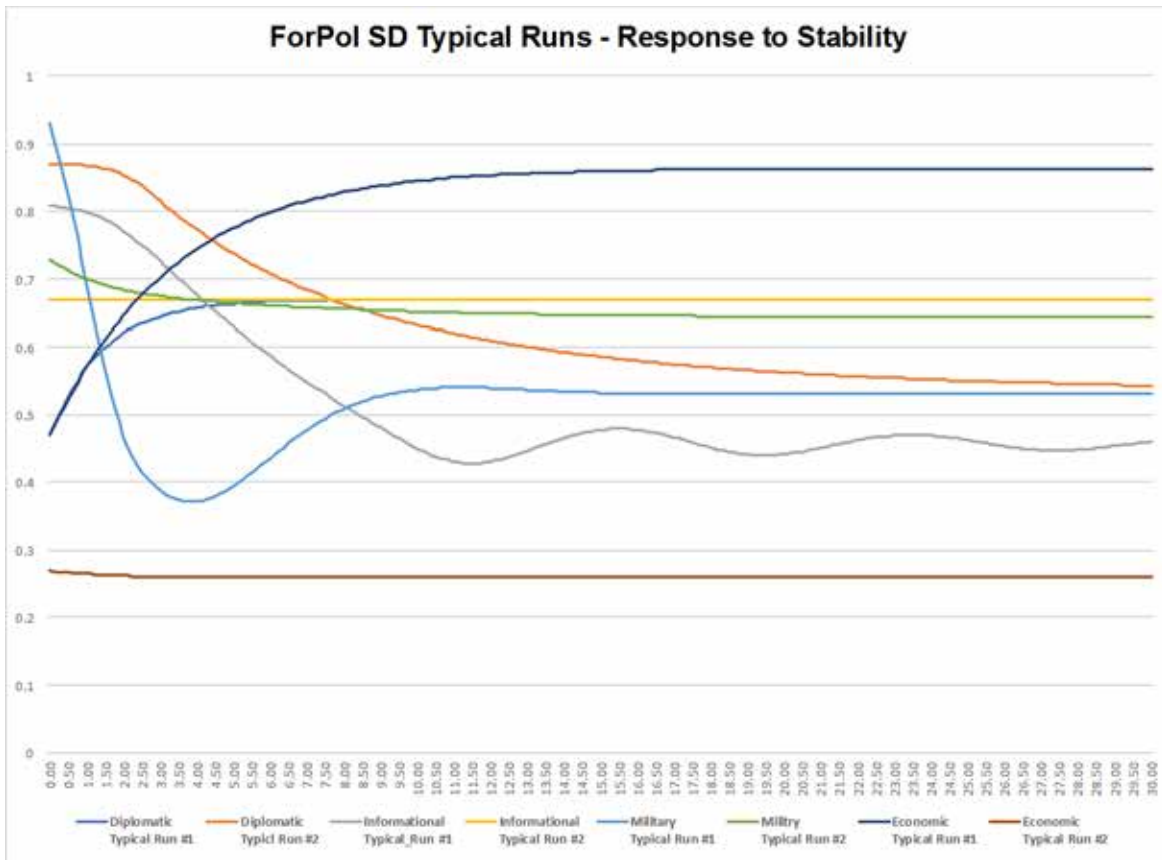

Figure 35 – ForPol SD Behavior – Policy Response to System Stability

This graph's story in figure 35 is telling, because it shows consistency with the 1967 Arab-Israeli Six-Day War COPDAB parameter inputs. For example, starting with the stability values for the events in table 21, the diplomatic typical run 1 curve (turquoise) seems to have a positive effect by increasing stability or cooperativeness (Azar, 1984). Alternatively, the diplomatic typical run 2 curve (orange), seems to have a negative effect on system stability by degrading over time, which is also consistent with the COPDAB, because diplomatic hostile events tend to be conflictive. Continuing with the values on table 20, the informational typical run 1 curve (gray) has a negative effect on system stability degrading overtime because they tend to be events of strong verbal

expressions of hostility (Azar, 1984). Alternatively, the informational type run 2 (yellow) has a positive effect increasing but maintaining a flat pattern of stability. Continuing with the values on table 21. The military typical run 1 curve (baby blue) has a negative effect on system stability by decreasing over time. This behavior continues to be consistent with the input parameters and displays a pattern of conflict (Azar). Alternatively, the military typical run 2 curve (green) has a positive effect by increasing stability and maintaining it. This behavior seems to be consistent with input parameters and displays a pattern of cooperativeness (1984). Finally, continuing with values in table 23, the economic policy run 1 curve (navy blue) by far has the greatest effect on system stability by increasing system stability over time, which seem to be cooperative events of economic support (1984). Economic policy run 2 curve (brown) seems to have the worst effect on system stability remaining constant over time. The behavior seems to be consistent with input parameters which display a conflictive pattern (1984).

5.3 Achievements

This thesis paves the foundation for a SD/AB/IR integrated framework for the study of political behavior and application of foreign policy. The thesis specifically archives the following:

- (1) Correlated the ICPSR COPDAB 1967 Arab-Israeli War input parameters.
- (2) Calibrated ForPol SD model input parameters by conducting typical runs.
- (3) Produced system behavior reference modes to draw observations, which explain system stability.

- (4) Laid the foundation for a state-actor AB model (Appendix D and C).
- (5) Presented a way to verify and validate the proposed integrative framework.
- (6) A comprehensive literature review, which exposes gaps in political science M&S and reveals existing model M&S.

5.4 Limitations

This thesis does not implement the proposed AB model for two main reasons. First, modeling AB macro-political behavior, must go beyond a conceptual outline as exposed in this thesis. The research and resources required expand beyond the scope and time limits of this project. Second, integrating the proposed AB model, cannot be done alone, a team of interdisciplinary members would be required, to garner stakeholder and human system integration requirements and see the development and implementation throughout its lifecycle.

The next limitation encountered was the inaccuracy and age of the COPDAB data set, which is why input parameter calibration was required. Some of the sources used to develop the data were news reports and media outlets dated back to the 1967 period, which inherently induces inaccuracy and bias into production of the data. The data is also left to interpretation and alteration. The author, leaves it to the user to interpret or alter as necessary. Another, challenge with the data is that the events were coded in qualitative short phrases, which many lacked context, making it difficult to differentiate and even understand its importance. A significant limitation with calibrating input parameters is discriminating data, because not all data matters or is need.

However, what data will, can or must be used as input parameters, to create the most realist scenario or system behavior. For example, an input parameter, which is selected over another may trigger the model to behave differently from the real system, leading to erroneous or false outputs.

The final limitation, was that the work focused mainly on calibrating the model's system stability causality loop. However, to gain a comprehensive understanding of the true dynamic relationships among the three causality loops, further calibration is required for the social stress loop and policy choice loop. For example, conducting correlation analysis between political salience and social stress and policy choice and social stress. Additionally, more research should be done to find existing models for measuring the proposed causal loops. For example, what are the existing measures for social stress as a function of political action? Cioffi-Revilla defines social stress as an attribute of a state, however, does not provide a measure, other than it is a function of a political event.

5.5 Future Work

This thesis makes the case for selecting and calibrating input parameters for a SD model called ForPol as the first steps carried forward into the process of verifying and validating an integrative SD/AB/IR hybrid framework that can test policy choices and predict outcomes. A way to integrate these components was initially described in chapter one of this thesis. However, future work should be focused in these two areas throughout the system's life-cycle to implementation (Balci, 2013).

Therefore, RG Sargent in his work *Verification and Validation of Simulation Models* (2013) suggests various verification and validation (V&V) methods, which can be implemented as an extension to this work. For example to achieve verification one can implement a “dynamic testing” method (Sargent, 2012, p.18), which consists in running the SD model under different scenarios and analyzing the output values to determine if the simulation was implemented correctly. ForPol was executed in a similar way, however the study did not focus on verification. Therefore, ForPol should be extended to include trace testing, data accuracy analysis and comparative analysis of system input-output, to determine if the SD model requires further fine-tuning (Sargent, 2012).

RG Sargent (2012) also recommends two validation techniques, which can be extended to ForPol called “parameter variability-sensitivity analysis” (Sargent, 2012, p.17) and “Predictive Validation” (Sargent, 2012, p.17). The first validation method is like the input parameter calibration method, in that it adjusts the model’s input parameter values to determine which ones have the greatest effects in the model, hence calibrating these to determine if the model and system behave similarly. Nevertheless, this last part is how ForPol should be validated, by comparing the selected empirical input parameters with the SD model output. The second validation method that could be used is “Predictive Validation” (Sargent, 2012, p.17), which consists in predicting how the real system will behave by comparing system behavior with the models predictions to determine if they also behave in a similar way. This validation technique applies to the life-cycle of experimental models such as ForPol,

specifically the major areas of implementation, application and acceptability (Balci, 2013).

Finally, as presented in the literature review, there are many venues that can be used to explain political behavior, SD is just one of them. However, SD is rarely used for the study of macro-political behavior. Consequently, there is room to pursue a hybrid approach, for a complete understanding of political behavior. An extension to this work would be integrating AB modeling at the micro-political level of analysis. Several AB exist that are used to explain social phenomena and political theory but most lack predictive capability (Bhavnani et al., 2008; C Cioffi-Revilla & Rouleau, 2009; Claudio Cioffi-Revilla, 2009; Claudio Cioffi-Revilla & Rouleau, 2010; MacKerrow, 2003). Therefore, part of this integrative process would be developing models which can provide some predictive output. Appendix D depicts a NetLogo interface in its infant stage as a prototype AB model and Appendix E lists the NetLogo code.

APPENDIX A: COPDAB 1967 ARAB-ISRAELI SIX-DAY WAR

Table 24 – 1967 Arab-Israeli Six-Day War Monthly Event Frequency

Month	ISR	EGY	SYR	JOR	LEB	PLO	TUR	IRQ	IRN	YAR	PAK	US	UKG	RUS	FRN	CHN	All Months
Jan	55	17	31	13	3	5	7	15	4	8	2	27	26	26	13	11	263
Feb	14	16	22	12	2	7	3	14	4	1	2	19	15	41	6	23	201
Mar	14	13	10	4	4	6	0	8	5	3	9	14	6	13	2	17	128
Apr	18	15	26	13	6	0	8	10	5	7	12	27	19	25	8	5	204
May	46	83	39	23	8	17	4	27	5	11	5	44	37	36	18	16	419
Jun	90	69	55	20	14	2	3	27	1	2	5	31	21	26	12	6	384
All Months	237	213	183	85	37	37	25	101	24	32	35	162	124	167	59	78	1,599

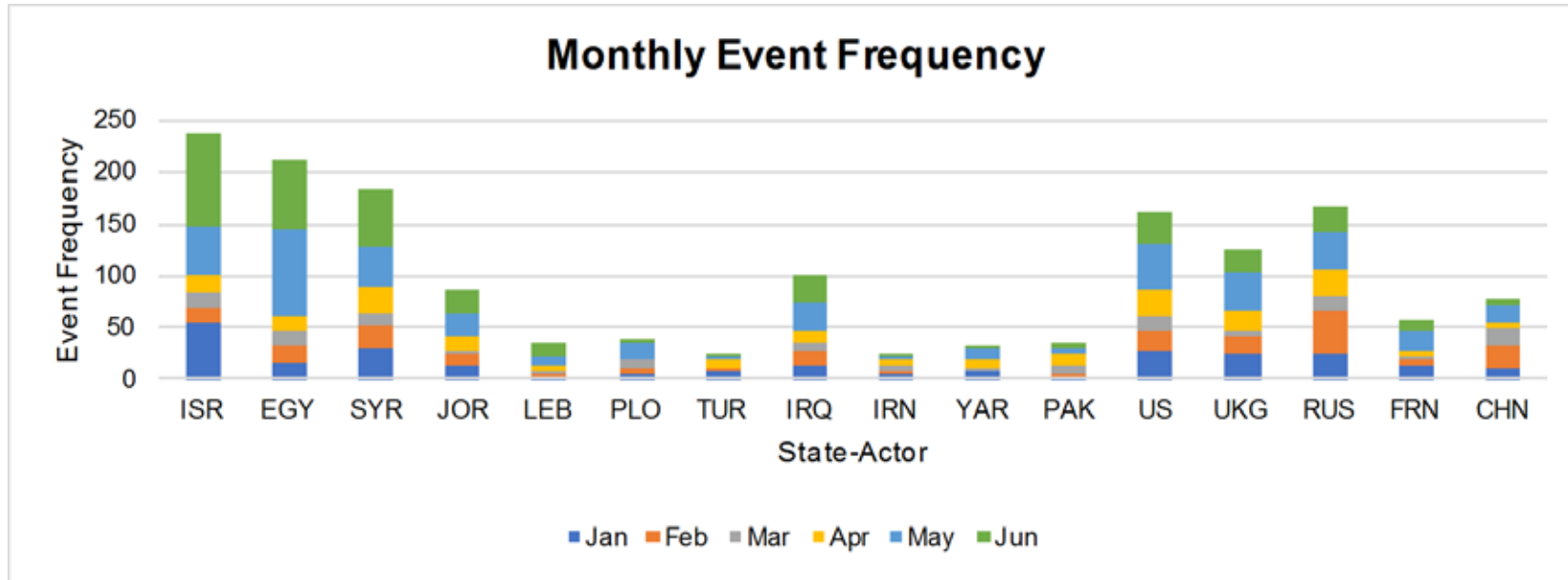

Figure 36 – COPDAB International Event Frequency

Table 25 – 1967 Arab-Israeli Six-Day War Policy Distribution

Policy	ISR	EGY	SYR	JOR	LEB	PLO	TUR	IRQ	IRN	YAR	PAK	US	UKG	RUS	FRN	CHN	All Months
Diplomatic	70	96	106	30	19	10	12	35	7	17	22	77	65	119	25	49	759
Informational	15	10	14	5	0	2	2	8	2	1	2	12	6	18	4	9	110
Military	149	88	55	38	10	25	2	27	2	9	2	43	29	12	9	15	515
Economic	3	19	8	12	8	0	9	31	13	5	9	30	24	18	21	5	215
All Months	237	213	183	85	37	37	25	101	24	32	35	162	124	167	59	78	1,599

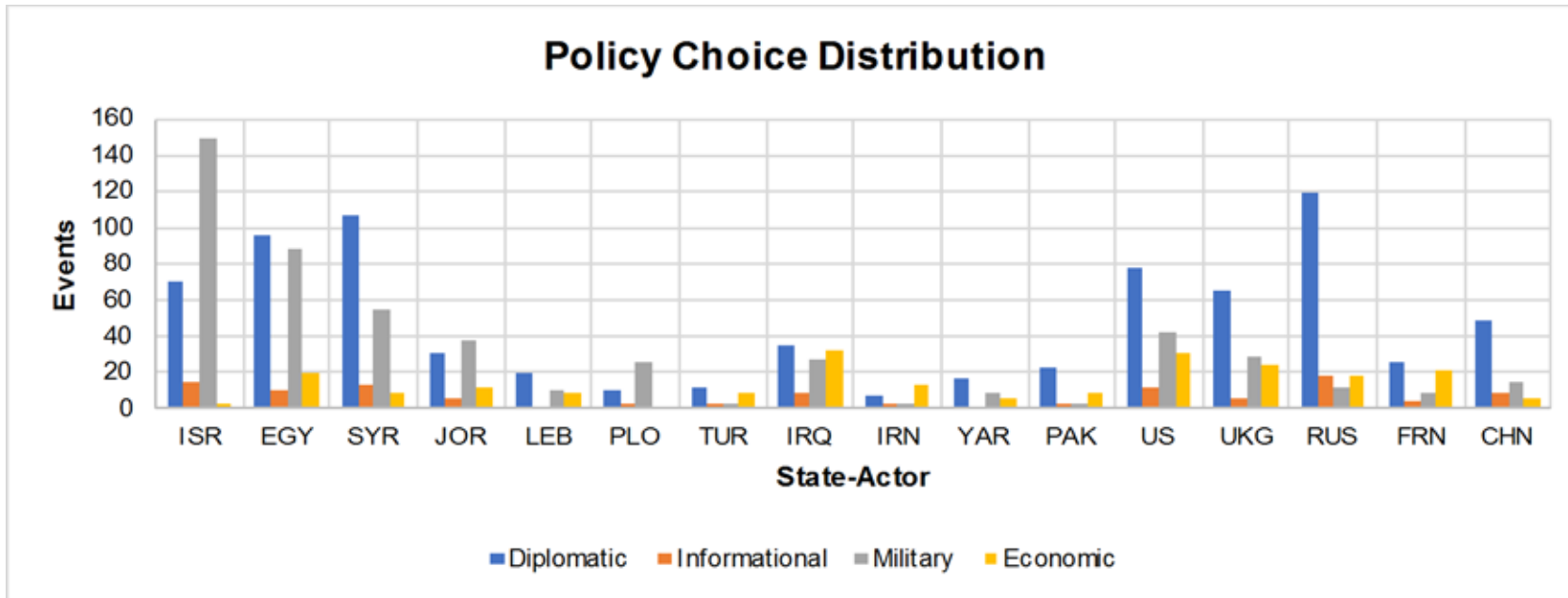

Figure 37 – COPDAB International Event Policy Distribution

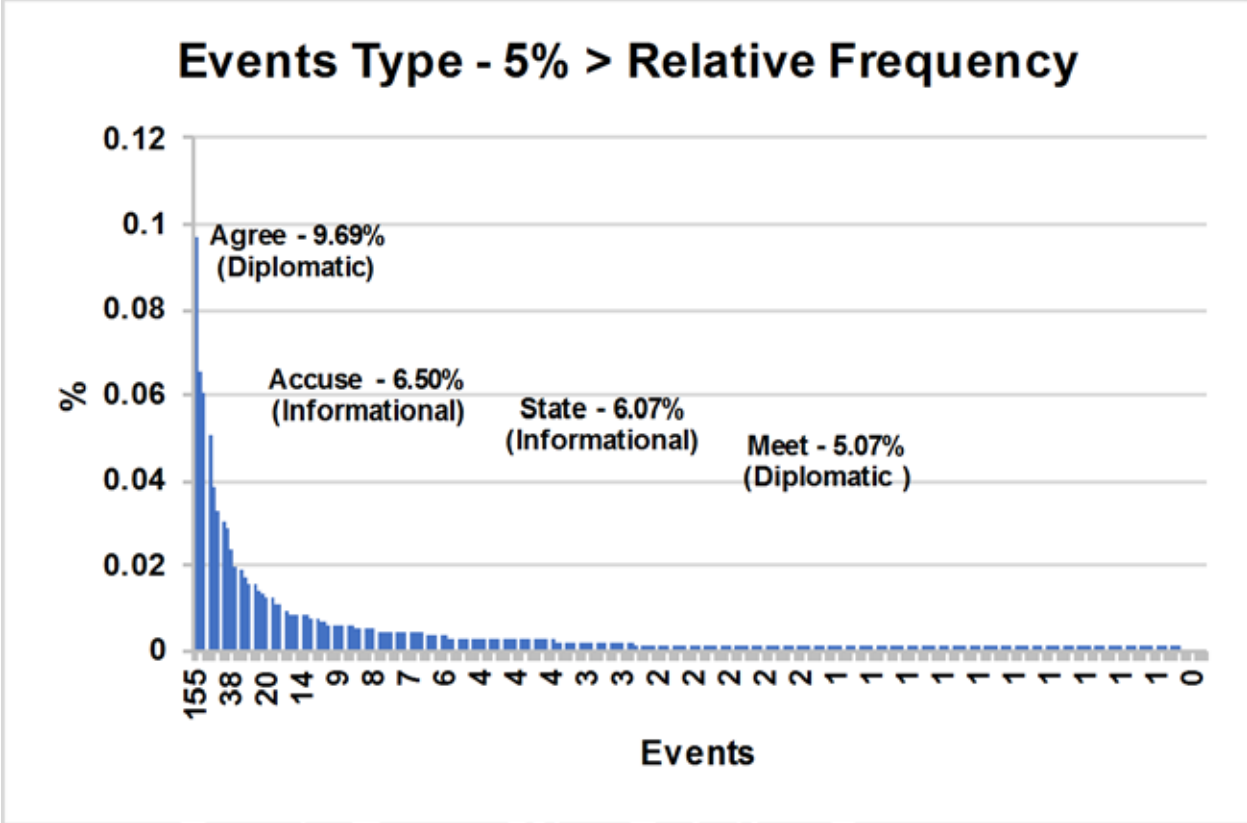

Figure 38 – 1967 Arab-Israeli Six-Day War Events Type – 5% > Relative Frequency

APPENDIX B: FORPOL SD LOOPS (STOCKS AND FLOWS)

Next, the main stock variables are discussed by feedback loop and chapter 4 will describe the experimental design simulation output and provide further understanding on which factors have the greatest impacts on the stock variables.

Beginning with loop 1 (-): A political event has salience that will negatively affect the level of social stress. Therefore, it must be assumed that the government takes political action by applying policy (diplomatic, informational, military, or economic) towards the political issue, which will succeed or fail. This reference mode was modeled using Cioffi-Revilla's definition and modeling of a political event in his theory of uncertainty and polity model SimPol (Cioffi-Revilla, 1998; Claudio Cioffi-Revilla, 2009).

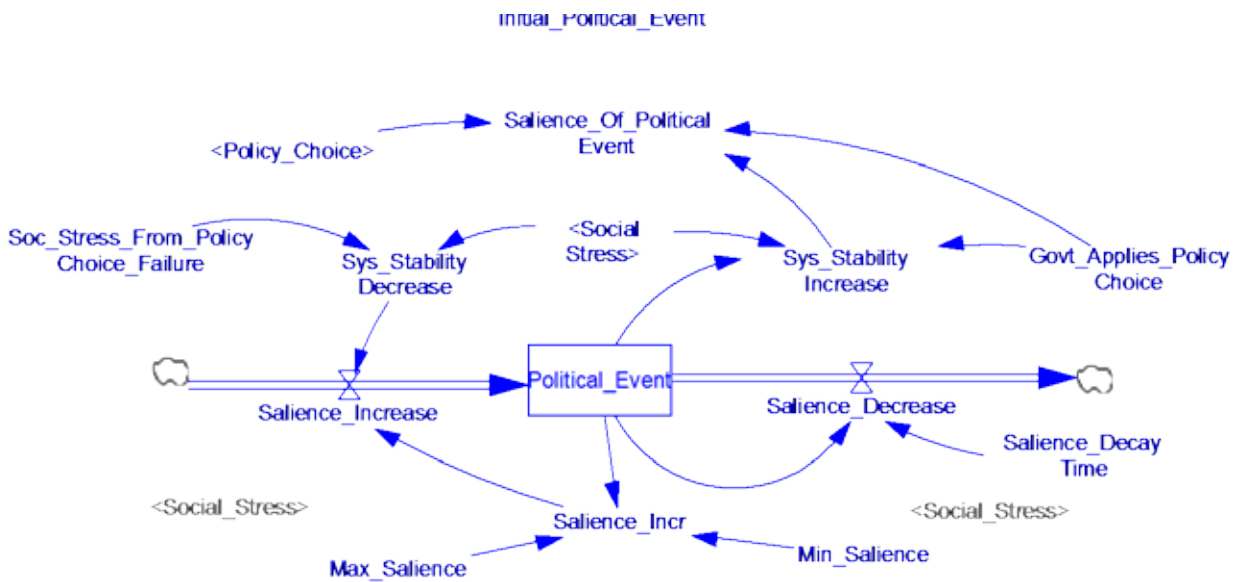

Figure 39 – System Dynamics Vensim Model – Saliency of Political Event

Source: Figure constructed using Vensim 7.0 Software by *Ventana Systems Inc.*, Copyright (2015) <http://vensim.com/vensim-software/>.

In loop 2 (-): The social stress level negatively affects system stability. In this case, it must be assumed that the government takes political action by applying policy (diplomatic, informational, military, or economic) towards the political issue, which will succeed or fail. This reference mode was developed after Cioffi-Revilla's definition and modeling of social stress in his polity model SimPol (Claudio Cioffi-Revilla, 2009)

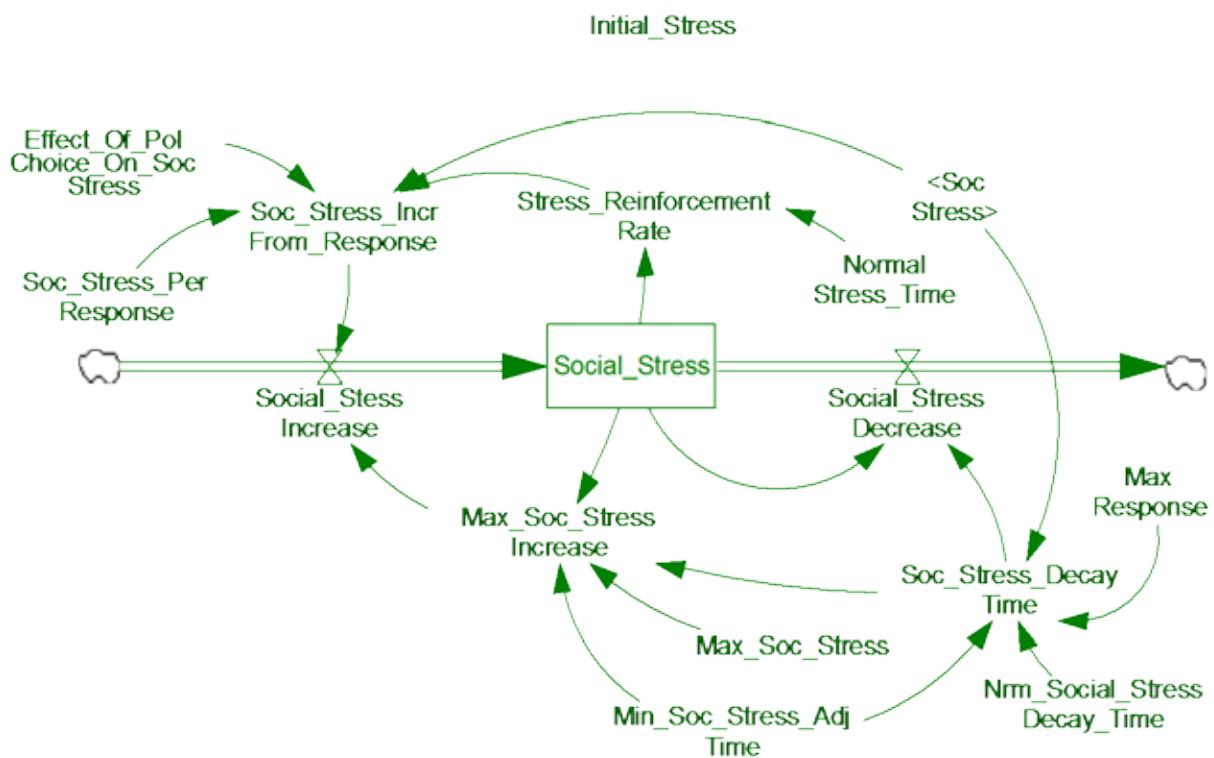

Figure 40 – System Dynamics Vensim Model – Social Stress

Source: Figure constructed using Vensim 7.0 Software by *Ventana Systems Inc.*, Copyright (2015) <http://vensim.com/vensim-software/>.

Alternatively, system stability negatively affects the society's level of social stress and is sensitive to changes in political event salience. It is assumed that as system stability decreases, the political event salience increases. This reference mode was

drafted using Choucri's definition and modeling of system stability (Choucri et al., 2006) but adapted to a regional system.

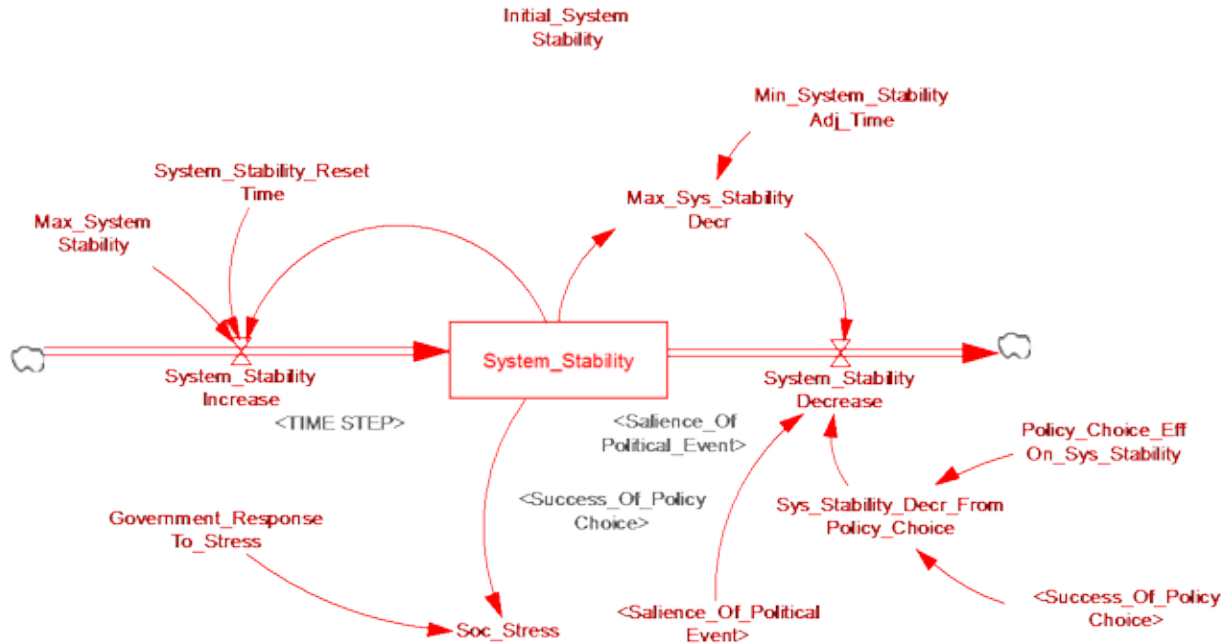

Figure 41 – System Dynamics Vensim Model – System Stability

Source: Figure constructed using Vensim 7.0 Software by *Ventana Systems Inc.*, Copyright (2015) <http://vensim.com/vensim-software/>.

In loop 3 (+): Policy choice (DIME) success or failure can positively affect political event salience and system stability. If the weight of the policy choice is greater than the weight of the salience, it is successful and the system remains stable. If the weight of the policy choice is less than the weight of the salience, it fails and the system is unstable. This reference mode was generated by combining the definitions of policy instruments and Cioffi-Revilla's definition and modeling of policy in his polity model SimPol (Brecher et al., 1969; Claudio Cioffi-Revilla, 2009; Hermann et al., 1977; Department of Defense, 2013)

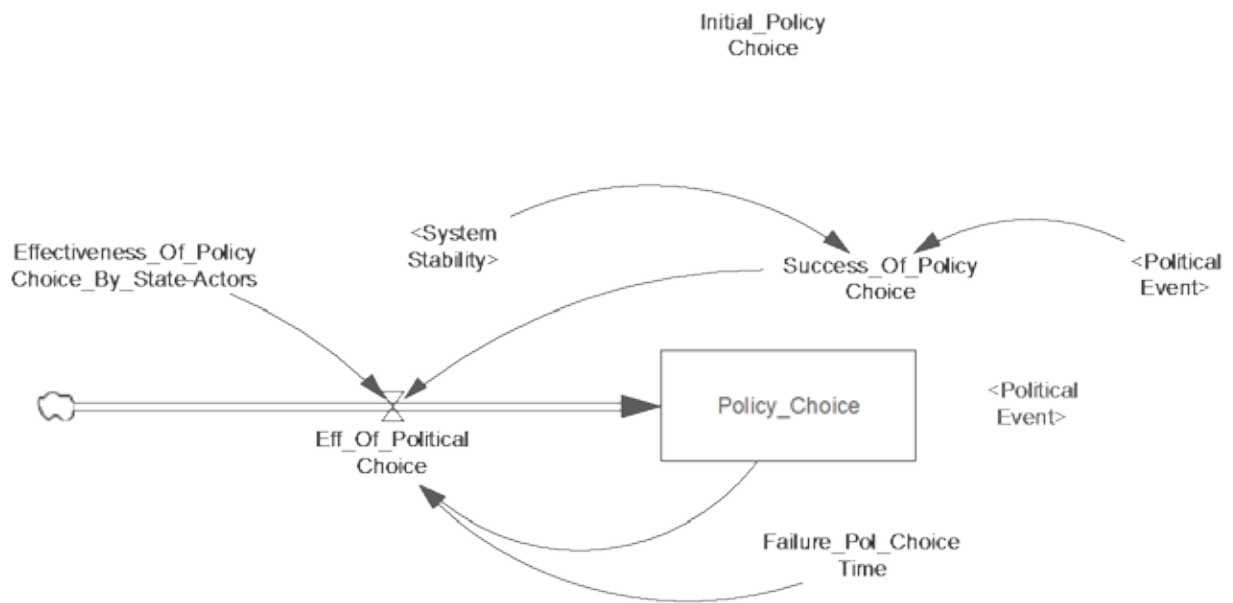

Figure 42 – System Dynamics Vensim Model – Policy Choice

Source: Figure constructed using Vensim 7.0 Software by *Ventana Systems Inc.*, Copyright (2015) <http://vensim.com/vensim-software/>.

APPENDIX C: CONFLICT AND PEACE DATA BANK

Obs	Mo	Day	Actor	Policy Choice	Target Actor	Policy	Type	COPDAB Stab_Scale	Adjusted Strs_Scale	COPDAB Weight	Adjusted Weight	Stability Value
1	5	1	SYR	US FRIENDS OF MIE SPY FOR US CIA BEHALF	US	Diplomatic	CHARGE	10	11	16	0.16	0.67
2	5	1	SYR	OBJECTIVE OF WAR WITH ISR TO DESTROY JOR GOVT	JOR	Informational	DECLARE	10	11	16	0.16	0.67
3	5	1	SYR	6TH FLEET NOT FRIGHTEN SYR;NOT STOP PAL WAR	US	Informational	DECLARE	10	11	16	0.16	0.67
4	5	2	JOR	AGREEMENT UNK EXEMPT JOR PAYMENT LL5M	UKG	Economic	APPROVE	4	5	27	0.26	0.27
5	5	3	EGY	AT UNO MEMBERSHIP	UN	Diplomatic	SHOOT	13	14	50	0.49	0.87
6	5	4	RUS	GENERAL ASSEMBLY ROLE IN PEACE KEEPING	UN	Diplomatic	OPPOSE	10	11	16	0.16	0.67
7	5	4	ISR	ARMY PATROL-SABOTAGE ATTEMPT NEAR LEB BORDER	PLO	Military	THWART	13	14	50	0.49	0.87
8	5	4	PLO	RESERVIOR WITH MINE--HEROES OF THE RETURN	ISR	Military	DESTROY	12	13	44	0.43	0.80
9	5	5	LEB	MORTAR ROUNDS INTO ISR FROM LEB	ISR	Military	FIRE	13	14	50	0.49	0.87
10	5	5	SYR	MORTAR ROUNDS INTO ISR FROM LEB	LEB	Military	FIRE	13	14	50	0.49	0.87
11	5	5	SYR	MORTAR ROUNDS INTO ISR FROM LEB	ISR	Military	FIRE	13	14	50	0.49	0.87
12	5	5	IRQ	HOSTILITIES AGAINST ISR AGGRESSOR	ISR	Military	OPEN	11	12	29	0.28	0.73
13	5	6	PLO	RESPONSIBLE FOR AN ATTACK-AL ASIFA	ISR	Informational	DECLARE	10	11	16	0.16	0.67
14	5	6	ISR	SYR TERRORISTS SHELL ISR FROM LEB	SYR	Military	REPORT	14	15	65	0.64	0.93
15	5	6	ISR	SYR TERRORISTS SHELL ISR FROM LEB	LEB	Military	ACCUSE	10	11	16	0.16	0.67
16	5	7	SYR	CIA INSTIGATE ATHEISM ARTICLE	US	Diplomatic	ACCUSE	10	11	16	0.16	0.67
17	5	8	FRN	CONF WITH AMBS	IRQ	Diplomatic	CONFER	7	8	5	0.05	0.47
18	5	8	FRN	CONF WITH AMBS	LEB	Diplomatic	CONFER	7	8	5	0.05	0.47
19	5	8	SYR	CONF WITH AMBS	UKG	Diplomatic	CONFER	7	8	5	0.05	0.47
20	5	9	ISR	BORDER RAIDS NORTH OF AMMIAD	PLO	Diplomatic	REPORT	13	14	50	0.49	0.87
21	5	9	PLO	ISR ROADS	ISR	Military	MINE	12	13	44	0.43	0.80
22	5	9	ISR	FURTHER TERRORISM PROVOKE RETALIATION BY PM	SYR	Military	WARN	10	11	16	0.16	0.67
23	5	10	JOR	16 POLITICAL REFUGEES	SYR	Diplomatic	DEPORT	10	11	16	0.16	0.67
24	5	10	IRQ	AREF PURSUE GOOD NEIGHBOR POLICY	IRN	Diplomatic	STATE	7	8	5	0.05	0.47
25	5	10	IRQ	AREF-PURSUE GOOD NEIGHBOR POLICY	TUR	Diplomatic	STATE	7	8	5	0.05	0.47
26	5	10	EGY	AIRLINER CONTINUE FLIGHT TO ADN (AFTER SEARCH)	UKG	Economic	ALLOW	7	8	5	0.05	0.47
27	5	10	US	US + USSR DESTROYERS	RUS	Military	COLLIDE	9	10	6	0.06	0.60

28	5	11	SYR	ISR INCR BORDER SUPERVISION NEAR SYR	ISR	Diplomatic	PROTEST	10	11	16	0.16	0.67
29	5	12	ISR	ESHKOL-FORCED TO TAKE RETLIATORY MEASURES	PLO	Diplomatic	STATE	10	11	16	0.16	0.67
30	5	12	US	ISR INDEPENDENCE DAY PARADE	ISR	Diplomatic	BOYCOTT	10	11	16	0.16	0.67
31	5	12	EGY	NASSER-ISR WILL CARRY OUT MILITARY OPERATIONS	ISR	Diplomatic	STATE	9	10	6	0.06	0.60
32	5	12	UKG	INCREASE ANNUAL LOAN LL100,000 FOR PROJECTS	JOR	Economic	AGREE	4	5	27	0.26	0.27
33	5	12	ISR	OF RETALIATORY MEASURES AGAINST RECENT ACTS	EGY	Military	WARN	10	11	16	0.16	0.67
34	5	13	SYR	PLOT TO DESTROY REVOLUTIONARY REGIME	ISR	Diplomatic	ACCUSE	10	11	16	0.16	0.67
35	5	13	SYR	U THANT CONDONES ISRAEL	UN	Diplomatic	CHARGE	10	11	16	0.16	0.67
36	5	13	SYR	TO UNO SG-THREATENING ATTITUDE OF ISR	UN	Diplomatic	PROTEST	10	11	16	0.16	0.67
37	5	13	SYR	PM-IF ATTACK-SYR UAR DEFENSE PACT EFFECTIVE	ISR	Diplomatic	STATE	10	11	16	0.16	0.67
38	5	13	SYR	U THANT-TOMEH	UN	Diplomatic	MEET	7	8	5	0.05	0.47
39	5	13	RUS	REPORT ISR GROUND-AIR ATTACK ALONG SYR BORDER	EGY	Informational	INFORM	12	13	44	0.43	0.80
40	5	13	RUS	REPORT ISR GROUND-AIR ATTACK ALONG SYR BORDER	SYR	Informational	INFORM	12	13	44	0.43	0.80
41	5	13	EGY	PERMISSION FOR 6TH FLEET VISIT ALEXANDRIA	US	Military	REFUSE	11	12	29	0.28	0.73
42	5	14	ISR	CHIEF OF STAFF BEHIND ALL SABOTAGE	SYR	Diplomatic	CHARGE	10	11	16	0.16	0.67
43	5	14	ISR	CONFRONTATION INEVITABLE IF PLO CONTINUES	SYR	Diplomatic	STATE	10	11	16	0.16	0.67
44	5	14	SYR	CREATE WAR ATMOSPHERE DELIBERATELY	ISR	Diplomatic	ACCUSE	10	11	16	0.16	0.67
45	5	14	SYR	U THANT STATEMENT ON ARA TERRORISM	UN	Diplomatic	DENOUNCE	10	11	16	0.16	0.67
46	5	14	RUS	AGGRESSIVE ACTIONS- COMMUNIQUE WITH UAR	ISR	Informational	CONDEMN	10	11	16	0.16	0.67
47	5	14	EGY	TROOPS NEAR BORDER	ISR	Military	MASS	11	12	29	0.28	0.73
48	5	14	SYR	TROOPS NEAR BORDER	ISR	Military	MOBILIZE	11	12	29	0.28	0.73
49	5	14	EGY	FAWZI-FOR TALKS ON JOINT DEFENSE PACT	SYR	Military	VISIT	5	6	14	0.14	0.33
50	5	15	EGY	TO HELP SYR REPEL ISR ATTACK	SYR	Diplomatic	PREPARE	3	4	31	0.30	0.20
51	5	15	EGY	ISR-SYR BORDER TENSE-MAY FLARE UP AT ANY TIME	ISR	Diplomatic	WARN	10	11	16	0.16	0.67
52	5	15	ISR	2 SABOTAGE INCIDENTS	PLO	Diplomatic	REPORT	10	11	16	0.16	0.67
53	5	15	SYR	UNO SC THAT SUEZ TYPE CRISIS DEVELOPING	ISR	Diplomatic	WARN	10	11	16	0.16	0.67
54	5	15	SYR	USA SIXTH FLEET INVOLVED IN LARGE CONSPIRACY	US	Diplomatic	ACCUSE	10	11	16	0.16	0.67
55	5	15	SYR	INTELLIGENCE SUPPRESS THE FEDAYEEN	JOR	Diplomatic	REPORT	10	11	16	0.16	0.67
56	5	15	US	EMB COMPOUND SEALED OFF IN	EGY	Diplomatic	ORDER	9	10	6	0.06	0.60

UAR												
57	5	15	US	EFFORT UNO SG MAINTAIN PEACE IN MIE	UN	Diplomatic	SUPPORT	7	8	5	0.05	0.47
58	5	15	SYR	UNO SC THAT SUEZ TYPE CRISIS DEVELOPING	UN	Informational	WARN	10	11	16	0.16	0.67
59	5	15	PLO	RAIDS ACROSS DMZ	ISR	Military	CONDUCT	12	13	44	0.43	0.80
60	5	15	ISR	THAT THE BORDER SITUATION SYR SERIOUS	US	Military	STATE	7	8	5	0.05	0.47
61	5	16	IRQ	NOT STAND FOR ISR AGGRESSION	US	Diplomatic	STATE	10	11	16	0.16	0.67
62	5	16	ISR	TO MAC OVER 2 ACTS BY JOR	JOR	Diplomatic	COMPLAIN	10	11	16	0.16	0.67
63	5	16	IRQ	PACHACHI-AMB-NOT STAND FOR ISR AGGRESSION	FRN	Diplomatic	STATE	9	10	6	0.06	0.60
64	5	16	IRQ	NOT STAND FOR ISR AGGRESSION	RUS	Diplomatic	STATE	7	8	5	0.05	0.47
65	5	16	RUS	AMB AND MILITARY ATTACHE-MIN OF WAR	EGY	Diplomatic	VISIT	7	8	5	0.05	0.47
66	5	16	RUS	INCREASE UAR PROFITS FOR AIR ROUTES	EGY	Economic	AGREE	4	5	27	0.26	0.27
67	5	16	EGY	UNEF TROOPS WITHDRAW	UN	Military	ORDER	11	12	29	0.28	0.73
68	5	16	EGY	TROOPS ON ALERT DECLARE EMERGENCY STATE	ISR	Military	PLACE	11	12	29	0.28	0.73
69	5	16	IRQ	SYR OF IRQ READINESS TO HELP SYR AGAINST ISR	ISR	Military	ASSURE	10	11	16	0.16	0.67
70	5	17	US	BY UAR REQUEST TO WITHDRAW UNO PATROL IN MIE	EGY	Diplomatic	OPPOSE	10	11	16	0.16	0.67
71	5	17	EGY	UNEF OBSERVATION POSTS IN AL-SABHA AREA	UN	Military	OCCUPY	12	13	44	0.43	0.80
72	5	17	PLO	KEEP SENDING COMMANDOS TO OCCUPIED PALESTINE	ISR	Military	TRANSPORT	12	13	44	0.43	0.80
73	5	17	EGY	ASSUME COMBAT READINESS AGAINST ISR	ISR	Military	MOBILIZE	11	12	29	0.28	0.73
74	5	17	SYR	ARMED FORCES-MAX READINESS DUE TO ISR BUILDUP	ISR	Military	STATE	11	12	29	0.28	0.73
75	5	17	IRQ	ALL POSSIBLE HELP TO REPEL ISR	SYR	Military	OFFER	6	7	10	0.10	0.40
76	5	17	LEB	POSTPONEMENT OF US SIXTH FLEET INDEFINITELY	US	Military	REQUEST	9	10	6	0.06	0.60
77	5	17	US	GROWING USR NAVAL CHALLENGE IN MEDITERRANEAN	RUS	Military	REPORT	9	10	6	0.06	0.60
78	5	18	ISR	U THANT + UN REPRESENTATIVE	UN	Diplomatic	MEET	7	8	5	0.05	0.47
79	5	18	ISR	ISR PLANES WARNING BURSTS AT UNO PLANE	UN	Military	FIRE	13	14	50	0.49	0.87
80	5	18	UKG	SUBMARINE AND FLEET TANKER	ISR	Military	AID	3	4	31	0.30	0.20
81	5	18	IRN	TROOPS TO COMBAT READINESS AGAINST ISR	ISR	Military	MOBILIZE	11	12	29	0.28	0.73
82	5	18	ISR	PERMIT UNEF STATIONED IN ISR	UN	Military	REFUSE	11	12	29	0.28	0.73
83	5	18	UKG	BROWN UNEF WITHDRAWAL FROM UAR	UN	Military	CRITICIZE	10	11	16	0.16	0.67
84	5	18	UKG	BOMBING OF SAU VILLAGES	EGY	Military	DEPLORE	10	11	16	0.16	0.67

85	5	18	UKG	UNFAVORABLY TO UAR REQUEST TO REMOVE UN TROOPS	EGY	Military	REACT	10	11	16	0.16	0.67
86	5	18	IRQ	MOBILIZATION FOR SUPPORT	SYR	Military	ANNOUNCE	6	7	10	0.10	0.40
87	5	18	JOR	MOBILIZATION FOR SUPPORT	EGY	Military	ANNOUNCE	6	7	10	0.10	0.40
88	5	18	JOR	MOBILIZATION FOR SUPPORT	SYR	Military	ANNOUNCE	6	7	10	0.10	0.40
89	5	18	EGY	UN WITHDRAW EMERGENCY FORCE SEPERATING TROOPS	ISR	Military	REQUEST	9	10	6	0.06	0.60
90	5	18	US	PROPOSED VISIT TO UAR BY 6TH FLEET	EGY	Military	CANCEL	9	10	6	0.06	0.60
91	5	18	IRQ	MOBILIZATION FOR SUPPORT	EGY	Military	ANNOUNCE	7	8	5	0.05	0.47
92	5	18	ISR	UNO TO COORDINATE FLIGHTS CLOSE TO ISR	UN	Military	REQUEST	7	8	5	0.05	0.47
93	5	19	RUS	NOT BE IDLE IF ISR ATTACK-UAR RADIO CLAIM	SYR	Diplomatic	PLEDGE	6	7	10	0.10	0.40
94	5	19	UKG	SOUTH WEST AFRICA INDEPENDENCE MOVE	UN	Diplomatic	SUPPORT	6	7	10	0.10	0.40
95	5	19	RUS	EBAN-CHUVAKHIN AND BYKOV	ISR	Diplomatic	MEET	7	8	5	0.05	0.47
96	5	19	EGY	UN FORCES FROM SINAI	UN	Military	PROHIBIT	11	12	29	0.28	0.73
97	5	19	PLO	FORMER UNEF POSTS	UN	Military	COMMAND	10	11	16	0.16	0.67
98	5	19	SYR	FOREIGN MIN-HUSSEIN-MASS TROOPS ON SYR BORDER	JOR	Military	ACCUSE	10	11	16	0.16	0.67
99	5	19	PLO	PALESTINE LIBERATION ARMY INTO FORMER UN POSTS	EGY	Military	MOVE	6	7	10	0.10	0.40
100	5	20	SYR	AIRPORTS TO ALL AIRCRAFT	EGY	Diplomatic	OPEN	5	6	14	0.14	0.33
101	5	20	US	U THANT DECISION GO TO UAR FOR PEACE EFFORT	UN	Diplomatic	WELCOME	6	7	10	0.10	0.40
102	5	20	EGY	STATE OF EMERGENCY-GAZA STRIP	ISR	Informational	DECLARE	11	12	29	0.28	0.73
103	5	20	EGY	TROOPS-OCCUPIED UNEF POSTS IN GAZA STRIP	PLO	Military	SUPPORT	3	4	31	0.30	0.20
104	5	20	ISR	PARTIAL TROOP OPERATIONS	JOR	Military	MOBILIZE	11	12	29	0.28	0.73
105	5	20	SYR	TROOPS NEAR BORDER	ISR	Military	MASS	11	12	29	0.28	0.73
106	5	20	IRQ	TALKS TO COORDINATE MILITARY COOPERATION	SYR	Military	CONFER	6	7	10	0.10	0.40
107	5	20	SYR	TALKS TO COORDINATE MILITARY COOPERATION	IRQ	Military	BEGIN	7	8	5	0.05	0.47
108	5	21	EGY	SHARM EL-SHAYKH	ISR	Diplomatic	OCCUPY	12	13	44	0.43	0.80
109	5	21	PLO	PEOPLE OVERTHROW KING HUSSEIN	JOR	Diplomatic	APPEAL	10	11	16	0.16	0.67
110	5	21	RUS	HAS INTEREST IN KEEPING MIE PEACE-US REPORTS	US	Diplomatic	ASSURE	7	8	5	0.05	0.47
111	5	21	PLO	ARAB TERRORISTS CARRY OUT RAIDS IN ISR	ISR	Informational	DECLARE	10	11	16	0.16	0.67
112	5	21	EGY	UAR CRUISER AND 6 OTHER VESSELS MOVING SOUTH	ISR	Military	MOBILIZE	11	12	29	0.28	0.73
113	5	21	ISR	PARTIAL MOBILIZATION OF RESERVES	EGY	Military	REPORT	11	12	29	0.28	0.73
114	5	21	JOR	SEND BOOBY-TRAP AUTOMOBILE	SYR	Military	CHARGE	10	11	16	0.16	0.67

ACROSS BORDER												
115	5	21	EGY	PALESTINE LIBERATION FRONT INTO ARAB ARMY	PLO	Military	MOBILIZE	6	7	10	0.10	0.40
116	5	21	JOR	CHIEF OF STAFF TO DISCUSS ARA COORDINATION	EGY	Military	VISIT	7	8	5	0.05	0.47
117	5	22	SYR	NATIONALISTS TO LEAVE	US	Diplomatic	REQUEST	11	12	29	0.28	0.73
118	5	22	EGY	PUSH ISR AGAINST ARA	US	Diplomatic	ACCUSE	10	11	16	0.16	0.67
119	5	22	ISR	SYR ALLEGATIONS MADE IN LETTER TO SC	SYR	Diplomatic	DENY	10	11	16	0.16	0.67
120	5	22	SYR	ATASSI-HUSSEIN CALLS FOR SUMMIT-INFILTRATION	JOR	Diplomatic	STATE	10	11	16	0.16	0.67
121	5	22	RUS	NASSER	EGY	Diplomatic	SUPPORT	6	7	10	0.10	0.40
122	5	22	ISR	U THANT + RAFAEL	UN	Diplomatic	MEET	7	8	5	0.05	0.47
123	5	22	EGY	GULF OF AQABA TO ISR SHIPS	ISR	Military	CLOSE	12	13	44	0.43	0.80
124	5	22	IRQ	MILITARY SUPPORT IN CASE OF HOSTILITIES	EGY	Military	OFFER	3	4	31	0.30	0.20
125	5	22	ISR	REMOVAL OF UNEF FROM UAR	UN	Military	ASSAIL	10	11	16	0.16	0.67
126	5	22	PLO	MOVE ARMY COMMAND TO GAZA	ISR	Military	ANNOUNCE	10	11	16	0.16	0.67
127	5	22	ISR	MUTUAL REDUCTION OF TROOPS BY ESHKOL	EGY	Military	PROPOSE	7	8	5	0.05	0.47
128	5	22	ISR	MUTUAL REDUCTION OF TROOP CONCENTRATION	SYR	Military	PROPOSE	7	8	5	0.05	0.47
129	5	22	ISR	INTERFERENCE WITH SHIPS BE CONSIDERED ATTACK	UN	Military	STATE	7	8	5	0.05	0.47
130	5	23	JOR	DIPLOMATIC RELATIONS	IRQ	Diplomatic	BREAK	12	13	44	0.43	0.80
131	5	23	JOR	AMB DUE TO 670521 BORDER INCIDENT	SYR	Diplomatic	EXPEL	12	13	44	0.43	0.80
132	5	23	EGY	MASS ANTI-ISR RALLY WHERE UNO SG WAS STAYING	ISR	Diplomatic	STAGE	10	11	16	0.16	0.67
133	5	23	RUS	FOR MIE WORSENING SITUATION	ISR	Diplomatic	BLAME	10	11	16	0.16	0.67
134	5	23	SYR	ISR DESTRUCTION	ISR	Diplomatic	ADVOCATE	10	11	16	0.16	0.67
135	5	23	SYR	DIPLOMATIC NEGOTIATIONS	JOR	Diplomatic	CEASE	10	11	16	0.16	0.67
136	5	23	SYR	PM AND CHIEF OF STAFF	EGY	Diplomatic	VISIT	5	6	14	0.14	0.33
137	5	23	UKG	AMB KING HUSSEIN	JOR	Diplomatic	VISIT	5	6	14	0.14	0.33
138	5	23	EGY	LBJ 5 POINT PEACE PLAN	US	Diplomatic	REJECT	9	10	6	0.06	0.60
139	5	23	US	GREAT DISMAY AT UNEF WITHDRAWAL FROM UAR	UN	Diplomatic	EXPRESS	9	10	6	0.06	0.60
140	5	23	EGY	BY U-THANT + LEADERS IN CAIRO	UN	Diplomatic	CONFER	7	8	5	0.05	0.47
141	5	23	EGY	RUSK-AMB	US	Diplomatic	MEET	7	8	5	0.05	0.47
142	5	23	ISR	ISR FM WITH UNK PM IN UNK	UKG	Diplomatic	MEET	7	8	5	0.05	0.47
143	5	23	RUS	AMB-KING HUSSEIN	JOR	Diplomatic	VISIT	7	8	5	0.05	0.47
144	5	23	US	AMB-KING HUSSEIN	JOR	Diplomatic	VISIT	7	8	5	0.05	0.47
145	5	23	EGY	IRN-SHIPS CARRYING IRN OIL TO ISR-NOT ALLOWED	IRN	Economic	STATE	10	11	16	0.16	0.67

146	5	23	SYR	STATEMENT-FULL SUPPORT UAR CLOSING GULF AQUABA	EGY	Informational	ISSUE	6	7	10	0.10	0.40
147	5	23	EGY	GULF OF AQABA	ISR	Military	MINE	13	14	50	0.49	0.87
148	5	23	EGY	STRAIT OF TIRAN	ISR	Military	BLOCKADE	12	13	44	0.43	0.80
149	5	23	IRQ	UNITE MILITARY-POLITICAL-ECON FORCES	EGY	Military	DECIDE	2	3	47	0.46	0.13
150	5	23	ISR	GULF OF AQABA BLOCKADE IS ACT OF WAR BY DM	EGY	Military	WARN	10	11	16	0.16	0.67
151	5	23	UKG	UNFAVORABLY TO UAR CLOSING OF STRAITS OF TIRAN	EGY	Military	REACT	10	11	16	0.16	0.67
152	5	23	EGY	UNITE MILITARY-POLITICAL-ECON FORCES	IRQ	Military	SUPPORT	5	6	14	0.14	0.33
153	5	23	ISR	MAJOR POWERS UNO TO MAINTAIN FREE NAVIGATION	UN	Military	CALL	7	8	5	0.05	0.47
154	5	23	LEB	MILITARY DELEGATION	EGY	Military	VISIT	7	8	5	0.05	0.47
155	5	24	EGY	WILL FIRE ON SHIPS ENTERING GULF FOR EILAT	ISR	Diplomatic	ANNOUNCE	10	11	16	0.16	0.67
156	5	24	JOR	SYR RULERS BUTCHERS MURDERERS CRIMINALS	SYR	Diplomatic	ACCUSE	10	11	16	0.16	0.67
157	5	24	RUS	NOT PARTICIPATE IN ANY DRAFT RESOLUTIONS IN SC	UN	Diplomatic	STATE	10	11	16	0.16	0.67
158	5	24	EGY	U THANT-RIYAD AND NASSER	UN	Diplomatic	CONFER	5	6	14	0.14	0.33
159	5	24	UKG	BROWN KOSYGIN AND GROMYKO ON MIE	RUS	Diplomatic	MEET	5	6	14	0.14	0.33
160	5	24	US	RUSK AND RUSTOW-THOMSON-DISCUSS MIE	UKG	Diplomatic	MEET	5	6	14	0.14	0.33
161	5	24	UKG	UNO WAS RIGHT ORG-ACT IN UAR WATERWAY CRISIS	UN	Diplomatic	ASSERT	6	7	10	0.10	0.40
162	5	24	EGY	DEFENSE OF ISR RIGHT TO GULF OF AQABA	US	Diplomatic	CRITICIZE	9	10	6	0.06	0.60
163	5	24	EGY	AL-KONI-SC DRAFT RESOLUTION-SABOTAGE SCG	UN	Diplomatic	DESCRIBE	9	10	6	0.06	0.60
164	5	24	FRN	US UNK FRN USR CONF ON MIE CRISIS	RUS	Diplomatic	PROPOSE	7	8	5	0.05	0.47
165	5	24	FRN	US UNK FRN USR CONF ON MIE CRISIS	UKG	Diplomatic	PROPOSE	7	8	5	0.05	0.47
166	5	24	FRN	US UNK FRN USR CONF ON MIE CRISIS	US	Diplomatic	PROPOSE	7	8	5	0.05	0.47
167	5	24	UKG	FOR RESTRAINT IN RESOLVING MIE CRISIS	RUS	Diplomatic	ASK	7	8	5	0.05	0.47
168	5	24	UKG	RUSK AND RUSTOW THOMSON DISCUSS MIE	US	Diplomatic	MEET	7	8	5	0.05	0.47
169	5	24	US	TO WORK DIRECTLY WITH FRN TO RESOLVE MIE	FRN	Diplomatic	OFFER	7	8	5	0.05	0.47
170	5	24	US	TO WORK DIRECTLY WITH USR TO RESOLVE MIE	RUS	Diplomatic	OFFER	7	8	5	0.05	0.47
171	5	24	US	JOINT UNK US USR FRN ACTION IN MIE	UN	Diplomatic	PROPOSE	7	8	5	0.05	0.47
172	5	24	US	SEAMEN CARRY CARGO TO UAR BECAUSE OF BLOCKADE	EGY	Economic	REFUSE	11	12	29	0.28	0.73
173	5	24	IRN	SELL OIL TO ISR	EGY	Economic	DENY	9	10	6	0.06	0.60

174	5	24	SYR	RADIO-HUSSEIN AS TRAITOR AND SPY	JOR	Informational	DESCRIBE	10	11	16	0.16	0.67
175	5	24	US	CONSIDER GULF OF AQABA BLOCKADE AGGRESSIVE ACT	EGY	Informational	WARN	10	11	16	0.16	0.67
176	5	24	UKG	WOULD SUPPORT ACTION TO KEEP STRAIT TIRAN OPEN	ISR	Informational	DECLARE	6	7	10	0.10	0.40
177	5	24	ISR	GUNFIRE IN GAZA	PLO	Military	EXCHANGE	13	14	50	0.49	0.87
178	5	24	PLO	ON ISR SOLDIERS WHO APPROACHED FRONTIER	ISR	Military	FIRE	12	13	44	0.43	0.80
179	5	24	EGY	LIGHT AND HEAVY ARMS-GAZA STRIP UNITS	PLO	Military	STRENGTHEN	3	4	31	0.30	0.20
180	5	24	IRQ	BILATERAL MILITARY COOPERATION	SYR	Military	AGREE	3	4	31	0.30	0.20
181	5	24	IRQ	SEND AIR FORCES UAR REPULSE ISR ATTACK	EGY	Military	DECIDE	3	4	31	0.30	0.20
182	5	24	LEB	LEB DEFENSE MINISTRY CALLS UP RESERVISTS	ISR	Military	MOBILIZE	11	12	29	0.28	0.73
183	5	24	JOR	PERMISSION FOR IRQ SAU FORCES ENTER JOR	IRQ	Military	GRANT	4	5	27	0.26	0.27
184	5	24	ISR	EBAN + WILSON REGARD BLOCKADE AS UAR AGGRESSION	UKG	Military	STATE	6	7	10	0.10	0.40
185	5	24	JOR	UAR MEASURES IN GULF OF AQABA ARE RIGHT	EGY	Military	STATE	6	7	10	0.10	0.40
186	5	24	LEB	SUPPORT FOR BLOCKADE VS ISR BY KARAMI	EGY	Military	REITERATE	6	7	10	0.10	0.40
187	5	25	RUS	PROPOSAL FOR US-UNK-USR-FRN CONF ON MIE	FRN	Diplomatic	REJECT	10	11	16	0.16	0.67
188	5	25	EGY	JOHNSON STATEMENT ON GULF OF AQABA	US	Diplomatic	REJECT	9	10	6	0.06	0.60
189	5	25	UKG	LET UN ATTEMPT TO SETTLE MIE BEFORE INTERVENE	US	Diplomatic	AGREE	7	8	5	0.05	0.47
190	5	25	UKG	PROPOSAL FOR UNK US FRN USR CONF ON MIE	FRN	Diplomatic	WELCOME	7	8	5	0.05	0.47
191	5	25	EGY	ENTRY OF ISR SHIP IN GULF OF AQABA & AGGRESSION	ISR	Informational	WARN	10	11	16	0.16	0.67
192	5	25	FRN	NOT TO TEST STRAITS OF TIRAN BLOCKADE	ISR	Informational	ADVISE	7	8	5	0.05	0.47
193	5	25	EGY	IN GAZA STRIP	ISR	Military	CLASH	15	16	102	1.00	1.00
194	5	25	IRQ	OFFER ALLOWING IRAQI TROOPS STATION IN JOR	JOR	Military	DECLINE	9	10	6	0.06	0.60
195	5	25	US	PLANS TO SEND AIRCRAFT CARRIER THRU SUEZ CANAL	EGY	Military	DELAY	9	10	6	0.06	0.60
196	5	25	EGY	DISCUSS MILITARY AID	RUS	Military	VISIT	7	8	5	0.05	0.47
197	5	25	ISR	TO KEEP ASSURANCE THAT USA KEEP AQABA OPEN	US	Military	VISIT	7	8	5	0.05	0.47
198	5	25	PLO	NO KNOWN CAUSALITIES IN BORDER CLASH WITH ISR	ISR	Military	STATE	7	8	5	0.05	0.47
199	5	26	EGY	OBJECTIVE OF WAR WITH ISR- DESTROY ISR	ISR	Diplomatic	STATE	12	13	44	0.43	0.80
200	5	26	EGY	USA OF SUPPORTING ISR IN PRESENT CRISIS	US	Diplomatic	ACCUSE	10	11	16	0.16	0.67
201	5	26	EGY	UNK PM CANNOT MOVE WITHOUT ORDERS FROM USA PRS	UKG	Diplomatic	CHARGE	10	11	16	0.16	0.67

202	5	26	EGY	USA MAIN ENEMY + REJECT US PEACE PROPOSAL	US	Diplomatic	CHARGE	10	11	16	0.16	0.67
203	5	26	PLO	KING HUSSEIN TURN JORDAN INTO NATO BASE	JOR	Diplomatic	ACCUSE	10	11	16	0.16	0.67
204	5	26	PLO	THAT PEOPLE JOIN ARA BATTLE	JOR	Diplomatic	REQUEST	10	11	16	0.16	0.67
205	5	26	EGY	THANKS TO FRN PRS-FRN KEEP FREEDOM OF ACTION	FRN	Diplomatic	STATE	6	7	10	0.10	0.40
206	5	26	UKG	AQABA INTL WATERWAY	EGY	Diplomatic	ASSERT	9	10	6	0.06	0.60
207	5	26	RUS	UAR AND SYR-TRY HARD TO PREVENT WAR IN MIE	EGY	Diplomatic	STATE	7	8	5	0.05	0.47
208	5	26	UKG	SHARE W INTENTION TO DEFUSE MIE CRISIS	RUS	Diplomatic	STATE	7	8	5	0.05	0.47
209	5	26	US	PROPOSAL TO UAR FOR PEACE IN MIE	EGY	Diplomatic	SUBMIT	7	8	5	0.05	0.47
210	5	26	EGY	COMPLETED MILITARY BUILD UP IN SINAI	ISR	Informational	ANNOUNCE	11	12	29	0.28	0.73
211	5	26	PLO	TROOPS FIGHT TOGETHER	IRQ	Military	ANNOUNCE	2	3	47	0.46	0.13
212	5	26	EGY	FOREIGN MIN-SHIPS SEARCHED GOING TO ISR	UKG	Military	WARN	10	11	16	0.16	0.67
213	5	26	ISR	WITHIN RIGHTS TO BREAK BLOCKADE IF UNO FAILS	EGY	Military	WARN	10	11	16	0.16	0.67
214	5	27	FRN	BE MODERATE (DE GAULLE-NASSER)	EGY	Diplomatic	URGE	9	10	6	0.06	0.60
215	5	27	EGY	OVER ARAB-ISRAELI CRISIS	CHN	Diplomatic	CONFER	7	8	5	0.05	0.47
216	5	27	EGY	SC-PLACE ISR AGGRESSIVE POLICY ON AGENDA	UN	Diplomatic	REQUEST	7	8	5	0.05	0.47
217	5	27	IRQ	OVER ARAB-ISRAELI CRISIS	CHN	Diplomatic	CONFER	7	8	5	0.05	0.47
218	5	27	EGY	APPROACH IRN STOP OIL TO ISR-FOREIGN MIN STATE	JOR	Economic	REQUEST	6	7	10	0.10	0.40
219	5	27	JOR	AGAINST SUPPORTING ISR BY JUMAA	US	Informational	WARN	9	10	6	0.06	0.60
220	5	27	US	AGAINST ANY UNILATERAL ACTION	ISR	Informational	CAUTION	9	10	6	0.06	0.60
221	5	27	EGY	HALFTRACK-WOUND 7 SOLDIERS	ISR	Military	CLASH	13	14	50	0.49	0.87
222	5	27	JOR	TROOPS AT BORDER	ISR	Military	MOBILIZE	13	14	50	0.49	0.87
223	5	27	LEB	BOMB IN EMBASSY	US	Military	EXPLODE	12	13	44	0.43	0.80
224	5	27	ISR	ISR HALFTRACK WAS BLOWN UP BY UAR MINE IN GAZA	EGY	Military	STATE	10	11	16	0.16	0.67
225	5	27	ISR	ISR HEARTENED BY FIRM STAND ON BLODKADE	US	Military	STATE	6	7	10	0.10	0.40
226	5	27	ISR	ANY BLOCKADE OF AQABA	FRN	Military	REJECT	9	10	6	0.06	0.60
227	5	27	EGY	RIYAD-U THANT-ACCELERATE UNEF EVACUATION	UN	Military	REQUEST	7	8	5	0.05	0.47
228	5	27	PLO	OVER ARAB-ISRAELI CRISIS	CHN	Military	CONFER	7	8	5	0.05	0.47
229	5	28	EGY	STOP IRN OIL SUPPLIES TO ISR	ISR	Diplomatic	ATTEMPT	11	12	29	0.28	0.73
230	5	28	EGY	EXTEND NT THAT TIRAN STRAITS ARE INTERNATIONAL	UKG	Diplomatic	REJECT	10	11	16	0.16	0.67
231	5	28	IRQ	CABINET-ADOPT MEASURES BAN	UKG	Diplomatic	DECIDE	10	11	16	0.16	0.67

AGGRESSION												
232	5	28	ISR	ISR WILL DEFEND RIGHT OF SELF-DEFENSE	EGY	Diplomatic	WARN	10	11	16	0.16	0.67
233	5	28	US	25,000-SUPPORT	ISR	Diplomatic	MARCH	6	7	10	0.10	0.40
234	5	28	US	UN RESOLUTION ON MIE	UN	Diplomatic	SUPPORT	6	7	10	0.10	0.40
235	5	28	EGY	STATEMENT THAT TIRAN STRAITS ARE INTERNATIONAL	US	Diplomatic	REJECT	9	10	6	0.06	0.60
236	5	28	EGY	MIE CONFLICT	RUS	Diplomatic	DISCUSS	7	8	5	0.05	0.47
237	5	28	IRQ	AREF SHAH STAND AGAINST ISR	IRN	Diplomatic	REQUEST	7	8	5	0.05	0.47
238	5	28	IRQ	SUPPORT FOR ARABS	TUR	Diplomatic	URGE	7	8	5	0.05	0.47
239	5	28	RUS	CHARGE D'AFFAIRES-DEAN-ON MIE CRISIS	US	Diplomatic	MEET	7	8	5	0.05	0.47
240	5	28	SYR	MIE CONFLICT	RUS	Diplomatic	DISCUSS	7	8	5	0.05	0.47
241	5	28	US	JOHNSON-SELF RESTRAINT	EGY	Diplomatic	APPEAL	7	8	5	0.05	0.47
242	5	28	US	OPTIMISM IN EASING TENSION	EGY	Diplomatic	EXPRESS	7	8	5	0.05	0.47
243	5	28	IRQ	OIL EXPORTS TO AGGRESSIVE STATES	US	Economic	BAN	11	12	29	0.28	0.73
244	5	28	IRQ	CANCEL OIL LICENSES IN NATIONS BACK ISR	ISR	Economic	WARN	11	12	29	0.28	0.73
245	5	28	US	THAT USAMAINAIN IMPORTS-IF REFRAIN ACTION	ISR	Economic	OFFER	7	8	5	0.05	0.47
246	5	28	SYR	RADIO-SYR-IRQ BILATERAL MILITARY AGREEMENT	IRQ	Informational	ANNOUNCE	3	4	31	0.30	0.20
247	5	28	EGY	CONSIDER US AND UNK AS ENEMIES	UKG	Informational	WARN	10	11	16	0.16	0.67
248	5	28	EGY	UAR ALWAYS EXTEND FRIENDSHIP TO USA	US	Informational	DECLARE	6	7	10	0.10	0.40
249	5	28	EGY	ACROSS GAZA BORDER	ISR	Military	CLASH	15	16	102	1.00	1.00
250	5	28	ISR	SHOTS ACROSS GAZA BORDER	EGY	Military	EXCHANGE	14	15	65	0.64	0.93
251	5	28	ISR	DEFENSES COMPLETED NEAR SINAI BORDERS BY DM	EGY	Military	ANNOUNCE	13	14	50	0.49	0.87
252	5	28	JOR	PATROL BOATS OUT OF ELAT	ISR	Military	CHASE	13	14	50	0.49	0.87
253	5	28	ISR	CAPTURE OF 5 UAR SOLDIERS IN ISR	EGY	Military	REPORT	12	13	44	0.43	0.80
254	5	28	IRQ	FORCES-INTO	SYR	Military	MOVE	3	4	31	0.30	0.20
255	5	28	US	AMMUNITION	ISR	Military	SUPPLY	3	4	31	0.30	0.20
256	5	28	EGY	MISSILE CARRIERS-MEDITERRANEAN-OFFENSIVE-ISR	ISR	Military	PREPARE	11	12	29	0.28	0.73
257	5	28	JOR	ATTEMPTING TO ESCALATE INTO WAR INEVITABLE WAR	ISR	Military	CHARGE	10	11	16	0.16	0.67
258	5	28	EGY	BULL-HELP IN RELEASE OF SOLDIERS HELD BY ISR	UN	Military	REQUEST	7	8	5	0.05	0.47
259	5	28	ISR	EXPECT WEST TO OPEN STRAITS OF TIRAN	US	Military	STATE	7	8	5	0.05	0.47
260	5	28	JOR	JOR NOT BE ABLE TO STAND SHOCK OF UAR DEFEAT	EGY	Military	STATE	7	8	5	0.05	0.47

261	5	29	ISR	U THANT PROPOSAL TO REVIVE MAC	UN	Diplomatic	REJECT	10	11	16	0.16	0.67
262	5	29	RUS	SHOULD WITHDRAW FLEETS FROM MEDITERRANEAN-UNO	US	Diplomatic	STATE	10	11	16	0.16	0.67
263	5	29	SYR	US ALIGNED WITH ISR AGAINST ARA	US	Diplomatic	ACCUSE	10	11	16	0.16	0.67
264	5	29	SYR	SYR PRS	RUS	Diplomatic	VISIT	5	6	14	0.14	0.33
265	5	29	EGY	NASSER-ASSEMBLY-USR SUPPORT UAR AND BLOCKADE	RUS	Diplomatic	STATE	7	8	5	0.05	0.47
266	5	29	US	CHARLES YOST (MIE SPECIALIST)- CONFER-NOLTE	EGY	Diplomatic	VISIT	7	8	5	0.05	0.47
267	5	29	ISR	SEEK END INTERFERENCE WITH SHIPPING	UN	Economic	REQUEST	7	8	5	0.05	0.47
268	5	29	EGY	NEGOTIATED PEACE OUT OF QUESTION	PLO	Informational	DECLARE	6	7	10	0.10	0.40
269	5	29	EGY	NAVY WARNING SHOTS TO SHIP IN RED SEA	US	Military	ATTACK	13	14	50	0.49	0.87
270	5	29	EGY	THAT US BASE IN LBY SEND ISR ARMS	US	Military	ACCUSE	10	11	16	0.16	0.67
271	5	29	RUS	AQABA BLOCKADE	EGY	Military	SUPPORT	6	7	10	0.10	0.40
272	5	29	ISR	WILL TAKE ACTION TO REMOVE BLOCKADE OF AQABA	UKG	Military	STATE	7	8	5	0.05	0.47
273	5	30	ISR	ABOUT JOR-UAR DEFENSE PACT	JOR	Diplomatic	WARN	10	11	16	0.16	0.67
274	5	30	SYR	UNWRITTEN US-ISR ALLIANCE	US	Diplomatic	CHARGE	10	11	16	0.16	0.67
275	5	30	US	SYR CHARGE OF TAKING SIDES AGAINST THEM	SYR	Diplomatic	DENOUNCE	10	11	16	0.16	0.67
276	5	30	EGY	USR ATTITUDE IN MIE	RUS	Diplomatic	PRAISE	6	7	10	0.10	0.40
277	5	30	RUS	FULL SUPPORT-SYR ANNOUNCE	SYR	Diplomatic	PLEDGE	6	7	10	0.10	0.40
278	5	30	US	ISR FRIENDSHIP	ISR	Diplomatic	DEFEND	6	7	10	0.10	0.40
279	5	30	EGY	BREAKING AQABA BLOCKADE MEAN TOTAL WAR	ISR	Informational	WARN	11	12	29	0.28	0.73
280	5	30	PLO	SOLDIERS IN SAF-KILL 2-WOUND 9	UKG	Military	AMBUSH	12	13	44	0.43	0.80
281	5	30	RUS	SHIPS-UNITS OF 6TH FLEET	US	Military	SHADOW	12	13	44	0.43	0.80
282	5	30	RUS	WARSHIPS IN MEDITERRANIAN	ISR	Military	MOBILIZE	11	12	29	0.28	0.73
283	5	30	EGY	5-YEAR DEFENSE TREATY- RECONCILE DIFFERENCES	JOR	Military	AGREE	4	5	27	0.26	0.27
284	5	30	EGY	MILITARY AIRLIFT INTO ISR	US	Military	ACCUSE	10	11	16	0.16	0.67
285	5	30	EGY	INSPECTION OF PLANES OVER UAR TERRITORY	US	Military	DEMAND	10	11	16	0.16	0.67
286	5	30	ISR	GOV WILL OPEN STRAITS OF TIRAN	EGY	Military	THREATEN	10	11	16	0.16	0.67
287	5	30	ISR	CONCERN FOR JOR-UAR DEFENSE PACT	EGY	Military	EXPRESS	9	10	6	0.06	0.60
288	5	31	JOR	RESPONSIBLE FOR MIE VIOLENCE	ISR	Diplomatic	ACCUSE	10	11	16	0.16	0.67
289	5	31	SYR	TROUBLE IN JOR ARMY	JOR	Diplomatic	CITE	10	11	16	0.16	0.67
290	5	31	EGY	UAR VP TO SYR & IRQ	IRQ	Diplomatic	VISIT	5	6	14	0.14	0.33

291	5	31	EGY	UAR VP SYR IRQ	SYR	Diplomatic	VISIT	5	6	14	0.14	0.33
292	5	31	UKG	GET ACTION TO STOP GULF OF AQABA BLOCKADE	EGY	Diplomatic	ATTEMPT	9	10	6	0.06	0.60
293	5	31	EGY	PLAN FOR MIE SOLUTION	UN	Diplomatic	ADVOCATE	7	8	5	0.05	0.47
294	5	31	EGY	AIRCRAFT CARRIER THROUGH SUEZ CANAL-US REPORT	US	Diplomatic	ALLOW	7	8	5	0.05	0.47
295	5	31	UKG	FAIL STOP BLOCKADE UNK STILL CONTINUE	UN	Diplomatic	STATE	7	8	5	0.05	0.47
296	5	31	IRQ	TROOPS INTO UAR	EGY	Military	AIRLIFT	3	4	31	0.30	0.20
297	5	31	JOR	UAR-JOR MUTUAL DEFENSE AGREEMENT	EGY	Military	SUPPORT	6	7	10	0.10	0.40
298	5	31	US	ALLEGATIONS-US BASE IN LIB DELIVER ARMS TO ISR	EGY	Military	DENY	9	10	6	0.06	0.60
299	5	31	US	INTL NAVAL FORCE TO SEE SHIPS THROUGH AQABA	EGY	Military	ENDORSE	9	10	6	0.06	0.60
300	5	31	JOR	CHIEF OF STAFF	SYR	Military	VISIT	7	8	5	0.05	0.47
301	6	1	EGY	ALLOW ENTRANCE TO CUSTOMS AREA	US	Diplomatic	REFUSE	11	12	29	0.28	0.73
302	6	1	IRQ	GOV-WORKS OF JEAN PAUL SARTRE FOR SUPPORT ISR	ISR	Diplomatic	BAN	11	12	29	0.28	0.73
303	6	1	SYR	CLOSE US EMBASSIES AND CULTURAL CENTERS	US	Diplomatic	ANNOUNCE	11	12	29	0.28	0.73
304	6	1	SYR	HARBOR 171 US TRAINERS OF SABOTEURS-SPIES	JOR	Diplomatic	ACCUSE	10	11	16	0.16	0.67
305	6	1	SYR	KING HUSSEIN-DESCRIBE AS REACTIONARY	JOR	Diplomatic	CRITICIZE	10	11	16	0.16	0.67
306	6	1	JOR	DIPLOMATIC RELATIONS	SYR	Diplomatic	RESUME	6	7	10	0.10	0.40
307	6	1	SYR	DIPLOMATIC RELATIONS	JOR	Diplomatic	RESUME	6	7	10	0.10	0.40
308	6	1	EGY	AGAINST OPPOSING AQABA BLOCKADE	ISR	Informational	WARN	10	11	16	0.16	0.67
309	6	1	IRQ	BREAK RELATIONS IF ISR AID CONTINUES	US	Informational	WARN	10	11	16	0.16	0.67
310	6	1	JOR	AT ISR HELICOPTER WHICH CROSS JOR AIR SPACE	ISR	Military	FIRE	13	14	50	0.49	0.87
311	6	1	JOR	JOINT MILITARY COMMAND AGAINST ISR	EGY	Military	FORM	2	3	47	0.46	0.13
312	6	1	JOR	JOINT MILITARY COMMAND	IRQ	Military	FORM	2	3	47	0.46	0.13
313	6	1	EGY	JOINT MILITARY COMMAND	IRQ	Military	FORM	3	4	31	0.30	0.20
314	6	1	IRQ	JOINT MILITARY COMMAND	JOR	Military	FORM	3	4	31	0.30	0.20
315	6	1	IRQ	IRQ FIGHTER PLANES ON ISR FRONT	ISR	Military	STATION	11	12	29	0.28	0.73
316	6	1	US	AIR EXERCISES IN MEDITERRANEAN	EGY	Military	CONDUCT	11	12	29	0.28	0.73
317	6	1	US	AIR EXERCISES IN MEDITERRANEAN	ISR	Military	CONDUCT	6	7	10	0.10	0.40
318	6	1	US	INITIATIVE OF CONSULTING POWERS ON GULF AQABA	UKG	Military	SUPPORT	6	7	10	0.10	0.40
319	6	1	JOR	TO MAC ISR HELICOPTER CROSS JOR AIR SPACE	UN	Military	COMPLAIN	7	8	5	0.05	0.47

320	6	2	FRN	DECLARATION ON FREE PASSAGE GULF OF AQABA	US	Diplomatic	OPPOSE	10	11	16	0.16	0.67
321	6	2	IRQ	PRO-ISR BIAS	UKG	Diplomatic	CRITICIZE	10	11	16	0.16	0.67
322	6	2	ISR	DEAL ON FREE PASSAGE IN STRAITS	EGY	Diplomatic	REJECT	10	11	16	0.16	0.67
323	6	2	RUS	PROPOSALS FOR MARITIME POWER DECLARATION-MIE	US	Diplomatic	REJECT	10	11	16	0.16	0.67
324	6	2	UKG	LBJ + WILSON ON AQABA BLOCKADE	US	Diplomatic	MEET	5	6	14	0.14	0.33
325	6	2	UKG	DECLARATION ALONG WITH CAD TO OPEN AQABA GULF	US	Diplomatic	AGREE	6	7	10	0.10	0.40
326	6	2	FRN	SIGN PLAN FOR FREEDOM IN AQABA	ISR	Diplomatic	REFUSE	9	10	6	0.06	0.60
327	6	2	RUS	TO OPEN AQABA GULF TO INTERNATIONAL TRADE	US	Diplomatic	DISAGREE	9	10	6	0.06	0.60
328	6	2	RUS	DECLARATION ON FREE PASSAGE-GULF OF AQABA	US	Diplomatic	OPPOSE	9	10	6	0.06	0.60
329	6	2	FRN	ISR-ARA HAVE RIGHT TO LIVE	ISR	Diplomatic	STATE	7	8	5	0.05	0.47
330	6	2	FRN	UNK USR FRN US SHOULD DECIDE ON BLOCKADE	RUS	Diplomatic	STATE	7	8	5	0.05	0.47
331	6	2	FRN	UNK USR FRN US SHOULD DECIDE ON BLOCKADE	UKG	Diplomatic	STATE	7	8	5	0.05	0.47
332	6	2	FRN	UNK USR FRN US SHOULD DECIDE ON BLOCKADE	US	Diplomatic	STATE	7	8	5	0.05	0.47
333	6	2	UKG	LIFTING BLOCKADE KEY TO MIE CRISIS	US	Diplomatic	REITERATE	7	8	5	0.05	0.47
334	6	2	FRN	ON OPENING AQABI GULF TO INTERNATIONAL TRADE	UKG	Economic	DISAGREE	9	10	6	0.06	0.60
335	6	2	ISR	TERRORIST GROUP 2 ISR KILLED 1 SYR KILLED	SYR	Military	INTERCEPT	14	15	65	0.64	0.93
336	6	2	EGY	SUEZ CANAL TO SHIPS THAT FORCE BLOCKADE	US	Military	CLOSE	13	14	50	0.49	0.87
337	6	2	SYR	2 ISR SOLDIERS IN CLASH	ISR	Military	KILL	13	14	50	0.49	0.87
338	6	2	EGY	ON INSTALLATIONS IN LBY	UKG	Military	AGREE	3	4	31	0.30	0.20
339	6	2	EGY	FREIGHTER ENTERING SUEZ CANAL	UKG	Military	STOP	11	12	29	0.28	0.73
340	6	2	US	LBJ + WILSON ON AQABA BLOCKADE	UKG	Military	MEET	5	6	14	0.14	0.33
341	6	2	ISR	DECLARATION ON GULF OF AQUABA	UKG	Military	ACCEPT	6	7	10	0.10	0.40
342	6	2	US	CONTINUED MILITARY SUPPORT	JOR	Military	ASSURE	6	7	10	0.10	0.40
343	6	3	EGY	UAR DEMONSTRATORS AGAINST US	US	Diplomatic	RIOT	11	12	29	0.28	0.73
344	6	3	US	UAR REJECT US-UNK MIE PLAN	EGY	Diplomatic	STATE	10	11	16	0.16	0.67
345	6	3	UKG	WILSON U THANT MIE CRISIS	UN	Diplomatic	DISCUSS	5	6	14	0.14	0.33
346	6	3	UKG	INTENSIFY EFFORT MARITIME POWERS STATEMENT	US	Diplomatic	AGREE	6	7	10	0.10	0.40
347	6	3	EGY	UN DELEGATE-FOR SUPPORT ISR	US	Diplomatic	CRITICIZE	9	10	6	0.06	0.60
348	6	3	EGY	EXCHANGE VISITS OF VP-KEEP DOOR TO PEACE OPEN	US	Diplomatic	DECIDE	7	8	5	0.05	0.47

349	6	3	EGY	NASSER-NUTTING-WAR SHOULD BE AVOIDED	UKG	Diplomatic	STATE	7	8	5	0.05	0.47
350	6	3	FRN	SC APPEAL TO ALL PARTIES IN MIE REFRAIN FORCE	UN	Diplomatic	PROPOSE	7	8	5	0.05	0.47
351	6	3	ISR	ACCEPT NOTHING LESS THAN FREE PASSAGE IN GULF	UN	Diplomatic	STATE	7	8	5	0.05	0.47
352	6	3	US	EXCHANGE VISITS OF VP-KEEP DOOR TO PEACE OPE	EGY	Diplomatic	AGREE	7	8	5	0.05	0.47
353	6	3	US	INTENSIFY EFFORT-MARITIME POWERS STATEMENT	UKG	Economic	AGREE	6	7	10	0.10	0.40
354	6	3	ISR	CITIZENS FROM ARMISTICE LINE WITH JOR	JOR	Economic	PLAN	9	10	6	0.06	0.60
355	6	3	RUS	BLOC COUNTRIES WITH OFFER BUY OIL	SYR	Economic	APPROACH	7	8	5	0.05	0.47
356	6	3	SYR	LEADERS-JOR-UAR MUTUAL DEFENSE PACT	EGY	Economic	DISCUSS	7	8	5	0.05	0.47
357	6	3	US	REVEAL VESSEL MISSION	EGY	Military	REFUSE	10	11	16	0.16	0.67
358	6	3	UKG	FEAR SURPRISE WEEKEND ATTACK BY DAYAN	EGY	Military	STATE	7	8	5	0.05	0.47
359	6	4	SYR	WITH 7 ARAB STATE TO STOP OIL TO USA & UNK	IRQ	Diplomatic	AGREE	4	5	27	0.26	0.27
360	6	4	LEB	WITH 7 ARAB STATE TO STOP OIL TO USA & UNK	EGY	Diplomatic	AGREE	6	7	10	0.10	0.40
361	6	4	LEB	WITH 7 ARAB STATE TO STOP OIL TO USA & UNK	IRQ	Diplomatic	AGREE	6	7	10	0.10	0.40
362	6	4	LEB	WITH 7 ARAB STATE TO STOP OIL TO USA & UNK	SYR	Diplomatic	AGREE	6	7	10	0.10	0.40
363	6	4	RUS	POSITION ON ME CRISIS - PRAVDA	UKG	Diplomatic	CRITICIZE	9	10	6	0.06	0.60
364	6	4	IRQ	WITH SEVEN ARAB STATES TO STOP OIL TO US + UNK	UKG	Economic	AGREE	11	12	29	0.28	0.73
365	6	4	IRQ	WITH SEVEN ARAB STATES TO STOP OIL TO US + UNK	US	Economic	AGREE	11	12	29	0.28	0.73
366	6	4	IRQ	WITH SEVEN ARAB STATES TO STOP OIL TO US & UNK	EGY	Economic	AGREE	4	5	27	0.26	0.27
367	6	4	EGY	WITH 7 ARAB STATE TO STOP OIL TO USA & UNK	LEB	Economic	AGREE	6	7	10	0.10	0.40
368	6	4	IRQ	WITH SEVEN ARAB STATES TO STOP OIL TO US & UNK	LEB	Economic	AGREE	6	7	10	0.10	0.40
369	6	4	IRQ	WITH SEVEN ARAB STATES TO STOP OIL TO US & UNK	SYR	Economic	AGREE	6	7	10	0.10	0.40
370	6	4	SYR	WITH 7 ARAB STATES TO STOP OIL TO USA & UNK	LEB	Economic	AGREE	6	7	10	0.10	0.40
371	6	4	ISR	TO FLOAT LOANS HOME AND ABROAD	JOR	Economic	PLAN	7	8	5	0.05	0.47
372	6	4	EGY	UNK-US AQABA PLAN CONSIDERED WAR	US	Informational	WARN	10	11	16	0.16	0.67
373	6	4	EGY	UNK-US AQABA PLAN CONSIDERED WAR	UKG	Informational	WARN	10	11	16	0.16	0.67
374	6	4	JOR	LOSE ARA FRIENDS IF SUPPORT ISR	UKG	Informational	WARN	10	11	16	0.16	0.67
375	6	4	JOR	LOSE ARA FRIENDS IF SUPPORT ISR BY KING	US	Informational	WARN	10	11	16	0.16	0.67

376	6	4	ISR	JERUSALEM AREA	JOR	Military	CLASH	14	15	65	0.64	0.93
377	6	4	JOR	JERUSALEM AREA BUT DENY EXCHANGING FIRE	ISR	Military	CLASH	14	15	65	0.64	0.93
378	6	4	EGY	THE 7 ARAB STATE TO STOP OIL TO USA & UNK	US	Military	SUSPEND	13	14	50	0.49	0.87
379	6	4	EGY	MILITARY EQUIPMENT-BY AIR	JOR	Military	SEND	3	4	31	0.30	0.20
380	6	4	IRQ	UAR-JOR DEFENSE PACT OF MAY 30	EGY	Military	JOIN	3	4	31	0.30	0.20
381	6	4	IRQ	DEFENSE PACT	SYR	Military	JOIN	3	4	31	0.30	0.20
382	6	4	IRQ	TROOPS-IN SINAI AND W BANK OF JORDAN RIVER	ISR	Military	POSITION	11	12	29	0.28	0.73
383	6	4	ISR	JOR SHOOTING AT ISR	JOR	Military	ACCUSE	10	11	16	0.16	0.67
384	6	4	RUS	NAVAL SIZE IN MEDITERRANEAN	EGY	Military	INCREASE	6	7	10	0.10	0.40
385	6	4	ISR	CONCERN AT SLOWNESS GREAT POWERS LIFT BLOCKADE	US	Military	EXPRESS	9	10	6	0.06	0.60
386	6	5	SYR	SEND TROOPS TO UAR	EGY	Diplomatic	PROMISE	3	4	31	0.30	0.20
387	6	5	EGY	KONI-PREMEDITATED	ISR	Diplomatic	ACCUSE	10	11	16	0.16	0.67
388	6	5	ISR	AGGRESSION-LETTER TO SC START HOSTILITIES IN MESSAGE TO SC	EGY	Diplomatic	ACCUSE	10	11	16	0.16	0.67
389	6	5	ISR	AIR FORCE AND TANKS MOVE TOWARD ISR	EGY	Diplomatic	ACCUSE	10	11	16	0.16	0.67
390	6	5	RUS	AGGRESSION (TASS)	ISR	Diplomatic	CONDEMN	10	11	16	0.16	0.67
391	6	5	RUS	UN CEASE-FIRE IN MIE BLOCK	EGY	Diplomatic	SUPPORT	6	7	10	0.10	0.40
392	6	5	US	US NOT INTEND TO ENTER MIE WAR BY LBJ	RUS	Diplomatic	ASSURE	6	7	10	0.10	0.40
393	6	5	US	HELPING ISR IN MIE WAR	EGY	Diplomatic	DENY	9	10	6	0.06	0.60
394	6	5	EGY	AL-KONI-SC-VIGOROUSLY CONDEMN ISR AGGRESSION	UN	Diplomatic	DEMAND	7	8	5	0.05	0.47
395	6	5	ISR	KEEP OUT OF CONFLICT TO HUSSEIN BY ESHKOL	JOR	Diplomatic	APPEAL	7	8	5	0.05	0.47
396	6	5	RUS	CONDEMN ISR	UN	Diplomatic	ASK	7	8	5	0.05	0.47
397	6	5	RUS	AMB-NASSER	EGY	Diplomatic	VISIT	7	8	5	0.05	0.47
398	6	5	SYR	ATASSI-HELOU	LEB	Diplomatic	TALK	7	8	5	0.05	0.47
399	6	5	US	PEACE PLAN FOR MIE	EGY	Diplomatic	OFFER	7	8	5	0.05	0.47
400	6	5	US	PEACE PLAN FOR MIE	ISR	Diplomatic	OFFER	7	8	5	0.05	0.47
401	6	5	IRQ	WAR ON ISR	ISR	Informational	DECLARE	15	16	102	1.00	1.00
402	6	5	ISR	WAR ON UAR AND OTHER ARAB STATES	EGY	Informational	DECLARE	15	16	102	1.00	1.00
403	6	5	ISR	WAR ON SYR AND OTHER ARAB STATES	SYR	Informational	DECLARE	15	16	102	1.00	1.00
404	6	5	SYR	WAR	ISR	Informational	DECLARE	15	16	102	1.00	1.00
405	6	5	EGY	NASSER-FIGHT TO RID ZIONISM-REGAIN PALESTINE	ISR	Informational	DECLARE	10	11	16	0.16	0.67
406	6	5	EGY	ALONG BORDER IN ARAB-ISRAELI WAR	ISR	Military	CLASH	15	16	102	1.00	1.00

407	6	5	ISR	GAZA	EGY	Military	ATTACK	15	16	102	1.00	1.00
408	6	5	ISR	AL-KUNTILLA	EGY	Military	ATTACK	15	16	102	1.00	1.00
409	6	5	ISR	CAIRO BY AIR	EGY	Military	ATTACK	15	16	102	1.00	1.00
410	6	5	ISR	AMMAN AND MAFRAQ AIRFIELDS	JOR	Military	ATTACK	15	16	102	1.00	1.00
411	6	5	ISR	AIRCRAFT BIQAA AND LITANI AREAS	LEB	Military	BATTLE	15	16	102	1.00	1.00
412	6	5	ISR	NAVAL FORCES OFF PORT SAID	EGY	Military	CLASH	15	16	102	1.00	1.00
413	6	5	ISR	IN ARAB - ISRAELI WAR + SHOOT 16 AIRCRAFT	IRQ	Military	CLASH	15	16	102	1.00	1.00
414	6	5	ISR	FULL SCALE WAR AGAINST UAR SYR JOR	PLO	Military	CONDUCT	15	16	102	1.00	1.00
415	6	5	ISR	ALL OF UAR AIRFORCES	EGY	Military	DESTROY	15	16	102	1.00	1.00
416	6	5	ISR	AIRFIELDS BY ISR AIRFORCE	SYR	Military	DESTROY	15	16	102	1.00	1.00
417	6	5	ISR	NAVAL FORCES IN ALEXANDRIA PORT	EGY	Military	ENTER	15	16	102	1.00	1.00
418	6	5	ISR	OFFENSIVE VS EGY + SYR + JOR BY ISR FORCES	EGY	Military	LAUNCH	15	16	102	1.00	1.00
419	6	5	ISR	OFFENSIVE VS EGY + SYR + JOR BY ISR FORCES	JOR	Military	LAUNCH	15	16	102	1.00	1.00
420	6	5	ISR	OFFENSIVE VS EGY + SYR + JOR BY ISR FORCES	SYR	Military	LAUNCH	15	16	102	1.00	1.00
421	6	5	ISR	AIR TANK ATTACKS IN GAZA + SINAI	EGY	Military	REPEL	15	16	102	1.00	1.00
422	6	5	ISR	AIRFIELDS + CAPTURE AL-ARISH IN SINAI	EGY	Military	STRIKE	15	16	102	1.00	1.00
423	6	5	JOR	JEBEL MUKHAIBER + DESTROY 12 AIRCRAFT -REPORT	ISR	Military	OCCUPY	15	16	102	1.00	1.00
424	6	5	SYR	30 AIRCRAFT OVER SYR TERRITORY-SYR REPORT	ISR	Military	SHOOT	15	16	102	1.00	1.00
425	6	5	ISR	HIT TANKER	FRN	Military	ATTEMPT	13	14	50	0.49	0.87
426	6	5	LEB	1 PLANE-CHASE OTHERS FROM LEB AIRSPACE	ISR	Military	SHOOT	13	14	50	0.49	0.87
427	6	5	SYR	FARM SETTLEMENTS	ISR	Military	SHELL	13	14	50	0.49	0.87
428	6	5	EGY	161 PLANES LOST	ISR	Military	CRUSH	12	13	44	0.43	0.80
429	6	5	ISR	KHAN YUNIS IN SINAI	EGY	Military	CAPTURE	12	13	44	0.43	0.80
430	6	5	JOR	UNTSO HQS IN JERUSALEM	UN	Military	OCCUPY	12	13	44	0.43	0.80
431	6	5	RUS	GUIDED MISSILE DESTROYER 381- AMERICA	US	Military	TRAIL	12	13	44	0.43	0.80
432	6	5	EGY	PLANES PROVIDE FIGHTER COVER OVER ISR PLANES PROVIDE FIGHTER COVER OVER ISR	US	Military	CHARGE	10	11	16	0.16	0.67
433	6	5	ISR	INITIATING HOSTILITIES	JOR	Military	ACCUSE	10	11	16	0.16	0.67
434	6	5	ISR	DOWN 389 ENEMY PLANES + LOSE 19	EGY	Military	REPORT	10	11	16	0.16	0.67
435	6	5	ISR	SHOOT 120 AIRCRAFT BY ISR	EGY	Military	REPORT	10	11	16	0.16	0.67

436	6	5	US	AIRCRAFT CARRIER AMERICA-550 MILES OFF ISR	ISR	Military	SUPPLY	6	7	10	0.10	0.40
-----	---	---	----	---	-----	----------	--------	---	---	----	------	------

APPENDIX D: NETLOGO INTERFACE

Interface Info Code

Edit Delete Add abc Button

normal speed

view updates

continuous

Settings...

ticks:

Agent-Base



State-Actors & Capability (Parameters)

On Off Israel On Off Syria On Off Jordan On Off Iraq On Off Turkey

ISR Capabili... SYR Capabilit... JOR Capabilt... IRQ Capabilt... TRK Capabili...

Diploma... Informati... Military Economic Diplomatic

On Off Egypt On Off Yemen On Off Palest... On Off Iran On Off Pakistan

EGY Capabilit... YEM Capabili... PAL Capabilt... IRN Capabili... PAK Capabili...

Diplomatic Informati... Military Economic Economic

On Off UK On Off US On Off USSR

UK Diplomatic US Diploma... USSR Diploma...

Political Event /

On Off UNEF_Remo... On Off USSR_Intel_Communic... On Off EGY_Troop_De...

On Off SOT_Blockade On Off SYR_Intel_Communicati... On Off JOR_Joins_UAR

On Off ISR-SYR_Bat... On Off EGY_al-Fatha_Support On Off Diplo_Deterr_Fa...

On Off National_Water_Carrier

1967 Arab-Israeli Six-Day War

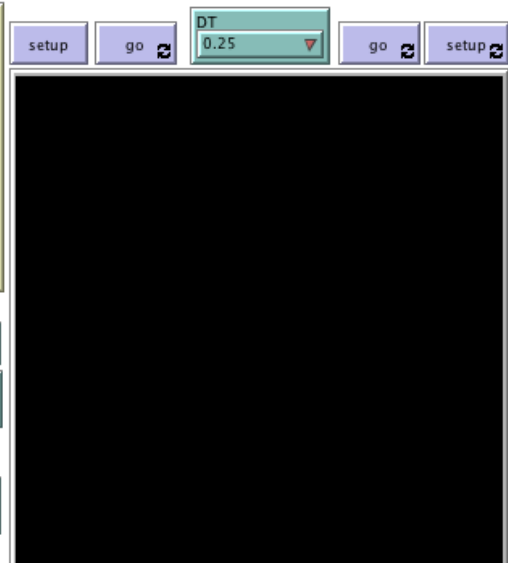

System-Dynamics

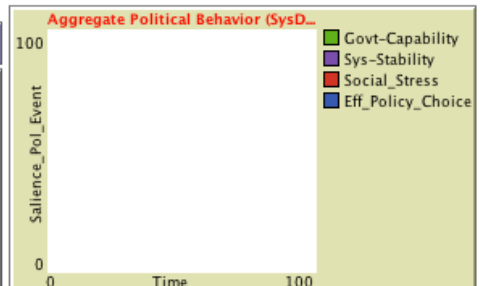

Factor Capability & Sallience

Govt_App_Pol_Choice 0.7

Success_Pol_Choice 0.5

Failure_Pol_Choice 0.5

Actor_Pol_Choice_Eff_On_Govt_Capa 0.9

Factor Social Stress

Sal_Pol_Event 0.4

Initial Stock and Randomization

Rnd_SPE 0 Rnd_SSL 0 Rnd_SPC 0 Rnd_FPC 4

APPENDIX E: NETLOGO CODE

```

;; Define breeds of turtles needed for state actors
breed[states state]
breed[governments government]
breed[societies society]

;; Define which variables are owned by which part of each state actor. Corresponding states,
governments, and societies will share the same "name" variable
states-own [name active?]
governments-own [name maximum-capability Pol-Choice weighted-action]
societies-own [name social-stress]

globals [

t
initial-maximum-capability
initial-action
initial-stress
nation-names
delta-stability-ab
delta-salience-ab
delta-action
delta-stress
weighted-action-sum

]

to nation-initial-conditions
set t 0
set nation-names (list "ISR" "SYR" "JOR" "IRQ" "TRK" "EGY" "YEM" "PAL" "IRN" "PAK" "UK" "US"
"USSR" "UN" "FRN" "LEB")
; set initial-salience [1 1 1 1 1 1 1 1 1 1 1 1 1 1]
set initial-maximum-capability [0.77 0.24 0.21 0.24 0.44 0.41 0.09 0.11 0.46
1.2 1.04 4.2 4.4 0 1.08 0.11]
set initial-action [29 29 -10 16 0 29 0 44 29 0 -31 16 44 0 -6 29]
set initial-stress [3 3 3 3 3 3 3 3 3 3 3 3 3
3 3 3 3 3]
set delta-stability-ab 0
set delta-salience-ab 0
set delta-action 0.01
set delta-stress 0.01
set weighted-action-sum 0
; set active-nations [1 1 1 1 0 1 0 1 1 0 1 1 1 1 1]
end

;; Imports the initial conditions from nation-initial-conditions into the created states, governments, and
societies
to setup-nations
create-states Number-Of-Nations ;; Create a state for each state actor
create-governments Number-Of-Nations ;; Create a government for each state actor
create-societies Number-Of-Nations ;; create a society for each state actor

let counter-1 0 ;; initialize for-loop

```

```

setup-active ;; Call setup-active to use active values in upcoming loop
ask states [
  setxy (who - 8) -5
  set color 69.9
]
ask governments [
  setxy (who - 24) 5
  set color 19.9
]
ask societies [
  setxy (who - 40) 0
  set color 109.9
]
.....; Note that nation on-off switch values need to be added in if
statements to set "off" nation values to zero
loop [
  if counter-1 > Number-Of-Nations - 1 [stop]
  ask state counter-1 [
    if active? [
;   ask state counter-1 [
;     set name item counter-1 nation-names
;     set salience item counter-1 initial-salience]
  ask government (counter-1 + Number-Of-Nations) [
    set name item counter-1 nation-names
    set maximum-capability item counter-1 initial-maximum-capability
    set Pol-Choice item counter-1 initial-action]
  ask society (counter-1 + 2 * Number-Of-Nations) [
    set name item counter-1 nation-names
    set social-stress item counter-1 initial-stress]
    ]
  ]
  set counter-1 counter-1 + 1
]
end

;; The initial system stability will be a function of the nation-initial-conditions
to setup-initial-stability
  set System-Stability initial_stability
end

to create-plot-pens
  ;; create plot pens for all active nations
  set-current-plot "Salience"
  clear-plot
  create-temporary-plot-pen (word "salience-pen")
  set-current-plot "Policy Choice"
  clear-plot
  ask governments [
    create-temporary-plot-pen (word who)
  ]

```

```

set-current-plot "Social Stress"
clear-plot
ask societies [
create-temporary-plot-pen (word who)
]
set-current-plot "System Stability"
clear-plot
create-temporary-plot-pen (word "stability-pen")
end

;;
to setup
clear-all
nation-initial-conditions ;; Depends on setup-active
setup-nations ;; Depends on nation-initial-conditions
setup-initial-stability ;; depends on nation-initial-conditions and setup-nations
create-plot-pens
reset-ticks
end

to do-plots
set-current-plot "Salience"
set-current-plot-pen "salience-pen"
plotxy t Salience
set-current-plot "Policy Choice"
ask governments with [name != "0"] [
set-current-plot-pen (word who)
plotxy t Pol-Choice
]
set-current-plot "Social Stress"
ask societies with [name != "0"] [
set-current-plot-pen (word who)
plotxy t social-stress
]
set-current-plot "System Stability"
set-current-plot-pen "stability-pen"
plotxy t System-Stability
end

to go
;; import current values of state actor variables
;; update all variables with loop like in setup-nations
;; update plots

ask governments with [name != "0"] [

set Pol-Choice Pol-Choice + delta-action ;; government action equation
if Pol-Choice > maximum-capability [ ;; check government action to prevent an action above the
maximum capability of that nation
set Pol-Choice maximum-capability
set Policy-Choice-Randomness 1 + random-float Policy-Choice-Randomness
set System-Stability-Randomness 1 + random-float System-Stability-Randomness

```

```

    set Saliency-Randomness 1 + random-float Saliency-Randomness
]
set weighted-action 0.16623 * (Event_Saliency) ^ 3 - 3.8836 *(Event_Saliency) ^ 2 + 35.066 *
(Event_Saliency) - 113.34
]

ask societies with [name != "0"] [

set social-stress 0.01 * system-stability ;; social stress equation for each active nation
if social-stress < 0 [ ;; check social stress value to prevent a potential negative value
set social-stress 0
]

]

set weighted-action-sum 0
ask governments with [name != 0] [ ;; Add conditional statement here to add probability of policy choice
success
ifelse random-float 100 < Policy-Choice-Probability
[ set color green ]
[ set color red ]
show-turtle

set weighted-action-sum weighted-action-sum + weighted-action
]

ask governments with [name != 0] [
set color red - Pol-Choice / 1
set size 5
set shape "circle"
set heading 0
hide-turtle

]
ask societies with [name != 0] [
set color yellow - social-stress / 1
set size 1
set shape "circle"
set heading 0
hide-turtle
]

set delta-stability-ab 0.01 * weighted-action-sum ;; change in system stability from AB model

set delta-saliency-ab 0 ;; change in saliency from AB model

do-plots

```

```
set t t + dt
tick
end
```

```
to setup-active
  ask state 0 [
    ifelse Israel
    [set active? true]
    [set active? false]
  ]
  ask state 1 [
    ifelse Syria
    [set active? true]
    [set active? false]
  ]
  ask state 2 [
    ifelse Jordan
    [set active? true]
    [set active? false]
  ]
  ask state 3 [
    ifelse Iraq
    [set active? true]
    [set active? false]
  ]
  ask state 4 [
    ifelse Turkey
    [set active? true]
    [set active? false]
  ]
  ask state 5 [
    ifelse Egypt
    [set active? true]
    [set active? false]
  ]
  ask state 6 [
    ifelse Yemen
    [set active? true]
    [set active? false]
  ]
  ask state 7 [
    ifelse Palestine
    [set active? true]
    [set active? false]
  ]
  ask state 8 [
    ifelse Iran
    [set active? true]
    [set active? false]
  ]
  ask state 9 [
    ifelse Pakistan
    [set active? true]
  ]
end
```

```
[set active? false]
]
  ask state 10 [
ifelse UK
[set active? true]
[set active? false]
]
  ask state 11 [
ifelse US
[set active? true]
[set active? false]
]
  ask state 12 [
ifelse USSR
[set active? true]
[set active? false]
]
  ask state 13 [
ifelse UN
[set active? true]
[set active? false]
]
  ask state 14 [
ifelse France
[set active? true]
[set active? false]
]
  ask state 15 [
ifelse Lebanon
[set active? true]
[set active? false]
]
end
```



```

;; System dynamics model globals
globals [
  ;; stock values
  Salience
  System-Stability
  ;; size of each step, see SYSTEM-DYNAMICS-GO
  dt
]

;; Initializes the system dynamics model.
;; Call this in your model's SETUP procedure.
to system-dynamics-setup
  reset-ticks
  set dt 0.1
  ;; initialize stock values
  set Salience 0.16623 * (Event_Salience) ^ 3 - 3.8836 *(Event_Salience) ^ 2 + 35.066 * (Event_Salience)
  - 113.34
  set System-Stability Initial_Stability
end

;; Step through the system dynamics model by performing next iteration of Euler's method.
;; Call this in your model's GO procedure.
to system-dynamics-go

  ;; compute variable and flow values once per step
  let local-delta-stability-sd delta-stability-sd
  let local-delta-salience-sd delta-salience-sd
  let local-Delta-Stability Delta-Stability
  let local-Delta-Salience Delta-Salience

  ;; update stock values
  ;; use temporary variables so order of computation doesn't affect result.
  let new-Salience ( Salience + local-Delta-Salience )
  let new-System-Stability ( System-Stability + local-Delta-Stability )
  set Salience new-Salience
  set System-Stability new-System-Stability

  tick-advance dt
end

;; Report value of flow
to-report Delta-Stability
  report ( delta-stability-sd
  ) * dt
end

;; Report value of flow
to-report Delta-Salience
  report ( delta-salience-sd
  ) * dt
end

;; Report value of variable
to-report delta-stability-sd

```

```
    report delta-stability-ab  
end
```

```
;; Report value of variable  
to-report delta-salience-sd  
  report delta-salience-ab  
end
```

```
;; Plot the current state of the system dynamics model's stocks  
;; Call this procedure in your plot's update commands.  
to system-dynamics-do-plot  
  if plot-pen-exists? "Salience" [  
    set-current-plot-pen "Salience"  
    plotxy ticks Salience  
  ]  
  if plot-pen-exists? "System-Stability" [  
    set-current-plot-pen "System-Stability"  
    plotxy ticks System-Stability  
  ]  
end
```

REFERENCES

- Allen, T.T. (2011). *Introduction to discrete event simulation and agent-based modeling voting systems, health care, military, and manufacturing*.
<https://doi.org/10.1007/978-0-85729-139-4>
- Anagnostou, A., Nouman, A., & Taylor, S.J.E. (2013). Distributed hybrid agent-based discrete event emergency medical services simulation. *Proceedings of the 2013 Winter Simulation Conference—Simulation: Making Decisions in a Complex World, WSC 2013*, 1625–1636. Washington, DC.
<https://doi.org/10.1109/WSC.2013.6721545>
- Angerhofer, B., & Angelides, M. (2000). System dynamics modelling in supply chain management: research review. *The 2000 Winter Simulation Conference Journal*, 342–351. Orlando, FL. <https://doi.org/10.1109/WSC.2000.899737>
- Azar, E.E. (1984). Inter-university Consortium for Political and Social Research. *Conflict and Peace Data Bank (COPDAB), 1948-1978*, ICPSR07767-v4, 126–133. Retrieved from <https://doi.org/10.3886/ICPSR07767.v4>
- Badii, R., & Politi, A. (1997). *Complexity: Hierarchical structures and scaling in physics*. New York: Cambridge University Press.
- Balci, O. (2013). Verification, validation, and testing of models. *Encyclopedia of operations research and management science*. <https://doi.org/10.1007/978-1-4419-1153-7>
- Bak, P. (1996). *How nature works: The science of self-organized criticality*. New York, NY: Springer-Verlag New York, Inc.
- Banks, J., Carson, J., Nelson, B.L., & Nicol, D. (2004). Discrete-event system simulation. *PrenticeHall international series in industrial and systems engineering*, 624. <https://doi.org/10.2307/1268124>
- Bapat, V., & Sturrock, D. (2003). The ARENA Product Family: Enterprise Modeling Solutions. In *Proceedings of the 2003 Winter Simulation Conference* (pp. 150–158). <https://doi.org/10.1057/jos.2009.25>
- Barabasi, A.L. (2013). *Network science*. Retrieved from <http://barabasi.com/book/network-science>
- Berge, T. J. (2015). Procasting and Evaluating Discrete Events in Mcroeconomics and International Macroeconomics. Dissertation.
<https://doi.org/10.1017/CBO9781107415324.004>

- Bayer, R. (2006). The Correlates of War Diplomatic Exchange Data Set, v2006.1. Retrieved From <http://www.correlatesofwar.org/data-sets/diplomatic-exchange>
- Baylis, J., Smith, S., & Owens, P. (2008). Glossary. In J. Baylis, S. Smith, & P. Owens (Ed.), *The globalization of world politics: An introduction to international relations* (4th ed., pp. 577–558). Oxford, UK: Oxford University Press.
- Bennett, D.S. (2000). Landscapes as analogues of political phenomena. In D. Richards (Ed.), *Political complexity nonlinear models of politics* (pp. 46–79). Ann Arbor, MI: The University of Michigan Press.
- Bhavnani, R., Miodownik, D., & Nart, J. (2008). REscape: An agent-based framework for modeling resources, ethnicity, and conflict. *Jasss*, 11(2). Retrieved from http://papers.ssrn.com/sol3/Delivery.cfm/SSRN_ID1117204_code888867.pdf?abstractid=1117204&mirid=1
- Birkland, T.A. (2005). *An introduction to the policy process: Theories, concepts, and models of public policy making* (2nd ed.). Armonk, NY: M.E. Sharpe, Inc.
- Blechman, B. M. (1998). Middle East event / interaction data, 1949–1969 and Middle East military event data, 1949–1969, ICPSR05201-v1, 1–13. Retrieved from <http://www.icpsr.umich.edu/icpsrweb/ICPSR/studies/5201%0Ahttp://www.icpsr.umich.edu/icpsrweb/ICPSR/studies/5202>
- Bloechle, W. K., & Schunk, D. (2003, December). Micro saint sharp simulation software: micro saint sharp simulation software. In Proceedings of the 35th conference on Winter simulation: driving innovation (pp. 182-187). Winter Simulation Conference.
- Borshchev, A. (2013). *The Big Book of Simulation Modeling: Multimethod Modeling with AnyLogic 6*. Lisle, IL: AnyLogic North America.
- Borshchev, A., & Filippov, A. (2004). From system dynamics and discrete event to practical agent based modeling: Reasons, techniques, tools. *The 22nd International Conference of the System Dynamics Society*, 25–29. Oxford, England. <https://www.anylogic.ru/upload/iblock/296/296cb8fa43251a1fc803e435b93c8ff2.pdf>
- Brecher, M., Steinberg, B., & Stein, J. (1969). A framework for research on foreign policy behavior. *Journal of Conflict Resolution*, 13(1), 75–101. <https://doi.org/10.1177/002200276901300105>
- Carpenter, D.P. (2000). Stochastic prediction and estimation of nonlinear political durations: An application of the lifetime of bureaus. In D. Richards (Ed.), *Political complexity nonlinear models of politics* (pp. 209-238). Ann Arbor, MI: The University of Michigan Press.

- Cederman, L.-E. (1997). *Emergent actors in world politics: How states and nations develop and dissolve*. Princeton, NJ: Princeton University Press.
- Cederman, L.-E. (2010). Modeling the Size of Wars: From Billiard Balls to Sandpiles. *Political Science*, 97(1), 135–150. Retrieved from <https://www.cambridge.org/core/journals/american-political-science-review/article/modeling-the-size-of-wars-from-billiard-balls-to-sandpiles/84FFC9F035902B95419977608C5A628A>
- Cederman, L. E., & Girardin, L. (2007). Beyond fractionalization: Mapping ethnicity onto nationalist insurgencies. *American Political science review*, 101(1), 173-185.
- Chang, C.-L. (2004). A measure of national power. *International Seminar at the National University of Malaysia*, 34. Retrieved from <http://www.fgu.edu.tw/~academic/up1/malayconference1/paperscollection.files/conferefpapers/chang.pdf>
- Choucri, N., Electris, C., Goldsmith, D., Mistree, D., Madnick, S.E., Morrison, J.B., ... Sweitzer-Hamilton, M. (2006). Understanding & modeling state stability: Exploiting system dynamics. *2006 IEEE Aerospace Conference*, 1–11. Cambridge, MA. <https://doi.org/10.1109/AERO.2006.1656057>
- (2015). Retrieved June 10, 2016, from Conference on Complex Systems 2015: <http://www.ccs2015.org>
- Cioffi-Revilla, C. (1990). *The scientific measurement of international Conflict: Handbook of datasets on crises and wars, 1495–1988 A.D.* Boulder, CO: Lynne Rienner Publishers, Inc.
- Cioffi-Revilla, C. (1998). *Politics and uncertainty: Theory models and applications*. New York, NY: Cambridge University Press.
- Coffi-Revilla, C. (2000). War and warfare: Scales of social conflict in long-range analysis. In R.A. Denemark, J. Friedman, & B.K. Gills (Eds.), *World system history: The social science of long-term change* (pp. 253–272). New York, NY: Routledge Taylor & Francis Group.
- Cioffi-Revilla, C., & Midlarsky, M.I. (2004). Power laws, scaling, and fractals in the most lethal international and civil wars. In P.F. Diehl (Ed.), *The scourge of war: new extengions on an old problem* (pp. 3–27). Ann Arbor, MI: The University of Mlchigan Press.
- Cioffi-Revilla, C., & O'Brien, S. (2007, August). Computational analysis in US foreign and defense policy (pp. 26-36). In First International Conference on Computational Cultural Dynamics. University of Maryland, College Park, MD.

- Cioffi-Revilla, C. (2009). Simplicity and reality in computational modeling of politics. *Computational and Mathematical Organization Theory*, 15(1), 26–46.
<https://doi.org/10.1007/s10588-008-9042-2>
- Cioffi-Revilla, C., & Rouleau, M. (2009). MASON AfriLand: A regional multi-country agent-based model with cultural and environmental dynamics. *Proceedings of the Human Behavior-Computational Modeling and Interoperability Conference*. Oak Ridge, TN. Retrieved from
<http://citeseerx.ist.psu.edu/viewdoc/download?doi=10.1.1.176.7764&rep=rep1&type=pdf>
- Cioffi-Revilla, C., & Rouleau, M. (2010). MASON RebeLand: An agent-based model of politics, environment, and insurgency. *International Studies Review*, 12(1), 31–52.
<https://doi.org/10.1111/j.1468-2486.2009.00911.x>
- Concannon, K. H., Hunter, K. I., & Tremble, J. M. (2003). Dynamic scheduling II: SIMUL8-planner simulation-based planning and scheduling. In *Proceedings of the 35th conference on Winter simulation: driving innovation* (pp. 1488-1493). Winter Simulation Conference.
- Conway, A. (2013). Applications of computational methods in political science (Order No. 3591186). Available from ProQuest Dissertations & Theses Global: Social Sciences. (1433826255). Retrieved from
<https://login.ezproxy.net.ucf.edu/login?url=https://search-proquest-com.ezproxy.net.ucf.edu/docview/1433826255?accountid=10003>
- Crosbie, S.K. (1974). The end of illusion: The Six Day War and its aftermath. In S.K. Crosbie (Ed.), *A tacit alliance: France and Israel from Suez to the Six Day War* (Vol. 7, pp. 191-214). Princeton, NJ: Princeton University Press.
- Cusack, T. R., & Stoll, R. J. (1994). Collective Security and State Survival in the Interstate System. *International Studies Quarterly*, 38(1), 33–59.
<https://doi.org/10.2307/2600871>
- Dahl, R.A. (1963). *Modern political analysis*. Englewood Cliffs, NJ: Prentice-Hall, Inc.
- Department of Defense. (2013). Joint operational planning publication, JP 5-0: Doctrine for the Armed Forces of the United States. *Joint Publications*, 172. Retrieved from
http://www.dtic.mil/doctrine/new_pubs/jp1.pdf
- Diez, D.M., Barr, C.D., & Cetinkaya-Rundel, M. (2015). *OpenIntro Statistics*.
[https://doi.org/Diez, D. M., & Barr, C. D. \(n.d.\). OpenIntro Statistics Second Edition.](https://doi.org/Diez, D. M., & Barr, C. D. (n.d.). OpenIntro Statistics Second Edition.)
- Doran, J. (2005). Iruba: An agent-based model of the guerrilla war process. *Representing Social Reality of the Conference of the European Social Simulation Association (ESSA)*, 198–205.

- Dubiel, B., & Tismhoni, O. (2005). Integrating agent based modeling into a discrete event simulation. *2005 Winter Simulation Conference* (pp. 1029–1037). Orlando, FL. <https://doi.org/10.1017/CBO9781107415324.004>
- Easton, D. (1991). *The political system*. Chicago, IL: University of Chicago Press.
- Eisenstadt, S.N. (1963). *The political systems of empires*. New York, NY: The Free Press of Glencoe.
- Engineering: Materials Science and Engineering: Electronic Resources. (n.d.). Retrieved June 10, 2016, from UCF Libraries: <http://guides.ucf.edu/c.php?g=294030&p=1958539>
- Epstein, J.M., & Axtell, R. (1996). *Growing artificial societies*. Washington, DC: Brookings Institution Press.
- Epstein, J. M. (1999). Agent-based computational models and generative social science. *Complexity*, 4(5), 41–60. [https://doi.org/10.1002/\(SICI\)1099-0526\(199905/06\)4:5<41::AID-CPLX9>3.3.CO;2-6](https://doi.org/10.1002/(SICI)1099-0526(199905/06)4:5<41::AID-CPLX9>3.3.CO;2-6)
- Finan, M. B. (2001). Lecture notes in discrete mathematics, 224. <https://doi.org/10.1016/j.dam.2007.03.020>
- Fontain, R., & Burton, B.M. (2010). Eye to the future: Refocusing stated department policy planning (Policy brief). Retrieved from https://www.files.ethz.ch/isn/120595/2010-08-Eye%20to%20the%20Future_Fontaine%20Burton.pdf
- Forrester, J. W. (1958). Industrial dynamics: a major breakthrough for decision makers. *Harvard business review*, 36(4), 37-66.
- Freedman, T.L. (2006). The ten forces that flattened the world. In *The world is flat: A brief history of the twenty-first century* (pp. 51–199). New York, NY: Picador/ Farrar, Straus, Giroux.
- Google Scholar. (2004, November 4). Retrieved June 10, 2016, from Google: <https://scholar.google.com>
- Goldsmith, D., Madnick, S.E., Mistree, D., Morrison, J.B., & Siegel, M.D. (2007). Using system dynamics to model and better understand state stability using system dynamics to model and better understand state stability, (July).
- Gordon, G. (1978). The development of the General Purpose Simulation System (GPSS). *ACM SIGPLAN Notices – Special Issue: History of Programming Languages Conference*, 13(8), 183–198. <https://doi.org/10.1017/CBO9781107415324.004>

- Grömping, U. (2011). Tutorial for designing experiments using the R Package RcmdrPlugin.DoE. *Reports in Mathematics, Physics and Chemistry*, 1–54.
- Hermann, C., Hermann, M.G., Salmore, S.A., East, M.A., Salmore, B.G., & Brady, L.P. (1977). *Comparative Research on the Events of Nations (CREON) project: Foreign policy events data set*. ICPSR05205-v1. <https://doi.org/10.3886/ICPSR05205.v1>
- Harrell, C. R., & Price, R. N. (2003, December). Simulation modeling using promodel technology: simulation modeling using promodel technology. In Proceedings of the 35th conference on Winter simulation: driving innovation (pp. 175-181). Winter Simulation Conference.
- Hillson, R. (2009). The DIME/PMESII model suite requirements project. *Information for the defense community*, 3, 235–239. Retrieved from <http://oai.dtic.mil/oai/oai?verb=getRecord&metadataPrefix=html&identifier=ADA525056>
- Hudson, V.M., Schrod, P.A., & Whitmer, R.D. (2008). Discrete sequence rule models as a social science methodology: An exploratory analysis of foreign policy rule enactment within Palestinian-Israeli event data. *Foreign Policy Analysis*, 4(2), 105–126. <https://doi.org/10.1111/j.1743-8594.2007.00060.x>
- ICPSR Find & Analyze Data. (2017). Retrieved December 17, 2017, from Inter-University Consortium for Political and Social Research: <https://www.icpsr.umich.edu/icpsrweb/ICPSR/>
- Keen, D. (2012). Greed and grievance in civil war. *International Affairs*, 88(4), 757–777. <https://doi.org/10.1111/j.1468-2346.2012.01100.x>
- Kegley Jr., C.W. (2009). International decision making. In C.W. Kegley, Jr., & C. Merrill (Eds.), *World politics: trends and transformation* (12th ed., pp. 58–65). Belmont, CA: Cengage Learning.
- Kelton, W., Smith, J.S., & Sturrock, D.T. (2014). *Simio and simulation: Modeling analysis, applications* (3rd ed.). Pittsburgh, PA: Simio LLC.
- Kingdon, J.W. (1995). *Agendas, alternatives and public policy*. New York, NY: Harper Collins College Publishers.
- Krahl, D. (2003). EXTEND: An Interactive Simulation Tool. In Proceedings of the 2003 Winter Simulation Conference (pp. 150–158). <https://doi.org/10.1057/jos.2009.25>
- Krahl, D. (2003). EXTEND: An Interactive Simulation Tool. In Proceedings of the 2003 Winter Simulation Conference (pp. 150–158). <https://doi.org/10.1057/jos.2009.25>

- Law, A.M. (2015). Agent-Based Simulation and System Dynamics. In A.M. Law (Ed.), *Simulation modeling and analysis* (5th ed., pp. 693-719). New York, NY: McGraw-Hill.
- Law, A.M. (2015). Basic simulation modeling. In A.M. Law (Ed.), *Simulation modeling and analysis* (5th ed., pp. 1-78). New York, NY: McGraw-Hill.
- Lee, E.A., & Berkeley, U.C. (1997). Heterogeneous simulation—Mixing discrete-event models with dataflow, *144*, 127–144. <https://doi.org/10.1023/A:1007930622942>
- Leemis, L. M., & Park, S. K. (2006). *Discrete-event simulation: A first course*. Upper Saddle River, NJ: Pearson Prentice Hall.
- Lubyansky, A. (2011). A system dynamics and agent-based simulation approach to test group-level theories of political violence. *The 29th International Conference of the System Dynamics Society* (pp. 1–26). Washington, DC. Retrieved from <http://www.systemdynamics.org/conferences/2011/proceed/papers/P1329.pdf>
- Lubyansky, A. Y. (2014). A feedback view of theories of contentious politics (Order No. 3642425). Available from ProQuest Dissertations & Theses Global. (1624871456). Retrieved from <https://login.ezproxy.net.ucf.edu/login?url=https://search-proquest-com.ezproxy.net.ucf.edu/docview/1624871456?accountid=10003>
- Lustick, I.S., Alcorn, B., Garces, M., & Ruvinskyc, A. (2012). From theory to simulation—The dynamic political hierarchy in country virtualization models. *Journal of Experimental & Theoretical Artificial Intelligence*, *24*(3), 279–299. <https://doi.org/10.1007/s13398-014-0173-7.2>
- MacKerrow, E.P. (2003). Understanding why—Dissecting radical Islamist terrorism with agent-based simulation. *Los Alamos Science*, *28*, 184–191.
- Markt, P. L., & Mayer, M. H. (1997, January). WITNESS simulation software: a flexible suite of simulation tools. In *Winter Simulation Conference: Proceedings of the 29 th conference on Winter simulation* (Vol. 7, No. 10, pp. 711-717).
- Mcclelland, C. (1978). World Event / Interaction Survey (WEIS) project, 1966–1978. *The New York Times*. <https://doi.org/10.3886/ICPSR05211>
- McDermott, R. (1998). Introduction & prospect theory. In R. McDermote (Ed.), *Risk-taking in international politics: Prospect theory in American foreign policy* (pp. 7–44). Ann Arbor, MI: The Univeristy of Michigan Press.
- McNamara, R. (2003). Britain, Nasser and the Six Day War, 1967 & The Six Day War and Its Aftermath. In M. Robert, *Britain, Nasser and the balance of power in the Middle East, 1952–1967: From the Egyptian Revolution to the Six-Day War* (pp. 241–280). Portland, OR: Frank Cass Publishers.

- Meakin, P. (1998). *Fractals, scaling and growth far from equilibrium*. New York, NY: Cambridge University Press.
- Morgan, G.M., & Henrion, M. (1990). *Uncertainty: A guide to dealing with uncertainty in quantitative risk and policy analysis*. New York, NY: Press Syndicate of the University of Cambridge.
- Mutawi, S.A. (1987). *Jordan in the 1967 War* (1st ed.). Cambridge, UK: Cambridge University Press.
- Mykoniatis, K. (2013). A Generic Framework for Multi-Method Modeling and Simulation of Complex Systems Using Discrete Event, System Dynamics and Agent Based Approaches, 53(9), 1689–1699. <https://doi.org/10.1017/CBO9781107415324.004>
- Nordgren, W. B. (2003). FlexSim simulation environment. Proceedings of the 2003 Winter Simulation Conference, 2003., 1, 197–200. <https://doi.org/10.1109/WSC.2003.1261424>
- Nye, J. (2009). Glossary. In J. Nye, *Understanding international conflicts: An introduction to theory and history* (7th ed., pp. 289–292). New York, NY: Pearson Longman.
- Oren, M.B. (2002). *Six days of war: June 1967 and the making of the modern Middle East*. New York, NY: Oxford University Press.
- Parker, R.B. (1993). Part one: June War. In R.B. Parker, *The Politics of Miscalculation in the Middle East*, (pp. 3–122). Bloomington, IN: Indiana University Press.
- Policy File Index. (1990). Retrieved June 10, 2016, from ProQuest: <http://www.policyfile.com.ezproxy.net.ucf.edu>
- Pidd, M. (2004). *Systems modelling: Theory and practice*. John Wiley & Sons, Ltd. Retrieved from http://www.untag-smd.ac.id/files/Perpustakaan_Digital_1/DECISION%20MAKING%20Systems%20modelling,%20theory%20and%20practice.pdf#page=16
- Powersim software [Computer Software]. (2003). Retrieved From <http://www.powersim.com>
- Quandt, W.B. (2005). Yellow light: Johnson and the crisis of May–June 1967. In W.B. Quandt, *Peace process: American diplomacy and the Arab-Israeli conflict since 1967* (3rd ed., pp. 23–52). Washington, DC: Brookings Institution Press.
- Randolph, S. (2009). The 1967 Arab-Israeli war. Milestones in the history of U.S. foreign relations—Office of the historian. Retrieved from <https://history.state.gov/milestones/1961-1968/arab-israeli-war-1967>

- Ratkovic, M.T., & Eng, K.H. (2009). Finding jumps in otherwise smooth curves: Identifying critical events in political processes. *Political Analysis*, 18(1), 57–77. <https://doi.org/10.1093/pan/mpp032>
- Regan, P.M. (2005). Greed, grievance, and mobilization in civil war. *Journal of Conflict Resolution*, 49(3), 319–336. <https://doi.org/10.1177/0022002704273441>
- Ricci, V. (2005). Fitting distributions with R. Retrieved from <http://citeseerx.ist.psu.edu/viewdoc/download?doi=10.1.1.162.998&rep=rep1&type=pdf>
- Richards, D. (2000). Nonlinear modeling: All things suffer change. In D. Richards, *Political complexity: Nonlinear models of politics* (pp. 1–20). Ann Arbor, MI: The University of Michigan Press.
- Richmond, B., Peterson, S., Chichakly, K., Liu, W., & Wallis, J. (2004). Ithink Software. Isee Systems Inc, Lebanon.
- Rikhye, I.J. (1980). *The Sinai blunder: Withdrawal of the United Nations emergency force leading to the Six-Day War of June 1967*. London, UK: Frank Cass and Company Limited.
- Rohrer, M. W. (2003, December). Maximizing simulation ROI with AutoMod: maximizing simulation ROI with AutoMod. In Proceedings of the 35th conference on Winter simulation: driving innovation (pp. 201-209). Winter Simulation Conference.
- Rousseau, D., & Van der Veen, A.M. (2005). The emergence of a shared identity: An agent-based computer simulation of idea diffusion. *The Journal of Conflict Resolution*, 49(5), 686–712. <https://doi.org/10.1177/0022002705279336>
- Rousseau, D. (2006). *Identifying threats and threatening identities: The social construction of realism and liberalism*. Stanford, CA: Stanford University Press.
- Richmond, B., Peterson, S., Chichakly, K., Liu, W., & Wallis, J. (2004). Ithink software. Isee Systems Inc, Lebanon.
- Sargent, R. G. (2012). Verification and validation of simulation models, 7(1), 12–24. <https://doi.org/10.1057/jos.2012.20>
- Sarkees, M. R. (2010). Correlates of War - Interstate Wars codebook. Resort to war: a data guide to inter-state, extra-state, intra-state, and non-state wars, 1816-2007. Choice Reviews Online, 48(2), 0–3. <https://doi.org/10.5860/CHOICE.48-0637>
- Schrodt, P.A. (2000). Pattern recognition of international crises using hidden Markov models. In D. Richards, *Political complexity nonlinear models of politics* (pp. 296–328). Ann Arbor, MI: The University of Michigan Press.

- Schroeder, M.R. (1991). *Fractals, chaos, power Laws*. New York, NY: W.H. Freeman and Company.
- Segev, T. (2007). *1967: Israel, the war, and the year that transformed the Middle East* (1st ed., J. Cohen, Trans.) New York, NY: Metropolitan Books Henry Holt and Company, LLC.
- Shemesh, M. (2008). Nasir's steps toward the Six Day War: May 13 to June 5, 1967. In M. Shemesh, *Arab politics, palestinian nationalism and the Six Day War: The crystalization of Arab strategy and Nasir's descent to war, 1957–1967* (pp. 157–231). Portland, OR: Sussex Academic Press.
- Schwar, H. D., & Keefer, E. C. (Eds.). (2004). Office of the Historian. (D. o. State, Producer, & United States Government Printing Office) Retrieved December 17, 2016, from Foreign Relations of the United States, 1964-1968: <http://history.state.gov/historicaldocuments/frus1964-68v19>
- (2016). Retrieved June 10, 2016, from Social Simulation Conference 2016: <http://ssc2016.cnr.it>
- Sterman, J.D. (2000). *Business Dynamics: Systems thinking and modeling for a complex world*. New York: Irwin/McGraw Hill. <https://doi.org/10.1108/13673270210417646>
- Stokman, F.N., & Zeggelink, E.P.H. (1996). Is politics power or policy oriented? A comparative analysis of dynamic access models in policy networks. *Journal of Mathematical Sociology*, 21, 77–111. Retrieved from https://www.researchgate.net/profile/Frans_Stokman/publication/30468583_Is_Politics_Power_Or_Policy_Driven_A_Comparative_Analysis_Of_Dynamic_Access_Models_In_Policy_Networks/links/545a247a0cf2bccc49131b3f.pdf
- Taylor, C. L., & Jodice, D. A. (1983). *World Handbook of Political and Social Indicators III. Volume 2: Political Protest and Government Change, 2(III)*.
- Taber, C. S., & Tipone, R. J. (1996). Beyond Simplicity: Focused Realism and Computational Modeling in International Relations. *Modern International Studies Review*, 40, 41–79.
- Thant, U. (1978). The Six-Day War and its aftermath. In U. Thant, *View from the UN* (1st ed., pp. 253–311). Garden City, NY: Double Day & Company, Inc.
- Torraco, R. J. (2005). Writing integrative literature reviews: Guidelines and examples. *Human resource development review*, 4(3), 356-367.
- UCF Modeling and Simulation Graduate Program. (2002). Retrieved June 10, 2016, from University of Central Florida: <http://www.ist.ucf.edu/grad/alumni.html>

Venables, N. W., Smith, M. D., & Team, R. C. (2017). An Introduction to R: Version 3.4.0, 1, 1–15. Retrieved from

<http://www.math.vu.nl/stochastics/onderwijs/statlearn/R-Binder.pdf>

Ventana Systems, Inc. (2015). Vensim software. *Ventana Systems, Inc.* Retrieved from <http://vensim.com/vensim-software/>

Waldrop, M. (1992). *Complexity*. New York, NY: Simon & Schuster.

Wendt, A. (1987). The agent-structure problem in international relations theory.

International Organization, 41(3), 335–70.

<https://doi.org/10.1017/S002081830002751X>

Whittemore, R., & Knafl, K. (2005). The integrative review: Updated methodology.

Journal of Advanced Nursing, 52(5), 546–553. <https://doi.org/10.1111/j.1365-2648.2005.03621.x>

Wilensky, U. (1999). NetLogo software: User manual. *Center for Connected Learning and Computer-Based Modeling*. Evanston, IL: Northwestern University. Retrieved

from <http://ccl.northwestern.edu/netlogo/>

Wimmer, A., Cederman, L.-E., & Min, B. (2009). Ethnic politics and armed conflict: A configurational analysis of a new global data set. *American Sociological Review*,

74(2), 316–337. <https://doi.org/10.1177/000312240907400208>

Wlezien, C. (2005). On the salience of political issues: The problem with “most important problem.” *Electoral Studies*, 24(4), 555–579.

<https://doi.org/10.1016/j.electstud.2005.01.009>