Electronic Theses and Dissertations, 2004-2019

2013

Biogeography And Systematics Of The Nerodia Clarkii/nerodia Fasciata Clade In Florida

Gregory Territo
University of Central Florida



Part of the [Biology Commons](#)

Find similar works at: <https://stars.library.ucf.edu/etd>

University of Central Florida Libraries <http://library.ucf.edu>

This Masters Thesis (Open Access) is brought to you for free and open access by STARS. It has been accepted for inclusion in Electronic Theses and Dissertations, 2004-2019 by an authorized administrator of STARS. For more information, please contact STARS@ucf.edu.

STARS Citation

Territo, Gregory, "Biogeography And Systematics Of The Nerodia Clarkii/nerodia Fasciata Clade In Florida" (2013). *Electronic Theses and Dissertations, 2004-2019*. 2823.

<https://stars.library.ucf.edu/etd/2823>



BIOGEOGRAPHY AND SYSTEMATICS OF THE *NERODIA CLARKII*/*NERODIA FASCIATA* CLADE IN
FLORIDA

by

GREGORY P. TERRITO

B.S. Molecular and Microbiology, University of Central Florida, 2009

B.S. Biology, University of Central Florida, 2009

A thesis submitted in partial fulfillment of the requirements
for the degree of Master of Science
in the Department of Biology
in the College of Sciences
at the University of Central Florida
Orlando, Florida

Spring Term
2013

© 2013 Gregory P. Territo

ABSTRACT

Biogeography provides a window into the evolutionary history of populations, and helps explain the diversity and distribution of life through time. Viewed from a systematic perspective, biogeographic studies generate convincing arguments to explain the relationships among organisms and categorize them into useful taxonomies. When taxonomies do not reflect evolutionary histories, inaccurate representations of biodiversity confound future studies and conservation efforts. Two thamnophiine snakes, *Nerodia clarkii* and *Nerodia fasciata*, harbor unique morphological and ecological adaptations that obscured natural groupings, leading to controversial taxonomic delimitations. Additionally, population declines documented in *N. clarkii compressicauda* and *N. clarkii taeniata* led managers to list *N. clarkii taeniata* as threatened in 1977.

I generated a baseline for continued biogeographic and systematic study of the *Nerodia clarkii/fasciata* clade. I used mitochondrial DNA to build a parsimony-based haplotype network, infer the phylogenetic relationships between the two species and their thamnophiine relatives, and estimate the divergence times of major *N. clarkii/fasciata* clades. With these data, I tested biogeographic and systematic hypotheses about the origin and distribution of diversity in this clade. I used principal components analyses to summarize morphological data and discuss ecological observations in search of characters that may unite genetic or taxonomic units. The analyses revealed a peninsular and a panhandle clade in Florida that appeared to

diverge as a result of Pleistocene glacial fluctuations. I found no support genetically, morphologically, or ecologically for the current taxonomy, indicating a need for range-wide research to generate revised nomenclature. My results do not support the protection status of *N. clarkii taeniata*.

ACKNOWLEDGMENTS

Single-authorship is the standard for theses and dissertations, as a product of the academic process. I fear that this standard does a disservice both to the many people who contributed to the work and to the authors who garnered those collaborations. Therefore, I express my deepest gratitude to all those who helped me develop, implement, and document my research.

My committee chair, Chris Parkinson, provided immeasurable guidance, support, and friendship over the last six years. Thanks for sculpting me as a real biologist, correcting the folly of my naive, conservationist youth. I am amazed that you could see (and help inspire) a successful biologist in the 20-year old kid that approached you about catching snakes. I would also like to thank you and Cynthia for helping me garner funding throughout my graduate career. You are a fantastic duo who have kept me off the streets and in the ditches (retention ponds and salt marshes, too). I extend a special thanks to Caroline for seeing through your taunts; Mr. Greg is not a dirty hippie.

To the H in the pH lab, Eric Hoffman, thank you for keeping Chris and I grounded and focused. We had a tendency to stray off into interesting (but unnecessary) tangents, and I could always count on a five-minute talk with you to remind me that my goal should be graduation, not institutionalization. You also provided a different perspective that greatly broadened my own, and I really appreciate all of our discussions (even the heated

disagreements). Finally, your guidance with publication formatting was crucial to the structure of this document.

I thank John Fauth, my third committee member, for providing a completely novel perspective from Chris' and Eric's. You taught me how to read scientific literature critically and helped me to find more objective, clear hypotheses and methods for my research. You had the incredible ability to teach me something in every conversation we had (even the social ones), and I will continue to strive to be as well-versed as you. You set the standard for excellence with this research, and kept me on track with realistic goals when I would get discouraged and try to give up.

Four years of fieldwork, morphological data collection, and specimen preservation would not have been possible without the help of the many undergraduate assistants that I had over the years. I thank you all for the tremendous work that you did both in the field and the lab. Late, soggy nights are difficult, particularly when there are no snakes to be found (as was often the case). I especially thank Mathew Tragash for finding the first *Nerodia* during my research experience and breaking the drought of countless snake-free nights. Mat, Joshua Castro, Michael Schrum, and Jason Hickson put up with more of my antics than anyone, but I hope you'll look back on those experiences as enlightening. I also thank the countless other individuals who helped me in the field. There are too many to name and thank individually, but I appreciate all your efforts.

The pH lab, both the old and new crews, was instrumental in my successes as a researcher and a person. Juan Daza mentored me, despite my incessant disapproval of the inadequacy of scientific data. You taught me to accept that all science is “fuckin’ shit, man,” as well as how to criticize like a Colombian Ph.D. Mr. and Mrs. Tyler Hether (although not at the time) showed me how to have a good time as a scientist and taught me how to identify frog calls. Håkon Kalkvik became a good friend and GIS mentor. Jason (Texas) Strickland is my favorite Texan, with Stacy as a close second. They helped keep me sane through the bioblitz, thesis writing, and long, last-minute sampling nights. Jason (Bithlo) Hickson has been an irreplaceable field hand and cartographer. Without Bithlo, there would be no maps. Thanks to Kelly Diamond (and Corbin), Sharon Carter, Vicki Villanova, Gina Ferrie, Alexa Trujillo, Tyler Carney, Emily Pitcairn, Jessica Kenyan, Robbie McKenna, Hollis Dahn, Sarah Johnson, and Rosanna Tursi for making the lab an enjoyable environment and for putting up with my shenanigans.

One of my favorite parts about this research experience was the environment at UCF in which I worked. The Biology Department provided a very close-knit community, in which I received help from virtually all of the researching graduate students and research professors in some form. The social and intellectual environment of the department has been inspiring, and I hope that my future holds a similarly excellent work environment.

I also acknowledge and thank all of the permitting and funding agencies that facilitated my research: U. S. Fish and Wildlife Service (funding and permits), Florida Fish and Wildlife

Conservation Commission (permits), Florida Department of Environmental Protection Division of Recreation and Parks (permits), and the UCF Institutional Animal Care and Use Committee (permits). I thank Billy Brooks (USFWS) for his valuable assistance with permits, funding, and facilitating communication, Kevin Enge and Paul Moler (FWS) for guidance and sampling help, Donna Watkins (Florida DEP) for helping with permits, and Graham Williams and Alice Bard (Florida DEP) for facilitating sampling, permits, and the bioblitz.

For specimen donations, I thank the Florida Museum of Natural History, Ken Sims, Pierson Hill, and Jim Peters. Several crucial sampling gaps were filled with the donations that you provided. I also appreciate the feedback, both colloquial and scientific, that each of you provided. I hope that we continue to collaborate on future projects.

To my family, including those who I have added since I started college, I cannot thank you enough. My Mom and Dad (Angela and Joseph Territo) supported all of my decisions, no matter how crazy, throughout this research venture. Matthew and Anna kept me on an even keel and served as constant reminders that graduation is inevitable. I thank the Schrums for making me feel like family and for letting me take Michael on some ridiculous collecting trips. Michael is an outstanding, dedicated snake catcher, and he made the work infinitely more bearable at times when I had reached the end of my rope. Stewart and Talisha Bernard have been amazing friends as long as I have known them, and they let me track mud and sleep in their house while collecting snakes down south. I can always count on a phone call from Stew to bring me back to reality when I get lost in the scientific cosmos. Mary Beth and Joe

Osbourne really helped me get started in research, especially with all of the late night guidance (and Arctic Monkeys) in the lab. Allyson, William, and Aiden Fenwick helped me in more ways than I can count; suffice to say that this thesis would not have been possible without them. Thanks to John Strang, on whom I can always rely when I need an interesting conversation and a reaffirmation of my greatness. I love and thank all of you.

Gregory Territo

February 28, 2013

TABLE OF CONTENTS

LIST OF FIGURES.....	xiii
LIST OF TABLES.....	xvi
INTRODUCTION.....	1
METHODS.....	9
Sampling.....	9
Ecological Data Collection and Analysis	11
Genetic Data Collection and Analysis.....	12
Haplotype network.....	15
Cyt b haplotype phylogeny.....	15
Conservative cyt b haplotype phylogeny	16
Combined GenBank cyt b haplotype phylogeny	16
Divergence date estimation	17
Morphological Data Collection and Analysis.....	17
RESULTS.....	20
Sampling Results	20
Ecological Results	20
Genetic Results.....	24

Nuclear loci	24
Haplotype network	24
Cyt b haplotype phylogeny	28
Conservative cyt b haplotype phylogeny	30
Combined GenBank cyt b haplotype phylogeny	32
Divergence date estimation	34
Morphological Results.....	36
DISCUSSION.....	42
Sampling	42
Ecology	44
Genetics.....	47
Nuclear loci	47
Haplotype network.....	49
Cyt b phylogenies and divergence date estimation	52
Morphology.....	54
Conclusions.....	55
APPENDIX A: IMAGES OF REPRESENTATIVE <i>NERODIA CLARKII CLARKII</i>	57
APPENDIX B: IMAGES OF REPRESENTATIVE <i>NERODIA CLARKII COMPRESSICAUDA</i>	60

APPENDIX C: IMAGES OF REPRESENTATIVE <i>NERODIA CLARKII TAENIATA</i>	64
APPENDIX D: IMAGES OF REPRESENTATIVE <i>NERODIA FASCIATA FASCIATA</i>	69
APPENDIX E: IMAGES OF REPRESENTATIVE <i>NERODIA FASCIATA PICTIVENTRIS</i>	71
APPENDIX F: IMAGES OF REPRESENTATIVE QUESTIONABLE <i>NERODIA CLARKII/FASCIATA</i>	76
APPENDIX G: PHOTOS OF CLP 1187 AND OFFSPRING	88
APPENDIX H: TABLE OF SAMPLES AND LOCALITIES	90
APPENDIX I: TABLE OF GENBANK SAMPLES	100
LIST OF REFERENCES	106

LIST OF FIGURES

Figure 1. Map of subspecies distributions and sample localities (triangles) of *Nerodia clarkii* and *N. fasciata* based on Gibbons & Dorcas 2004. Blue = *N. clarkii clarkii*, green = *N. clarkii compressicauda*, orange = *N. clarkii taeniata*, red = *N. fasciata confluens*, purple = *N. fasciata fasciata*, and yellow = *N. fasciata pictiventris*. 6

Figure 2. Logistic regression demonstrating significant ($p < 0.0001$) differences in the probability of collecting *Nerodia clarkii*, *N. fasciata*, and questionable *N. clarkii/fasciata* based on the salinity (in parts per thousand, ppt) of the nearest water. Blue curves partition the probability of species identity of a sample according to salinity, where the lower third represents the probability of questionable *N. clarkii/fasciata* individuals, the middle third denotes the probability of *N. clarkii* individuals, and the upper third indicates the probability of *N. fasciata*. Dots represent individual sample points colored according to species (black = *N. clarkii*, red = *N. fasciata*, gray = questionable *N. clarkii/fasciata*). While the points are located in the appropriate third according to their species designations, their position on the y-axis is otherwise arbitrary. 23

Figure 3. Parsimony cytochrome *b* haplotype network from TCS v1.21. Circles represent distinct *cyt b* haplotypes; circle diameters, pie sizes, and numbers correlate to the number of samples with the haplotype; letters represent haplotypes; and colors represent subspecies: blue = *N. c. clarkii*, green = *N. c. compressicauda*, orange = *N. c. taeniata*, purple = *N. f. fasciata*, yellow = *N. f. pictiventris*, and gray = questionable *N. clarkii/fasciata*. 26

Figure 4. Cytochrome *b* haplotypes of *Nerodia clarkii/N. fasciata* superimposed over a map of Florida watersheds along with *cyt b* haplotype network. Colors correlate to haplotype letters; numbers on the haplotype network indicate the numbers of specimens with each haplotype. Pie slice sizes correlate to proportion of samples with a given haplotype within a watershed. . 27

Figure 5. Cytochrome *b* haplotype phylogeny of *Nerodia clarkii/N. fasciata* from MrBayes v3.2.1, with node posterior probabilities (Pp) ≥ 0.5 . Haplotype letters correlate to haplotypes from Figures 3 and 4. Colored boxes correlate haplotypes to subspecies: blue = *N. c. clarkii*, green = *N. c. compressicauda*, orange = *N. c. taeniata*, purple = *N. f. fasciata*, yellow = *N. f. pictiventris*, and gray = questionable *N. clarkii/fasciata*. Placement of haplotype EE is unresolved in this phylogeny ($Pp < 0.5$) and is not included in either the inferred peninsular or panhandle clades, although it occurs geographically in the panhandle. 29

Figure 6. Conservative cytochrome *b* haplotype phylogeny of *Nerodia clarkii*/*N. fasciata* from MrBayes v3.2.1. Node values represent posterior probabilities. Haplotype letters correlate to haplotypes from Figures 3 and 4. Colored boxes correlate haplotypes to subspecies: yellow = *N. f. pictiventris*, purple = *N. f. fasciata*, blue = *N. c. clarkii*, green = *N. c. compressicauda*, and orange = *N. c. taeniata*. Just over 0.07 substitutions per site differed between the *N. sipedon* and *N. clarkii/fasciata* clades..... 31

Figure 7. Combined GenBank cytochrome *b* haplotype phylogeny of *Thamnophiini* from MrBayes v3.2.1, with node posterior probabilities (*Pp*) ≥ 0.5. Collapsed nodes supported by *Pp* ≥ 0.95 and contain ≥ 15 individuals. 33

Figure 8. Chronogram generated by BEAST v1.7.4 with magnified view of the *N. clarkii/fasciata/harteri/sipedon* clade. Gray bars represent 95% confidence intervals for divergence date estimates, with node posterior probabilities (*Pp*) ≥ 0.5. Collapsed nodes supported by *Pp* ≥ 0.95 and contain ≥ 15 individuals. Asterisk demonstrates the phylogenetic position of the magnified clade. 35

Figure 9. Graph of PC1 plotted against PC2 from the Principal Components (PC) Analysis of 10 morphological characters for 138 individuals of *Nerodia clarkii*/*N. fasciata* from Florida. Points represent individuals within morphospace; colors correlate to cytochrome *b* haplotypes and correspond to the colors used in the haplotype network (Fig. 4). 38

Figure 10. Graph of PC1 plotted against PC2 from the Principal Components (PC) Analysis of 10 morphological characters for 138 individuals *Nerodia clarkii*/*N. fasciata* from Florida. Points represent individuals within morphospace; colors correlate to phylogenetic clades: black = peninsular clade, gray = panhandle clade. 39

Figure 11. Graph of PC1 plotted against PC2 from the Principal Components Analysis of 10 morphological characters for 141 individuals *Nerodia clarkii*/*N. fasciata* from Florida. Points represent individuals within morphospace; colors correlate to subspecies designations: blue = *N. c. clarkii*, green = *N. c. compressicauda*, orange = *N. c. taeniata*, purple = *N. f. fasciata*, yellow = *N. f. pictiventris*, and gray = questionable *N. clarkii/fasciata*. 40

Figure 12. Graph of PC1 plotted against PC2 from the Principal Components (PC) Analysis of 9 morphological characters for 141 individuals *Nerodia clarkii*/*N. fasciata* from Florida. Points represent individuals within morphospace; colors correlate to subspecies designations: blue =

N. c. clarkii, green = *N. c. compressicauda*, orange = *N. c. taeniata*, purple = *N. f. fasciata*, yellow = *N. f. pictiventris*, and gray = questionable *N. clarkii/fasciata*..... 41

LIST OF TABLES

Table 1. List of PCR conditions and primer sequences for each locus amplified in <i>Nerodia clarkii/N. fasciata</i> collected in Florida.	14
Table 2. Minimum (MIN), maximum (MAX), and median (MED) values of 23 morphological characters collected for <i>Nerodia clarkii/N. fasciata</i> in Florida, according to the full dataset (All Samples) or by subspecies. DORS A = anterior dorsal scale counts, DORS M = midbody dorsal scale counts, DORS P = posterior dorsal scale counts, SUPL L = left supralabials, SUPL R = right supralabials, INFL L = left infralabials, INFL R = right infralabials, PRO L = left preoculars, PRO R = right preoculars, POO L = left postoculars, POO R = right postoculars, LIO L = left labials in orbit, LIO R = right labials in orbit, VEN = ventrals, ANT L = left anterior temporals, ANT R = right anterior temporals, POT L = left posterior temporals, POT R = right posterior temporals, ANTK L = keeled left anterior temporals, ANTK R = keeled right anterior temporals, POTK L = keeled left posterior temporals, POTK R = keeled right posterior temporals, and SUBC = subcaudals. * denotes characters included in the Principal Components Analyses.....	19
Table 3. List of eigenvalues and character weightings for Principal Components 1, 2, and 3 grouped according to haplotypes, clades, subspecies, and subspecies excluding dorsals at midbody.	37

INTRODUCTION

While biogeographic studies can identify patterns and processes that lead to population diversification, a critical first step is identifying and classifying extant variation. Studies can be misled if evolutionary relationships among taxa of interest are not well established, or if these relationships are not properly communicated through a clear taxonomy. Incorrect assumptions of relatedness detrimentally impact the interpretations and applications of research findings. One typical assumption is using morphologically-defined taxa to represent heritable, evolutionary groups. Research demonstrated cases where morphological taxa correlate to genetic taxa (*Sylvilagus spp.*, Lee et al., 2010; *Trhypochthonius spp.*, Heethoff et al., 2011), where genetic variation occurs despite lack of morphological distinction (*Aspidomorphus spp.*: Metzger et al., 2010; *Acropora spp.*: Ladner & Palumbi, 2012), where morphologically-disparate taxa exist which lack genetic distinctness (*Puma concolor coryi*: Culver et al., 2000; Florida Grasshopper Sparrow: Bulgin et al., 2003; *Sylvilagus palustris*: Tursi et al., 2012), and where analyses based on morphological taxa provided different relationships from those using genetic data (Urodela: Wiens et al., 2005). Currently, researchers expect taxonomic names to communicate information about the groups they describe. In particular, taxonomic groups should represent evolutionary units: populations of organisms that share a common ancestry, heritable traits, and a common evolutionary fate. Researchers increasingly cite the unified species concept as the preferred species criterion, in which species represent independently-evolving lineages (de Queiroz, 2007). Additionally, applications of misinformed taxonomies, such as the use of *Puma concolor coryi* (Florida Panther) as a conservation unit, can impede

scientific and technological progress, confound conservation objectives, and result in inefficient resource allocation. Because most research, conservation strategies, and biological management practices are taxon focused, systematists and taxonomists should rigorously assess evolutionary relationships of organisms and historical nomenclature to generate informed, evolutionarily-relevant taxonomies.

Once systematists categorize and name evolutionary lineages, biogeographers can formulate and test hypotheses explaining lineage distribution and diversification. Many biogeographic studies of North American fauna commonly find a phylogeographic break occurring in northwest Florida (Burbrink et al., 2000; Pauly et al., 2007; Burbrink et al., 2008; Guiher & Burbrink, 2008; Douglas et al., 2009; Butler et al., 2011; Campbell-Staton et al., 2012). Peninsular Florida served as a refuge from Quaternary glacial, climate, and sea level fluctuations, often leaving a genetic signature of isolation between the descendants of populations surviving in Florida and those that survived elsewhere on the continent (Avice, 1992; Hewitt, 1996; Soltis et al., 2006). As glaciers or sea levels receded or climates became more favorable, populations that persisted in Florida moved northward where secondary contact occurred from continental populations that persisted through the climate changes (Swenson & Howard, 2005).

Natricinae, commonly referred to as the water snakes, is a subfamily of colubrids endemic to both Old and New World locales, ranging in Africa, Europe, Asia, and throughout North America (Malnate, 1960). As their common name suggests, many natricine snakes reside

in mesic environments and readily take to the water for refuge or to hunt fish, amphibians, and aquatic invertebrates, though several do thrive in arid environments (Malnate, 1960; Gibbons & Dorcas, 2004). Research supports the monophyly of natricine snakes excluding the *incertae sedis* *Psammodynastes* spp. (Lawson et al., 2005; Pyron et al., 2011), which some researchers place in Natricinae (Zaher, 1999). Data also support the Asian origin of Natricinae and many broad-scale biogeographic hypotheses on the origins of major clades within the lineage (Guo et al., 2012). The New World natricines (tribe Thamnophiini) consist of a single, monophyletic clade of North American snakes in the following genera: garter snakes (*Thamnophis* spp.), crayfish and queen snakes (*Regina*), mountain meadow snakes (*Adelophis*), Kirtland's snake (*Clonophis*), swamp snakes (*Seminatrix*), brown snakes (*Storeria*), lined snakes (*Tropidoclonion*), earth snakes (*Virginia*), and water snakes (*Nerodia*) (Rossman & Eberle, 1977; Alfaro & Arnold, 2001; de Queiroz et al., 2002; Guo et al., 2012). These genera span several habitat types and potential biogeographic barriers, making the Thamnophiini a good group in which to test biogeographic hypotheses. Phylogenetic inference also demonstrated paraphyly and polyphyly of several thamnophiine genera and species, leaving several relationships unresolved and demonstrating a need for finer-scale biogeographic study (Lawson, 1987; Guo et al., 2012).

Florida's geographic history likely affected the evolution of *Nerodia clarkii* (Salt Marsh Snake, Baird & Girard 1853) and *Nerodia fasciata* (Banded Water Snake, Linnaeus 1766), two thamnophiine species. The systematic and taxonomic histories of these two snakes remain a topic of controversy, debated since the 1800's (Baird & Girard, 1853; Kennicott, 1860; Cope, 1895; Carr & Goin, 1942; Kochman, 1977; Dunson, 1979; Lawson et al., 1991). Despite these

disagreements, scientists assume a sister relationship between the two species because of their similar ecology, behavior, morphologies, and completely overlapping distributions (See Figure 1; Conant & Collins, 1998; Gibbons & Dorcas, 2004). Some studies synonymize *N. clarkii* and *N. fasciata*, either both as members of *N. fasciata* (Conant, 1963; Lawson et al. 1991), or as members of the related species *N. sipedon* (the Northern Water Snake; Clay, 1938; Cliburn, 1957). Differences in experimental salinity tolerances (Pettus, 1958, 1963; Kochman, 1977; Dunson, 1978, 1980) and allozyme signatures (Lawson et al., 1991) led to the inference of two species. However, Jansen (2001) reanalyzed the dataset of Lawson et al. (1991) and found no statistical support for the differences between *N. fasciata* and *N. clarkii*. In addition, several studies reported morphological and ecological intermediates between *N. clarkii* and *N. fasciata* and concluded that hybridization occurs throughout Florida (Carr & Goin, 1942; Lawson et al., 1991; Goode et al., 1992). According to the current taxonomy, *N. clarkii* and *N. fasciata* each contain three subspecies: *N. clarkii clarkii* (Gulf Coast Salt Marsh Snake; Baird & Girard, 1853), *N. clarkii compressicauda* (Mangrove Salt Marsh Snake; Kennicott, 1860), *N. clarkii taeniata* (Atlantic Salt Marsh Snake; Cope, 1895), *N. fasciata fasciata* (Southern Water Snake; Linnaeus, 1766), *N. fasciata pictiventris* (Florida Water Snake; Cope, 1895), and *N. fasciata confluens* (Broad-banded Water Snake; Blanchard, 1923). All subspecies exist in Florida except *N. f. confluens*; three exist exclusively in Florida and Cuba: *N. f. pictiventris*, *N. c. compressicauda*, and *N. c. taeniata* (Gibbons and Dorcas 2004). A narrow distribution, prevalence of apparent hybrids with *N. f. pictiventris*, and significant habitat loss led the U.S. Fish and Wildlife Service to list *N. clarkii taeniata* as threatened in 1977 (USFWS, 1977, 1993; Brooks 2008). In the U. S. Fish

and Wildlife Service five year review, Brooks (2008) states that the population status of *N. c. taeniata* remains unknown, which precludes assessment of recovery criteria for this threatened taxon.

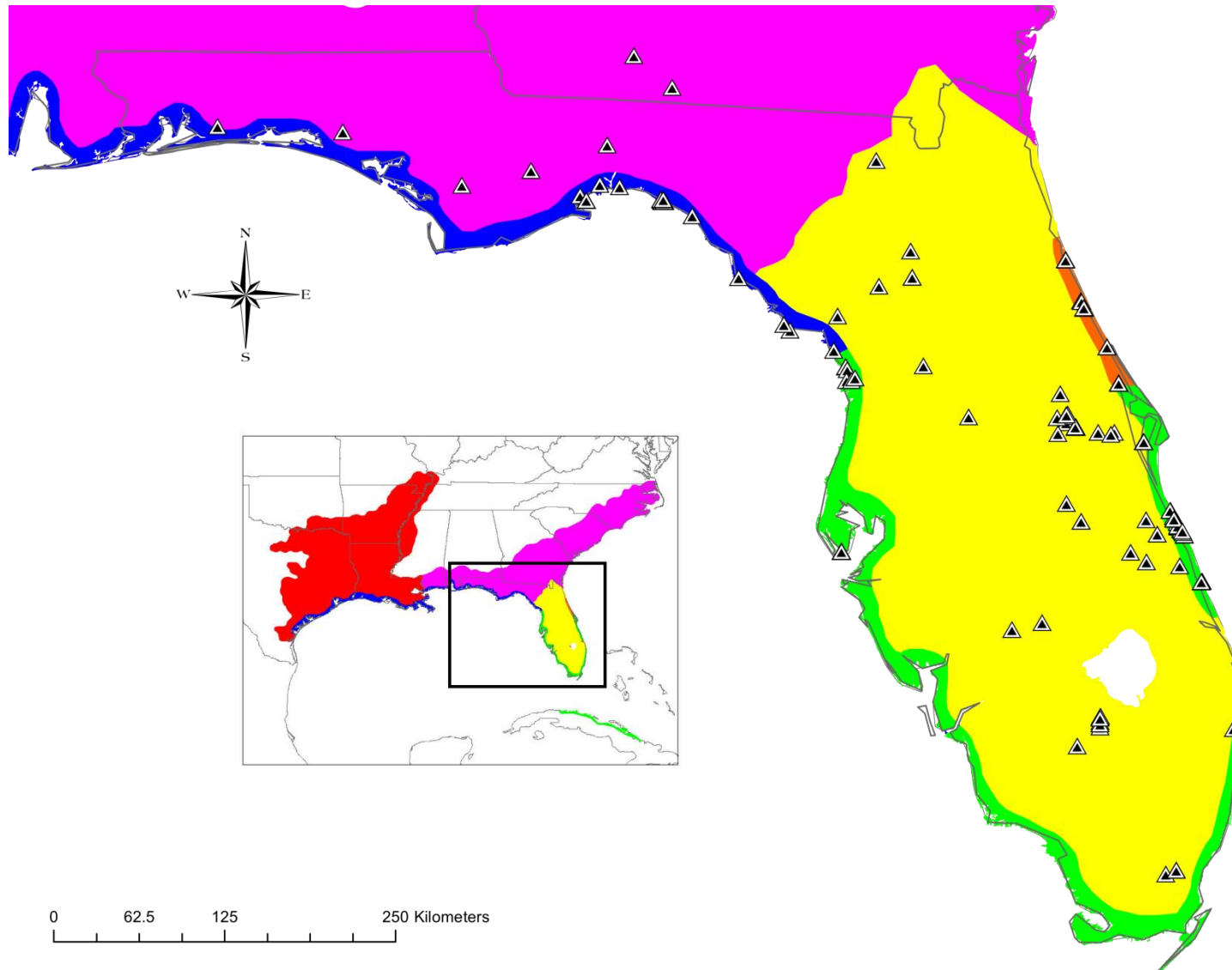

Figure 1. Map of subspecies distributions and sample localities (triangles) of *Nerodia clarkii* and *N. fasciata* based on Gibbons & Dorcas 2004. Blue = *N. clarkii clarkii*, green = *N. clarkii compressicauda*, orange = *N. clarkii taeniata*, red = *N. fasciata confluens*, purple = *N. fasciata fasciata*, and yellow = *N. fasciata pictiventris*.

Researchers struggled to elucidate patterns and processes that gave rise to the variation observed in *N. clarkii* and *N. fasciata*, due largely to the lack of genetic data. In 1942, Carr and Goin generated a hypothesis to explain how the variation among the three *N. clarkii* subspecies evolved. They proposed that during the latest Pleistocene interglacial cycle, sea-level rise flooded much of Florida, leaving small islands isolated from the continent. Associated with this split, they suggested that continental populations maintained a predominantly striped phenotype while island populations comprised mostly unstriped individuals. They hypothesized that the unstriped populations evolved into *N. clarkii compressicauda* and subsequent sea-level retreat created inhospitable inland habitat which isolated two striped populations (one on the Gulf coast, and another on Florida's Atlantic coast), giving rise to *N. clarkii clarkii* and *N. clarkii taeniata*. When the islands reconnected with the North American continent, *N. clarkii compressicauda* came into secondary contact with its conspecifics. Therefore, based upon similarities in phenotype, behavior, and latitudinal distribution, Carr and Goin (1942) hypothesized that *N. clarkii compressicauda* diverged from a common ancestor with the more closely-related *N. clarkii clarkii* and *N. clarkii taeniata*.

My thesis combined genetic, morphological, and ecological data to understand the evolutionary relationships of *N. clarkii* and *N. fasciata* in Florida (systematics) and to estimate phylogeographic patterns within these species (biogeography). I performed a logistic regression to assess the effect of salinity on species presence as a metric of ecological divergence between taxa. I used Bayesian phylogenetic inference of 974 bases of the mitochondrial cytochrome *b* gene (*cyt b*) and a combined 2896 bases of nuclear DNA data to

test the hypotheses that *N. clarkii* is a monophyletic sister species to *N. fasciata* and that the three *N. clarkii* subspecies represent monophyletic units. Additionally, I generated a parsimony-based haplotype network from the *cyt b* data to determine whether the *N. clarkii* and *N. fasciata* subspecies formed haplotype clusters according to their subspecies designations. This approach tested Carr and Goin's (1942) hypothesis that *N. clarkii compressicauda* diverged from a common ancestor with the monophyletic *N. clarkii clarkii/N. clarkii taeniata* clade. I also incorporated data from GenBank to confirm placement of the *N. clarkii/fasciata* clade within the New World Natricine clade, *Thamnophiini*. I used fossil calibrations to estimate divergence times of lineages within the *N. clarkii/fasciata* clade, and combined these and geographic data to search for phylogeographic breaks congruent with those in other studies (e.g. Soltis et al. 2006). These phylogenetic data can be used to better inform taxonomic classification of *N. clarkii* and *N. fasciata*, and thereby their conservation status. Finally, I assessed the correlation between morphology and genetics in these two species and plotted *cyt b* variation on a map to determine the geographic distribution of haplotypes throughout Florida.

METHODS

Sampling

I employed three methods to collect snakes for this study: 1) I deployed eel pot and minnow-style funnel traps, 2) I drove slowly down low-traffic roads and collected any road-killed or live snakes on or adjacent to the road, and 3) I hand-captured snakes through visual searches on foot or in canoes in wetlands throughout Florida. I selected sample sites according to 1) published research and range maps of *N. clarkii* and *N. fasciata*, 2) anecdotal accounts from scientists and community members, and 3) identification of suitable habitats using online and print maps (Google Maps: <https://maps.google.com/>, Google Earth, Florida atlas). See Figure 1 for a map of sample localities. I placed a closed, empty bottle (20 oz Gatorade bottle or equivalent, cleaned with the label removed) inside of each trap and then secured the traps in place by sliding a 6 foot bamboo rod through the ring of the minnow trap/eel pot clip and into the ground. This configuration maintained an air pocket in the trap and allowed it to float or sink vertically with the tides, so that roughly two-thirds of the trap remained underwater throughout the trapping effort. I checked the traps three times per day while deployed, in accordance with my collection permit requirements. To increase my sample size and better understand the distribution and abundance of *N. clarkii taeniata*, I also organized a water snake bioblitz in the Tomoka Basin. This endeavor consisted of 5 days of intense sampling by 22 volunteers on foot, via canoe, or by road cruising. To supplement field collections, I obtained

68 samples from donations by private individuals, 25 tissues from Pierson Hill at Florida State University, and 28 tissues from the Florida Museum of Natural History.

The repeatability of biological studies often necessitates collecting voucher specimens, particularly for taxonomic and molecular phylogenetic research (Martin 1990, Funk et al. 2005, Pleijel et al. 2008). I therefore collected tissue and specimen vouchers for most of my samples (I will deposit voucher specimens in the Florida Museum of Natural History for permanent storage). I scale-clipped for tissue and permanent identification (following the method of Brown & Parker, 1976) protected taxa (*N. clarkii taeniata*) and those that otherwise could not be vouchered before releasing them at the site of capture. I injected PIT-tags into all collected *N. clarkii taeniata* prior to release, for a reliable means of permanent identification. I took photographic and tissue vouchers for all of the specimens that I released.

To conservatively test monophyly of *N. clarkii*, I assigned taxon names to specimens according to Cope's (1860a, 1860b, 1895, 1898) descriptions. I built a dichotomous key (below) from Cope's research because he published descriptions of all currently-named morphotypes in Florida for this species complex. As such, I aimed to reduce bias in my taxonomic designations by limiting the descriptions to a single researcher instead of trying to match characters, names, and descriptions from multiple authors.

- 1) Oculars; scale rows 1-3, 19-21, ***N. clarkii*** (2)
1-2-3, 23-25, brown transverse bands along the length of the dorsum, ***N. fasciata***
- 2) 4 longitudinal dorsal stripes on length of body, ***N. clarkii clarkii***
on neck only, (3)
- 3) 4 rows of longitudinal dorsal blotches, the median pair forming stripes anteriorly over the greater length of the body; venter black with median, yellow halfmoon pattern,
N. clarkii taeniata
4 longitudinal dorsal stripes on neck only; dark dorsal crossbands anteriorly, three rows of blotches posteriorly; venter not black, with median, yellow halfmoon pattern,
– or –
Yellow-ish ferruginous dorsum with darker, indistinct half-bands which become fully transverse posteriorly; venter salmon, with yellow centers that have darker borders, darkening to orange-ish ferruginous posteriorly,
– or –
Dorsum black-ish brown, pale, barely visible, oblique crossbands; venter stone brown with central, elliptical, yellow spots which narrow and break posteriorly,
N. clarkii compressicauda

I used the distribution map from Conant and Collins (1998) to assign samples which keyed as *N. fasciata* to either *N. fasciata fasciata* or *N. fasciata pictiventris*. I placed snakes with intermediate phenotypes (e.g. 23 scale rows at mid body and a completely striped dorsum) in the questionable *N. clarkii/fasciata* category. I used the taxonomic names provided by Kenneth R. Sims and the Florida Museum of Natural History for the samples that they donated.

Ecological Data Collection and Analysis

I recorded salinity of the nearest appreciable water source for each snake collected using a refractometer. I also recorded several qualitative environmental and climate characteristics, including vegetation types, general weather conditions, moon phase, and observations of other species. I induced regurgitation of food from captured snakes when

possible to qualitatively assess diet. Due to inconsistencies in data collection, I only analyzed the salinity data. To do so I performed a logistic regression using salinity as my predictor and species as my response variables. I used the mean salinity for any snake with multiple salinity values (either from recapture data or multiple nearby water bodies) in the logistic regression.

Genetic Data Collection and Analysis

I isolated DNA from tissue samples using a Qiagen DNeasy Blood & Tissue Kit and then checked the extract for quantity and quality using gel electrophoresis. I used the polymerase chain reaction method (PCR) to amplify the mitochondrial protein-coding gene cytochrome *b* (*cyt b*) from 230 individuals, the nuclear protein-coding recombinase activating gene 1 (RAG1) from 12 individuals (three *N. clarkii clarkii*, one *N. clarkii taeniata*, seven *N. fasciata pictiventris*, and one *N. clarkii/fasciata* questionable), and three nuclear introns: β -spectrin nonerythrocytic intron 1 (SPTBN1) from four individuals (four *N. fasciata pictiventris*), ribosomal protein S8 (RPS8) from 18 individuals (three *N. clarkii clarkii*, two *N. clarkii compressicauda*, two *N. clarkii taeniata*, two *N. fasciata fasciata*, three *N. fasciata pictiventris*, and six *N. clarkii/fasciata* questionable), and selenoprotein T (SELT) from 15 individuals (one *N. clarkii clarkii*, two *N. clarkii compressicauda*, two *N. clarkii taeniata*, one *N. fasciata fasciata*, three *N. fasciata pictiventris*, and six *N. clarkii/fasciata* questionable). Table 1 lists the PCR conditions for each locus. I generated internal primers to amplify *cyt b* in samples with degraded DNA (many of the road-killed or donated specimens). I ran 30 μ L PCR reactions and prepared each sample for sequencing with the IBI Gel/PCR DNA Fragments Extraction Kit and protocol. Some samples

failed to amplify with high enough yields to sequence; in these instances, I repeated the PCR reactions and used the IBI Gel/PCR DNA Fragments Extraction Kit and protocol to concentrate the combined products. After fragment extraction, I sent PCR products to the University of Arizona Genetics Core to sequence both forward and reverse directions for each sample. I checked my sequencing results for ambiguous or erroneous calls in Sequencher 4.8 (Gene Codes Corporation). I designated ambiguous peaks with the appropriate IUPAC ambiguity code and removed miscalled indels. I aligned sequences in GeneDoc v2.7.0 (Nicholas et al., 1997) by a combination of automatic and visual editing. I trimmed the ends of the alignment until 70% of samples displayed complete data.

Table 1. List of PCR conditions and primer sequences for each locus amplified in *Nerodia clarkii*/*N. fasciata* collected in Florida.

Locus	Primers	Temp. (°C)	MgCl ₂ (mM)	Reference
cyt <i>b</i>	L14910 5'-GAC CTG TGA TMT GAA AAA CCA YCG TTG T-3' H16064 5'-CTT TGG TTT ACA AGA ACA ATG CTT TA-3'	46	2.0	Burbrink et al. 2000 Burbrink et al. 2000
5' cyt <i>b</i>	L14910 5'-GAC CTG TGA TMT GAA AAA CCA YCG TTG T-3' NercybtR607 5'-TCA ATG TCT GAG TTT GTT CCT AAG G-3'	46	2.0	Burbrink et al. 2000 This study
mid cyt <i>b</i>	NercybtF249 5'-CAC ATT GCA CGA GGA CTT TAT TAC G-3' NercybtR973 5'-GAT CAG GTG ATT ATG ATG AAA GTA GCG-3'	46	2.0	This study This study
SPTBN1	SPTBN1-F1 5'-TCT CAA GAC TAT GGC AAA CA-3' SPTBN1-R1 5'-CTG CCA TCT CCC AGA AGA A-3'	54	1.0	Matthee et al. 2001; Metzger et al. 2009 Matthee et al. 2001; Metzger et al. 2009
RAG1	G396 (R13) 5'-TCT GAA TGG AAA TTC AAG CTG TT-3' G397 (R18) 5'-GAT GCT GCC TCG GTC GGC CAC CTT T-3'	55	2.5	Groth & Barrowclough 1999; Metzger et al. 2009 Groth & Barrowclough 1999; Metzger et al. 2009
RPS8	RPS8_F 5'-CGG AAA AAG AAT GCY AAG ATC AGT AG-3' RPS8_R 5'-GTA GCC ATC TGC TCG GCC ACA TTG TCC-3'	50	1.0	Julianne Goldenberg, pers. comm., originally from Dean Leavitt Julianne Goldenberg, pers. comm., originally from Dean Leavitt
SELT	SELT2_F 5'-GTT ATY AGC CAG CGG TAC CCA GAC ATC CG-3' SELT2_R 5'-GCC TAT TAA YAC TAG TTT GAA GAC TGA CAG-3'	50	1.0	Julianne Goldenberg, pers. comm., originally from Dean Leavitt Julianne Goldenberg, pers. comm., originally from Dean Leavitt

Haplotype network

I generated a parsimony-based haplotype network of *cyt b* data in TCS v1.21 (Clement et al., 2000) and color-coded the network according to subspecies designations to infer relationships of haplotypes between *N. clarkii* and *N. fasciata* subspecies. I also plotted pie graphs of *cyt b* haplotype frequencies on a map of Florida according to watersheds in ArcMap 10.1 (ESRI, Redlands, CA, USA).

Cyt b haplotype phylogeny

Using the output from TCS, I consolidated my *cyt b* alignment into one consisting of only distinct haplotypes, so it contained only one representative of each haplotype. I then employed the program MrBayes v3.2.1 (Huelsenbeck & Ronquist, 2001; Ronquist & Huelsenbeck, 2003) to infer a Bayesian haplotype phylogeny. Based on published work I designated my *N. floridana* sample as the outgroup for the analysis, but I also included three *N. sipedon* (GenBank accession #: GQ285445, JF964960, and AF402913) and three *N. erythrogaster* (GenBank accession #: AF337099, AF420081, and AF402912) samples from GenBank as additional outgroups. I performed analyses on the *cyt b* dataset in 3 ways: 1) unpartitioned, 2) partitioned by codon position, and 3) partitioned by third codon position. I used MrModelTest v2.2 (Nylander, 2004) to select the most supported model of evolution for each partition. For each partitioning strategy, I ran MrBayes for 3×10^6 generations, sampling every 100 trees. I implemented the following models of evolution: 1) HKY + I (second codon position and unpartitioned run), 2) HKY + G (first codon position and combined first and second codon

positions), and 3) GTR + G (third codon position). After analyses, I used Tracer v1.5 (Rambaut & Drummond, 2007) to confirm stationarity and sufficient sampling of the posterior and used Bayes factors to determine which partitioning strategy produced the best-fitting phylogeny from the data.

Conservative cyt b haplotype phylogeny

I also built an alignment of *cyt b* sequences from 78 specimens (22 *N. clarkii clarkii*, 3 *N. clarkii taeniata*, 1 *N. clarkii compressicauda*, 5 *N. fasciata fasciata*, and 47 *N. fasciata pictiventris*) from sample sites in which all individuals could be unambiguously assigned to one taxon according to the aforementioned dichotomous key. I then reduced this alignment to represent unique *cyt b* haplotypes within this subsample of individuals and inferred a second phylogeny following the previously described methodologies. This approach reduced the likelihood of genetic influence from potential hybridization between lineages and provided a conservative estimate of phylogenetic relationships of the *N. clarkii* and *N. fasciata* species.

Combined GenBank cyt b haplotype phylogeny

To determine placement of the *clarkii/fasciata* clade within water snakes, I obtained all available GenBank sequences of *cyt b* for new world natricine snakes and several old world outgroups (Appendix I). I then consolidated this dataset to the unique haplotypes and inferred a third phylogeny in MrBayes v3.2.1 combining my data and the GenBank data, using methods described above with the following changes: I ran MrBayes for 5×10^6 generations and applied GTR + I + G (first codon position, second codon position, combined first and second codon

positions, and unpartitioned run) or GTR + G (third codon position) as my models of evolution. I then compared my results to the seven-locus phylogram of Guo et al. (2012).

Divergence date estimation

While researchers proposed divergence times for lineages within *N. clarkii* (Carr & Goin, 1942; Lawson et al., 1991), no studies explicitly test node ages within it. Guo et al. (2012) estimated divergence times for most natricine clades but excluded *N. clarkii* from their analyses. I used BEAST v1.7.4 (Drummond et al., 2012) to estimate phylogenetic relationships and node divergence dates for my combined GenBank dataset. I used three partitions (by codon position) and followed the methods of Guo et al. (2012) with minor changes described below. I only included the genus *Natrix* from the old-world natricines, so I used two fossil calibrations: I set lognormal priors for the time to the most recent common ancestor (tMRCA) of *Natrix* with a mean of 22 million years ago (Ma) and the tMRCA of *Thamnophis* with a mean of 16 Ma, both with a standard deviation of 0.15 and no offset. I also used uniform priors, as opposed to Jeffrey's priors, on my substitution model parameters and I applied a uniform prior (initial value = 1, upper = 5, lower = 0) to the uncorrelated lognormal relaxed clock mean. I ran the analysis twice for 5×10^7 generations each, and verified stationarity and sufficient sampling for each parameter in Tracer v1.5.

Morphological Data Collection and Analysis

I measured snout-vent length and tail length to the nearest millimeter, post mortem (unless snakes were released), using a measuring tape. I counted dorsals two head lengths

behind the head, at mid-body, and two head lengths in front of the tail. I counted an additional 20 scale characters (Table 2). I counted subcaudal scales, including those from individuals with damaged or incomplete tails, so I excluded subcaudals from my analyses. I used a balance to measure the mass of each specimen to the nearest gram and sexed each snake by a combination of visual inspection, probing, and hemipene eversion. I qualitatively described each snake's coloration and pattern and used a scanner to record their images.

I used Principal Components Analysis (PCA) to summarize 10 scale-count characters from 138 individuals (Table 2). I analyzed the means of characters with left/right symmetry and I used log-transformed dorsal scale rows (anterior, midbody, and posterior) and ventrals. I excluded posterior dorsal scale rows and anterior temporals from my analyses due to strong correlations with other characters. I then plotted a graph of the first and second principal components (PC1 and PC2, respectively) and superimposed minimum convex polygons (MCPs) over the graph. I grouped samples within polygons according to the *cyt b* haplotypes and clades from my phylogenetic results. I collected morphological data (but lacked genetic data) for additional individuals, so I created a second PCA using 141 specimens and superimposed MCPs based on subspecies designations. I used dorsals at midbody to assign snakes to species, so I generated a third PCA of 141 samples, excluding dorsals at midbody, and superimposed MCPs according to subspecies designations.

Table 2. Minimum (MIN), maximum (MAX), and median (MED) values of 23 morphological characters collected for *Nerodia clarkii*/*N. fasciata* in Florida, according to the full dataset (All Samples) or by subspecies. DORS A = anterior dorsal scale counts, DORS M = midbody dorsal scale counts, DORS P = posterior dorsal scale counts, SUPL L = left supralabials, SUPL R = right supralabials, INFL L = left infralabials, INFL R = right infralabials, PRO L = left preoculars, PRO R = right preoculars, POO L = left postoculars, POO R = right postoculars, LIO L = left labials in orbit, LIO R = right labials in orbit, VEN = ventrals, ANT L = left anterior temporals, ANT R = right anterior temporals, POT L = left posterior temporals, POT R = right posterior temporals, ANTK L = keeled left anterior temporals, ANTK R = keeled right anterior temporals, POTK L = keeled left posterior temporals, POTK R = keeled right posterior temporals, and SUBC = subcaudals. * denotes characters included in the Principal Components Analyses.

Character	All Samples			<i>N. c. clarkii</i>			<i>N. c. compressicauda</i>			<i>N. c. taeniata</i>			<i>N. f. fasciata</i>	<i>N. f. pictiventris</i>			Questionable		
	N = 141			N = 18			N = 19			N = 2			N = 1	N = 59			N = 42		
	MIN	MAX	MED	MIN	MAX	MED	MIN	MAX	MED	MIN	MAX	MED	Values	MIN	MAX	MED	MIN	MAX	MED
*DORS A	19	24	21	19	21	21	19	21	21	21	21	21	23	21	24	23	19	23	21
*DORS M	20	25	23	20	21	21	20	21	21	21	21	21	23	23	25	23	21	25	22
DORS P	16	21	19	17	19	17	17	19	18	17	17	17	19	16	21	19	17	20	19
*SUPL L	8	10	8	8	9	8	8	10	8	8	8	8	8	8	9	8	8	9	8
*SUPL R	7	9	8	8	9	8	8	8	8	8	8	8	8	7	9	8	8	9	8
*INFL L	8	10	9	9	10	9	9	9	9	9	9	9	9	8	10	9	9	10	9
*INFL R	7	10	9	8	10	9	7	9	9	8	9	8.5	9	8	10	9	8	10	9
PRO L	1	1	1	1	1	1	1	1	1	1	1	1	1	1	1	1	1	1	1
PRO R	1	1	1	1	1	1	1	1	1	1	1	1	1	1	1	1	1	1	1
*POO L	1	4	3	2	3	3	2	3	3	2	2	2	3	2	4	3	1	3	3
*POO R	1	3	3	2	3	3	1	3	3	2	2	2	3	2	3	3	2	3	3
*LIO L	1	3	2	1	2	2	1	3	2	2	2	2	2	1	2	2	1	2	2
*LIO R	1	2	2	1	2	2	1	2	2	2	2	2	2	1	2	1	1	2	2
*VEN	121	136	128	126	136	131.5	125	131	130	129	129	129	131	122	130	126	121	135	129
ANT L	1	2	1	1	1	1	1	2	1	1	1	1	1	1	1	1	1	2	1
ANT R	1	2	1	1	1	1	1	2	1	1	1	1	1	1	2	1	1	2	1
*POT L	2	4	3	2	3	3	2	4	3	2	2	2	3	2	4	3	2	4	3
*POT R	2	4	3	2	3	3	2	4	3	2	3	2.5	3	2	3	3	2	4	3
*ANTK L	0	1	0	0	0	0	0	1	0	0	0	0	0	0	1	0	0	1	0
*ANTK R	0	1	0	0	0	0	0	1	0	0	0	0	0	0	1	0	0	1	0
*POTK L	0	4	2	0	3	0.5	0	4	2	0	0	0	3	0	3	3	0	3	2
*POTK R	0	3	2	0	2	0.5	1	3	2	0	0	0	3	0	3	3	0	3	2.5
SUBC	12	90	73	12	90	70	23	86	70	16	35	25.5	83	15	86	73	25	90	74

RESULTS

Sampling Results

I collected 162 snakes by hand capture and road cruising and received 117 samples through museum and private donations, for a total of 279 specimens. I set traps along waterways in Tomoka and Addison Blockhouse State Parks for a total of 86 trap-nights, but failed to catch any snakes in traps. I obtained the following taxon coverage: 40 *N. clarkii clarkii*, 27 *N. clarkii compressicauda*, 3 *N. clarkii taeniata*, 6 *N. fasciata fasciata*, 109 *N. fasciata pictiventris*, 92 questionable *N. clarkii/fasciata*, and 2 *N. floridana*. Three individuals collected in Taylor County (CLP 1233, CLP 1250, and CLP 1258) matched the description for *N. clarkii taeniata*. Anecdotal accounts cited this phenotype regularly on the Gulf coast and assumed it resulted from either intergradation between *N. clarkii clarkii* and *N. clarkii compressicauda* or hybridization between *N. clarkii* and *N. fasciata* (Pierson Hill, Kevin Enge, pers. comm.). As a conservative measure, I relegated these Gulf coast “*taeniata*” specimens to the questionable category. See Appendix H for a table of samples and their localities.

Ecological Results

I collected salinity data for 178 individuals representing 25 of the 41 haplotypes that I amplified, which varied both within and between sample sites from 0 parts per thousand (ppt) to 41 ppt. I documented individuals from all three most common haplotypes (A, C, and H) in water varying from fresh (0 ppt) to 40 ppt (one individual of haplotype H was recorded at 41 ppt). I recorded salinities ranging from 0 ppt to 18 ppt for 61 *N. fasciata pictiventris*. I collected

all three *N. fasciata fasciata* for which I have salinity data in freshwater (0 ppt) environments. I noted 35 of 70 *N. fasciata* samples in or near brackish water (5 – 18 ppt). I observed salinities ranging from 24 – 35 ppt in 32 *N. clarkii clarkii* samples, 25 – 27 ppt in two *N. clarkii taeniata*, and 0 – 38 ppt in 18 *N. clarkii compressicauda*. I obtained 16 of 53 *N. clarkii* in or near fresh water (0 ppt). I collected 49 questionable *N. clarkii/fasciata* individuals in salinities ranging from 0 – 41 ppt. The logistic regression demonstrated that the likelihood of assigning a captured snake to *N. fasciata* decreased with increasing salinity, while the probability of assignment to *N. clarkii* and questionable *N. clarkii/fasciata* increased with increasing salinity (Fig. 2). It showed that the probability of identifying *N. fasciata* declined sharply with increasing salinity, the likelihood of identifying *N. clarkii* increased rapidly with increasing salinity, and that the probability of identifying a questionable *N. clarkii/fasciata* increased moderately as salinity increases ($X^2 = 64.90$, $df = 2$, $p < 0.0001$; $r^2 = 0.17$). Interestingly, Figure 2 displayed that I only collected *N. fasciata* in salinities at or below 18 ppt, I collected *N. clarkii* in both salinity extremes (0 ppt and above 24 ppt), and I collected questionable *N. clarkii/fasciata* across the range of salinities.

I regurgitated food items from 10 individuals, and found all either consumed frogs or fish. I confirmed *Hyla cinerea* (Green Treefrog) in the guts of two *N. fasciata pictiventris*, two *Hyla sp.* in the guts of two other *N. fasciata pictiventris*, and two *Hyla sp.* in the guts of two questionable individuals. I identified two fish species in the gut contents of snakes: the Eastern Mosquitofish (*Gambusia holbrooki*) and the Sheepshead Minnow (*Cyprinodon variegatus*). One

N. fasciata pictiventris, one *N. clarkii compressicauda*, and a questionable individual each regurgitated *G. holbrooki*. A single *N. clarkii taeniata* regurgitated the *C. variegatus*.

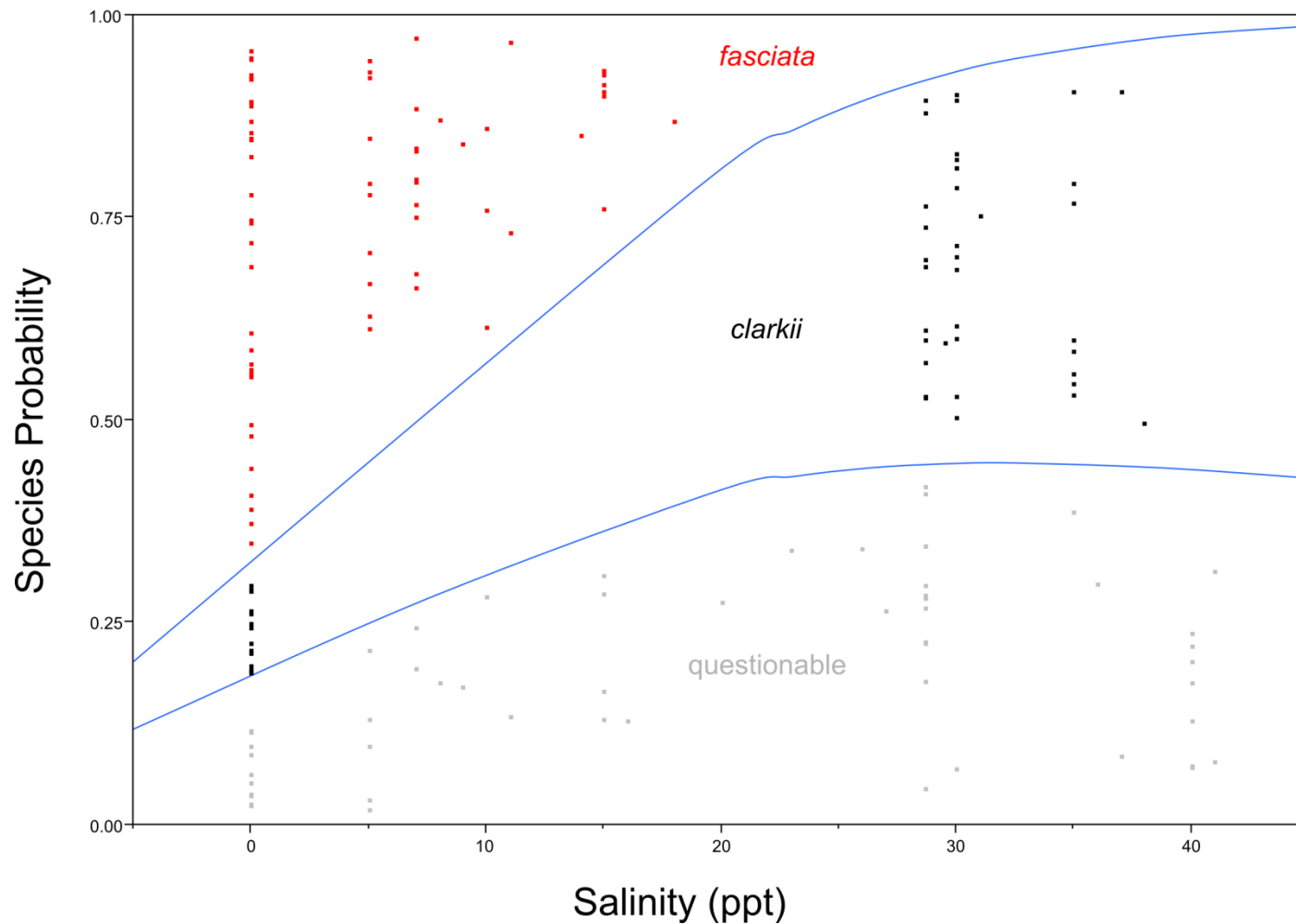

Figure 2. Logistic regression demonstrating significant ($p < 0.0001$) differences in the probability of collecting *Nerodia clarkii*, *N. fasciata*, and questionable *N. clarkii/fasciata* based on the salinity (in parts per thousand, ppt) of the nearest water. Blue curves partition the probability of species identity of a sample according to salinity, where the lower third represents the probability of questionable *N. clarkii/fasciata* individuals, the middle third denotes the probability of *N. clarkii* individuals, and the upper third indicates the probability of *N. fasciata*. Dots represent individual sample points colored according to species (black = *N. clarkii*, red = *N. fasciata*, gray = questionable *N. clarkii/fasciata*). While the points are located in the appropriate third according to their species designations, their position on the y-axis is otherwise arbitrary.

Genetic Results

Nuclear loci

My nuclear data consisted of 810 bases of RAG1, 931 bases of SPTBN1, 521 bases of RPS8, and 634 bases of SELT. In the combined 2896 bases of nuclear data, I only identified three variable sites (one in SPTBN1, one in RPS8, and one in SELT) and three ambiguities (two in RAG1 and one in SELT). I therefore excluded nuclear loci from my analyses and I address the implications of this shortage of variability in my discussion.

Haplotype network

I amplified *cyt b* and aligned 974 bases from 230 individuals to identify the unique haplotypes in my dataset, to generate my haplotype network, and to infer my full haplotype phylogeny. I observed a general correlation between haplotype relatedness (inferred by the number of mutational steps between haplotypes in my parsimony-based haplotype network) and geographic location. Closely related haplotypes tended to share more similar geographical distributions than distantly related haplotypes (Fig. 4). Despite this trend, I observed a number of haplotypes with widespread distributions that did not clearly conform to the overall pattern. I collected most haplotypes in multiple localities and several haplotypes at most sample sites. Contrary to this pattern, I only collected haplotype M from 18 individuals at Eckerd College, and I found no other haplotypes at this locale.

To generate my conservative haplotype and combined GenBank phylogenies, I used 981 and 837 bases of my *cyt b* alignment, respectively. I identified 41 *cyt b* haplotypes, seven unique to *N. c. clarkii*, two unique to *N. c. compressicauda*, fifteen unique to *N. f. pictiventris*, four unique to *N. f. fasciata*, and two unique to questionable *N. clarkii/fasciata* individuals. The remaining 11 haplotypes belonged to some combination of the aforementioned groups (Fig. 3). My conservative phylogenetic analysis only included 23 of these 41 haplotypes. See Figure 4 for the geographic distributions of the *cyt b* haplotypes. While several conspecific individuals from GenBank shared *cyt b* sequences, only two species (other than *N. clarkii* and *N. fasciata* from my samples) shared a haplotype: *Regina rigida* (GenBank accession #: AF471052) and *Regina alleni* (GenBank accession #: AF402916). I did not identify any *cyt b* haplotypes shared between the remaining species from the GenBank samples.

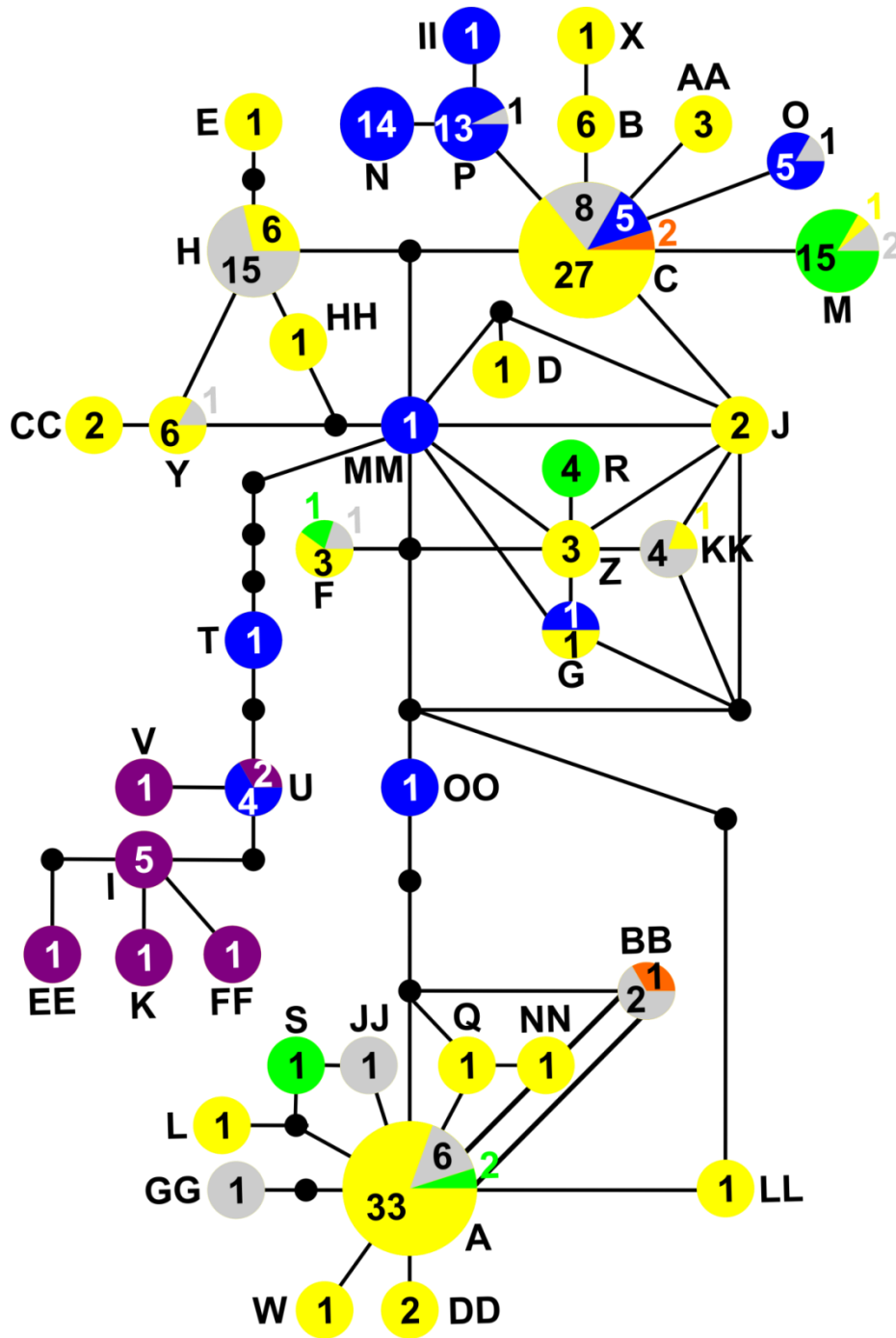

Figure 3. Parsimony cytochrome *b* haplotype network from TCS v1.21. Circles represent distinct *cyt b* haplotypes; circle diameters, pie sizes, and numbers correlate to the number of samples with the haplotype; letters represent haplotypes; and colors represent subspecies: blue = *N. c. clarkii*, green = *N. c. compressicauda*, orange = *N. c. taeniata*, purple = *N. f. fasciata*, yellow = *N. f. pictiventris*, and grey = questionable *N. clarkii/fasciata*.

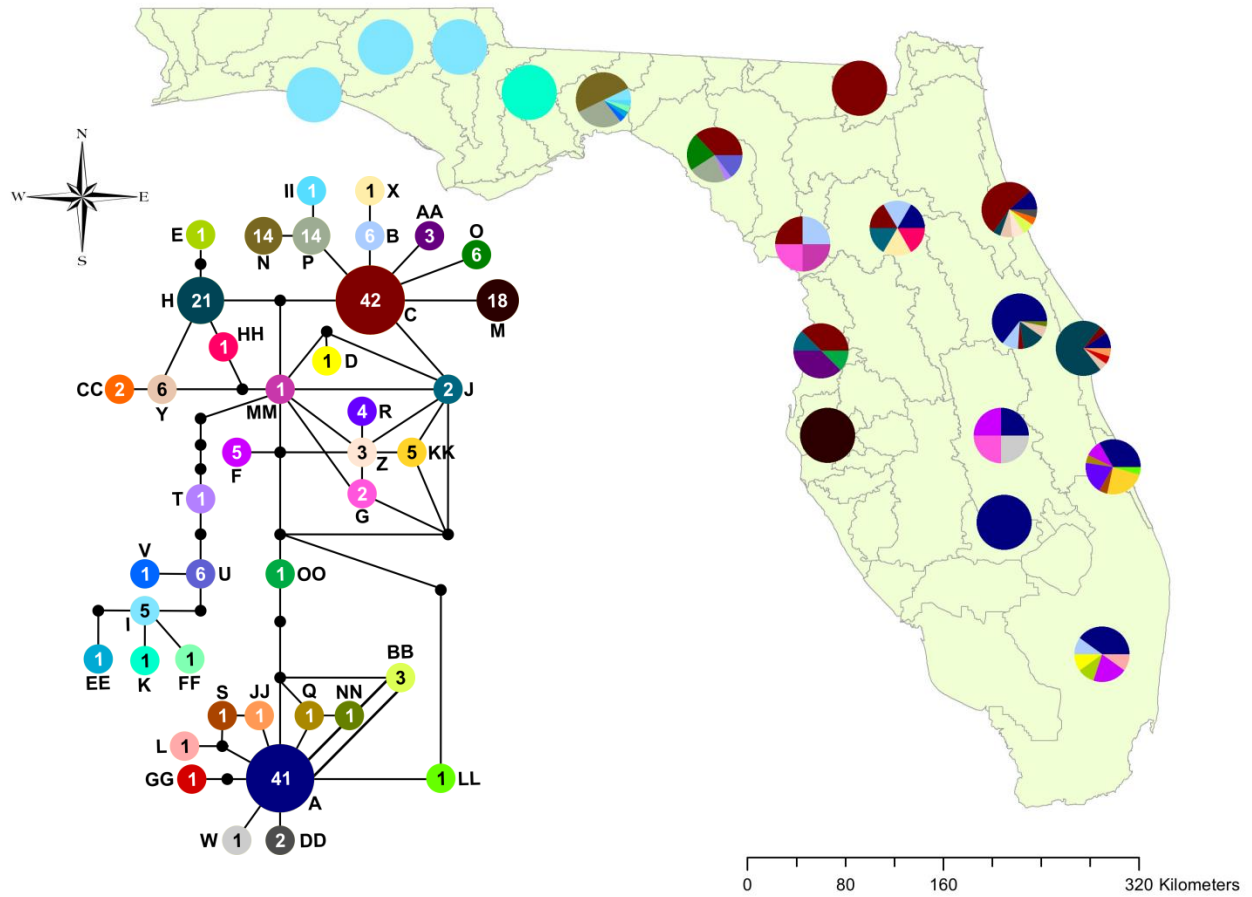

Figure 4. Cytochrome *b* haplotypes of *Nerodia clarkii*/*N. fasciata* superimposed over a map of Florida watersheds along with *cyt b* haplotype network. Colors correlate to haplotype letters; numbers on the haplotype network indicate the numbers of specimens with each haplotype. Pie slice sizes correlate to proportion of samples with a given haplotype within a watershed.

Cyt b haplotype phylogeny

Using the full *cyt b* haplotype data, partitioning the dataset by codon position provided a significantly better model than the unpartitioned or two-partition (codon positions 1&2, codon position 3) models (Log_{10} Bayes Factors = 67, 18 respectively; three-partitioned mean LnL = -2577, two-partitioned mean LnL = -2620, unpartitioned mean LnL = -2729). The three partitioning strategies yielded ESS values ≥ 200 for all parameters estimated. Figure 5 shows the results of the three-partition *cyt b* haplotype phylogeny. I recovered a monophyletic clade of the *N. clarkii/fasciata* haplotypes sister to *N. sipedon* with strong support ($Pp = 0.98$). I identified two well-supported ($Pp = 1$) subclades at the broadest level within the *N. clarkii/fasciata* clade: 1) a northwestern (panhandle) clade and 2) a peninsular clade. Two watersheds, Econfinia-Fenholoway and St. Marks River, contained haplotypes from both clades. I did not recover monophyly of *N. clarkii* or *N. fasciata*, nor did I recover monophyly of any of the five subspecies analyzed.

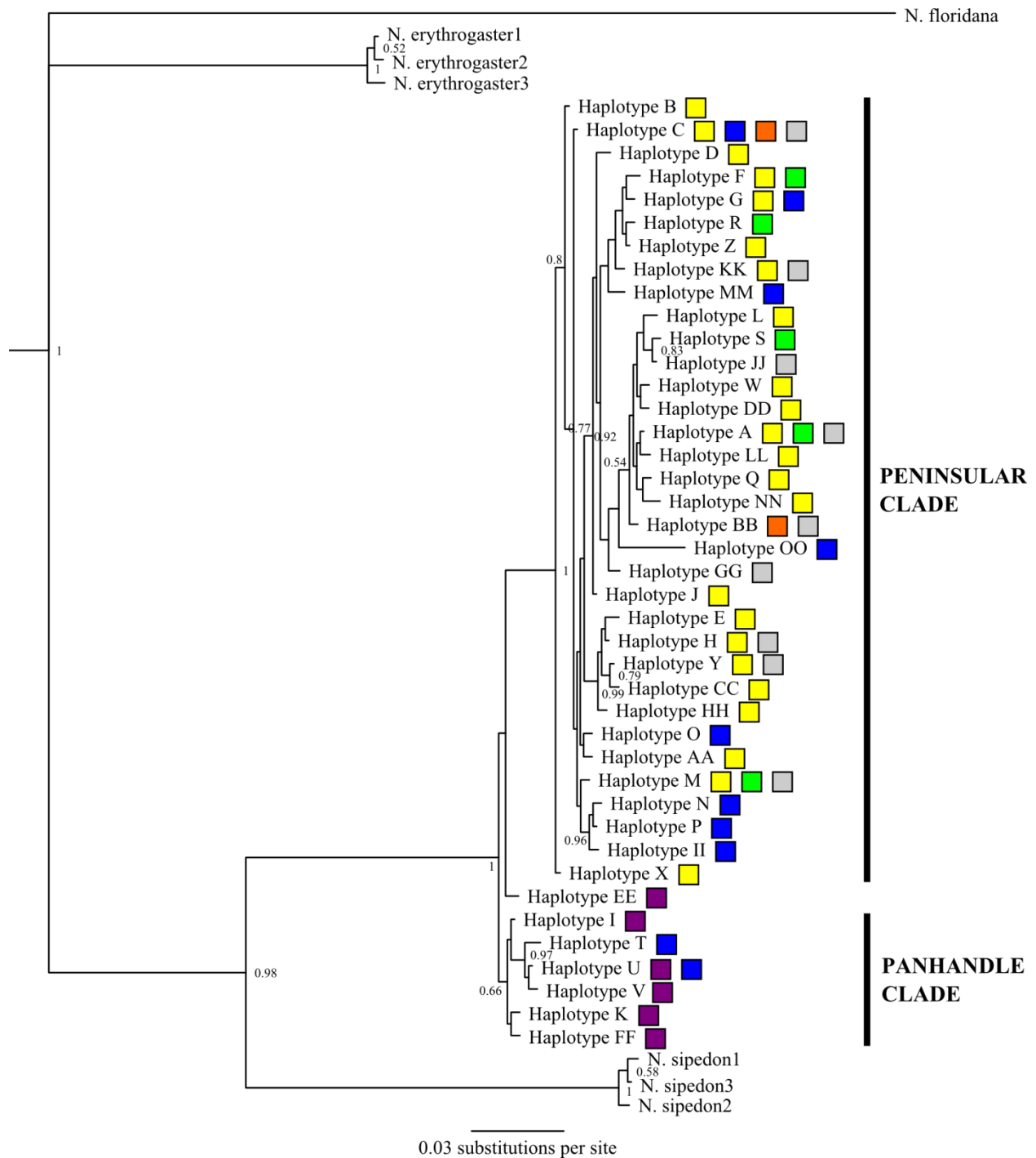

Figure 5. Cytochrome *b* haplotype phylogeny of *Nerodia clarkii*/*N. fasciata* from MrBayes v3.2.1, with node posterior probabilities (Pp) ≥ 0.5 . Haplotype letters correlate to haplotypes from Figures 3 and 4. Colored boxes correlate haplotypes to subspecies: blue = *N. c. clarkii*, green = *N. c. compressicauda*, orange = *N. c. taeniata*, purple = *N. f. fasciata*, yellow = *N. f. pictiventris*, and gray = questionable *N. clarkii/fasciata*. Placement of haplotype EE is unresolved in this phylogeny ($Pp < 0.5$) and is not included in either the inferred peninsular or panhandle clades, although it occurs geographically in the panhandle.

Conservative cyt b haplotype phylogeny

Due to difficulties finding substantial populations of the *N. clarkii* subspecies, I failed to find sample sites where all individuals of *N. clarkii clarkii* or *N. clarkii taeniata* matched the dichotomous key unambiguously. I therefore included a population of *N. clarkii clarkii* in which two of 25 individuals differed from the key only in midbody scale rows (23 instead of 21) and a population of *N. clarkii taeniata* in which two of four individuals differed from the key only in midbody scale rows (22 instead of 21) in the conservative phylogenetic analysis. I could only include one *N. clarkii compressicauda* in the conservative analysis. Based on the Tracer v1.5 output, I concluded that the topology with two partitions (codon positions 1 & 2, codon position 3) did not differ from the topology partitioned by codon position (Log_{10} Bayes Factors = 4), but it produced a significantly better tree than the unpartitioned strategy (Log_{10} Bayes Factors = 24; unpartitioned mean LnL = -1939, partitioned mean LnL = -1885). As with the *cyt b* haplotype phylogeny, I obtained ESS values ≥ 200 for each parameter in all three analyses. Since the two-partitioned model did not differ significantly from the three-partitioned model, I present the results of the simpler model (Fig. 6). Concordant with the *cyt b* haplotype phylogeny, I found strong support for the monophyly of the *N. clarkii/fasciata* clade ($Pp=1$). I also recovered strong support ($pp=1$) for the panhandle and peninsular clades, and I found *N. clarkii* and *N. fasciata* paraphyletic. I inferred monophyly of *N. fasciata fasciata* with low support ($Pp=0.74$) and *N. clarkii clarkii* with strong support ($Pp=0.98$).

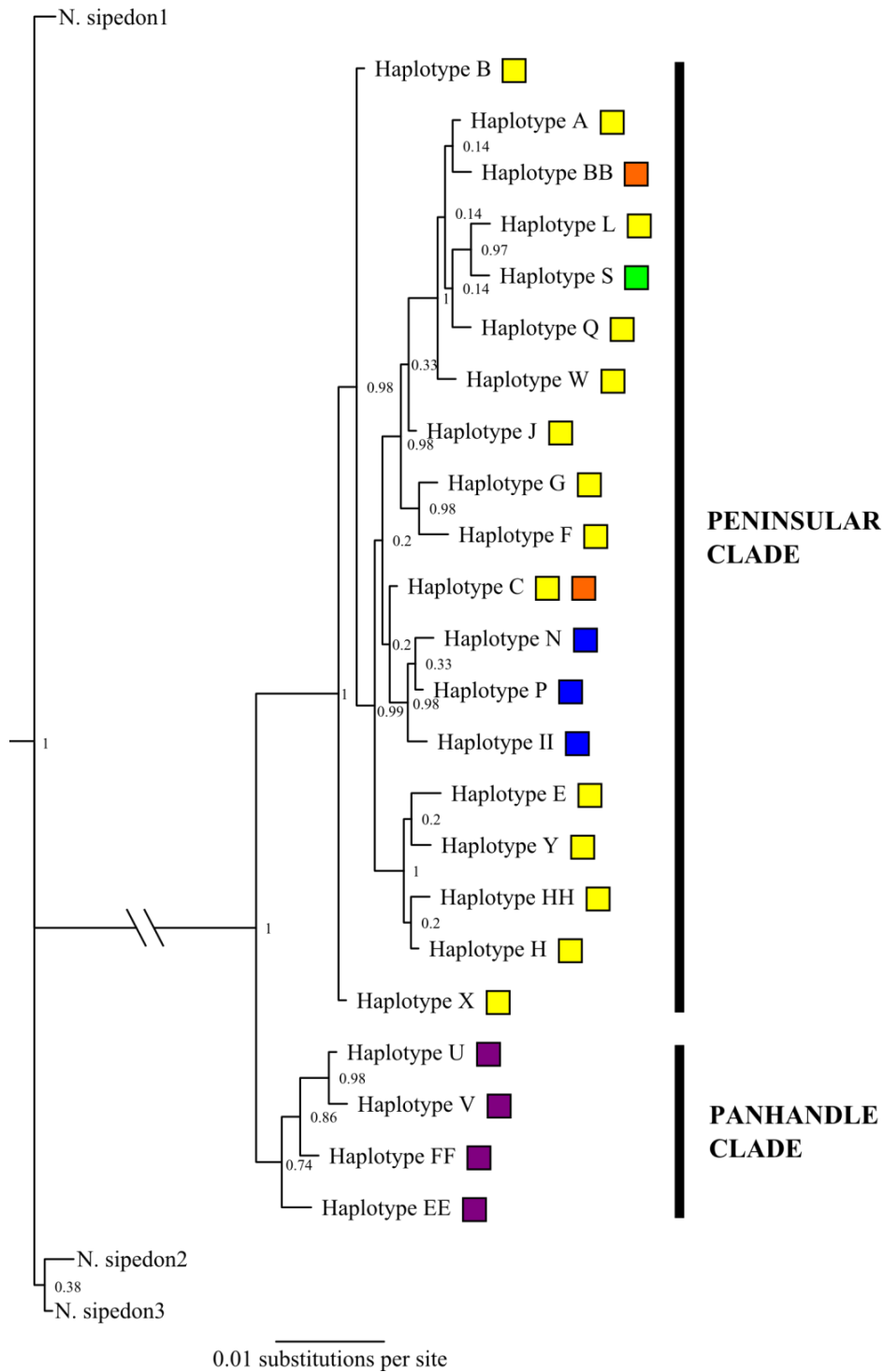

Figure 6. Conservative cytochrome *b* haplotype phylogeny of *Nerodia clarkii*/*N. fasciata* from MrBayes v3.2.1. Node values represent posterior probabilities. Haplotype letters correlate to haplotypes from Figures 3 and 4. Colored boxes correlate haplotypes to subspecies: yellow = *N. f. pictiventris*, purple = *N. f. fasciata*, blue = *N. c. clarkii*, green = *N. c. compressicauda*, and orange = *N. c. taeniata*. Just over 0.07 substitutions per site differed between the *N. sipedon* and *N. clarkii/fasciata* clades.

Combined GenBank cyt b haplotype phylogeny

My analysis of the combined GenBank cyt *b* haplotype dataset generated the favorable topology when partitioned by each codon position as compared to the two-partitioned (Log_{10} Bayes Factors = 17; three-partitioned mean LnL = -11178, two-partitioned mean LnL = -11217) or unpartitioned models (Log_{10} Bayes Factors = 195; unpartitioned mean LnL = -11626). Tracer v1.5 calculated ESS values greater than 200 for all parameters under all partitioning strategies. I therefore describe the results of the three-partitioned model (Fig. 7). The GenBank cyt *b* haplotype phylogeny also demonstrates monophyly of the *N. clarkii/fasciata* clade ($Pp = 1$), sister to a *N. harteri/ N. sipedon* clade, as well as the monophyly of the peninsular and panhandle clades with strong support ($Pp = 1$). Additionally, I observed a strongly supported sister relationship between two *N. fasciata* individuals from GenBank and the peninsula and panhandle clades. One of these two *N. fasciata* (GenBank accession#: AF402910) originated in Texas and the other (GenBank accession#: GQ285450) came from Mississippi. I refer to these two individuals as the western *N. fasciata* clade. Consistent with Guo et al. (2012), I find paraphyly of *Thamnophis*, *Regina*, and *Nerodia*. The GenBank cyt *b* haplotype topology supports the monophyly of most currently accepted *Nerodia* species, with *N. clarkii* and *N. fasciata* as notable exceptions. I also found *R. rigida*, *T. butleri*, *T. couchii*, *T. cyrtopsis*, *T. elegans*, *T. radix*, and *T. scaliger* as non-monophyletic taxa.



Figure 7. Combined GenBank cytochrome *b* haplotype phylogeny of Thamnophiini from MrBayes v3.2.1, with node posterior probabilities (P_p) ≥ 0.5 . Collapsed nodes supported by $P_p \geq 0.95$ and contain ≥ 15 individuals.

Divergence date estimation

My two BEAST runs converged within 5×10^7 generations and generated ESS values ≥ 200 for all parameters. BEAST estimated a mean divergence date of 26.31 Ma (95% CI 19.79 - 33.07 Ma) for the Thamnophiini and *Natrix* clades, which coincides with the 95% confidence interval placed around the tMRCA of the *Natrix* ancestor. I inferred a mean divergence date of 6.06 Ma (95% CI 3.43 - 8.47 Ma) for the split between the *N. harteri/sipedon* clade and the *N. clarkii/fasciata* clade and a mean divergence date of 2.76 Ma (95% CI 1.41 - 3.97 Ma) for the *N. clarkii/fasciata* clade in Florida and the western *N. fasciata* clade. My results from BEAST indicate that the *N. clarkii/fasciata* peninsular and *N. clarkii/fasciata* panhandle clades diverged during the Pleistocene (mean divergence estimate = 1.62 Ma, 95% CI 0.81 - 2.3 Ma). Figure 8 summarizes these results below.

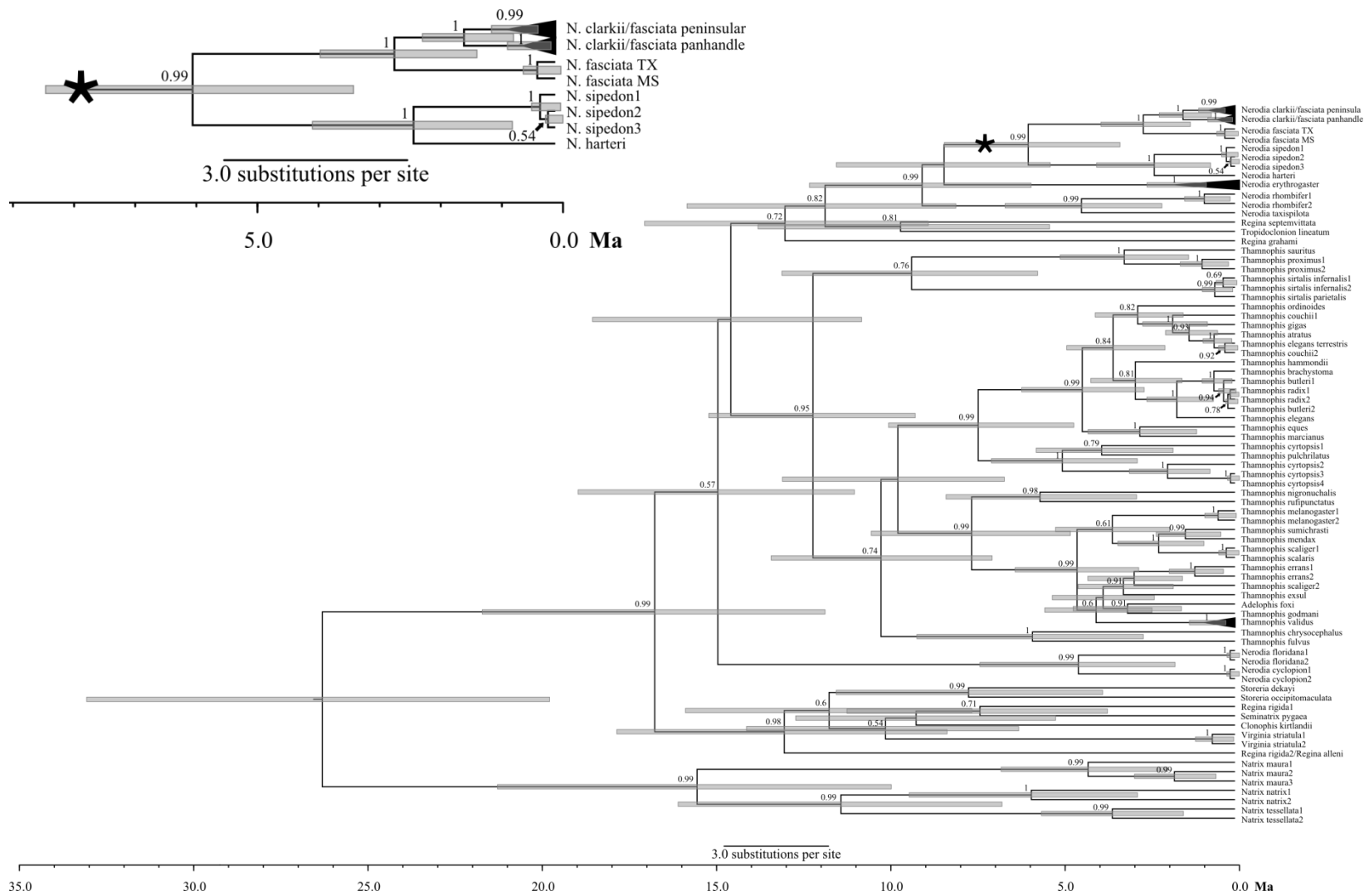

Figure 8. Chronogram generated by BEAST v1.7.4 with magnified view of the *N. clarkii/fasciata/harteri/sipedon* clade. Gray bars represent 95% confidence intervals for divergence date estimates, with node posterior probabilities (P_p) ≥ 0.5 . Collapsed nodes supported by $P_p \geq 0.95$ and contain ≥ 15 individuals. Asterisk demonstrates the phylogenetic position of the magnified clade.

Morphological Results

Figures 9 - 12 summarize the results of my principal components analyses. PC 1 and 2 collectively describe 36.7% of the variation in the 10 morphological characters analyzed for the haplotype and clade comparisons. Haplotype MCPs overlap in morphospace, as do the MCPs for the peninsular and panhandle clades. PC 1 and 2 summarize 36.7% of the variation in the 10 morphological characters analyzed for the conservative subspecies comparison and 35.0% of the variation in the 9 characters analyzed when I excluded dorsals at midbody. Similar to the haplotype analysis, the MCPs of each subspecies overlap in morphospace, with a greater degree of overlap when excluding dorsals at midbody. I also found *N. clarkii* and *N. fasciata* overlapped in morphospace in both analyses.

Table 3. List of eigenvalues and character weightings for Principal Components 1, 2, and 3 grouped according to haplotypes, clades, subspecies, and subspecies excluding dorsals at midbody.

Haplotypes								Clades							
PC	Eigenvalue	Percent	Cum %	Character	PC1	PC2	PC3	PC	Eigenvalue	Percent	Cum %	Character	PC1	PC2	PC3
PC1	2.1772	21.7724	21.7724	LOG10 DORS A	0.5893	-0.0051	-0.1356	PC1	2.1772	21.7724	21.7724	LOG10 DORS A	0.5893	-0.0051	-0.1356
PC2	1.4856	14.8565	36.6289	LOG10 DORS M	0.5697	0.1019	-0.1658	PC2	1.4856	14.8565	36.6289	LOG10 DORS M	0.5697	0.1019	-0.1658
PC3	1.2633	12.6329	49.2618	MEAN SUPL	-0.1659	0.5879	0.1726	PC3	1.2633	12.6329	49.2618	MEAN SUPL	-0.1659	0.5879	0.1726
				MEAN INFL	0.0564	0.4729	0.2608					MEAN INFL	0.0564	0.4729	0.2608
				MEAN POO	0.2410	0.1825	-0.0031					MEAN POO	0.2410	0.1825	-0.0031
				MEAN LIO	-0.2216	-0.4758	0.2210					MEAN LIO	-0.2216	-0.4758	0.2210
				LOG10 VEN	0.1440	-0.2518	-0.1555					LOG10 VEN	0.1440	-0.2518	-0.1555
				MEAN POT	0.0992	0.0519	0.6724					MEAN POT	0.0992	0.0519	0.6724
				MEAN ANTK	0.0171	-0.1808	0.3308					MEAN ANTK	0.0171	-0.1808	0.3308
				MEAN POTK	0.3993	-0.2489	0.4709					MEAN POTK	0.3993	-0.2489	0.4709
Subspecies								Subspecies No DORSM							
PC	Eigenvalue	Percent	Cum %	Character	PC1	PC2	PC3	PC	Eigenvalue	Percent	Cum %	Character	PC1	PC2	PC3
PC1	2.1764	21.7644	21.7644	LOG10 DORS A	0.5863	-0.0313	-0.1625	PC1	1.6698	18.5530	18.5530	LOG10 DORS A	0.5494	0.1023	-0.2908
PC2	1.4945	14.9449	36.7093	LOG10 DORS M	0.5704	0.0820	-0.1845	PC2	1.4740	16.3780	34.9310	MEAN SUPL	-0.3156	0.5413	0.1626
PC3	1.2530	12.5298	49.2391	MEAN SUPL	-0.1531	0.6000	0.1516	PC3	1.2036	13.3740	48.3050	MEAN INFL	-0.0633	0.4888	0.3419
				MEAN INFL	0.0649	0.4810	0.2410					MEAN POO	0.2880	0.3066	-0.2625
				MEAN POO	0.2411	0.1909	0.0163					MEAN LIO	-0.1054	-0.5000	0.3436
				MEAN LIO	-0.2283	-0.4662	0.2429					LOG10 VEN	0.2164	-0.1898	-0.0108
				LOG10 VEN	0.1376	-0.2369	-0.1091					MEAN POT	0.2699	0.2522	0.3903
				MEAN POT	0.1191	0.0955	0.6435					MEAN ANTK	0.0900	-0.1163	0.5800
				MEAN ANTK	0.0207	-0.1564	0.3827					MEAN POTK	0.6105	-0.0196	0.3102
				MEAN POTK	0.3993	-0.2398	0.4761								

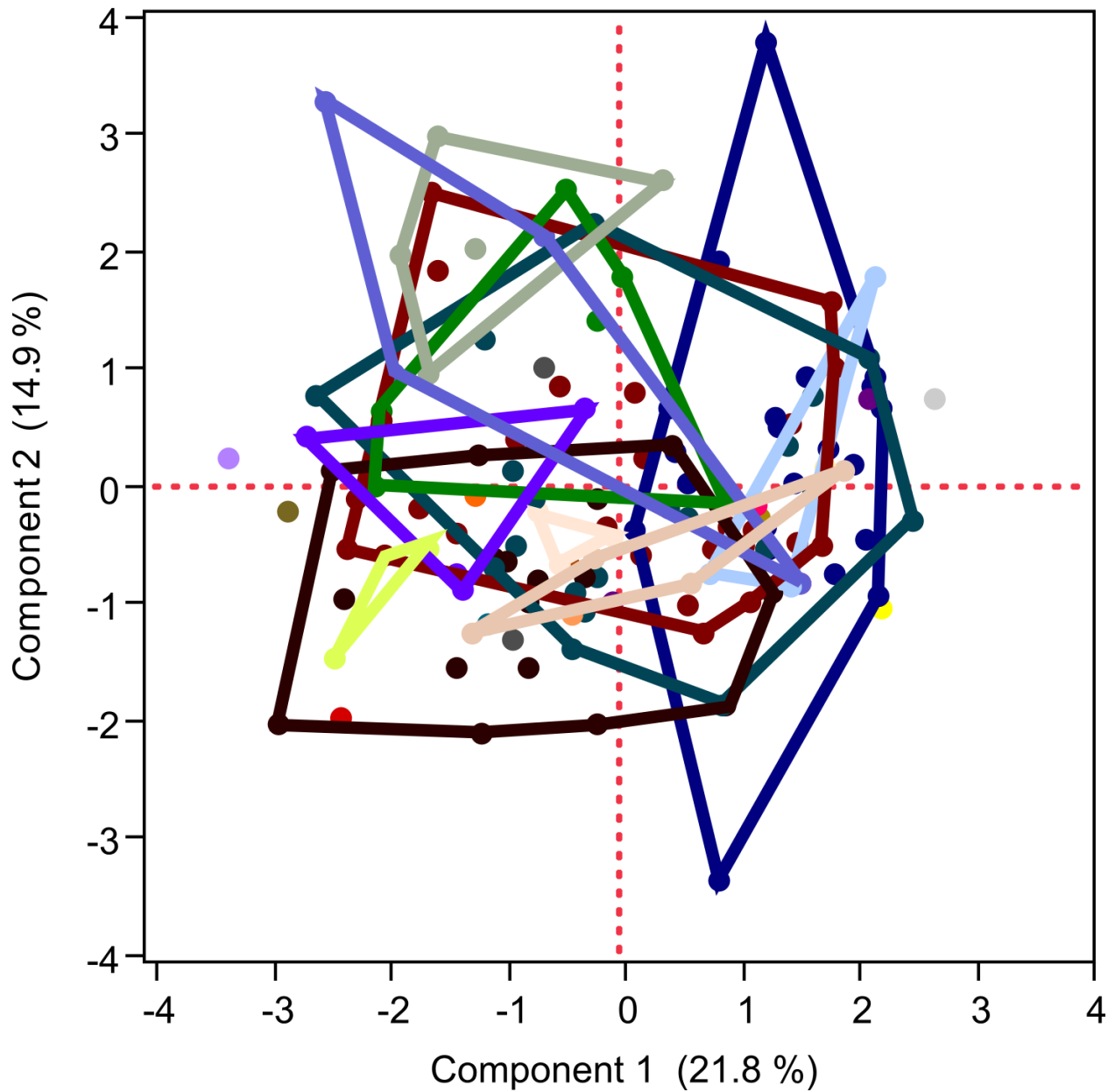

Figure 9. Graph of PC1 plotted against PC2 from the Principal Components (PC) Analysis of 10 morphological characters for 138 individuals of *Nerodia clarkii*/*N. fasciata* from Florida. Points represent individuals within morphospace; colors correlate to cytochrome *b* haplotypes and correspond to the colors used in the haplotype network (Fig. 4).

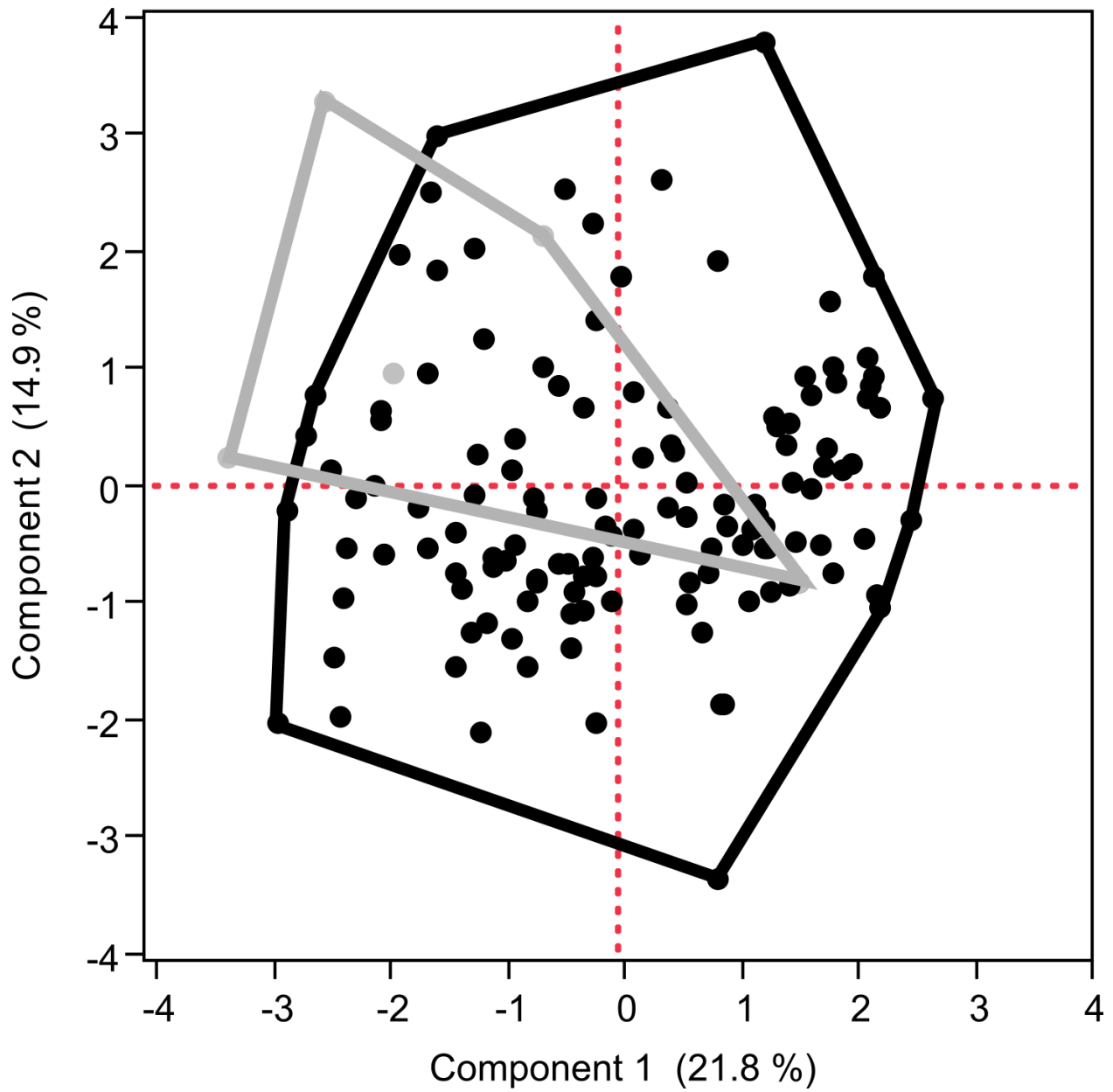

Figure 10. Graph of PC1 plotted against PC2 from the Principal Components (PC) Analysis of 10 morphological characters for 138 individuals *Nerodia clarkii*/*N. fasciata* from Florida. Points represent individuals within morphospace; colors correlate to phylogenetic clades: black = peninsular clade, gray = panhandle clade.

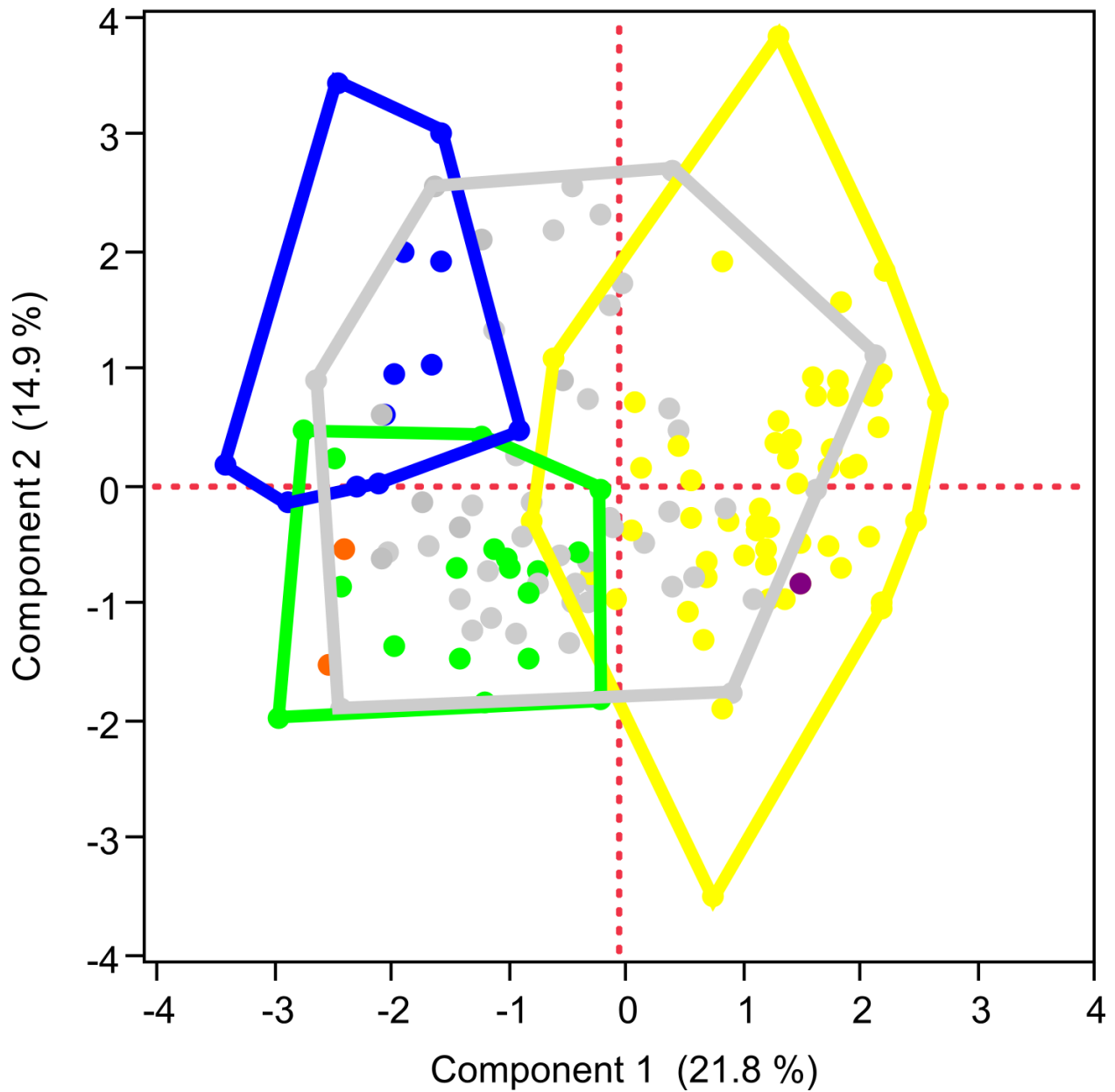

Figure 11. Graph of PC1 plotted against PC2 from the Principal Components Analysis of 10 morphological characters for 141 individuals *Nerodia clarkii*/*N. fasciata* from Florida. Points represent individuals within morphospace; colors correlate to subspecies designations: blue = *N. c. clarkii*, green = *N. c. compressicauda*, orange = *N. c. taeniata*, purple = *N. f. fasciata*, yellow = *N. f. pictiventris*, and gray = questionable *N. clarkii/fasciata*.

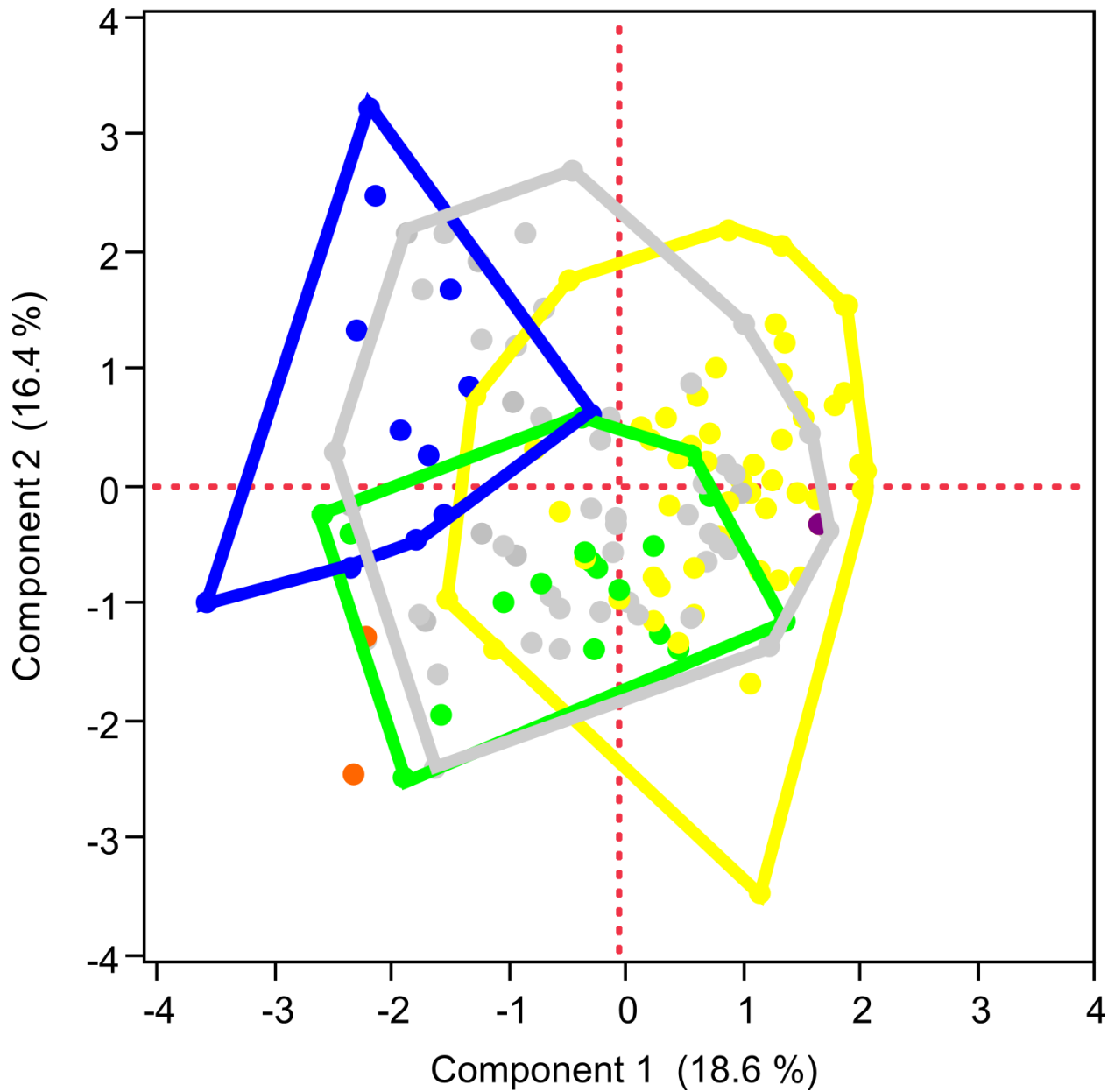

Figure 12. Graph of PC1 plotted against PC2 from the Principal Components (PC) Analysis of 9 morphological characters for 141 individuals *Nerodia clarkii*/*N. fasciata* from Florida. Points represent individuals within morphospace; colors correlate to subspecies designations: blue = *N. c. clarkii*, green = *N. c. compressicauda*, orange = *N. c. taeniata*, purple = *N. f. fasciata*, yellow = *N. f. pictiventris*, and gray = questionable *N. clarkii/fasciata*.

DISCUSSION

Phylogenetic results demonstrated paraphyly of the *N. clarkii* and *N. fasciata* species and subspecies, inconsistent with the Carr and Goin (1942) hypothesis of a monophyletic striped snake clade sister to a monophyletic *N. clarkii compressicauda* clade. In addition *N. clarkii* and *N. fasciata* represented paraphyletic taxa that lacked morphologically and ecologically distinguishing traits, according to the character set I analyzed. The results support a monophyletic *N. clarkii/fasciata* clade and a Pleistocene origin for the peninsula and panhandle subclades in this group. The results also corroborate the paraphyly of *Nerodia*, *Regina*, and *Thamnophis* inferred by Guo et al. (2012).

Sampling

The results support two main suspicions: 1) high levels of gene flow between *N. clarkii* and *N. fasciata*, suggestive of a single species rather than hybridization between isolated populations and 2) a lack of uniqueness of the *N. clarkii taeniata* phenotype. When searching for suitable collection sites, I found few isolated areas of saltmarsh or brackish water. While anthropogenic activity introduced some fresh water near saline habitats (mostly in the form of pond and roadside retention), I identified apparently natural freshwater wetland habitats near or nestled within many saltmarsh areas. Also, many rivers and streams empty into the ocean, creating environmental gradients from inland fresh water to brackish water coastward, likely promoting gene flow between *N. clarkii* and *N. fasciata*. Research suggested that the two species maintain distinct identities in isolated patches of habitat and that hybridization occurs

in areas where fresh and salt water are in close proximity, or where the two habitats meet, as in the case of rivers emptying into salt marshes (Carr & Goin, 1942; Kochman, 1977; Lawson et al., 1991). However, Mebert (2008) identified a 70 km wide hybrid zone between *N. fasciata* and *N. sipedon* and found that alleles had introgressed as far as 300 km from the hybrid zone. Assuming a similar pattern of hybridization between *N. clarkii* and *N. fasciata* (a likely assumption, given the phylogenetic proximity of *N. sipedon*), these data suggest that genetic introgression occurs across Florida. Peninsular Florida is less than 300 km at its widest, making it unlikely that any population in the state could escape the effects of genetic introgression. Given this assumption, the proximity of fresh and salt water around the entire coastline of Florida precludes the possibility of isolation of *N. clarkii* populations from *N. fasciata*. Additionally, one-third of my samples from across the state did not fit into a taxon according to my dichotomous key. The abundance and prevalence of these questionable *N. clarkii/fasciata* snakes across all habitat types supports the idea that gene flow is rampant between *N. clarkii* and *N. fasciata*.

My results call the species boundaries into question and highlight discrepancies in the subspecies descriptions. I collected five snakes that keyed morphologically as *N. clarkii taeniata*, three of which I captured on the Gulf coast in Taylor County. Several studies cite finding snakes that resemble *N. clarkii taeniata* phenotypes on the southern Gulf coast and in Cuba (Barbour & Noble, 1915; Carr & Goin, 1942; Dunson, 1979; Hebrard & Lee, 1981), leading Barbour & Noble and Dunson to argue synonymy of *N. c. compressicauda* and *N. c. taeniata*. Despite their data, many studies still consider *N. clarkii taeniata* in Volusia County a

morphologically distinct population (Carr & Goin 1942; Lawson et al., 1991; Goode et al., 1992). No studies cite snakes indistinguishable from *N. clarkii taeniata* collected on the Gulf coast. Additionally, no reports of snakes closely resembling *N. clarkii taeniata* north of Volusia County exist on either coast. Despite the absence of literature, anecdotal accounts of *N. c. taeniata* phenotypes on the west coast, similar to what I found, discard these snakes as hybrids or intergrades between *N. c. clarkii*, *N. c. compressicauda*, and *N. fasciata* (Pierson Hill, Kevin Enge, pers. comm.). Though researchers and managers acknowledge individuals with these phenotypes from the Gulf coast (both in and outside of Florida), their presence is poorly documented in the scientific literature. As Dunson (1979) aptly stated, “[t]he significance of *taeniata*-like phenotypes from many parts of the range of *N. [c.] compressicauda* seems to have been overlooked.”

Ecology

Although I recorded several ecological variables, salinity represents the most consistent, comparable, and relevant character that I measured. I collected snakes with the three most common *cyt b* haplotypes in fresh and brackish water, reducing the likelihood of correlation between genetics and salinity tolerance. Despite the historical experiments which suggest that *N. fasciata* lacks salinity tolerance, I collected half of the individuals (35 of 70) that match the phenotypic description of *N. fasciata pictiventris* in brackish water (5 – 18ppt), consistent with Neill (1958). I also collected a single *N. fasciata pictiventris* and a population of *N. clarkii compressicauda* that match the orange, oblong-banded phenotype described by Cope (1860a)

and observed by Peter Meylan (pers. comm.). I found both species in a storm retention pond with fresh water (0 ppt) at Eckerd College. Historical evidence failed to identify salt glands in *N. clarkii* or clear skin permeability differences between *N. clarkii* and *N. fasciata*, suggesting that the differences found in salinity tolerance between these taxa result from differences in behavioral avoidance of drinking salt water (Schmidt-Nielsen & Fange, 1958; Pettus, 1958, 1963; Kochman, 1977; Dunson, 1978, 1980). Pettus (1958) performed necropsies on *N. fasciata* that died after prolonged immersion in seawater and found intestinal distention consistent with drinking salt water. These researchers argued that morphologically-intermediate specimens (which they call hybrids) demonstrate an expected intermediate salinity tolerance, relative to *N. clarkii* and *N. fasciata*. My results somewhat contradict these findings, in that my *N. clarkii/fasciata* questionable category has the highest recorded salinity value (41 ppt). I collected these snakes at Turnbull Creek, the same site that Kochman (1977) used as his hybrid swarm.

The logistic regression results suggested that salinity affects the probability of collecting a given species (*N. clarkii*, *N. fasciata*, or questionable *N. clarkii/fasciata*). Although I identified differences in the likelihood of finding *N. clarkii* and *N. fasciata* based on salinity, I recognized a range of salinities in which I found *N. fasciata*, inconsistent with the previous literature (e.g. Pettus, 1958; Kochman, 1977). Also, I observed that *N. clarkii* utilized freshwater habitats, consistent with findings by Pettus (1958) that *N. clarkii* preferentially chooses freshwater when available. These two findings, coupled with the observation of questionable *N. clarkii/fasciata* in the full range of salinities, demonstrated that these snakes exist across a gradient of

salinities, rather than isolated to discrete saline versus freshwater habitats. Additionally, I assigned the species names according to morphologies, which may be plastic or under environmental selective pressures. The differences in salinity at different collecting sites may correlate to other variations in the environment (e.g. plant cover, prey types/abundances, predator types/abundances, sediment types) which may act on the phenotype of these snakes, inducing the observed differences. While my findings do suggest a statistical difference in the responses of taxa to salinity, concerted research efforts should be made to understand the influence of salinity on taxonomic representation in this group before strong conclusions can be made.

Three recent studies found no clear morphological or physiological adaptations to salinity tolerance in *N. clarkii*, weakening the evidence for distinction between *N. fasciata* and *N. clarkii* (Babonis & Evans, 2011; Babonis et al., 2011; Babonis et al., 2012). These researchers found no differences in the structure and function of the kidneys, colon, or cloaca with respect to salt influx/efflux, no differences in the morphology of the cephalic glands, mass loss did not differ when placed in solutions of various salinities, and ureters may demonstrate environmentally-variable plasticity of ion transport between the two species. While both species demonstrated a localized abundance of certain ion transport proteins in the posterior lingual glands, *N. clarkii* had a greater abundance than *N. fasciata*. Babonis and Evans (2012) concluded that this difference is only likely to result in a slight increase in salt excretion. They noted increased plasma osmolality and documented fatalities in *N. fasciata* but not in *N. clarkii*, which agree with the behavioral differences proposed by Pettus (1958, 1963) and Dunson

(1978, 1980). Importantly, no study to date has effectively controlled for maternal and environmental effects when comparing salinity tolerance between *N. clarkii* and *N. fasciata*.

While collecting, I made an interesting ecological observation about the habitat in which I found *N. clarkii taeniata*. Brooks (2008) cites habitat alteration affects *N. clarkii taeniata*, likely increasing levels of gene flow from *N. fasciata pictiventris*. I only collected two *N. clarkii taeniata* on the Atlantic coast, both within 100 m of each other in a roadside ditch in New Smyrna Beach, Volusia County. This habitat is adjacent to two neighborhoods with retention ponds and other freshwater sources. *Avicennia germinans* (Black Mangrove) and *Schinus terebinthifolius* (Brazilian Pepper, an exotic invasive species) dominated the collection site, which was littered with trash and debris from the road. I recaptured these snakes several times over a two-month period, always within the same 100 m stretch of ditch, suggesting that they used this habitat as more than a transient corridor to more pristine habitats elsewhere. The intense anthropogenic influence on this habitat contradicts the perception that *N. clarkii taeniata* requires undisturbed habitat, suggesting that our understanding of this subspecies may be incorrect.

Genetics

Nuclear loci

I found no differences in nuclear loci for my *N. clarkii/fasciata* dataset, suggestive of one lineage or multiple, recently-diverged lineages. I inferred two major lineages within the *N. clarkii/fasciata* clade (based on my *cyt b* data): a peninsular clade and a panhandle clade.

Divergence time estimates from these data suggested that the peninsular and panhandle clades likely diverged within the last 2.5 million years, consistent with my expectation of recent divergence. Also, I found shared *cyt b* haplotypes between the Apalachicola and Suwannee rivers, which may be a region of secondary contact. Distribution maps indicated that the *N. clarkii* and *N. fasciata* distributions are contiguous along this apparent phylogeographic border (Gibbons & Dorcas, 2004) and Lawson et al. (1991) inferred gene flow in this area. These data, combined with my lack of nuclear signal, suggested that the period of isolation between the peninsular and panhandle lineages may have been short-lived. I hypothesize that if isolation occurred during the Pleistocene, it did not last long enough for mutations to accumulate within the nuclear genome to differentiate the clades prior to the resumption of gene flow from secondary contact.

While the patterns I observed in my nuclear and mitochondrial signal differ, both suggested a lack of genetic distinction between *N. clarkii* and *N. fasciata*. The difference in mutation rates of nuclear and mitochondrial loci explains the difference in signal between these two types of markers. The mitochondrial genome evolves more rapidly than most nuclear loci (Brown et al., 1979), largely due to differences in effective population size: $4N$ for most nuclear loci but N for mitochondrial loci resulting from its haploid, uniparental inheritance. Therefore, I expected a detectable mitochondrial signal to arise in a shorter time period than a nuclear signal.

Several plausible (though less likely) alternatives exist for the lack of nuclear divergence in my dataset. First, the possibility exists that the few nuclear samples I amplified provided an unrepresentative estimate of nuclear variation in the *N. clarkii/fasciata* clade. Although better sample coverage would likely provide a more representative estimate of genetic variation in this group, phylogenetic studies of species- or higher-level variation regularly use one or few representatives of each taxon with good results, particularly when divergence times are large (De Queiroz et al., 2002; Fenwick et al., 2009; Townsend et al., 2011). Also, nuclear divergence may have occurred during an early Pleistocene isolation, but the signal may have been lost during genetic admixture when secondary contact occurred. In this scenario, gene flow would have to rapidly spread nuclear alleles from the point of secondary contact across all of the state. This hypothesis seems unlikely, because such high levels of gene flow would likely reduce the detectable signal in the *cyt b* data.

Haplotype network

The haplotype data suggested regional distinction of *cyt b* haplotypes, which correlated broadly to three major areas: 1) panhandle, 2) north-west peninsula, and 3) south-east peninsula. The division between the panhandle and peninsula corresponded to a major phylogeographic break identified by other researchers (Avice, 1992; Hewitt, 1996; Soltis et al., 2006). As a semi-aquatic taxon, the xeric Lake Wales, Mount Dora, and Bombing Range ridges likely inhibit *N. clarkii/fasciata* dispersal through central Florida. I also suspect that human development may have altered gene flow patterns of these snakes, as evidenced by the Eckerd

College population. I collected these snakes in the Omega/Zeta pond on Eckerd's campus, which sits at the tip of the Pinellas Peninsula. This sample site contained *N. clarkii compressicauda*, *N. fasciata pictiventris*, and questionable *N. clarkii/fasciata* individuals. All exhibited the M haplotype, a haplotype found nowhere else. The Pinellas Peninsula is heavily developed, with several roads that bisect the entire peninsula. I hypothesize that this heavy anthropogenic disturbance severely restricted gene flow from populations outside the peninsula, thus restricting haplotype M to the Eckerd College population. I also noted that no other collection locality (other than those where I collected only one individual) had only one haplotype documented, which supports my hypothesis that this population is reproductively isolated.

The haplotype network analysis provided no evidence for distinction between the *N. clarkii* and *N. fasciata* species. I hypothesized that haplotype groups would cluster both according to species and subspecies, based on the hypothesis of Carr and Goin (1942). Quite the contrary, haplotypes neither clustered according to species or subspecies, and individuals of both species shared haplotypes. Finding both *N. clarkii* and *N. fasciata* with the same haplotype at Eckerd College supported previous notions that the two species are reproductively compatible (Carr & Goin, 1942; Kochman, 1977; Lawson et al., 1991; Goode et al., 1992). One of the *N. clarkii compressicauda* captured in the Omega/Zeta pond (CLP 1187) gave birth to five offspring during transportation to the lab, three of which had *N. fasciata pictiventris* coloration (see Appendix G for photos of CLP 1187 and offspring). While I omitted the offspring from my analyses because of their relatedness, they also supported the notion of reproductive

compatibility between *N. fasciata* and *N. clarkii* species. These results suggested high morphological variability within genetically similar populations, rather than hybridization between two discrete taxa.

Only four of the 52 species that I analyzed shared haplotypes with another species: *N. clarkii* and *N. fasciata* shared several haplotypes including ~15% of their *cyt b* haplotypes. *Regina rigida* and *Regina alleni* also shared a haplotype. Given the rapid rate of evolution of *cyt b*, one expects well-differentiated species to share fewer, if any, haplotypes. The rare incidence of shared haplotypes in the other species in my analysis supported this expectation. Lack of shared haplotypes in other natricine snakes could be an artifact of my relatively low sample coverage compared to the *N. clarkii/fasciata* clade, however. I obtained appreciably more samples of *N. clarkii* and *N. fasciata* than almost all other taxa (except *N. erythrogaster*), so it is possible that additional samples would share haplotypes across species lines. For example, I only used one individual each of *Storeria dekayi* and *S. occipitomaculata*, making it unlikely for me to recognize shared haplotypes between these two taxa, should they exist. *Regina alleni* (AF471052) shared a haplotype with one *Regina rigida* (AF402916), but the second *Regina rigida* sequence diverged by roughly 1.2 substitutions per site, a larger difference than I found between most of the other thamnophiine species comparisons. Researchers collected all three snakes in areas of sympatry between the two species (AF402916 from Alachua County, FL; AF402919 from Franklin County, FL; AF471052 from Volusia County, FL), which increased the possibility of misidentification of a sample. Because I used *cyt b*, I cannot rule out the possibility of hybridization between *R. alleni* and *R. rigida* confounding my results. That said,

very little is known about the reproductive biology of either species, and no studies suggest that *R. alleni/rigida* hybrids occur (Gibbons and Dorcas, 2004). These results highlight the need for further research into the taxonomy and natural history of *Regina*.

Cyt b phylogenies and divergence date estimation

Both my phylogenetic and divergence date results corroborate the findings of Guo et al. (2012). I inferred two major lineages in the *N. clarkii/fasciata* clade in Florida, which probably split in the late Pliocene or during the Pleistocene: a panhandle lineage and a peninsular lineage. Other snake taxa display a similar pattern, including *Coluber constrictor* (Burbrink et al., 2008), *Pantherophis* sp. (Burbrink et al., 2000), and *Agkistrodon piscivorus* (Guiher & Burbrink, 2008; Douglas et al., 2009; Strickland, 2011). All have a phylogeographic break in northwest Florida. Non-snake taxa also demonstrate a comparable phylogeographic break in northwest Florida, including *Hyla squirella* (Hether, 2010), *Anolis carolinensis* (Campbell-Staton et al., 2012), *Terrapene carolina* (Butler et al., 2011), and *Ambystoma cingulatum* (Pauly et al., 2007). Population isolation in Florida during Pleistocene glacial cycles and sea-level fluctuations can explain this phylogenetic signal (Auffenberg, 1958; Milstead, 1969; Pauly et al., 2007; Guiher & Burbrink, 2008; Douglas et al., 2009; Strickland, 2011; Campbell-Staton et al., 2012). Secondary contact also occurred between many of the peninsular and continental populations once conditions became favorable for range expansion (Swenson & Howard 2005). The presence of haplotypes from both my peninsular and panhandle clades in populations between the Apalachicola and Suwanee rivers provided evidence for gene flow between the two

lineages. I therefore propose a hypothesis similar to that of Carr & Goin (1942): *Nerodia clarkii/fasciata* in Florida became isolated from the continental populations during Pleistocene interglacial cycles, possibly trapped on isolated islands that remained above sea-level. As the ocean receded, the Apalachicola and Suwanee rivers acted as inland seas, maintaining an east-west barrier in the panhandle of Florida, but allowing movement of populations northward. Secondary contact subsequently occurred when populations expanded following the full retreat of elevated sea levels.

I propose a similar, alternative hypothesis to explain the distribution of diversity in the *N. clarkii/fasciata* clade in Florida. Pleistocene glacial cycles covered much of North America in a sheet of ice that induced cooler, drier climates (Soltis et al., 2006). This cooling and drying may have driven water snakes to southwestern (Texas) and southeastern (Florida) refugia. As the climate warmed, the two relict populations may have expanded and come into secondary contact around the Apalachicola and Suwanee rivers. This hypothesis seems less likely because sea-level declined during Pleistocene glaciation, creating a more direct east-west corridor between southern Florida and Texas. Also, I inferred a western *N. fasciata* clade from my combined GenBank cyt b haplotype phylogeny. A *N. clarkii/fasciata* panhandle clade more closely related to the western *N. fasciata* clade than to the *N. clarkii/fasciata* peninsular clade would support this hypothesis. Instead, I found a more recent ancestor for the panhandle and peninsular lineages, supporting an interglacial origin of lineages.

While my data support Carr & Goin's proposition that Pleistocene sea-level rise had an isolating effect on *N. clarkii/fasciata* populations, *N. clarkii compressicauda* is not sister to a monophyletic *N. clarkii clarkii/N. clarkii taeniata* clade. I inferred paraphyly of all five subspecies in the *N. clarkii/fasciata*. Neither *N. clarkii* nor *N. fasciata* represented clades, but rather the two shared a complex evolutionary history. Jansen (2001) also found *N. clarkii* and *N. fasciata* to be paraphyletic using *cyt b*. Although I only analyzed 974 bases of *cyt b* data, my results are concordant with the 6243 bases of combined nuclear and mitochondrial data from Guo et al. (2012). I recovered paraphyly of *Nerodia*, *Regina*, and *Thamnophis* along with seven of their congeners. Only nine of the 52 species in my analysis appeared paraphyletic, which reflects the same patterns observed using a much larger dataset. Therefore, my *cyt b* data adequately described the species-level phylogenetic relationships in the *N. clarkii/fasciata* clade.

Morphology

My morphological results indicate that most of the commonly used scale-count characters are uninformative for systematic and taxonomic purposes in this system. These results make sense in light of several previous studies. First, Osgood (1978) found that temperature variation during pre-natal development affected scale and vertebral counts in *N. fasciata*. The taxonomy of *N. fasciata* and *N. clarkii* has been fraught with conflicting reports since the first descriptions. Scale counts have always been similar between the two species, but many studies cited overlapping scale-count values and distinguish taxa based on color

pattern and ecology (Clay, 1938; Carr & Goin, 1942; Hebrard & Lee, 1981). Others synonymized taxa due to a lack of morphological differentiation (Dunson, 1979). Several researchers found similar discordance between morphology and genetics in other morphologically-defined taxa (Makowsky et al., 2010; Tursi et al., 2012). Although I did not rigorously test color pattern data in my analyses, I assigned specimens to taxon names according, in part, to color patterns. I observed discordance between taxonomic groups and genetic diversity in my phylogenetic analyses, which suggests that the color patterns may not reflect evolutionary history in this species group.

Conclusions

My research follows a growing list of studies that support a Pleistocene-driven phylogeographic break in the panhandle of Florida (e.g. Auffenberg, 1958; Milstead, 1969; Pauly et al., 2007; Guiher & Burbrink, 2008; Douglas et al., 2009; Strickland, 2011; Campbell-Staton et al., 2012). Viewed from a taxonomic perspective, my results indicate that the current species and subspecies designations within the *N. clarkii/fasciata* clade do not represent natural groups and inadequately describe the variation present in this lineage. My morphological and ecological results suggest that these populations have a remarkable adaptability, allowing them to take advantage of both fresh and salt water environments. These data demonstrate the need for an intense, range-wide systematic study of *N. clarkii/fasciata* to better understand the ecology of these unique snakes and to generate an improved taxonomy.

I found no evidence for genetic, morphological, or ecological distinction of *N. clarkii taeniata* and therefore recommend that *N. clarkii taeniata* be delisted from its threatened status. Dunson (1979) and Jansen et al. (2008) proposed that *N. clarkii compressicauda* deserves additional conservation attention as a result of locally-restricted population sizes. They assumed distinct evolutionary histories and trajectories for *N. clarkii compressicauda* and *N. f. pictiventris* and treated them independently (despite Jansen 2001 finding *N. clarkii* and *N. fasciata* paraphyletic). However, I found no evidence to support their concerns; on the contrary, *N. clarkii/fasciata* is highly adaptable and boasts a wide array of phenotypic and genetic diversity. Future management-oriented studies should include all local members of the *N. clarkii/fasciata* clade and take a fine-scale genetic approach to determine if anthropogenic change affected gene flow between populations.

APPENDIX A: IMAGES OF REPRESENTATIVE *NERODIA CLARKII*
CLARKII

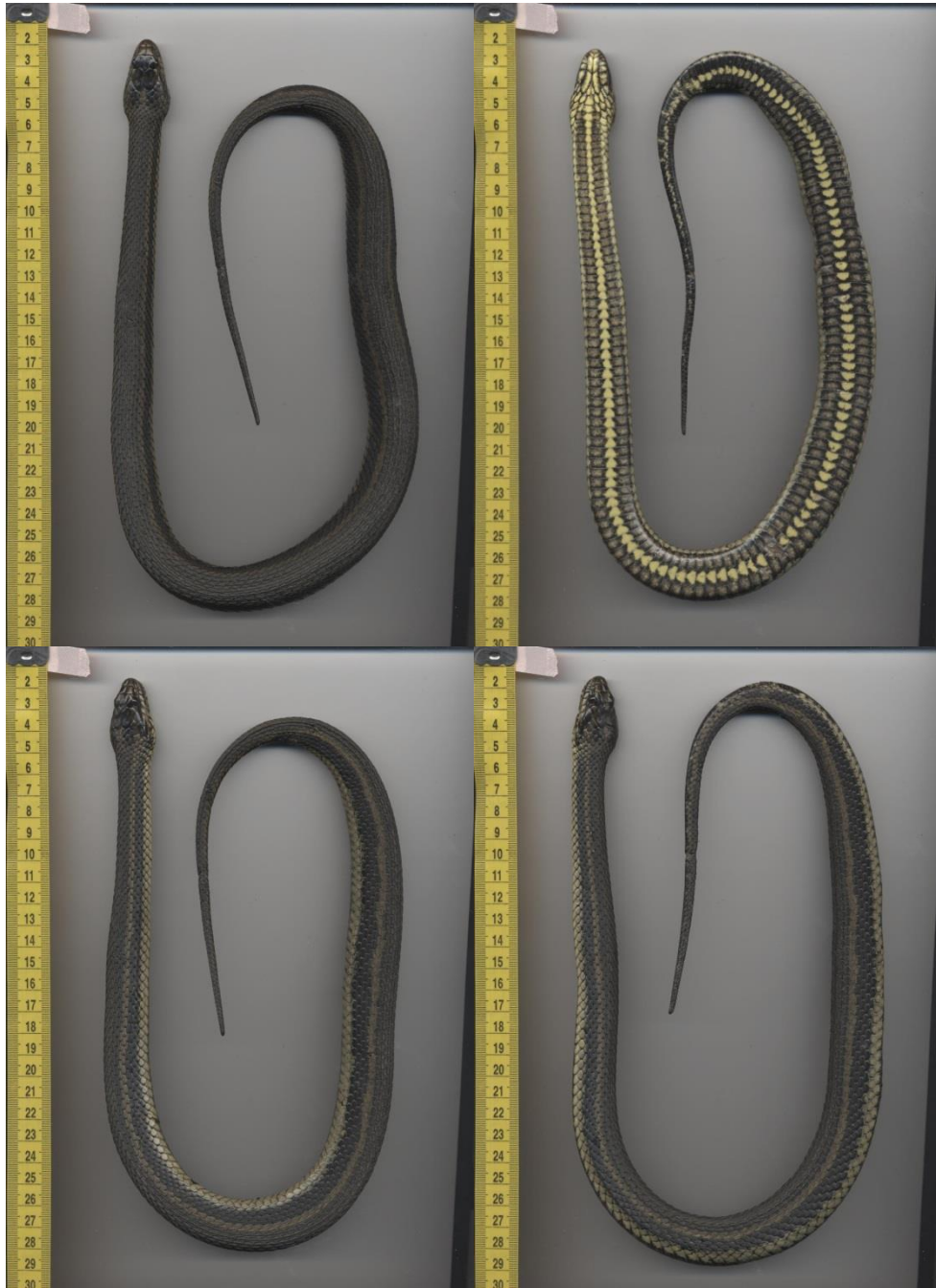

Appendix A1. Dorsal, ventral, and lateral images of CLP 1237, a typical representative of the *N. clarkii clarkii* phenotype that I collected.



Appendix A2. Dorsal, ventral, and lateral images of CLP 1239, a typical representative of the *N. clarkii clarkii* phenotype that I collected.

**APPENDIX B: IMAGES OF REPRESENTATIVE *NERODIA CLARKII*
*COMPRESSICAUDA***

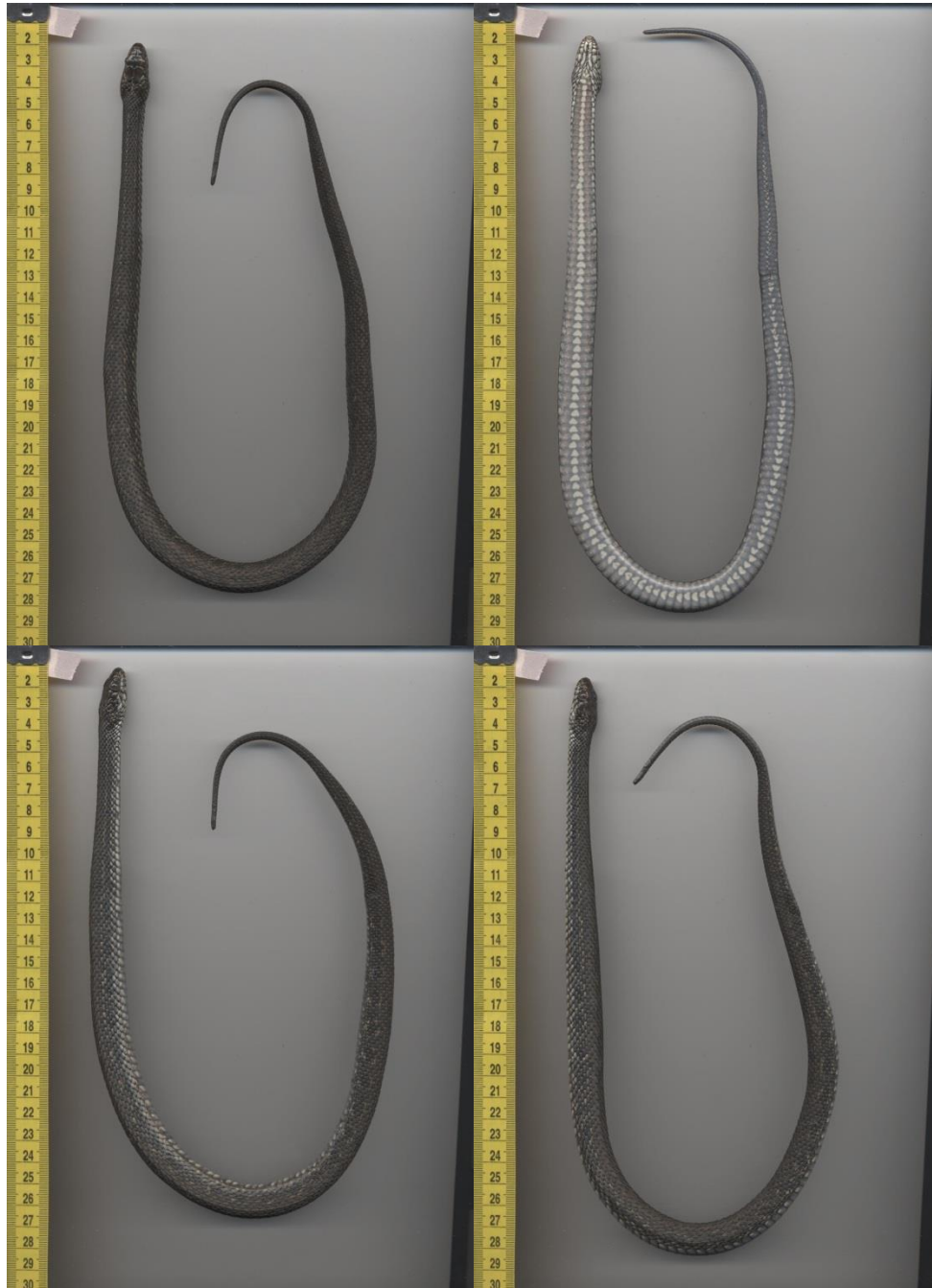

Appendix B1. Dorsal, ventral, and lateral images of CLP 1192, a typical representative of one of the *N. clarkii compressicauda* phenotypes that I collected. The snake was opaque and preparing to shed when it was photographed, so the colors appear lighter and muted.



Appendix B2. Dorsal, ventral, and lateral images of CLP 1176, a typical representative of one of the *N. clarkii compressicauda* phenotypes that I collected.



Appendix B3. Dorsal, ventral, and lateral images of CLP 1191, a typical representative of one of the *N. clarkii compressicauda* phenotypes that I collected.

**APPENDIX C: IMAGES OF REPRESENTATIVE *NERODIA CLARKII*
*TAENIATA***

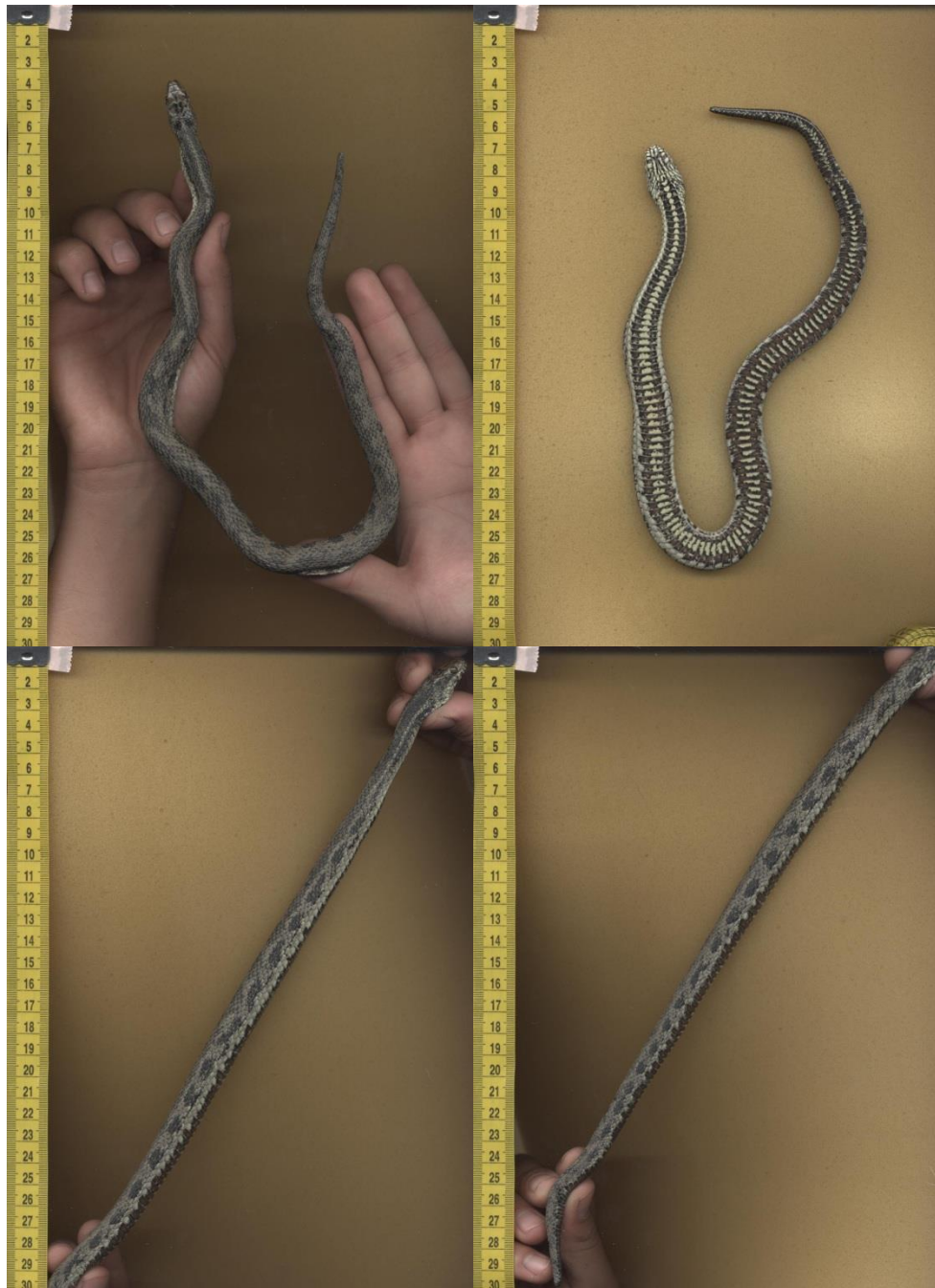



Appendix C1. Dorsal, ventral, and lateral images of CLPT 02, one of the two *N. clarkii taeniata* phenotypes that I collected.

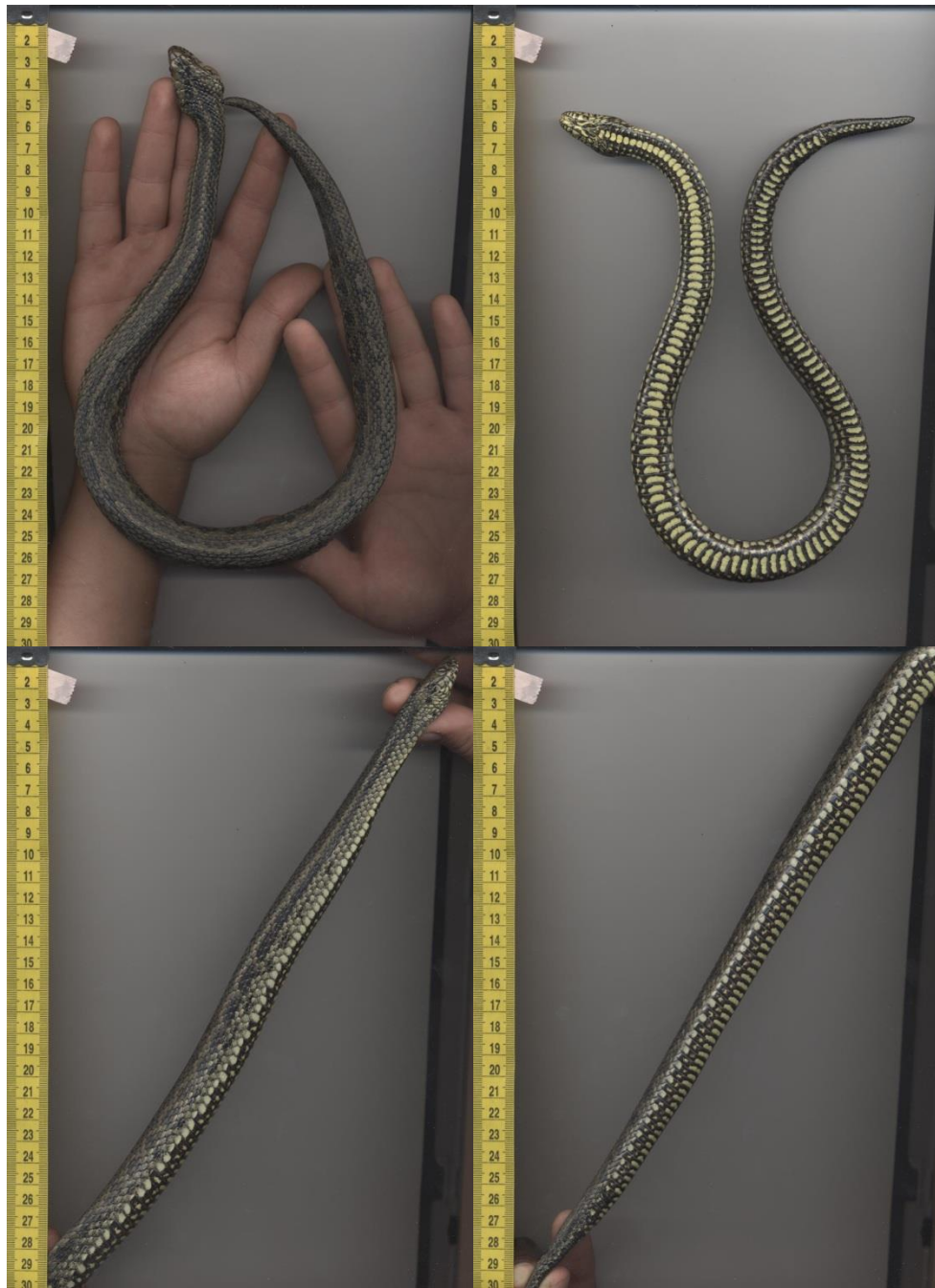



Appendix C2. Dorsal, ventral, and lateral images of CLPT 03, one of the two *N. clarkii taeniata* phenotypes that I collected.

**APPENDIX D: IMAGES OF REPRESENTATIVE *NERODIA FASCIATA*
*FASCIATA***

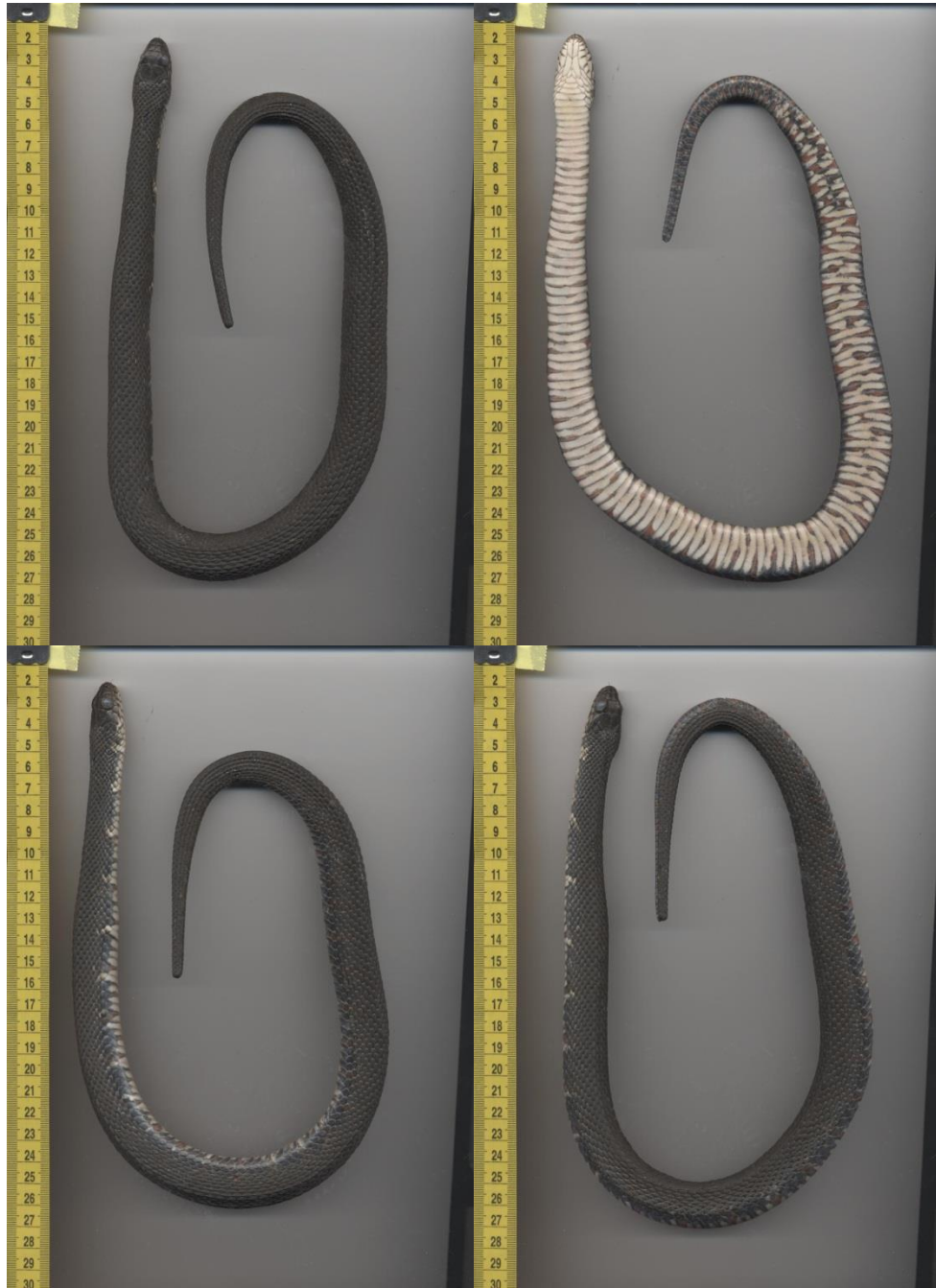

Appendix D. Dorsal, ventral, and lateral images of CLP 1285, a typical representative of the *N. fasciata fasciata* phenotypes that I collected. The snake was opaque and preparing to shed when it was photographed, so the colors appear lighter and muted.

**APPENDIX E: IMAGES OF REPRESENTATIVE *NERODIA FASCIATA*
*PICTIVENTRIS***



Appendix E1. Dorsal, ventral, and lateral images of CLP 1154, a typical representative of the *N. fasciata pictiventris* phenotypes that I collected.



Appendix E2. Dorsal, ventral, and lateral images of CLP 1227, a typical representative of the *N. fasciata pictiventris* phenotypes that I collected.

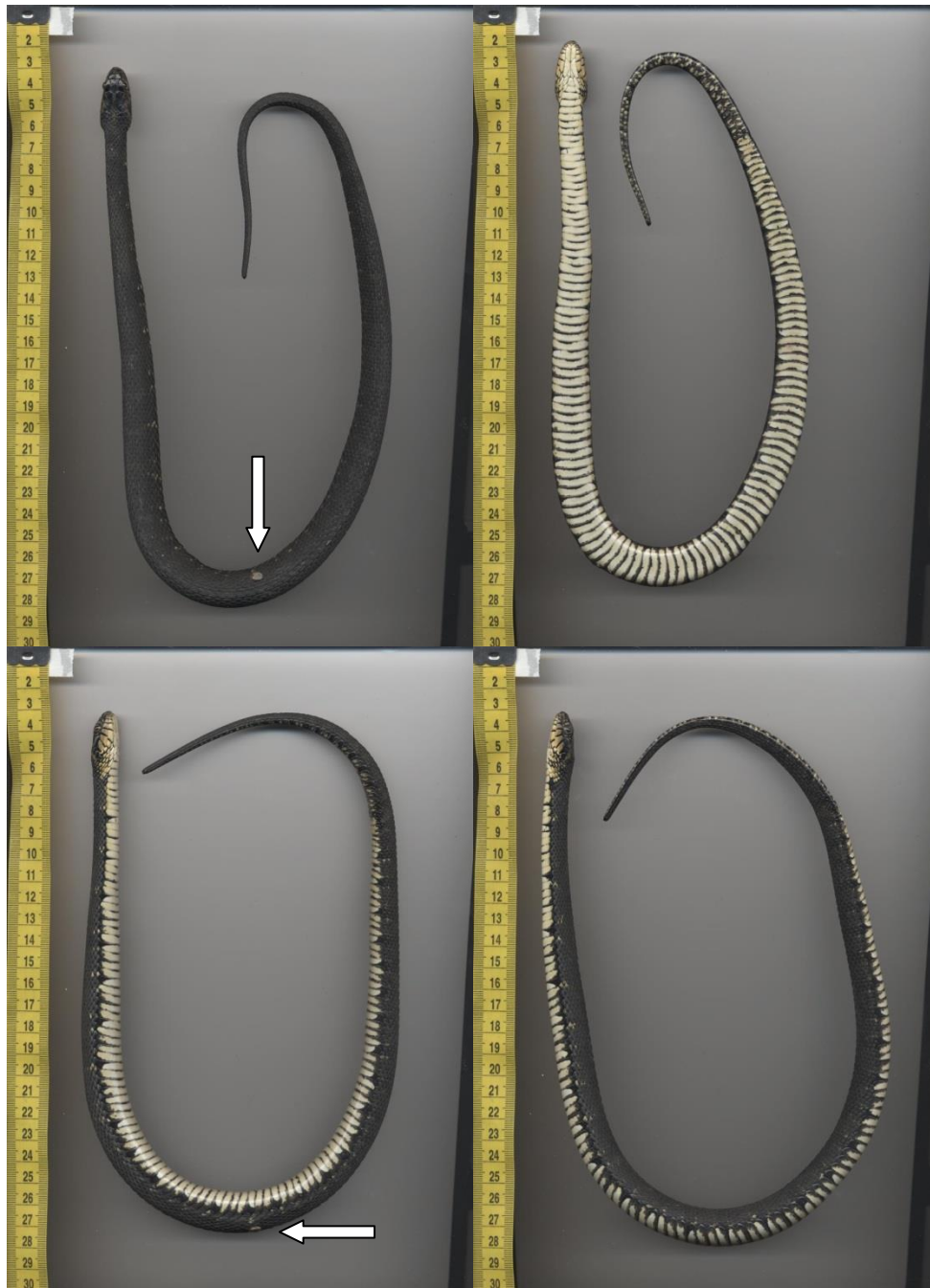

Appendix E3. Dorsal, ventral, and lateral images of CLP 1139, a typical representative of the *N. fasciata pictiventris* phenotypes that I collected. Arrows point to an ectoparasite (tick) attached to the snake.

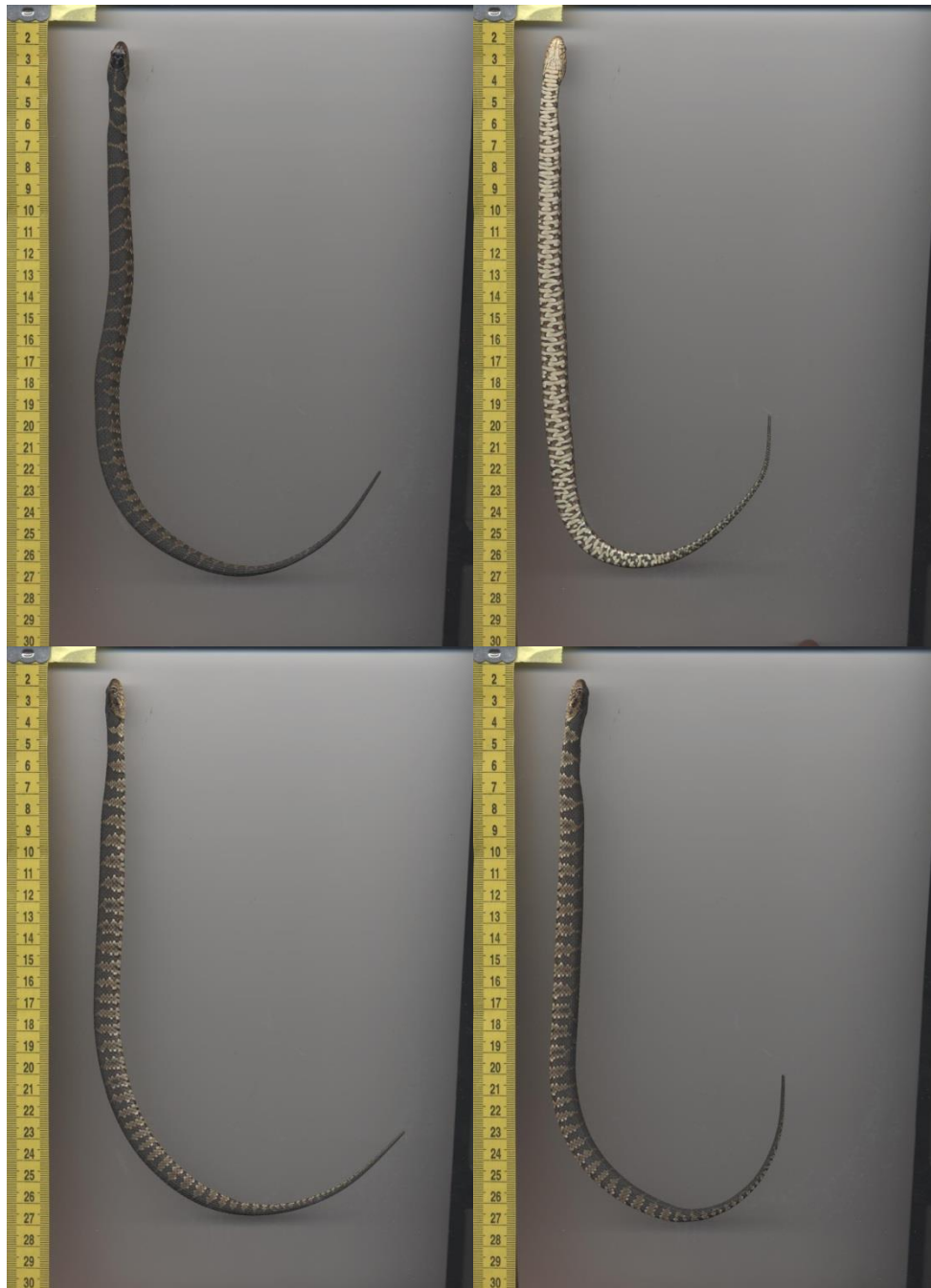

Appendix E4. Dorsal, ventral, and lateral images of CLP 1292, a typical representative of the *N. fasciata pictiventris* phenotypes that I collected.

**APPENDIX F: IMAGES OF REPRESENTATIVE QUESTIONABLE
*NERODIA CLARKII/FASCIATA***



Appendix F1. Dorsal, ventral, and lateral images of CLP 1233, one of the three Gulf Coast "*taeniata*" phenotypes that I collected.



Appendix F2. Dorsal, ventral, and lateral images of CLP 1250, one of the three Gulf Coast "*taeniata*" phenotypes that I collected.



Appendix F3. Dorsal, ventral, and lateral images of CLP 1258, one of the three Gulf Coast "*taeniata*" phenotypes that I collected.



Appendix F4. Dorsal, ventral, and lateral images of CLP 1150, a typical representative of the questionable *N. clarkii/taeniata* phenotypes that I collected at Turnbull Creek.



Appendix F5. Dorsal, ventral, and lateral images of CLP 1218, a typical representative of the questionable *N. clarkii/taeniata* phenotypes that I collected at Eckerd College.



Appendix F6. Dorsal, ventral, and lateral images of CLP 1193, a hyper-melanistic representative of the questionable *N. clarkii/taeniata* phenotype.



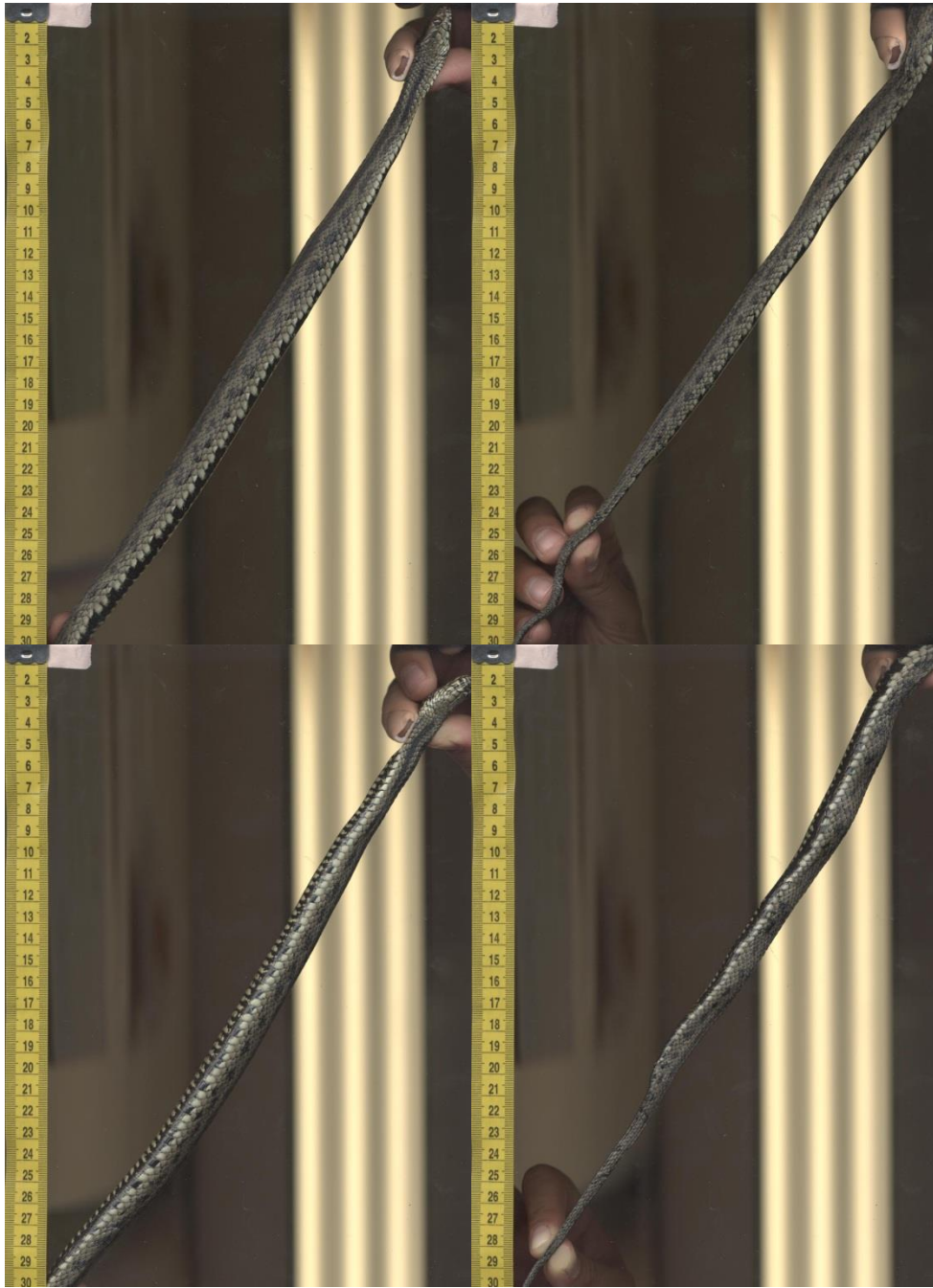

Appendix F7. Dorsal, ventral, and lateral images of CLPT 04, one of the questionable *N. clarkii/taeniata* phenotypes that matched the description of *N. clarkii taeniata* except for dorsal scale rows at midbody.



Appendix F8. Dorsal, ventral, and lateral images of CLP 1303, one of the questionable *N. clarkii/taeniata* phenotypes that matched the description of *N. fasciata pictiventris* except for dorsal scale rows at midbody.



Appendix F9. Dorsal, ventral, and lateral images of CLP 1190, one of the questionable *N. clarkii/taeniata* phenotypes that matched the description of *N. clarkii compressicauda* except for dorsal scale rows at midbody.



Appendix F10. Dorsal, ventral, and lateral images of CLPT 26, one of the questionable *N. clarkii/taeniata* phenotypes that matched the description of *N. clarkii compressicauda* except for dorsal scale rows at midbody.

APPENDIX G: PHOTOS OF CLP 1187 AND OFFSPRING



Appendix G. Photos of CLP 1187 and four of five offspring (left), same four of five offspring from CLP 1187 (right), including three with *N. fasciata* coloration.

APPENDIX H: TABLE OF SAMPLES AND LOCALITIES

Appendix H. Table of samples obtained for this study. Asterisk indicates samples I included as haplotype representatives in my *cyt b* haplotype phylogenetic analysis. Bold indicates haplotype representatives used in my conservative *cyt b* haplotype phylogenetic analysis. ALC = Alachua, BRE = Brevard, CIT = Citrus, CLM = Columbia, DAD = Miami-Dade, DES = DeSoto, DIX = Dixie, FLG = Flagler, GUL = Gulf, HEN = Hendry, HIG = Highlands, IDR = Indian River, LAK = Lake, LEO = Leon, LEV = Levy, LIB = Liberty, ORA = Orange, OSC = Osceola, PAL = Palm Beach, PIN = Pinellas, SAN = Santa Rosa, SEM = Seminole, STL = St. Lucie, TAY = Taylor, THO, GA = Thomas Georgia, VOL = Volusia, WAK = Wakulla, WAL = Walton.

Specimen ID	Taxon	Locality					Sequence Data Used					Sample Providers
		County	Watershed	Zone	Easting	Northing	<i>cyt b</i>	RAG1	RPS8	SELT	SPTBN1	
CLP 0945	<i>N. f. pictiventris</i>	ORA	St. Johns River, Upper	17 R	0485967	3155790	X	X				This study
CLP 0946	<i>N. f. pictiventris</i>	ORA	St. Johns River, Upper	17 R	0486112	3155571	X	X			X	This study
CLP 0947	<i>N. f. pictiventris</i>	ORA	St. Johns River, Upper	17 R	0486106	3155580	X				X	This study
CLP 0948	<i>N. f. pictiventris</i>	ORA	St. Johns River, Upper	17 R	0486123	3155588	X					This study
* CLP 0949	<i>N. f. pictiventris</i>	ORA	St. Johns River, Upper	17 R	0485947	3155726	X					This study
CLP 0950	<i>N. f. pictiventris</i>	ORA	St. Johns River, Upper	17 R	0486107	3155575	X					This study
CLP 0951	<i>N. f. pictiventris</i>	ORA	St. Johns River, Upper	17 R	0486102	3155581	X					This study
CLP 0952	<i>N. f. pictiventris</i>	ORA	St. Johns River, Upper	17 R	0485989	3155779	X					This study
CLP 0953	<i>N. f. pictiventris</i>	ORA	St. Johns River, Upper	17 R	0486115	3155564	X					This study
CLP 0954	<i>N. f. pictiventris</i>	ORA	St. Johns River, Upper	17 R	0479768	3158929	X					This study
CLP 0955	<i>N. c./f. questionable</i>	ORA	St. Johns River, Upper	17 R	0480720	3163458	X					This study
* CLP 0956	<i>N. f. pictiventris</i>	FLG	East Coast, Upper	17 R	0479812	3277971	X					This study
CLP 0957	<i>N. c./f. questionable</i>	FLG	East Coast, Upper	17 R	0479835	3277966	X					This study
CLP 0958	<i>N. f. pictiventris</i>	FLG	East Coast, Upper	17 R	0480844	3165195	X					This study
CLP 0959	<i>N. f. pictiventris</i>	FLG	East Coast, Upper	17 R	0480844	3165195	X	X				This study
CLP 0960	<i>N. f. pictiventris</i>	FLG	East Coast, Upper	17 R	0479812	3277971	X	X			X	This study
CLP 0961	<i>N. f. pictiventris</i>	FLG	East Coast, Upper	17 R	0480844	3165195	X					This study
CLP 0962	<i>N. f. pictiventris</i>	FLG	East Coast, Upper	17 R	0479812	3277971	X					This study
CLP 0963	<i>N. f. pictiventris</i>	FLG	East Coast, Upper	17 R	0479812	3277971	X					This study
CLP 0964	<i>N. f. pictiventris</i>	FLG	East Coast, Upper	17 R	0479812	3277971	X					This study
CLP 0965	<i>N. f. pictiventris</i>	FLG	East Coast, Upper	17 R	0479812	3277971	X					This study
* CLP 0966	<i>N. f. pictiventris</i>	DAD	Southeast Florida Coast	17 R	0545165	2829649	X					Jim Peters
* CLP 0969	<i>N. floridana</i>	ORA	St. Johns River, Upper	17 R	0486110	3155573	X		X			This study
* CLP 0970	<i>N. f. pictiventris</i>	DAD	Southeast Florida Coast	17 R	0552254	2832545	X	X				J. Peters
* CLP 0971	<i>N. f. pictiventris</i>	DAD	Southeast Florida Coast	17 R	0552254	2832545	X				X	J. Peters
* CLP 0972	<i>N. f. pictiventris</i>	DAD	Southeast Florida Coast	17 R	0552254	2832545	X					J. Peters
* CLP 0973	<i>N. f. pictiventris</i>	OSC	Kissimmee River	17 R	0489339	3087053	X	X				J. Peters
* CLP 0974	<i>N. f. pictiventris</i>	OSC	Kissimmee River	17 R	0489339	3087053	X	X				J. Peters

Specimen ID	Taxon	County	Locality				Sequence Data Used				Sample Providers	
			Watershed	Zone	Easting	Northing	cyt b	RAG1	RPS8	SELT		SPTBN1
CLP 0975	<i>N. f. pictiventris</i>	ORA	St. Johns River, Upper	17 R	0473959	3162680	X					J. Peters
CLP 0976	<i>N. f. pictiventris</i>	OSC	Kissimmee River	17 R	0479997	3099938	X					This study
CLP 0977	<i>N. f. pictiventris</i>	ORA	St. Johns River, Upper	17 R	0486111	3155575	X					This study
CLP 0978	<i>N. f. pictiventris</i>	DAD	Southeast Florida Coast	17 R	0552254	2832545	X					J. Peters & S. McDaniel
CLP 0979	<i>N. f. pictiventris</i>	DAD	Southeast Florida Coast	17 R	0552254	2832545	X					J. Peters & S. McDaniel
CLP 0980	<i>N. c./f. questionable</i>	CLM	St. Marys River	17 R	0359813	3351467	X					J. Peters & E. Casano
CLP 0983	<i>N. f. fasciata</i>	THO, GA		16 R	0781179	3430617	X		X			This study
CLP 0990	<i>N. c./f. questionable</i>	VOL	East Coast, Middle	17 R	0513656	3187846	X					This study
CLP 0991	<i>N. c./f. questionable</i>	VOL	East Coast, Middle	17 R	0513659	3187864	X					This study
* CLP 1127	<i>N. f. pictiventris</i>	BRE	Indian River, South	17 R	0551968	3086283	X					K. R. Sims
CLP 1128	<i>N. c./f. questionable</i>	VOL	East Coast, Middle	17 R	0513647	3188035	X					This study
CLP 1129	<i>N. c./f. questionable</i>	VOL	East Coast, Middle	17 R	0513655	3187848	X					This study
CLP 1130	<i>N. c./f. questionable</i>	VOL	East Coast, Middle	17 R	0513665	3187888	X					This study
CLP 1131	<i>N. c. compressicauda</i>	IDR	Indian River, South	17 R	0556388	3077102	X					K. R. Sims
CLP 1132	<i>N. c. compressicauda</i>	IDR	Indian River, South	17 R	0556417	3077161	X					K. R. Sims
* CLP 1133	<i>N. c./f. questionable</i>	BRE	Indian River, South	17 R	0552379	3083512	X					K. R. Sims
* CLP 1134	<i>N. c./f. questionable</i>	VOL	East Coast, Middle	17 R	0513653	3187974	X					This study
* CLP 1135	<i>N. c./f. questionable</i>	VOL	East Coast, Middle	17 R	0513660	3187865	X					This study
CLP 1136	<i>N. c./f. questionable</i>	VOL	East Coast, Middle	17 R	0513659	3187845	X					This study
CLP 1137	<i>N. c./f. questionable</i>	VOL	East Coast, Middle	17 R	0513599	3187737	X					This study
CLP 1138	<i>N. c./f. questionable</i>	VOL	East Coast, Middle	17 R	0513615	3187708	X					This study
CLP 1139	<i>N. f. pictiventris</i>	PAL	Southeast Florida Coast	17 R	0589326	2936089	X					This study
* CLP 1140	<i>N. f. pictiventris</i>	LEV	Oklawaha River	17 R	0360365	3259626	X					This study
CLP 1141	<i>N. c./f. questionable</i>	VOL	East Coast, Middle	17 R	0513714	3187894	X					This study
CLP 1142	<i>N. c./f. questionable</i>	VOL	East Coast, Middle	17 R	0513707	3187964	X					This study
CLP 1143	<i>N. c./f. questionable</i>	VOL	East Coast, Middle	17 R	0513714	3187976	X					This study
CLP 1144	<i>N. c./f. questionable</i>	VOL	East Coast, Middle	17 R	0513692	3188036	X					This study
CLP 1145	<i>N. c./f. questionable</i>	VOL	East Coast, Middle	17 R	0513702	3188002	X					This study
CLP 1146	<i>N. c./f. questionable</i>	VOL	East Coast, Middle	17 R	0513712	3187916	X					This study
CLP 1147	<i>N. c./f. questionable</i>	VOL	East Coast, Middle	17 R	0513663	3187908	X					This study
CLP 1148	<i>N. c./f. questionable</i>	VOL	East Coast, Middle	17 R	0513608	3187711	X					This study
CLP 1149	<i>N. c./f. questionable</i>	VOL	East Coast, Middle	17 R	0513650	3187810	X					This study

Specimen ID	Taxon	County	Locality				Sequence Data Used					Sample Providers
			Watershed	Zone	Easting	Northing	cyt b	RAG1	RPS8	SELT	SPTBN1	
* CLP 1150	<i>N. c./f. questionable</i>	VOL	East Coast, Middle	17 R	0513614	3187751	X		X	X		This study
CLP 1151	<i>N. c./f. questionable</i>	VOL	East Coast, Middle	17 R	0513599	3187750	X		X	X		This study
CLP 1152	<i>N. f. pictiventris</i>	ORA	St. Johns River, Upper	17 R	0485821	3155981	X		X	X		This study
* CLP 1153	<i>N. f. pictiventris</i>	ORA	St. Johns River, Upper	17 R	0485821	3155981	X		X	X		This study
CLP 1154	<i>N. f. pictiventris</i>	ORA	St. Johns River, Upper	17 R	0486104	3155579	X					This study
CLP 1155	<i>N. f. pictiventris</i>	ORA	St. Johns River, Upper	17 R	0485821	3155981	X					This study
CLP 1156	<i>N. f. pictiventris</i>	ORA	St. Johns River, Upper	17 R	0485798	3156004	X					This study
CLP 1158	<i>N. c./f. questionable</i>	BRE	Indian River, South	17 R	0552189	3083906	X					K. R. Sims
CLP 1159	<i>N. f. pictiventris</i>	ORA	St. Johns River, Upper	17 R	0474577	3151021	X					This study
CLP 1160	<i>N. c. compressicauda</i>	BRE	Indian River, South	17 R	0552183	3083905	X					K. R. Sims
CLP 1161	<i>N. f. pictiventris</i>	ORA	St. Johns River, Upper	17 R	0486116	3155576	X					This study
CLP 1162	<i>N. f. pictiventris</i>	ORA	St. Johns River, Upper	17 R	0486112	3155577	X					This study
CLP 1163	<i>N. f. pictiventris</i>	ORA	St. Johns River, Upper	17 R	0486106	3155577	X					This study
CLP 1164	<i>N. f. pictiventris</i>	ORA	St. Johns River, Upper	17 R	0486110	3155582	X					This study
CLP 1165	<i>N. f. pictiventris</i>	ORA	St. Johns River, Upper	17 R	0485811	3155988	X					This study
* CLP 1167	<i>N. f. pictiventris</i>	LAK	Oklawaha River	17 R	0417061	3163515	X					This study
CLP 1168	<i>N. c./f. questionable</i>	BRE	Indian River, South	17 R	0552183	3083905	X					K. R. Sims
CLP 1169	<i>N. f. pictiventris</i>	BRE	Indian River, South	17 R	0552696	3082966	X					K. R. Sims
CLP 1170	<i>N. c./f. questionable</i>	BRE	Indian River, South	17 R	0552696	3082966	X					K. R. Sims
CLP 1171	<i>N. c./f. questionable</i>	BRE	Indian River, South	17 R	0552454	3083297						K. R. Sims
CLP 1176	<i>N. c. compressicauda</i>	PIN	Tampa Bay	17 R	0333697	3066283	X					This study
* CLP 1177	<i>N. c. compressicauda</i>	PIN	Tampa Bay	17 R	0333713	3066287	X					This study
CLP 1178	<i>N. c. compressicauda</i>	PIN	Tampa Bay	17 R	0333713	3066287	X					This study
CLP 1179	<i>N. c. compressicauda</i>	PIN	Tampa Bay	17 R	0333698	3066286	X					This study
CLP 1180	<i>N. c. compressicauda</i>	PIN	Tampa Bay	17 R	0333697	3066283	X					This study
CLP 1181	<i>N. c. compressicauda</i>	PIN	Tampa Bay	17 R	0333713	3066287	X		X	X		This study
CLP 1182	<i>N. c. compressicauda</i>	PIN	Tampa Bay	17 R	0333698	3066286	X					This study
CLP 1183	<i>N. c. compressicauda</i>	PIN	Tampa Bay	17 R	0333621	3066276	X					This study
CLP 1184	<i>N. c. compressicauda</i>	PIN	Tampa Bay	17 R	0333767	3066328	X					This study
CLP 1185	<i>N. c. compressicauda</i>	PIN	Tampa Bay	17 R	0333767	3066328	X					This study
CLP 1186	<i>N. c./f. questionable</i>	PIN	Tampa Bay	17 R	0333767	3066328	X					This study
CLP 1187	<i>N. c. compressicauda</i>	PIN	Tampa Bay	17 R	0333767	3066328	X					This study

Specimen ID	Taxon	County	Locality				Sequence Data Used					Sample Providers
			Watershed	Zone	Easting	Northing	cyt b	RAG1	RPS8	SELT	SPTBN1	
* CLP 1188	<i>N. f. pictiventris</i>	BRE	Indian River, South	17 R	0538821	3077739	X					This study
CLP 1189	<i>N. f. pictiventris</i>	BRE	Indian River, South	17 R	0538821	3077739	X					This study
* CLP 1190	<i>N. c./f. questionable</i>	IDR	Indian River, South	17 R	0554294	3081214	X	X				This study
* CLP 1191	<i>N. c. compressicauda</i>	BRE	Indian River, South	17 R	0549269	3090392	X					This study
CLP 1192	<i>N. c. compressicauda</i>	IDR	Indian River, South	17 R	0554218	3081176	X		X	X		This study
CLP 1193	<i>N. c./f. questionable</i>	IDR	Indian River, South	17 R	0554082	3080968	X		X	X		This study
CLP 1194	<i>N. c. compressicauda</i>	IDR	Indian River, South	17 R	0554294	3081206	X					This study
CLP 1195	<i>N. c./f. questionable</i>	BRE	Indian River, South	17 R	0552492	3083214	X					K. R. Sims
CLP 1196	<i>N. c./f. questionable</i>	BRE	Indian River, South	17 R	0552534	3083187	X					K. R. Sims
CLP 1197	<i>N. c./f. questionable</i>	BRE	Indian River, South	17 R	0552443	3083217	X					K. R. Sims
CLP 1198	<i>N. c./f. questionable</i>	BRE	Indian River, South	17 R	0552350	3083919	X					K. R. Sims
CLP 1199	<i>N. c./f. questionable</i>	BRE	Indian River, South	17 R	0552156	3083875	X					K. R. Sims
* CLP 1200	<i>N. c. clarkii</i>	LEV	Wacasassa River	17 R	0302836	3228164	X					K. R. Sims
* CLP 1201	<i>N. f. pictiventris</i>	IDR	St. Johns River, Upper	17 R	0521535	3064436	X					K. R. Sims
CLP 1202	<i>N. c./f. questionable</i>	IDR		17 R	0555646	3078998						K. R. Sims
CLP 1203	<i>N. c. clarkii</i>	TAY		17 R	0242070	3313013						K. R. Sims
CLP 1204	<i>N. f. fasciata</i>	TAY		17 R	0242158	3313110						K. R. Sims
CLP 1205	<i>N. f. pictiventris</i>	IDR		17 R	0531957	3057416						K. R. Sims
CLP 1206	<i>N. c. taeniata</i>						X					K. R. Sims
CLP 1207	<i>N. c./f. questionable</i>	BRE		17 R	0549784	3088723						K. R. Sims
CLP 1208	<i>N. c. compressicauda</i>	BRE		17 R	0549793	3088708						K. R. Sims
CLP 1209	<i>N. c./f. questionable</i>	BRE		17 R	0550154	3088537						K. R. Sims
CLP 1210	<i>N. c./f. questionable</i>	BRE		17 R	0547261	3095040						K. R. Sims
CLP 1211	<i>N. c./f. questionable</i>	BRE		17 R	0547209	3095037						K. R. Sims
CLP 1212	<i>N. c./f. questionable</i>	BRE		17 R	0547163	3095064						K. R. Sims
CLP 1213	<i>N. c./f. questionable</i>	PIN	Tampa Bay	17 R	0333717	3066288	X					This study
CLP 1214	<i>N. c./f. questionable</i>	PIN	Tampa Bay	17 R	0333717	3066288	X					This study
CLP 1215	<i>N. f. pictiventris</i>	PIN	Tampa Bay	17 R	0333717	3066288	X		X	X		This study
CLP 1216	<i>N. c. compressicauda</i>	PIN	Tampa Bay	17 R	0333717	3066288	X					This study
CLP 1217	<i>N. c. compressicauda</i>	PIN	Tampa Bay	17 R	0333717	3066288	X					This study
CLP 1218	<i>N. c./f. questionable</i>	PIN		17 R	0333717	3066288						This study
CLP 1219	<i>N. c. compressicauda</i>	PIN		17 R	0333717	3066288						This study

Specimen ID	Taxon	County	Locality				Sequence Data Used				Sample Providers	
			Watershed	Zone	Easting	Northing	cyt b	RAG1	RPS8	SELT		SPTBN1
CLP 1220	<i>N. c. compressicauda</i>	PIN		17 R	0333717	3066288						This study
CLP 1221	<i>N. c. compressicauda</i>	PIN	Tampa Bay	17 R	0333717	3066288	X					This study
CLP 1227	<i>N. f. pictiventris</i>	FLG	East Coast, Upper	17 R	0479769	3277976	X					This study
CLP 1228	<i>N. f. pictiventris</i>	FLG	East Coast, Upper	17 R	0479763	3278032	X					This study
CLP 1230	<i>N. c./f. questionable</i>	LEV	Wacasassa River	17 R	0330717	3212972	X					P. Hill
CLP 1231	<i>N. c./f. questionable</i>	DIX	Econfina-Fenholoway	17 R	0270681	3267193	X					P. Hill
CLP 1232	<i>N. c. clarkii</i>	WAK	St. Marks River	16 R	0753853	3324369	X					This study
* CLP 1233	<i>N. c./f. questionable</i>	TAY	Econfina-Fenholoway	17 R	0223083	3324214	X		X	X		This study
CLP 1234	<i>N. c./f. questionable</i>	TAY	Econfina-Fenholoway	17 R	0223113	3324191	X					This study
CLP 1235	<i>N. c./f. questionable</i>	TAY	Econfina-Fenholoway	17 R	0223281	3324006	X					This study
CLP 1236	<i>N. c. clarkii</i>	TAY	Econfina-Fenholoway	17 R	0223282	3324006	X					This study
CLP 1237	<i>N. c. clarkii</i>	TAY	Econfina-Fenholoway	17 R	0223556	3323951	X					This study
CLP 1238	<i>N. c. clarkii</i>	TAY	Econfina-Fenholoway	17 R	0223846	3323969	X					This study
CLP 1239	<i>N. c. clarkii</i>	TAY	Econfina-Fenholoway	17 R	0223899	3323959	X					This study
CLP 1240	<i>N. c. clarkii</i>	TAY	Econfina-Fenholoway	17 R	0223961	3323957	X					This study
CLP 1241	<i>N. c. clarkii</i>	TAY	Econfina-Fenholoway	17 R	0224079	3323910	X					This study
* CLP 1242	<i>N. c. clarkii</i>	TAY	Econfina-Fenholoway	17 R	0224700	3323805	X		X			This study
CLP 1243	<i>N. c./f. questionable</i>	TAY	Econfina-Fenholoway	17 R	0224748	3323805	X					This study
CLP 1244	<i>N. c./f. questionable</i>	TAY	Econfina-Fenholoway	17 R	0224968	3323876	X					This study
CLP 1245	<i>N. c. clarkii</i>	TAY	Econfina-Fenholoway	17 R	0224968	3323876	X					This study
CLP 1246	<i>N. c. clarkii</i>	TAY	Econfina-Fenholoway	17 R	0224995	3323878	X					This study
* CLP 1247	<i>N. c./f. questionable</i>	TAY	Econfina-Fenholoway	17 R	0223358	3323949	X					This study
CLP 1248	<i>N. c./f. questionable</i>	TAY	Econfina-Fenholoway	17 R	0224700	3323813	X					This study
CLP 1249	<i>N. c. clarkii</i>	TAY	Econfina-Fenholoway	17 R	0223646	3323962	X					This study
CLP 1250	<i>N. c./f. questionable</i>	TAY	Econfina-Fenholoway	17 R	0223260	3324021	X					This study
* CLP 1251	<i>N. c./f. questionable</i>	TAY	Econfina-Fenholoway	17 R	0223308	3323984	X					This study
CLP 1252	<i>N. c. clarkii</i>	TAY	Econfina-Fenholoway	17 R	0224429	3323820	X					This study
CLP 1253	<i>N. c./f. questionable</i>	TAY	Econfina-Fenholoway	17 R	0222333	3325202	X					This study
CLP 1254	<i>N. c./f. questionable</i>	TAY	Econfina-Fenholoway	17 R	0222397	3325376	X					This study
CLP 1255	<i>N. c./f. questionable</i>	TAY	East Coast, Upper	17 R	0491541	3242936	X					This study
CLP 1256	<i>N. f. pictiventris</i>	TAY	East Coast, Upper	17 R	0491592	3242898	X					This study
* CLP 1257	<i>N. f. pictiventris</i>	TAY	East Coast, Upper	17 R	0491627	3242977	X					This study

Specimen ID	Taxon	County	Locality				Sequence Data Used					Sample Providers
			Watershed	Zone	Easting	Northing	cyt b	RAG1	RPS8	SELT	SPTBN1	
CLP 1258	<i>N. c./f. questionable</i>	TAY	Econfina-Fenholoway	17 R	0222397	3325376	X					This study
CLP 1260	<i>N. f. pictiventris</i>	VOL	East Coast, Upper	17 R	0491523	3242952	X					This study
CLP 1262	<i>N. c. compressicauda</i>	BRE		17 R	0529653	3145222						K. R. Sims
CLP 1263	<i>N. c./f. questionable</i>	BRE		17 R	0529653	3145222						K. R. Sims
CLP 1264	<i>N. c. compressicauda</i>	BRE		17 R	0549661	3088858						K. R. Sims
CLP 1265	<i>N. f. pictiventris</i>	BRE		17 R	0529865	3145192						K. R. Sims
CLP 1266	<i>N. c./f. questionable</i>	BRE		17 R	0549707	3088846						K. R. Sims
CLP 1267	<i>N. c./f. questionable</i>	BRE		17 R	0549746	3088806						K. R. Sims
CLP 1268	<i>N. f. pictiventris</i>	IDR		17 R	0553537	3054733						K. R. Sims
CLP 1269	<i>N. f. pictiventris</i>	BRE		17 R	0529835	3145167						K. R. Sims
CLP 1270	<i>N. f. pictiventris</i>	BRE		17 R	0529955	3145155						K. R. Sims
CLP 1271	<i>N. c. compressicauda</i>	BRE		17 R	0529881	3145174						K. R. Sims
CLP 1272	<i>N. c./f. questionable</i>	BRE		17 R	0529865	3145192						K. R. Sims
CLP 1273	<i>N. c./f. questionable</i>	BRE		17 R	0529865	3145192						K. R. Sims
CLP 1274	<i>N. c./f. questionable</i>	BRE		17 R	0529865	3145192						K. R. Sims
CLP 1275	<i>N. f. pictiventris</i>	BRE		17 R	0529865	3145192						K. R. Sims
CLP 1280	<i>N. f. pictiventris</i>	ORA	St. Johns River, Upper	17 R	0479875	3164736	X					This study
CLP 1281	<i>N. f. pictiventris</i>	ORA	St. Johns River, Upper	17 R	0479908	3164747	X					This study
CLP 1285	<i>N. f. fasciata</i>	THO, GA		17 R	0231710	3407236	X		X	X		This study
CLP 1286	<i>N. f. pictiventris</i>	SEM	St. Johns River, Upper	17 R	0475978	3180286	X					This study
CLP 1287	<i>N. f. pictiventris</i>	ORA	St. Johns River, Upper	17 R	0500431	3151920	X					This study
CLP 1288	<i>N. c. compressicauda</i>	BRE		17 R	0529816	3145223						K. R. Sims
CLP 1289	<i>N. c./f. questionable</i>	BRE		17 R	0549770	3088782						K. R. Sims
CLP 1292	<i>N. f. pictiventris</i>	ORA	St. Johns River, Upper	17 R	0510890	3151857	X					This study
CLP 1293	<i>N. f. pictiventris</i>	ORA	St. Johns River, Upper	17 R	0508577	3150428	X					This study
CLP 1295	<i>N. c./f. questionable</i>	BRE		17 R	0549666	3088855						K. R. Sims
CLP 1296	<i>N. c./f. questionable</i>	IDR		17 R	0555082	3080167						K. R. Sims
* CLP 1297	<i>N. c./f. questionable</i>	VOL	East Coast, Upper	17 R	0489363	3247955	X					This study
CLP 1298	<i>N. f. pictiventris</i>	VOL	East Coast, Upper	17 R	0489359	3247955	X					This study
CLP 1299	<i>N. f. pictiventris</i>	VOL	East Coast, Upper	17 R	0489354	3247959	X					This study
CLP 1300	<i>N. f. pictiventris</i>	VOL	East Coast, Upper	17 R	0489859	3247296	X					This study
CLP 1301	<i>N. f. pictiventris</i>	VOL	East Coast, Upper	17 R	0491623	3242639	X					This study

Specimen ID	Taxon	County	Locality				Sequence Data Used					Sample Providers
			Watershed	Zone	Easting	Northing	cyt b	RAG1	RPS8	SELT	SPTBN1	
* CLP 1302	<i>N. f. pictiventris</i>	VOL	East Coast, Upper	17 R	0491510	3242615	X					This study
CLP 1303	<i>N. c./f. questionable</i>	VOL	East Coast, Upper	17 R	0491250	3242528	X					This study
CLP 1304	<i>N. c./f. questionable</i>	VOL	East Coast, Upper	17 R	0491361	3242649	X					This study
CLP 1305	<i>N. f. pictiventris</i>	VOL	East Coast, Upper	17 R	0491435	3242696	X					This study
* CLP 1306	<i>N. f. pictiventris</i>	VOL	East Coast, Upper	17 R	0491510	3242612	X					This study
CLP 1307	<i>N. f. pictiventris</i>	VOL	East Coast, Upper	17 R	0491371	3242769	X					This study
CLP 1308	<i>N. f. pictiventris</i>	VOL	East Coast, Upper	17 R	0491534	3242568	X					This study
CLP 1309	<i>N. c./f. questionable</i>	VOL	East Coast, Upper	17 R	0491169	3242731	X					This study
CLP 1311	<i>N. c./f. questionable</i>	CIT	Crystal River-St. Pete	17 R	0338308	3200943	X					This study
CLP 1312	<i>N. f. pictiventris</i>	CIT	Crystal River-St. Pete	17 R	0338292	3200949	X					This study
CLP 1313	<i>N. c./f. questionable</i>	CIT	Crystal River-St. Pete	17 R	0338268	3200936	X					This study
* CLP 1314	<i>N. f. pictiventris</i>	CIT	Crystal River-St. Pete	17 R	0338292	3200949	X					This study
CLP 1315	<i>N. f. pictiventris</i>	CIT	Crystal River-St. Pete	17 R	0388292	3200949	X					This study
CLP 1316	<i>N. f. pictiventris</i>	CIT	Crystal River-St. Pete	17 R	0338289	3201055	X					This study
CLP 1317	<i>N. c./f. questionable</i>	CIT		17 R	0339194	3198830						This study
CLP 1318	<i>N. c./f. questionable</i>	CIT	Crystal River-St. Pete	17 R	0341239	3190863	X					This study
CLP 1319	<i>N. c./f. questionable</i>	CIT		17 R	0338530	3190835						This study
CLP 1320	<i>N. c./f. questionable</i>	CIT		17 R	0341726	3190873						This study
CLP 1325	<i>N. c./f. questionable</i>	STL		17 R	0568113	3043379						K. R. Sims
CLP 1326	<i>N. c./f. questionable</i>	STL		17 R	0568100	3043391						K. R. Sims
CLP 1327	<i>N. c./f. questionable</i>	STL		17 R	0567701	3043001						K. R. Sims
CLP 1328	<i>N. c./f. questionable</i>	STL		17 R	0567558	3043065						K. R. Sims
CLP 1329	<i>N. c./f. questionable</i>	STL		17 R	0567662	3043078						K. R. Sims
CLP 1330	<i>N. c./f. questionable</i>	STL		17 R	0567643	3043071						K. R. Sims
* CLPT 01	<i>N. c./f. questionable</i>	VOL	East Coast, Upper	17 R	0506166	3214248	X		X	X		This study
CLPT 02	<i>N. c. taeniata</i>	VOL	East Coast, Upper	17 R	0506182	3214257	X	X	X	X		This study
CLPT 03	<i>N. c. taeniata</i>	VOL	East Coast, Upper	17 R	0506166	3214252	X		X	X		This study
CLPT 04	<i>N. c./f. questionable</i>	VOL	East Coast, Upper	17 R	0506183	3214264	X		X	X		This study
CLPT 05	<i>N. f. pictiventris</i>	FLG	East Coast, Upper	17 R	0479791	3277973	X					This study
CLPT 06	<i>N. f. pictiventris</i>	FLG	East Coast, Upper	17 R	0479797	3278004	X					This study
CLPT 07	<i>N. f. pictiventris</i>	FLG	East Coast, Upper	17 R	0479797	3278004	X					This study
CLPT 09	<i>N. c./f. questionable</i>	FLG	East Coast, Upper	17 R	0479768	3278016	X					This study

Specimen ID	Taxon	County	Locality				Sequence Data Used				Sample Providers	
			Watershed	Zone	Easting	Northing	cyt b	RAG1	RPS8	SELT		SPTBN1
CLPT 11	<i>N. f. pictiventris</i>	FLG	East Coast, Upper	17 R	0479763	3278032	X					This study
CLPT 12	<i>N. f. pictiventris</i>	FLG	East Coast, Upper	17 R	0479801	3277985	X					This study
CLPT 13	<i>N. c./f. questionable</i>	FLG	East Coast, Upper	17 R	0479775	3278034	X					This study
CLPT 14	<i>N. f. pictiventris</i>	FLG	East Coast, Upper	17 R	0479812	3277969	X					This study
CLPT 15	<i>N. f. pictiventris</i>	FLG	East Coast, Upper	17 R	0479763	3278032	X					This study
CLPT 16	<i>N. f. pictiventris</i>	FLG	East Coast, Upper	17 R	0479781	3277983	X					This study
CLPT 17	<i>N. c. clarkii</i>	WAK	St. Marks River	16 R	0753853	3324369	X	X				P. Hill
CLPT 18	<i>N. c. clarkii</i>	WAK	St. Marks River	16 R	0753853	3324369	X					P. Hill
CLPT 19	<i>N. c. clarkii</i>	WAK	St. Marks River	16 R	0753853	3324369	X					P. Hill
CLPT 20	<i>N. c. clarkii</i>	WAK	St. Marks River	16 R	0753853	3324369	X		X			P. Hill
CLPT 21	<i>N. c. clarkii</i>	WAK	St. Marks River	16 R	0753853	3324369	X		X	X		P. Hill
* CLPT 22	<i>N. f. fasciata</i>	WAK	St. Marks River	16 R	0749727	3327529	X					P. Hill
CLPT 23	<i>N. c. clarkii</i>	WAK	St. Marks River	16 R	0753853	3324369	X					P. Hill
CLPT 24	<i>N. c. clarkii</i>	WAK	St. Marks River	16 R	0753853	3324369	X					P. Hill
CLPT 25	<i>N. c. clarkii</i>	WAK	St. Marks River	16 R	0753853	3324369	X					P. Hill
CLPT 26	<i>N. c./f. questionable</i>	WAK	St. Marks River	16 R	0753853	3324369	X					P. Hill
CLPT 27	<i>N. c./f. questionable</i>	WAK	St. Marks River	16 R	0753853	3324369	X					P. Hill
CLPT 28	<i>N. c. clarkii</i>	WAK	St. Marks River	16 R	0753853	3324369	X					P. Hill
* CLPT 29	<i>N. c. clarkii</i>	WAK	St. Marks River	16 R	0753853	3324369	X					P. Hill
CLPT 30	<i>N. c. clarkii</i>	WAK	St. Marks River	16 R	0753853	3324369	X					P. Hill
CLPT 31	<i>N. c. clarkii</i>	WAK	St. Marks River	16 R	0753853	3324369	X					P. Hill
CLPT 32	<i>N. c. clarkii</i>	WAK	St. Marks River	16 R	0753853	3324369	X					P. Hill
CLPT 33	<i>N. c. clarkii</i>	WAK	St. Marks River	16 R	0753853	3324369	X					P. Hill
CLPT 34	<i>N. c. clarkii</i>	WAK	St. Marks River	16 R	0753853	3324369	X					P. Hill
CLPT 35	<i>N. c. clarkii</i>	WAK	St. Marks River	16 R	0753853	3324369	X					P. Hill
CLPT 36	<i>N. c. clarkii</i>	WAK	St. Marks River	16 R	0753853	3324369	X					P. Hill
CLPT 37	<i>N. c. clarkii</i>	WAK	St. Marks River	16 R	0753853	3324369	X					P. Hill
CLPT 38	<i>N. c. clarkii</i>	WAK	St. Marks River	16 R	0753853	3324369	X					P. Hill
CLPT 39	<i>N. c. clarkii</i>	WAK	St. Marks River	16 R	0753853	3324369	X					P. Hill
* CLPT 40	<i>N. f. fasciata</i>	WAK	St. Marks River	16 R	0761431	762160	X					P. Hill
* CLPT 41	<i>N. f. fasciata</i>	WAK	St. Marks River	16 R	0762160	3335932	X					P. Hill
* FLMNH 146653	<i>N. fasciata</i>	SAN	Choctawhatchee Bay	16 R	0519192	3375218	X					FLMNH

Specimen ID	Taxon	County	Locality				Sequence Data Used				Sample Providers	
			Watershed	Zone	Easting	Northing	cyt b	RAG1	RPS8	SELT		SPTBN1
* FLMNH 150372	<i>N. clarkii</i>	CIT	Crystal River-St. Pete	17 R	0344176	3192758	X					FLMNH
FLMNH 150378	<i>N. clarkii</i>	CIT		17 R	0344176	3192758						FLMNH
FLMNH 151277	<i>N. fasciata</i>	HEN	Southeast Florida Coast	17 R	0501746	2940859	X					FLMNH
FLMNH 151292	<i>N. fasciata</i>	LEV	Wacasassa River	17 R	0333605	3238121	X					FLMNH
FLMNH 151460	<i>N. fasciata</i>	BRE		17 R	0531474	3088287						FLMNH
FLMNH 151482	<i>N. fasciata</i>	HEN		17 R	0501831	2936791						FLMNH
FLMNH 151483	<i>N. fasciata</i>	HEN	Southeast Florida Coast	17 R	0501782	2939231	X					FLMNH
FLMNH 151529	<i>N. fasciata</i>	HEN	Southeast Florida Coast	17 R	0501706	2944101	X					FLMNH
FLMNH 151560	<i>N. fasciata</i>	HEN		17 R	0501933	2944732						FLMNH
FLMNH 151561	<i>N. fasciata</i>	HEN		17 R	0486736	2923162						FLMNH
FLMNH 151562	<i>N. fasciata</i>	HEN		17 R	0501708	2943417						FLMNH
FLMNH 152288	<i>N. fasciata</i>	ALC	Oklawaha River	17 R	0380887	3284916	X					FLMNH
FLMNH 152421	<i>N. fasciata</i>	HIG	Kissimmee River	17 R	0463854	3013279	X					FLMNH
FLMNH 152422	<i>N. floridana</i>	HIG		17 R			X		X			FLMNH
FLMNH 152437	<i>N. fasciata</i>	DES	Fisheating Creek	17 R	0444224	3008201	X					FLMNH
FLMNH 152521	<i>N. fasciata</i>	LEO	St. Marks River	16 R	0766075	3364880	X					FLMNH
FLMNH 152527	<i>N. fasciata</i>	GUL	Chipola River	16 R	0674490	3333755	X					FLMNH
FLMNH 152675	<i>N. fasciata</i>	WAK	St. Marks River	16 R	0774673	3334743	X					FLMNH
FLMNH 153023	<i>N. fasciata</i>	WAL	Choctawhatchee Bay	16 R	0598367	3371672	X					FLMNH
FLMNH 153451	<i>N. clarkii</i>	LEV	Wacasassa River	17 R	0299043	3232605	X					FLMNH
FLMNH 155391	<i>N. fasciata</i>	ALC	Oklawaha River	17 R	0381621	3265918	X					FLMNH
FLMNH 155397	<i>N. fasciata</i>	ALC	Oklawaha River	17 R	0381621	3265918	X					FLMNH
* FLMNH 155398	<i>N. fasciata</i>	ALC	Oklawaha River	17 R	0381621	3265918	X					FLMNH
FLMNH 158882	<i>N. c. clarkii</i>	TAY	Econfina-Fenholoway	17 R	0223961	3325337	X	X				FLMNH
* FLMNH 159540	<i>N. fasciata</i>	LIB	Ochlocknee River	16 R	0718074	3345124						FLMNH
FLMNH 160366	<i>N. c. clarkii</i>	TAY	Econfina-Fenholoway	17 R	0223961	3325337	X	X				FLMNH
FLMNH 160367	<i>N. c. clarkii</i>	TAY	Econfina-Fenholoway	17 R	0223961	3325337	X					FLMNH

APPENDIX I: TABLE OF GENBANK SAMPLES

Appendix I. List of samples from GenBank and their *cyt b* accession numbers. Phylogenetic outgroups in bold.

Taxon	Citation	Accession #
Regina alleni	Alfaro & Arnold, 2001	AF402916
Thamnophis atratus	de Queiroz et al., 2002	AF420085
Thamnophis brachystoma	de Queiroz et al., 2002	AF420089
Thamnophis butleri	de Queiroz et al., 2002	AF420107
Thamnophis butleri	Alfaro & Arnold, 2001	AF402923
Thamnophis chrysocephalus	de Queiroz et al., 2002	AF420108
Clonophis kirtlandii	Alfaro & Arnold, 2001	AF402908
Thamnophis couchii	de Queiroz et al., 2002	AF420103
Thamnophis couchii	Alfaro & Arnold, 2001	AF402936
Nerodia cyclopion	Alfaro & Arnold, 2001	AF402909
Nerodia cyclopion	Makowsky et al., 2010	GQ285449
Thamnophis cyrtopsis collaris	de Queiroz et al., 2002	AF420099
Thamnophis cyrtopsis	de Queiroz & Lawson, 2008	EF417412
Thamnophis cyrtopsis cyrtopsis	de Queiroz et al., 2002	AF420109
Thamnophis cyrtopsis	Alfaro & Arnold, 2001	AF402924
Storeria dekayi	Alfaro & Arnold, 2001	AF402922
Thamnophis elegans terrestris	de Queiroz et al., 2002	AF420113
Thamnophis elegans	Alfaro & Arnold, 2001	AF402925
Thamnophis eques	de Queiroz et al., 2002	AF420117
Thamnophis errans	de Queiroz & Lawson, 2008	EF417411
Thamnophis errans	de Queiroz et al., 2002	AF420121
Nerodia erythrogaster neglecta	Fetzner, J. W. & L. R. Miller, unpublished 2001	AF337097
Nerodia erythrogaster flavigaster	Fetzner, J. W. & L. R. Miller, unpublished 2001	AF337099
Nerodia erythrogaster	de Queiroz et al., 2002	AF420081
Nerodia erythrogaster	Alfaro & Arnold, 2001	AF402912
Nerodia erythrogaster	Makowsky et al., 2010	GQ285486
Nerodia erythrogaster	Makowsky et al., 2010	GQ285565
Nerodia erythrogaster	Makowsky et al., 2010	GQ285575
Nerodia erythrogaster	Makowsky et al., 2010	GQ285547
Nerodia erythrogaster	Makowsky et al., 2010	GQ285582
Nerodia erythrogaster	Makowsky et al., 2010	GQ285507
Nerodia erythrogaster	Makowsky et al., 2010	GQ285460
Nerodia erythrogaster	Makowsky et al., 2010	GQ285563
Nerodia erythrogaster	Makowsky et al., 2010	GQ285502
Nerodia erythrogaster	Makowsky et al., 2010	GQ285456
Nerodia erythrogaster	Makowsky et al., 2010	GQ285457
Nerodia erythrogaster	Makowsky et al., 2010	GQ285553
Nerodia erythrogaster	Makowsky et al., 2010	GQ285586
Nerodia erythrogaster	Makowsky et al., 2010	GQ285518
Nerodia erythrogaster	Makowsky et al., 2010	GQ285548
Nerodia erythrogaster	Makowsky et al., 2010	GQ285512
Nerodia erythrogaster	Makowsky et al., 2010	GQ285451

Taxon	Citation	Accession #
Nerodia erythrogaster	Makowsky et al., 2010	GQ285481
Nerodia erythrogaster	Makowsky et al., 2010	GQ285597
Nerodia erythrogaster	Makowsky et al., 2010	GQ285500
Nerodia erythrogaster	Makowsky et al., 2010	GQ285494
Nerodia erythrogaster	Makowsky et al., 2010	GQ285596
Nerodia erythrogaster	Makowsky et al., 2010	GQ285562
Nerodia erythrogaster	Makowsky et al., 2010	GQ285561
Nerodia erythrogaster	Makowsky et al., 2010	GQ285529
Nerodia erythrogaster	Makowsky et al., 2010	GQ285495
Nerodia erythrogaster	Makowsky et al., 2010	GQ285525
Nerodia erythrogaster	Makowsky et al., 2010	GQ285533
Nerodia erythrogaster	Makowsky et al., 2010	GQ285492
Nerodia erythrogaster	Makowsky et al., 2010	GQ285496
Nerodia erythrogaster	Makowsky et al., 2010	GQ285523
Nerodia erythrogaster	Makowsky et al., 2010	GQ285535
Nerodia erythrogaster	Makowsky et al., 2010	GQ285526
Nerodia erythrogaster	Makowsky et al., 2010	GQ285489
Nerodia erythrogaster	Makowsky et al., 2010	GQ285593
Nerodia erythrogaster	Makowsky et al., 2010	GQ285573
Nerodia erythrogaster	Makowsky et al., 2010	GQ285598
Nerodia erythrogaster	Makowsky et al., 2010	GQ285554
Nerodia erythrogaster	Makowsky et al., 2010	GQ285538
Nerodia erythrogaster	Makowsky et al., 2010	GQ285484
Nerodia erythrogaster	Makowsky et al., 2010	GQ285482
Nerodia erythrogaster	Makowsky et al., 2010	GQ285470
Nerodia erythrogaster	Makowsky et al., 2010	GQ285595
Nerodia erythrogaster	Makowsky et al., 2010	GQ285452
Nerodia erythrogaster	Makowsky et al., 2010	GQ285483
Nerodia erythrogaster	Makowsky et al., 2010	GQ285467
Nerodia erythrogaster	Makowsky et al., 2010	GQ285461
Nerodia erythrogaster	Makowsky et al., 2010	GQ285506
Nerodia erythrogaster	Makowsky et al., 2010	GQ285504
Nerodia erythrogaster	Makowsky et al., 2010	GQ285468
Nerodia erythrogaster	Makowsky et al., 2010	GQ285475
Nerodia erythrogaster	Makowsky et al., 2010	GQ285466
Nerodia erythrogaster	Makowsky et al., 2010	GQ285540
Nerodia erythrogaster	Makowsky et al., 2010	GQ285555
Nerodia erythrogaster	Makowsky et al., 2010	GQ285464
Nerodia erythrogaster	Makowsky et al., 2010	GQ285532
Nerodia erythrogaster	Makowsky et al., 2010	GQ285599
Nerodia erythrogaster	Makowsky et al., 2010	GQ285479
Nerodia erythrogaster	Makowsky et al., 2010	GQ285542
Nerodia erythrogaster	Makowsky et al., 2010	GQ285537

Taxon	Citation	Accession #
Nerodia erythrogaster	Makowsky et al., 2010	GQ285469
Nerodia erythrogaster	Makowsky et al., 2010	GQ285478
Nerodia erythrogaster	Makowsky et al., 2010	GQ285499
Nerodia erythrogaster	Makowsky et al., 2010	GQ285550
Nerodia erythrogaster	Makowsky et al., 2010	GQ285476
Nerodia erythrogaster	Makowsky et al., 2010	GQ285514
Nerodia erythrogaster	Makowsky et al., 2010	GQ285543
Nerodia erythrogaster	Makowsky et al., 2010	GQ285465
Nerodia erythrogaster	Makowsky et al., 2010	GQ285564
Nerodia erythrogaster	Makowsky et al., 2010	GQ285522
Nerodia erythrogaster	Makowsky et al., 2010	GQ285594
Nerodia erythrogaster	Makowsky et al., 2010	GQ285541
Nerodia erythrogaster	Makowsky et al., 2010	GQ285558
Nerodia erythrogaster	Makowsky et al., 2010	GQ285571
Nerodia erythrogaster	Makowsky et al., 2010	GQ285560
Nerodia erythrogaster	Makowsky et al., 2010	GQ285572
Nerodia erythrogaster	Makowsky et al., 2010	GQ285527
Nerodia erythrogaster	Makowsky et al., 2010	GQ285453
Nerodia erythrogaster	Makowsky et al., 2010	GQ285473
Nerodia erythrogaster	Makowsky et al., 2010	GQ285557
Thamnophis exsul	de Queiroz et al., 2002	AF420125
Nerodia fasciata	Guicking et al., 2006	AY866529
Nerodia fasciata	Alfaro & Arnold, 2001	AF402910
Nerodia fasciata	Makowsky et al., 2010	GQ285450
Nerodia fasciata	Makowsky et al., 2010	GQ285447
Nerodia fasciata	Makowsky et al., 2010	GQ285448
Nerodia floridana	Alfaro & Arnold, 2001	AF402911
Thamnophis fulvus	de Queiroz et al., 2002	AF420129
Adelophis foxi	de Queiroz et al., 2002	AF420069
Natrix maura	de Queiroz et al., 2002	AF420077
Natrix natrix	Lawson et al., 2005	AF471059
Natrix tessellata	Guicking et al., 2009	AY487680
Natrix maura	Guicking et al., 2006	AY866530
Natrix natrix	Guicking et al., 2006	AY866536
Natrix tessellata	Guicking et al., 2009	EU119168
Thamnophis gigas	de Queiroz et al., 2002	AF420133
Thamnophis godmani	de Queiroz et al., 2002	AF420135
Regina grahami	Alfaro & Arnold, 2001	AF402918
Thamnophis hammondii	de Queiroz et al., 2002	AF420139
Nerodia harteri	Alfaro & Arnold, 2001	AF402935
Thamnophis marcianus	de Queiroz et al., 2002	AF420143
Thamnophis melanogaster	de Queiroz & Lawson, 2008	EF417410
Thamnophis melanogaster	de Queiroz et al., 2002	AF420147

Taxon	Citation	Accession #
Thamnophis mendax	de Queiroz et al., 2002	AF420151
Natrix maura	Alfaro & Arnold, 2001	AF402906
Thamnophis nigronuchalis	de Queiroz et al., 2002	AF420153
Storeria occipitomaculata	Alfaro & Arnold, 2001	AF402921
Thamnophis ordinoides	de Queiroz et al., 2002	AF420157
Thamnophis ordinoides	Alfaro & Arnold, 2001	AF402927
Thamnophis proximus	de Queiroz et al., 2002	AF420161
Thamnophis proximus	Alfaro & Arnold, 2001	AF402928
Thamnophis pulchrilatus	de Queiroz et al., 2002	AF420165
Seminatrix pygaea	Alfaro & Arnold, 2001	AF402920
Thamnophis radix	de Queiroz et al., 2002	AF420169
Thamnophis radix	Alfaro & Arnold, 2001	AF402934
Nerodia rhombifer	Alfaro & Arnold, 2001	AF402915
Nerodia rhombifer	Makowsky et al., 2010	GQ285446
Regina rigida	Lawson et al., 2005	AF471052
Regina rigida	Alfaro & Arnold, 2001	AF402919
Thamnophis rufipunctatus	de Queiroz et al., 2002	AF420173
Thamnophis sauritus	de Queiroz et al., 2002	AF420177
Thamnophis scalaris	de Queiroz et al., 2002	AF420181
Thamnophis scaliger	de Queiroz et al., 2002	AF420185
Thamnophis scaliger	de Queiroz et al., 2002	AF420189
Regina septemvittata	Alfaro & Arnold, 2001	AF402917
Nerodia sipedon	Makowsky et al., 2010	GQ285445
Nerodia sipedon	K. A. Huff, P. A. Ritchey, & A. B. Cahoon unpublished 2011	JF964960
Nerodia sipedon	Alfaro & Arnold, 2001	AF402913
Thamnophis sirtalis infernalis	de Queiroz et al., 2002	AF420193
Thamnophis sirtalis infernalis	Alfaro & Arnold, 2001	AF402929
Thamnophis sirtalis parietalis	Alfaro & Arnold, 2001	AF402930
Thamnophis sumichrasti	de Queiroz et al., 2002	AF420197
Nerodia taxispilota	Alfaro & Arnold, 2001	AF402914
Tropidoclonion lineatum	Alfaro & Arnold, 2001	AF402931
Thamnophis validus validus	de Queiroz & Lawson, 2008	EF417398
Thamnophis validus validus	de Queiroz & Lawson, 2008	EF417392
Thamnophis validus isabella	de Queiroz & Lawson, 2008	EF417405
Thamnophis validus isabella	de Queiroz & Lawson, 2008	EF417404
Thamnophis validus thamnophisoides	de Queiroz & Lawson, 2008	EF417402
Thamnophis validus validus	de Queiroz & Lawson, 2008	EF417393
Thamnophis validus celaeno	de Queiroz & Lawson, 2008	EF417407
Thamnophis validus celaeno	de Queiroz & Lawson, 2008	EF417408
Thamnophis validus thamnophisoides	de Queiroz et al., 2002	AF420201
Thamnophis validus validus	de Queiroz & Lawson, 2008	EF417394
Thamnophis validus validus	de Queiroz & Lawson, 2008	EF417390

Taxon	Citation	Accession #
Thamnophis validus celaeno	de Queiroz & Lawson, 2008	EF417409
Thamnophis validus validus	de Queiroz & Lawson, 2008	EF417391
Thamnophis validus isabella	de Queiroz & Lawson, 2008	EF417403
Thamnophis validus validus	de Queiroz & Lawson, 2008	EF417397
Thamnophis validus validus	de Queiroz & Lawson, 2008	EF417396
Virginia striatula	Alfaro & Arnold, 2001	AF402932
Virginia striatula	Alfaro & Arnold, 2001	AF402933

LIST OF REFERENCES

- Alfaro, M. E., & Arnold, S. J. (2001). Molecular systematics and evolution of *Regina* and the thamnophiine snakes. *Molecular Phylogenetics and Evolution*, 21(3), 408–423.
- Auffenberg, W. (1958). Fossil turtles of the genus *Terrapene* in Florida. *Bulletin of the Florida State Museum: Biological Sciences*, 3(2), 39.
- Avise, J. (1992). Molecular population structure and the biogeographic history of a regional fauna: a case history with lessons for conservation biology. *Oikos*, 63, 62–76.
- Babonis, L., & Evans, D. (2011). Morphological and biochemical evidence for the evolution of salt glands in snakes. *Comparative Biochemistry and Physiology, Part A*, 160(3), 400–411.
- Babonis, L. S., Miller, S. N., & Evans, D. H. (2011). Renal responses to salinity change in snakes with and without salt glands. *The Journal of Experimental Biology*, 214, 2140–56.
- Babonis, L. S., Womack, M. C., & Evans, D. H. (2012). Morphology and putative function of the colon and cloaca of marine and freshwater snakes. *Journal of Morphology*, 273(1), 88–102.
- Baird, S. F., & Girard, C. (1853). *Catalogue of North American Reptiles in the Museum of the Smithsonian Institution: Serpents* (Vol. 1, p. 172). Smithsonian institution.
- Barbour, T., & Noble, G. K. (1915). Notes on the water snake *Natrix compressicauda*. *Proceedings of the Academy of Natural Sciences of Philadelphia*, 67(1), 29–35.
- Blanchard, F. N. (1923). A new North American snake of the genus *Natrix*. *Occasional Papers of the Museum of Zoology*, (140), 1–7.
- Brooks, W. (2008). Atlantic salt marsh snake (*Nerodia clarkii taeniata*) 5-Year Review: Summary and Evaluation.
- Brown, W. M., George, M., & Wilson, A. C. (1979). Rapid evolution of animal mitochondrial DNA. *Proceedings of the National Academy of Sciences*, 76(4), 1967–1971.
- Brown, W. S., & Parker, W. S. (1976). A ventral scale clipping system for permanently marking snakes (Reptilia, Serpentes). *Journal of Herpetology*, 10(3), 247–249.
- Bulgin, N. L., Gibbs, H. L., Vickery, P., & Baker, A. J. (2003). Ancestral polymorphisms in genetic markers obscure detection of evolutionarily distinct populations in the endangered Florida grasshopper sparrow (*Ammodramus savannarum floridanus*). *Molecular Ecology*, 12(4), 831–44.

- Burbrink, F. T., Fontanella, F., Pyron, R. A., Guiher, T. J., & Jimenez, C. (2008). Phylogeography across a continent: The evolutionary and demographic history of the North American racer (Serpentes: Colubridae: *Coluber constrictor*). *Molecular Phylogenetics and Evolution*, 47(1), 274–288.
- Burbrink, F. T., Lawson, R., & Slowinski, J. B. (2000). Mitochondrial DNA phylogeography of the polytypic North American rat snake (*Elaphe obsoleta*): a critique of the subspecies concept. *Evolution*, 54(6), 2107–2118.
- Butler, J. M., Dodd Jr., C. K., Aresco, M., & Austin, J. D. (2011). Morphological and molecular evidence indicates that the Gulf Coast Box Turtle (*Terrapene carolina major*) is not a distinct evolutionary lineage in the Florida Panhandle. *Biological Journal of the Linnean Society*, 102(4), 889–901.
- Campbell-Staton, S. C., Goodman, R. M., Backström, N., Edwards, S. V., Losos, J. B., & Kolbe, J. J. (2012). Out of Florida: mtDNA reveals patterns of migration and Pleistocene range expansion of the Green Anole lizard (*Anolis carolinensis*). *Ecology and Evolution*, 2(9), 2274–2284.
- Carr, A. F. J., & Goin, C. J. (1942). Rehabilitation of *Natrix sipedon taeniata* Cope. *Proceedings of the New England Zoological Club*, 21, 47–54.
- Clay, W. M. (1938). A synopsis of the North American water snakes of the genus *Natrix*. *Copeia*, 1938(4), 173–182.
- Clement, M., Posada, D., & Crandall, K. A. (2000). TCS: a computer program to estimate gene genealogies. *Molecular Ecology*, 9(10), 1657–1659.
- Cliburn, J. W. (1957). Some southern races of the Common Water Snake, *Natrix sipedon*. *Herpetologica*, 13(3), 193–202.
- Conant, R. (1963). Evidence for the specific status of the water snake *Natrix fasciata*. *American Museum Novitates*, 2212, 1–38.
- Conant, Roger, & Collins, J. T. (1998). *A Field Guide to Reptiles and Amphibians: Eastern and Central North America* (Third Edit., pp. 295–299).
- Cope, E. D. (1860a). Notes and descriptions of new and little known species of American reptiles. *Proceedings of the Academy of Natural Sciences of Philadelphia*, 12, 339–345.
- Cope, E. D. (1860b). Descriptions of reptiles from tropical America and Asia. *Proceedings of the Academy of Natural Sciences of Philadelphia*, 12, 368–374.
- Cope, E. D. (1895). On some new North American snakes. *The American Naturalist*, 29(343), 674–681.
- Cope, E. D. (1900). *The crocodylians, lizards and snakes of North America. The Report of the U. S. National Museum for 1898*. Government Printing Office.

- Culver, M., J., W. E., Pecon-Slattey, J., & O'Brien, S. J. (2000). Genomic ancestry of the American puma (*Puma concolor*). *The Journal of Heredity*, *91*(3), 186–97.
- De Queiroz, A., Lawson, R., & Lemos-Espinal, J. A. (2002). Phylogenetic relationships of North American garter snakes (*Thamnophis*) based on four mitochondrial genes: how much DNA sequence is enough? *Molecular Phylogenetics and Evolution*, *22*(2), 315–29.
- De Queiroz, K. (2007). Species concepts and species delimitation. *Systematic Biology*, *56*(6), 879.
- De Queiroz, K., & Lawson, R. (2008). A peninsula as an island: multiple forms of evidence for overwater colonization of Baja California by the gartersnake *Thamnophis validus*. *Biological Journal of the Linnean Society*, *95*(2), 409–424.
- Douglas, M. E., Douglas, M. R., Schuett, G. W., & Porras, L. W. (2009). Climate change and evolution of the New World pitviper genus *Agkistrodon* (Viperidae). *Journal of Biogeography*, *36*(6), 1164–1180.
- Drummond, A. J., Suchard, M. A., Xie, D., & Rambaut, A. (2012). Bayesian phylogenetics with BEAUti and the BEAST 1.7. *Molecular Biology and Evolution*, *29*(8), 1969–73.
- Dunson, W. A. (1978). Role of the skin in sodium and water exchange of aquatic snakes placed in seawater. *American Journal of Physiology - Regulatory, Integrative and Comparative Physiology*, *235*(3), R151–R159.
- Dunson, W. A. (1979). Occurrence of partially striped forms of the mangrove snake *Nerodia fasciata compressicauda* Kennicott and comments on the status of *N. f. taeniata* Cope. *Florida Scientist*, *42*, 102–112.
- Dunson, W. A. (1980). The relation of sodium and water-balance to survival in sea-water of estuarine and fresh-water races of the snakes *Nerodia fasciata*, *Nerodia sipedon* and *Nerodia valida*. *Copeia*, (2), 268–280.
- Fenwick, A. M., Gutberlet Jr, R. L., Evans, J. A., & Parkinson, C. L. (2009). Morphological and molecular evidence for phylogeny and classification of South American pitvipers, genera *Bothrops*, *Bothriopsis*, and *Bothrocophias* (Serpentes: Viperidae). *Zoological Journal of the Linnean Society*, *156*(3), 617–640.
- Gibbons, J. W., & Dorcas, M. E. (2004). *North American Watersnakes: A Natural History* (p. 438). University of Oklahoma Press.
- Goode, G., Scott, S., & Kochman, H. (1992). Utilization of open marsh water management ditches by the threatened Atlantic Salt Marsh Snake (*Nerodia clarkii taeniata*). Unpublished report to the East Volusia Mosquito Control District.
- Groth, J., & Barrowclough, G. (1999). Basal divergences in birds and the phylogenetic utility of the nuclear RAG-1 gene. *Molecular Phylogenetics and Evolution*, *12*(2), 115–123.

- Guicking, D., Lawson, R., Joger, U., & Wink, M. (2006). Evolution and phylogeny of the genus *Natrix* (Serpentes: Colubridae). *Biological Journal of the Linnean Society*, 87(1), 127-144.
- Guiher, T. J., & Burbrink, F. T. (2008). Demographic and phylogeographic histories of two venomous North American snakes of the genus *Agkistrodon*. *Molecular Phylogenetics and Evolution*, 48(2), 543–553.
- Guo, P., Liu, Q., Xu, Y., Jiang, K., Hou, M., Ding, L., Pyron, R. A., & Burbrink, F. T. (2012). Out of Asia: Natricine snakes support the Cenozoic Beringian Dispersal Hypothesis. *Molecular phylogenetics and evolution*, 63(2012), 825-833.
- Hebrard, J., & Lee, R. (1981). A large collection of brackish water snakes from the central Atlantic coast of Florida. *Copeia*, 1981(4), 886–889.
- Heethoff, M., Laumann, M., Weigmann, G., & Raspotnig, G. (2011). Integrative taxonomy: Combining morphological, molecular and chemical data for species delineation in the parthenogenetic *Trhypochthonius tectorum* complex (Acari, Oribatida, Trhypochthoniidae). *Frontiers in Zoology*, 8(2), 1–10.
- Hether, T. D. (2010). *Using landscape genetics to assess population connectivity in a habitat generalist*. Unpublished Master's Thesis, University of Central Florida, Orlando.
- Hewitt, G. (1996). Some genetic consequences of ice ages, and their role in divergence and speciation. *Biological Journal of the Linnean Society*, 58, 247–276.
- Huelsenbeck, J. P., & Ronquist, F. (2001). MRBAYES: Bayesian inference of phylogenetic trees. *Bioinformatics*, 17(8), 754–755.
- Jansen, K P, Mushinsky, H. R., & Karl, S. A. (2008). Population genetics of the Mangrove Salt Marsh Snake, *Nerodia clarkii compressicauda*, in a linear, fragmented habitat. *Conservation Genetics*, 9(2), 401–410.
- Jansen, Kevin P. (2001). *Ecological genetics of the Salt Marsh Snake Nerodia clarkii*. Unpublished P.h.D. Dissertation, University of South Florida, Tampa.
- Kennicott, R. (1860). Descriptions of new species of North American serpents in the Museum of the Smithsonian Institution, Washington. *Proceedings of the Academy of Natural Sciences of Philadelphia*, 12, 328–338.
- Kochman, H. I. (1977). *Differentiation and hybridization in the Natrix fasciata complex (Reptilia: Serpentes): A nonmorphological approach*. Unpublished Master's Thesis, University of Florida, Gainesville.
- Ladner, J. T., & Palumbi, S. R. (2012). Extensive sympatry, cryptic diversity and introgression throughout the geographic distribution of two coral species complexes. *Molecular Ecology*, 21(9), 2224–38.

- Lawson, R. (1987). Molecular studies of thamnophiine snakes: 1. The phylogeny of the genus *Nerodia*. *Journal of Herpetology*, 21(2), 140–157.
- Lawson, R., Meier, A. J., Frank, P. G., & Moler, P. E. (1991). Allozyme variation and systematics of the *Nerodia fasciata*-*Nerodia clarkii* complex of water snakes (Serpentes, Colubridae). *Copeia*, (3), 638–659.
- Lawson, R., Slowinski, J. B., Crother, B. I., & Burbrink, F. T. (2005). Phylogeny of the Colubroidea (Serpentes): new evidence from mitochondrial and nuclear genes. *Molecular Phylogenetics and Evolution*, 37(2), 581–601.
- Lee, D. N., Pfau, R. S., & Ammerman, L. K. (2010). Taxonomic status of the Davis Mountains Cottontail, *Sylvilagus robustus*, revealed by amplified fragment length polymorphism. *Journal of Mammalogy*, 91(6), 1473–1483.
- Makowsky, R., Marshall, J. C., McVay, J., Chippindale, P. T., & Rissler, L. J. (2010). Phylogeographic analysis and environmental niche modeling of the plain-bellied watersnake (*Nerodia erythrogaster*) reveals low levels of genetic and ecological differentiation. *Molecular Phylogenetics and Evolution*, 55(3), 985–995.
- Malnate, E. (1960). Systematic division and evolution of the colubrid snake genus *Natrix*, with comments on the subfamily Natricinae. *Proceedings of the Academy of Natural Sciences of Philadelphia*, 112, 41–71.
- Matthee, C., Burzlaff, J., Taylor, J., & Davis, S. K., (2001). Mining the mammalian genome for artiodactyl systematics. *Systematic Biology*, 50(3), 367–390.
- Mebert, K. (2008). Good species despite massive hybridization: genetic research on the contact zone between the watersnakes *Nerodia sipedon* and *N. fasciata* in the Carolinas, USA. *Molecular Ecology*, 17(8), 1918–1929.
- Metzger, G. A., Kraus, F., Allison, A., & Parkinson, C. L. (2010). Uncovering cryptic diversity in *Aspidomorphus* (Serpentes: Elapidae): evidence from mitochondrial and nuclear markers. *Molecular phylogenetics and evolution*, 54(2), 405–16.
- Milstead, W. W. (1969). Studies on the evolution of box turtles (genus *Terrapene*). *Bulletin of the Florida State Museum: Biological Sciences*, 14(1), 113.
- Neill, W. T. (1958). The occurrence of amphibians and reptiles in saltwater areas, and a bibliography. *Bulletin of Marine Science of the Gulf and Caribbean*, 8(1), 1–97.
- Nicholas, K., Nicholas, H., & Deerfield, D. (1997). GeneDoc: analysis and visualization of genetic variation. *EMBnet.news*, 1–3.
- Nylander, J. A. A. (2004). MrModeltest v2. Evolutionary Biology Centre, Uppsala University.

- Osgood, D. (1978). Effects of temperature on the development of meristic characters in *Natrix fasciata*. *Copeia*, 1978(1), 33–47.
- Pauly, G. B., Piskurek, O., & Shaffer, H. B. (2007). Phylogeographic concordance in the southeastern United States: the flatwoods salamander, *Ambystoma cingulatum*, as a test case. *Molecular Ecology*, 16(2), 415–29.
- Pettus, D. (1958). Water relationships in *Natrix sipedon*. *Copeia*, 207–211.
- Pettus, D. (1963). Salinity and subspeciation in *Natrix sipedon*. *Copeia*, 1963(3), 499–504.
- Pyron, R. A., Burbrink, F. T., Colli, G. R., De Oca, A. N. M., Vitt, L. J., Kuczynski, C. A., & Wiens, J. J. (2011). The phylogeny of advanced snakes (Colubroidea), with discovery of a new subfamily and comparison of support methods for likelihood trees. *Molecular Phylogenetics and Evolution*, 58(2), 329–42.
- Rambaut, A., & Drummond, A. J. (2007). Tracer v1.4. Available at <http://beast.bio.ed.ac.uk/Tracer>.
- Ronquist, F., & Huelsenbeck, J. P. (2003). MrBayes 3: Bayesian phylogenetic inference under mixed models. *Bioinformatics*, 19(12), 1572–1574.
- Rossman, D., & Eberle, W. (1977). Partition of the genus *Natrix*, with preliminary observations on evolutionary trends in natricine snakes. *Herpetologica*, 33(1), 34–43.
- Schmidt-Nielsen, K., & Fange, R. (1958). Salt glands in marine reptiles. *Nature*, 182(4638), 783–785.
- Soltis, D. E., Morris, A. B., McLachlan, J. S., Manos, P. S., & Soltis, P. S. (2006). Comparative phylogeography of unglaciated eastern North America. *Molecular Ecology*, 15(14), 4261–93.
- Strickland, J. L. (2011). *Phylogeography of the Cottonmouth, Agkistrodon piscivorus, using AFLP and venom protein profiles*. Unpublished Master's Thesis, Angelo State University, San Angelo, Texas.
- Swenson, N. G., & Howard, D. J. (2005). Clustering of contact zones, hybrid zones, and phylogeographic breaks in North America. *The American Naturalist*, 166(5), 581–91.
- Townsend, T. M., Mulcahy, D. G., Noonan, B. P., Sites, J. W., Kuczynski, C. A., Wiens, J. J., & Reeder, T. W. (2011). Phylogeny of iguanian lizards inferred from 29 nuclear loci, and a comparison of concatenated and species-tree approaches for an ancient, rapid radiation. *Molecular Phylogenetics and Evolution*, 61(2), 363–380.
- Tursi, R. M., Hughes, P. T., & Hoffman, E. A. (2012). Taxonomy versus phylogeny: evolutionary history of marsh rabbits without hopping to conclusions. *Diversity and Distributions*, 19(2), 120–133.

- U. S. Fish and Wildlife Service. (1977). Listing of the Atlantic Salt Marsh Snake as a threatened species. Federal Register 42:60743-60745.
- U. S. Fish and Wildlife Service. (1993). Atlantic Salt Marsh Snake Recovery Plan. Atlanta, Georgia. 19 pages.
- Wiens, J., Bonett, R., & Chippindale, P. (2005). Ontogeny discombobulates phylogeny: paedomorphosis and higher-level salamander relationships. *Systematic Biology*, 54(1), 91–110.
- Zaher, H. (1999). Hemipenial morphology of the South American xenodontine snakes: with a proposal for a monophyletic Xenodontinae and a reappraisal of colubroid hemipenes. *Bulletin of the American Museum of Natural History*, (240), 1-168.