

STARS

University of Central Florida
STARS

Electronic Theses and Dissertations, 2004-2019

2014

Placement of Mode and Wavelength Converters for Throughput Enhancement in Optical Networks

Ruaa Abdulrahman
University of Central Florida

 Part of the [Computer Sciences Commons](#), and the [Engineering Commons](#)

Find similar works at: <https://stars.library.ucf.edu/etd>

University of Central Florida Libraries <http://library.ucf.edu>

This Masters Thesis (Open Access) is brought to you for free and open access by STARS. It has been accepted for inclusion in Electronic Theses and Dissertations, 2004-2019 by an authorized administrator of STARS. For more information, please contact STARS@ucf.edu.

STARS Citation

Abdulrahman, Ruaa, "Placement of Mode and Wavelength Converters for Throughput Enhancement in Optical Networks" (2014). *Electronic Theses and Dissertations, 2004-2019*. 4707.

<https://stars.library.ucf.edu/etd/4707>



PLACEMENT OF MODE AND WAVELENGTH CONVERTERS FOR THROUGHPUT
ENHANCMENT IN OPTICAL NETWORKS

by

RUAA RYIADH ABDULRAHMAN
B.S. University of Baghdad, 2007

A thesis submitted in partial fulfillment of the requirements
for the degree of Master of Science
in the Department of Electrical Engineering and Computer Science
in the College of Engineering and Computer Science
at the University of Central Florida
Orlando, Florida

Spring Term
2014

Major Professor: Mostafa Bassiouni

© 2014 RUAA RYIADH ABDULRAHMAN

ABSTRACT

The success of recent experiments to transport data using combined wavelength division multiplexed (WDM) and mode-division multiplexed (MDM) transmission has generated optimism for the attainment of optical networks with unprecedented bandwidth capacity, exceeding the fundamental Shannon capacity limit attained by WDM alone. Optical mode converters and wavelength converters are devices that can be placed in future optical nodes (routers) to prevent or reduce the connection blocking rate and consequently increase network throughput. In this thesis, the specific problem of the placement of mode converters (MC) and mode-wavelength converters (MWC) in combined mode and wavelength division multiplexing (MWDM) networks is investigated. Four previously proposed wavelength converter placement heuristics are extended to handle the placement of MC and MWC in MWDM networks. A simple but effective method for the placement of mode and wavelength converters in MWDM networks is proposed based on ranking the nodes with respect to the volume of received connection requests. The results of extensive simulation tests to evaluate the new method and compare its performance with the performance of the other four heuristics are presented. The thesis provides extensive comparison results among the five converter placement methods using different network topologies and under different network loads. The results demonstrate the effectiveness of the new proposed method in achieving lower blocking rates compared to the other more-complex converter placement heuristics.

*To my dear father who passed away but his guiding hand on my shoulder will
remain with me forever.*

To my two angels, Anas and Mary. You keep inspiring me !

ACKNOWLEDGMENTS

I would like to greatly thank my advisor, Professor Mostafa Bassiouni, for his guidance, support, patience, and teaching throughout my education. I deeply appreciate all that he has done for me from the initial developing stages of this thesis. I also would like to thank my committee members Dr. Mainak Chatterjee and Dr. Cliff C. Zou for their valued comments, suggestions, and support.

My deepest gratitude goes to the Higher Committee for Education Development in Iraq (HCED) for providing me with the scholarship and all the needed support to pursue my graduate degree and make this work a reality.

I would like to also acknowledge the help I received from Mrs. Sana Tariq whose contribution in this work is very valuable.

To my family, I could not make it without your support. To my husband, Bilal Salih, your endless support and love will never be forgotten. To my friends, thank you all for your encouragement and great support.

TABLE OF CONTENTS

LIST OF FIGURES	ix
LIST OF TABLES	xi
LIST OF ACRONYMS	xii
CHAPTER 1 INTRODUCTION	1
1.1 Wavelength Division Multiplexing.....	2
1.2 Mode Division Multiplexing.....	6
1.3 Converter Placement Problem	8
1.4 Contributions.....	9
1.5 Thesis Organization	10
CHAPTER 2 OPTICAL CONVERTERS PLACEMENT HEURISTICS	11
2.1 Existing Heuristics for Converter Placement.....	12
2.1.1 Random Placement Heuristic.....	14
2.1.2 High Blocking Placement Heuristic (HBP)	14
2.1.3 K-DS Placement Heuristic	17
2.1.4 HYBRID Placement Heuristic (HYB).....	20

2.2	New Heuristic for Converter Placement	22
2.2.1	HRN Algorithm	24
CHAPTER 3 NETWORK MODEL AND SIMULATION SCHEMES		25
3.1	Optical Network Simulation	25
3.1.1	Blocking Percentage Calculation	29
3.2	Heuristics Implementation Examples	31
3.2.1	HBP Implementation Example	31
3.2.2	K-DS Implementation Example.....	33
3.2.3	HYB Implementation Example.....	35
3.2.4	HRN Implementation Example.....	36
3.3	Converter Position Impact	37
CHAPTER 4 PERFORMANCE COMPARISON AND SIMULATION RESULTS		39
4.1	Simulation Results and Discussion, <i>US Long Haul Network</i>	39
4.1.1	Wavelength Converter Performance.....	40
4.1.2	Mode Converter Performance.....	44
4.1.3	Mode-Wavelength Converter Performance	47
4.2	Simulation Results and Discussion, <i>Toronto Metropolitan Network</i>	53
4.3	Simulation Results and Discussion, <i>5 x 5 Mesh- Tours</i>	56

CHAPTER 5	CONCLUSION.....	58
LIST OF REFERENCES		61

LIST OF FIGURES

Figure 1.1 : Continuity Constraint Problem.....	4
Figure 1.2 : Limited and Complete Conversion Capability.....	5
Figure 1.3 : Schematic of MWDM Network	7
Figure 2.1 : Examples of Different Values of K with Different Topologies	18
Figure 3.1 : Three Different Network Topologies	26
Figure 3.2 : Blocking Performance.....	30
Figure 3.3 : HBP Descending Order of Blocking Probability	32
Figure 3.4: Converter Placement in US Long Haul using HBP	32
Figure 3.5 : HRN Descending Order of Number of Requests	36
Figure 3.6 : Converter Placement in US Long Haul using HRN.....	37
Figure 3.7 : Converter Position Comparison	38
Figure 4.1 : RDP, HBP, KDS, HRN Comparison using Different Numbers of WC.....	40
Figure 4.2 : RDP, HBP, HYB, HRN Comparison using Different Numbers of WC	41
Figure 4.3 : Blocking Percentage of HRN versus Number of WC, Various λ and W.....	43
Figure 4.4 : RDP, HBP, KDS, HRN Comparison using Different Numbers of MC.....	44
Figure 4.5 : RDP, HBP, HYB, HRN Comparison using Different Numbers of MC	45
Figure 4.6 : Blocking Percentage of HRN versus Number of MC, Various λ , and M.....	47
Figure 4.7 : RDP, HBP, K-DS, HRN Comparison using Different Numbers of MWC.....	48
Figure 4.8 : RDP, HBP, HYB, HRN Comparison using Different Numbers of MWC.....	48
Figure 4.9 : Blocking Percentage of HRN versus Number of MWC, Various λ , and M,W.....	50

Figure 4.10 : Blocking Percentage of HRN versus Loads, MC = WC = MWC = 5.....	51
Figure 4.11 : Blocking Percentage of HRN versus Loads, MC = WC = MWC = 13.....	52
Figure 4.12 : Blocking Percentage of HRN versus Loads, MC = WC = MWC = 20.....	52
Figure 4.13 : Toronto Metropolitan, Placement of WC using RDP, HBP, HYB, and HRN	53
Figure 4.14 : Toronto Metropolitan, Placement of MC using RDP, HBP, HYB, and HRN	54
Figure 4.15 : Toronto Metropolitan, Placement of MWC using RDP, HBP, HYB, and HRN	54
Figure 4.16 : 5 x 5 Mesh- Tours, Placement of WC using RDP, HBP, HYB, and HRN	56
Figure 4.17 : 5 x 5 Mesh- Tours, Placement of MC using RDP, HBP, HYB, and HRN	57
Figure 4.18 : 5 x 5 Mesh- Tours, Placement of MWC using RDP, HBP, HYB, and HRN.....	57

LIST OF TABLES

Table 3.1 : K-DS Results for US Long Haul Network	33
Table 3.2 : K-DS Results for Toronto Metropolitan Network.....	34
Table 3.3 : K-DS Results for 5 x 5 Mesh- Tours Network.....	34
Table 3.4 : HYB Results for US Long Haul Network with various values of X.....	35

LIST OF ACRONYMS

ARMBP	Alternate Routing Minimum Blocking Probability
ARSPFFF	Alternate Routing with Shortest Path First-First Fit
CP	Control Packet
DLE	Dynamic lightpath establishment
DS	Dominating Set
FAR	Fixed Alternate Routing
FF	First-Fit wavelength-assignment heuristic
HBP	High Blocking Placement Heuristic
HRN	Highest Request Node Placement Heuristic
HYB	HYBRID Placement Heuristic
JET	Just Enough Time protocol
JIT	Just In Time protocol
K-DS	K-DS Placement Heuristic
LLR	Least Loaded Routing
M	Mode

MBPF	Minimum Blocking Probability First
MC	Mode Converter
MDM	Mode Division Multiplexing
MWC	Mode Wavelength Converter
OBS	Optical Burst Switching
OCS	Optical Circuit Switching
ONS	Optical Network Simulator
OPS	Optical Packet Switching
RDP	Random Placement Heuristic
RWA	Routing and Wavelength Assignment
SLE	Static Lightpath establishment
SPF	Shortest Path First algorithm
W	Wavelength
WC	Wavelength Converter
WDM	Wavelength Division Multiplexing
WMSL	Weighted Maximum Segment Length

CHAPTER 1 INTRODUCTION

Optical networks, which use optical fibers as a transmission media and employ optical signals to carry information over these fibers at the speed of light, have been playing a significant and important role in the world of telecommunication networks. Optical networks have been studied extensively with great interest, and have already become the leading networks that occupy a paramount position in the backbone of the Internet because of their capability to increase the available bandwidth many folds [1, 2] . Optical transmissions provide a high bandwidth data rate with minimum loss and a low bit error rate. The bandwidth capacity of optical networks can easily reach data rates of tens of terabits per second (Tbps) and beyond [3]. This immense capacity can satisfy the rapidly increasing bandwidth demand, and the requirements of future applications. Examples of such applications are live audio/video streaming and teleconferencing applications, heavy graphical user interfaces, online gaming, document distribution and telemedicine, defense applications, and many more application to come [4].

In order to efficiently use the enormous bandwidth capacity provided by optical fibers, to serve more communication needs and satisfy the exponential growth in bandwidth demands, several approaches and routing protocols have been proposed and developed. The wavelength division multiplexing (WDM) technology in optical networks has received the most considerable attention to be developed and utilized [5].

1.1 Wavelength Division Multiplexing

Wavelength division multiplexing (WDM) in optical networks has been rapidly gaining acceptance as an efficient technique that can manage the ever increasing transmission capacity demands of network users [6]. It has the potential to be the dominant technology choice for near future Tera-bit communication infrastructure [7], WDM can provide unprecedented bandwidth, reduce processing cost, and enable efficient failure handling [8].

WDM technology divides the bandwidth of each single optical fiber to several non-overlapping data channels. Each data channel is regulated independently onto a carrier with a unique optical frequency (wavelength). These multiple wavelength channels can be allocated and multiplexed in one individual optical fiber. They can be operated simultaneously using different rates and data transmission, including some analog and some digital, within certain limits. WDM allows tens or hundreds of wavelength channels to transmit over a single optical fiber. Meanwhile, each one of these channels can transmit data at rate of 10 Gb/s and beyond. Thus, WDM can significantly improve the total data rate in each individual optical fiber to reach 10 Tb/s.

In WDM optical networks, data can be routed from their source to their destination based on their wavelengths. This technique is referred to as wavelength routing, and a network that utilizes this type of routing is known as a wavelength routed network [6]. The wavelength routed all-optical network refers to the network that has all its interfaces (user-network and network-network) based on optical transmission. A wavelength routed network comprises of wavelength

routing nodes (switches) which are interconnected by optical fiber links and can communicate with each other using all optical WDM channels. The protocol that controls communications and data routing between two wavelength routed nodes (source and destination) is called routing and wavelength assignment (RWA). In order to establish an optical connection, the RWA protocol selects a suitable path of physical links between the source and destination nodes (routing), and finds an available wavelength to be allocated specifically for that connection (wavelength assignment). This high speed, fixed-bandwidth, and end-to-end connection path is known as a lightpath [9]. A lightpath is necessary to create a connection between any two WDM optical nodes, and has to be established prior to the transmission of data between the two nodes. This established lightpath can connect two optical nodes and requires the same wavelength channel to be allocated on all the fiber links traversed by the connection along the route from the source to the destination. In addition, the assigned wavelength of a lightpath should be distinct compared with the wavelengths of other lightpaths sharing the same fiber link. These restrictions are known in the literature as the wavelength continuity constraint, and are considered the reasons that cause the connection request to be blocked when the RWA protocol is unable to find a path that has the same available wavelength from the source to destination in every fiber link. This constraint is illustrated in Figure 1.1. To transmit a data from node 1 to node 8, a lightpath with assigned wavelength W_1 is established at the source node 1; therefore, to have unblocked connection between this pair (1, 8), the established lightpath must use W_1 along all the intermediate nodes 3, 6, and 7 until it reaches the destination node 8. This constraint is also applied for all the other source-destination pairs 2 to 4 - using W_2 , and 2 to 8 - using W_3 .

On the other hand, when a lightpath is established at node 5 to send data to node 6 using wavelength W_1 , the connection is blocked at node 3 due to unavailability of W_1 in the link from node 3 to node 6.

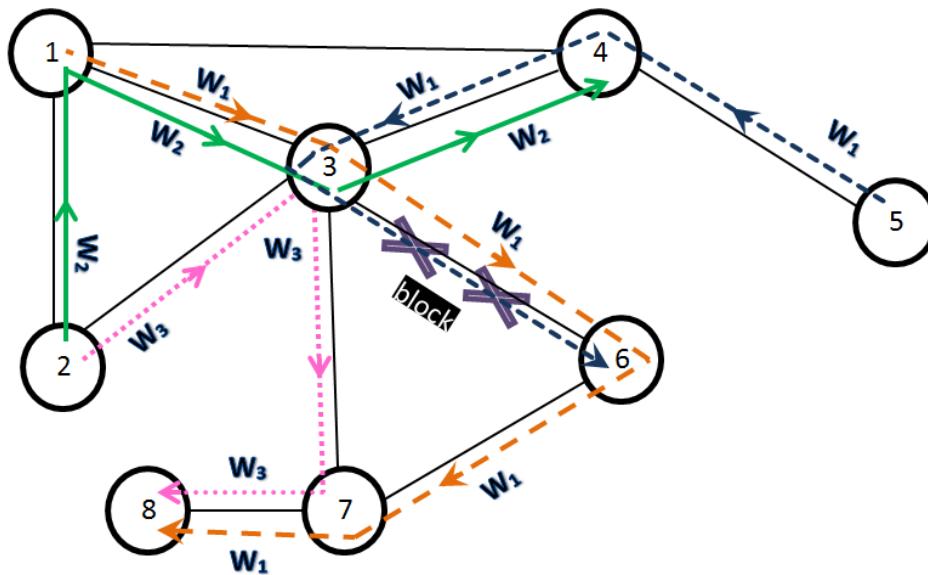

Figure 1.1 : Continuity Constraint Problem

In order to reduce the effect of this constraint, and hence decrease the number of blocked requests, a high enough number of wavelength channels should be provided to support all the communication needs. However, an important goal of the design of WDM networks is to use fewer and an optimal number of wavelengths that are needed to serve more communications [10]. Fortunately, a device called a converter can be utilized and allocated on an optical wavelength node to overcome this discrepancy and translate optical signals from one to another

[11, 12]. The lightpath will try to continue using the same wavelength until it reaches its destination and if the same wavelength is unavailable at the input port the Wavelength Converter (WC) will convert this incoming wavelength to a different one as it departs from the output port [4, 13]. Wavelength converters can be classified according to their conversion capability as follows: a converter with complete conversion capability (CWC), which can convert an input wavelength to any output wavelength without any limitation, and a converter with limited conversion capability (LWC), which can convert an input wavelength to only some specific output wavelength [3, 4]. Figure 1.2 shows both types of converters. In this thesis, we will only consider converters with complete conversion capability. Adding the conversion ability to WDM networks will relax the continuity constraint, reduce network blocking performance and increase the reuse of wavelength channels [12, 14].

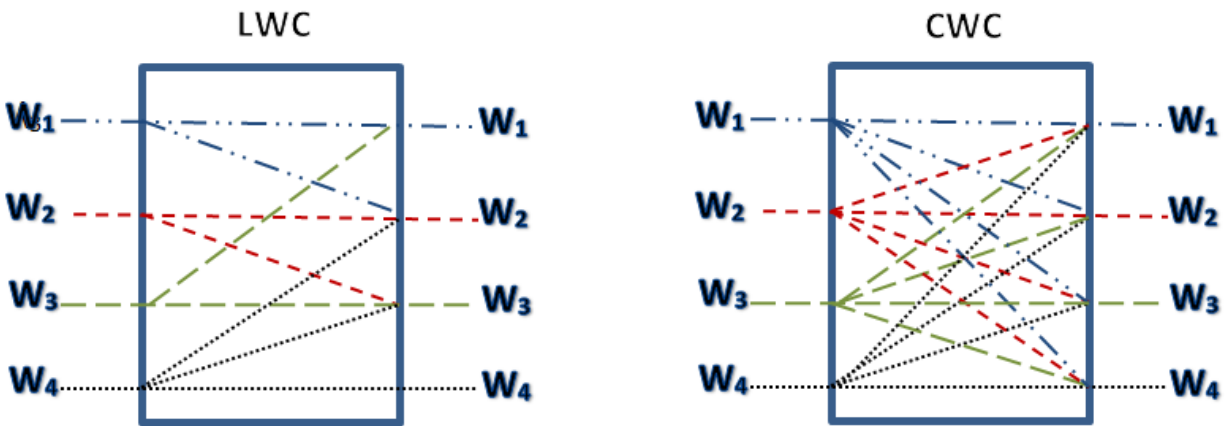

Figure 1.2 : Limited and Complete Conversion Capability

1.2 Mode Division Multiplexing

Nowadays there is an increasing realization that WDM networks with a single fiber are rapidly approaching the limit for transmission capacity [15]. New applications with higher bandwidth demand have increased the interest in finding additional ways to increase the bandwidth capacity of WDM single fiber networks [16]. Mode Division Multiplexing (MDM) has received particular attention as one of the best alternative technology to increase the capacity of optical fiber networks, and utilize the high potential number of modes that can be used in one fiber [16-19]. Although the MDM technology was first believed to be feasible only over short fiber length, recently, a wide number of experiments implementing this technology have clearly showed that MDM will be a feasible future technology that provides the ability to transmit data over long distances using a large number of modes [16, 17, 20]. When MDM is incorporated with WDM, several individual signals will be allowed to transmit using propagation modes at certain wavelengths, and greatly increase the number of signals per optical fiber [19]. The availability of multiple modes over the same fiber can greatly improve parallel transmissions over the optical fiber by adding an additional degree of freedom that multiplicatively increases the available number of wavelength transmission channels. Ultimately, this will enhance the performance and capacity of optical networks, and reduce their blocking percentage [16, 21].

There is strong evidence that the combination of WDM and MDM will be used in future optical networks in such a way that the routing protocol that controls the communications in these networks will assign a specific wavelength that has a certain mode to be used along the path

from the source to destination. Figure 1.3 shows a schematic of a network that utilizes both MDM and WDM. In this network, the lightpath 8 - 5 and the lightpath 3 - 5 are assigned the same wavelength W_1 ; however, they are not blocked even when they traverse the same fiber channel along the link from node 1 to node 4 because they utilize different modes, M_1 and M_2 respectively. If the use of a specific wavelength that has a certain mode along the entire path is not possible, the protocol will first attempt to change the assigned wavelength's mode using the mode converter MC and if needed it will change the wavelength itself using the wavelength converter WC.

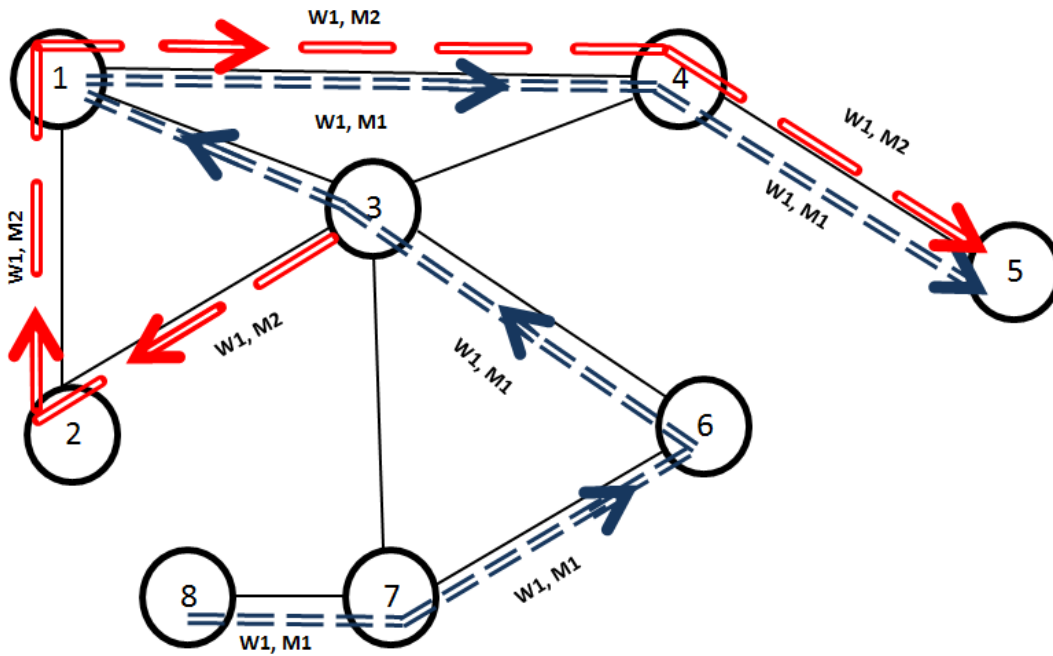

Figure 1.3 : Schematic of MWDM Network

1.3 Converter Placement Problem

As illustrated above, the continuity constraint problem in optical networks causes transmission requests to be blocked, even when there is a physical link available from the source to destination. This happens especially with long path connections and can be relaxed through the use of converters. Adding mode converters (MC), wavelength converters (WC), or combined mode-wavelength converters (MWC) to optical networks minimizes the blocking probabilities, supports higher loads, and enhances the network throughput. In addition, the best improvement can be achieved when all the nodes in the network have conversion capability (full conversion deployment). However, the introduction of converters increases the cost and complexity of optical networks because converter devices are very expensive and they cause a processing delay. Therefore, to save the hardware cost and conversion delay, converters must be placed judiciously on the nodes that maximize performance improvement [22]. This issue has been an active research topic in the past few years for WDM networks and is known in literatures as the sparse deployment of wavelength conversion. Using sparse conversion means that only a fraction of the nodes (routers) in the network is occupied with converters, and the other nodes have no conversion capability [1, 23]. It is important to obtain the most benefits of converters without placing them in all the nodes (full conversion deployment) by finding effective solutions to the converter placement problem.

1.4 Contributions

Although the MDM technology is still in the research phase and has not been commercially developed, there is strong evidence that combined mode and wavelength division multiplexing will be the future technology for data transmission over optical networks. This thesis is the first research work that investigates the specific problem of the placement of mode converters (MC) and mode-wavelength converters (MWC) in combined mode and wavelength division multiplexing networks. In this research, we extend the logic of previously proposed wavelength converter placement heuristics to place MC and MWC as well as WC on combined MDM and WDM, referred to in this thesis as (MWDM) networks. In addition, we propose a simple but effective method to place WC, MC, and MWC in MWDM networks based on ranking the nodes with respect to the volume of received connection requests. The thesis provides extensive comparison results among the converter placement methods.

1.5 Thesis Organization

We organize the remainder of this thesis as follows: in Chapter 2, we present a literature review about the heuristics that have been proposed as a solution for the WDM converter placement problem, and introduce the detailed approaches of four well-known algorithms that are utilized in this thesis. Chapter 2 is concluded by introducing our new approach for the placement of MC, WC, and MWC on optical network. Chapter 3 describes the network model used in the thesis, and gives details of the simulation model and the network topologies used to evaluate the different heuristics for the converter placement problem. In addition, an example of each one of the applied converter placement heuristics is presented to show the mechanism of choosing the optimal nodes to be occupied with converters. In Chapter 4, we evaluate our new approach and compare its performance with the performance of the other four simulated heuristics. Chapter 5 concludes the thesis and describes our future ideas to extend this work.

CHAPTER 2 OPTICAL CONVERTERS PLACEMENT HEURISTICS

The concept of the sparse deployment of wavelength converters was first introduced in the study by [23]. The authors define a factor, called conversion density, to represent the fraction of nodes with complete conversion capability. The results of their analytic model for evaluating the blocking probability show that the partial placement of wavelength converter, allocated uniformly, can effectively reduce the cost and achieve most of the benefits of full wavelength conversion. Additionally, the study by [24] indicates that enhancing the performance of wavelength-routing network depends on both the locations of wavelength converters and the number of wavelength conversion operations. Another investigation is done by the study in [25], in which a heuristic algorithm for dynamic routing with node architecture to reduce the number of wavelength conversion operations is proposed. In recent years, there have been some efforts in investigating the wavelength converter placement problem to determine the locations of converters that minimize the blocking performance. The work of some studies is focused on the placement of the converters with limited conversion capability, while the research of other studies investigated the complete conversion capability case. Some of the studies that deal with the limited conversion capability can be found in [26-31]. The research of this thesis investigates the placement of converters with complete conversion capability. In this chapter, we present the detailed analyses of four exciting wavelength converter placement methods and extend their approaches on combined MDM and WDM (MWDM) networks. Later in this chapter, we introduce a new heuristic for the converter placement problem.

2.1 Existing Heuristics for Converter Placement

In the last few years, many heuristic algorithms for placing a given number of converters with complete conversion capability are proposed to minimize the blocking probability and enhance the overall throughput of the network. A heuristic-based algorithm for converter placement, called Alternate Routing Minimum Blocking Probability (ARMBP), is proposed in [12]. In this heuristic, the Alternate Routing with Shortest Path First- First Fit (AR-SPF-FF) algorithm is employed to place a pre-specified number of converters one by one, sequentially, on the most important nodes among the candidate nodes. The study in [10] presents another novel placement method to minimize the wavelengths usage. In this method, wavelength converters are placed on some of the network nodes in such a way that the number of required wavelengths can be made equal to the maximal number of channels over the fiber (maximal link load). A dynamic programming algorithm that optimally places a given number of converters to minimize the blocking probability in a path is provided in [1], while other algorithms for optimal placement of converters in simple network topologies have been presented in [24]. Another wavelength converters placement approach is proposed in [32]. In their study, the authors investigate the Fixed Alternate Routing (FAR) algorithm and introduce an appropriate heuristic for wavelength converter placement, namely, Minimum Blocking Probability First (MBPF). They also propose another algorithm for wavelength converter placement called Weighted Maximum Segment Length (WMSL) which is compatible to work under the Least Loaded Routing (LLR) algorithm. The study by [33] introduces another heuristic that allocates the converters on the nodes with the highest nodal degree. In their work, the blocking probabilities for Static Lightpath Establishment

(SLE) and Dynamic Lightpath Establishment (DLE) are analyzed, and the results show that this method is cost effective compared with the case of having full deployment of converters in all nodes. In [34], a path metric-based algorithm to determine the best locations for the converters in a network with a given nominal traffic pattern is proposed. A Weighting Factor (WF) that depends on the interference length and the number of hops between the nodes is computed to allow ranking all the nodes in the network, and placing the converters on those nodes having the higher values of (WF). The work of the study by [13] focuses on shared- per- link conversion design and discusses the optimal placement of a specific number of converters in two cases: given either the number of available converters at each node in the network, or given the total number of available converters in the network. In order to have the total amount of traffic through the system getting maximized, the authors propose a heuristic for the first case to place the available number of converters at each node on its outgoing links. For the second case, they propose an optimal algorithm that allocates the available converter in the network at the outgoing links of each node. Other different algorithms for placing converters can be found in [35-39]. In this thesis, we implement four well known converter placement heuristics and compare their performance with our new heuristic. These heuristics with their detailed analyses are presented below.

2.1.1 Random Placement Heuristic

In the Random placement algorithm, the nodes which will be characterized by conversion capability are chosen arbitrary. This method does not follow any systematically placement algorithm, and all the nodes in the network have equal probability of being occupied with a converter. Randomly allocating converters in the network reduces the number of blocked connection requests. Although, this heuristic does not achieve optimal results, it is still useful for comparison purposes to demonstrate the importance of having well-designed converter placement algorithms to minimize blocking probability and achieve the best throughput. In this thesis, we refer to this heuristic by RDP.

2.1.2 High Blocking Placement Heuristic (HBP)

This is a well-known heuristic to solve the problem of converter placement by adding the conversion capability to the nodes having the highest blocking percentages. The blocking probability is the statistical probability that a request connection cannot continue its way to reach the destination due to insufficient transmission resources in the network such as optical wavelengths, optical modes, and optical converters. This concept has been discussed in many studies and is utilized to propose different approaches for determining the optimal placement of a given number of converters. One of these approaches is the exhaustive searching algorithm described in [11]. In this simulation-based algorithm, the network is simulated using certain traffic conditions and a specific number of converters to determine the blocking performance.

Having converters with complete conversion capability, an exhaustive search is performed to find all the possible ways to place these converters at X nodes, where X takes all the values from one to the total number of the nodes in the network. In other words, the algorithm determines and records the blocking probabilities of all the possible combinations of converter placement schemes, all combinations of one node with complete conversion capability, all combinations of two nodes with complete conversion capability, and all combinations of three nodes with complete conversion capability, all the way up to all combinations of all the nodes in the network having complete conversion capability. Subsequently, the optimal nodes to be occupied with converters are assigned by choosing the combination that gives the lowest blocking probability. An important drawback of this algorithm is the long running time especially with the networks that have large number of nodes. Another approach is the Minimum Blocking Probability First (MBPF) algorithm which is introduced in [32]. MBPF initially starts with a network of N nodes that are devoid of converters, and then provides these nodes with conversion capability one by one, sequentially. The first step is to find the node in which the first converter will be placed. The algorithm determines the overall blocking probability of the network for a number of cases equals to the number the network nodes N in such a way that in each case, the converter will be placed on a different node and the blocking probability will be determined, until visiting all the N nodes of the network. The result of this step is a set of blocking probabilities, each one is associated with one node, and the first converter should be placed on the node which has the lowest blocking probability. In the second step, the algorithm takes into account that the network now has one converter that is already placed, and there are $N-1$ candidate nodes to be chosen for

the placement of the second converter. Similarly, the corresponding overall blocking probability will be calculated, and the second converter will be placed according to the same rules used in the first step. MBPF continues working gradually until placing all the converters in the network.

In this thesis, we utilize a variation of the blocking-based approach which places the converters at the nodes with the highest blocking percentages which is proposed in [11] and is referred to in this thesis by HBP. The HBP heuristic gives the near optimal placements by placing all the given converters at the same time without the need to use the aforementioned brute-force search approaches

2.1.2.1 HBP Algorithm

For a given network with N nodes with X converters that are needed to be placed, the HBP algorithm works based on ranking the nodes according to their blocking percentages as follows.

Step 1: Run the simulation on the network with zero number of converters, and calculate the blocking percentage at each node v using this formula

$$BrP(v) = \frac{Br}{Tr},$$

where Br and Tr are the number of blocked requests and the total number of requests at node v .

Step 2: Arrange all the nodes in descending order based on the calculated blocking percentage at each node.

Step 3: Place all the X converters on the first X nodes with the highest blocking percentages.

2.1.3 *K-DS Placement Heuristic*

The K-DS placement heuristic is an algorithm for the sparse placement of converters that was introduced in the study by [24]. It utilizes the concept of dominating sets (DS) theory to reduce the overall blocking probability in a network. For a given network graph (network topology), the dominating set represents a subset or a group of nodes that are referred to as Master nodes and are chosen in such a way that each other node in the network that does not belong to this group, will be a neighbor of at least one of these master nodes [14]. The K-DS heuristic takes into account the amount of the traffic that flows through the network's nodes by considering the degree of each node, and attempts to select the master nodes that can send and receive messages to and from a larger set of the other nodes (that do not belong to the dominating set) in the network. It also considers the distance between master nodes and the other nodes in the network. By K-DS, the conversion capability is added only to the master nodes of the network (dominating nodes set) that are chosen in such a way that each other node is either at k hops away or less from at least one master node.

Unlike other heuristics, the required number of converters that are needed to be allocated in a network using the K-DS algorithm is specified based on the total number of nodes in the network and the K value which represents the maximum distance between the master nodes and other nodes in the network. The smaller the value of K the closer the distance, and the closer the distance the larger the master nodes number (converters). Figure 2.1 shows two topologies with different values of K . Topology (a) consists of 15 nodes and has only 1 Master node for the case

of 2-DS , while topology (b) has 10 nodes and 1-DS Master nodes set of size 2. It can be seen from these two topologies that each one of the network nodes is either a master node or is at K hop a way of it.

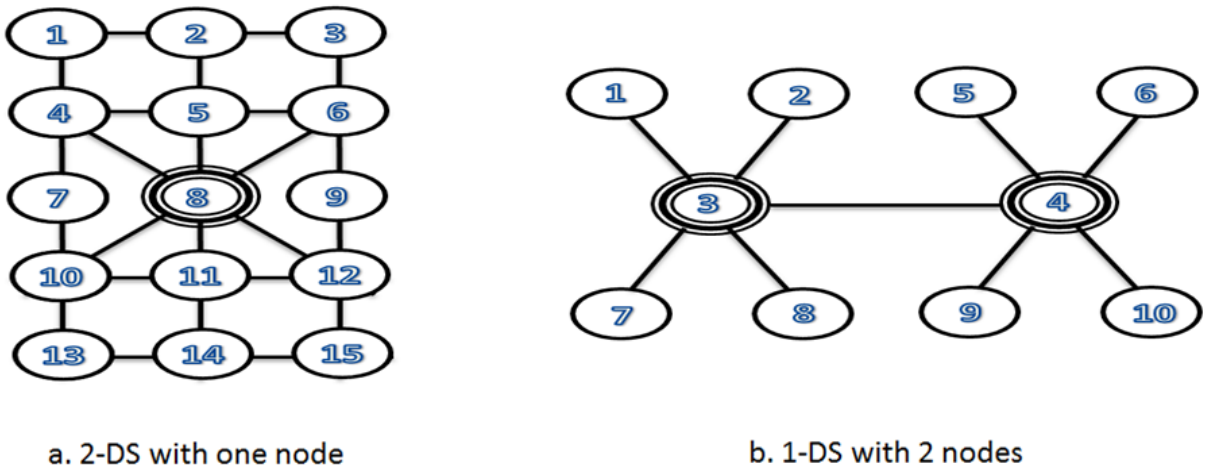

Figure 2.1 : Examples of Different Values of K with Different Topologies

2.1.3.1 K-DS Algorithm

The K-DS algorithm uses the topology of the network as an input and examines all its nodes to provide the set of master nodes that are needed to be occupied with complete conversion capability. For a given network topology, certain number of connected nodes arranged in a specific pattern, with a graph $G (V, E)$, the algorithm computes a dominating set D such that D is a part of V , and ensures that every node of V in G is either in D or is at most at distance K away from any node in D . Consequently, the algorithm first initializes an empty set S , and then each

node v determines its connectivity index $Connect_k$ with respect to the nodes that are located within a distance k from the node v . Therefore, the values of $Connect_{k-1}$ of the node v and all $Neighbor(v)$, the node that shares a link with the node v , are added as follows.

- $Connect_0 = \text{degree}(v)$ or the number of links that are connected directly to the node v .
- $Connect_1(v) = Connect_0(v) + Connect_0(r_1) + Connect_0(r_2) + \dots + Connect_0(r_m)$,
where $r \in Neighbor(v)$, and $m = \text{Number of nodes in } Neighbor(v) \text{ set}$.

Thus, $Connect_k(v)$ can be defined as:

- $Connect_k(v) = Connect_{k-1}(v) + \sum Connect_{k-1}(r_m), r_m \in Neighbor(v)$

After computing $Connect_k(v)$, each node v sends a message to the set of nodes that at k distance or less away from it; all the nodes in its $Neighbor_k(v)$ set. Subsequently, each node will choose its master node, referred to as $Master_k(v)$ from the nodes in its $Neighbor_k$ set, by choosing the node with the highest connectivity index $Connect_k(v)$. Then, each node v will send a voting result message to its selected $Master_k$ node to inform this node that it was chosen to be a master node. Consequently, all the nodes that receive voting messages, selected to be $Master_k$ node, are added to the dominating set S to be characterized later with conversion capability.

The pseudo code of K-DS algorithm is given below.

For a given network with a graph G , and number of iterations K , $K > 0$:

Step 1: Initialize the working set S to the empty set ϕ .

Step 2: For all nodes v in G , compute $Connect_k(v)$.

Step 3: For all nodes v , If $S \cap Neighbor_k(v)$ is empty, Do

- {Find the node m that is $Master_k(v)$.
- Add node m to the set S }.

Step 4: Set K -DS to S ; Return K -DS.

2.1.4 HYBRID Placement Heuristic (HYB)

This heuristic approach combines the two aforementioned converter placement algorithms, K-DS and HBP. HYBRID placement heuristic is introduced in the study [24] as an extension to the K-DS algorithm. Since K-DS deals with a fixed number of converters, HYB is proposed to overcome this limitation and allows any arbitrary number of converters to be placed in the network. HYB provides a solution for the cases in which the number of the given converters does not exactly match any K-DS sets by utilizing both K-DS and HBP.

By using HYB for placing a given number of converters X on the network, a group with a number of nodes equals the largest possible K-DS set size smaller than X , denoted as $\mathcal{L}K$ -DS, is

selected first to be occupied with converters using K-DS algorithm. Then HBP algorithm is used to place the rest of converters iteratively one by one on the node with the highest experienced blocking, until placing all the X converters. The set of nodes selected by HYB always include the k-DS nodes, and when a given number of converters X is equal any K-DS set, HYB algorithm returns similar results as K-DS, due to the fact that the selected nodes to be occupied with converters are the same.

2.1.4.1 HYB Algorithm

HYB takes advantages of both k-DS and HBP algorithms, and can be described as follows.

Step 1:

- Set *NumNodes* to be the number of selected nodes to be occupied with converter;
- Start with $k = 1$, Do until $\mathcal{L}K\text{-DS} \leq X$
- { Compute K-DS; *NumNodes* = No. of the master nodes;
- Increment K by 1; Repeat }

Step 2:

- If *NumNodes* = X {
- Return $\mathcal{L}K\text{-DS}$ as the list of nodes that should have converters; Exit the algorithm }
- Else {
- Add converter to each one of the nodes in $\mathcal{L}K\text{-DS}$ }

Step 3:

- Set $j = \text{NumNodes}$, Do until $j = X$ {
- Run simulation with j nodes occupied with convertors.
- Select the node with the highest blocking percentage to be the next $(j+1)^{\text{th}}$ node , and allocate convertor on it.
- Increment j by 1; Repeat }

2.2 New Heuristic for Converter Placement

Various heuristic algorithms and approaches for the sparse converter placement problem have been shown and discussed in the previous sections of this chapter. Some of these heuristics are simulation-based algorithms. Some of them place converters all at once while in the others the converters are allocated sequentially one by one. Furthermore, the functions and computational analyses used in some of them are complex compared to the simple methods. However, this complexity does not always provide better performance.

In this thesis, we propose a new heuristic to solve the converter placement problem called the Highest Request Node (HRN) heuristic. HRN considers the number of communications between the nodes in the network, and places the converters on the nodes that receive the highest volume of connection requests. The idea behind this approach is to indicate the nodes that can benefit more from having a converter and add the conversion capability to them. Having a node with high connection requests means that there is a high number of lightpaths, associated with these requests, passing through this node. The higher the number of lightpaths, the higher the number of resources, wavelength and mode, is needed to support these connections, and the higher the number of conversions required to overcome the continuity constrain problem. Thus, a better functionality of a converter can be achieved if it is added to such a node compared to other nodes in the network. Adding the conversion capability to the node with the highest requests efficiently increases the reuse of its resources to support a larger number of lightpaths. Consequently, this

leads to reduce the number of the blocked requests at each node and enhances the overall throughput of the network.

HRN heuristic uses only the traffic at each node as an input and does not consider the dependence between converters locations. Therefore, it places all the given converters at once. In addition, HRN is a simulation based heuristic in which a simulation test is run first to obtain the total number of requests at each node before placing any converter in the network. For calculating the total number of requests at each node, HRN does not count any sourced and sinked request. When a connection is established at a source node, sourced request, a wavelength and/or a mode is assigned to this connection. The presence of a converter at such a node, source node, does not provide any more resources if all the available modes and wavelengths are consumed. Furthermore, the requests that reach their destination, sinked requests, will never need to perform any resource conversion. Thus, HRN considers only the requests that are passing through the node (traversing) when it functions as an intermediate node.

2.2.1 HRN Algorithm

This algorithm is based on ranking the nodes according to the total number of requests at each node and works as shown below.

For a given network with N nodes, and X number of converters that need to be placed:

Step 1:

- *Run the simulation on the network setting conversion capability to be not available in any node (Zero number of converters)*
- *For each node, $v = 1, 2, 3, \dots, N$ {*
- *Set $T_r(v) = 0$; // $T_r(v)$ is the total number of requests at node v ,*
- *For each request R coming to node v ,*
- *if (R is not sourced or sinked) { $T_r(v) = T_r(v) + 1$ }*

Step 2:

- *Arrange all the nodes in descending order based on the calculated $T_r(v)$ at each node.*

Step 3:

- *Return the first X nodes that have the highest $T_r(v)$ to be occupied with convertors.*

CHAPTER 3 NETWORK MODEL AND SIMULATION SCHEMES

In this chapter, we firstly present the network topologies, algorithms, and approaches that are used in the simulation analysis. Subsequently, the following converter placement methods: High Blocking placement (HBP), K-DS placement (K-DS), HYBRID placement (HYB), and Highest Request Node (HRN) placement heuristics have been illustrated by examples that show their mechanisms of choosing the perfect set of nodes to be occupied with converters. Then, we illustrate the importance of the converters' positions, and show the difference in the blocking performance of the same number of converters placed in the same network topology but on different nodes locations.

3.1 Optical Network Simulation

In order to carry out the simulation tests and evaluate the performance of the converter placement heuristics, a simulation testbed written in C++ is designed. We refer to this simulator as the Optical Network Simulator (ONS). Extensive tests are performed using ONS over a variety of optical network topologies. We use mostly a popular topology called US-Long Haul that is usually used in the literature for the simulation analysis of optical networks. The US-Long Haul network consists of 28 nodes and 45 bidirectional fiber links as shown in Fig 3.1(a). In addition, we consider another optical network topology that is smaller but denser than the US-Long Haul topology, called Toronto Metropolitan. This topology has a higher link density with

55 bidirectional fiber links and 25 nodes as shown in Fig 3.1(b). Furthermore, we use a 5 x 5 Mesh-Tours topology with 49 bidirectional fiber links as shown in Fig 3.1(c).

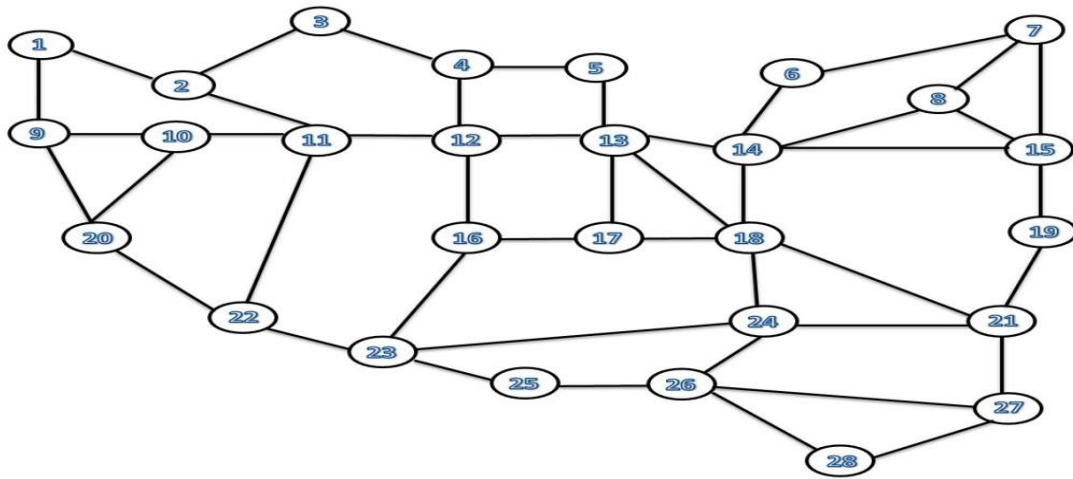

(a) US Long Haul

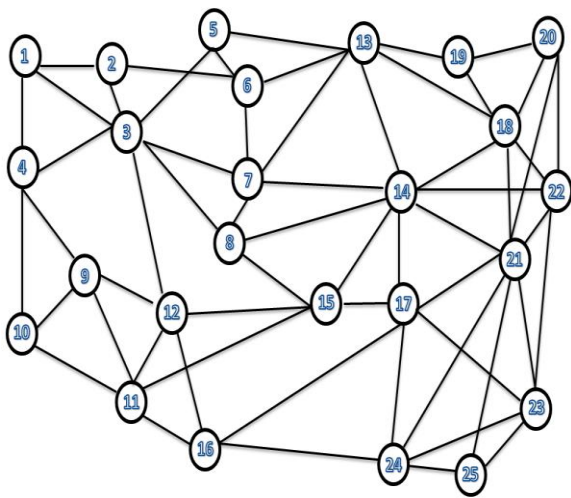

(b) Toronto Metropolitan

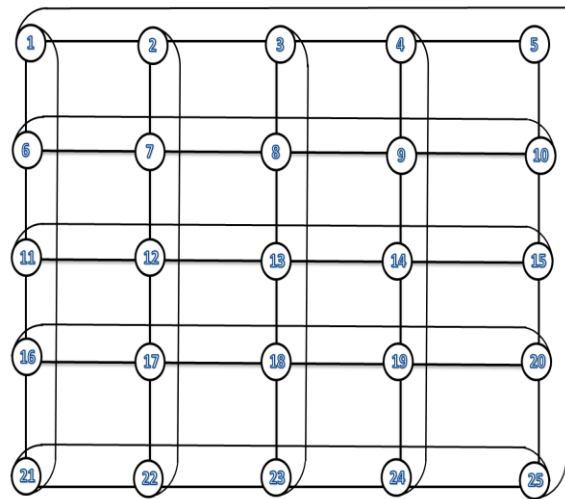

(c) 5 x 5 Mesh-Tours

Figure 3.1 : Three Different Network Topologies

The load is expressed using “Erlangs” which is the product of the average arrival rate (λ) with the average holding time to transmit the data from the transmitter at the source node ($1/\mu$). In ONS, we utilize the Shortest Path First algorithm (SPF) to assign a specific path between each source-destination pair. The source and destination nodes are randomly chosen and the shortest path between these two nodes is computed using Dijkstra’s algorithm. To establish the static lightpath, ONS implements the First-Fit wavelength-assignment or mode-assignment heuristic (FF). This heuristic predefines an arbitrary order on the wavelengths (or modes) and labels them numerically. Consequently, to assign a wavelength (or mode) for a lightpath at the source node, the algorithm searches for the available wavelengths (modes) and select the first free low numbered wavelength (mode). This assignment strategy is easy to be implemented and is preferred in practice because of its small overhead and low complexity. Furthermore, it does not require any global knowledge because it does not need to know or search the entire wavelength (mode) space for each route. Moreover, it is fairly efficient at utilizing wavelengths and performs well in term of blocking probability [11, 40, 41]. One of the objectives of this thesis is to utilize the combination between MDM and WDM in Mode-Wavelength Division Multiplexing (MWDM) network. Thus, in our simulation, each lightpath does not just need a free wavelength but a free mode as well. More precisely in ONS, the First Fit heuristic is used to assign a free mode and wavelength for each lightpath at the source node.

Regarding to the optical transport methodologies, we use one of the most important optical switching technologies, namely, Optical Burst Switching (OBS). Although there are other all-optical transport methodologies such as Optical Circuit Switching (OCS) and Optical Packet

Switching (OPS), Optical Burst Switching (OBS) is viewed as the best compromise between OCS and OPS through combining their best characteristics and avoiding the drawbacks [42, 43]. In standard OBS networks, the data is divided into a collection of packets called a Burst. A header message called Control Packet (CP) is sent ahead of the corresponding data burst to reserve a route for the upcoming burst by reserving an optical channel in each optical router, node, along the lightpath from the source to the destination. The data burst follows the control packet without waiting for an acknowledgment. The starting time of these two transmissions are separated by a special time (offset time) at the source node and all the subsequent intermediate nodes. There are two main optical burst reservation protocols (scheduling methods): Just In Time (JIT) and Just Enough Time (JET) [44]. In our simulation, we use the JIT signaling protocol [45], in which the offset time is specified based on the number of hops along the lightpath and the switch configuration time (cut through time). As mentioned above, ONS chooses the source-destination pair randomly and establishes a lightpath based on the shortest distance between them. During the simulation, the assembled burst is assumed to arrive at the network with a controllable Poisson distribution (λ), and processed by a holding time that is distributed exponentially with a mean of $(1/\mu)$. The control packet which is generated at the source node is sent to reserve a free optical channel, wavelength and mode, from the source to the destination using JIT. When there are no available W, and M at the next hop, it tries a mode conversion, a wavelength conversion, or both, if a mode converter (MC), a wavelength converter (WC), or mode-wavelength converter (MWC) is available at the node respectively. This process continues

until the control packet either succeeds to reserve a free channel and reach its destination, or gets blocked because of the unavailability of a free W and/or M .

3.1.1 Blocking Percentage Calculation

In order to evaluate the performance of the various converter placement heuristics that are considered in this thesis, we use the overall blocking percentage of the network as a key metric to represent and compare the simulation results. During the simulation, the blocking percentage is computed as:

$$\text{Block Percent} = \frac{TBR}{TR}$$

where TR is the total number of requests of the network and represents the summation of all the arrival bursts. TBR is the total number of blocked requests (blocked bursts) and consists of two types of blocked bursts: the blocked bursts due to the lack in the network resources at the node, exhaustion in W or M , and the blocked bursts because of the continuity constraint problem, the unavailability of MC , WC , or MWC . Figure 3.2 shows the simulation results of the blocking performance of the US Long Haul network, using fiber links with $M=6$, and $W=12$ and different applied loads in Erlangs for the following cases: (i) without conversion capability, (ii) full deployment of MC , (iii) full deployment of WC , and (iv) full deployment of MWC . It can be seen from the results shown in Figure 3.2 that the blocking percentage, represented by the top curve no.4 and associated with case of no converters in the network, is significantly high because

it suffers from both types of burst blocking. However, adding conversion capability to the network causes the blocking percentage to decrease sharply especially for the case of using MWC. This is due to the fact that occupying each node in the network with the MC, WC, or MWC, breaks the continuity constraint problem. Therefore, the percentage of the blocked bursts due to the unavailability of MC, WC, and MWC will be removed from the overall blocking percentage as shown in curve no.3, curve no.2, and curve no.1 respectively.

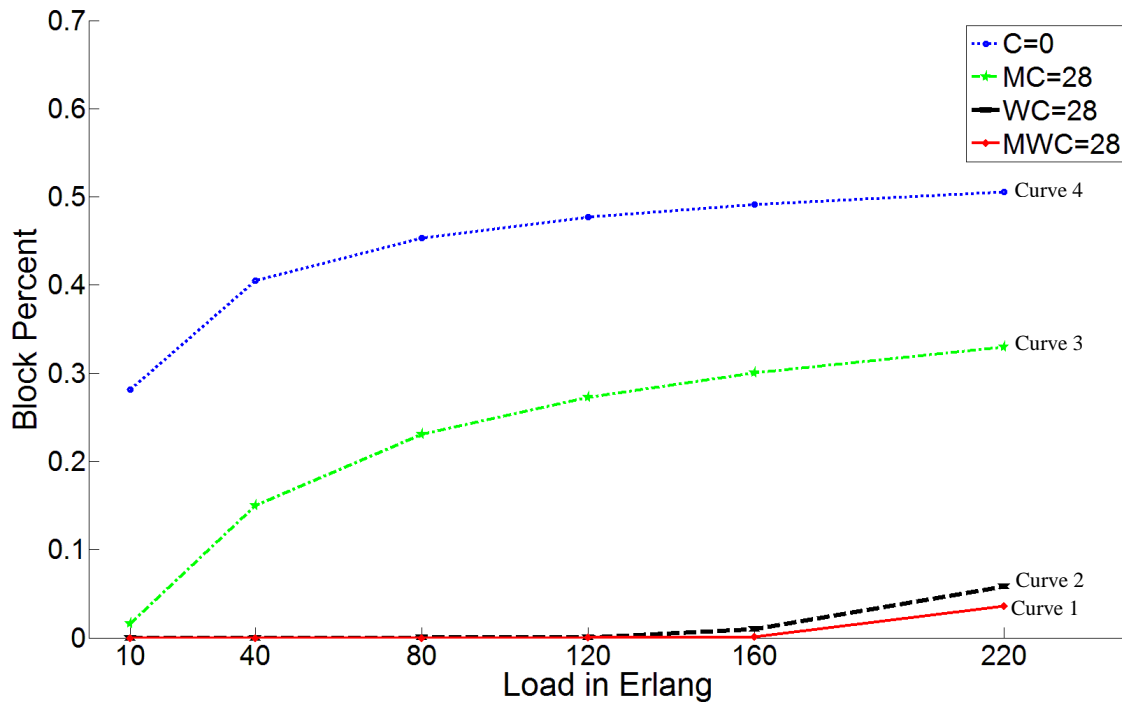

Figure 3.2 : Blocking Performance

It can be observed from the results of Figure 3.2 that the blocking percentage increases with the increase in the applied loads because of the fact that the network's resources, $M=6$, and $W=12$,

are fixed for all the loads. Furthermore, when the load is low, the bursts are blocked mainly because of the continuity constraint. However, when the traffic load is heavy, the bursts are blocked mainly because the network resources are exhausted. Consequently, we can see from curve no.1 that the blocking percentage equals almost zero but when the traffic increases, load= 160, and 220 Erlangs, the blocking percentage starts to increase due to the exhaustion of resources.

3.2 Heuristics Implementation Examples

In this section, an example of each one of HBP, K-DS, HYB, and HRN heuristics is introduced. These examples show the returned results when the aforementioned algorithms are applied on a network topology. These results demonstrate the most effective nodes that should be occupied by the converters based on each algorithm.

3.2.1 HBP Implementation Example

HBP is implemented by carrying out a simulation for the load in Erlang equals to 120 over the US Long Haul topology shown in Figure 3.1(a) without any conversion capabilities. The algorithm returns a list of nodes ordered in a descending order of blocking probability starting with the node v that has the highest blocking percentage, highest $BrP(v)$, as shown in Figure 3.3. Therefore, to place any number of converters X on the US Long Haul network, the first X nodes

should be selected. The nodes with multiple circles that are shown in Figure 3.4, represent the positions of converters for the case of $X=6$.

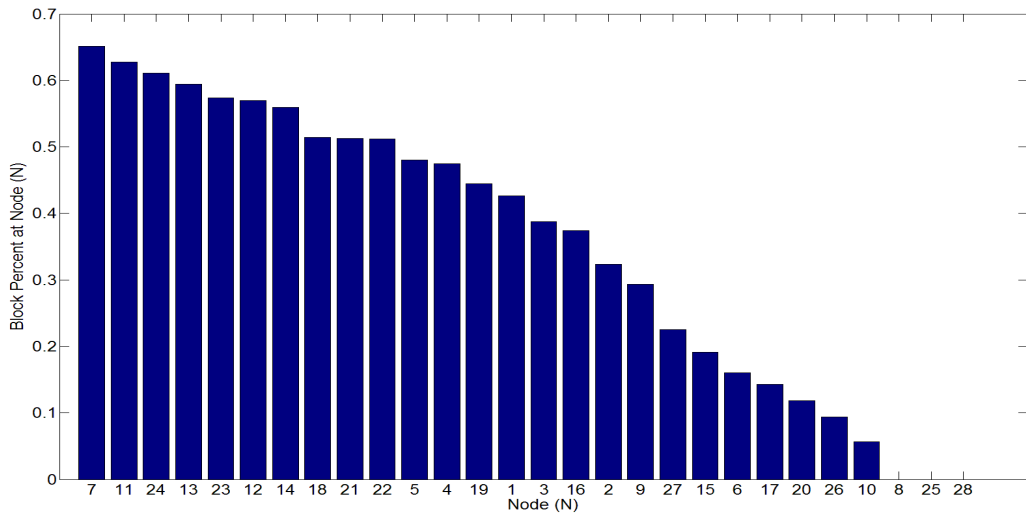

Figure 3.3 : HBP Descending Order of Blocking Probability

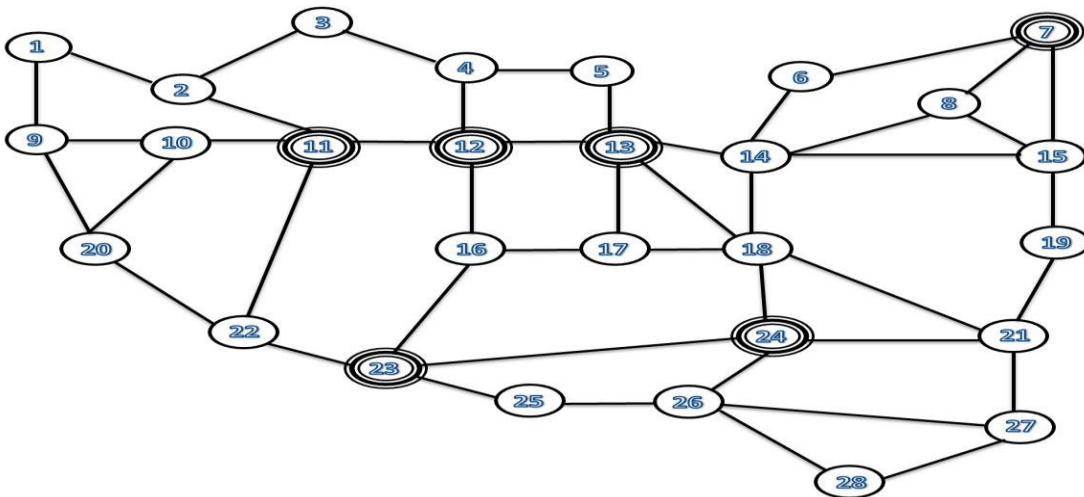

Figure 3.4: Converter Placement in US Long Haul using HBP

3.2.2 K-DS Implementation Example

The K-DS algorithm is applied over all the three network topologies that are used in this thesis to obtain the set of the master nodes corresponding to each one of these topologies for all the possible values of K. The US Long Haul network is used first as an input to implement the K-DS algorithm. We initially run the algorithm starting with k equals 1 and record the set of the master nodes that is returned as the result. We then increase the value of k by one, and repeat the same process until k-DS returns only a one master node. Table 3.1 shows the $Master_k$ sets corresponding to the US Long Haul topology for all the possible values of K.

Table 3.1 : K-DS Results for US Long Haul Network

K-DS	Master Nodes
1-DS	{ 2, 9, 10, 11, 12, 13, 14, 15, 21, 22, 23, 24, 26 }
2-DS	{ 11, 12, 13, 14, 24 }
3-DS	{ 12, 13, 24 }
4-DS	{ 13 }

Similarly, the K-DS algorithm is implemented over the Toronto Metropolitan and 5 x 5 Mesh-Tours topologies which are shown in Figures 3.1(b), and (c) respectively, to get the set of the master nodes that corresponds to these two topologies for all the possible values of K. The results are shown in Table 3.2 and Table 3.3, respectively. It can be seen from these results that the smaller (less nodes number) and denser (higher links number) networks require a smaller set of master nodes to satisfy the cases of K-D.S.

Table 3.2 : K-DS Results for Toronto Metropolitan Network

K-DS	Master Nodes
1-DS	{ 3, 11, 13, 21 }
2-DS	{ 3, 21 }
3-DS	{ 7 }

Table 3.3 : K-DS Results for 5 x 5 Mesh- Tours Network

K-DS	Master Nodes
1-DS	{ 1, 5, 9, 12, 20, 23 }
2-DS	{ 1, 10, 13, 22 }
3-DS	{ 1, 13 }
4-DS	{ 13 }

3.2.3 HYB Implementation Example

For a given number of converters X , the US Long Haul network is used as an input to implement HYB. We run the algorithm for different values of X using a fixed load equals 120 Erlangs. Table 3.4 shows the results. For each considered value of X , the results present the corresponding \mathcal{L} K-DS nodes set, and the other nodes that are used to place the rest of the converters for each of iteration J . Similarly, the Toronto Metropolitan and 5 x 5 Mesh- Tours topologies are implemented during the simulation tests.

Table 3.4 : HYB Results for US Long Haul Network with various values of X

X	\mathcal{L} K-DS	Highest Blocking Percentage Nodes				
5	2-DS	J=X=5				
	{ 11, 12, 13, 14, 24 }	-----				
8	2-DS	J=6	J=7	J=X=8		
	{ 11, 12, 13, 14, 24 }	7	23	18		
18	1-DS	J=14	J=15	J=16	J=17	J=X=18
	{ 2, 9, 10, 11, 12, 13, 14, 15, 21, 22, 23, 24, 26 }	7	18	19	3	5

3.2.4 HRN Implementation Example

In order to show an example of how HRN places a given number of converters on a network, a simulation is carried out on the U.S Long Haul under a load in Erlang equals 120. We initially run the simulation assuming that the complete conversion capability is not available at any node. Meanwhile, the nodes request's counters $T_r(v)$ are updated and recorded. Subsequently, the algorithm returns a list of nodes ordered in a descending way starting by the node with the highest number of requests. Figure 3.5 shows the number of requests at each node, starting from high to low. Now, in order to place any given number of converters X on the US Long Haul network, the first X nodes should be selected. The nodes with multiple circles that are shown in Figure 3.6, represent the positions of converters for the case of $X=8$.

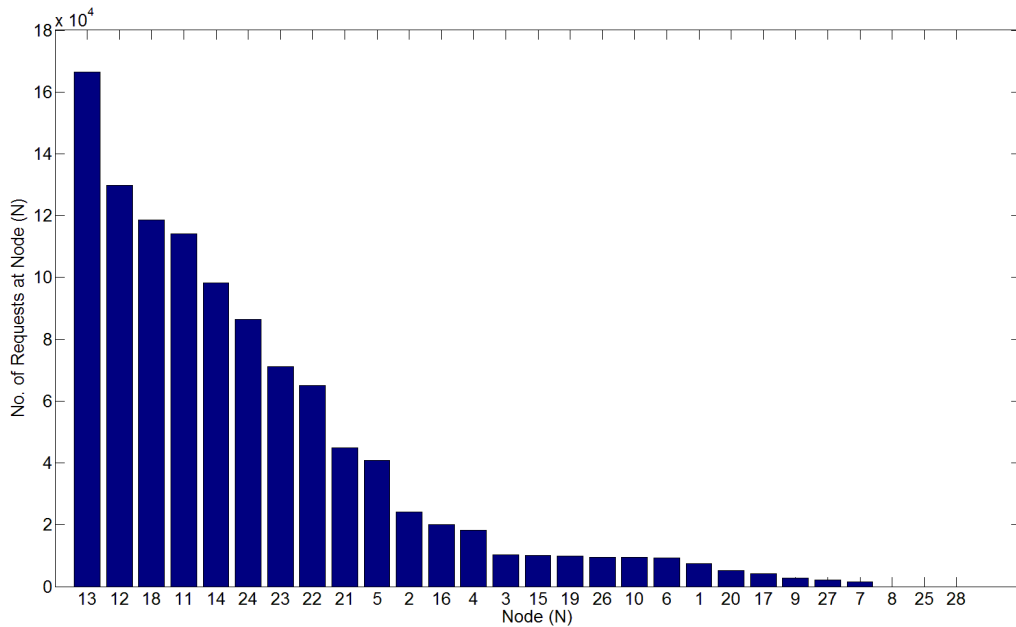

Figure 3.5 : HRN Descending Order of Number of Requests

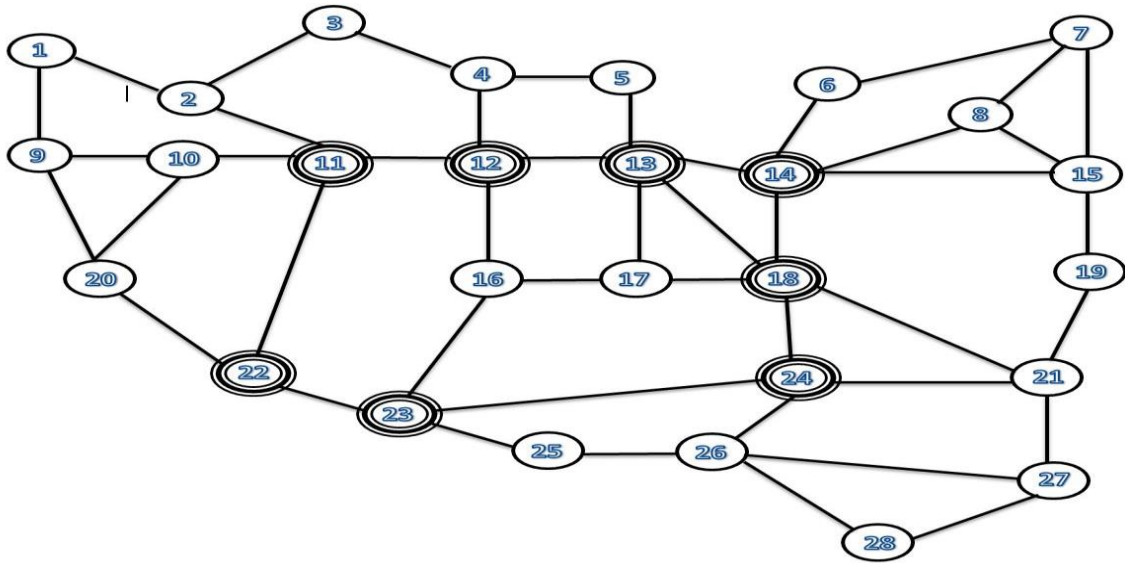

Figure 3.6 : Converter Placement in US Long Haul using HRN

3.3 Converter Position Impact

In order to gain some qualitative insights into the importance of converters location in the network, and to demonstrate the need of having well designed converter placement heuristics to achieve a good performance, an initial set of simulations is implemented on the US Long Haul topology. A simulation is run first under a load in Erlang =120, using $M=6$, $W=12$, and only one WC allocated on the node no.1 in the network to compute the utilization gain of adding WC to this node. This gain represents the amount of which the overall blocking percentage of the network reduces. Then the location of this WC is changed to all the nodes in the network, one by one, sequentially, and the utilization gain that is associated with each node is calculated. Similarly, and instead of using WC, another two sets of simulations are carried out using

MC =1, and MWC =1. Figure 3.7 shows the utilization gain of having one WC, MC, or MWC as a function of converter position. By looking to these results, we can see the disparity between the values of the utilization gain of each node. Therefore, it is further validated that we can achieve better blocking performance if the converters are placed judiciously in the network.

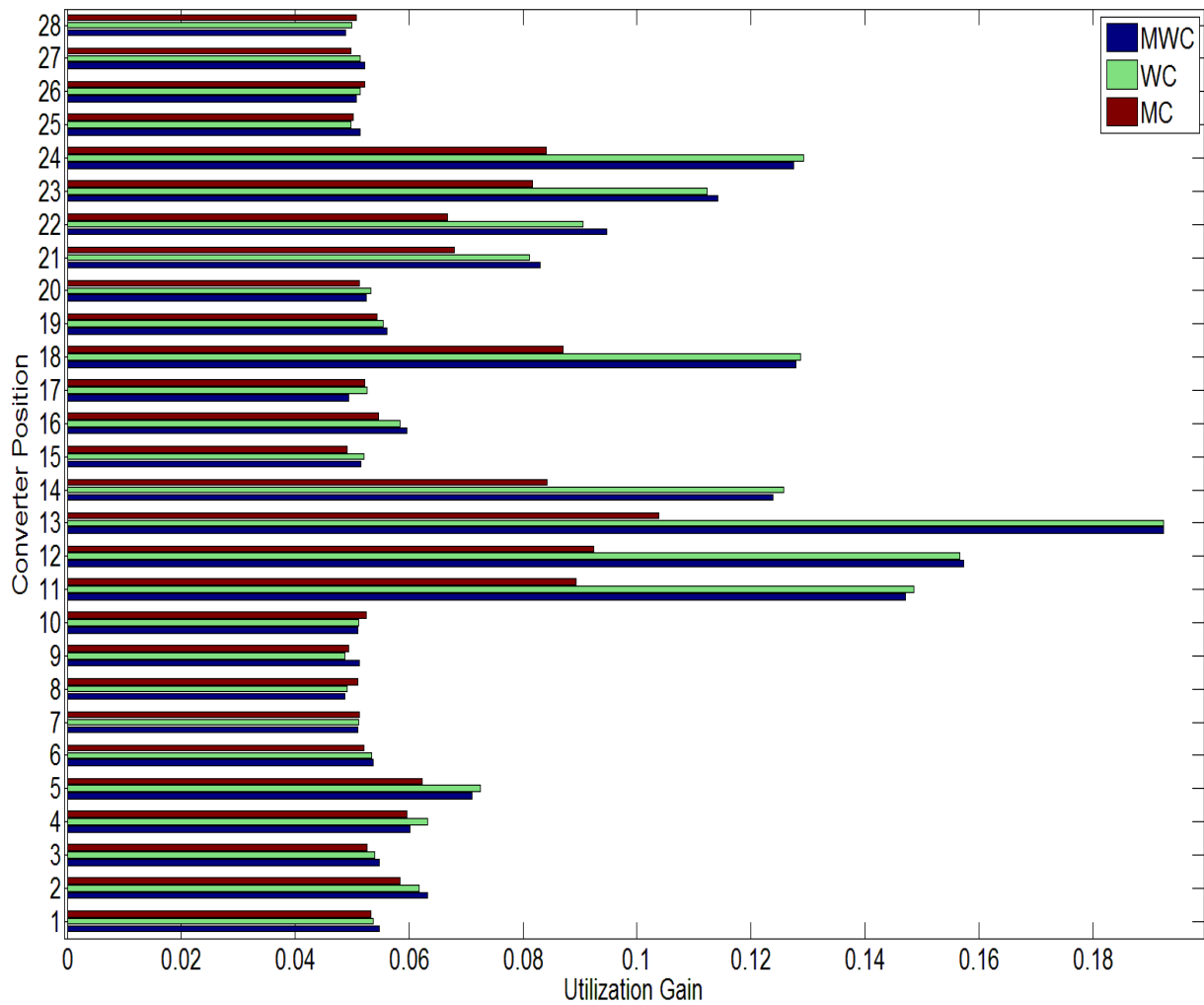

Figure 3.7 : Converter Position Comparison

CHAPTER 4 PERFORMANCE COMPARISON AND SIMULATION RESULTS

In this chapter, the simulation tests results using variety of converter placement methods over different network topologies are presented. The following methods: Random placement (RDP), High Blocking placement (HBP), K-DS placement (K-DS), HYBRID placement (HYB), and the new proposed method Highest Request Node (HRN) have been extensively tested using the ONS simulation. We first introduce the performance results and comparisons of the different types of converters for the US Long Haul Network. Subsequently, the performance results of the Toronto Metropolitan and 5 x 5 Mesh- Tours topologies are presented.

4.1 Simulation Results and Discussion, *US Long Haul Network*

To investigate the behavior of the converters when they are placed on the US Long Haul optical network with 28 nodes and 45 links as shown in Figure 3.1(a), several simulation tests are carried out using RDP, HBP, K-DS , HYB, and HRN converter placement heuristics. Then the performance results of wavelength converters (WC), mode converters (MC), and mode-wavelength converters (MWC) are presented sequentially.

4.1.1 Wavelength Converter Performance

A set of simulations to compare the performance of placing WC in the US Long Haul network is implemented under a load of 120 Erlang. In these simulations, each fiber link is assumed to have $M=6$, and $W=12$. The results of the blocking percentage versus the number of WC are plotted in Figure 4.1 and 4.2. Different numbers of WC that fit with the K-DS algorithm are used in Figure 4.1, while another flexible range of WC is used in Figure 4.2.

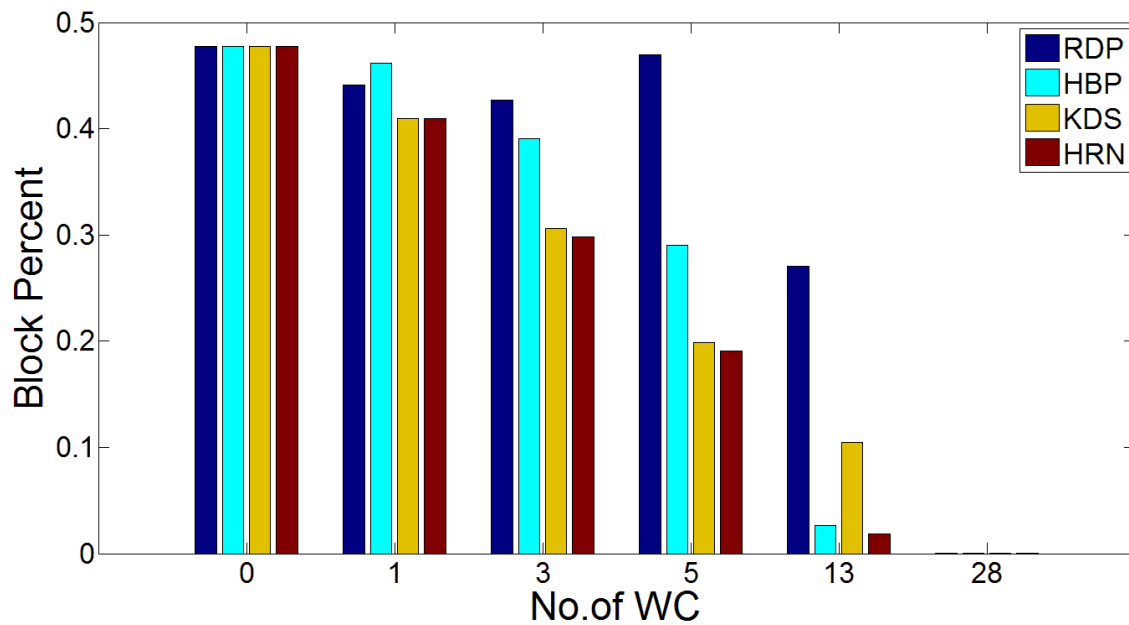

Figure 4.1 : RDP, HBP, KDS, HRN Comparison using Different Numbers of WC

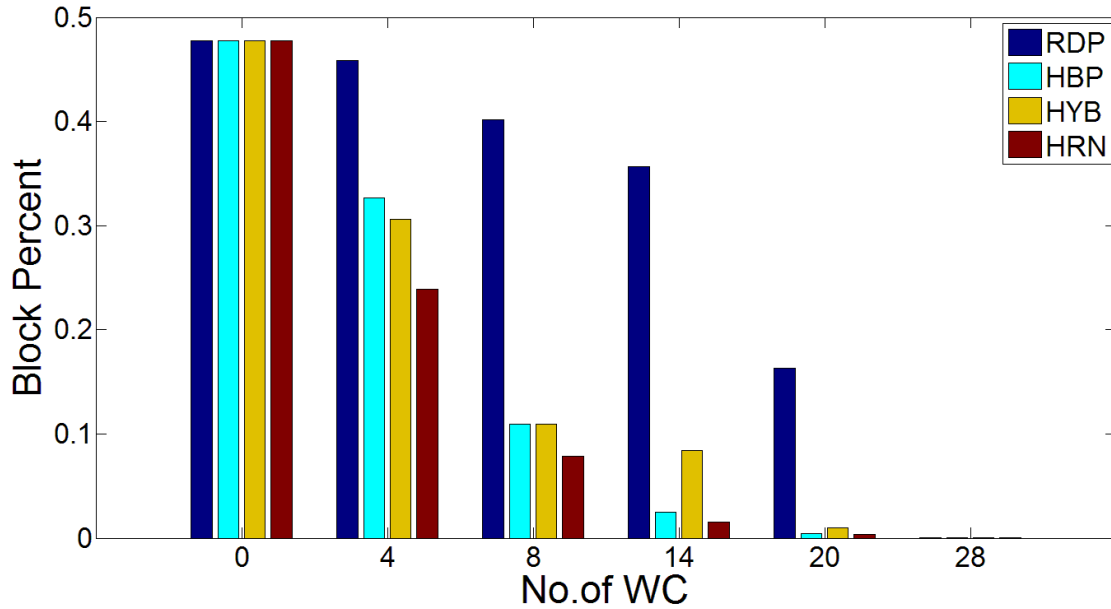

Figure 4.2 : RDP, HBP, HYB, HRN Comparison using Different Numbers of WC

Several observations can be made from Figures 4.1, and 4.2. First of all, the blocking percentage of the network decreases as the number of WC increases in the network for all the aforementioned algorithms. Secondly, the performance of RDP is poor, and a better blocking performance can be achieved if the converters are placed optimally using HBP, K-DS, HYB, or HRN. Furthermore, it can be seen from Figure 4.2, an appropriate converter placement of four WCs could achieve better performance than an arbitrary placement of fourteen WCs. Moreover, it is obvious that our algorithm HRN achieves minimum blocking probability than the other algorithms RDP, HBP, K-DS, and HYB. This can be explained by the fact that HRN places converters on the nodes with the highest requests, which can benefit more from having a converter. In addition, we can see from Figure 4.1 that K-DS and HRN produce an equal

blocking percentage for the case of $WC = 1$, and this is due to the reason that in this case, both algorithms place the converter on the same node, $v=13$. Another observation is that the performance of HYB algorithm is better than K-DS because it combines the good results of both K-DS and HBP. The presented results demonstrate that conversion plays a significant role in improving the blocking percentage in optical networks, and with only a few converters the throughput can be enhanced by a large margin.

Another set of simulations is conducted using the HRN algorithm to evaluate the performance of WC on the blocking percentage of the network under variable loads. In these simulations, each fiber link is assumed to support different wavelengths (W) but only a fixed number of modes (M). The variety in the number of supported W allows examining the relation between these numbers and the applied load. It also helps studying the effect of supported W on the performance of WC. Figure 4.3 shows the blocking percentage of the network versus different number of WC for the following cases: (i) Load (λ) = 120 Erlang, $W=8$, and $M=6$, (ii) Load (λ) = 120 Erlang, $W=16$, and $M=6$, (iii) Load (λ) = 240 Erlang, $W=8$, and $M=6$, and (iv) Load (λ) = 240 Erlang, $W=16$, and $M=6$. Obviously, the blocking percentages reduce if the network supports more wavelengths per fiber. When the number of supported wavelengths is the highest with $W=16$ and the load is the smallest with $\lambda = 120$, the blocking performance in the network is the best. In contrast, when the applied load is large with $\lambda = 240$ and the available number of wavelengths is low with $W=8$, the blocking percentage in the network is the worst. The increase of the number of W reduces the number of the blocked bursts due to the resources exhaustive, and increases the options for wavelength conversions that eliminate the effect of wavelength

continuity constraint. On the other hand, it can be seen from the results in Figure 4.3 that the increase in the load increases the blocking percentage of the network for each considered number of W . When the load is heavy, the bursts are blocked mainly because of the lack of W . Therefore, increasing the load and fixing W decreases the benefit of WC to reduce the blocking percentage.

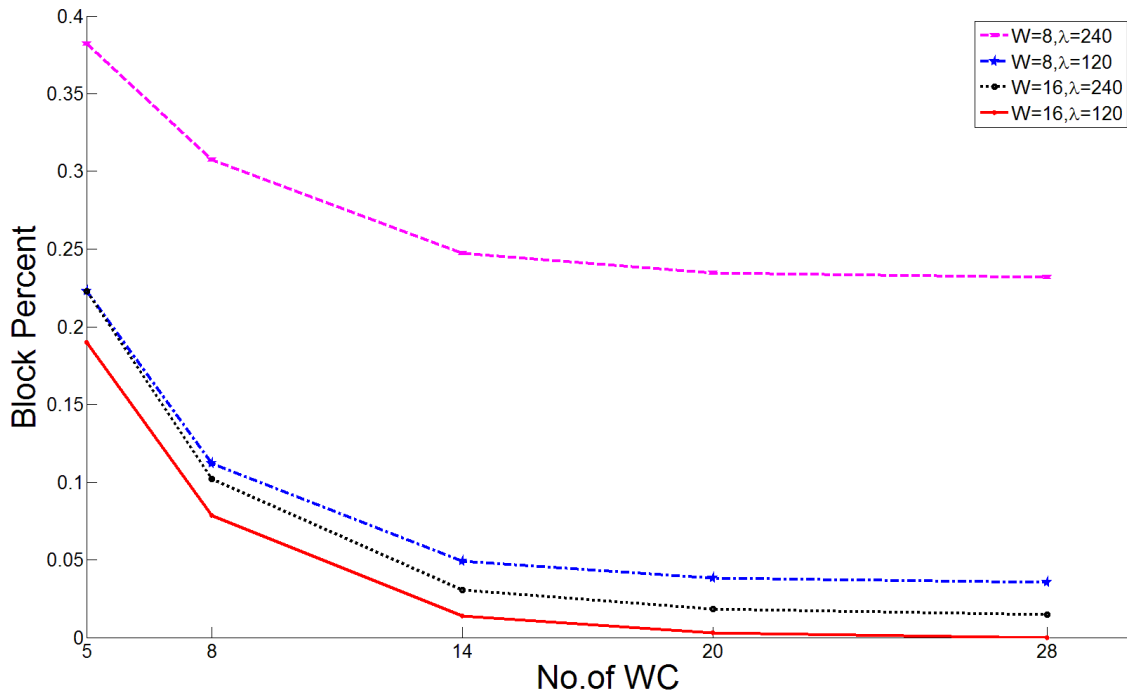

Figure 4.3 : Blocking Percentage of HRN versus Number of WC, Various λ and W

4.1.2 Mode Converter Performance

The performance of MC is also investigated through simulation. The algorithms for converter placement RDP, HBP, K-DS, HYB, and HRN are run sequentially on the US Long Haul topology under load in Erlang equals 120 and $M=6$, $W=12$. The results of the blocking percentage versus the different numbers of MC are shown in Figures 4.4 and 4.5.

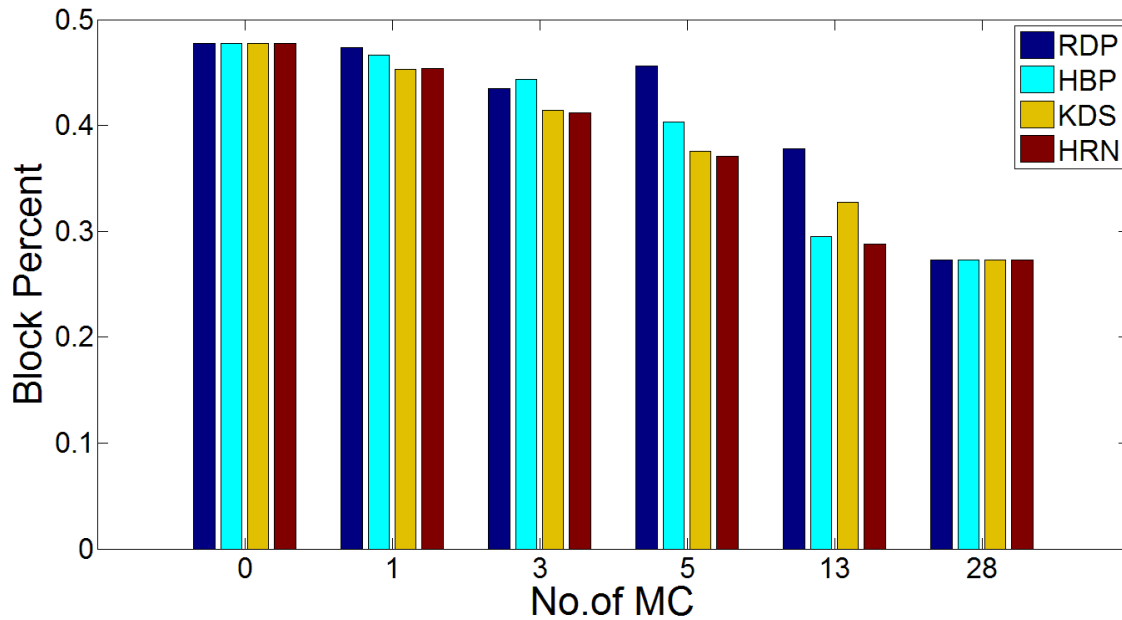

Figure 4.4 : RDP, HBP, KDS, HRN Comparison using Different Numbers of MC

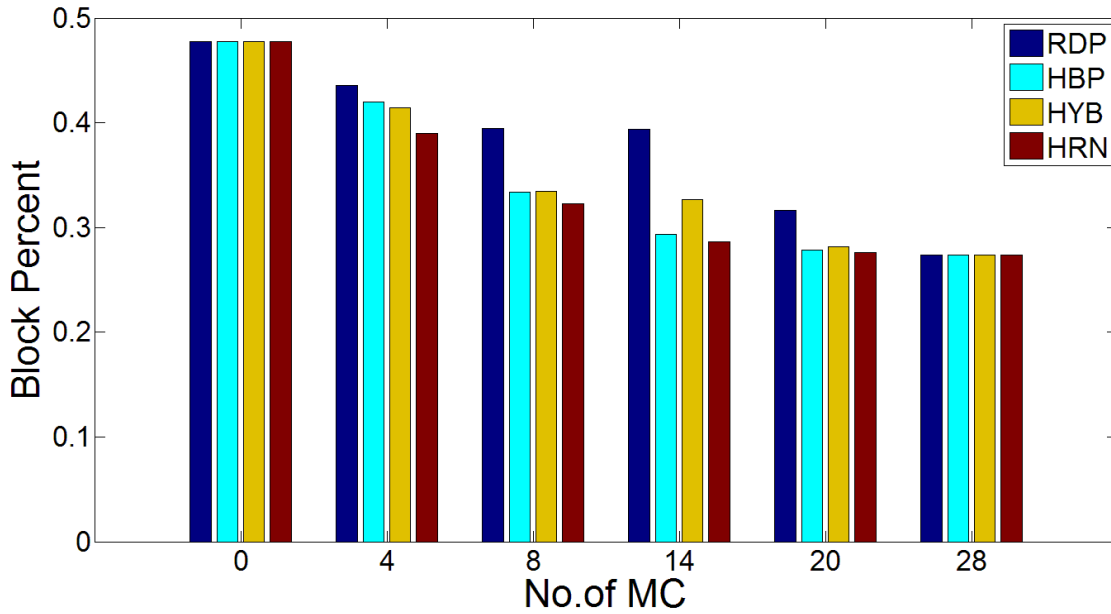

Figure 4.5 : RDP, HBP, HYB, HRN Comparison using Different Numbers of MC

By comparing the results in Figures 4.4 and 4.5, and the previously mentioned results associated with WC, it can be seen that there is a significant change between the performance of WC and MC even with full conversion capability. The blocking reduction achievement by MC is poorer, and this can be explained by the fact that in these simulations scenarios, the number of M supported by the network equals to half the number of W. Therefore, the number of wavelength conversion is much higher than the number of mode conversion in the network. Consequently, the network will benefit more from WC, and the blocking performance will be better. On the other hand, and similar to the observations that are made from the performance results of WC, we can observe from Figures 4.4, and 4.5, that with the increase in the number of MC, the blocking percentage decreases. In addition, the optimal placement heuristics HBP, K-DS, HYB,

and HRN result in a better performance than random placement RDP. Furthermore, our HRN algorithm provides the lowest blocking percentage with respect to other algorithms which indicates the effectiveness of our algorithm.

Mode Converter performance is also investigated using a various numbers of supported modes, and different applied loads. In these performance tests, HRN is used to place the converters, and each fiber link is assumed to support a fixed number of wavelengths ($W=12$) and different modes ($M=4$, and $M=8$). The considered loads in these tests are $\lambda = 120$, and 240 Erlang. The results of these different cases are shown in Figure 4.6. A similar discussion to that which is made about WC can be presented here. The heavier the load, the higher the blocking performance associated with each number of M . Furthermore, increasing the number of M improves the blocking performance of the network, and enlarges the benefit of using MC. The amount of mode conversions increases in the network that leads to reduce the effect of mode continuity constraint. Moreover, having both, the enough number of supported M and the large number of MC, enhances the throughput of the network through reducing the blocking percentage by a large margin. However, with a smaller number of modes, the effect of increasing the number of MC on reducing blocking percentage of the network decreases. This can be explained by the fact that the free mode resources in the network are exhausted and no more mode conversions can be done.

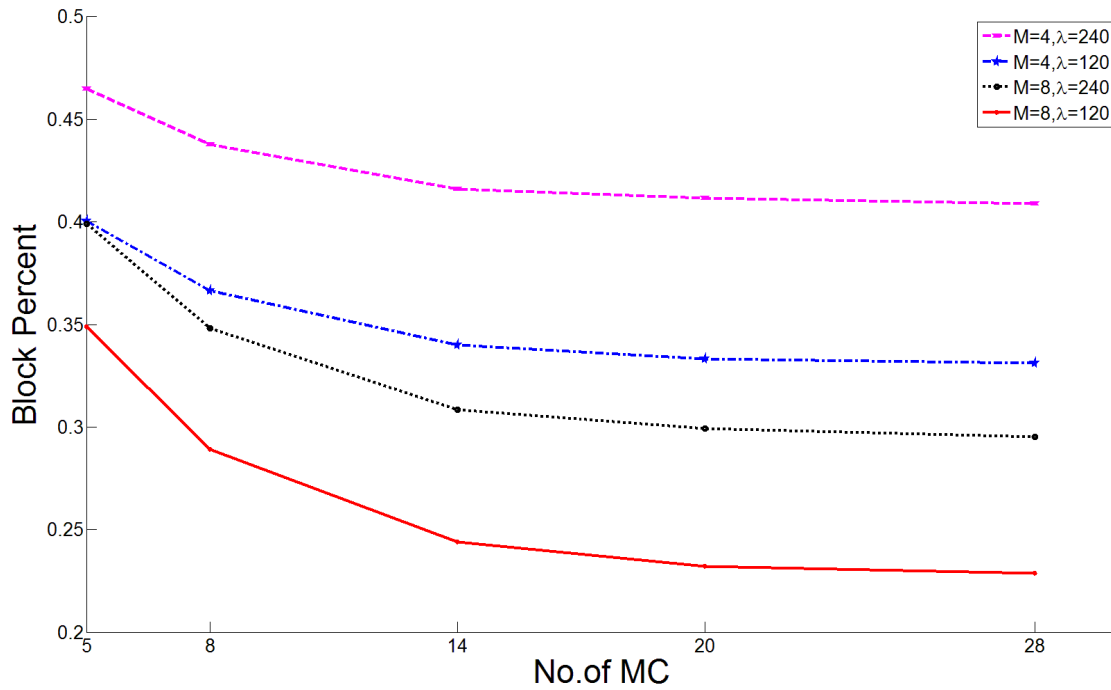

Figure 4.6 : Blocking Percentage of HRN versus Number of MC, Various λ , and M

4.1.3 Mode-Wavelength Converter Performance

In the two previous subsections of this chapter, we investigate the case of placing either a given number of WC or MC. We now consider the case of using both of them as MWC. We run simulation tests with a different numbers of MWC placed on the US Long Haul network's nodes under the load of 120 Erlang and $M=6, W=12$, and measure the blocking percentage for every simulation case. The comparison results of the performance of RDP, HBP, K-DS, HYB, and HRN algorithms are plotted in Figures 4.7, and 4.8.

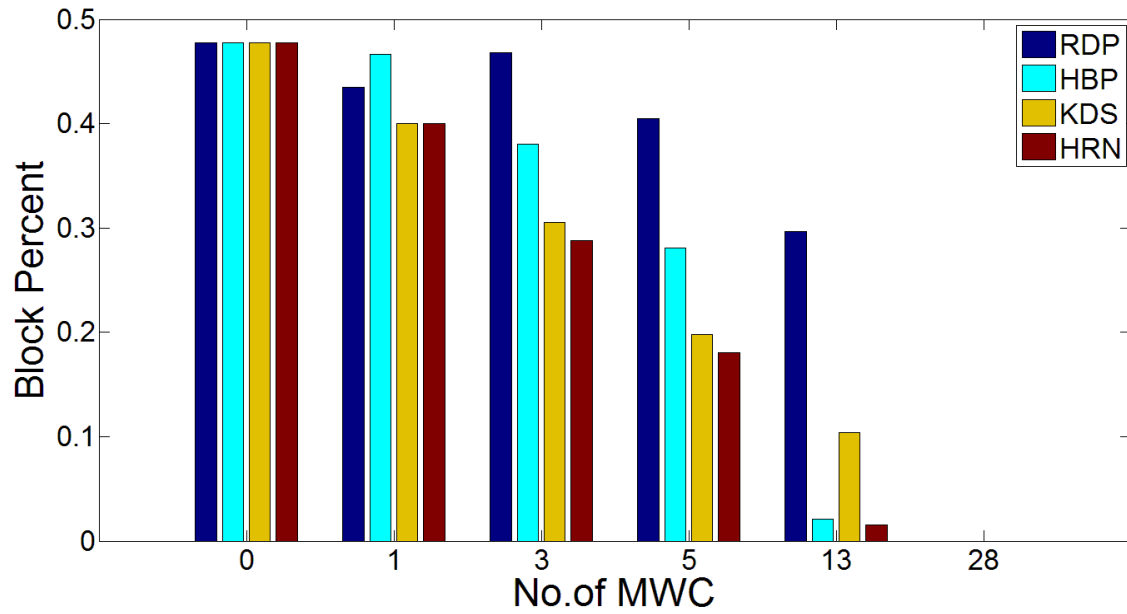

Figure 4.7 : RDP, HBP, K-DS, HRN Comparison using Different Numbers of MWC

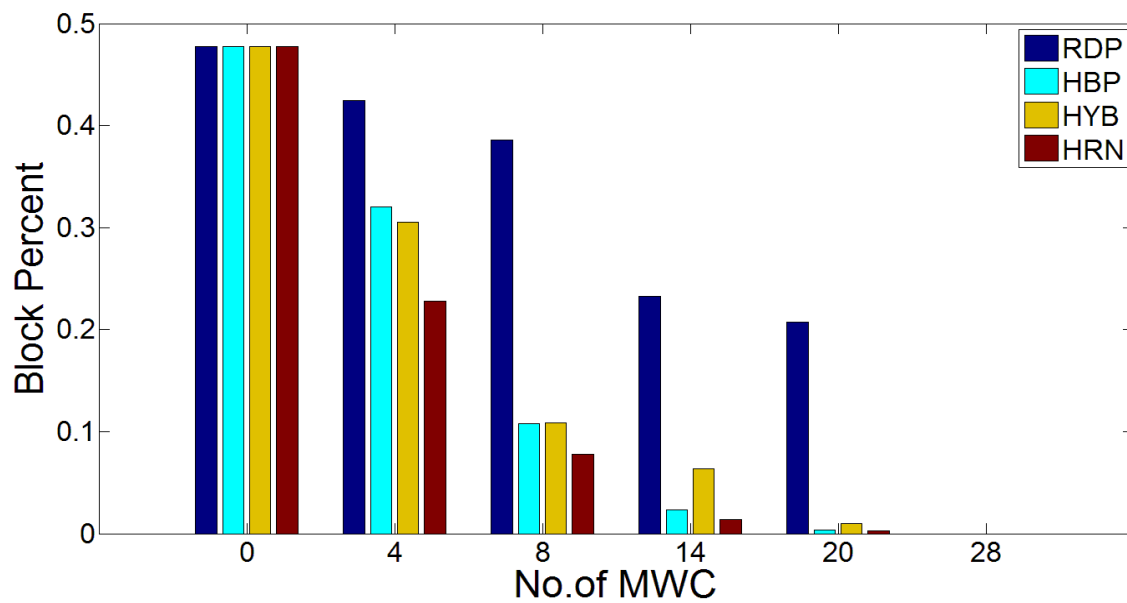

Figure 4.8 : RDP, HBP, HYB, HRN Comparison using Different Numbers of MWC

The results, introduced in Figures 4.7, and 4.8, indicate that there is a large improvement in the blocking performance of the network. The blocking percentage decreases sharply with the increase of the number of MWC until it reaches the perfect results of blocking percentage equaling zero which is associated with the case of deployment full mode-wavelength conversion capability (MWC =28). This can be explained due to the fact that performing modes and wavelengths conversion simultaneously in the network significantly increases the number of the reuse of the M and W and breaks the continuity constraint problem. Furthermore, it prevents the resources of the network, M and W, from being exhausted quickly and supports more loads through supporting a higher number of lightpaths to be established and be assigned a free M and W. In addition, the results of Figures 4.7, and 4.8, demonstrate the importance of having well designed converter placement heuristics compared with the performance of random placement. Furthermore, these results illustrate the performance of HRN algorithm and confirm that indeed our HRN heuristic always provides the lowest blocking percentages among all the other aforementioned heuristics.

The cases of using HRN algorithm and applying different loads and variable network resources ,M and W, are also investigated. Unlike the previous performance tests of WC or MC, in this set of simulations, the fiber links of the network are assumed to support variable modes and wavelengths. The results of simulating the following cases: (i) Load (λ) = 120 Erlang, W=8, and M=4 , (ii) Load (λ) = 120 Erlang, W=16, and M=8, (iii) Load (λ) = 240 Erlang, W=8, and M=4, and (iv) Load (λ) = 240 Erlang, W=16, and M=8, are presented in Figure 4.9.

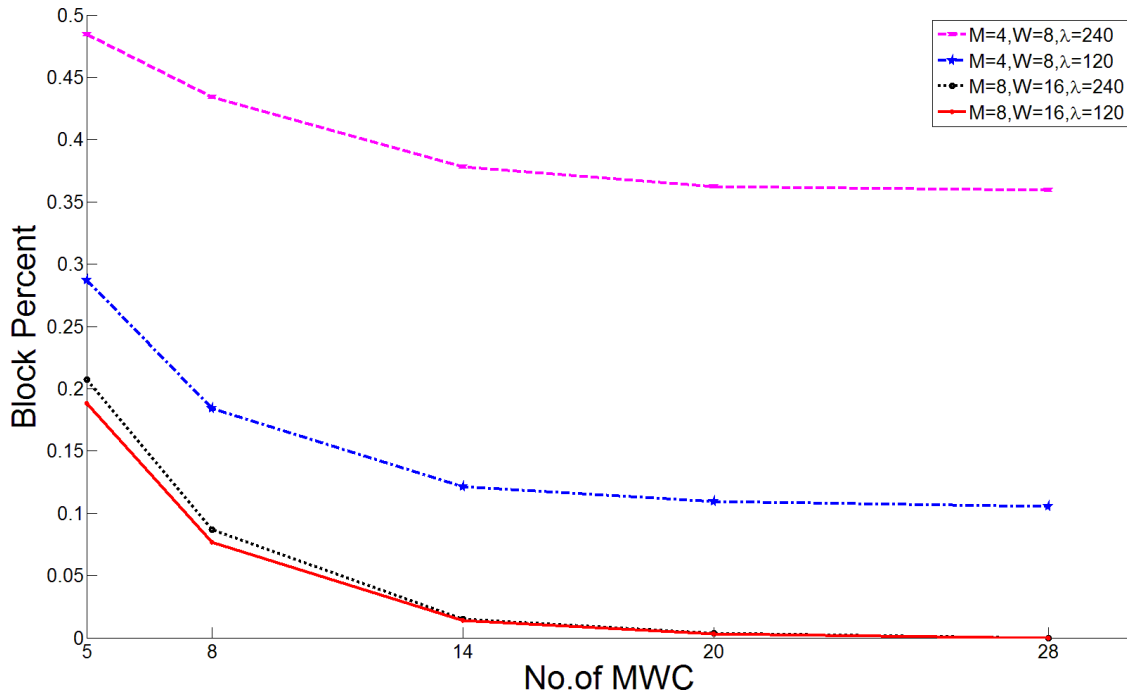

Figure 4.9 : Blocking Percentage of HRN versus Number of MWC, Various λ , and M,W

The performance of mode-wavelength converters (MWC) in optical networks that support Mode and Wavelength is the best. The aforementioned results in the previous subsections of this chapter indicate that performing both M and W conversion at the same time in the network produces the best network performance improvement in terms of blocking percentage. This better performance is not only achieved for the case of increasing the number of converter but also under different applied loads and variable network resources. To confirm the superiority of MWC, a set of results that compare the performance of MC, WC, and MWC under variable loads and different number of converters are presented below. Figure 4.10 shows the blocking

percentage versus the load using HRN to place separately five MCs, WCs and MWCs. In Figure 4.11 we use 13converters, whereas in Figure 4.12 we use 20 converters.

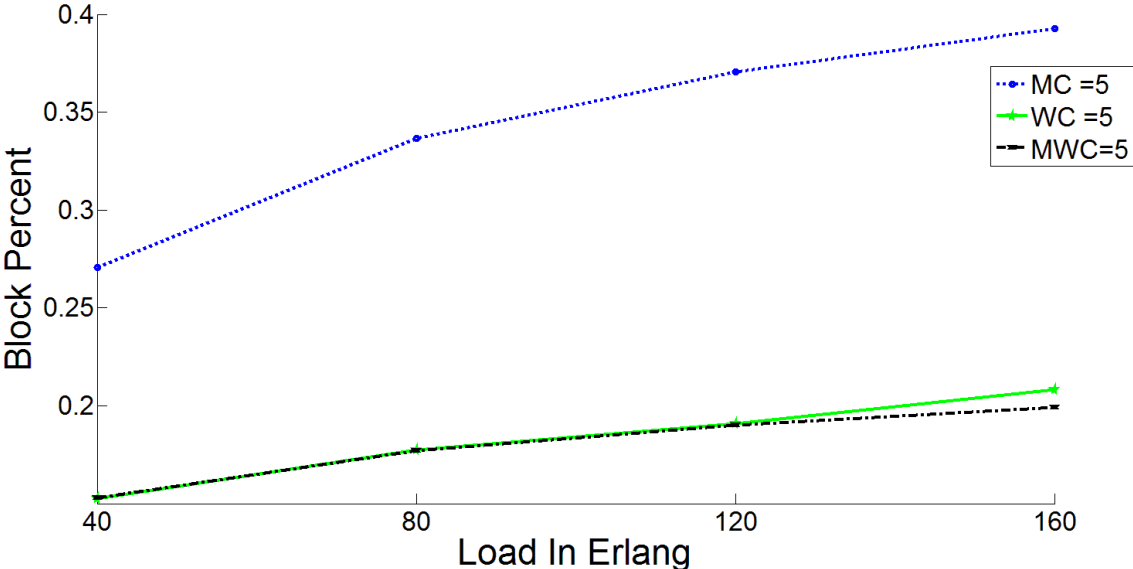

Figure 4.10 : Blocking Percentage of HRN versus Loads, MC = WC = MWC = 5

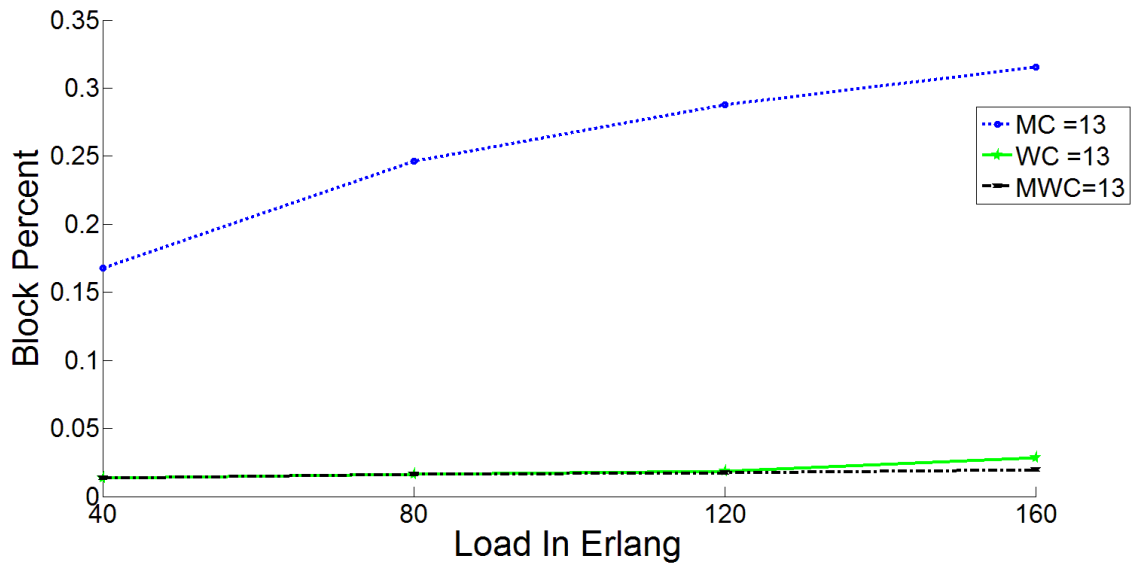

Figure 4.11 : Blocking Percentage of HRN versus Loads, MC = WC = MWC = 13

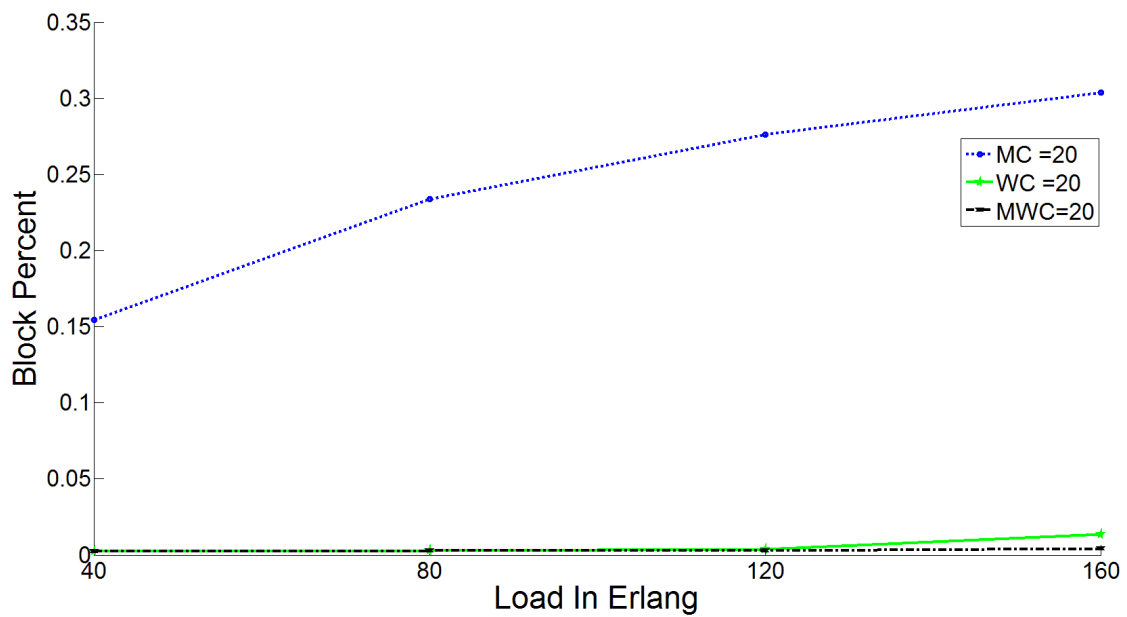

Figure 4.12 : Blocking Percentage of HRN versus Loads, MC = WC = MWC = 20

4.2 Simulation Results and Discussion, *Toronto Metropolitan Network*

To this end, the simulation results that were presented for the US Long Haul topology in the previous section 4.1 have proved that HRN heuristic always provides the best blocking performance among other placement heuristics. Now, another set of simulations is carried out to investigate the behavior of RDP, HBP, K-DS, HYB, and HRN converters placement heuristics over Toronto Metropolitan topology with 25 nodes and 55 fiber links as shown in Figure 3.1(b). The performance results of wavelength converters (WC), mode converters (MC), and mode-wavelength converters (MWC) are plotted in Figures 4.13, 4.14, and 4.15 respectively. For these tests, each fiber link is assumed to support $W=12$, and $M=6$ under load = 120 Erlang.

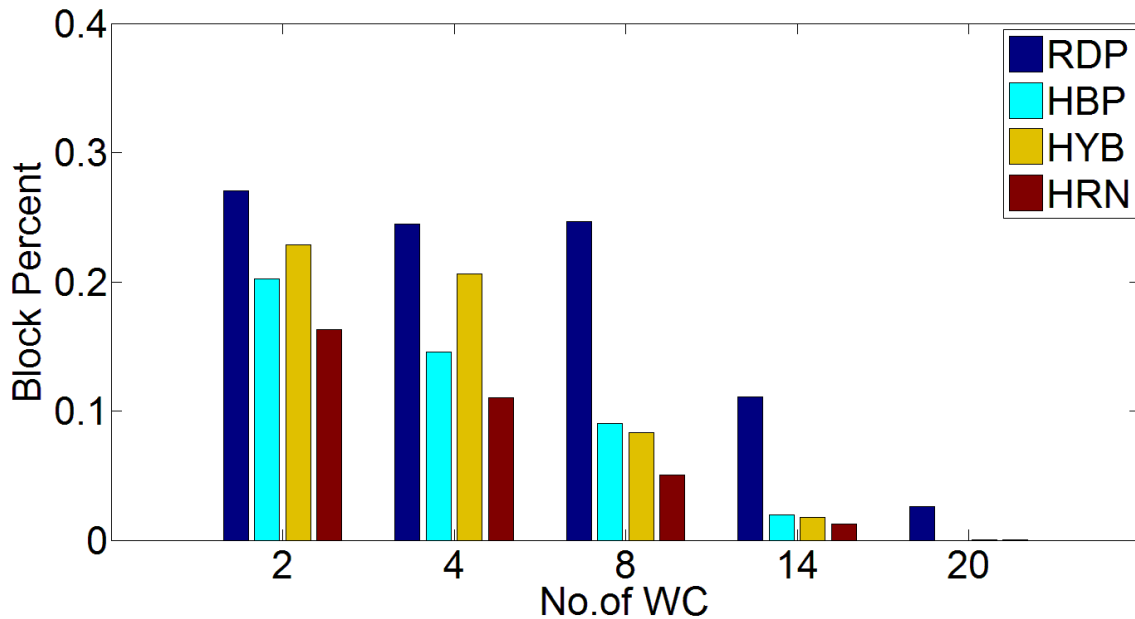

Figure 4.13 : Toronto Metropolitan, Placement of WC using RDP, HBP, HYB, and HRN

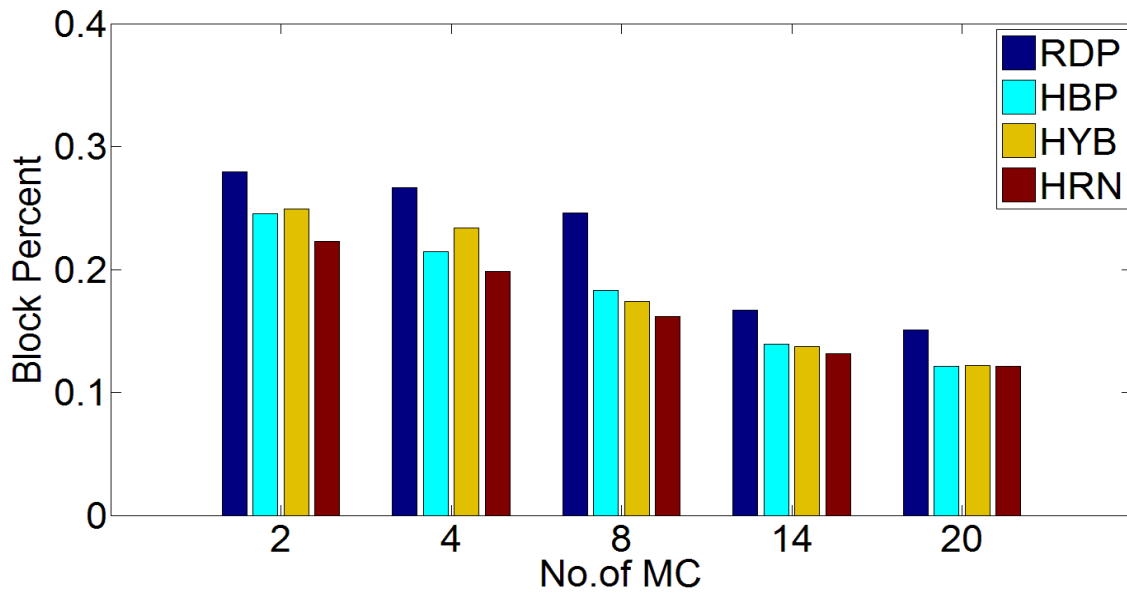

Figure 4.14 : Toronto Metropolitan, Placement of MC using RDP, HBP, HYB, and HRN

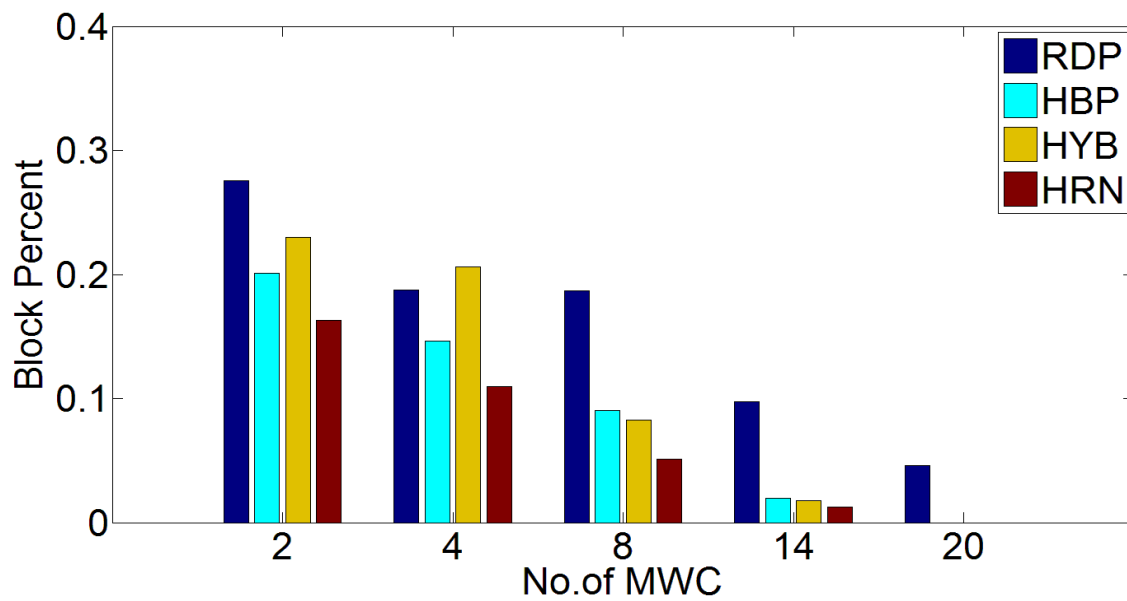

Figure 4.15 : Toronto Metropolitan, Placement of MWC using RDP, HBP, HYB, and HRN

Although, the results of the K-DS placement heuristic are not shown separately in the Figures 4.13, 4.14, and 4.15, the performance results of the three types of converters using K-DS are included in the results associated with HYB heuristic for the cases of 1-DS with 4 converters, and 2-DS with 2 converters. It can be inferred from the results presented in Figures 4.13, 4.14, and 4.15 that the overall blocking performance of all the placement heuristics on the Toronto Metropolitan network is better than the corresponding results of US Long Haul. The average of the blocking percentages of the US Long Haul networks could reach the level of 30% while the highest blocking percentage of the Toronto Metropolitan network does not exceed the level of 28%. This can be explained by the fact that the Toronto Metropolitan is a smaller and denser network compared with the US Long Haul, thus the paths between any random source-destination pair are shorter than those in US Long Haul, which allows the data to reach its destination using less network resources (M, W) and smaller number of conversion operations. It can be also observed that the perfect performance of zero blocking percentage in the Toronto Metropolitan network can be achieved without the need to occupy each node in the network with a converter as shown in Figure 4.15 in the case of $MWC=20$. Therefore, the denser the network, the higher is the utilization gain of the converter. Furthermore, HRN provides a better blocking performance for the Toronto Metropolitan network, and these results have proved the effectiveness of the HRN compared to the other heuristics.

4.3 Simulation Results and Discussion, 5 x 5 Mesh- Tours

The topology of 5 x 5 Mesh- Tours is also used to evaluate the performance of WC, MC, and MWC using RDP, HBP, K-DS, HYB, and HRN heuristics. A set of simulations is implemented under a load of 120 Erlang. In these simulations, each fiber link is assumed to have $M=6$, and $W=12$. Figures 4.16, 4.17, and 4.18 show the results of the blocking percentage versus the number of converters. Similar to the US Long Haul and Toronto Metropolitan networks, these results have confirmed the superiority of HRN to achieve the minimum blocking percentage for the three different topologies used in this thesis. It can be seen from the results that there is no significant difference between the performance of HRN, and HBP. However, HRN always provides the lowest blocking percentages.

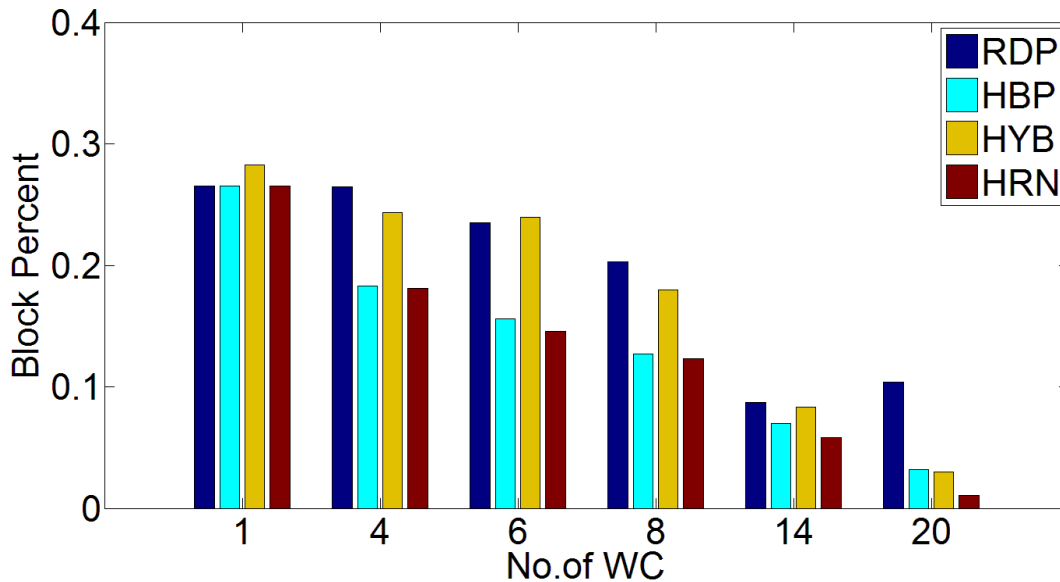

Figure 4.16 : 5 x 5 Mesh- Tours, Placement of WC using RDP, HBP, HYB, and HRN

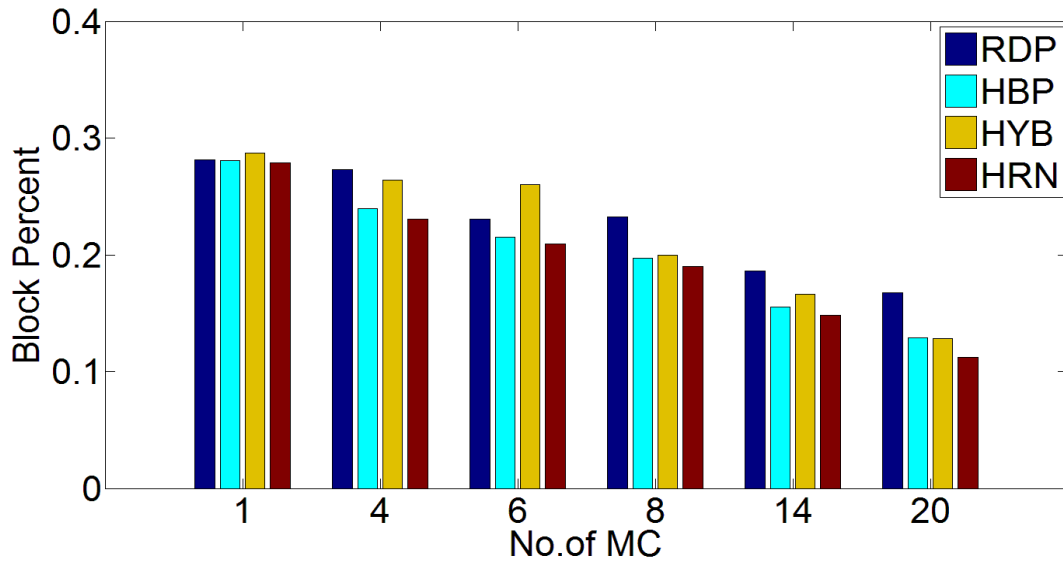

Figure 4.17 : 5 x 5 Mesh- Tours, Placement of MC using RDP, HBP, HYB, and HRN

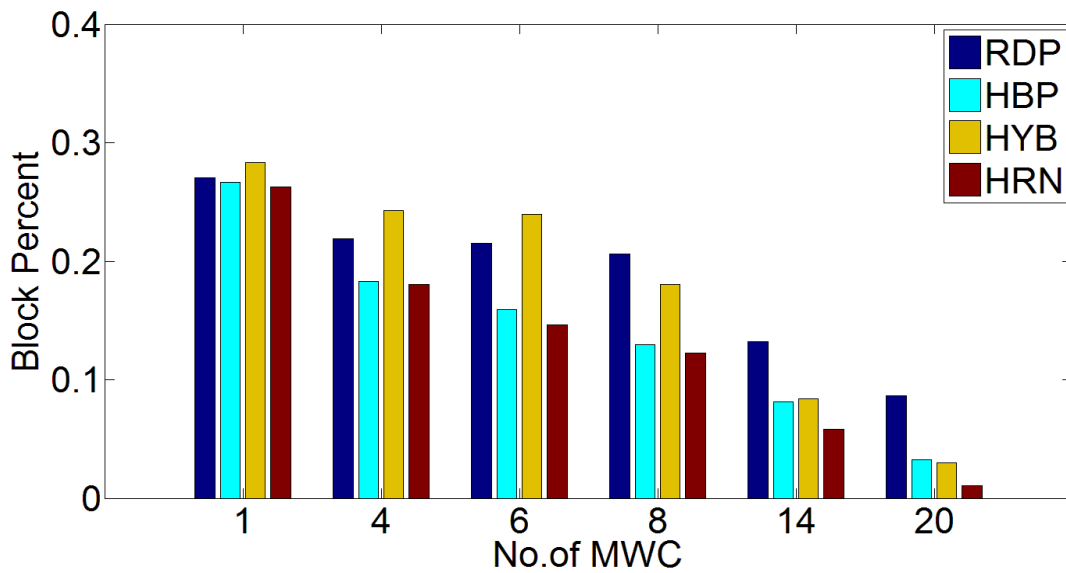

Figure 4.18 : 5 x 5 Mesh- Tours, Placement of MWC using RDP, HBP, HYB, and HRN

CHAPTER 5 CONCLUSION

In this chapter we conclude the work presented in this thesis and summarize our finding and observations. We also discuss the possible future investigation areas and the ideas to extend this research.

In this thesis, we identified the problem of continuity constraint and its drawbacks that affect the blocking performance of WDM optical networks. We also illustrated that occupying each node in the network with wavelength converter relaxes this problem but adds a high cost and complexity to the network and produces a performance delay. Thus, several heuristic algorithms have been proposed to allocate wavelength converters partially in the network without remarkably affecting its blocking percentage. The aim of this research is to investigate the problem of complete conversion converter placement on the MWDM networks. Therefore, we studied, analyzed, and implemented four existing wavelength converter placement heuristics, namely, Random placement (RDP), High Blocking placement (HBP), K-DS placement (K-DS), and HYBRID placement (HYB) and extended them to place mode converters (MC), wavelength converters (WC), and combined mode-wavelength converters (MWC).

Furthermore, we addressed the problem of how optimally placing a limited number of MC, WC, and MWC by introducing and implementing a new and effective complete conversion converter placement heuristic, namely, Highest Request Node (HRN). The approach of HRN heuristic considers the number of communications between the nodes in the network, and places the

converters on the nodes receiving the highest volume of connection requests. Consequently the HRN heuristic is a simulation- based and uses only the traffic at each node as an input.

Subsequently, we provided comparison results among the converter placement methods. We extensively carried out a simulation performance tests over three different topologies, namely, US Long Haul, Toronto Metropolitan, and 5 x 5 Mesh-Tours to prove the effectiveness of HRN algorithm, and presented their results. The simulation results demonstrated that the utilization gain of a converter depends on its position in the network. In addition, a limited number of converters, optimally placed on the network, can significantly improve the blocking performance. This converter effectiveness is also shown to depend on the type of the converter, the amount of the available resources, the topology, and the traffic load in the network. The presented results demonstrated that performance of MWC in MWDM network provides a better blocking percentage than WC or MC.

HRN was proved to provide the least blocking percentages among the other placement heuristics for all types of converters and over all three topologies that were used in this thesis. HRN was also shown to produce a near optimal blocking performance results. As an example, for the US Long Haul network under a load in Erlang = 120, HRN utilized only 8 MWC, equivalent to around 28% of the networks nodes, to achieve almost 84% improvement in the blocking percentage. Similarly, for the Toronto Metropolitan network, HRN needed only 14 MWC, equivalent to around 56% of the networks nodes, to achieve perfect performance with zero

blocking percentage. Moreover, by applying HRN on the 5 x 5 Mesh-Tours network, 96% improvement in blocking percentage is obtained using only 20 MWC.

The work of this research can be developed to work with other efficient optical network algorithms such as Just Enough Time (JET) scheduling method, and dynamic wavelength and mode assignment, over other fixed and arbitrary network topologies. Furthermore, the results that were obtained in this thesis can be utilized in future research works to understand the behavior of the suggested MWDM optical networks. One possible future research idea is to place the converters in the network based on their cost not on their number. To implement this idea, HRN needs to be extended to consider the cost of the different types of converters and place MC, WC, and MWC simultaneously in the MWDM networks so that a better blocking performance can be achieved by a lower cost. Finally, another possible way of future work is to investigate the problem of limited conversion capability converters in MWDM networks.

LIST OF REFERENCES

- [1] S. Subramaniam, M. Azizoglu, and A. K. Somani, "On optimal converter placement in wavelength-routed networks," *Networking, IEEE/ACM Transactions on*, vol.7, no.5, pp.754-766.
- [2] T. Stern and K. Bala, "Multiwavelength optical networks: A layered approach Addison-Wesley," Reading, Mass.
- [3] A. Soares, J. Maranhao, W. Giozza, and P. Cunha, "First load priority: A wavelength converter placement scheme for optical networks," *Revista Brasileira de Redes de Computadores e Sistemas Distribuídos*, pp.23-36.
- [4] G. N. Rouskas, "Routing and wavelength assignment in optical WDM networks," *Encyclopedia of Telecommunications*.
- [5] B. Ramamurthy and B. Mukherjee, "Wavelength conversion in WDM networking,".
- [6] B. Mukherjee, *Optical communication networks*, McGraw-Hill New York, 1997.
- [7] K. Lee and V. O. Li, "Routing and switching in a wavelength convertible optical network," *INFOCOM'93. Proceedings. Twelfth Annual Joint Conference of the IEEE Computer and Communications Societies. Networking: Foundation for the Future*, IEEE, pp.578-585.
- [8] M. El Houmaidi, *Resource allocation schemes and performance evaluation models for wavelength division multiplexed optical networks*.
- [9] J. M. Yates, M. P. Rumsewicz, and J. P. Lacey, "Wavelength converters in dynamically-reconfigurable WDM networks," *Communications Surveys & Tutorials, IEEE*, vol.2, no.2, pp.2-15.
- [10] X. Jia, D. Du, X. Hu, H. Huang, and D. Li, "Placement of wavelength converters for minimal wavelength usage in WDM networks," *INFOCOM 2002. Twenty-First Annual Joint Conference of the IEEE Computer and Communications Societies. Proceedings. IEEE*, pp.1425-1431.
- [11] J. Iness and B. Mukherjee, "Sparse wavelength conversion in wavelength-routed WDM optical networks*," *Photonic Network Communication*, vol.1, no.3, pp.183-205.
- [12] T. De, A. K. Pathak, and A. Pal, "An efficient heuristic-based algorithm for wavelength converter placement in all-optical networks," *Telecommunications and Malaysia International*

Conference on Communications, 2007. ICT-MICC 2007. IEEE International Conference on, pp.186-190.

[13] D. Li and X. Jia, "Allocating wavelength converters in shared-per-link structure in WDM networks," IEE Proceedings-Communications, vol.149, no.3, pp.185-188.

[14] M. Houmaidi and M. A. Bassiouni, "Dependency-based analytical model for computing connection blocking rates and its application in the sparse placement of optical converters," Communications, IEEE Transactions on, vol.54, no.1, pp.159-168.

[15] R. Essiambre, G. Kramer, P. J. Winzer, G. J. Foschini, and B. Goebel, "Capacity limits of optical fiber networks," Lightwave Technology, Journal of, vol.28, no.4, pp.662-701.

[16] S. Tariq, M. Bassiouni, and G. Li, "Improving fairness of OBS routing protocols in multimode fiber networks," Proceedings of the 2013 International Conference on Computing, Networking and Communications (ICNC), pp.1146-1150.

[17] N. Bai, E. Ip, Y. Huang, E. Mateo, F. Yaman, M. Li, S. Bickham, S. Ten, J. Liñares, and C. Montero, "Mode-division multiplexed transmission with inline few-mode fiber amplifier," Optics express, vol.20, no.3, pp.2668-2680.

[18] P. Sillard, M. Astruc, D. Boivin, H. Maerten, and L. Provost, "Few-mode fiber for uncoupled mode-division multiplexing transmissions," European Conference and Exposition on Optical Communications, pp.Tu. 5. LeCervin. 7.

[19] N. Hanzawa, K. Saitoh, T. Sakamoto, T. Matsui, S. Tomita, and M. Koshiba, "Demonstration of mode-division multiplexing transmission over 10 km two-mode fiber with mode coupler," Optical Fiber Communication Conference & Exposition (OFC/NFOEC), 2011 & the National Fiber Optic Engineers Conference, pp.1, 01.

[20] C. Koebele, M. Salsi, L. Milord, R. Ryf, C. A. Bolle, P. Sillard, S. Bigo, and G. Charlet, "40km transmission of five mode division multiplexed data streams at 100Gb/s with low MIMO-DSP complexity," European Conference and Exposition on Optical Communications, pp.Th. 13. C. 3.

[21] E. Ip, M. Li, Y. Huang, A. Tanaka, E. Mateo, W. Wood, J. Hu, Y. Yano, and K. Koreshkov, "146λx6x19-gbaud wavelength-and mode-division multiplexed transmission over 10x50-km spans of few-mode fiber with a gain-equalized few-mode EDFA," Optical Fiber Communication Conference, pp.PDP5A. 2.

[22] M. El Houmaidi and M. A. Bassiouni, "K-weighted minimum dominating sets for sparse wavelength converters placement under nonuniform traffic," Modeling, Analysis and Simulation

of Computer Telecommunications Systems, 2003. MASCOTS 2003. 11th IEEE/ACM International Symposium on, pp.56-61.

[23] S. S. Subramaniam, M. Azizoglu, and A. K. Somani, "All-optical networks with sparse wavelength conversion," *Networking, IEEE/ACM Transactions on*, vol.4, no.4, pp.544-557.

[24] S. Subramaniam, M. Azizoglu, and A. K. Somani, "On the optimal placement of wavelength converters in wavelength-routed networks," *INFOCOM'98. Seventeenth Annual Joint Conference of the IEEE Computer and Communications Societies. Proceedings. IEEE*, pp.902-909.

[25] K. Lee and V. O. Li, "A wavelength-convertible optical network," *Lightwave Technology, Journal of*, vol.11, no.5, pp.962-970.

[26] K. Venugopal, M. Shiva Kumar, and P. Sreenivasa Kumar, "A heuristic for placement of limited range wavelength converters in all-optical networks," *Computer Networks*, vol.35, no.2, pp.143-163.

[27] J. Yates, J. Lacey, D. Everitt, and M. Summerfield, "Limited-range wavelength translation in all-optical networks," *INFOCOM'96. Fifteenth Annual Joint Conference of the IEEE Computer Societies. Networking the Next Generation. Proceedings IEEE*, pp.954-961.

[28] M. El Houmaidi, M. Bassiouni, and G. Li, "Algorithm for placement of limited wavelength conversion in WDM optical networks," *ITCom 2003*, pp.185-195.

[29] K. Lu, G. Xiao, and I. Chlamtac, "Behavior of distributed wavelength provisioning in wavelength-routed networks with partial wavelength conversion," *INFOCOM 2003. Twenty-Second Annual Joint Conference of the IEEE Computer and Communications. IEEE Societies*, pp.1816-1825.

[30] X. Chu, B. Li, and Z. Zhang, "Sparse-partial wavelength conversion in wavelength-routed all-optical networks," *OptiComm 2003: Optical Networking and Communications*, pp.278-289.

[31] X. Chu, J. Liu, and Z. Zhang, "Analysis of sparse-partial wavelength conversion in wavelength-routed WDM networks," *INFOCOM 2004. Twenty-third Annual Joint Conference of the IEEE Computer and Communications Societies*, pp.1363-1371.

[32] X. Chu, B. Li, and I. Chlamtac, "Wavelength converter placement under different RWA algorithms in wavelength-routed all-optical networks," *Communications, IEEE Transactions on*, vol.51, no.4, pp.607-617.

- [33] K. Venugopal, E. E. Rajan, and P. S. Kumar, "Performance analysis of wavelength converters in WDM wavelength routed optical networks," High Performance Computing, 1998. HIPC'98. 5th International Conference On, pp.239-246.
- [34] S. K. Bose, Y. N. Singh, A. Raju, and B. Popat, "Sparse converter placement in WDM networks and their dynamic operation using path-metric based algorithms," Communications, 2002. ICC 2002. IEEE International Conference on, pp.2855-2859.
- [35] G. Xiao and Y. Leung, "Algorithms for allocating wavelength converters in all-optical networks," Networking, IEEE/ACM Transactions on, vol.7, no.4, pp.545-557.
- [36] S. Thiagarajan and A. K. Somani, "An efficient algorithm for optimal wavelength converter placement on wavelength-routed networks with arbitrary topologies," INFOCOM'99. Eighteenth Annual Joint Conference of the IEEE Computer and Communications Societies. Proceedings. IEEE, pp.916-923.
- [37] A. S. Arora and S. Subramaniam, "Converter placement in wavelength routing mesh topologies," Communications, 2000. ICC 2000. 2000 IEEE International Conference on, pp.1282-1288.
- [38] X. Chu, B. Li, and I. Chlamtac, "Wavelength converter placement for different RWA algorithms in wavelength-routed all-optical networks," ITCOM 2002: The Convergence of Information Technologies and Communications, pp.186-197.
- [39] K. Venugopal, E. E. Rajan, and P. S. Kumar, "Performance analysis of wavelength converters in WDM wavelength routed optical networks," High Performance Computing, 1998. HIPC'98. 5th International Conference On, pp.239-246.
- [40] I. Chlamtac, A. Ganz, and G. Karmi, "Lightpath communications: An approach to high bandwidth optical WAN's," Communications, IEEE Transactions on, vol.40, no.7, pp.1171-1182.
- [41] H. Zang, J. P. Jue, and B. Mukherjee, "A review of routing and wavelength assignment approaches for wavelength-routed optical WDM networks," Optical Networks Magazine, vol.1, no.1, pp.47-60.
- [42] C. Qiao and M. Yoo, "Optical burst switching (OBS)—a new paradigm for an optical internet," Journal of high speed networks, vol.8, no.1, pp.69-84.
- [43] M. Yoo, C. Qiao, and S. Dixit, "Optical burst switching for service differentiation in the next-generation optical internet," Communications Magazine, IEEE, vol.39, no.2, pp.98-104.

[44] B. Zhou and M. A. Bassiouni, "Supporting differentiated quality of service in optical burst switched networks," *Optical Engineering*, vol.45, no.1, pp.015003-015003-12.

[45] J. Y. Wei and R. I. McFarland, "Just-in-time signaling for WDM optical burst switching networks," *J.Lightwave Technol.*, vol.18, no.12, pp.2019.