

STARS

University of Central Florida
STARS

[UCF Patents](#)

[Technology Transfer](#)

4-19-2011

Fast Response Liquid Crystal Mode. DIV.B

Shin-Tson Wu
University of Central Florida

Wing Choi
University of Central Florida

Find similar works at: <https://stars.library.ucf.edu/patents>
University of Central Florida Libraries <http://library.ucf.edu>

This Patent is brought to you for free and open access by the Technology Transfer at STARS. It has been accepted for inclusion in UCF Patents by an authorized administrator of STARS. For more information, please contact STARS@ucf.edu.

Recommended Citation

Wu, Shin-Tson and Choi, Wing, "Fast Response Liquid Crystal Mode. DIV.B" (2011). *UCF Patents*. 186.
<https://stars.library.ucf.edu/patents/186>





US007929097B1

(12) **United States Patent**
Choi et al.

(10) **Patent No.:** **US 7,929,097 B1**
(45) **Date of Patent:** **Apr. 19, 2011**

(54) **FAST RESPONSE LIQUID CRYSTAL MODE**

(75) Inventors: **Wing Kit Choi**, Taipei (TW); **Shin-Tson Wu**, Oviedo, FL (US)

(73) Assignee: **University of Central Florida Research Foundation, Inc.**, Orlando, FL (US)

(*) Notice: Subject to any disclaimer, the term of this patent is extended or adjusted under 35 U.S.C. 154(b) by 0 days.

(21) Appl. No.: **11/906,081**

(22) Filed: **Sep. 28, 2007**

Related U.S. Application Data

(62) Division of application No. 10/874,481, filed on Jun. 23, 2004, now Pat. No. 7,298,445.

(60) Provisional application No. 60/480,622, filed on Jun. 23, 2003.

(51) **Int. Cl.**
G02F 1/1343 (2006.01)

(52) **U.S. Cl.** **349/141**; 349/130; 349/139

(58) **Field of Classification Search** 349/130,
349/139, 141

See application file for complete search history.

(56) **References Cited**

U.S. PATENT DOCUMENTS

5,128,786	A	7/1992	Yanagisawa	
5,179,460	A	1/1993	Hinata et al.	
5,377,027	A	12/1994	Jelley et al.	
5,781,259	A	7/1998	Shinomiya et al.	
6,005,650	A	12/1999	Kim et al.	
6,031,593	A	2/2000	Morikawa et al.	
6,181,402	B1 *	1/2001	Shim et al.	349/130
6,724,454	B2	4/2004	Kim et al.	
6,882,395	B2 *	4/2005	Liu	349/141
6,924,876	B2 *	8/2005	Kubo et al.	349/193
7,369,204	B1 *	5/2008	Choi et al.	349/141

OTHER PUBLICATIONS

W. Liu, et al. "21.3: Electro-Optical Performance of a Vertically Aligned LCD Mode Using Electrically Controlled Self-Compensation" SID Digest, 1998, pp. 319-321.

Seung Ho Hong, et al., "Electro-Optic Characteristic of Fringe-Field Switching Mode Depending on Rubbing Direction" Journal of Applied Physics, vol. 39, No. 6A, Jun. 1, 2000, pp. 527-530.

Hajime Nakamura, et al., "Bend Transition in Pi-cell" Journal of Applied Physics, vol. 39, No. 11, Nov. 1, 2000, pp. 6368-6375.

"Electro-Optical Performance of a Vertically Aligned LCD Mode Using Electrically Controlled Self-Compensation," W. Lui et al, SID Digest, 1998, pp. 319-321.

"Electro-Optic Characteristic of Fringe-Field Switching Mode Depending on Rubbing Direction," S.H. Hong et al, Journal of Applied Physics vol. 39, No. 6A, Jun. 1, 2000, pp. 527-530.

"Bend Transition in Pi-cell," H. Nakamura et al, Journal of Applied Physics vol. 39, No. 11, Nov. 11, 2000, pp. 6368-6375.

* cited by examiner

Primary Examiner — Michael H Caley

(74) *Attorney, Agent, or Firm* — Brian S. Steinberger; Phyllis K. Wood; Law Offices of Brian S. Steinberger, P.A.

(57) **ABSTRACT**

A novel nematic liquid crystal (LC) mode is based on the Fringing-Field-Switching of Vertically-Aligned liquid crystals. The VA-FFS mode is capable of generating very fast optical modulation without the use of very thin cell gap. A major feature of this LC mode is that it has unusual fast relaxation time compared with the conventional nematic LC modes that require a thin cell gap. This fast relaxation occurs even at very low applied voltages and the operation is very stable. The fast-response mechanism of this LC mode involves the confinement of liquid crystal molecular switching within self-imposed thin LC layers. The present invention provides a novel approach to overcome the fundamental problem of the long relaxation time of the conventional nematic liquid crystal modes.

10 Claims, 25 Drawing Sheets

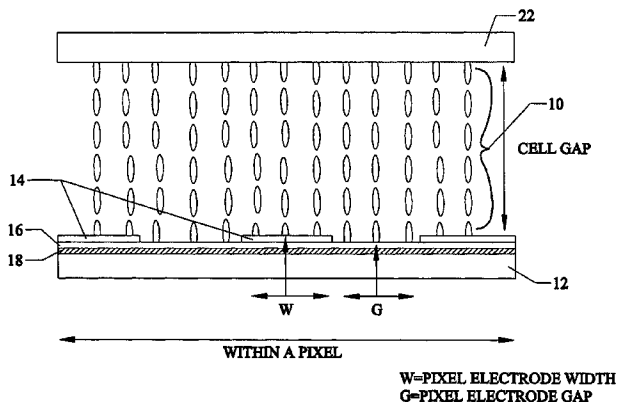

Fig. 1

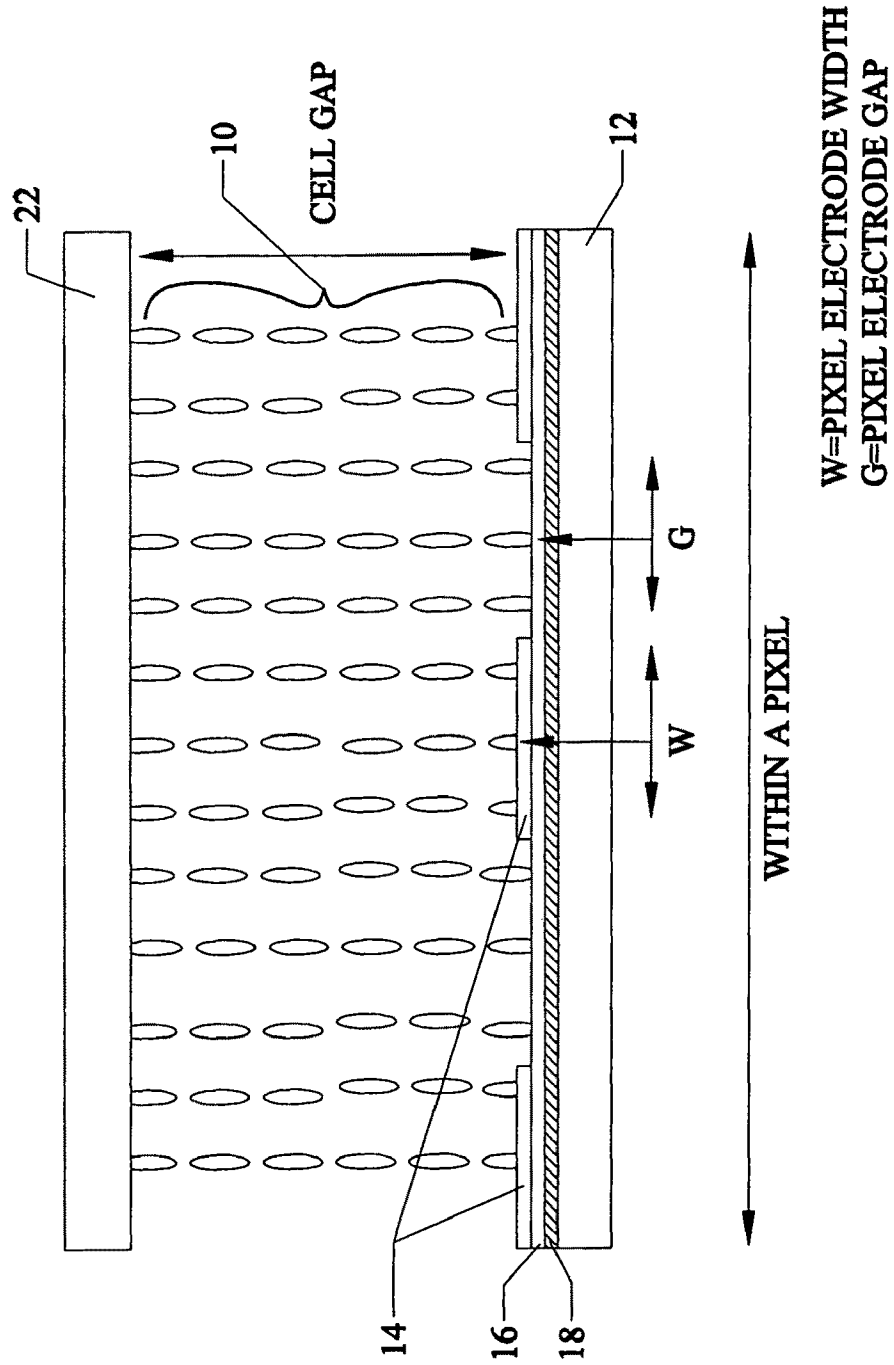

Fig. 2

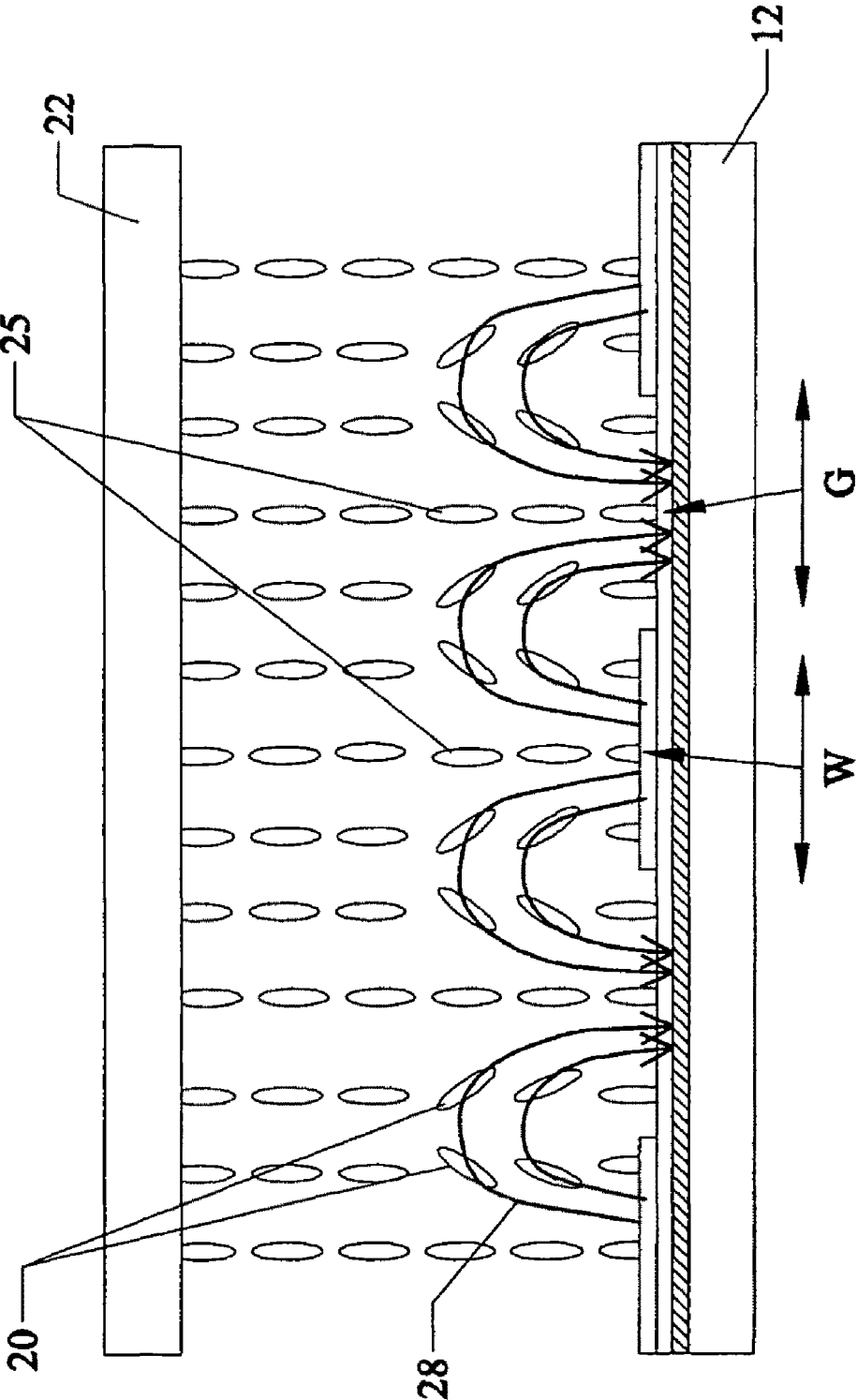

Fig. 3

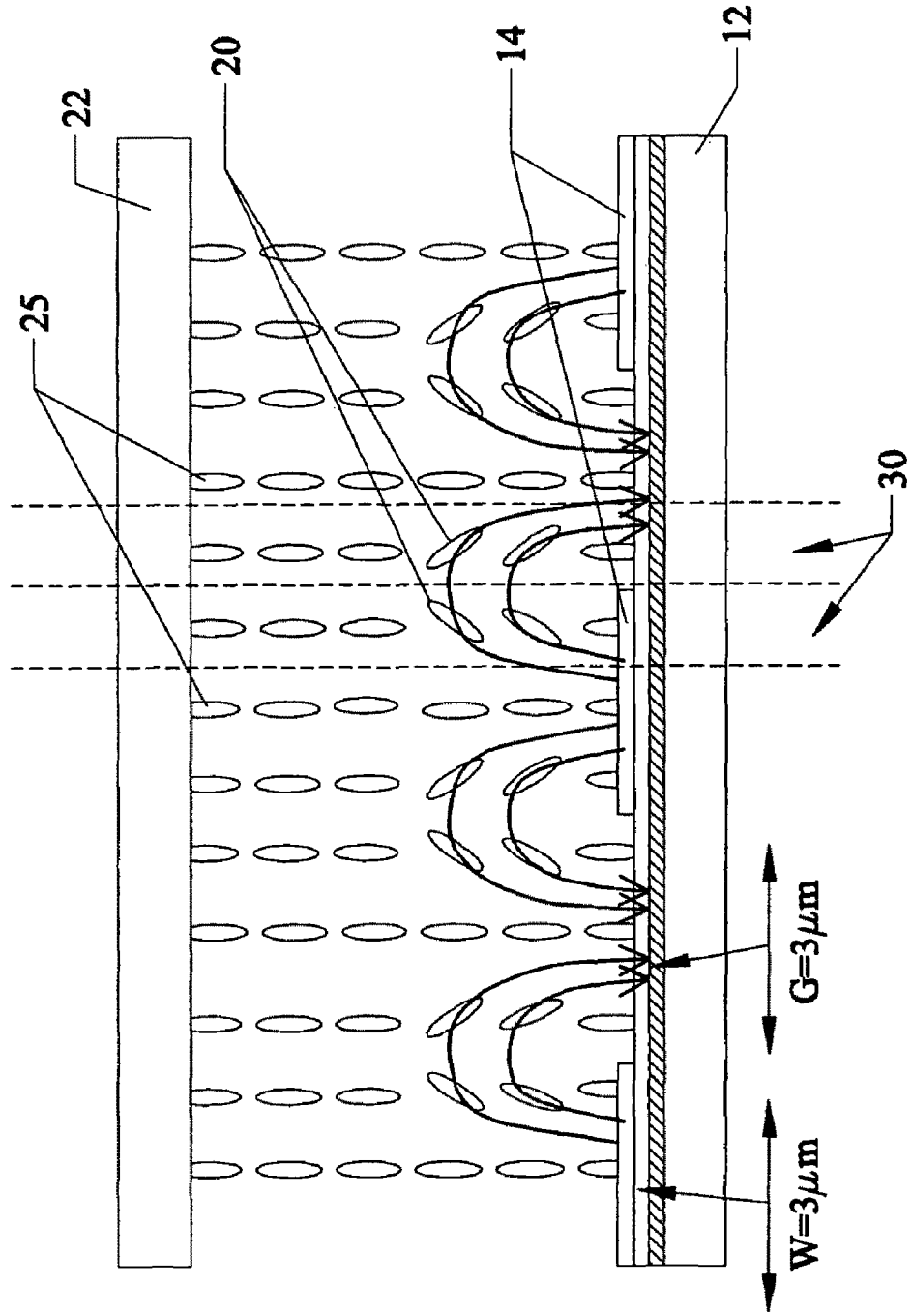
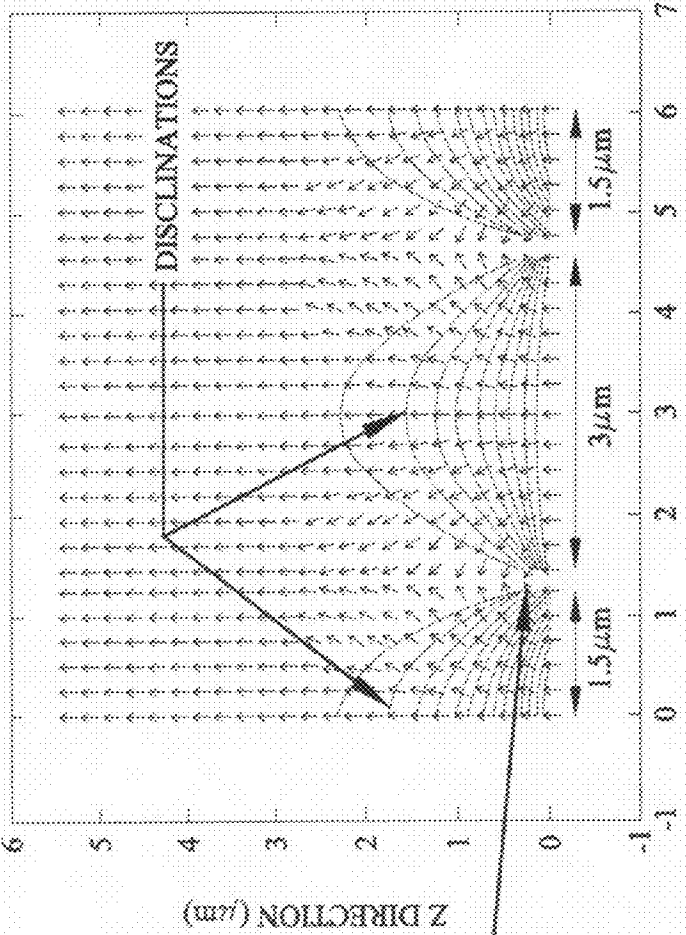
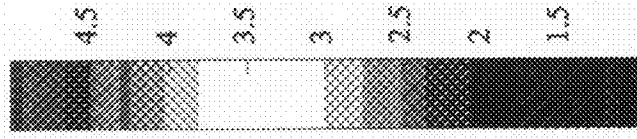

Fig. 4

$W=0.3\mu\text{m}$, $d=5.5\mu\text{m}$, $5V$

DIRECTOR DISTRIBUTION - SIDE VIEW, MAXIMUM VOLTAGE = 5



STRONG ELECTRIC FIELD: SWITCHING IS MUCH LARGER NEAR THE SUBSTRATE

Fig. 5

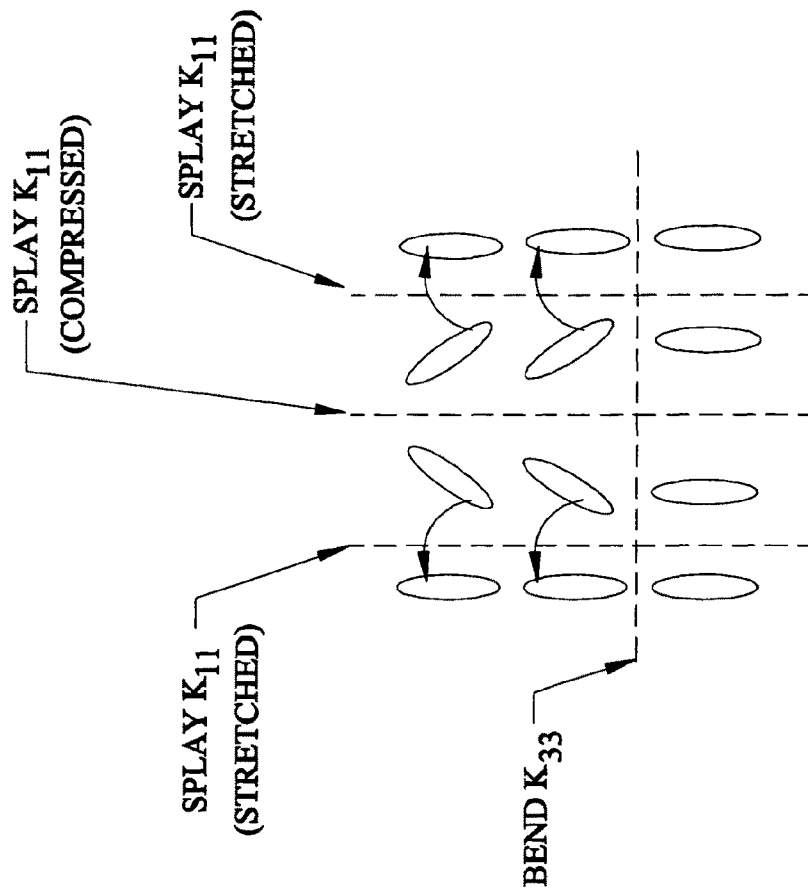

Fig. 6
(PRIOR ART)

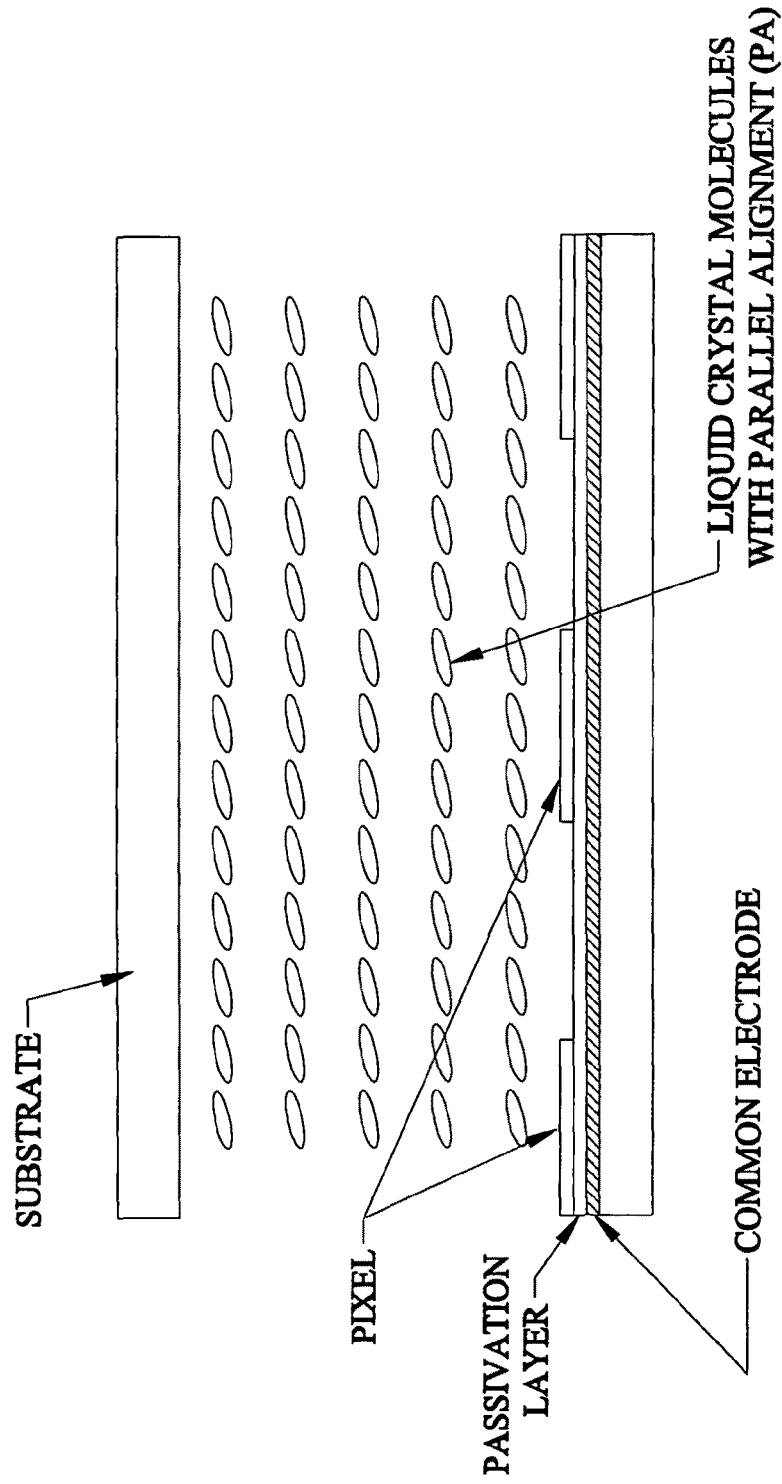

Fig. 7
(PRIOR ART)

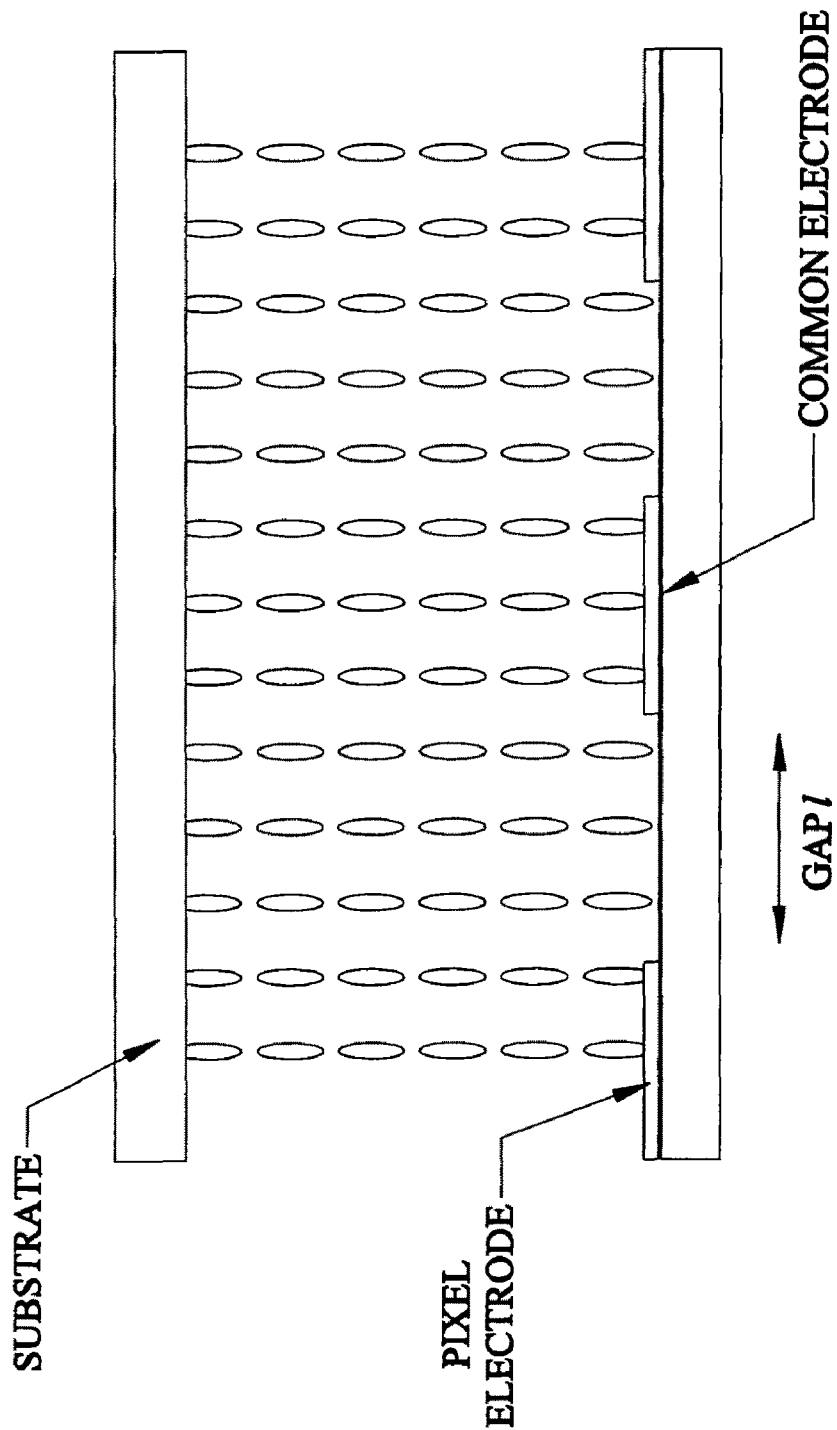

Fig. 8
(PRIOR ART)

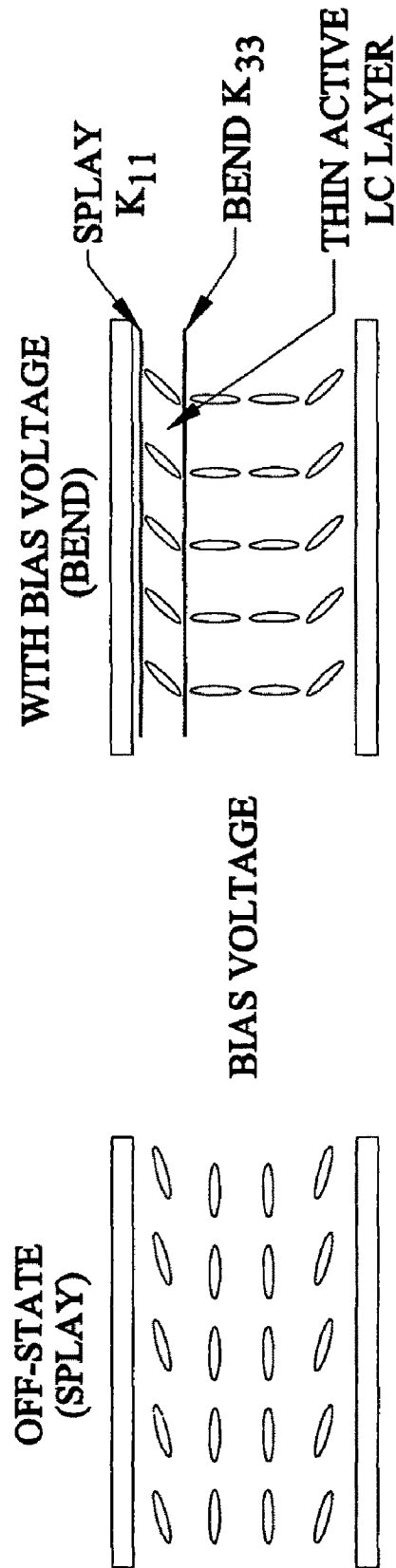

Fig. 9

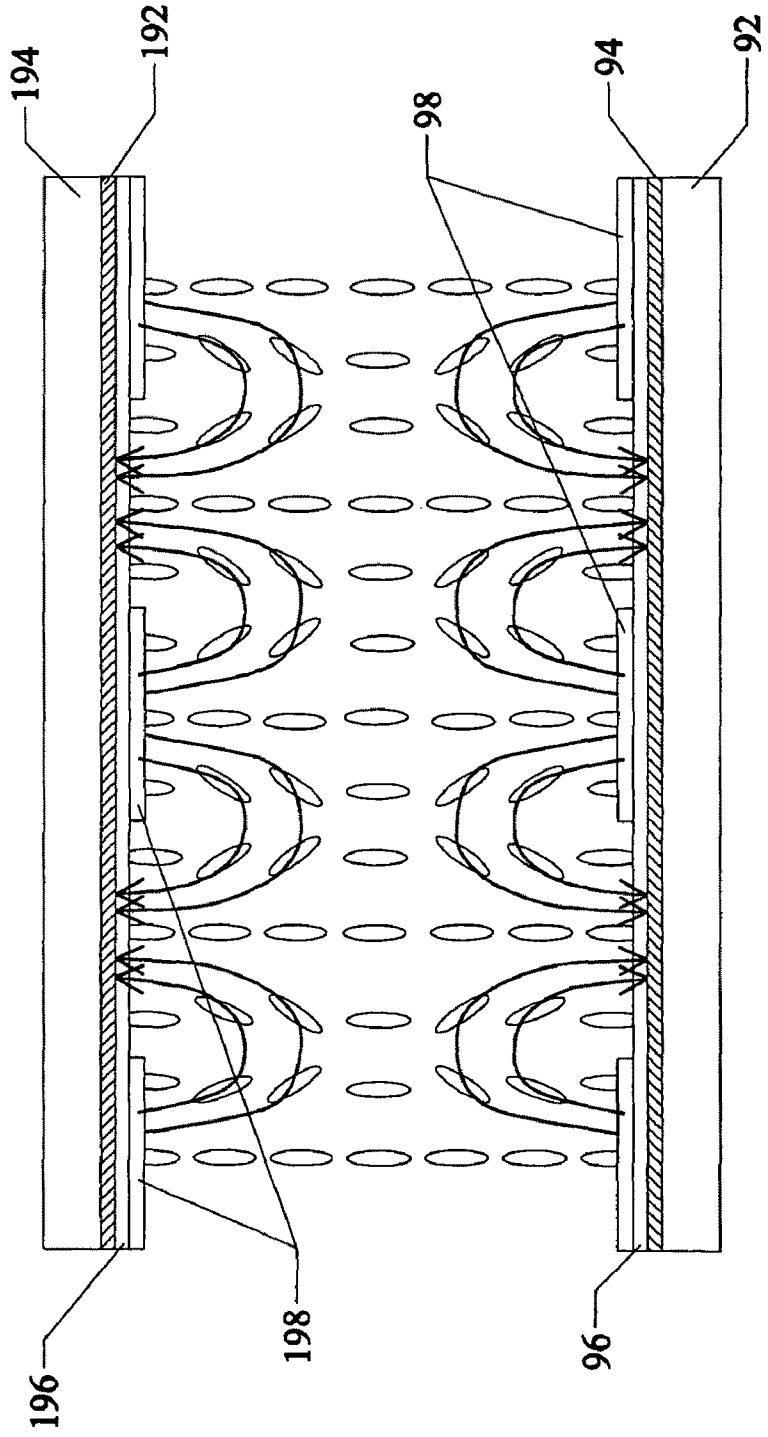

Fig. 10

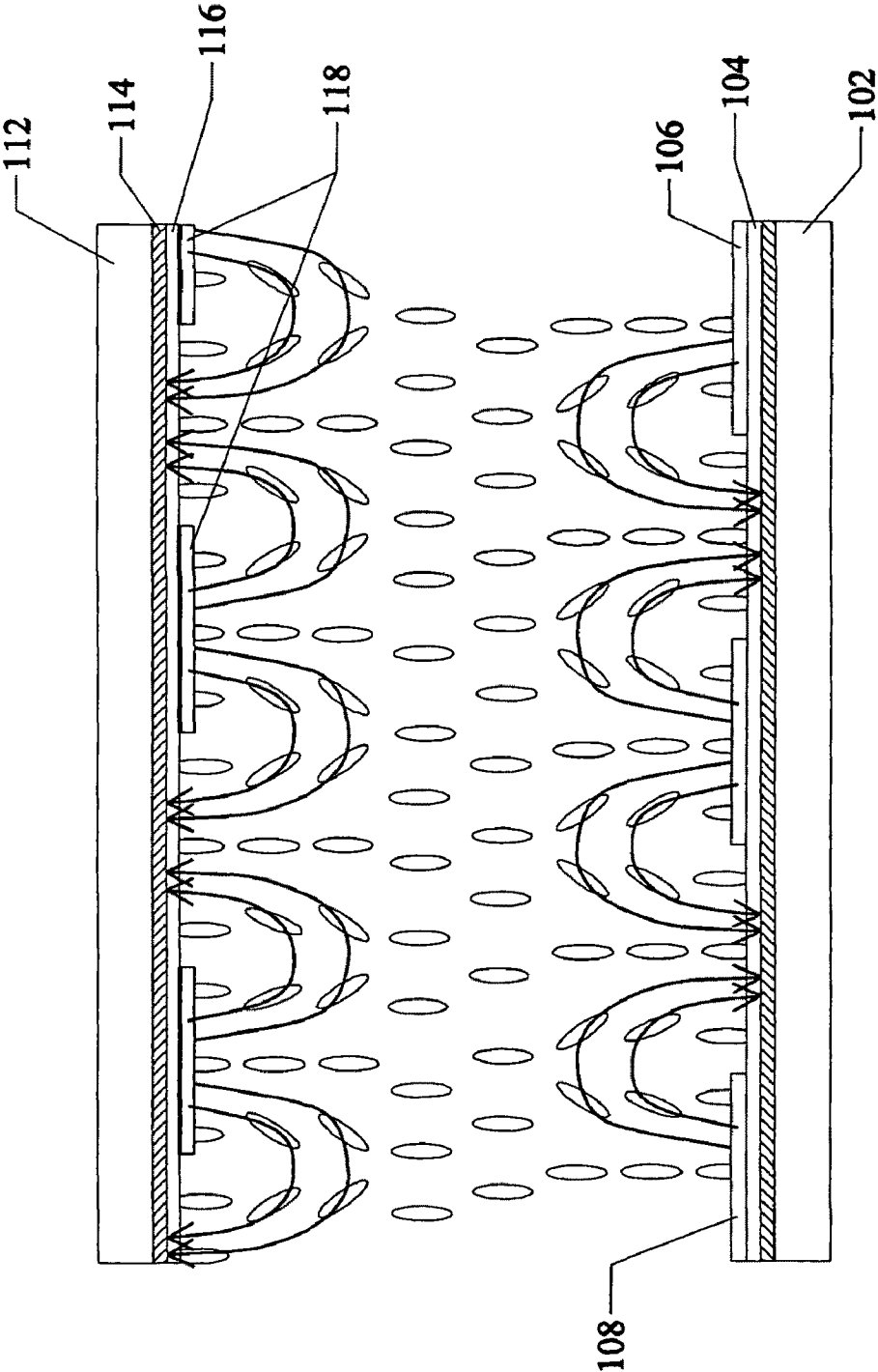

Fig. 11

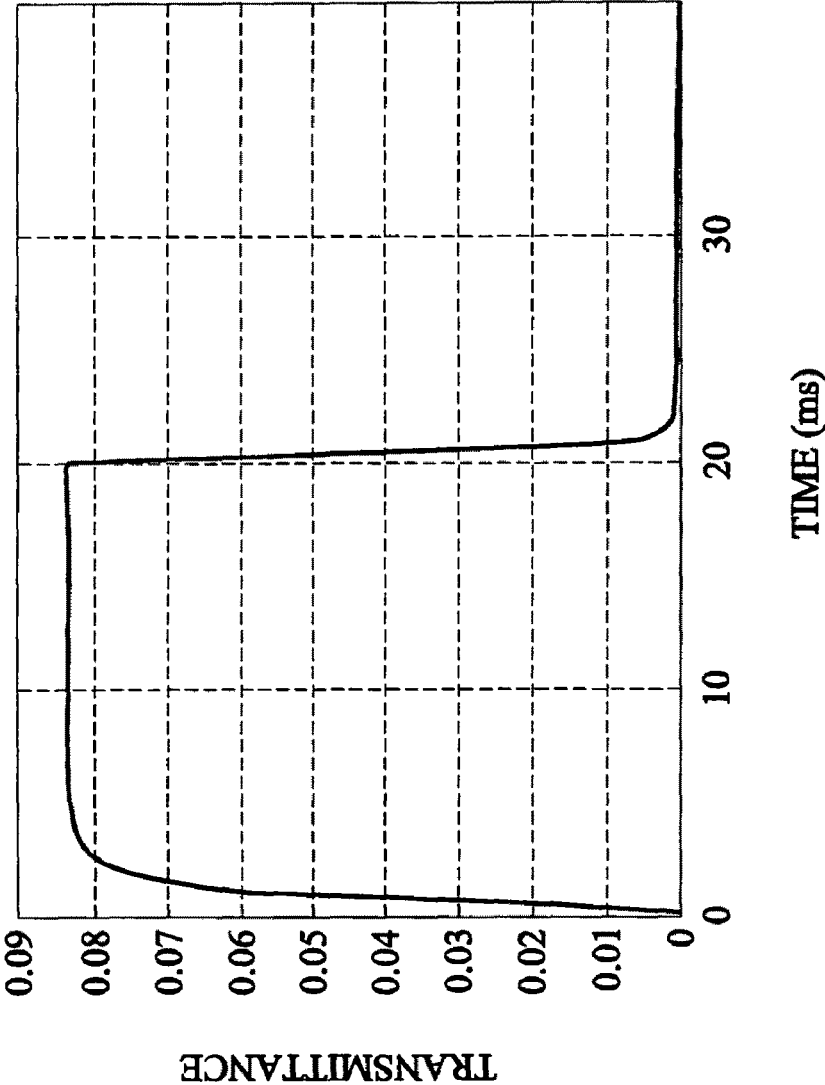

Fig. 12

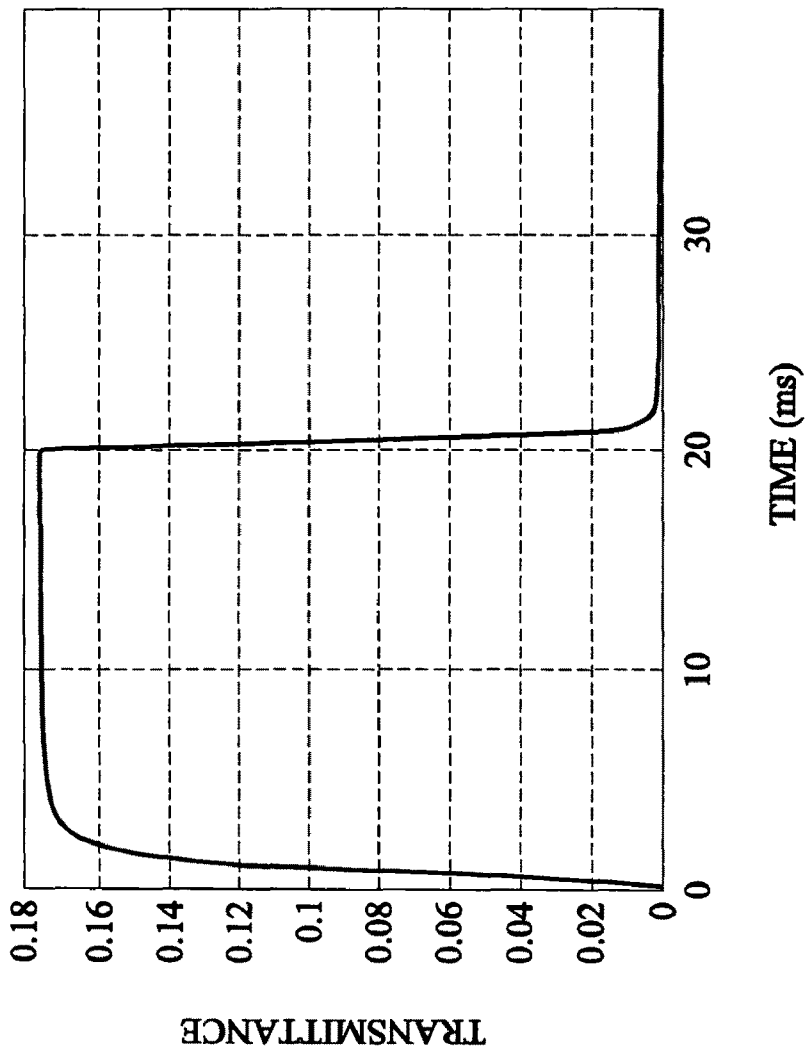

Fig. 13

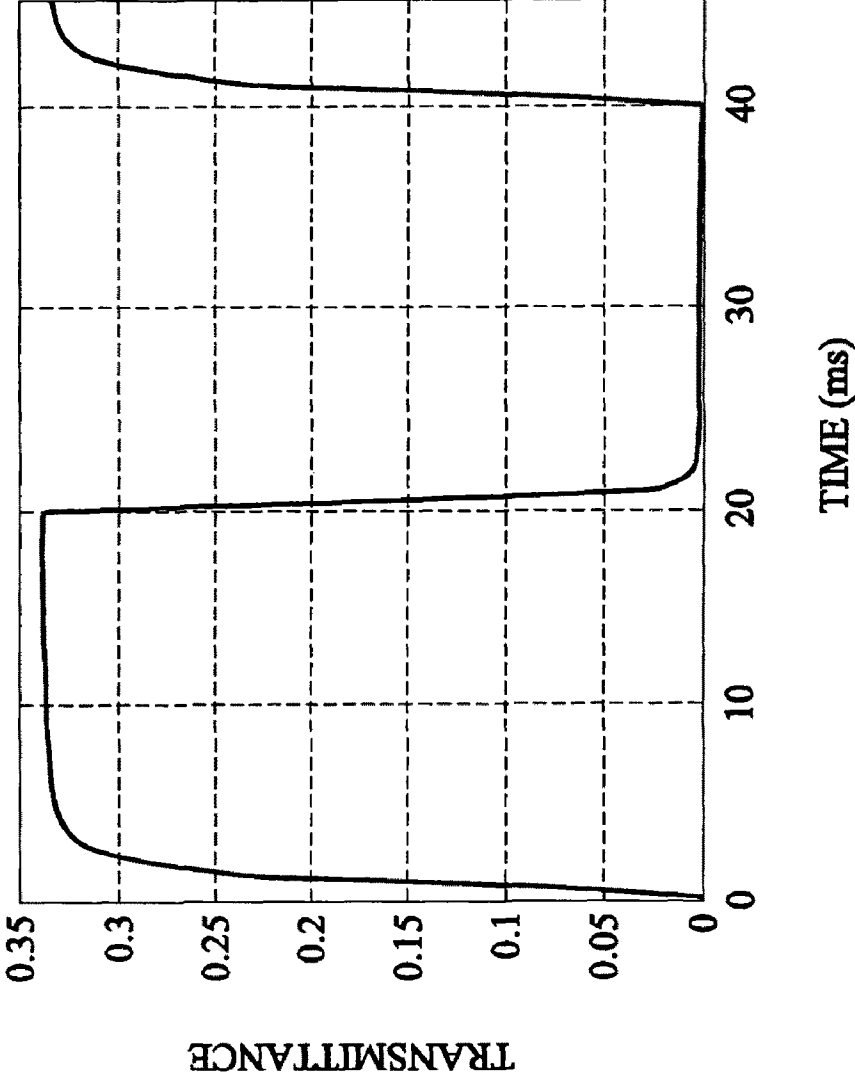

Fig. 14

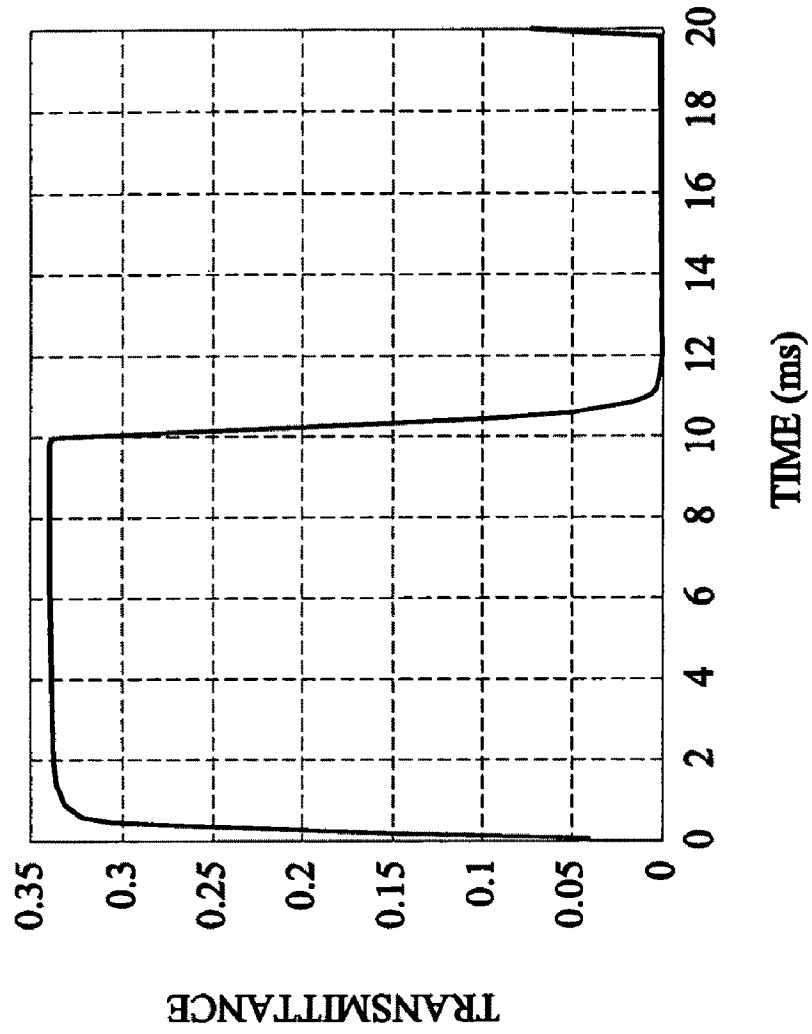

Fig. 15

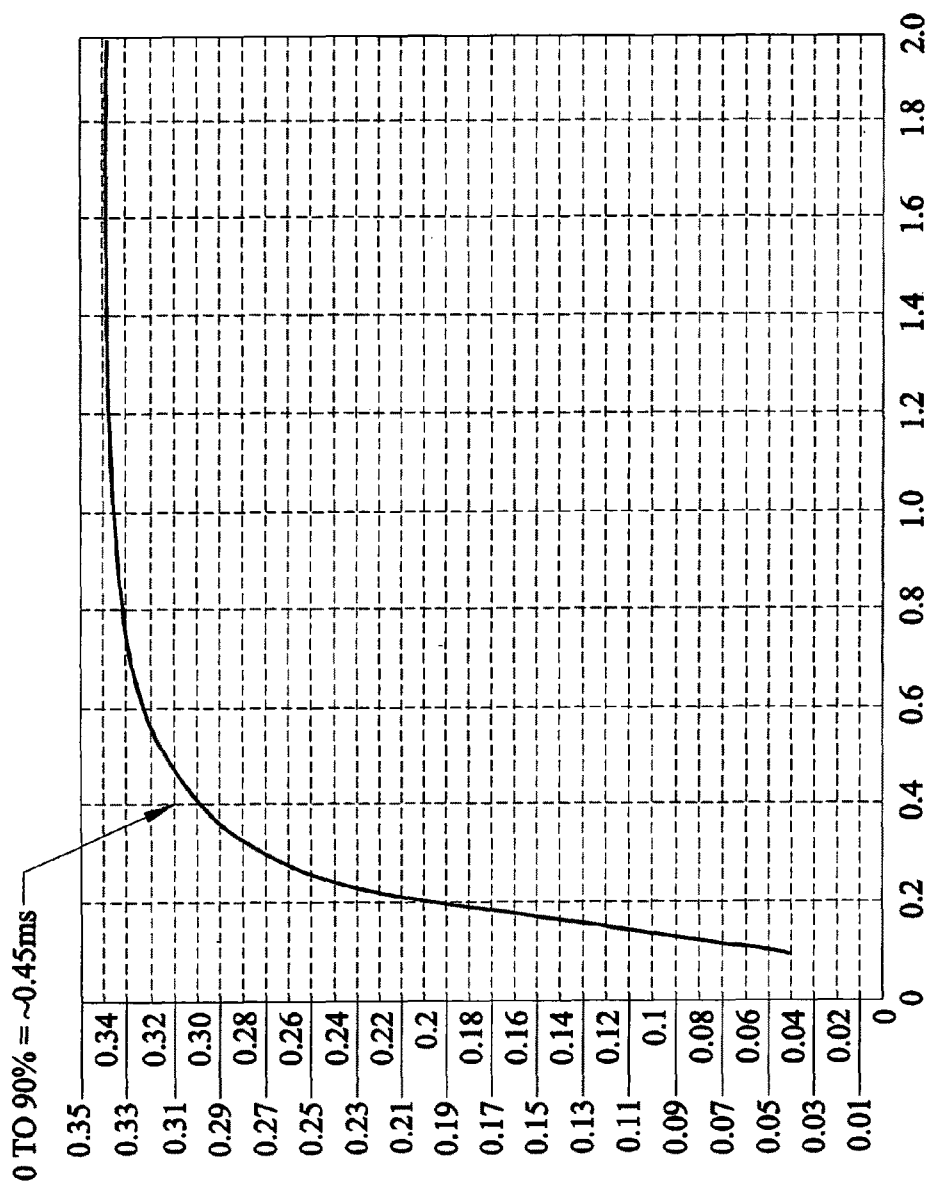

Fig. 16

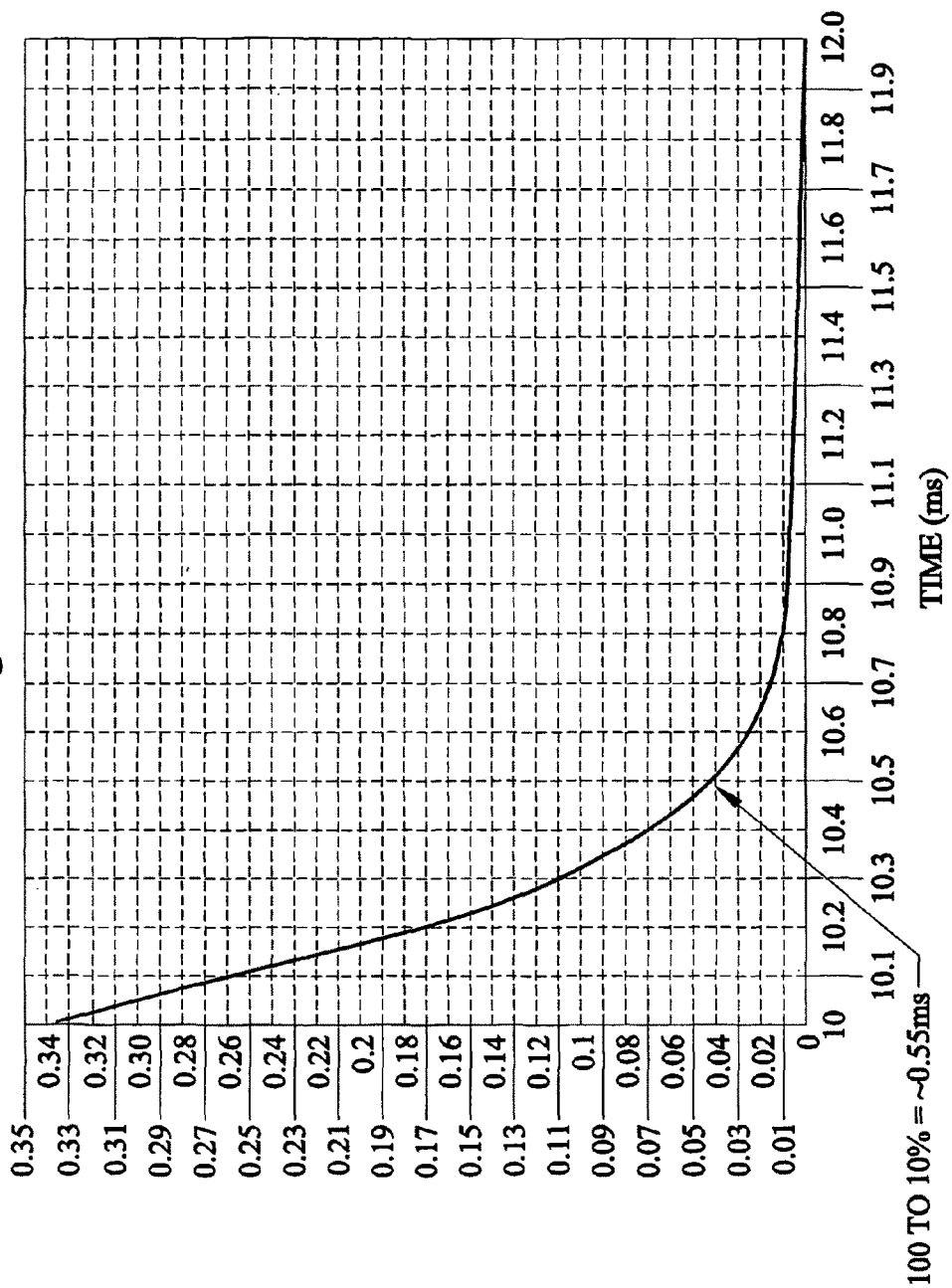

Fig. 17

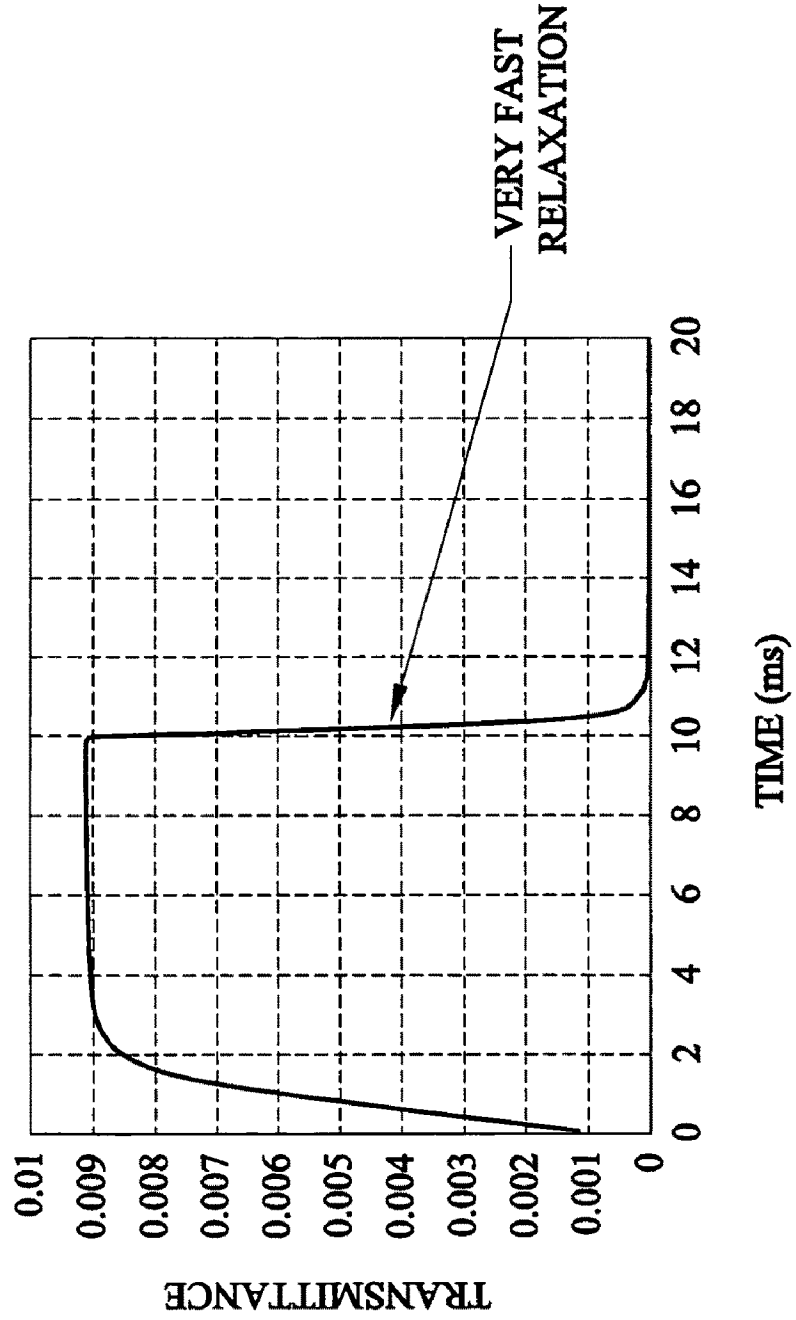

Fig. 18

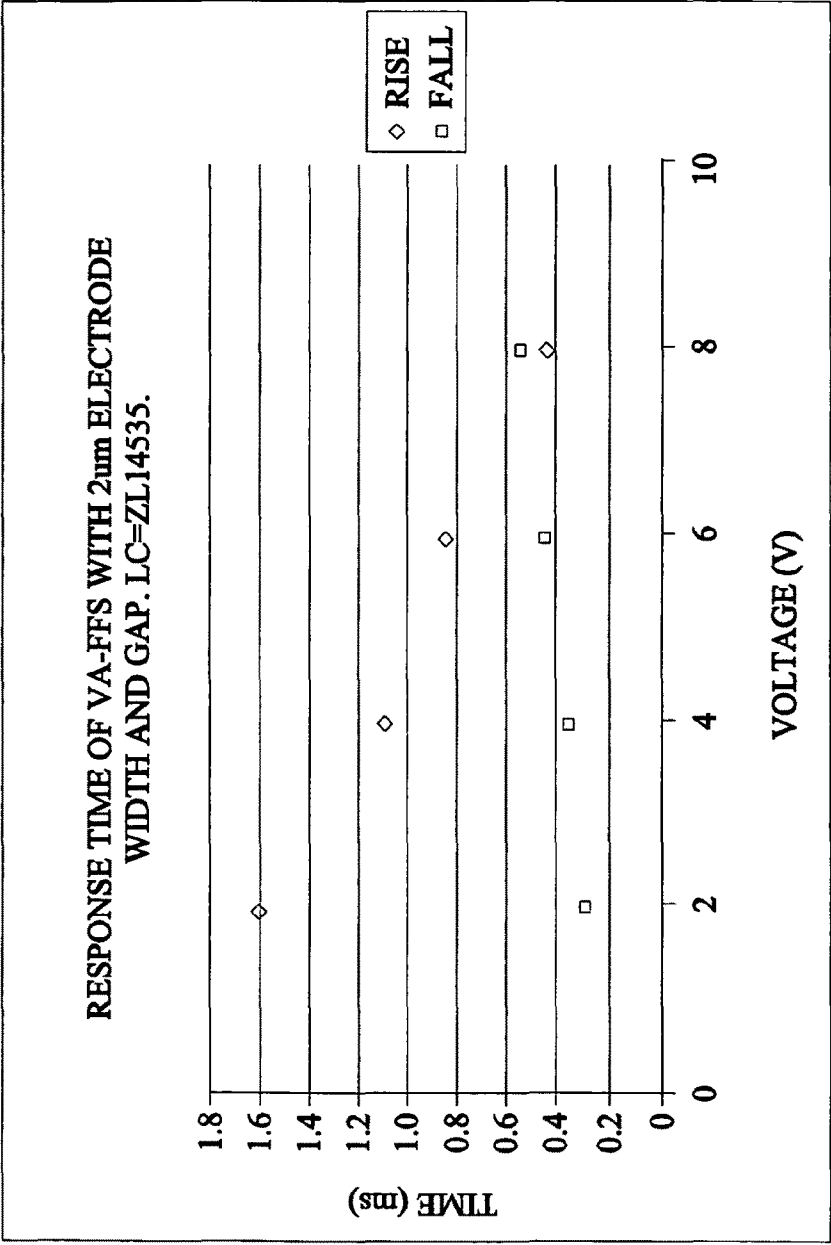

Fig. 19

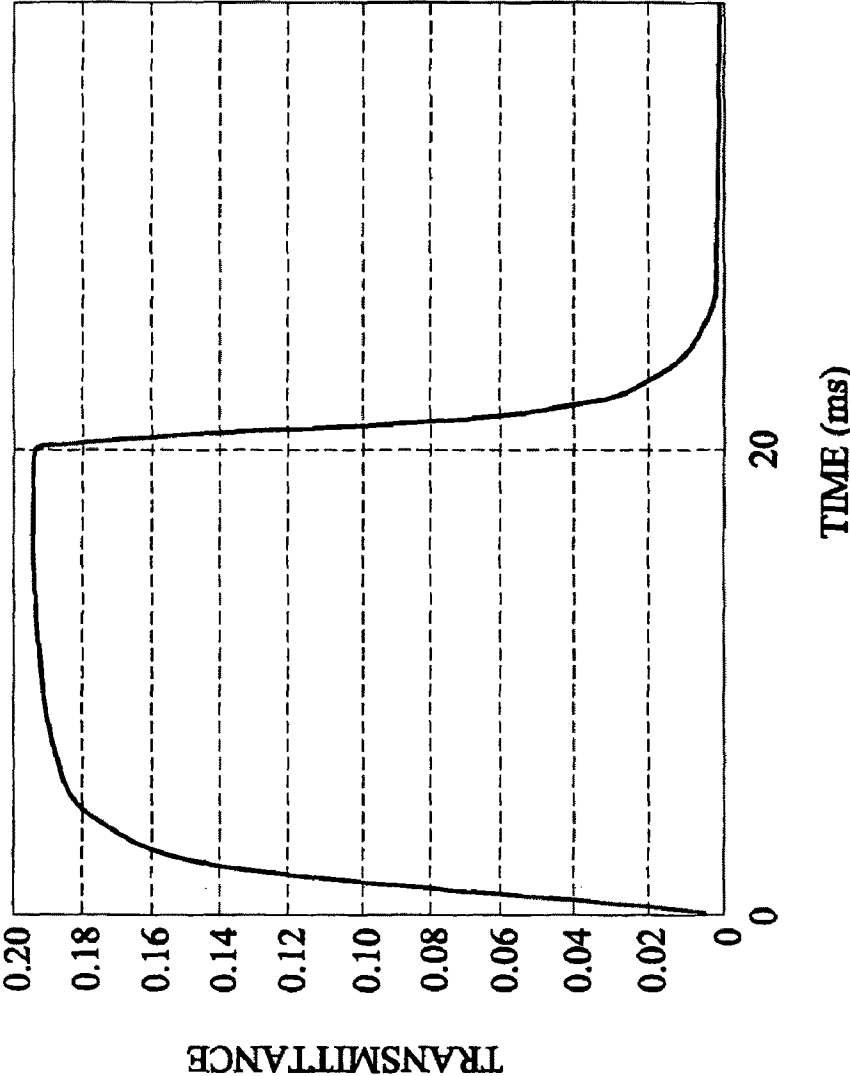

Fig. 20

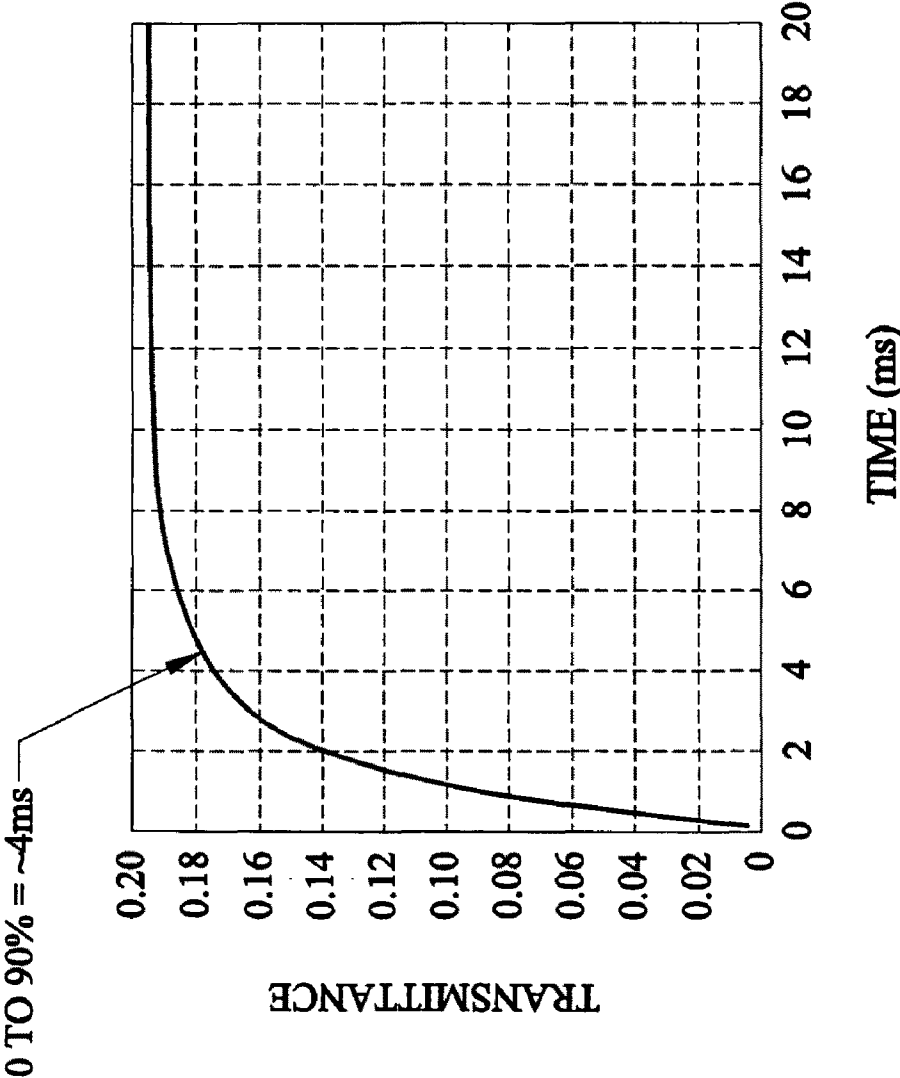

Fig. 21

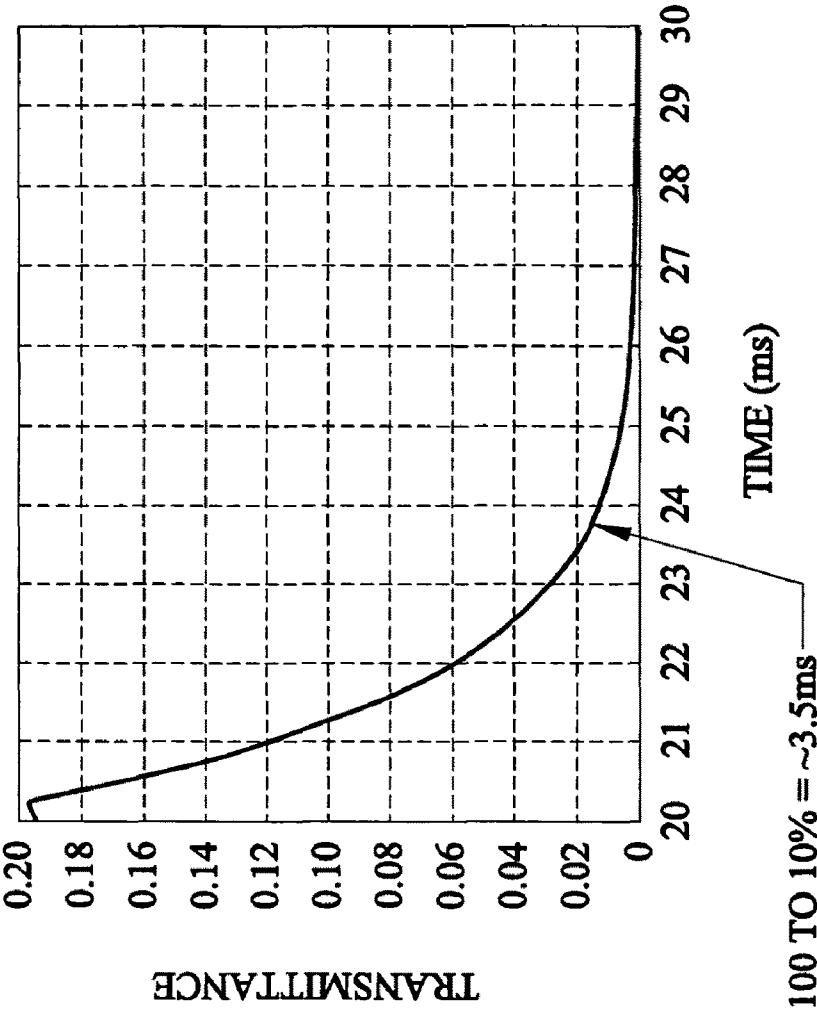

Fig. 22A

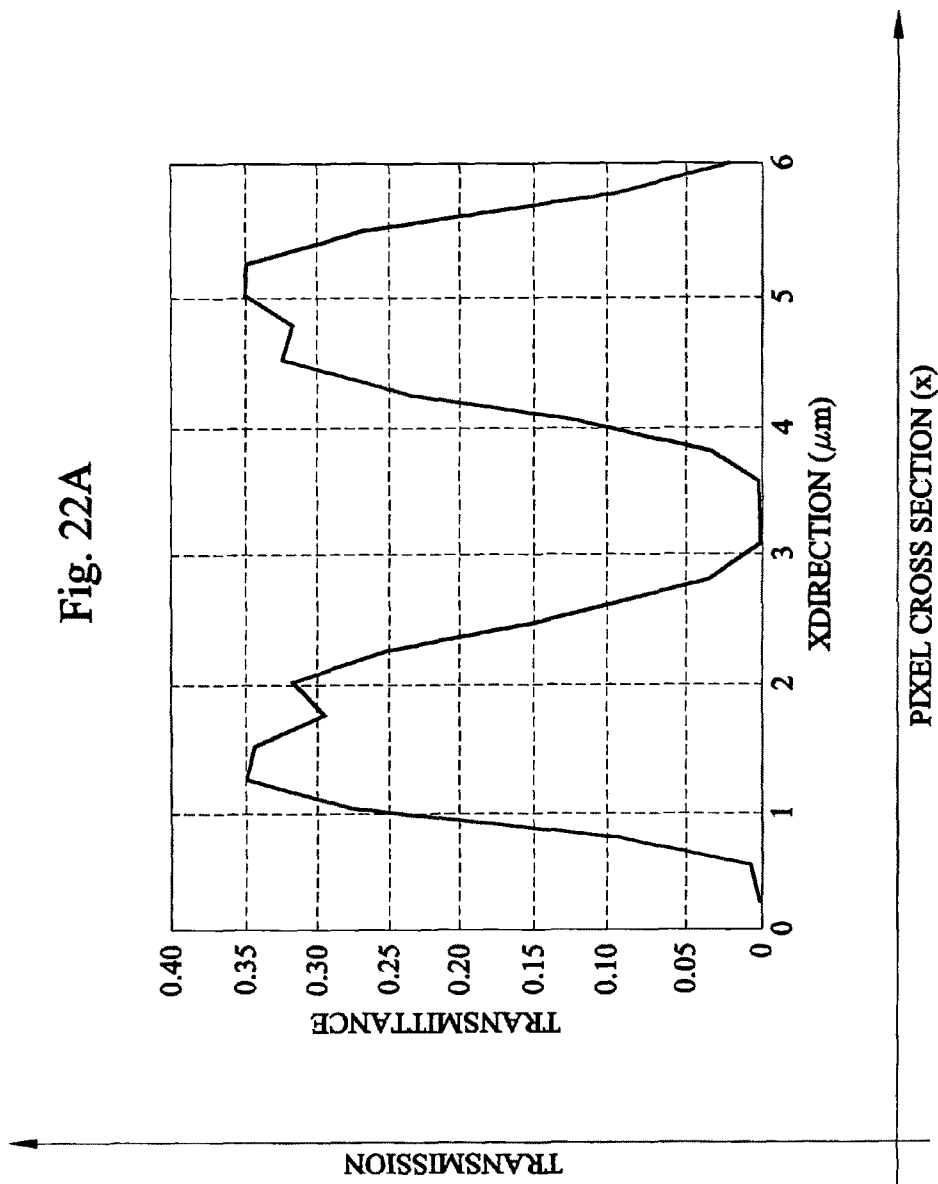

Fig. 22B

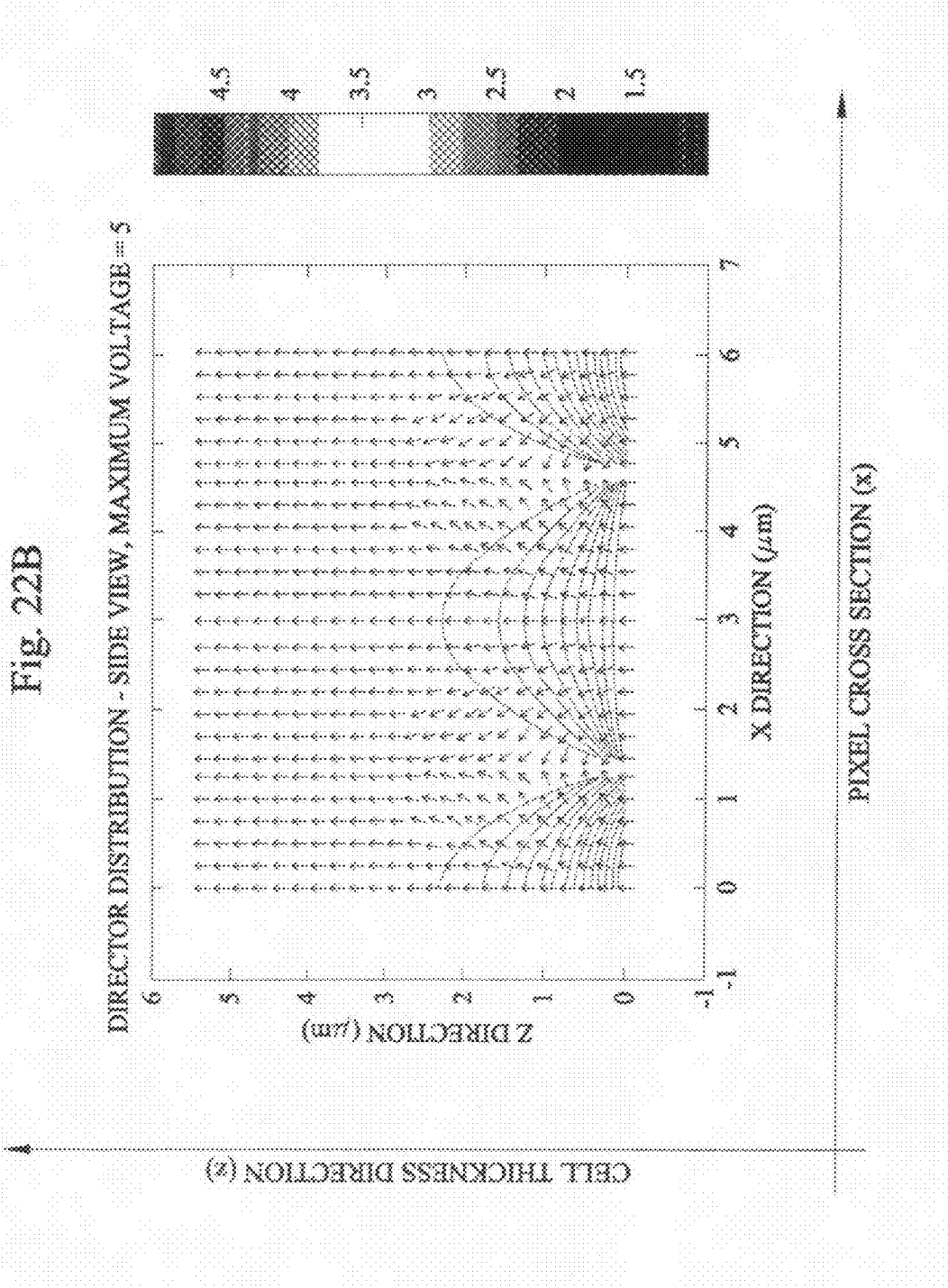

Fig. 23A

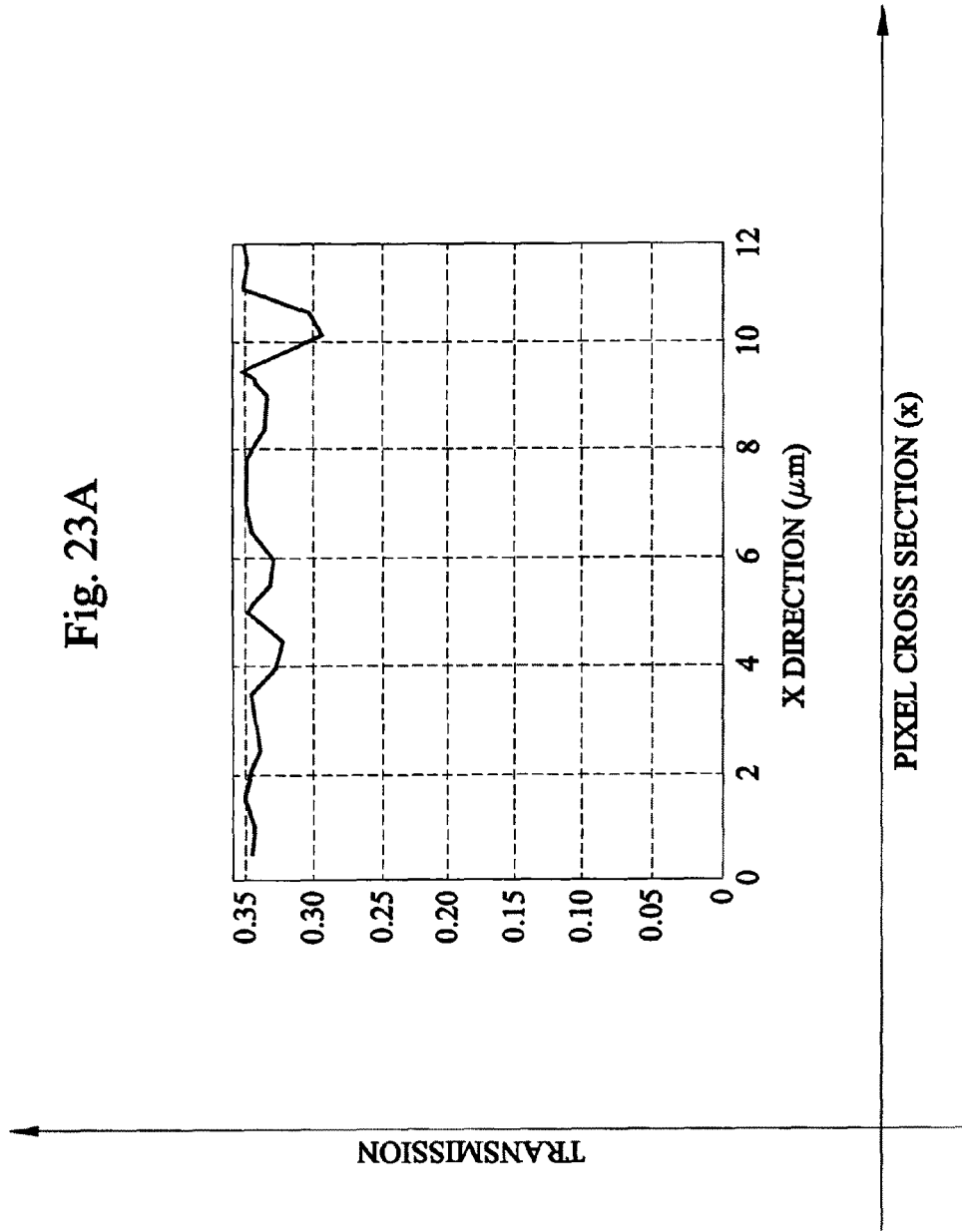
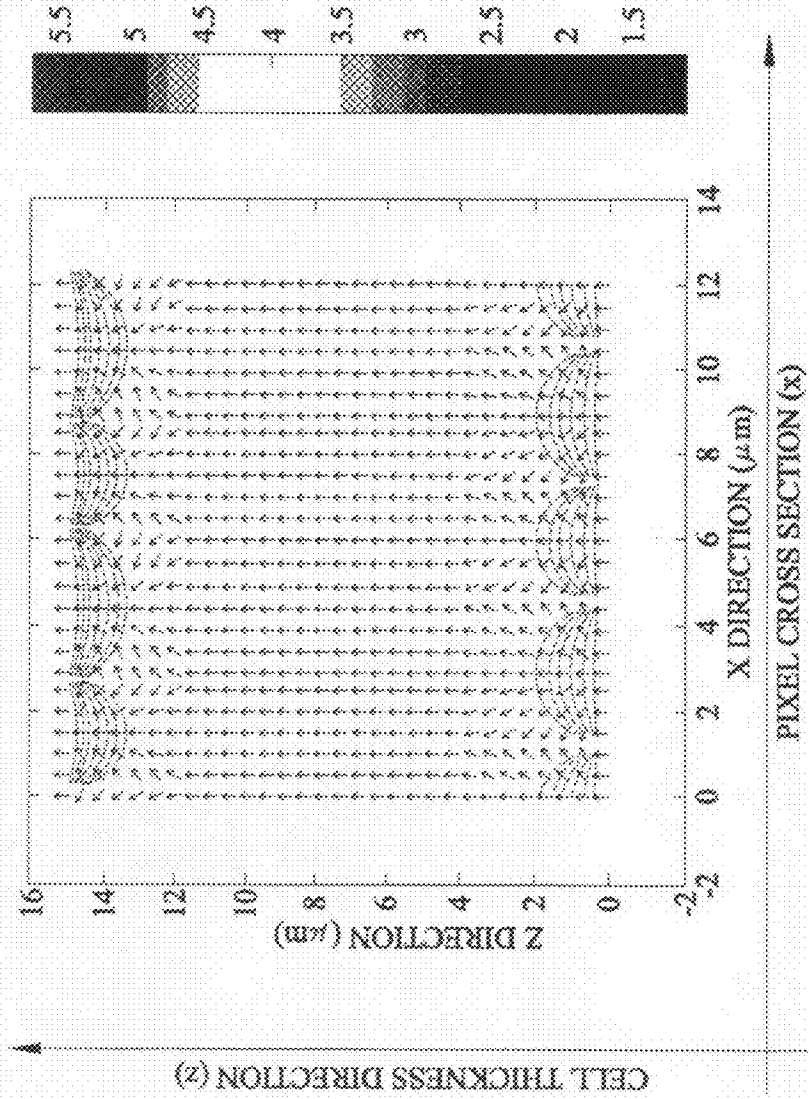

Fig. 23B

DIRECTOR DISTRIBUTION - SIDE VIEW, MAXIMUM VOLTAGE = 4.077



FAST RESPONSE LIQUID CRYSTAL MODE

This application is a divisional application of U.S. patent application Ser. No. 10/874,481 filed on Jun. 23, 2004 now U.S. Pat. No. 7,298,445 and claims the priority of U.S. Provisional Application Ser. No. 60/480,622 filed Jun. 23, 2003.

This application was supported in part by Department of Defense Advanced Research Project Agency (DARPA) and Raytheon Electronic Systems under Contract No. 65-04-878.

FIELD OF THE INVENTION

This invention relates to a liquid crystal operation mode, and in particular to methods and apparatus for producing a stable and fast-response optical modulator for use in optical communications and advanced display systems.

BACKGROUND AND PRIOR ART

Due to the slow response of nematic liquid crystals (typically 25 milliseconds (ms) to 100 ms), applications for nematic liquid crystals today have been mainly limited to those with relatively low data rates. This shortcoming is caused by the fact that the switching speed of nematic liquid crystals is often limited by its long relaxation time. Unlike the switching-on process, which is electric-field driven, the relaxation process (i.e. switching-off) is not electric-field driven and is generally a much slower process. This relaxation process is slower in a thicker cell since the restoring force provided by the alignment layers (substrate surfaces) to the bulk is weaker in a thick cell. In order for liquid crystal devices to switch at high speed, i.e. with short relaxation time, one often needs to use very thin cell gap (e.g. $<2\ \mu\text{m}$) such that the restoring force provided by the alignment layers remains very high in the bulk of the liquid crystal. This thin cell gap however increases fabrication difficulty, especially when the panel size is large, and also limits the potential optical retardation since cell gap is limited. It is therefore anticipated that if a nematic liquid crystal mode capable of achieving very fast response (e.g. $<5\ \text{ms}$) without the use of thin cell gap can be realized, it can greatly advance the development of high-speed applications in various areas such as those in optical communication systems (e.g., optical phase modulators) and advanced display systems, e.g., color sequential displays and television (TV) displays. Although a liquid crystal mode, known as Pi-cell Bend mode or Optically Compensated Bend (OCB) mode, capable of generating very fast response without the use of thin cell gap has been reported, this liquid crystal mode is unstable and requires a constant bias voltage.

With regard to Fringing-Field-Switching mode (FFS), the electrode design in the present invention is very similar to the FFS mode, as shown in FIG. 6, which was proposed by researchers in Korea for obtaining high efficiency wide-viewing-angle liquid crystal displays. The FFS mode developed in Korea has Parallel-Alignment (PA) at the off-state which leads to much slower response since the LC molecules in the whole bulk layer also switch without the restriction of the boundary effects, and the restoring force is mainly governed by the elastic constant K_{22} which is small. See "Fringing-Field-Switching mode (FFS)", Seung Hong et al, *Japanese Journal of Applied Physics*, Vol. 39, p. L527, 2000.

Vertical-Alignment-In-Plane-Switching (VA-IPS) is discussed by W. Liu et al, in *SID Digest '98*, p. 319, 1998. Researchers proposed the VA-IPS mode which combined VA alignment with IPS electrode design. The VA-IPS mode can achieve a wide-viewing angle property but the response time is not very fast. A major difference between VA-IPS and the

present invention is that the gap l between the positive and negative electrode is much larger in VA-IPS mode as shown in FIG. 7 whereas l is almost zero in the present invention (separated by a passivation layer only). Therefore the electric field in the VA-IPS mode is much more spread out and less localized which results in large switching of LC bulk layer and hence small boundary effect and slower response time.

Another liquid crystal mode of interest is the Optically Compensated Bend mode (OCB) discussed in *Japanese Journal of Applied Physics*, Vol. 39, Part 1, No. 11, H. Nakamura et al, p. 6368-6375, (2000). OCB is a liquid crystal mode that can generate very fast response without the use of very thin cell gap or special driving conditions. At off-state, this mode has Parallel Alignment (PA) with opposite top and bottom pre-tilts as shown in FIG. 8. Under a certain bias voltage, the molecules in the bulk are switched to vertical. Modulation of electric field above this bias voltage causes switching of the molecules near the boundaries. The OCB liquid crystal mode has very thin active LC layers and very strong boundary effects due to K_{33} and K_{11} as shown in FIG. 8. The OCB mode is however rather unstable since it involves the Splay to Bend transition and it also requires a constant bias voltage.

The following patent references are related to the use of liquid crystal display devices, but have no mention of Fringing Field Switching mode for Vertically Aligned liquid crystals.

U.S. Pat. No. 5,128,786 to Yanagisawa describes a LC display device wherein the image elements are arranged like a matrix with discontinuous electrodes. U.S. Pat. No. 5,179,460 to Hinata et al. discloses an input structure for a LC display that prevents electrode peeling and eliminates bending stresses and cracks in the electrode. U.S. Pat. No. 5,377,027 to Jelley describes a light-emitting LC display wherein a matrix area separates pixels. U.S. Pat. No. 5,781,259 to Shinomiya et al. describes another LC display device with transparent substrates, transparent pixels and transparent electrodes, the transparent pixels are separated from polymer portions with a shielding layer of metal foil. U.S. Pat. No. 6,031,593 to Morikawa et al. describes a spacing layer for LC display using light shielding layer. Pixels are formed with flattened film in between to suppress disinclination. None of the references suggest a configuration that uses self-imposed boundary layers by vertically aligned liquid crystals. Commercial demand is very strong for fast response, stable and easily fabricated liquid crystal devices.

The present invention provides a novel liquid crystal mode capable of producing very fast response, due to fast relaxation time, without the use of thin cell gap is disclosed. This invention is very stable and has very short relaxation time even at low voltages.

SUMMARY OF THE INVENTION

The first objective of the present invention is to provide a fast-response liquid crystal modulator.

The second objective of the present invention is to provide a fast-response liquid crystal modulator based on the use of Fringing-Field-Switching (FFS) to the Vertical Aligned (VA) liquid crystals (denoted by VA-FFS).

The third objective of the present invention is to provide a fast-response liquid crystal modulator without the use of thin cell gap.

The fourth objective of the present invention is to provide a fast-response liquid crystal modulator with self-imposed strong boundary layers such that very fast relaxation occurs even in a thick cell.

The fifth objective of the present invention is to provide a fast-response liquid crystal modulator with high stability.

The sixth objective of the present invention is to provide a fast-response liquid crystal modulator even at low operating voltage

Further objects and advantages of this invention will be apparent from the following detailed description of a presently preferred embodiment, which is illustrated, schematically in the accompanying drawings.

BRIEF DESCRIPTION OF THE FIGURES

FIG. 1 shows the structure of the liquid crystal mode (VA-FFS) in the present invention at "off state" with no applied voltage.

FIG. 2 shows the structure of the liquid crystal mode (VA-FFS) in the present invention at "on state" with an applied voltage.

FIG. 3 shows the switching of molecules occurs only within very thin layers of liquid crystals, which are generated as a result of disclination.

FIG. 4 shows the switching of LC, which is much larger near the substrate surface.

FIG. 5 shows the elastic forces and the boundaries responsible for the very fast relaxation.

FIG. 6 shows the structure of the Fringing-Field-Switching mode (FFS) at off-state. (Prior Art)

FIG. 7 shows the structure and switching of Vertical-Alignment-In-Plane-Switching (VA-IPS). (Prior Art)

FIG. 8 shows the structure of the Optically Compensated Bend mode (OCB) (Prior Art)

FIG. 9 shows the use of symmetric upper and lower electrode configuration in our present invention that can lower the operating voltage.

FIG. 10 shows the use of asymmetric upper and lower electrode configuration in our present invention that can achieve maximum possible transmission.

FIG. 11 shows a simulation of the optical response of the present invention with lower electrode only.

FIG. 12 shows a simulation of the optical response of the device in FIG. 11 after using a higher birefringence of liquid crystal and result in higher transmission.

FIG. 13 shows a simulation of the optical response of the present invention with asymmetric upper and lower electrode.

FIG. 14 shows the simulated optical response of the present invention with asymmetric upper and lower electrode and narrower electrode width and gap of 2 micrometers (μm).

FIG. 15 shows the rise time of the simulated optical response in FIG. 14.

FIG. 16 shows the fall time of the simulated optical response in FIG. 14.

FIG. 17 shows the simulated optical response of the device in FIG. 14 at 2 Volts (V).

FIG. 18 shows the rise and fall times of the device in FIG. 14 at different applied voltages.

FIG. 19 shows the simulated optical response of the present invention with lower electrode only and wider electrode width and gap of 5 μm .

FIG. 20 shows the rise time of the simulated optical response in FIG. 19.

FIG. 21 shows the fall time of the simulated optical response in FIG. 19.

FIG. 22A shows the transmission profile of the present invention with lower electrode only.

FIG. 22B shows the director distribution of the present invention with lower electrode only.

FIG. 23A shows the transmission profile of the present invention with asymmetric upper and lower electrode.

FIG. 23B shows the director distribution of the present invention with asymmetric upper and lower electrode.

DESCRIPTION OF THE PREFERRED EMBODIMENT

Before explaining the disclosed embodiment of the present invention in detail it is to be understood that the invention is not limited in its application to the details of the particular arrangement shown since the invention is capable of other embodiments. Also, the terminology used herein is for the purpose of description and not of limitation.

Acronyms used throughout the description of the present invention are defined as follows:

G—pixel electrode gap measured in micrometers (μm)

LC—liquid crystal

OCB—Optically Compensated Bend liquid crystal mode requires continuous application of bias voltage.

PA—Parallel Alignment of liquid crystals

TN—Twisted Nematic liquid crystals

VA-FFS—Vertical Alignment Fringing Field Switching liquid crystal mode of the present invention uses very low voltage, e.g., $<5\text{V}$.

VA-IPS—Vertical Alignment In Plane Switching liquid crystal mode

W—pixel electrode width measured in micrometers (μm)

The operating principle of the liquid crystal mode in the present invention is based on the Fringing-Field Switching (FFS) of Vertically-Aligned (VA) liquid crystals; this novel mode is hereinafter denoted as VA-FFS. The structure of this liquid crystal mode is shown in FIG. 1. Liquid crystal molecules **10** are sandwiched between a top substrate **22** and a bottom substrate **12**. The alignment of the liquid crystal molecules **10** is vertical at the "off state" where there is no applied voltage. The transmission is thus zero when the device is placed between crossed polarizers since there is no birefringence experienced by the incident light. In the bottom substrate **12**, the pixel electrode **14** next to the liquid crystal layer consists of discontinuous and narrow segments. These pixel electrode segments within one pixel are all connected to the same voltage source via a thin-film transistor. This pixel electrode **14** is separated from the bottom common electrode **18** (could be -0V) by a passivation layer **16**. The passivation layer **16** is usually silicon dioxide or any other commonly known insulation material and it is used as insulation between the pixel electrode **14** and the common electrode **18**. The width of each pixel electrode segment will be denoted by W and the width of the gap between adjacent segments will be denoted by G as shown in FIG. 1. Discontinuous and narrow segments of a pixel electrode for the present invention are in a range from approximately 1 micrometer (μm) to approximately 10 micrometers (μm); preferably between approximately 2 μm to approximately 7 μm . When the voltage of the pixel electrode **14** is switched on, e.g. from 0V to 5V, an electric field pattern **28** is generated as shown in FIG. 2. This electric field switches the vertically aligned molecules and generates a bright state between crossed polarizers. The switched molecules relax back to the original state when the applied voltage is removed. It is found that the relaxation time of this liquid crystal mode becomes exceedingly fast, e.g., in a range from 1 millisecond to 3 milliseconds (ms) when W and G of the pixel electrode become very narrow, e.g. 3 μm or below. Although, in general, W and G can have different values, through simulations it has been found that highest light efficiency is usually obtained when W and G are equal.

For example, when $W=G=3\ \mu\text{m}$, both rise and fall (relaxation) times are often as short as 3 milliseconds (ms) or below. Moreover, these fast responses can occur at a relatively low voltage, e.g. 2-5 Volts (V), and in a thick cell (e.g. 5-15 μm). These unusual fast responses suggest that this novel liquid crystal mode can have significant potential for low voltage, fast response, nematic liquid crystal modulators.

The mechanisms for the unusual fast response involve strong boundary effects provided by disclinations (K_{11}) and strong boundary effects provided by substrate surface (K_{33}).

As shown in FIG. 2, due to the interaction of LC molecules with the generated electric field, regular disclinations **25**, also known as "unswitched molecules," exist above the pixel electrode. These disclinations **25** cause the switching of LC molecules **20** to be confined within very thin layers or horizontal sections that are perpendicular to the vertically aligned LC molecules. For example, when $W=G=3\ \mu\text{m}$, LC molecules are only allowed to switch within 1.5 μm layers of LC as shown in FIG. 3. The LC layers **30** are so thin that the majority of the LC molecules are influenced and governed by the adjacent disclinations **25**. The disclinations **25** act as strong boundaries which induce very high restoring forces (due to elastic constant K_{11}) on the switched LC molecules **20** after the removal of an applied voltage and result in very fast relaxation. This is very similar to the mechanism for the fast response, which occurs in LC devices with very thin cell gap since a majority of the molecules in these devices are strongly controlled and influenced by the boundary (alignment) layers. This is justified by the fact that the relaxation time of the LC mode in this invention remains very fast even after the removal of a very small voltage, e.g. 2V.

Referring now to the strong boundary effects provided by a substrate surface (due to elastic constant K_{33}). In FIG. 3, substrate surface **12** supports pixel electrode **14** and when W and G of the pixel electrode become very small, most of the electric field generated is concentrated near the electrode, i.e. the electric field is much stronger near the surface of the substrate **12**. Therefore, the extent of the LC switching (i.e. angle of rotation) is much larger near the substrate surface than in the bulk as shown in the simulated director distribution in FIG. 4. The relaxation speed of these molecules is thus further enhanced by the strong elastic force due to K_{33} provided by the boundary layer (alignment layer) on the substrate surface. The relaxation process of this type of LC mode where the switching occurs mainly near boundaries, similar to the OCB liquid crystal mode, is in general much faster compared with LC modes where the molecules in the bulk also switch significantly.

FIG. 5 summarizes the elastic forces and boundaries around the switched molecules responsible for this fast response mode. The switched molecules shown in FIG. 5 correspond to the active LC layers **30** shown in FIG. 3. K_{11} and K_{33} are elastic constants that correspond to different types of elastic forces exerted on the active molecules. K_{11} tends to be along the longer, vertical axis of the molecule and K_{33} tends to be along the shorter, horizontal axis of the molecule. Splay and Bend are the technical names used to distinguish the different types of elastic forces. Thus, Bend K_{33} represents elastic forces in a horizontal direction and Splay refers to the elastic forces in a vertical direction. Compressed Splay occurs when the molecules are squeezed against each other and Stretched Splay occurs when the molecules are being pulled apart. In both cases, compressed and stretched splay, the movement creates an elastic force along the vertical length of the molecule.

Below are further embodiments that can enhance the efficiency or brightness of a device using the present invention.

One embodiment uses symmetrical upper and lower electrodes as shown in FIG. 9. In a lower stacked arrangement, a first substrate **92** is adjacent to a common electrode **94** adjacent to a passivation layer **96** that is adjacent to a discontinuous pixel electrode **98**. Opposite and symmetrically aligned is an upper stacked arrangement having a second substrate **192**, adjacent to a second common electrode **194**, adjacent to a second passivation layer **196** attached to a second discontinuous pixel electrode **198**. This configuration can lower the required voltage to attain a certain transmission compared with the lower electrode only configuration shown in FIG. 1.

Another embodiment uses asymmetric upper and lower electrodes as shown in FIG. 10. In a lower stacked arrangement, a first substrate **102** is adjacent to a common electrode **104**, adjacent to a passivation layer **106** that is adjacent to a discontinuous pixel electrode **108**. Opposite and asymmetrically aligned is an upper stacked arrangement having a second substrate **112**, adjacent to a second common electrode **114**, adjacent to a second passivation layer **116** attached to a second discontinuous pixel electrode **118**. This configuration allows the transmission to increase significantly since the switched LC molecules in the upper electrode compensate for the unswitched LC molecules (disclination) in the lower electrode, thus increases the maximum possible transmission.

Simulation results for each of the embodiments of the VA-FFS liquid crystal mode of the present invention are shown in FIGS. 11 to 23.

FIG. 11 shows the simulation result of the optical response of a 5.5 μm thick VA-FFS (with lower electrode only) device to an applied voltage of 5V. The liquid crystal has birefringence (Δn) of 0.2 whereas other physical properties are taken the same as LC ZLI-4535, the product code for a liquid crystal that is commercially available from Merck, Inc. ($K_{11}=9.3\ \text{pN}$, $K_{22}=5.9\ \text{pN}$, $K_{33}=11.8\ \text{pN}$ and $\Delta\epsilon=14.8$). The device has $W=G=3\ \mu\text{m}$. The transmission of this cell is not so high, $\sim 8.5/35 \sim 24\%$. The transmission is divided by 35 since 35 corresponds to 100% normalized transmission of the conventional twisted nematic (TN) cell. However, the response times are unusually fast. The rise time is $< 3\ \text{ms}$ and the fall time is $< 1\ \text{ms}$. Moreover, this happens at a relatively low voltage of 5V.

By using higher birefringence liquid crystal, one can increase the transmission of the device in FIG. 11. For example, by using Δn of 0.4, the transmission is approximately doubled to 17.5%, which is 50% of TN as shown in FIG. 12.

By using asymmetric upper/lower electrode, the potential transmission can be maximized. For example, the transmission of a device with asymmetric upper and lower electrodes is $\sim 33.5/35 \sim 96\%$ at 6V with LC $\Delta n=0.4$ as shown in FIG. 13. Other LC physical parameters are $K_{11}=12\ \text{pN}$, $K_{22}=6\ \text{pN}$, $K_{33}=16\ \text{pN}$ and $\Delta\epsilon=10$. Cell gap of the device was 15 μm thick in order to reduce the influence of the electric fields between top and bottom electrode.

By using $W=G=2\ \mu\text{m}$, the response time can be reduced even further at the expense of higher applied voltage. For example, the electro-optic response of a device using asymmetric upper and lower electrodes with $W=G=2\ \mu\text{m}$ is shown in FIG. 14. The rise and fall times are only $\sim 0.45\ \text{ms}$ and $\sim 0.55\ \text{ms}$ as shown in FIGS. 15 and 16. The LC is ZLI4535 with $\Delta n=0.4$ and transmission reaches maximum at almost 100% at the applied voltage of 8V. FIG. 17 shows the optical response of the device when it is under an applied voltage of 2V. As can be seen from the figure, this liquid crystal mode offers unusual fast relaxation even at very small applied voltages. In fact, the relaxation time (fall time) becomes shorter at lowered applied voltage since the molecular perturbation

becomes smaller at lower applied voltage. FIG. 18 shows the rise and fall times of the device at different applied voltages. As can be seen from the plot, both rise and fall times are very fast <2 ms even at low applied voltages. The relaxation time becomes shorter as voltage is lowered due to lower molecular perturbation whereas rise time increases as voltage is lowered due to lower applied electric field; rise time is field-driven.

FIG. 19 shows the optical response of a device when the electrode width W and gap G are $=5 \mu\text{m}$. In this example, only a lower electrode was used. FIGS. 20 and 21 show that the rise and fall times of the devices are still very fast at ~ 4 ms and ~ 3.5 ms respectively. The transmission of a $10 \mu\text{m}$ thick device is $\sim 20/35 \sim 57\%$ at an applied voltage 6V. An of the LC used is 0.2 and other physical parameters of LC are taken as those of ZLI4535. Higher transmission is possible by including an upper electrode. These results can be important for manufacturers where the fabrication capability of narrow pixel electrode is more limited.

The optical response of the device for intensity modulation has been demonstrated. However, phase modulation is often required for optical communication applications. The fact that the amount of induced phase shift for phase modulation is proportional to the amount of induced retardation for the intensity modulation suggests that we can deduce the phase modulation capability of the device by analyzing the intensity modulation behavior. In general, intensity modulation operates when the device is placed between crossed polarizers and that the incident beam is polarized at 45° relative to the plane of optic axis rotation. Incident light experiences both ordinary and extraordinary indices n_o and $n_{e(\text{eff})}$. Upon an applied voltage, transmission changes from 0 to 100% when a π optical retardation is induced. This π optical retardation however becomes a π pure phase-shift when the device operates in the phase modulation mode, which occurs when the incident beam is polarized along the plane of optic axis rotation, instead of 45° as for intensity modulation. Thus, the incident beam experiences $n_{e(\text{eff})}$ only. Therefore, a full intensity transmission in intensity modulation also corresponds to a π phase shift in phase modulation.

In general, if the transmission profile is examined across a pixel in the device of the present invention with lower electrode only, it has a rather non-uniform output profile as shown in FIG. 22A. This is due to the non-uniform switching of LCs caused by the disclination and the generated electric field pattern as shown in simulated director distribution in FIG. 22B. This non-uniformity is acceptable for applications such as displays where the intensity of a pixel perceived by the human eyes is spatially averaged. However, for phase modulation, this non-uniformity corresponds to non-uniform phase shift across the pixel. Better uniformity is desired in order to maximize the phase modulation efficiency. By using asymmetric upper and lower electrodes, the transmission profile becomes much more uniform as shown in FIG. 23A. This happens as a result of the compensation offered by the upper electrode. Simulated director distribution of a LC device with asymmetric upper and lower electrodes is shown in FIG. 23B. Further improvement of the uniformity may be obtained by careful design and optimization of the electrode.

The transmission shown in FIG. 23A is $\sim 100\%$, since 0.35 transmission on the figure corresponds to 100% normalized transmission, which corresponds to a π pure phase-shift or phase modulation. The pixel electrode width W and gap G are both $2 \mu\text{m}$. The applied voltage is 8V with Δn of LC=0.2 at wavelength of 550 nm. By using $\Delta n=0.4$, a 2π phase shift may be obtained. To obtain a 2π phase shift at 1550 nm infrared region, further improvements on the device design or LC birefringence may be required.

Due to the mirror symmetry of the molecular switching which results in multi-domain formation, this liquid crystal mode has inherent wide-viewing-angle property, which is a very desirable property for display applications.

Other potential applications for the present invention include, but are not limited to, optical-phased-arrays for beam-steering, high-speed color sequential displays, TV displays with fast response and wide-viewing angle. Those skilled in the art will perceive additional applications when the advantages of the present invention are discussed in view of current technology.

The present invention provides a faster response than the Fringing-Field-Switching liquid crystal mode and the Vertical-Alignment-In-Plane-Switching mode. The present invention is more stable and does not require bias voltage, as does the Optical Compensated Bend liquid crystal mode. With regard to conventional liquid crystal cells which can have Vertical Alignment (VA), Parallel Alignment (PA), or Twisted Nematic (TN) cells that require a thin cell gap structure; the present invention does not require a thin cell gap.

Thus, the present invention provides a unique structure, the Vertically Aligned-Fringing Field Switching (VA-FFS) liquid crystal mode capable of generating very fast optical modulation without the use of a very thin cell gap. Fast relaxation occurs even at very low applied voltages and the operation is very stable. The end result is a fast response liquid crystal mode to meet the demand and use in advanced display systems and optical communication systems.

While the invention has been described, disclosed, illustrated and shown in various terms of certain embodiments or modifications which it has presumed in practice, the scope of the invention is not intended to be, nor should it be deemed to be, limited thereby and such other modifications or embodiments as may be suggested by the teachings herein are particularly reserved especially as they fall within the breadth and scope of the claims here appended.

We claim:

1. A method of producing a stable, fast-response optical modulator with vertically aligned (VA) fringing field switching (FFS) liquid crystals, consisting of the steps of:
 - a) forming a top substrate and a bottom substrate, only the bottom substrate capable of supporting one single continuous common electrode connected to a voltage source,
 - b) placing a nematic liquid crystal layer between the top and bottom substrate of (a) so that the molecules of said crystal are vertically aligned when there is no voltage applied,
 - c) including only one single pixel electrode only on the bottom substrate next to the liquid crystal layer above the continuous common electrode, said only one single pixel electrode having discontinuous and adjacent narrow segments that are parallel to one another having a width (W) and a space between segments forming a gap (G); and
 - d) connecting the only one single pixel electrode to a voltage source, the parallel pixel electrode segments of a pixel connected to the same voltage source; and
 - e) providing insulation between the only one single pixel electrodes and the only one single continuous common electrode with a passivation layer, wherein when the voltage in the on state, a layer of unswitched vertically aligned liquid crystal molecules are located adjacent to the top substrate; whereby intensity and phase modulation for displays and optical communication are accomplished.

9

2. The method of claim 1, wherein W and G have the same value.

3. The method of claim 1, wherein W and G are below approximately 7 micrometers (μm).

4. An optical response device for producing stable, fast-response optical modulation consisting of:

a top substrate and a bottom substrate having only one single continuous common electrode connected to a voltage source and only on the bottom substrate,

nematic, vertically aligned liquid crystal (LC) molecules in the off state when there is no applied voltage,

self-imposed strong boundary layers adjacent to the top substrate provided by unswitched LC molecules when a voltage is applied,

fringing field switching in the operational mode,

only one single pixel electrode having discontinuous and parallel narrow segments having a width (W) and a space between segments forming a gap (G) between adjacent parallel segments formed only on the bottom substrate

above the continuous common electrode adjacent to a liquid crystal layer sandwiched between the top and bottom substrate, the only one single pixel electrode

connected to a voltage connection, and

10

a passivation layer between the only one single common electrode and the only one single pixel electrode.

5. The optical device of claim 4, wherein the self-imposed strong boundary layers comprise unswitched LC molecules being held in a stationary position by adjacent fringing field switching molecules interacting with a generated electric field above the pixel electrode.

6. The optical device of claim 5, wherein the fringing field switching occurs in very thin horizontal sections that are perpendicular to the vertical alignment of the LC molecules.

7. The optical device of claim 6, wherein the fringing field switching occurs in horizontal sections of less than approximately 3.5 μm in length.

8. The optical device of claim 4, wherein the discontinuous and narrow segments include:

a narrow width (W) of less than approximately 7 μm ; and a narrow gap (G) of less than approximately 7 μm .

9. The optical device of claim 4, wherein the only one single pixel electrode includes a thin-film transistor for a voltage source.

10. The optical device of claim 4, wherein the passivation layer is an electrical insulating material.

* * * * *