

Improving Behavior of Castellated Beam by Adding Spacer Plat and Steel Rings

Hayder Wafi Ali Al-Thabthabee

Muslim Abdul-Ameer Al-Kannoon

College of Engineering, Al-Kufa of University

Dr_haider.wafy@yahoo.com

muslim.altameemi@uokufa.edu.iq

Abstract

Castellated steel beams are those members which are made from hot rolled steel I-section firstly by cutting the web in zigzag pattern and rejoining the two halves by welding together to form a hexagonal castellated beam such that the depth of section will be increased. Generally, the openings made in the web are with hexagonal shape; however, octagonal shape of web openings is typically obtained by providing spacer plate which is utilized to increase the depth of beam. Nowadays, using castellated beams in building construction becomes very popular because of their useful functions such as ease of service provision, strength and low cost. This study focuses on improving the behavior of hexagonal and octagonal castellated beam with spacer plate. The ultimate strength of the original (parent) I- section beam increases due to the increasing its depth. The increment of castellated beam depth; however, leads to post buckling in its web and to many other modes of failure when these beams are subjected for loading. Hexagonal and octagonal castellated beams which are fabricated using parent I-section (IPN140) are analyzed using finite element model (FEM). The analysis results revealed that using ring stiffeners around edge of holes contributes effectively in strengthening the web. It was found that using ring steel stiffeners can reduce the stress concentration around the edge of holes and improve the behavior of these beams by increasing the ultimate strength and minimizing the deflection. From the numerical (FEM) results obtained by using ANSYS14, it is concluded that ultimate strength of castellated beam can be improved by providing spacer plate and ring stiffeners around the web hole. Also, the results showed that ultimate strength of octagonal castellated steel beam can be increased up to (53%) more than the parent beam (IPN140) with providing only (13.0%) weight of steel (spacer plate plus ring steel stiffeners).

Key word: Castellated steel beam (CSB), Spacer plate, Ring steel stiffeners, Ultimate strength, Parent section, Finite element method (FEM).

الخلاصة

العتبات الفولاذية القلعوية هي تلك الاعضاء الانشائية التي تصنع من مقاطع فولاذي قياسية بعد قطع جذع المقطع بشكل متعرج ثم ترخيف الجزئين وربطهما بواسطة اللحام لتشكيل عتبة قلعوية ذات فتحات سداسية مما يؤدي لزيادة عمق مقطع العتبة الفولاذية. بصورة عامة ان الفتحات المتكونة في جذع العتبة القلعوية تكون بشكل سداسي مع ذلك يمكن الحصول على فتحة ثمانية الشكل باضافة صفيحة من الفولاذ بين الجزئين (Spacer Plate) لزيادة عمق العتبة. اصبح استخدام العتبات القلعوية في انشاء الابنية منتشرة بشكل واسع بسبب العديد من الايجابيات مثل سهولة مد الخدمات و المقاومة العالية والكلفة المنخفضة بالمقارنة بالمقطع الام. هذه الدراسة تركز على تحسين سلوك العتبات القلعوية ذات الفتحات السداسية الشكل و الفتحات ثمانية الشكل والمجهزة صفيحة فولاذية لزيادة العمق. التحمل الاقصى للعتبة الام تزداد مع زيادة عمق العتبة. لكن الزيادة بعمق العتبة القلعوية يؤدي لحدوث فشل الانبعاج في الجذع مع انواع اخرى من الفشل عند تسليط الاحمال الخارجية. اثبتت نتائج التحليل ان استخدام حلقة فولاذية كتنقوية حول الفتحة الثمانية تساهم بتقوية جذع العتبة و تقليل هكذي انواع من الفشل. بالاضافة لذلك ان استخدام الحلقة الفولاذ يقلل من تركيز الاجهادات حول حافة الفتحات ويحسن من سلوك هذه العتبات من خلال زيادة التحمل الاقصى وتقليل انفعال التشوه. تم استخدام طريقة العناصر المحددة لتحليل العتبات القلعوية ذات الفتحات السداسية والثمانية الشكل التي تم صنعها من مقطع فولاذي نوع (IPN140). من خلال دراسة النتائج العددية التي حصلنا عليه بواسطة استخدام برنامج ANSYS 14، لوحظ ان التحمل الاقصى للعتبات القلعوية يمكن تحسينها باضافة صفيحة فولاذية و حلقة فولاذية كتنقوية حول الفتحات. اذ لوحظ ان التحمل الاقصى للعتبات القلعوية ذات الفتحات ثمانية الشكل يمكن ان تزداد لحد (53%) اكثر من التحمل الاقصى للعتبة الام (IPN140) مع اضافة فولاذ (صفيحة مع حلقة فولاذية) بنسبة (13%) من الوزن الكلي للعتبة الام.

الكلمات المفتاحية: - شعاع الصلب المصبوب (CSB)، لوحة فاصل، حلقة الصلب التقوية، القوة في نهاية المطاف، للعتبة الام، طريقة عنصر محدود (FEM).

Introduction

Continued efforts have been put by structural engineers for improving the behavior of construction materials and their geometrical shapes. This is with the overall aim of obtaining light weight, high strength and low cost materials for constructing steel structures.

Structural engineers continually work to modify the behavior and geometries of building materials employed in steel structures construction to be lighter weight, higher strength and lower cost. During the Second World War, castellated steel beams were one such improvement occurred in built-up structural members to modify hot rolled I-section steel beams by increasing their stiffness and strength. Castellated steel beams are typically fabricated by cutting wide flange standard I-sections steel beam along its centerline and thereafter re-welding the generated two halves. The overall I-beam depth, as a consequence, could be increased up to 50% resulting in significance enhancing in its flexural strength as shown in Fig.(1).

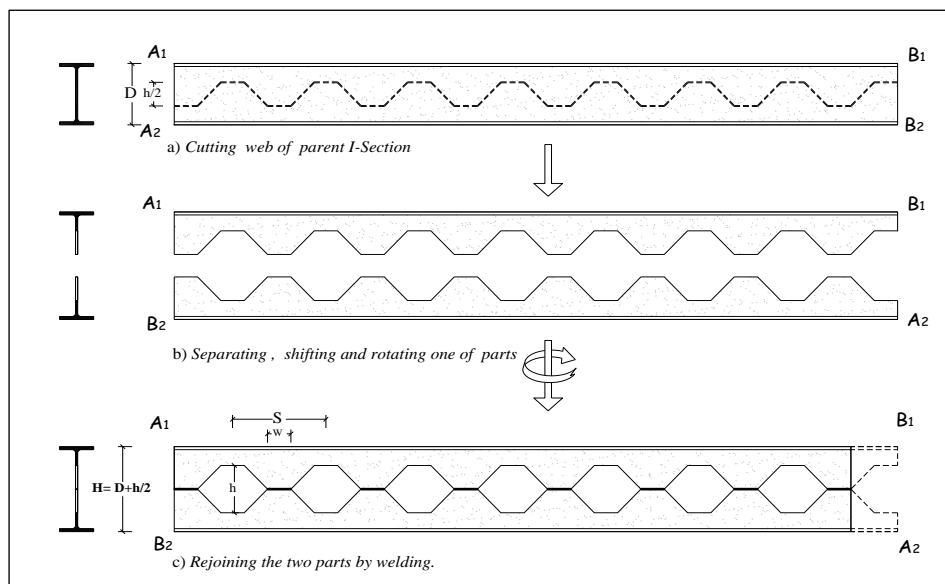

Fig.(1): Process of fabrication castellated steel beam with hexagonal opening.

The increase in depth of beam, which is obtained due to construction process, leads to modify the stiffness and strength of castellated beam compared to the original (parent) hot rolled one. Some cases of design make it advantageous to raise the depth more by adding increment plate between the two halves of the tee sections which are called "Spacer Plates" as shown in Fig.(2). The major disadvantage of castellated beam is that openings in the web of the beam usually lead to redistribution of the stresses within the member and also influences its collapse behavior. These openings decrease the stiffness of beams and hence resulting in larger deflection. For improving the behavior of castellated steel beam, stiffeners can be used to increase stiffness and to strengthen the moment resistance of steel plates along both longitudinal and transverse directions and also along the edge of opening. These stiffeners increased the buckling strength of web.

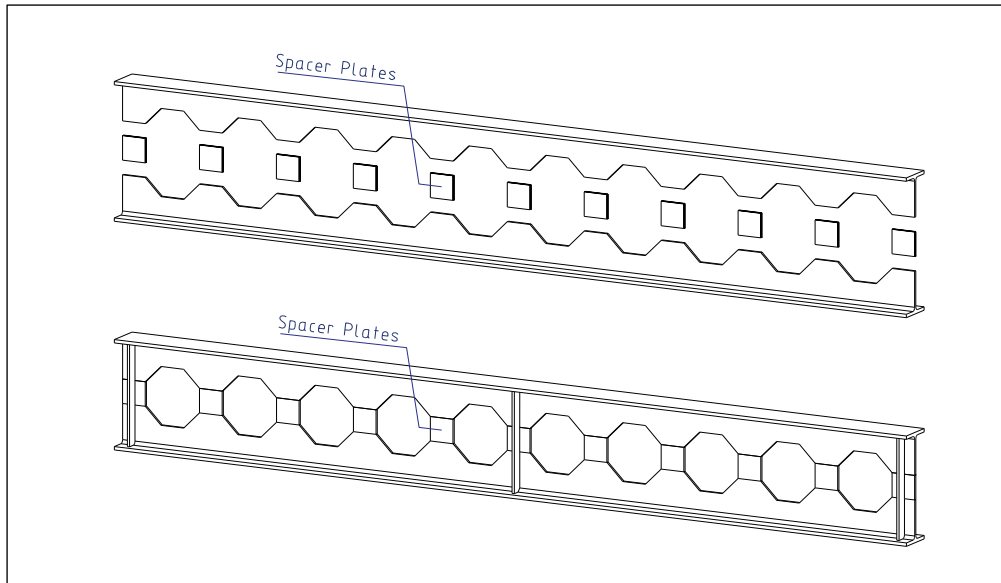

Fig.(2): Rejoined castellated steel beam with increment plate (octagonal opening)

In order to verify the numerical results and to investigate the non-linear behavior of failure modes, non-linear finite element models of steel castellated beams are developed to simulate the experimental cases by using (ANSYS Ver.14.0) program.

The present research aims to improve stiffness response and strengthen flexural behavior of octagonal castellated steel beam using steel rings as stiffeners around the edge of opening. Computational non-linear finite element method (FEM) analysis and a parametric study are employed to understand the behavior of a stiffened octagonal castellated steel beam with web openings.

Previous Studies And Research Gap

Konstantinos and Mello in (2011) investigated the behavior of castellated steel beams with webs of closely spaced openings by studying seven experimental specimens and fourteen numerical ones. The purpose of their work was to examine the potential impacts of various shapes and sizes of holes on the failure mode and ultimate strength of castellated steel beams. Finite element models of castellated beams with hexagonal, circular and elongated web openings were developed and analyzed by using ANSYS v11.0 software; The results were compared with seven experiments test specimens. They concluded that the maximum shear stresses spread from the mid-height of the web-post nearer to the flanges in the direction of the axial forces

In (2012), Soltani et al. developed a numerical model to study the behavior of castellated steel beams with hexagonal and octagonal openings up to failure. Their central objective was to investigate the web-post buckling. They stated that the use of spacer plates could make castellated steel beams more vulnerable to web-post buckling. Also, the numerical results revealed that depth of these plates must not be greater than (15%) of the overall opening depth.

Jamadar and Kumbhar in (2015) used finite element models by using ABAQUS software to obtain best dimension of opening for castellated steel beams. They investigated opening with hexagonal, circular and diamond shapes. The depth ratio of

overall castellated beam to the opening (D/d_o) and the spacing to depth opening ratio (S/d_o) were both taken into account. The numerical results which were experimentally validated confirmed that the beam gives best stiffness and strength results when the opening are with diamond shapes and with size of 0.67 times of overall beam depth.

From the previous studies, it can be concluded that there is a lack in research examining the behavior of castellated steel beam with octagonal opening (by additional increment or spacer plate) as shown in Fig.(2). In contrast, it can be noted that due to ease of the manufacturing, circular and hexagonal shape of openings are widely used in building and construction industries. In addition, most of the works have indicated that the failure of opening web beams has been happened due to local buckling failures in the web segment. Also, few studies have been carried out to strengthen castellated steel beams for avoiding local failure. It is noted that there is no regulated knowledge of how a castellated beam would behave if a stiffener is placed around the hole.

The growing strength of castellated steel beams should be carefully examined when such beams are exposed to concentrated loads. That is because this type of beams are suitable to resist distributed loads but not strong enough to carry high concentrated load. The response and modes of failure should be checked for providing best shape of stiffeners and appropriate region so that the beam efficiency is not compromised even at worst condition of stress concentration. Most standards have no provisions for the stiffeners of castellated steel beam and hence relevant guidelines are needed to be developed. This paper considers improving the flexural response of castellated steel beam by using increment plate (with octagonal open). Also, the current study aims to examine the effectiveness of strengthening castellated steel beam with octagonal opening by using ring steel stiffeners to reduce stress concentration.

Finite Element Model (FEM)

In this section, non-linear finite element models (NFEM) are used to simulate the castellated steel beams (CSB) and then to calibrate these models against experimental specimens. Geometrical and material non-linearities have been adopted in the numerical model on the purpose of determine the collapse phenomena that is as close as to the reality. The Newton- Raphson procedure was considered to obtain the nonlinear solution. In addition, shell element (SHELL181) is used to model the castellated beam as shown in Fig.(3). This type of elements has 4-nodes with six degree of freedom per node. This work aids in obtaining a mesh with minimal number of elements in order of modeling the castellated steel beam specimen as accurate as possible. A multi-linear stress- strain response (Elastic – Plastic – strain hardening model) and the Von Misses failure criterion have been adopted to capture the material nonlinearity of steel as shown in Fig.(4).

The geometrical nonlinearity was adopted by using a large strain theory that depends on the model deformed configuration. Taking non-linearity into account makes it possible for these large strains to be generated at the steel beam web as a result of the stress redistribution which usually can be happen around the web opening after starting of the first yield.

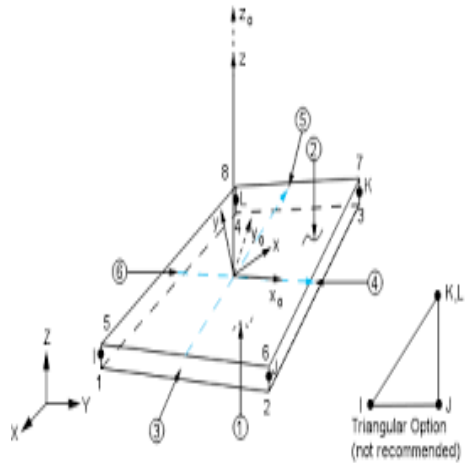

Fig.(3): SHELL181 element (ANSYS library).

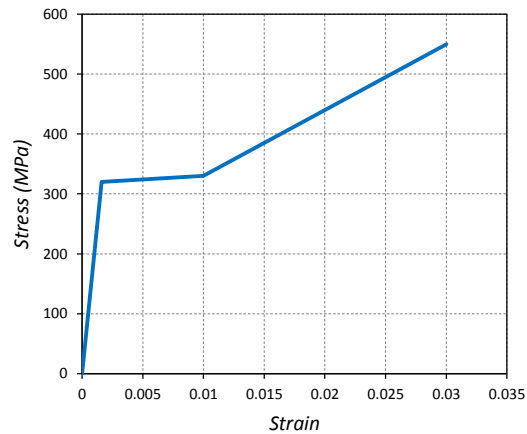

Fig.(4): Strain – Stress of steel plate.

Verification of Finite Element Models

Utilizing ANSYS software (ver. 14.0), finite element analysis of CSB model was carried out to calibrate with results obtained from the experimental castellated steel beam tested by Al-Thebhawee. Both the original I-section (IPE140) and the castellated steel beam specimens have been manufactured in correspondence with the numerical model results. The specimens were tested under a concentrated as shown in Fig.(5). The dimensions and properties of a castellated steel beam with span length of 1600mm and eight hexagonal opening fabricated as parent section can be seen in Fig.(6).



Fig.(5): Test setup for parent I-section and castellated steel beam with eight hexagonal opening

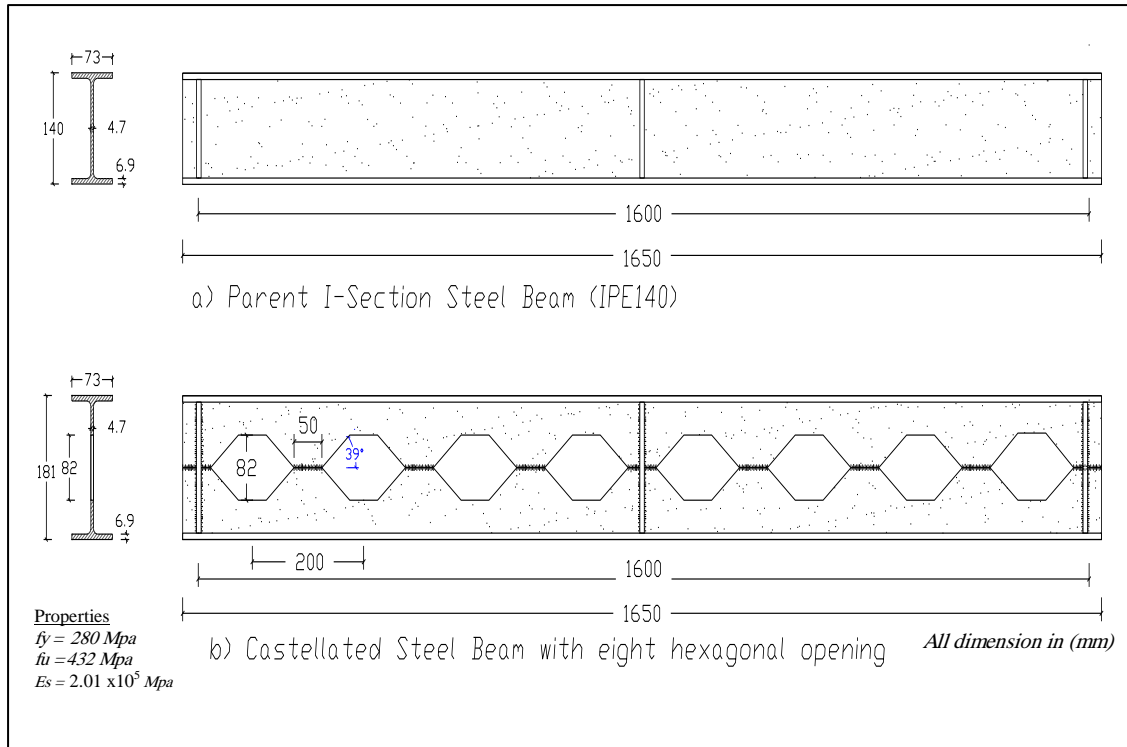

Fig.(6): Dimensions and properties of parent I-section and castellated steel beam

The numerical finite element model which was represented using shell elements (SHELL181) and the meshing model for castellated beam with eight hexagonal opening and parent section are displayed in Fig.(7). The computed failure load was slightly higher than the experimental failure load for the both cases. When the numerical model results of parent I-section and castellated steel beams are compared with experimental results, it is found that the failure load obtained from the nonlinear model is 11.2% more than that obtained from the experimental work for parent I-section steel beam and 8.7% more than the experimental one for castellated steel beam. Load-deflection curve that are obtained by the finite element model and the experimental work for both cases (parent I-section and castellated steel) are presented in Fig.(8).

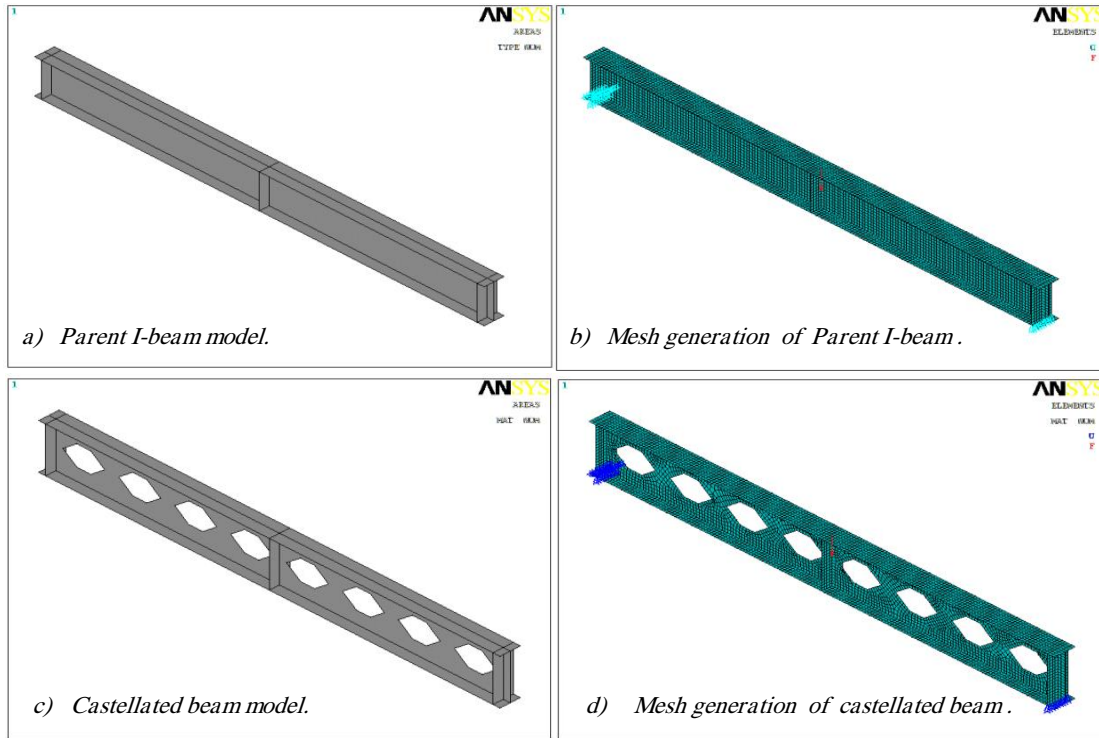

Fig.(7): Finite element models using ANSYS program of parent and castellated steel beams.

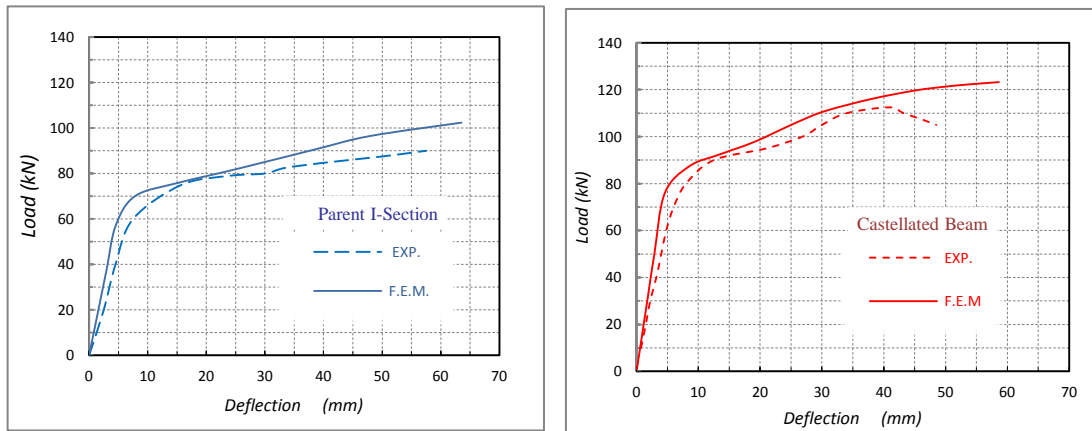

Fig.(8): Experimental and NFE models load - deflection curve of parent I-section and castellated steel beam.

Good agreement was shown between the predicated finite element and the experimental load-deflection curve throughout the entire range of loading of the tested specimens. These results verify the capability of the presented ANSYS model of dealing with castellated steel beam under concentrated load at mid-span. At failure load of castellated beam, the Von-Mises stress distribution of FEM results and a photograph of failure mode of experimental results are shown in Fig.(9). It can be observed that finite element-based failure mode for this case is very similar to the experimental failure one.

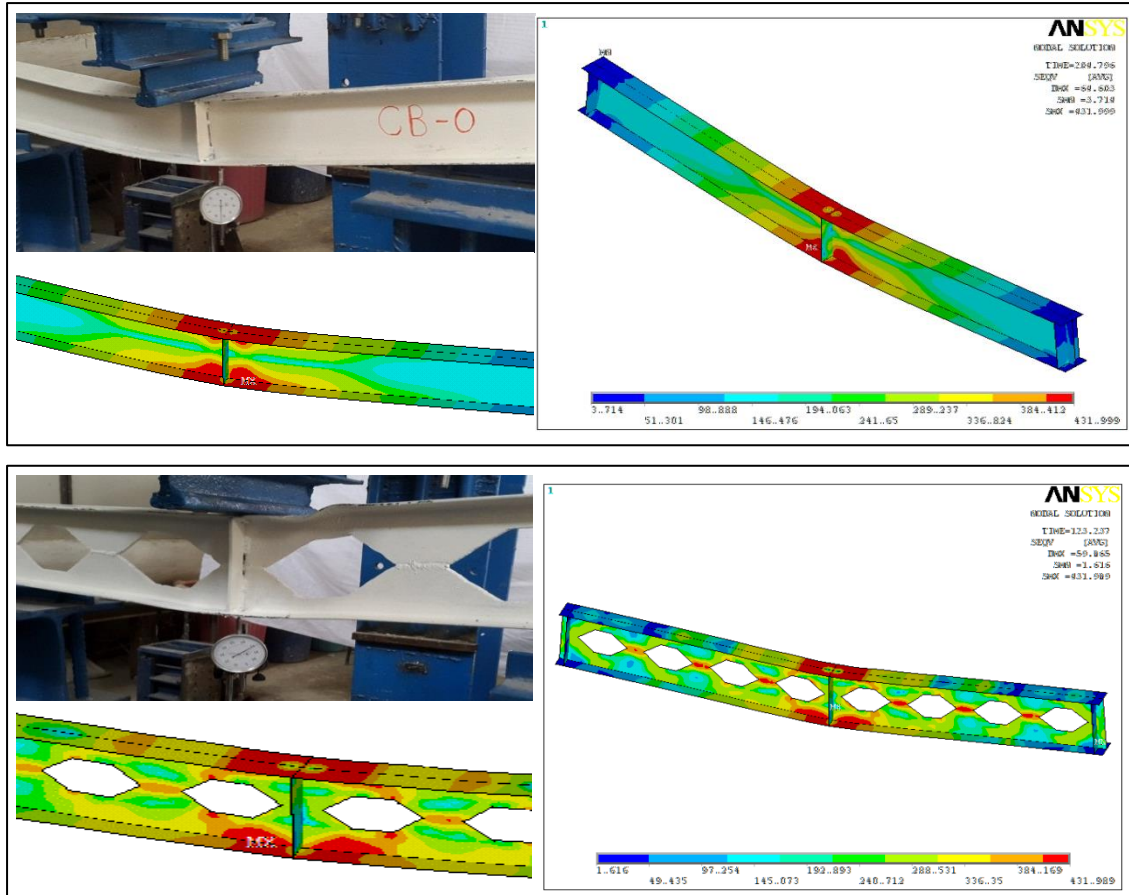

Fig.(9): Von- Mises stress distribution of parent section and castellated beam at failure loads.

F.E.M of Castellated Beam (CSB) with Octagonal Openings

As an attempt to improve the behavior of castellated steel beam, the parent section which is shown in Fig.(10-a) has been re-fabricated by using cutting angle (45°) instead of angle (39°) which was previously used in fabrication the specimens of hexagonal opening to achieve equal edge sides (See Fig.10-b). The purpose of making the castellated beam with equal edges hexagonal opening is to obtain octagonal opening with equal edge sides after adding the increment plate as shown in Fig.(10-c). This shape and geometry of opening allowed to use steel ring as stiffeners to strengthen castellated beam as shown in Fig.(10-d). Figure (11) exhibits key details and dimensions of the steel ring used as stiffeners to strengthen the octagonal castellated beam. Same material properties, loading and boundary conditions have been applied on parent section (PISB), (CHOB), (COOB) with spacer plate and (COOBR) with ring steel stiffeners having thickness ($t=3.0\text{mm}$) and width ($w=20\text{mm}$) is adopted and modeled by the finite element model. Figure (12) shows the finite element models developed using ANSYS software to study the flexural response.

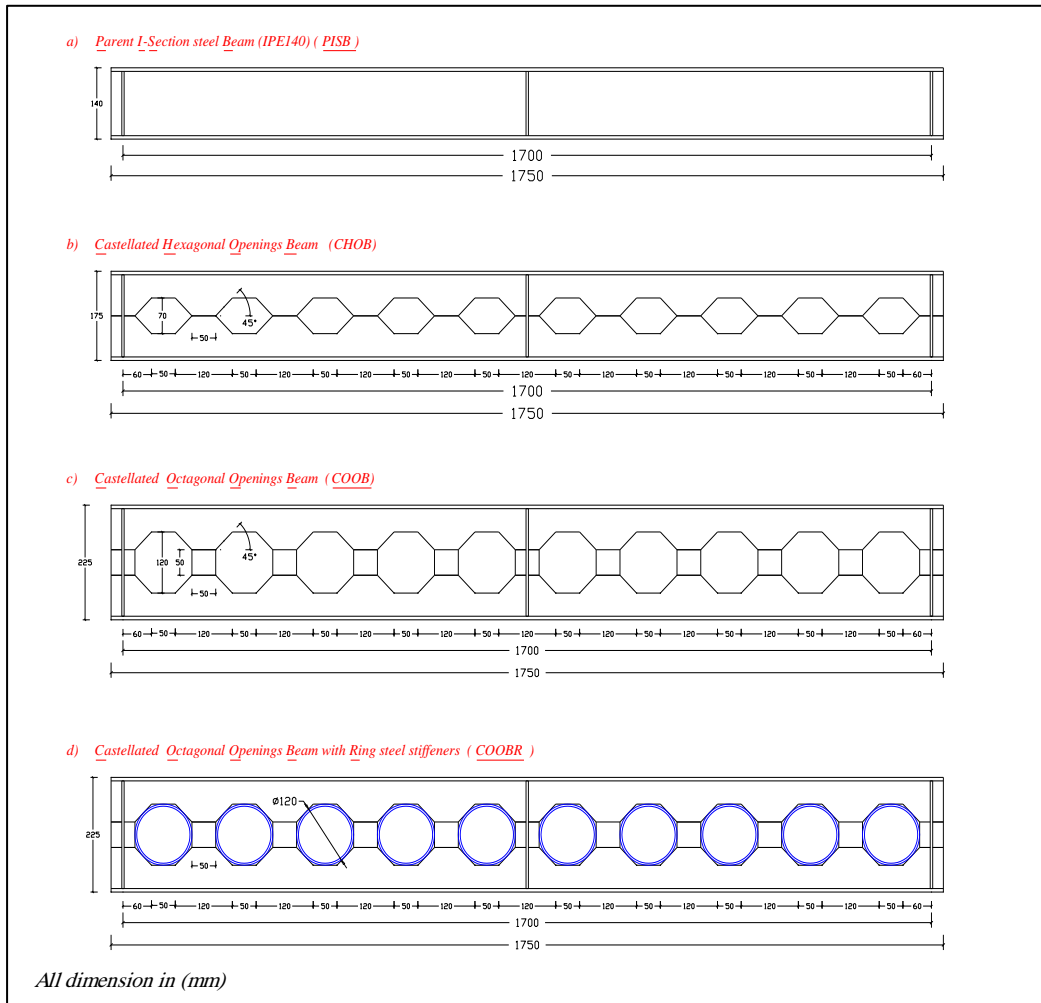

Fig.(10): Dimensions and details of cases studied:

- a) *Parent I-section beam (PISB)*
- b) *Castellated hexagonal opening steel beams(CHOB).*
- c) *Castellated octagonal opening steel beams (COOB)*
- d) *Castellated octagonal opening steel beams with ring stiffeners (COOBR)*

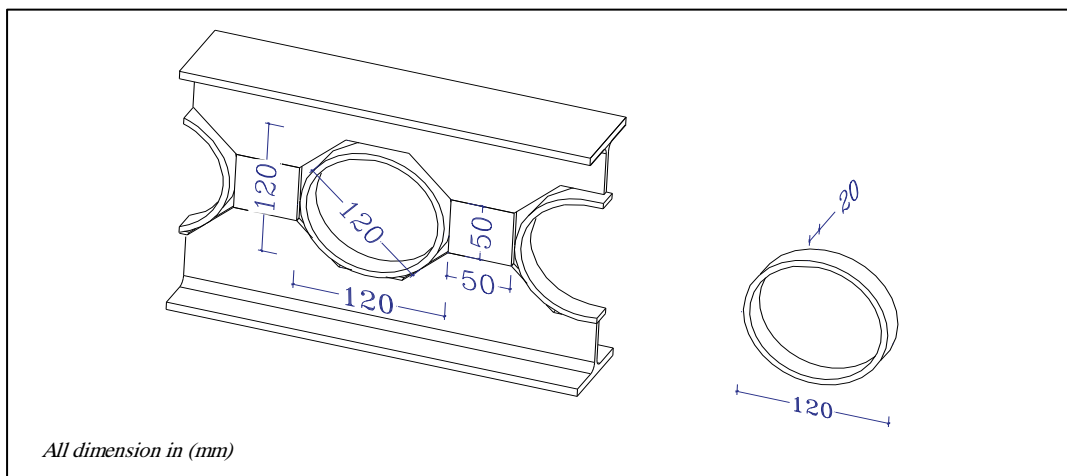

Fig.(11): Details and dimension of ring steel stiffeners of octagonal castellated beam.

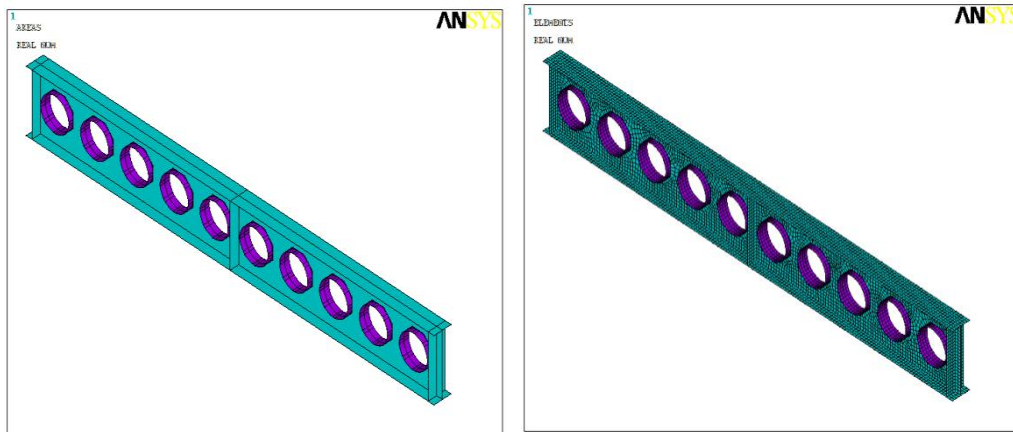

Fig.(12): Finite element models of octagonal castellated steel beams with ring steel stiffeners .

From the results of finite element analysis, it is noted that the failure load which obtained from castellated beam with spacer plates (octagonal opening) is (12.0%) more than that for the same beam but without spacer plate (hexagonal opening) and 33.0% more than the parent I-section beam. In addition, the stiffness and failure load of castellated beam with stiffeners (COOBR) was improved in comparison with castellated beam without stiffeners (COOB). Interestingly, the results also revealed that the percentage of failure load for (COOBR) is (52%), (40%) and (19%) more than failure load of (PISB), (CHOB) and (COOB) respectively. Load-deflection diagrams that are obtained by the finite element models of (PISB), (CHOB), (COOB) and (COOBR) are illustrated in Fig.(13).

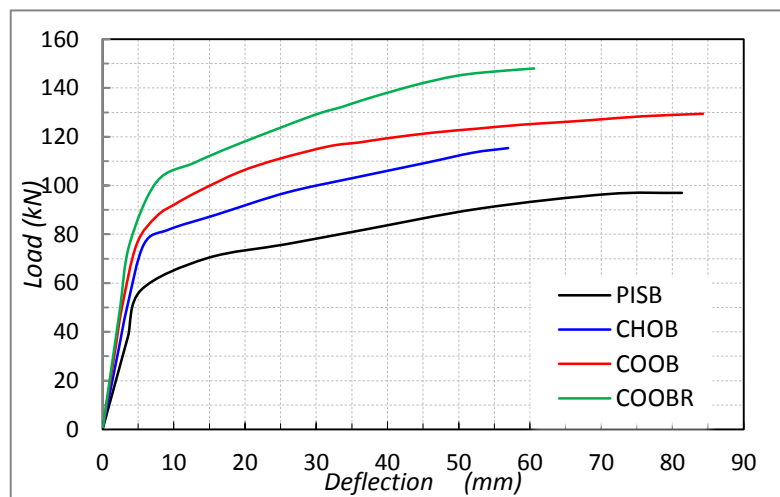

Fig.(13): Load –Deflection of (PISB, CHOB, COOB and COOBR).

Figure (14), Fig.(15) and Fig.(16) display the improvement in stress distribution and stiffness for castellated beam with stiffeners (COOBR) compared with those of parent section (PISB 96.7 kN), castellated hexagonal opening beam (CHOB 115.3 kN) and castellated octagonal opening beam (COOB 129.0 kN) respectively. Furthermore, Fig. (17) shows the stress distribution and stiffness of castellated octagonal beam with ring steel stiffeners at failure load (148.0kN). The figure reveals that a significant increase in stiffness and failure load have been achieved by using the steel ring to

reinforce the boundary of web opening. It is also can be noted that the percentage of material added for improvement (spacer plate and ring steel) is equal to (13%) but with the ultimate load is considerably increased to (52%) compared with ultimate load of parent beam (PISB). To sum up, analysis results indicated that the use of ring steel stiffeners around web opening leads to minimize the deflection and increase the ultimate strength. These stiffeners help in reducing the stress concentration around the openings.

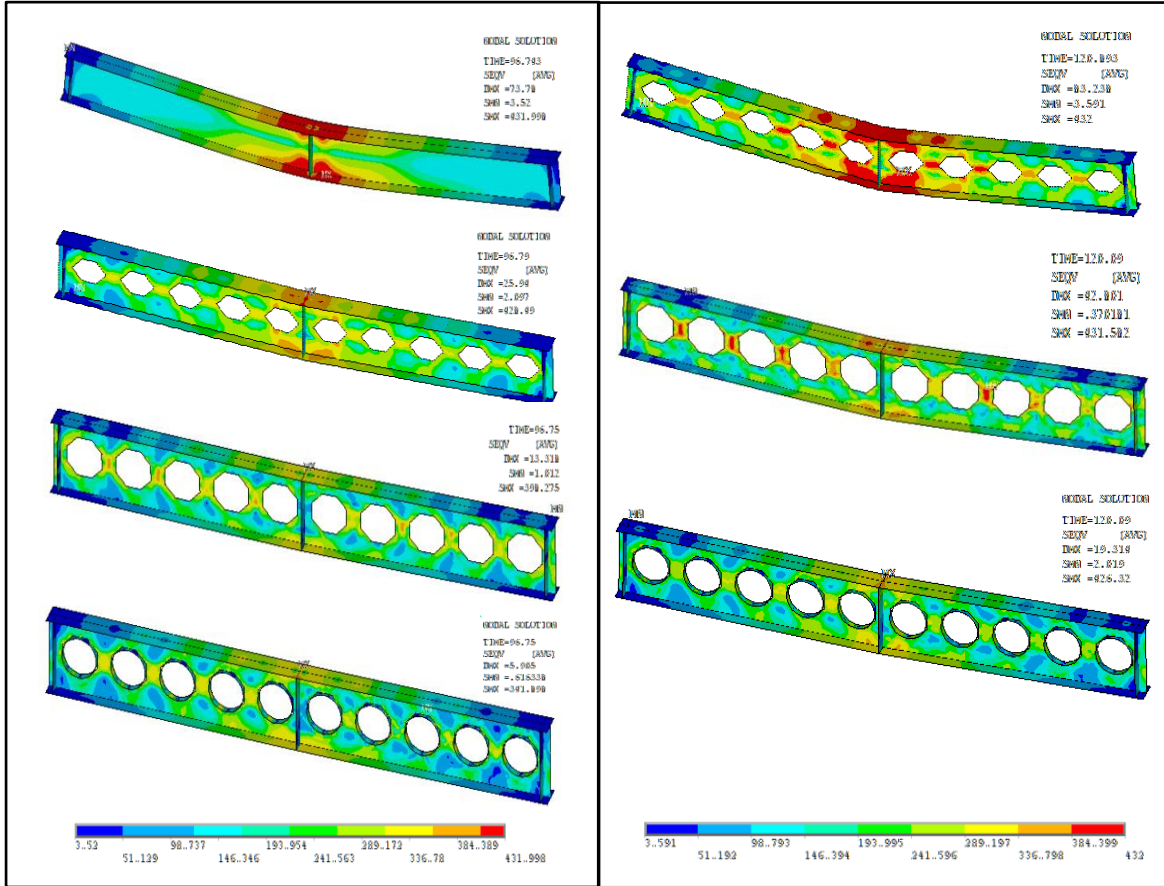

Fig.(14): Stress distribution and deflection of (PISB, CHOB, COOB and COOBR) at failure load of (PISB = 96.7kN).

Fig.(15): Stress distribution and deflection of (CHOB, COOB and COOBR) at failure load of (CHOB = 115.3 kN).

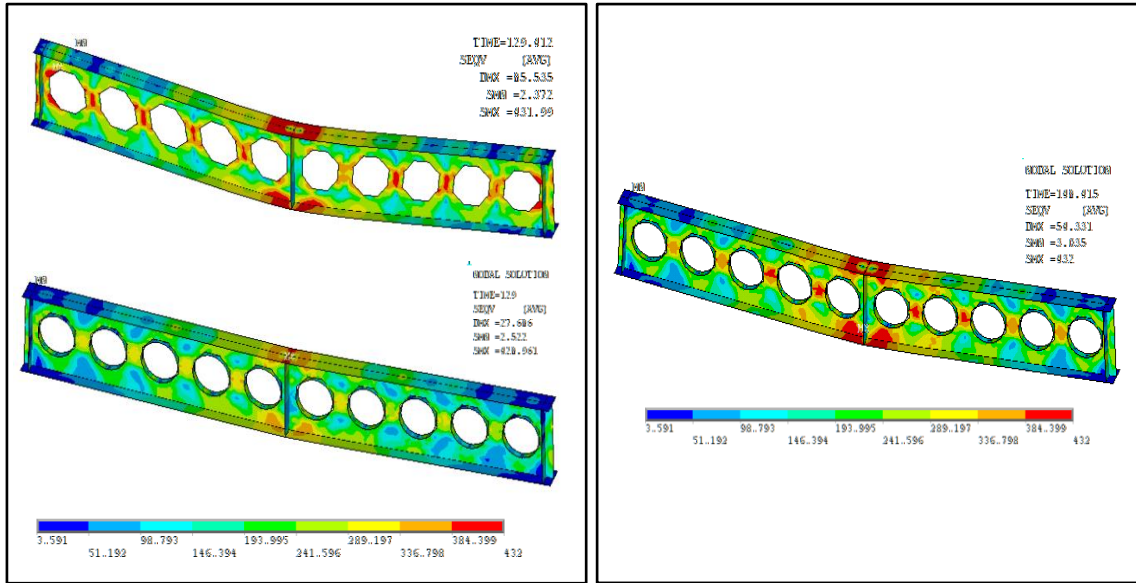

Fig.(16): Stress distribution and deflection of (COOB and COOBR) at failure load of (COOB = **129.0kN**).

Fig.(17): Stress distribution and deflection of (COOBR) at failure load of (COOBR= **148.0kN**).

Effects of Thickness of Ring Steel Stiffeners on Ultimate Strength

In order to investigate the effect of thickness of ring steel stiffener on failure load for octagonal castellated beam (COOBR), four different thicknesses of stiffeners (t_r) (1.5mm, 3.0mm, 4.5mm and 6.0mm) were analyzed by using Non-linear Finite Element Method (FEM). Figure (18) graphically summarizes the effects of the different thicknesses of stiffener steel ring on the load–deflection behavior of (COOBR). According to numerical tests, I-section beam can be strengthened by adding only small amounts of material.

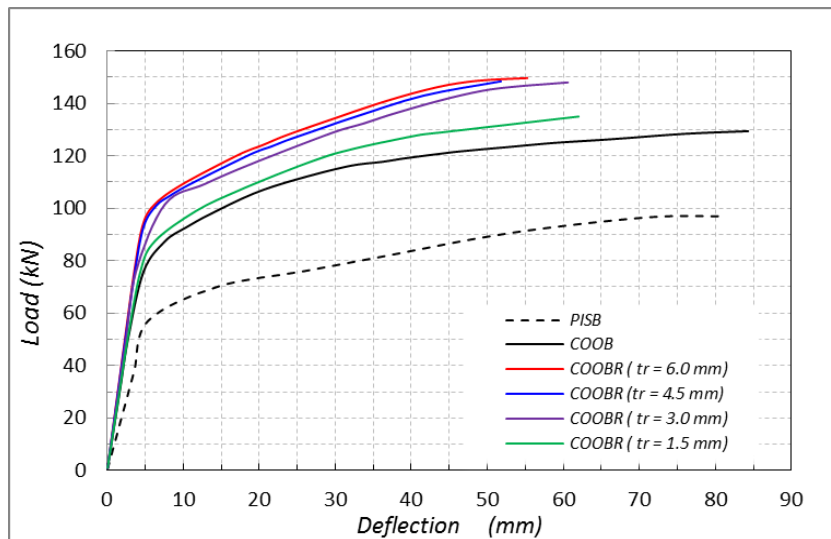

Fig.(18): Effect of thickness of ring steel stiffener on Load – deflection diagram.

In Table (1), it can be seen that the failure load is increased up to (19.0%) without any additional weight (hexagonal hole). Also it is increased up to (33%) with (4.0%) additional weight as spacer plate (octagonal hole) and up to (53%) with (13%) additional weight as spacer plate plus ring steel (octagonal hole with ring stiffeners has thickness equal 3.0mm). Nevertheless, analysis results confirmed that the ultimate strength was with insignificant increase when steel ring thickness increased beyond 3.0mm.

Table(1): Effects of additional material and thickness of stiffener steel ring on ultimate strength.

	Ring Stiffeners		Weight (kg)	$\left(\frac{w-w_o}{w_o}\right) \times 100$	U.L. (kN)	$\left(\frac{UL-UL_o}{UL_o}\right) \times 100$
	Thickness (mm)	Width (mm)				
<i>PISB</i> (IPE140)	—	—	21.22 (w_o)	100%	96.99 (UL_o)	100%
Castellated	—	—	21.22	100%	115.34	119%
Castellated +PL	—	—	22.14	104%	129.41	133%
Castellated +PL + Ring	1.5	20	23.02	108%	135.00	139.6 %
Castellated + PL + Ring	3.0	20	23.90	113%	148.00	153%
Castellated +PL + Ring	4.5	20	24.78	117%	148.42	153%
Castellated + PL + Ring	6.0	20	25.67	121%	149.64	154%

Conclusion

This study has come with the following conclusions:

- 1- Analysis results revealed that the failure load obtained from the nonlinear model is 11.2% more than that obtained from experimental work for parent I-section steel beam (IPN 140) and 8.7% more than that obtained from experimental work for castellated beams with eight hexagonal opening.
- 2- The numerical results indicated that castellated steel beam with octagonal opening (with spacer plate) has given more satisfying results of ultimate strength than these with hexagonal opening (without spacer plate). Speaking in numbers, the ultimate load can be increased up to (14%) when using spacer plate with only 4% additional material.
- 3- According to the numerical results, flexural stiffness and ultimate strength of octagonal castellated beam (with spacer plate) can be improved by providing ring steel stiffeners around web opening. Adding (13.0%) weight of steel (4.7 mm spacer plate plus ring steel stiffeners of 3.0mm thickness and 20mm width) to a castellated steel beam can lead to an increase in the ultimate strength of up to (53%) relative to the parent section (IPN140).
- 4- Analysis results also indicated that the use of ring steel stiffeners around web opening of castellated beams can effectively contribute in minimizing deflection and maximizing ultimate strength. These stiffeners which were provided to strengthen the edge of web opening can reduce the stress concentration along openings.

References

- Al-Thabhwawee H. W., 2017 . "Experimental Study of Effect of Hexagonal Holes Dimension on Ultimate Strength of Castellated Steel Beam". Kufa Journal of Engineering, Vol. 8, No.1, pp. 97-107.
- Boyer, 1964 . " Castellated Beams—New Developments ". AISC Engineering Journal , pp. 104–108. [01]
- Galambos A.R., Hosain M.U., and Spin W.G., 1975, "Optimum expansion ratio of castellated steel beams. Engineering Optimization, London, Great Britain, Vol. 1. pp 213- 222.
- Jamadar and Kumbhar, 2015 . " Parametric Study of Castellated Beam With Circular and Diamond Shaped Openings". International Research Journal of Engineering and Technology, Volume: 02, Issue: 02, pp. 715–722.
- Konstantinos T. D. and Mello C., 2011 . "Web Buckling Study of The Behavior And Strength of Perforated Steel Beam With Different Novel Web Opening Shapes". Journal of Constructional Steel Research, Vol. 67, pp. 1605-1620.
- Siddheshwari and Popat, 2015 . " Study of castellated beam using stiffeners: a review ". International Journal of Research in Engineering and Technology, Volume 4 , Issue 11, pp. 50-54.
- Soltani et.al., 2012 . " Nonlinear FE analysis of the ultimate behavior of steel castellated beams". Journal of Constructional Steel Research 70, pp. 101–114.
- Wakchaure , Sagade and Auti, 2012 . " Parametric Study of Castellated Beam With Varying Depth of Web Opening ". International Journal of Scientific and Research Publications, Volume 2, Issue 8, pp. 1–6.