

Bearbeitet von/ Compiled by:
Paolo Balsari, Hans-Joachim Wehmann

SPISE 7

7th European Workshop on
Standardized Procedure for the
Inspection of Sprayers in Europe
Athens, Greece
September 26-28, 2018

Berichte aus dem Julius Kühn-Institut

196



Kontaktadressen/ Contacts

Prof. Paolo Balsari
Full Professor
Department of Agricultural Forest and Food Sciences (DISAFA)
University of Torino (Italy)
L.go Braccini 2
10095 Grugliasco
Italy
Telefon +39 - 011 - 670 8587
Telefax +39 - 011 - 670 87 91
paolo.balsari@unito.it

Hans-Joachim Wehmann
Julius Kühn-Institut
Bundesforschungsinstitut für Kulturpflanzen
Institut für Anwendungstechnik im Pflanzenschutz
Messeweg 11/12
38104 Braunschweig
Germany
Telefon +49 (0) 5 31 -2 99 36 59
Telefax +49 (0) 5 31 -2 99 30 12
at@julius-kuehn.de

Wir unterstützen den offenen Zugang zu wissenschaftlichem Wissen.
Die Berichte aus dem Julius Kühn-Institut erscheinen daher als OPEN ACCESS-Zeitschrift.
Alle Ausgaben stehen kostenfrei im Internet zur Verfügung:
<http://www.julius-kuehn.de> Bereich Veröffentlichungen – Berichte.

We advocate open access to scientific knowledge. Reports from the Julius Kühn Institute are therefore published as open access journal. All issues are available free of charge under <http://www.julius-kuehn.de> (see Publications – Reports).

Herausgeber / Editor

Julius Kühn-Institut, Bundesforschungsinstitut für Kulturpflanzen, Braunschweig, Deutschland
Julius Kühn Institute, Federal Research Centre for Cultivated Plants, Braunschweig, Germany

Vertrieb

Saphir Verlag, Gutsstraße 15, 38551 Ribbesbüttel
Telefon +49 (0) 5374 6576
Telefax +49 (0) 5374 6577
verlag@saphirverlag.de

ISSN 1866-590X

DOI 10.5073/berjki.2018.196.000



Dieses Werk ist lizenziert unter einer [Creative Commons – Namensnennung – Weitergabe unter gleichen Bedingungen – 4.0 Lizenz](https://creativecommons.org/licenses/by-sa/4.0/).

This work is licensed under a [Creative Commons – Attribution – ShareAlike – 4.0 license](https://creativecommons.org/licenses/by-sa/4.0/).

Table of Contents

Preface	7
Round Table	
Status Quo of inspection in EU: the results of SPISE enquiry	9
<i>H.-J. Wehmann</i>	
Inspection system for in use pesticide application equipment in Greece. First three years of application	23
<i>G. Bourodimos^{1,2}, A. T. Balafoutis³, M. Giamouri¹, S. Fountas²</i>	
The inspection quality assurance: present situation and needs	31
<i>Jan Langenakens</i>	
The CEMA decal - promotion of the inspection of brand new sprayers	33
<i>Christoph Schulze Stentrop</i>	
The importance of sprayer inspections in the EU from a chemical industry perspective	37
<i>Manfred Roettel¹; Volker Laabs²; Steward Rutherford³</i>	
Session 1: Present experiences and challenges in inspections activities	
Present experiences and challenges in inspections activities in Serbia	45
<i>Aleksandar Sedlar¹, Vladimir Višacki¹, Rajko Bugarin¹, Petar Radić²</i>	
The Belgian experience with sprayer inspection activities and future challenges	52
<i>Johan Declercq¹, Guillaume Defays², Bruno Huyghebaert², David Nuyttens¹</i>	
Assessment of the sprayer inspection results in Catalonia	58
<i>Francesc Solanelles, Ferran Camp, Alba Fillat, Felip Gracia</i>	
Session 2: Common procedures for Pesticide Application Equipment (PAE) risk assessment and for the evaluation of environmental benefit of the inspection	
Advice for risk assessment concerning the inspection of pesticide application equipment in use according to article 8 (3) of Directive 2009/128/EC	65
<i>Bruno Huyghebaert¹ David Nuyttens² Marie Stas¹, Jens Karl Wegener³</i>	
An approach to fulfill art 8 of directive 2009/128: procedure of risk assessment for pesticide application equipment	80
<i>M. Stas¹, G. Defays¹, D. Nuyttens², O. Mostade¹, J. Declercq², I. Zwertvaegher², D. Dekeyser², B. Huyghebaert¹</i>	
Session 3: Harmonized test methods for PAE not included in ISO EN 16122 series	
The SPISE Advice: Main goal and the activities done by SPISE TWGs	86
<i>Paolo Balsari</i>	
The importance of a harmonized sprayers inspection: The SPISE manual	90
<i>JP Douzals¹, V Polveche² and Z. Czaczyk³</i>	
Advice for the functional inspection of the dusters	97
<i>Paolo Balsari (DISAFA, Italy) Paolo Marucco (DISAFA, Italy) Emilio Gil (UPC, Spain)</i>	
Berichte aus dem Julius Kühn-Institut 196	3

SPISE Advice of Periodical inspection Granulate application equipment	111
<i>Ian Forman⁽¹⁾, Jaco Kole⁽²⁾</i>	
Research of an appropriate inert compound to use as an alternative to the granules of the plant protection products in the inspections of microgranulators	118
<i>Marco Manzone, Davide Allochis, Paolo Balsari</i>	
SPISE Advice of the Periodical inspection of misting equipment	126
<i>Tom Bals⁽¹⁾, Jaco Kole⁽²⁾</i>	
Advice for the functional inspection of plot sprayers with compression tanks	130
<i>Eskil Nilsson (VISA VI, Sweden) Jaco Kole (SKL, The Netherlands)</i>	
SPISE Advice of the Periodical inspection of fixed and mobile Rotary atomizers pesticide application equipment for band application.	147
<i>Tom Bals⁽¹⁾ Jaco Kole⁽²⁾</i>	
The future demand for an inspection of more advanced features on pesticide application equipment	151
<i>Christoph Schulze Stentrop (HARDI International A/S)</i>	

Poster Session

INNOSETA – Innovative training and influence on the quality of inspections. An overview of training organization in EU	154
<i>Emilio Gil</i>	
Applicability evaluation of draft test protocol for functional inspection of solid fumigant applicators.	160
<i>Gianluca Oggero¹, Paolo Balsari¹, Andrea Minuto², Paolo Vinotti²</i>	
Requirements for plot trial equipment and how to control	167
<i>Reinhard Friessleben</i>	
The effect of the type of sprayer bodies on the obtained coefficient of variation of sprayed liquid deposition	171
<i>Stanisław Parafiniuk¹, Marek Milanowski¹, Witold Kowalik¹ Milan Koszel¹, Marek Kopacki²</i>	
Wireless flow-sensor to inspect spray rate controllers	176
<i>J. Declercq¹, E. Matthys¹, G. Defays², B. Huyghebaert², D. Nuyttens¹</i>	
New challenges about pesticide application equipment in Serbia: Usage of new nozzles types for better deposition and coverage.	181
<i>Višacki Vladimir¹, Sedlar Aleksandar¹, Bugarin Rajko¹, Radić Petar², Turan Jan¹, Ponjičan Ondrej¹, Ivanišević Mladen¹</i>	
Effect of air distribution and spray liquid distribution of a cross-flow fan orchard sprayer on spray deposition in fruit trees	186
<i>J.C. van de Zande, J.M.G.P. Michielsen, H. Stallinga, P. van Dalfsen, M. Wenneker</i>	
Assessment of some measurement methods for the inspection of spray application equipment	193
<i>Francesc Solanelles, Ferran Camp, Alba Fillat, Felip Gracia</i>	
Sprayers inspection in Venetian Region: experiences, issues and future perspectives	198

Cristiano Baldoin

20% reduction of crop protection products in the five main grapes of Sardinia (Cannonau, Carignano, Cagnulari, Nuragus, Vermentino)	209
Homologation and inspection of spray drones in Switzerland	211

Thomas Anken

Session 3: Harmonized test methods for PAE not included in ISO EN 16122 series (continue)

The SPISE Advice for functional inspection of wiper applicator.	214
<i>Paolo Balsari¹, Gianluca Oggero¹, Jaco Kole²,</i>	
The SPISE Advice for functional inspection of seed treatment equipment	222
<i>Hans-Jürgen Osteroth¹ Eskil Nilsson²,</i>	
Advice for functional inspection of postharvest application equipment	231
<i>Francesc Solanelles</i>	

Session 4: Inspection quality: “Certification” of the Workshop activity (quality assurance) included the certification of devices/instruments used for the inspections

“Certification” of the Workshop activity (quality assurance) included the certification of devices used for the inspections	236
Quality assurance of the workshop activity - including test facilities	243
<i>Harald Kramer</i>	
Quality control of the workshops, the Danish approach	248
<i>Hans Henrik Pedersen¹, Bo Grubov¹, Anita Fjelsted², Jaco Kole¹</i>	
Self-inspection of sprayers and seed treatment machines in Poland – proposal of instruction manual	252
<i>Grzegorz Doruchowski, Artur Godyń, Ryszard Hołownicki, Waldemar Świechowski</i>	

Session 5: Additional Workshops activities including PAE adjustment

What to be considered when you buy a sprayer: the SPISE advice	259
<i>Emilio Gil¹ and Christoph Schulze-Stentrop²</i>	
Effect of sprayer boom curvature on spray distribution: test on spray distribution bench	263
<i>M. Stas¹, G. Defays¹, P. Bienfait¹, G. Dubois¹, A. Delooz J¹, O. Mostade¹</i>	
Sprayers adjustment at the workshop thanks to the use of a dedicate software	268
<i>Gianluca Oggero¹, Paolo Balsari¹, Fabrizio Stefano Gioelli¹, Luisa Cavargna Bontosi², Federico Spanna³</i>	
A test method to assess operator safety using Closed Transfer Systems	276
<i>Jens Karl Wegener, Matthias Kemmerling, Jan-Philip Pohl, Eckhard Immenroth</i>	

Session 6: Inspectors training harmonization and refreshment

Inspector’s training and influence on the quality of inspections. An overview of training organization in EU	282
<i>Emilio Gil</i>	

Spanish's experience on improving inspection of sprayers: official manual for ISO 16122 and ISO 16119	287
--	------------

Emilio Gil, Javier Campos and Paula Ortega

Excursion - the program of the 27th September 2018

Technical Visit to Epidaurus	292
-------------------------------------	------------

General

Scientific Committee	298
Organizing Committee	298
Sponsors	299

Preface

Plant protection equipment must dose and distribute products exactly and function faultlessly. In order to achieve this, plant protection equipment should be inspected regularly to be able to identify and eliminate any technical defects.

However, there are three main arguments for the inspection:

- good control of the pest with the minimum possible input of crop protection product
- less potential risk of environmental contamination by crop protection products
- safety hazards for the operator

The inspection of plant protection equipment is becoming more and more interesting for the Member States (MS).

The 1st European SPISE workshop (Braunschweig, DE) took place in April 2004 in prompted by the publication of European Standard 13790; the 2nd European Workshop aims to support the MS in introducing inspections for plant protection equipment. This Workshop represented a platform on which to discuss further regulations for introducing, putting into practice and monitoring the inspections in the MS and for co-ordinating them. This was carried out in the form of lectures, working groups or excursions.

In some MS such as Belgium, Germany and the Netherlands, equipment inspections have been developed and established over the past few years, and although they are organised in different ways (state-run, private sector), they have all resulted in high-quality technical inspections, ensuring reliable and efficient plant protection equipment.

Within the 2nd SPISE workshop (Straelen, DE), the legal/statutory regulations and technical standards for successful plant protection equipment inspections already in force in the countries stated above have been presented as examples and described in detail. The excursions to the three MS have shown their practical implementation which could be analysed and taken as a basis for implementation in one's own MS.

The 3rd SPISE workshop (Brno, CZ) represented a platform on which to discuss further regulations for introducing, putting into practice and monitoring the inspections in the Member States and for co-ordinating them. In the meantime the Directive of the European Parliament and of the Council establishing a framework for Community action to achieve the sustainable use of pesticides obliges the Member States to ensure that pesticide application equipment in professional use shall be subject to inspections at regular intervals. The 3rd European Workshop informed the participants about the newest legal developments and showed which procedures/documents accompanying the article 8 of the Sustainable Use Directive (SUD) under the responsibility of the Member States are required. The Directive determines the key points. The development of procedures between the MS is left to the Member States according to the principle of subsidiarity. They have a fair amount of leeway and are able to take their own experience and conditions into consideration.

The 4th SPISE workshop took place in Lana, South Tyrol in March 2012. The aim was to support the introduction of inspections of plant protection equipment already in use in the Member States (MS) of the EU. Following the publication of Directive 2009/128/EC in October 2009, the Member States have to introduce technical inspections for plant protection equipment at regular intervals and ensure that all items of plant protection equipment have been inspected at least once by 2016. Due to the region of South Tyrol the focus this time was on the air-assisted sprayers. During the workshop the attendants were invited to register themselves in Technical Working Groups (TWGs). These 7 TWGs have the task to discuss and to prepare advices regarding up to now not clear details of article 8 of the SUD.

In October 2014 the participants of the 5th SPISE workshop met at Montpellier, France. During the 7 sessions the attendants were informed about the intermediate results of the TWGs. These groups met

in the meantime seven times. They presented the state of work and of the preparation of the so-called SPISE advices.

The SPISE 6 Workshop took place at Barcelona, Spain, on 13 to 15 September 2016. The locally organisation was under the responsibility of the Escola Superior d'Agricultura de Barcelona, Universitat Politècnica de Catalunya (UPC), Spain. The 6th edition of SPISE workshop covered important aspects: The recently published harmonized EN ISO 16122 for inspection of sprayers in use, and the deadline according the EU Directive 2009/128/EC – November 26th 2016 – for the accomplishment of the official mandate. It was an interesting opportunity to evaluate the present situation on MS and to understand the difficulties encountered and the necessary actions needed to solve them. It was also possible for the participants to evaluate and discuss about the recently entered in force harmonized standard on the inspections of sprayers used in greenhouse (ISO EN 16122-4). More than 40 presentations from the participants plus 7 posters showed the ongoing activities in the Member States and the current situation regarding the introduction of plant protection equipment mandatory inspections in the MS. As usual the second day was dedicated to practical demonstration of the sprayers' inspections activities this time with particular effort to the inspections of sprayers used in greenhouse.

Round Table

Status Quo of inspection in EU: the results of SPISE enquiry

H.-J. Wehmann

Julius Kühn-Institut, Institute for Application Techniques in Plant Protection,
Messeweg 11/12, 38104 Braunschweig, GERMANY

Summary

In preparation for the SPISE 7 workshop during the summer time of the year 2017 again a survey in the European Member States and other countries in Europe was carried out. The aim of this survey was to compile information concerning the actual situation of the inspection of pesticide application equipment PAE in use and this time especially the occurrence of problems connected to the implementation of an inspection system. The responsible colleagues of all involved countries got a short questionnaire where they gave new information. Special thanks to the reporters for this additional task.

Introduction

On the occasion of previous SPISE workshops in the years 2004, 2007, 2009, 2012 and 2016 similar surveys were carried out. With this actual survey the colleagues were asked for updating the data regarding the inspection of field and air-assisted sprayers, band sprayers, fixed and semi-mobile sprayers, foggers, PAE used for seed treatment, hand-operated and handheld sprayers, spray equipment mounted on aircrafts or trains, dusters, granular applicators and not handheld wipers. In detail the colleagues were asked for data regarding:

1. Number of PAE in use
2. Kind of data basis
3. Number of PAE inspected in 2016 and 2017
4. Basis for requirements for the inspection
5. Inspection fees
6. Percentage of defect PAE and TOP 5 of detected defects
7. Body/bodies responsible for implementing the inspection
8. Picture of current sticker
9. Number of current authorized workshops/ official teams and inspectors
10. Link to website where the addresses of authorized workshops are listed
11. Certificate system of quality control established
12. Definitions for destination of water used for measurements
13. Definitions for destination of old PAE intended to be scrapped
14. Definitions for mutual recognition of inspection from other Member States
15. Penalty system for use of not inspected PAE
16. Main problems during the introduction process

17. Questions intended to the European Commission concerning the mandatory inspection of PAE in your country
18. Knowledge of SPISE Advices
19. Knowledge of BTSF courses

26 of 37 asked countries returned at least partly filled questionnaires. Summarizing all data, it can be stated that the involved countries reported a mainly estimated existence of around 2.7 Millions of sprayers liable for inspection (Assumption: exemption of handheld and knapsack sprayers). This time 25 countries confirmed the already started inspection activities.

2. Assessment

The tables¹ summarizes the collected data regarding the number of inspections 2015 to 2017 separated for field crop sprayers and air-assisted sprayers for bush and tree crops.

Tab. 1 Inspection of field crop sprayers and air-assisted sprayers for bush and tree crops in the European Countries

Country	Field crop sprayers				Air-assisted sprayers for bush and tree crops			
	Number of sprayers in use	Number of sprayers inspected (2015)	Number of sprayers inspected (2016)	Number of sprayers inspected (2017)	Number of sprayers in use	Number of sprayers inspected (2015)	Number of sprayers inspected (2016)	Number of sprayers inspected (2017)
Austria	35.000	1600	8539	1955	18.000	2000	4403	1008
Belgium	19.053	5.703	5.155	5.239	1.781	566	611	438
Cyprus	1.500	0	0	0	no data available	no data available	no data available	no data available
Czech Republic	7.500	962	1.405	778	1.400	214	403	172
Denmark	12.000	2.591	3.488	2.353	333	64	99	74
Estonia	1.200		234	253	no data available	no data available	no data available	no data available
Finland	20.000	4.000	3.000	3.500	2.000	100	-	25
Germany	115.000	69.784	48.729	15.955	31.000	19.363	11.214	4.239
Greece	76.993	45	4030	7.336	27.736	55	3.857	5.852
Hungary	35.000	0	0	0	18.000	0	0	0
Ireland	20.000	-	2022	2.491	no data available	no data available	no data available	no data available
Italy	170.000	3863	13902	14.570	330.000	7.500	26.987	28.284
Latvia	9.600	130	233	550	400	5	10	23

Lithuania	21.190	1.642	1.713	1.452	212	12	35	19
Luxembourg	1.032	94	300	465	290	266	7	0
Netherlands	12.000	4.070	3.943	4.147	2100	534	720	713
Norway	12.000	no data available	1000	1.000	1.000	no data available	150	150
Poland	225.077	56.390	67.643	76.192	22.602	4.978	7.323	7.884
Portugal	25.000	419	1781	2.260	25.000	895	4.464	4.108
Serbia	132.000	457	500	300	30.000	85	200	100
Slovakia	4.500	63	74	324	550	31	15	76
Slovenia	12.040		5518	5.489	5.678		2.266	2.806
Spain	87.000	15.840	15.840	15.840	173.000	31.360	31.360	31.360
Sweden	14.000	2.000		(in2018) 6749	500	<100	no data available	no data available
Switzerland	20.000	3.000	2.798	2.492	6.000	1.000	994	832
United Kingdom	20.000	16.500	17.500	17.273	2.000	250	377	1.019

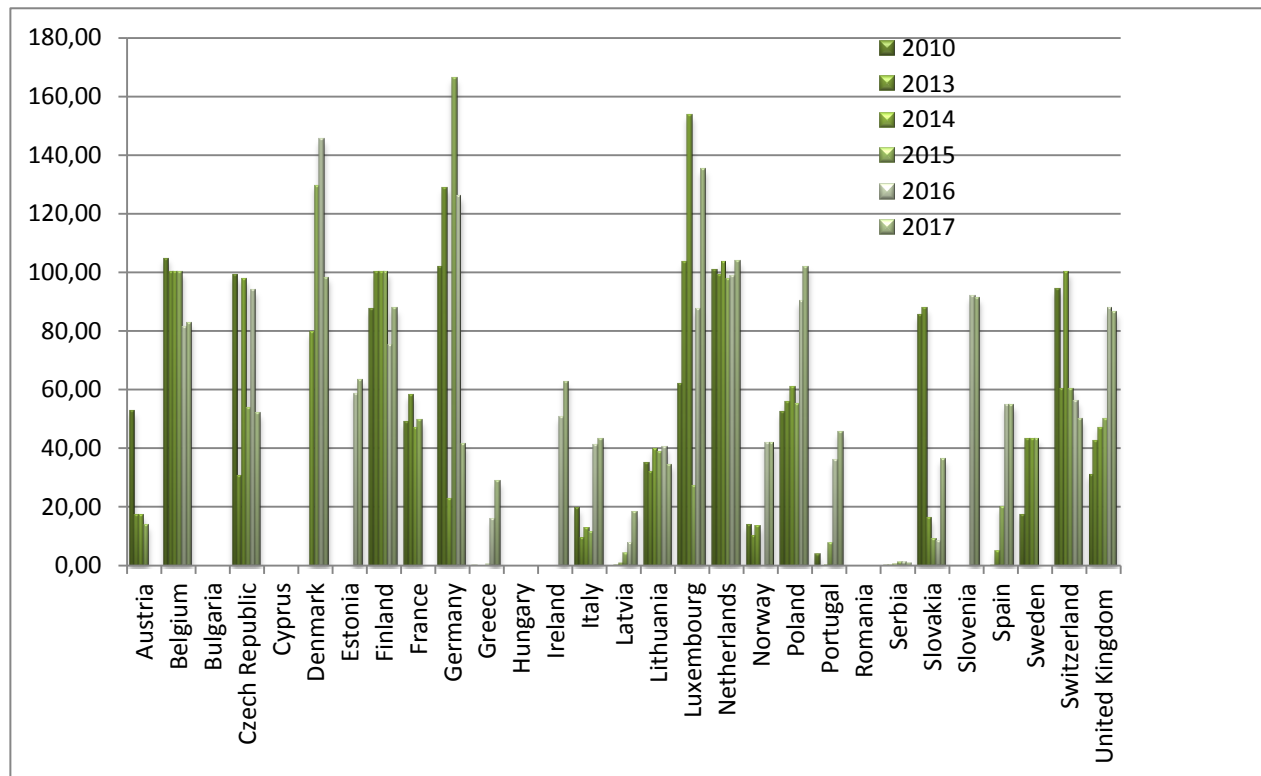

Tab. 2 Yearly inspected field crop sprayers as percentage of yearly requested inspections in the European Countries

Table 2 shows in which extent the users of field crop sprayers took part in the offered inspections. Yearly requested inspections in this case means: Number of sprayers in use divided by the inspection interval. From this value the percentage of real performed inspections was calculated. Assigned are the results from the time period from 2010 to 2017. The single columns show big differences of percentages, which range from 0 % up to about 160 %. For some countries only the last columns exist which demonstrate the newer existence of an inspection system. Looking to single countries the variability of the values is remarkable. Mainly this can be explained by changing the inspection intervals e.g. from 2 to 3 years in Germany. Only some few countries reach the 100 % mark regularly.

Tab. 3 Further data concerning the inspection systems in the European countries

Country	After how many years the inspection must be repeated	Average inspection cost (Euro) from...to ..	Number of authorized workshops (official teams)	Percentage of inspected sprayers (field crop) with defect (%)	Is there a certificate system established of quality control of inspection	Are there definitions for a mutual recognition of inspection in other MS	Is there a penalty system for the use of not-inspected PAE
Austria	3	130-200	119		no	yes	yes
Belgium	3	85-179,50	2 + 5	11	yes	Yes	Yes
Cyprus	no data	no data	no data	no data	no data	no data	yes

	available	available	available	available	available	available	
Czech Republic	5	80-280	48	no data available	No certificate, but superv. by UKZUZ	yes	yes
Denmark	5		5	92	yes	yes	yes
Estonia	3	50-90	10	12			
Finland	5	100-150	60	no data available	pending	yes	yes
Germany	3	60-350	900	41	Yes by federal states	yes	yes
Greece	3	50-150	150	83	yes	yes	yes
Hungary	3	125-150	no data available	no data available	no	no	no
Ireland	5	200-500	147	>25	yes	yes	yes
Italy	5	60-300	325	70	Yes in preparation	yes	yes
Latvia	3	50-200	5	6	Yes ISO 17020	yes	yes
Lithuania	5	58-85	12	17	yes	yes	yes
Luxembourg	3	60-250	6	< 5	yes	Soon (End of 2018)	Yes after 2020
Netherlands	3	120-350	162	53	yes	yes	yes
Norway	5	120-350	70	no data available	Yes in preparation	yes	yes
Poland	3		400	0	yes	yes	yes
Portugal	5	60-70	23	39	yes	yes	Yes
Serbia	3	100	2	85	no	no	no
Slovakia	5	160-350	13	90	yes	yes	yes
Slovenia	2	40	8	no data available	no	yes	yes
Spain	3	75-125	175	80	Yes	no	yes
Sweden	3	60-600	117	no data available	yes	yes	yes
Switzerland	4	80-120	62	5-10	yes	yes	yes
United Kingdom	1	80-300	462	50	yes	with Netherl.	yes

Table 3 shows some further aspects around the partly different introduced inspection systems in the European countries.

The still different organised inspection interval will step by step settle down by 3 years as prescribed at last for 2020 by the Sustainable Use Directive (SUD).

The cost for an inspection procedure mostly covers a big range, which is needed for the workshops/teams to work cost-covering at each time. Farmers will accept these costs mainly if they are informed regarding the benefits of such inspection, which is not only healthy, environmentally and safety relevant but often will save money.

Looking to the countries where data are available in the meantime nearly 3300 authorized workshops or teams are available to ensure that farmers must not accept very long access routes.

Furthermore the establishment of a certificate system is confirmed by about 80 % of the answering countries.

The question in which way is dealt with the water arising during the measurement of e.g. the cross distribution was answered by 4 different answers: 15 countries answered, that the water is pumped back to the spray liquid tank of the tested PAE. 6 countries reported that there are no special official requirements so that the water is not collected as long it is not polluted. Two countries report on a collection of the arising water in a separate tank. Three countries have no data available in this connection.

Regarding the scrapping of PAE which e.g. due to age or accidents cannot longer be used all countries reported that there are no special regulations in this case. 8 countries refer to the recommendations sometimes give in the owners' manuals. Two countries mention the national laws of waste in general.

This of course is an essential prerequisite for the mutual recognition of inspections of PAEs in use which is particularly mentioned in Article 8 of the SUD.

Nearly all countries in the meantime installed a penalty system to give special emphasis to the prohibition of use of not inspected PAEs.

For the first time the contact persons were questioned concerning the percentage of stated defects on PAEs. These answers diverge a lot. Here are statements which range from less than 5 % to 92 %. This fact leads to the assumption that the question wasn't right understandable. Of course the question was directed to know how often it occur that defect sprayers are presented to the Workshop stuff.

Also for the first time the contact persons this time were asked concerning the most detected defects. Reliable data were delivered for field crop sprayers and for sprayers for bush and tree crops. About 20 different defects were reported. The tables 4 and 5 show the number of reported defects by the countries. It can be determined, that wear and tear on nozzles is common. Also frequently occurring are defect manometers. Especially to be mentioned is the high amount of leakages on air-assisted sprayers for bush and tree crops. Here also problems with the pump flow rate occur more often. Both could be seen in the relation with the higher working pressure of those sprayers.

Tab. 4: the top ten defects of field crop sprayers in use mentioned by decreasing frequency

<u>Reported defects by the participating countries</u>	<u>Number of mentions</u>
1. Nozzle wear	18
2. Manometer	15
3. Anti Drip device	10
4. Leakages (Hoses and pipes)	9
5. Technical state of boom	6
6. Drive/PTO protection	7
7. Compensative return device	5
8. Pump flow rate	4
9. Tank content indicator	4
10. Pressure drop	3

Tab 5: the top ten defects of air-assisted sprayers used in bush and tree crops mentioned by decreasing frequency



<u>Reported defects by the participating countries</u>	<u>Number of mentions</u>
1. Leakages (Hoses and pipes)	18
2. Nozzle wear	15
3. Manometer	12
4. Pump flow rate	10
5. Filters (dirt/isolation device)	6
6. Spray liquid tank	6
7. Anti Drip device	5
8. Tank content indicator	4
9. Drive/PTO protection	2
10. Pressure valve	2





The last questions concern the knowledge of the existence of SPISE Advices and the expected benefit. Here all confirmed their knowledge and see the benefit of these booklets where official standards are not available.



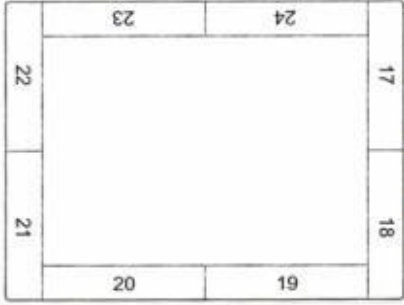

As well really all reporters know the BTSF courses and confirmed the participation in a course by them self or by a person working in the same field.

The minimum prerequisite for starting a contact with the aim of a mutual recognition is to know the addresses of the responsible bodies and the additional an example of the used inspection sticker. Therefore in the following table are assembled for all reporting countries the contact data of the responsible bodies and where available a picture of the current inspection sticker.

Tab. 6: Responsible bodies and examples of stickers of attending countries

<p>Austria</p>	<p>Office of the Provincial Government of Lower Austria: Landhausplatz 1, Haus 3 in 3109 Sankt Pölten (=St. Pölten), Vienna City Administration: Rathaus, 1082 Wien, Office of the Provincial Government of Burgenland: Europaplatz 1, 7000 Eisenstadt, Office of the Provincial Government of Styria: Burgring, 8011 Graz, Office of the Provincial Government of Upper Austria: Landhausplatz 1, 4021 Linz, Office of the Provincial Government of</p>	 <p>Each Federal State has a different sticker (here example for Steiermark)</p>
<p>Belgium</p>	<p>Federal Agency for Food Security is responsible (FAVV-AFSCA) and delegates to two regional bodies. Flemish part ILVO and Walloon part CRAW.</p>	
<p>Czech Republic</p>	<p>Ústřední kontrolní a zkušební ústav zemědělský - Central Institute for Supervising and Testing in Agriculture (ÚKZÚZ) Hroznová 63/2 656 06 Brno</p>	
<p>Cyprus</p>	<p>Department of Agriculture Ministry of Agriculture, Natural Resources and Environment www.moa.gov.cy</p>	

<p>Denmark</p>	<p>Ministry of the Environment and Food of Denmark, Danish Environmental Protection Agency Miljøstyrelsen Haraldsgade 53, 2100 København Ø</p>	
<p>Estonia</p>	<p>Plant Protection and Fertilizer department Agricultural Board of Estonia Teaduse 2 / 75501 Saku / Harju country www.pma.agri.ee</p>	
<p>Finland</p>	<p>Finnish Safety and Chemicals Agency (Tukes), P.O.Box 66, Helsinki, Finland</p>	
<p>France</p>	<p>MINISTRY OF AGRICULTURE / GIP PULVES (MONTPELLIER) GIP PULVES, 361 rue Jean François Breton BP 5095 34196 MONTPELLIER Cedex 5</p>	
<p>Germany</p>	<p>Plant Protection Services of the Federal States www.bvl.bund.de/DE/04_Pflanzenschutzmittel/02_Verbraucher/03_HausKleingarten/01_amtl_Auskunftsstellen/Auskunftsstellen_node.html</p>	

<p>Greece</p>	<p>Competent Authority: Directorate of Land Reclamation and Mechanical Equipment of the Ministry of Rural Development and Food. Reference Laboratory: Hellenic Agricultural Organization - DEMETER, Institute of Soil and Water Resources, Department of Agricultural Engineering, 61 Demokratias Str., 13561 Aghii Anargiri Attikis, Greece.</p>	
<p>Hungary</p>	<p>There is no responsible body for the implementations. Regulation mentioned above is under modification by the government.</p>	<p>?</p>
<p>Ireland</p>	<p>Department of Agriculture, Food & the Marine, Pesticide Controls Division Agriculture House, Kildare St. Dublin 2. Do2 WK12</p>	
<p>Italy</p>	<p>Italian Ministry of Agriculture through ENAMA (National Board for Agricultural mechanisation - www.enama.it - Address: via Venafro 5 ROMA) as coordinating authority between Regional Ministry</p>	 <p>Two examples of stickers used in different Italian regions</p>
<p>Latvia</p>	<p>State Plant Protection Service Lielvārdes iela 36/38 Riga, LV-1006, LATVIA www.vaad.gov.lv</p>	

Lithuania	<ol style="list-style-type: none"> 1. The Ministry of Agriculture of the Republic of Lithuania, Gedimino Ave.19, LT-01103 Vilnius, Lithuania 2. State Enterprise Machinery Testing Station, Neries str. 4, LT-54370 Domeikava, Kaunas distr. Lithuania 	
Luxembourg	Administration of technical services of agriculture depending on the Ministry of agriculture	
Netherlands	SKL, Agro Businesspark 24, NL-6708PW Wageningen, the Netherlands	
Norway	Norwegian Food Safety Authority, (Mattilsynet), Postbox 383 2381 Brumunddal, Norway.	
Poland	<p>Państwowa Inspekcja Ochrony Roślin i Nasiennictwa PIORiN (National Inspection of Plant Health and Seed, www.piorin.gov.pl, adress: Street: al. Jana Pawła II 11, 00-828 Warszawa, tel.+48 22 652-92-90, e-mail: gi@piorin.gov.pl) with 16 Voivodeship Plant Health and Seed Inspection Services. It is the inspection body of Ministry of Agriculture.</p>	

<p>Portugal</p>	<p>Ministry of Agriculture The coordination is done by Direção-Geral da Alimentação e Veterinário. Direção de Serviços de Meios de Defesa Sanitária. Divisão de Gestão e Autorização de Produtos Fitofarmacêuticos. Quinta do Marquês, 2770 - 155 Oeiras</p>	
<p>Serbia</p>	<p>University of Novi Sad, Faculty of Agriculture and University of Belgrade, Faculty of Agriculture</p>	
<p>Slovakia</p>	<p>Ministry of Agriculture and Rural Development of the Slovak Republic Coordination is carried out the Central Control and Testing Institute in Agriculture - Agricultural Technical and testing Institute Majerská 326 900 41 Rovinka Slovak Republic www.uksup.sk</p>	
<p>Slovenia</p>	<p>Ministry of Agriculture, Forestry and Food Dunajska cesta 22 1000 Ljubljana, Slovenija</p>	
<p>Spain</p>	<p>Local authorities are responsible. 17 different governments. Data collected by Ministry of Agriculture. Coordination under CEMA http://agricultura.gencat.cat/es/ambits/agricultura/cma_maquinaria_agricola/cma_03_serveis/cma_laboratori_referencia/</p>	

<p>Sweden</p>	<p>Swedish Board of Agriculture, Jönköping http://www.jordbruksverket.se/</p>	
<p>Switzerland</p>	<p>Schweiz. Verband für Landtechnik - SVLT Ausserdorfstrasse 31 5223 Riniken www.agrartechnik.ch</p>	
<p>United Kingdom</p>	<p>AEA, NSTS, 62 Forder Way, PE7 8, Peterborough</p>	

3. Conclusions

Summarising all data, it can be stated that not all involved countries reported the existence of a good working inspection system. There are still some problems to serve, one the one hand regarding the quality of the carried out inspection itself and on the other hand regarding a certain number of PAE which are being used even though they still have not been inspected. The contact persons see the following aspects as main reasons:

- Not enough farmer information
- Not enough high level of workshop activity control (certification system)
- No national/regional register of PAE in use
- No national register of PAE inspected
- Disunity within federalism systems
- Lack of knowledge about the inspection procedure
- Lack of interest among farmers, advisors, and even among authorities

4. Acknowledgement

The SPISE Working Group would like to express its thanks to all of the contact persons in the different European Countries. Also the submitted data are not pleasant in every case the reporters from the countries collected a big amount of information and gave this important input for a future planning. This is commendable.

Inspection system for in use pesticide application equipment in Greece. First three years of application

G. Bourodimos^{1,2}, A. T. Balafoutis³, M. Giamouri¹, S. Fountas²

¹ Hellenic Agricultural Organisation - DEMETER, Agricultural Engineering Department, Dimokratias Avenue 61, Ag. Anargiri, Athens, Greece

² Agricultural University of Athens, Department of Natural Resources & Agricultural Engineering, Iera Odos 75, 11855, Athens, Greece

³ Centre of Research & Technology Hellas, Institute for Bio-Economy & Agro-Technology, 6th km of Charilaou-Thermi Road, Thessaloniki, Greece

Abstract

According to Directive 2009/128/EC, all member states should have inspected all in-use Pesticide Application Equipment (PAE) by November 2016. In Greece, Law 4036/2012 embodied the provisions of this Directive into Greek legislation, but unfortunately due to various reasons, the inspections were significantly delayed. Aim of the current study is to briefly present the inspection system of in-use PAE that was developed due to the aforementioned law and then provide the statistical results of the inspections until February 2018. The progress of the last two years was significant, but a lot of work remains to make the inspection system functional and unproblematic.

Introduction

Directive 2009/128/EC, which establishes the regular inspection of in-use Pesticide Application Equipment (PAE), was incorporated into Greek law in 2012 with Law 4036. However, the system of mandatory periodic inspection of in-use PAE, which leads to the granting of certificate of inspection and sticker label, was actually introduced in Greece in 2015 by the Decision of the Deputy Minister of Production Reconstruction, Environment and Energy, numbered E8 1831/39763 and published in FEK 671/B/21-04-2015.

Until 2015 the controls of both new and in-use PAE were optional and the only body that carried out testing of these machines was the Department of Agricultural Engineering of the Hellenic Agricultural Organization - DEMETER, which in the period between 2000 and 2015 had carried out 17 tests of new machinery according to EN 12761 and 33 tests of in-use PAE according to EN 13790 under the program LIFE07 - EcoPest.

With the above Ministerial Decision, the Directorate of Land Reclamation and Mechanical Equipment of the Ministry of Rural Development and Food was designated as the Competent Authority for the regular inspection of PAE in Greece and the Department of Agricultural Engineering of the Hellenic Agricultural Organization - DEMETER as the Inspection Reference Laboratory.

In our country, the first Pesticide Application Equipment Inspection Stations (PAEIS) was established in September 2015 and the first inspections were made in early 2016. PAE inspected in 2016 will be re-tested in 2020 and then every three years, while PAE to be tested for the first time since 2017 and then will be re-tested every 3 years.

Inspection system for pesticide application equipment in use

The parties involved in the Inspection System are as follows (Figure 1):

The Inspection Reference Laboratory is responsible for the preparation of the PAE Inspection Manual and the Control of the PAEIS.

The Regional Agricultural Equipment Inventory Services (RAEIS) is responsible for the maintenance, updating and management of the Registry of PAE (RPAE).

The PAEIS that may be fixed or mobile and may be state and/or private entities owned by natural or legal persons. PAEIS must have the appropriate equipment and personnel to perform the inspections and are required to conduct inspections in accordance with the Inspection Manual.

The owner of the in-use PAE is responsible for (i) the registration of the PAE in the RPAE, (ii) the inspection of the PAE at a PAEIS of his/her choice, during which he/she must be present and (iii) the remediation of any deficiencies of the PAE identified during the inspection.

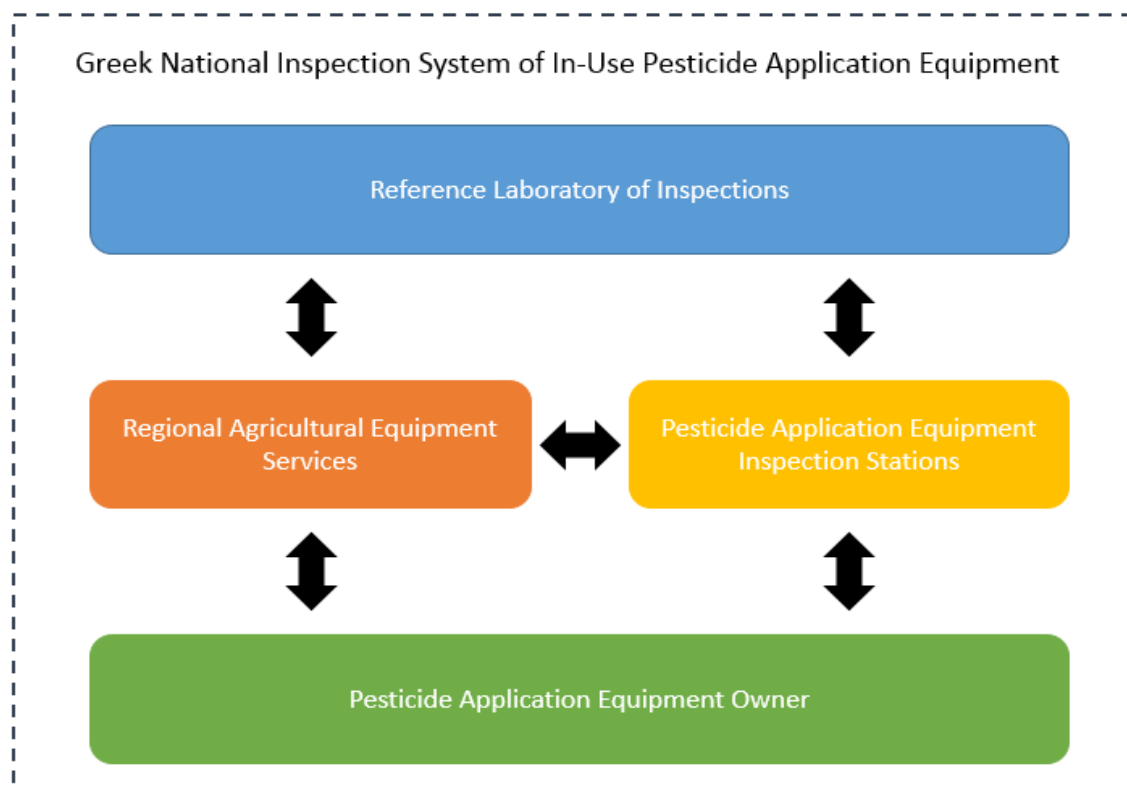

Figure 1. Interactions between the stakeholders of the national inspection

The Reference Laboratory's Inspection Manual sets out the requirements for the inspection of in-use PAE and has been prepared in accordance to the European Standards EN 13790-1: 2003 and EN 13790-2: 2003. A new version of the manual, based on the EN ISO 16122 series of standards, is in progress. To date, the types of machines that are under inspection in Greece are (i) air assisted tree and bush sprayers, (ii) boom sprayers and (iii) lance sprayers. At the moment, the inspections of knapsack sprayers and portable PAE are excluded from the law, but an amendment to the Ministerial Decision is expected with which fixed and semi-fixed sprayers will be included.

Number and Distribution of Pesticide Application Equipment Inspection Stations

The PAEIS approved in Greece from September 2015 to February 2018 are 149. The distribution of PAEIS by Geographical Province and Prefecture is presented in Table 1 (DEMETER, 2018).

Table 1. Allocation of PAEIS in different Geographical Province and Prefecture

<i>Geographical District</i>	<i>Prefecture</i>	<i>Number of PAEIS</i>	<i>Geographical Province</i>	<i>Prefecture</i>	<i>Number of PAEIS</i>
Thrace (16)	Evros	7	Epirus (2)	Ioannina	1
	Rodopi	5		Arta	1
	Xanthi	4	Stereia Hellas	Etoloacarnaria	1

Macedonia (65)	Drama	3	(12)	Fthiotida	2	
	Kavala	3		Viotia	7	
	Serres	10		Evia	1	
	Kilkis	2		Attiki	1	
	Thessaloniki	7	Peloponnese (25)	Korinthia	2	
	Halkidiki	3		Achaia	4	
	Pella	17		Argolida	3	
	Imathia	10		Arkadia	3	
	Pieria	1		Ilia	5	
	Florina	1		Messinia	3	
	Kastoria	1		Lakonia	5	
	Kozani	6		Crete (10)	Chania	3
	Grevena	1			Rethimno	3
	Larisa	14			Iraklio	2
Thessaly (19)	Magnisia	1	Aegean Islands	Lasithi	2	
	Trikala	2			0	
	Karditsa	2	Ionian Islands		0	
	<i>Total</i>			<i>149</i>		

PAEIS has been established in 38 prefectures in the country. Specifically, there are PAEIS in all the prefectures of Thrace, Macedonia, Thessaly, Peloponnese and Crete. PAEIS has not been authorized in the prefectures of Thesprotia and Preveza in Epirus, in the prefectures of Fokida and Evritania in Sterea Hellas, as well as in the Aegean and Ionian islands. Most PAEIS are located in the prefectures of Pella (17), Larissa (14), Imathia (10) and Serres (10). Figure 2 shows the PAEIS per geographical compartment as a percentage of the total number. The majority of PAEIS (43.6%) are located in the Province of Macedonia.

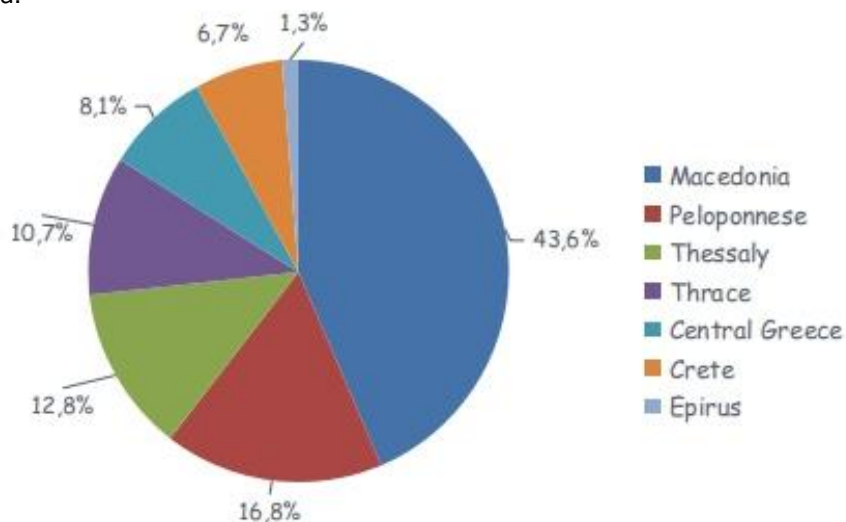

Figure 2. Allocation of PAEIS in different Geographical Province

Type of PAEIS

All PAEIS (100%) are mobile.

Equipment of PAEIS

The great majority of PAEIS (98%) use equipment of the least possible cost, avoiding high-tech devices.

Ownership of PAEIS

The ownership of PAEIS in Greece is divided in the next categories (Figure 3):

- 136 PAEIS are private entities (71 are manufacturers-retailers of agricultural machinery).
- 11 PAEIS are owned by Agricultural Cooperatives.
- 2 PAEIS are under Universities command.

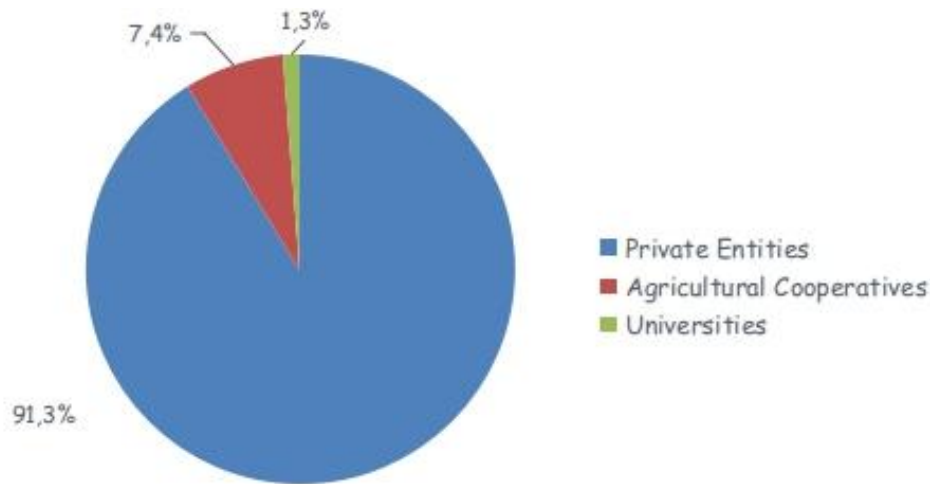

Figure 3. Ownership of PAEIS

Inspectors of PAEIS

The majority of inspectors (60,4%) are Agricultural Engineers or Agricultural Engineers (Tech), but Mechanical engineers of both types are also active in this sector. (Table 2, Figure 4).

Table 2. PAEIS Inspectors

Inspectors	Number
Agricultural Engineers	68
Mechanical Engineers	42
Agricultural Engineers (Tech)	22
Mechanical Engineers (Tech)	17
<i>Total</i>	<i>149</i>

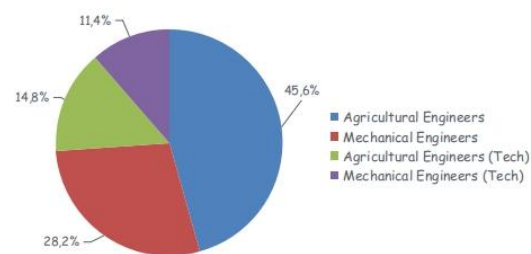

Figure 4. PAEIS Inspectors

Number and distribution of Pesticide Application Equipment

The difficulty in determining the number of PAE in Greece makes it tough to properly implement the inspection system. Data provided by various bodies such as the Hellenic Statistical Authority (ELSTAT), the Ministry of Rural Development & Food, manufacturers, etc., differ considerably from one another. According to ELSTAT (2014), the total number of spraying equipment to be inspected in Greece is 151,437, of which air assisted tree and bush sprayers are 105,380 (69,6%) and boom sprayers are 46,057 (30,4%). Table 3 gives the number and distribution by geographical province of the sprayers according to ELSTAT. The bulk number of them is in Macedonia.

Table 3. Number and distribution of PAE (Source ELSTAT 2014)

<i>Geographical Province</i>	<i>Number of PAE</i>	<i>Percentage (%) of the total number</i>
Thrace	13.227	8,7
Macedonia	53.346	35,2
Epirus	3.520	2,3
Thessaly	11.146	7,4
Central Greece	13.932	9,2
Peloponnese	31.027	20,5
Crete	20.698	13,7
Aegean Islands	2.239	1,5
Ionian Islands	2.302	1,5
<i>Total</i>	<i>151.437</i>	<i>100</i>

The registered PAE in the RPAE are 139,283 by February 2018. Table 4 and Figure 5 show the distribution of PAE by Geographic Province.

Table 4. Number and Allocation of PAE (Source PAE Registry 2/2018)

Geographical Province	Number of PAE
Thrace	21.070
Macedonia	43.252
Epirus	1.075
Thessaly	26.133
Central Greece	13.635
Peloponnese	24.574
Crete	8.093
Aegean Islands	1.441
Ionian Islands	10
Total	139.283

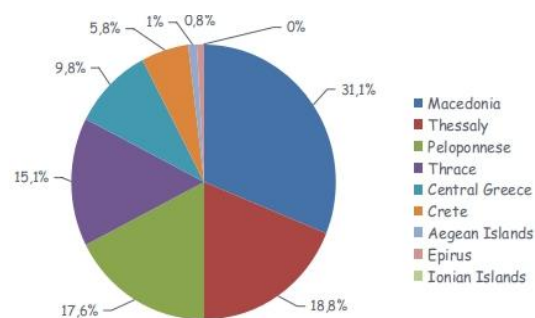
**Figure 5.** Allocation of PAE (Source PAE Registry 2/2018)

Number and distribution of inspected PAE

From the equipment registered in the RPAE, the machinery to be inspected are 127,274, as portable equipment is currently exempted from inspections. Table 5 shows the types of PAE recorded in the Registry by February 2018.

Table 5. PAE Type (Πηγή PAE Registry 2/2018)

Type of PAE	Number	PAE for Inspection
Air assisted tree and bush Sprayers	27.736	127.274
Boom Sprayers	76.993	
Sprayers with Lance	22.545	
Knapsack sprayers	11.921	
Fixed/semi-fixed sprayers	88	
<i>Total</i>	<i>139.283</i>	

The total number of the inspected PAE by February 2018 is 23,583 machines, i.e. 18.53% of the total PAE (Bourodimos et al., 2018). The distribution of the inspected PAE by geographical province is given in Table 6 and Figure 6.

Table 6. Allocation of Inspected ΕΕΓΦ in each Geographical province

Geographical Province	Number of inspected PAE
Thrace	4.962
Macedonia	11.660
Epirus	88
Thessaly	2.756
Central Greece	507
Peloponnese	3.455
Crete	155
Aegean Islands	0
<i>Total</i>	<i>23.583</i>

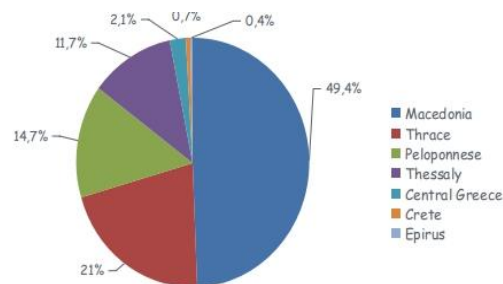
Figure 6. Allocation of Inspected PAE

The average tested PAE per PAEIS is 158.3. Table 7 shows the average of inspections per PAEIS and per geographical province. The data is precarious, because many PAEIS are also active outside the geographic province they belong to.

Table 7. Mean of inspected PAE per PAEIS in each Geographical Province

Geographical Province	Mean Inspections per PAEIS	Geographical Province	Mean Inspections per PAEIS
Thrace	310,1	Central Greece	42,3
Macedonia	179,4	Peloponnese	138,2
Epirus	44,0	Crete	15,5
Thessaly	145,1	Aegean/Ionian Islands	0

Types of Inspected PAE

The inspected PAE was divided into 3 groups (Figure 7):

- Boom sprayers, which accounted for 48.2% of the sample.
- Air assisted tree and bush sprayers, which accounted for 41.2% of the sample.
- Sprayers with Lance, which accounted for 10.6% of the sample.

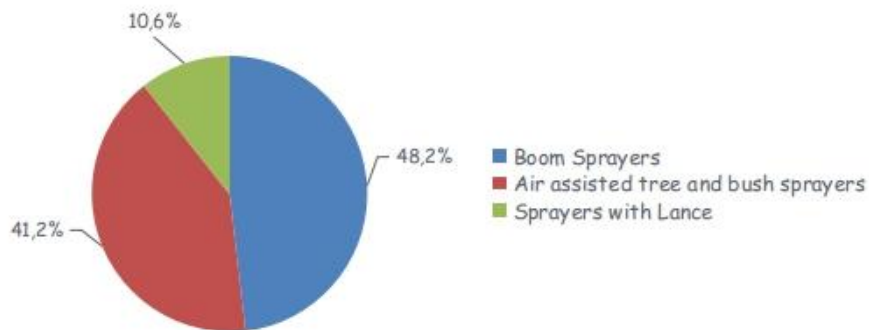

Figure 7. Type of Inspected PAE

Classification of Inspected PAE

Upon completion of the inspection of the PAE, the inspected equipment is classified in one of four categories:

- CATEGORY I: Equipment meeting the requirements of Law 4036/2012. A Certificate of Inspection and a sticker of compliance are issued.
- CATEGORY II: Equipment with minor deviations to be corrected until the next inspection. A Certificate of Inspection and a sticker of compliance are issued.
- CATEGORY III: Equipment that presents significant deviations from the requirements of Law 4036/2012. No sticker of compliance is issued and the PAE use until its successful inspection is forbidden.
- CATEGORY IV: Equipment included in Category III that its owner with a statement affirms that he wishes to delete it from the RPAE.

The 23.583 inspected PAE were classified in the four categories as follows (Bourodimos et al., 2018):

- Category I, 17.06% of the sample.
- Category II, 80.61% of the sample.
- Category III, 2.31% of the sample.
- Category IV, 0.02% of the sample (Figure 7).

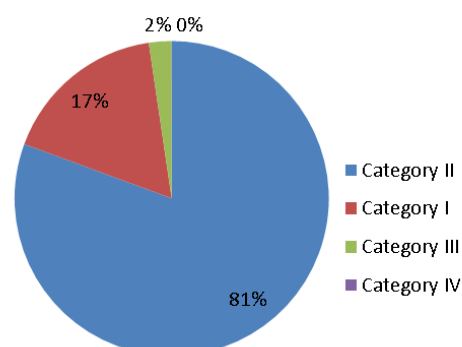

Figure 8. Classification of inspected PAE

Discussion-Conclusions

The number of PAEIS established is satisfactory, and so is the distribution by geographical province. Lack of PAEIS is mainly observed in areas with a small number of PAE, mostly islands, and this obviously discourages people from investing. It is possible to cover these areas from existing PAEIS, since everyone is mobile and for this purpose the Reference Laboratory is trying to reach an agreement between the existing PAEIS.

The majority of PAEIS were established with low cost equipment, which affects the time and quality of inspections.

There are PAEIS with very high number of inspections, resulting in their controversial quality.

Allegations for PAEIS that carry out inadequate inspections have already been filed to the Reference Laboratory and the Directorate of Land Reclamation and Mechanical Equipment of the Ministry of Rural Development and Food. The Reference Laboratory has begun sampling inspections at different PAEIS and on PAE that have been inspected and are labeled with a sticker.

A particularly high proportion of machinery (97.7%) is considered suitable for use in Categories I and II. The most possible reason for this percentage is the fact that any shortcoming is repaired immediately in order for the PAE to be classified in these categories without the Technical Inspection Reports of the original - before the repair - inspection being sent to the Reference Laboratory. Another possible reason would be the inadequate controls of PAE by some PAEIS.

The number of machines inspected is particularly small, bearing in mind that all PAE should have been audited by 26 November 2016. The Ministry of Rural Development & Food is trying to address this situation by linking the plant protection product purchases with the PAE inspection certificates and the user certificates for the rational use of plant protection products. However, it must be stressed that there is a need for systematic dissemination to the farmers about the periodic mandatory PAE inspections and the consequences of PAE misuse.

References

1. **EN 13790-1,2, 2003.** Agricultural machinery-Sprayers-Inspection of sprayers in use. Brussels.
2. **EN ISO 16122-1,2,3,4, 2015.** Agricultural and forestry machinery - Inspection of sprayers in use. Brussels.
3. **Directive 2009/128/EC, 2009.**
4. **Bourodimos G., Giamouri M., Fountas S., 2018.** Inspection of Pesticide Application Equipment - Inspection Stations and Results of Inspections so far. Proceedings of 7th Panhellenic Meeting for plant protection, Larissa, 5-8 March 2018.
5. **Law 4036, 2012.** ΦΕΚ 8/Α/27-01-2012. Marketing of pesticides on the market, rational use of these and related provisions. Athens, Greece.
6. **Department of Agricultural Engineering - Institute of Soil-Water Resources, 2015.** Manual for in-use PAE Inspection, 2015. Syntax: G. Bourodimos. Athens, Greece.
7. **Department of Agricultural Engineering - Institute of Soil-Water Resources, 2018.** Panhellenic Registry of PAEIS, Archives of Technical Inspection Reports of PAEIS, Athens, Greece.
8. **Ministry of Rural Development & Food, 2016.** Ministerial Decision, No. Ε8 2010/50687, ΦΕΚ 1323/Β/11.05.2016. Amendment of No. Ε8 1831/39763, ΦΕΚ 671/Β/21.04.2015 Y.A. Athens, Greece.
9. **Ministry of Environment, 2015.** Ministerial Decision No. Ε8 1831/39763, ΦΕΚ 671/Β/21.04.2015. PAE Inspection system and procedure for inspection certification, Athens, Greece.

The inspection quality assurance: present situation and needs

Jan Langenakens

AAMS-Salvarani, Belgium

Opinion

Inspections started in the seventies as being voluntary and having the goal to help farmers to spray better and more efficiently. After some success in this missionary work in several countries, inspections of sprayers in use became mandatory to help agriculture to safeguard the use of crop protection products in their production process to optimize yield, minimize/reduce the use of chemicals and to prevent high residues in the marketed products.

Mandatory inspections have started in the 90's in European countries. The European Commission has captured that idea and integrated it as one of the actions in the European Directive 2009/128, establishing a framework for Community action to achieve the sustainable use of pesticides. In the directive a transition period has been foreseen but all sprayers on European territory should have had a 1st inspection before end of 2016.

Today, as being active in about all European member states, we observe, regardless statistics handed to the Spise secretariat, that not half of all member states has an inspection system installed. Even worse is that countries that have started an inspection system/schedule, are having issues to organise a practical follow-up of inspections in the field. This lack of supervision is causing multiple irregularities in the field, each reinforcing the other.

- **Lack of checking on farms/in the field if sprayers are inspected** (with no penalty applied to growers that are not inspected as required by law) causing farmers not to inspect their sprayer or all of their sprayers, especially smaller farmers or farmers in a secondary occupation, causing a too low number of sprayers available for inspections to make it viable for inspection stations.
- The lack of numbers of sprayers to inspect is putting an economical pressure on inspection stations that reduce the inspection cost in an economic struggle to be able to amortise their inspection tools and make no losses. **The lack of supervision on the activities of inspection stations**, not performing inspections as prescribed to reduce time and efforts, to reduce costs, to be able to lower the price of the inspection service to be the best on the market, going that far to just selling an approval certificate/sticker of inspections, causing the good and faithful growers to loose their trust in the inspection systems and seeing it just as a tax, just choosing the cheapest solution.
- **The lack of practical and precision of inspection stations**, where inspection stations use not validated/certified measuring tools in inspections and in many cases tools that are less precise (at the best identical) than the tools and parts installed on sprayers, where farmers loose trust in the results of the inspections after being rejected or require repair.
- **The lack of proper training and advisory stations for inspectors**, where inspectors have a major experience in inspections and trainers never did any inspection. This is especially an issue in completion and refreshment courses.

Is it all bad? No, but it becomes time that serious actions are undertaken in multiple countries and regions to avoid that more inspections systems that just have been initiated will implode. Nobody gains anything with bad executed inspections or even the vanishing of inspections, with the whole agricultural sector and the environment as being first effected. Let's all work together to get the process of inspections of sprayers in use back on the right track to help agriculture and environment to sustain hand-in-hand.

References

Directive 2009/128/EC of the European Parliament and of the Council of 21 October 2009 establishing a framework for Community action to achieve the sustainable use of pesticides. <http://eur-lex.europa.eu/eli/dir/2009/128/2009-11-25>

The CEMA decal - promotion of the inspection of brand new sprayers

Christoph Schulze Stentrop

(HARDI International A/S)
CEMA PT 24 working group

Summary

The placing of pesticide application equipment (PAE) on the market in compliance with the European legislation and the in-use inspection are both covered by this CEMA initiative.

The declaration of conformity is part of the sprayer operator handbook and demands a risk assessment of the manufacturer. On top of this some customers, dealers and importers want to be double sure that the new sprayer will pass the first inspection for sprayers in use and that the sprayer is accompanied.

In combination with a national test report and the CEMA decal a further proof of compliance is given, but it has to be stated that this is not a legal requirement.

The leading European sprayer manufacturers represented in CEMA have started to harmonise such optional individual sprayer proof of compliance by means of mutual recognition of national test reports and the belonging decal. To use the CEMA decal the sprayer manufacturer needs to be an authorised test centre, while the suitable test protocol could be adapted to a certain demand. An important precondition for the authorisation is a verification and agreement of the manufacturer's test protocol by the authorisation body of a Member State.

The presentation will promote the use of this preliminary inspection. A report will be given, to show the status after the launch on the Agritechnica 2017.

The CEMA decal supports the approach of the manufacturers to bring new PAE to a higher safety and quality level. A positive effect is also that the training and the certification of the test staff is easier, as only one national certificate is demanded. The CEMA decal will support the mutual recognition between the authorisation bodies.

Keyword: preliminary inspection, new sprayers, CEMA decal

Situation:

The leading European sprayer manufacturers represented by CEMA have always worked along a clear vision and strategy to ensure the safety and health of the operator and the protection of the environment, while satisfying the customer demands for functionality, versatility, operability, etc. Therefore, in addition to the efforts in product development the industry, together with the other stakeholders, has drafted the harmonised European standard EN ISO 16119 for placing sprayers on the EU market and as second step the harmonised European standard EN ISO 16122 for inspection of sprayers in use. Standardising the requirements and methods for inspection of sprayers in use takes into consideration not only the original performance of the sprayer but also its use, care and maintenance. This is a logical link to ensure the continued benefit arising from the supply of new sprayers of good quality and with all officially demanded features.

What are the current steps in the process of approval and in-use inspection today?

The self-certification (module A) according to the Machinery Directive, which is usually based on the EN ISO 16119, is an obligation for the manufacturer. It is part of the declaration of conformity and it is identifiable on the machine by the CE mark.

The Declaration of Conformity is the formal and legal statement addressed to authorities that the individual machine complies with the Machinery Directive under self-certification.

The inspection of sprayers in use according to EN ISO 16122 (formerly EN 13790) must be carried out by an authorized test centre. The first inspection must take place not later than 3 / 5 years after placing on the market.

Problem:

Compliance for new sprayers with EN ISO 16119 includes higher performance requirements than EN ISO 16122, but customers, dealers and importers want to be double sure that the new sprayer will pass the first inspection for sprayers in use. Therefore they prefer that the new sprayer will be delivered with the certificate showing compliance with the national demanded test level, which can be on different levels either following the EN directive 128 (Sustainable Use Directive) or EN ISO 16122 or EN 13790. This includes for the customer a national test report and decal.

The first inspection, according EN ISO 16122 or EN 13790, of the sprayer can be offered by the manufacturer as an additional service, i.e. in terms of an optional item in the product catalogue (as already done today in various Member States), but there is no mutual recognition of national test reports across all member states, due to different reasons. Already the link to the EU directive 128 (Sustainable Use Directive) where the sprayer in use inspection is based on is interpreted differently by the different Member States.

Individual sprayer inspections for each Member State would be the worst case scenario, difficult or impossible to be managed and therefore it would be rejected by the industry.

Solution:

The (first) inspection is offered by the manufacturer as an option – it is not an obligation. It is up to each individual customer to decide whether or not he likes to accept and to buy this offer as option.

Upon a request, the manufacturer shall be approved as an authorized test centre by an authorization body of one Member State, in order to carry out officially recognized sprayer inspections.

The test reports and certificates issued by any authorized test centre (including an authorized manufacturer) shall be mutually recognized. This mutual recognition is a mandatory requirement according to the Sustainable Use of Pesticides Directive!

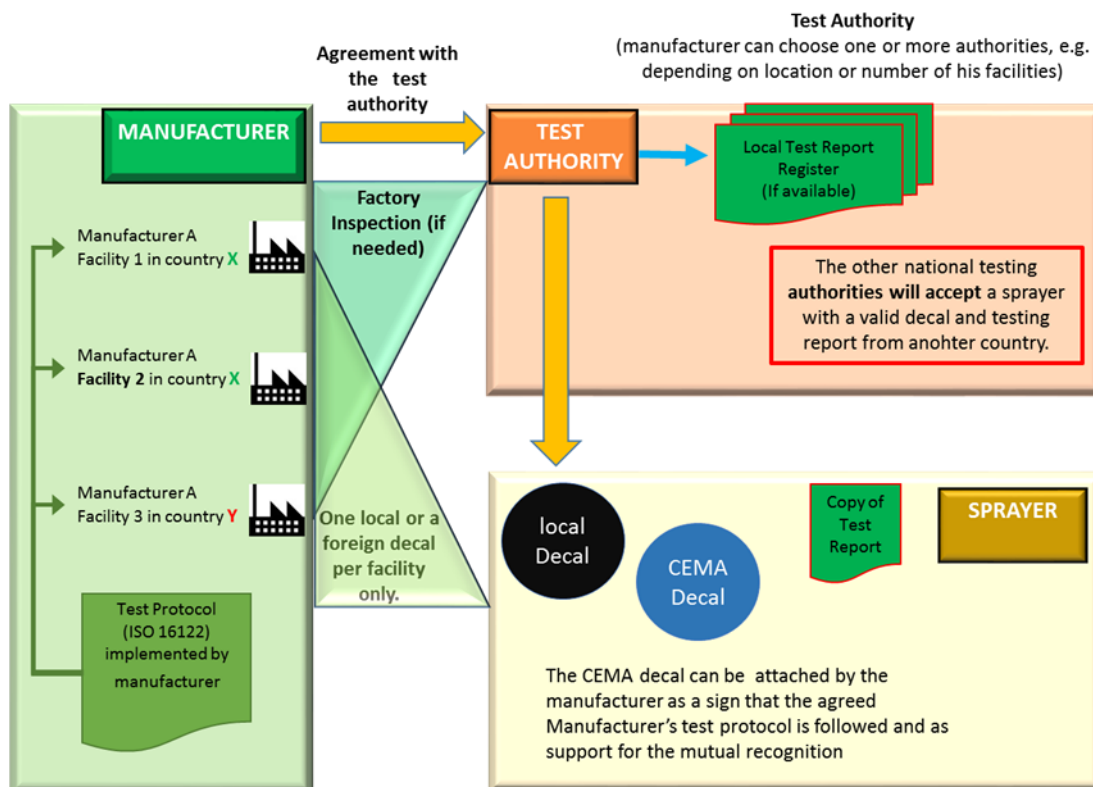

Figure 1

CEMA Approach in detail:

There is a test protocol based on the EN ISO 16122 adopted by a manufacturer. The test protocol can be specifically written for the manufacturing facility (tailored to the manufacturer depending on the level of integration of the Certificate of Production into his manufacturing processes). It is referred to as the manufacturer's test protocol.

The manufacturer can choose for its authorisation as test centre an authorisation body which is located at the manufacturer's facility place (county, province or state), or it can be an authority from one of the different EU member states.

The selected authority is asked to verify whether the Manufacturer's test protocol is fulfilling the requirements of EN ISO 16122 and whether it can be agreed, with or without certain modifications, as equivalent of the test protocol from the testing authority. The authorisation as test centre is dependent on this agreement.

The selected authority may visit and inspect the manufacturing facility (to check items related to EN ISO 16122 only).

The manufacturer will conduct the testing of the sprayer according the test protocol and will be authorized to issue the testing report and place the local authority decal on the machine.

The manufacturer will pay fees related to the approval as test centre.

The different national schemes (authority, testing records and decals) will be kept as they are today.

The CEMA decal can be attached by the manufacturer as a sign that above procedures are followed and as support for the mutual recognition. A solution for national test reports and decals could then still be done locally following the local procedure or registration process, but a new test should not be done to get this national documents! Here it is a great help to have a national responsible contact to get this process better organised.



Figure 2

Status

The CEMA decal has been officially launched at the Agritechnica 2017. The leading manufacturers had the decal on their inspected sprayers and showed the concept to farmers and dealers.

Today the European market in regards of sprayer testing is not homogeneous. The countries, where it has been common practice to deliver sprayers already inspected has the same situation as before, the only difference is another extra decal. But these established markets still demand to keep the same performance level, including changes in digital reporting etc.

Other areas where the inspection has no tradition are still struggling to do introduce both, an inspected sprayer and an extra decal. It should be noted that the 5 years first inspection is seen as a drawback, as an inspected sprayer has to come to next inspection after 3 years. But this will change in 2019 when the first inspection has to be after 3 years.

Also a problem is that not all national regulations allow an inspection in the factories, which forces some extra work and ideas to solve this.

Another issue is that national inspections have different price levels, which always leads to discussions in a price sensitive industry as the sprayer business is. The whole process cost money and the advantages of mutual recognition are not really seen by production responsible persons in the different companies.

Further information:

<http://www.cema-agri.org/cema-inspected>

The importance of sprayer inspections in the EU from a chemical industry perspective

Manfred Roettel¹; Volker Laabs²; Steward Rutherford³

¹ BetterDecisions, Kandern, Germany

² BASF SE, Agricultural Solutions, Limburgerhof, Germany

³ ECPA, Brussels, Belgium

Summary

The legal requirements for sprayer inspection schemes reflect that Crop Protection has to be seen as a process, which includes the user, the application equipment, the infrastructure and the Plant Protection Product (PPP). EU directives set the legal framework for crop protection product registration and practices. For sprayers, or pesticide application equipment (PAE), the EU Directive on Sustainable Use of Pesticide (SUD), with its focus on risk reduction, requires the implementation of regular sprayer inspection and certified repeated trainings for users, advisers and stakeholders. The EU Machinery directive amendment lists the technical requirements a sprayer should fulfil which include environmental aspects for the first time. Standards are used to define technical performance requirements and how these should be tested. In Europe the CE label certifies that the PAE complies with the harmonized standards. The Crop Protection industry supports the implementation of PAE inspection schemes and supports the main objectives. These cover all aspects of operator safety, to optimize efficacy and to reduce PPP losses and reduce unintended environmental impacts. According to the relevant directive, all sprayers in use should have been tested at least once by 2016, however this has not yet been achieved. Implementation of inspection procedures are not yet well harmonized, which makes it difficult to compare tests results. Current inspections are mainly developed for field crop and bush / tree crop sprayers. Inspections for other types of PAE are generally not available, mainly because the respective technical standards are missing. TOPPS surveys in EU countries show that the need for advice on spraying is considered largely insufficient and varies significantly between EU member states. Countries with many farmers and a large variety of crops in general have higher needs for advice. The established sprayer inspection stations represent a possible opportunity to develop further competences in order to give application advice to farmers. This would require an appropriate training program for the sprayer inspectors, so that advice on e.g. better adjustment of sprayers can be further transferred by them to farmers. PAE will be a key element in further risk reduction requirements and may become more regulated and integrated in crop certification schemes. Therefore, it is necessary to follow comparable and consistent procedures which are both auditable and broadly accepted. The SPISE working groups gather experts from various countries eager to find solutions to the challenges.

Keywords: plant protection, sprayer testing, SPISE, harmonization, EU legal framework, standards (ISO/CEN), certification schemes, risk reduction, PAE

Introduction

Since humans changed their lifestyle about 12,000 years ago and cultivated plants to stabilize their food supply they have been involved in fighting against diseases, pests and weeds. Harvests have historically represented only what diseases, pests and weeds left untouched. The effort to reduce such crop losses to a minimum is what we call crop protection (1). First simple scratch ploughs were used to give the cultivated plants a competitive advantage over the weeds by improving their germination conditions. Weed control was further improved with the invention of ploughs turning the soil about 2000 years ago (e.g. mouldboard plough) (2). Spray applications and dusting for crop protection started in Europe around 120 years ago with the application of copper (Bordeaux Mix) and sulphur against diseases and further natural toxins like nicotine and arsenic to control pests (ref 1, 3). The basic principles for spray applications are mainly the same today: spray liquid in a tank is applied through

nozzles / dispersers with pressure produced by a pump to protect crops. For field applications, the spray reaches the target mainly through gravity forces when downward spraying, while in bush and tree crops additional air support is used to transport the spray to the target by upward and sideward spraying.

Legal Framework for crop protection increasingly focus on the crop protection process

In the last 40 years the regulatory requirements for chemical plant protection products (PPP) in the EU have steadily increased. This has resulted in use restrictions and losses of registrations for many active ingredients. Beside the efficacy and safe use of the PPP for humans, also environmental aspects have gained more importance in regulatory risk assessments. In 2009 two new EU directives were published which focussed on the use phase of the PPP and the application equipment. These are the Directive on Sustainable Use of Pesticides (SUD)(2009/128/EU) and the amendment of the Machinery Directive (2009/127/EC), where environmental aspects related to sprayers are mentioned for the first time and requirements for Pesticide Application Equipment are expressed.

Focus of the SUD (2009/128/EU) is on the use phase of PPP, aiming at risk reduction (4)

The implementation of the following actions are required by EU Member States:

- Set up of National Action Plans (NAPs) containing objectives and timetables to reduce risks and impacts of pesticide use;
- ***Training: Professional pesticide users, distributors and advisors must receive proper training on the safe use and handling of PPP (sprayer licence);***
- ***Establish competent authorities and certification systems for trainings;***
- Minimise or prohibit PPP use where necessary in certain critical areas for environmental or health reasons;
- ***Inspecting application equipment in use: All PPP application equipment should have been inspected at least once by 2016 (except knapsack sprayers) and subsequently at ongoing intervals (3 to 5 years).***

Machinery directive amendment (2009/127/EC) to the directive (2006/42/EC) (5)

The amendment defines specific requirements for crop protection machinery concerning the protection of the environment. All new machines entering the market from 2011 onwards should fulfil the harmonized standards of the machinery directive. Machinery for pesticide application must be designed and constructed in such a way that the machinery can be operated, adjusted and maintained without unintended exposure of the environment to pesticides. To this aim, the following technical requirements are defined in the Directive:

- Controls and monitoring
It must be possible to easily and accurately control, monitor and immediately stop the pesticide application from the operating positions.
- Filling and emptying
The machinery must be designed to facilitate precise filling with the necessary quantity of pesticide and to ensure easy and complete emptying, while preventing spillage of pesticide and avoiding the contamination of the water source during such operations.
- Application of pesticides
The machinery must be fitted with means of easily adjusting the application rate; be designed to ensure that pesticide is deposited on target areas, to minimise losses to other areas and to prevent drift of pesticide to the environment; and be designed to prevent losses/ drips while the pesticide application function is stopped.
- Maintenance
The machinery must be designed to allow easy and thorough cleaning, and to facilitate servicing and changing of worn parts without contamination of the environment.

- Inspections
It must be possible to easily connect the necessary measuring instruments to the machinery to check correct functioning.
- Marking of nozzles, strainers and filters
Nozzles, strainers and filters must be marked so that their type and size can be clearly identified (colour code).
- Indication of pesticide in use
Where appropriate, the machinery must be fitted with a specific mounting on which the operator can place the name of the pesticide in use.
- Instructions (user manual)
The instructions of the application machinery must provide relevant information in order to facilitate correct operation of the equipment and to avoid contamination of the environment, including but not limited to the following:
 - precautions to be taken during mixing, loading, application, emptying, cleaning, servicing and transport operations;
 - detailed conditions of use for the different operating environments envisaged;
 - the range of types and sizes of nozzles, strainers and filters that can be used with the machinery;
 - the frequency of checks and the criteria and method for the replacement of parts subject to wear that affect the correct functioning of the machinery, such as nozzles, strainers and filters;
 - specification of calibration, daily maintenance, winter preparation and other checks necessary to ensure the correct functioning of the machinery;
 - types of pesticides that may cause incorrect functioning of the machinery;
 - an indication that the machinery may be subject to national requirements for regular inspection by designated bodies, as provided for in Directive 2009/128/EC on the sustainable use of pesticides.

Point 7 of the Directive (2009/127/EC) points out the following: "This Directive is limited to the **essential requirements** with which machinery for pesticide application must comply before being placed on the market and/or put into service, while the European standardisation organisations are responsible for drawing up **harmonised standards** providing detailed specifications for the various categories of such machinery in order to enable manufacturers to comply with those requirements."

The harmonized standards support the implementation of the SUD through the definition of the respective functional and technical requirements (6)

Standards

As is common practice in EU technical legislation, accompanying standards have been established by CEN/ISO, compliance with which can be used as one way of showing that the general requirements of the associated directives are met. Standards covering new sprayers ISO 16119 and sprayers in use ISO 16122 have been published specifically for field crop sprayers and orchard sprayers, respectively. These harmonised standards are published in the Official Journal of the EU. Sprayer manufacturers selling sprayers in the EU market are requested to make a risk assessment for their sprayers covering operator and environmental risks, based on applying the harmonized standards. Sprayer manufacturers are responsible for guaranteeing (by means of self certification) that the machinery complies with the relevant requirements, and may then apply the official CE label to the sprayer. So, in principle the CE label can only be applied if the requirements as set out in the machinery directive are fulfilled. Standards are essential because they facilitate the implementation of regulation and contribute to harmonisation between countries. Standards are also a tool which regulation can build on (6).

Article 11 of the Machinery directive states:

"Where a Member State ascertains that machinery covered by this Directive, bearing the CE marking, accompanied by the EC declaration of conformity and used in accordance with its intended purpose or under reasonably foreseeable conditions, is liable to endanger the health or safety of persons or, where appropriate, domestic animals or property or, where applicable, the environment, it shall take all appropriate measures to withdraw such machinery from the market, to prohibit the placing on the market and/or putting into service of such machinery or to restrict the free movement thereof. "

Sprayer inspections concentrate on sprayers which are already in use (ISO 16122), but do not check if new sprayers comply with the harmonized standards. New sprayers are self certified by manufacturers and should show this by means of a CE label (ISO 16119) which is necessary to access the market

New sprayers therefore can enter the market without prior sprayer inspection. Manufacturers represented in CEMA offer a sprayer inspection as an option following ISO 16122 (7). In Germany the first sprayer inspection is required 6 months after purchase, in Austria the first sprayer inspection is required 5 years after purchase. This can have negative consequences for the farmer because after 5 years guarantees from manufacturers are no longer valid if standards are not met. This means that manufactures may not be liable for non compliance with the standard. This also means that the standard for sprayers in use ISO 16122 applies, which only inspects technical features present on the sprayer (8). Yet, new sprayers being placed on the market since 2011 should comply with the harmonized standard ISO 16119. Unfortunately, this is not always the case today. Reports from sprayer inspectors (8) mention examples of cases where new sprayers enter the EU market which do not comply with harmonized standard ISO 16119 (this is particularly the case for sprayers at the cheaper end of the market).

In general, the enforcement level of the machinery directive would benefit from strengthening in most EU member states, and this needs to be addressed urgently.

Although standards exist for field crop sprayers, bush and tree crop sprayers and some fixed, semi mobile sprayers, there is also a lot of specialised application equipment on the market to which no standards apply, and this needs to be addressed as well.

Harmonization of inspection procedures in countries are needed.

It is only the first step to establish EU directives with the overall target to improve PAE and PPP application, which is fully supported. Stronger guidance and support on how more effective implementation could be achieved would be helpful. Inspection procedures in EU member states are variable and do not always deliver comparable results (9). Therefore, testing results can be partly questioned. In this regard, we give credit to the efforts of the SPISE working groups which try to help develop and implement harmonized procedures for sprayer inspection. These efforts need to be better supported to increase their chance for success. Harmonized inspection procedures are also important for increasing their acceptance by farmers and their associations. The cost for the sprayer inspection varies by state and by region, which may also influence the acceptance of sprayer inspections by farmers at local level. A low level of acceptance may also indicate a lacking explanation of the benefits of sprayer inspections by authorities (10). Harmonized inspections are in the interest of the crop protection industry as sprayers are part of the efforts for overall risk reduction, which should support the compliance with regulatory requirements of the PPP.

Crop protection needs to be understood as a process where each step offers opportunities to realize improvements.

The legal requirements, as reflected by the relevant EU Directives, are based on a process view for crop protection, which includes the people involved (e.g. operator), the application technique, and also suitable infrastructure and the PPP. Each element in the process can contribute to the objectives as set

out in the SUD and contribute to sustainable crop protection. Based on experiences from the TOPPS projects (16) we realized that the areas of sprayer configuration and sprayer calibration/adjustment/maintenance represent mostly untapped resources for improving the overall process of crop protection. It is clear from a TOPPS stakeholder/advisor survey 2016 (Fig1) that there is insufficient advice or training for farmers concerning the adjustment and operation of sprayers (11). Currently, relatively few application specialists are active in EU member states and we believe we need to find innovative solutions to expand advice capacity for teaching farmers the correct adjustment of sprayers and on the significance of further application parameters which are relevant for risk reduction.

Can we develop the sprayer inspection schemes further to also provide advice on technical matters and the adjustment of sprayers?

In most countries sprayer inspection is organized through local workshops, where technicians are trained and supervised by an authority (which may be private or state run). In general, the workshops just perform the technical inspection as required in an inspection protocol. Advice to farmers on correct sprayer use and adjustments in practice are usually not provided. These workshops could offer an opportunity, if technicians are correctly trained, to increase the advice capacity concerning the correct use and adjustment of sprayers. Especially the quality of the sprayer adjustment for bush and tree crop sprayers has great potential to improve the overall efficacy and environmental performance of crop protection practices. This often does not require costly technical upgrades of the sprayer. Practical tests in Italy, for instance, showed that just by adjusting orchard sprayers to the correct tree height via selection of the number of nozzles used and their spray direction, that spray drift was reduced by 65 to 70% (12).

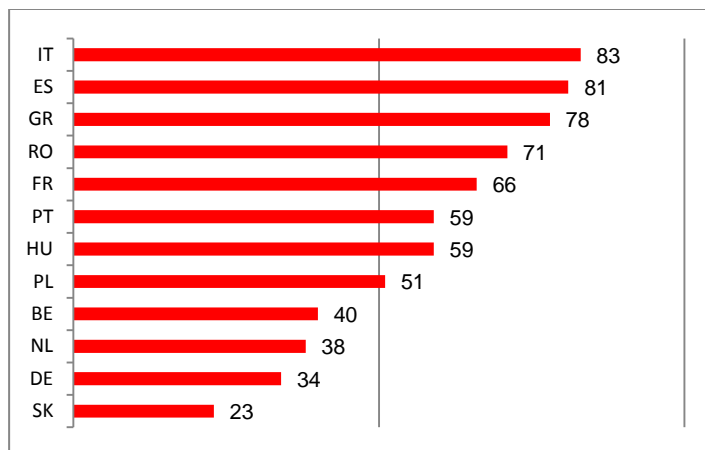

Fig 1.: TOPPS - Stakeholder / Advisor survey 2016; n= 1161

Do you think farmers get sufficient advice to correctly adjusting and using their sprayer ?

(Answer "No" in % of respondents)

Sprayer inspectors can see immediately when they inspect a sprayer how it is adjusted and maintained and therefore are in an ideal position to make a judgment on the needs for advice for the operator of the sprayer. Such an approach would require a dedicated training program for the persons who are running the sprayer inspection to broaden their competencies for providing advice on sprayer adjustment and correct use to farmers. This additional advice or service would also help increase the acceptance of sprayer inspection schemes by farmers, as they would directly experience the benefits for their crop protection practices.

However, such an extension of advice activities by the sprayer inspection organizations might meet some resistance, as it would require additional training and effort. Such an approach could possibly be tested in an EU project involving various partners and countries to identify the main hurdles and also the success criteria. If we are able to combine sprayer inspection and advice on the correct use of the

sprayer we would reach most farmers operating a sprayer and would have a better chance of reaching the objectives set out in the SUD.

A further aspect where sprayer inspectors could give advice is to check as far as possible if the sprayers comply with the harmonized standards. Farmers should be made aware of machines which are non-compliant with current ISO/CEN standards. Sprayers which have entered the market after 2011 and which clearly do not comply with the harmonized standards should not get a label to certify inspection.

STEP-water a joint effort between sprayer manufacturers (CEMA) and crop protection industry (ECPA) to provide information to users on sprayer standards

As a result of the ECPA - TOPPS water protection projects it became clear that a reduction of PPP losses to water needs to consider spray machinery conditions and options to realize further risk reduction (13,14,,) and also that there is scope for possible future improvement in this area. This has stimulated further developments such as the continuous internal sprayer cleaning concept, which is now implemented on some new sprayers and is also applicable via upgrading kits to retrofit older sprayers. In Switzerland, the continuous internal sprayer cleaning is incentivised and there are intentions to make this obligatory in future.

Additional activities focus on providing information tools (websites) for farmers, and evaluating technologies with respect to their risk reduction potentials for improved water protection. Based on an intensive cooperation between CEMA and ECPA, the STEP-water webtool will be launched this year as an information and learning platform for farmers on technologies relevant for sprayer filling, internal and external cleaning, reduction of spray losses, and remnant management. It highlights technologies which are partly covered by harmonized standards and those which can be strongly recommended and which might be established as a standard in future. Such web information tools can help to spread information about standards and technologies to farmers, sprayer dealers, advisers, as well as to technicians performing the sprayer inspections (15).

The current module concentrates on water protection, but it could be extended to also cover e.g. operator safety aspects.

Outlook

Sprayer inspection is needed and should be further developed and supported.

The Crop Protection industry supports the implementation of sprayer inspection as a well-designed and functioning sprayer / PAE is an essential element to achieve sustainable crop protection in practice. The whole process of PPP application should be seen as providing potential contributions to risk reduction and thus to achieving the objectives of the various EU directives which include e.g. to optimize the application to reach best efficacy with lowest losses of PPP, improve operator safety, and reduce the risk of environmental contaminations with PPP.

Some unintended effects of PPP applications (e.g. PPP losses to water or non target areas by spray drift) can be significantly reduced by utilizing the risk reduction potential which is offered by improved spray equipment (16). Risk reduction measures (e.g. technologies) will increasingly be linked more closely with the regulatory process for PPPs, as we can see already with spray buffer distance regulations being related to drift reducing technologies. This will require harmonized sprayer inspection schemes, which ensures that the results can be used across countries. Sprayer inspection may become a subject of certification schemes (already in place in some countries, and with market organizations), which would mean that the inspection procedures must be transparent and auditable.

The current standards also need to be further developed to reflect progress made in application technology. Parallel to this we need to extend the sprayer inspection into areas which are important but which are not inspected today e.g. like measuring the cleaning efficiency or the agitation quality of sprayers. It is also important to develop inspection regimes which cover the air profile and adjustment

of Bush and Tree crop sprayers (18). Additionally, standards should be developed for those types of Pesticide Application Equipment (PAE) to which standards do not apply today. SPISE working groups intend to close this gap through the publication of SPISE advice (e.g. 18). These activities are useful to address the issue, but will not have the same obligation for implementation as an established technical standard. Therefore, developing such standards should be a next step to help achieve the SUD goals of improved operator safety and environmental protection in the EU. It would be very helpful if such developments could be financially supported under an appropriate EU project.

References

- (1) Rademacher B., 1949: Krankheiten und Schädlinge im Acker- und Feldgemüsebau. Ulmer Verlag Stuttgart.
- (2) https://de.wikipedia.org/wiki/Pflug#Geschichte_des_Pfluges
- (3) Balsari P., P. Marucco, 2011: The new EU Directive requirements and the innovation in pesticide application techniques. Journal ASTN Int, Vol.8.2
- (4) DIRECTIVE 2009/128/EC OF THE EUROPEAN PARLIAMENT AND OF THE COUNCIL of 21 October 2009 establishing a framework for Community action to achieve the sustainable use of pesticides. Official Journal EU, L309/71-85
- (5) DIRECTIVE 2009/127/EC OF THE EUROPEAN PARLIAMENT AND OF THE COUNCIL of 21 October 2009 amending Directive 2006/42/EC with regard to machinery for pesticide application, Official Journal EU, L310/29-33
- (6) Bals, T. : CEN and ISO Standards on equipment for plant/crop protection. <https://pdfs.semanticscholar.org/presentation/2ad9/a09c65834755e39417e229e3e1a879772c56.pdf>
- (7) Schulze Stentrop C., P. Holben 2016: Industry proposal on the inspection of sprayers in use (preliminary inspection). 6th European workshop on Standardised Procedure for the Inspection of Sprayers in Europe-Spise 6. 37-39. Barcelona
- (8) Herbst K, E. Herbst 2016: Inspection of new sprayers defects following EN-ISO 16119/16122. 6th European workshop on Standardised Procedure for the Inspection of Sprayers in Europe-Spise 6. 41-43. Barcelona.
- (9) Kole J, P. Harasta 2016: "Certification" of the Workshop activity (quality assurance) included the certification of devices/ instruments used for the inspections. 6th European workshop on Standardised Procedure for the Inspection of Sprayers in Europe-Spise 6. 125-129. Barcelona.
- (10) Gonzales C. 2016: The point of view of a farmer. 6th European workshop on Standardised Procedure for the Inspection of Sprayers in Europe-Spise 6. 31-34. Barcelona
- (11) Roettele, M., M Gallart, E Gil, 2017: Perception on how to reduce the risk of Plant Protection Products (PPP) losses to surface water in fruit production. Results from the European TOPPS stakeholder survey 2016. Abstract 14 th Workshop on Spray Application Techniques in Fruit Growing, 10-12 May 2017 Hasselt, BE
- (12) Balsari P., 2017: Personal communication
- (13) Roettele M, Balsari P, Doruchowski G, Petersen PH (2010). Sprayer development needs more focus on mitigation of environmental risks arising from point source water pollution. Inter. Advances in Pesticide Application, Aspect of Applied Biology 99,, 357-368
- (14) Roettele M., P. Balsari, G. Doruchowski, H.J. Wehmann 2012: Environmentally Optimized Sprayer (EOS). Evaluation of spray equipment to mitigate point and diffuse source losses of Plant Protection Products (PPP) to water. Int. Advances in Pesticide Application. Aspects of Applied Biology 114, 143-150.
- (15) Roettele, M., S Rutherford, P Balsari, I Hostens, T Bals, J-C Rousseau, P Hloben, 2018: STEP-water - New online advice and information tool on sprayer technologies enabling the reduction of Plant Protection Products (PPP) losses to water. Inter. Advances in Pesticide Application, Aspect of Applied Biology 137, 59-64.
- (16) www.TOPPS-life.org
- (17) Triloff, P. 2016: Results and conclusions from five years measuring and adjusting air distribution of brand new sprayers for 3D crops. 6th European workshop on Standardised Procedure for the Inspection of Sprayers in Europe-Spise 6. 179-185. Barcelona

(18) Spise Advice 2/2016: Advice for functional inspection of special spraying trains and other vehicles for chemical weed control on railways and public roads. SPISE website- <https://spise.julius-kuehn.de/>

Session 1: Present experiences and challenges in inspections activities

Present experiences and challenges in inspections activities in Serbia

Aleksandar Sedlar¹, Vladimir Višacki¹, Rajko Bugarin¹, Petar Radić²

¹University of Novi Sad, Faculty of Agriculture, Department of Agricultural Engineering, Education Developmental Center for Pesticide Application Equipment, Sq. D. Obradovića 8, 21000 Novi Sad, Serbia

²Cooperative Union of Vojvodina, Blvd M. Pupina 25, 21000 Novi Sad, Serbia

Summary

During 2016, after 3 years, activities which were focused on establishing a system for control testing of sprayer and air assisted sprayers on the territory of the Republic of Serbia the whole system was established on a 31 station for control testing of PAE and 2 bodies who are responsible for control and system organization.

Thanks to the activities carried out through the IPA Twinning Project SR12 / IB / AG / 01 in December 2014, the equipment supplied to all stations by its basic activity of agricultural schools, agricultural extension services, professional high schools, agricultural institutes. Stations are equipped with all necessary equipment. The equipment is at each station entrusted to graduate agricultural engineer who have full-time job and they were trained in two basic courses.

Plan was that during 2017. Serbia get new “Law of plant protection products”, which include parts of mandatory control testing PAE but we still in anticipation of this new legislation. During these anticipations, Faculty of Agriculture, University of Novi Sad organized many workshops with agricultural producers. Aim of this workshops is to introduce agricultural producers with important and benefit of sprayer inspection and calibration. These workshops were supported by Vojvodina’s government. Also many of established station start with training of agricultural producers in their area with support of municipality or other state local body.

Agricultural producers make good response on this activity, so experts from Faculty of Agriculture Novi Sad, provide also to agricultural producers training in their “Education Developmental Center for Pesticide Application Equipment” (ERTAP). We call it “ERTAP open days”. So, during season of spraying they can call us or visit our Center and we help them to be more effective and environmental friendly in pesticide application.

Still, the biggest problem is that we do not have new legislation. Like two years ago, also now for implantation of control testing in Serbia we needed an urgent adoption of a new law as well as supporting acts, with emphasis Rules on control testing, in order to implement the system in practice.

Key words: inspection, activities, educational workshop, new law, Serbia

Introduction

The importance of inspections of pesticide application equipment is reflected in the pesticide application efficiency. For pesticide efficiency, applications are a key nozzles and operating pressure. For their proper functioning, it is necessary:

- There is no pressure drop (leaks and dropping);
- The pump achieves the declared flow and operating pressure;
- Controlling via the control group (setting and controlling the pressure, switching on and off);
- set appropriate nozzles are installed;
- the wings are horizontally and vertically flat;

The mentioned factors have a final impact on the uniform application of pesticides. In addition to internal factors (element and sprayer circuits), there are external factors that influence the uniformity of the pesticide application. External factors include:

- Air temperature;
- Air humidity;
- Speed of movement;
- condition of crop;

Changing the pressure causes a change in the droplet size. By increasing pressure, a more uniform application of pesticides will be obtained (Višacki et al., 2016). Different nozzles have a different effect on the uniformity of the application. Injector nozzles will have a better distribution of the working fluid from the spray nozzle. Reflective sprayers will have a poorer distribution than all nozzles. The reason is in the type of nozzle because of the change in pressure, there is also a change in the size of the drops and the method of disintegration of the working fluid. Accordingly, lower pressures will affect the formation of larger droplets and higher pressures on the formation of smaller droplets. The effect will be different for a flat jet nozzles or injector type nozzles (Nuyttens et al., 2007). Therefore, at the same time, the uniformity of distribution of the sprayer will be different. In general, according to Sehsah and Klesinger (2011), it is noted that the pressure has an impact on the uniformity of the distribution of the sprayer. The same author proves that in wind conditions there are changes in the uniformity of the application of pesticides due to the change in the coefficient of variation. Similarly, Subr et al. (2017) where it adds that the wear nozzles additionally changes the coefficient of variation to higher values. The higher value of the coefficient of variation indicates an uneven application of pesticides. All of these factors will affect the efficiency of the pesticide application. The occurrence of drift is the first problem faced by a farmer. In addition to drifting winds that are almost constantly present, evaporative drift is increasingly more frequent (Heidary et al., 2015). This is confirmed in an open field where the type of nozzles, working pressure, drift and droplet size play a decisive role in the amount of deposits on the plant or the target surface. Olivet et al. (2017), Reynaldo and Machado (2017), Ozkan et al. (2012), Mesterhazy et al (2011) confirm the advantage of using an injector nozzles as a good solution in case of drifting. They state that a larger amount of deposits is achieved using a two-jet nozzles.

All of these facts are in fact a problem in Serbia in the application of pesticides. The importance of implementing the plant protection inspection procedure itself does not represent the completion of a task related to the efficient application of pesticides. The next step is farmer education. Although the law has not yet been adopted, the Educational Development Center for Pesticide Application first identified the critical points of the pesticide application, and then formed a team of people who first write a training literature and carried out dozens of different types of training both at the Faculty and throughout the territory of Serbia and Vojvodina province.

Material and method

The identified problems are in fact the result of non-compliance with several international standards. Requirements prescribed by international standards are a starting point for all educational workshops conducted by the Educational Development Center for Pesticide Application. Requirements of the following standards have been observed:

- [1] [ISO 5682-1:2017](#): Equipment for crop protection -- Spraying equipment -- Part 1: Test methods for sprayer nozzles
- [2] [ISO 5682-2:2017](#): Equipment for crop protection -- Spraying equipment -- Part 2: Test methods to assess the horizontal transverse distribution for hydraulic sprayers

- [3] [ISO 6686:1995](#): Equipment for crop protection -- Antidrip devices -- Determination of performance
- [4] [ISO 8169:1984](#): Equipment for crop protection -- Sprayers -- Connecting dimensions for nozzles and manometers
- [5] [ISO 16122-1:2015](#): Agricultural and forestry machinery -- Inspection of sprayers in use -- Part 1: General
- [6] [ISO 16122-2:2015](#): Agricultural and forestry machinery -- Inspection of sprayers in use -- Part 2: Horizontal boom sprayers
- [7] [ISO 19732:2007](#): Equipment for crop protection -- Sprayer filters -- Color coding for identification
- [8] [ISO 22369-1:2006](#): Crop protection equipment -- Drift classification of spraying equipment -- Part 1: Classes
- [9] [ISO 22369-2:2010](#): Crop protection equipment -- Drift classification of spraying equipment -- Part 2: Classification of field crop sprayers by field measurements
- [10] [ISO 22401:2015](#): Equipment for crop protection -- Method for measurement of potential spray drift from horizontal boom sprayers by the use of a test bench
- [11] [ISO 10625:2018](#): Equipment for crop protection -- Sprayer nozzles -- Color coding for identification

Accordingly, three groups of problems have been identified. In first group is the problem that farmers faces:

- Age of sprayers since many sprayers were acquired thirty years ago while the domestic economy functioned;
- The problem with new sprayers that appeared as non-compliance with applicable standards;
- Spray nozzles in terms of weariness;
- Inappropriate sprayer nozzles do not comply with field requirements;
- Manometer does not meet scale standards;
- Problem with the speed of the shaft since the low speed does not generate sufficient flow;
- Poor membranes and valves on the pump as well as pressure in the air bell;
- Exploitation factors does not correspond to field conditions, operating pressure and traveling speed;
- Conditions on the field, drift and deposit on target.

The second group includes producers of cheap sprayers with the following problems identified:

- they do not know the requirements of international valid standards;
- Used nozzles are domestic production and do not meet international standards in terms of color coding, flow and distribution;
- Spray nozzles and nozzles carriers do not perform an adequate function;
- Filters do not have matching mesh; no threads are marked with a good color;
- Valves, ducts, manometers and command units in many cases do not work well since they leaking and do not stop the flow, they are very imprecise;
- Sprayer wings are neither vertical nor horizontal, nor have any automatic leveling systems.

The third group includes sprayers' manufacturers, which are not manufacturers, but those who build new sprays by purchasing components most often from Italy, Slovenia or Germany. The main problem identified is that they do not deal with the principles of effective pesticide application. Accordingly, sprayers are delivered with equipment that does not ensure that the operator performs an efficient pesticide application. Additionally, they train them for basic things about spraying, and not about the principles of good agricultural practice and real possibilities of a very high price machine for our market.

Another problem identified during the previous and this year is that farmers buy different machines without knowing what the ability of sprayer. They also do not know their exploitation factors and often buy oversized machines for their farms. This is an increasingly frequent problem because the state allocates huge incentives for the purchase of new agricultural machinery. The machines are imported without any control and no compliance with the standards of the European Union is checked, which is, for example, a problem with machines coming from Russia and Turkey.

Results and discussion

The solution of the problems identified is in the continuous and all time education of farmers. Dozens of educational workshops were conducted mainly in the territory of the autonomous province of Vojvodina. These workshops were divided into 4 segments. The first segment concerned general information related to the application of pesticides, diseases and pests and machinery for plant protection, the other part related to the choice of nozzles, norms and other exploitation parameters. The third part covered the personal protective equipment of the users of plant protection products. In the end, all three parts were covered and through the fourth part of the course participants could see this practically with a special emphasis on the inspection of pesticide application equipment.

The first segment included:

- Diseases and pests in crop production;
- Elements and assemblies of plant protection machines;
- Setting up a sprayer;
- Norm, dose and concentration;
- Maintenance and off-season storage of the machine;

The second segment concerned:

- Types and subtypes of nozzles;
- Drift;
- The size of the drops of the nozzles;
- Impact of pressure on the pesticide application efficiency;
- Efficient and economical application of pesticides;
- Use of a tracer and pesticide deposit;
- Exploitation parameters of labor.
- The third part of the course also had several areas:
- Packaging, instructions for use and manipulation with plant protection products;
- Spray filler, pouring and flushing process;
- Collection and destruction of packaging;
- Preservation and storage of plant protection products;
- Personal protective equipment;
- Measures of protection and caution when handling, storing, transporting plant protection products;

The fourth part was the most interesting course participants since it was related to the practical part. Thus, through this part of the course, an inspection of the sprayers was carried out by the owners of the course. Specifically, there are recommendations regarding nozzles, operating pressure and speed of movement in pesticide application, weather conditions and limitations.

The following photos show different segments of realized courses.



Fig. 1. The first part of the lecture is about personal protective equipment



Fig. 2. Practical presentation of the work of nozzles



Fig. 3. Selection of nozzles



Fig. 4. The accompanying publication is related to the course



Fig. 5. Types of nozzles for efficient pesticide application



Fig. 6. Personal protective equipment and nozzles



Fig. 7. Practical demonstration of inspections of pesticide application equipment



Fig. 8. Presentation of the Course at the annual conference

All equipped stations with equipment for inspection of pesticide application equipment have been realized equipment in the test run and performed the first tests. According to unofficial data, over 85% of pesticide application equipment do not comply with applicable standards. The most common problems are with nozzles, wings and pressure gauges. Leaking and dropping from parts is almost a regular occurrence. Nozzles have not been changed since the purchase of the sprayers. Not knowing the color coding and flow, setting the standard and influencing the pressure on the droplet size as a fat of efficiency is a daily occurrence. Although the inspection of the plant protection equipment is not mandatory, the stations have initiated self-financing of their activities from municipal funds or funds of the Provincial Secretariat for Agriculture or the Ministry of Agriculture of the Republic of Serbia.

Conclusion

By not adopting a new law of plant protection products, enormous damage to the environment and agricultural production is inflicted. Currently, the activities of the equipped stations are very useful and have brought very bad results in case of current stand of pesticide application equipment. This shows that the new law of plant protection products have included inspections of pesticide application equipment, which will be extremely useful for efficient and sustainable agricultural production. Courses related to the principles of efficient and economical agricultural production in the framework of sustainable agricultural production and sustainable management and land use as a natural non-renewable resource are currently of crucial importance for Serbia's agriculture.

Note: This paper is part of the research on the project TR 31046: "Improving the quality of tractors and mobile systems in order to increase competitiveness, conservation of land and the environment" (2011-2018), financed by the Ministry of Science and Education of the Republic of Serbia.

Literature

1. Višacki V, Sedlar A, Bugarin R, Turan J, Burg P. (2017). Effect of Pressure on the Uniformity of Nozzles Transverse Distribution and Mathematical Model Development. *Acta Universitatis Agriculturae et Silviculturae Mendelianae Brunensis*, 65(2): 563–568.
2. Nuyttens, D., K. Baetens, M. De Schampheleire, and B. Sonck. (2007). Effect of nozzle type, size, and pressure on spray droplet characteristics. *Biosystems Eng.* 97(3): 333-345
3. Sehsah E. M. E. and Kleisinger S. (2011). Study of some parameters affecting spray distribution uniformity patternen *Misr J. Ag. Eng.*, 26(1): 69- 93

4. Subr A , Milanowski M , Parafiniuk S , Sawa J. (2017). Testing the uniformity of spray distribution under different application parameters. IX International Scientific Symposium "Farm Machinery and Processes Management in Sustainable Agriculture", Lublin, Poland, 2017 DOI: 10.24326/fmpmsa.2017.64 359
5. Étore F. Reynaldo¹ and Thiago M. Machado (2017). Performance of spray nozzles to control fusarium head blight and mycotoxin in the barley crop. Revista Brasileira de Engenharia Agrícola e Ambiental Campina Grande, PB, UAEA/UFCG, ISSN 1807-1929 v.21, n.3, p.209-213, 2017 DOI: <http://dx.doi.org/10.1590/1807-1929/agriambi.v21n3p209-213>
6. Ozkan H E, Paul P , Derksen R C, Zhu H. (2012). Influence of application equipment on deposition of spray droplets in wheat canopy. Aspects of Applied Biology 114, 2012 International Advances in Pesticide Application 317
7. Mesterházy A, Tóth B, Varga M, Bartók T, Szabó-Hevér A, Farády L, Lehoczki-Krsjak S. (2011). Role of Fungicides, Application of Nozzle Types, and the Resistance Level of Wheat Varieties in the Control of Fusarium Head Blight and Deoxynivalenol. Toxins, 2011(3), pp.1453-1483
8. [Juan J. Olivet](#), [Juana Villalba](#) and [Jorge Volpi](#). (2017). Evaluation of spray nozzles for fungicidal control of tan spot in wheat Crop and Pasture Science 68(7):591-598. 2017 <https://doi.org/10.1071/CP17171>

The Belgian experience with sprayer inspection activities and future challenges

Johan Declercq¹, Guillaume Defays², Bruno Huyghebaert², David Nuyttens¹

¹ Institute for Agricultural and Fisheries Research (ILVO), Technology & Food Science Unit - Agricultural Engineering – Burg. Van Gansberghelaan 115 – 9820 Merelbeke – BELGIUM. Contact: johan.declercq@ilvo.vlaanderen.be

² Agricultural Research Centre (CRA-W) – Agricultural Engineering Department Chée de Namur 146 – 5030 Gembloux – BELGIUM

Summary.

In Belgium, the mandatory inspection of field crop, orchard and vineyard sprayers was already started up in 1995. Furthermore, the inspection of greenhouse sprayers and soil-disinfection machines was implemented respectively in 2011 and 2014. So Belgium can look back on more than 22 years of experiences with the inspection of sprayers.

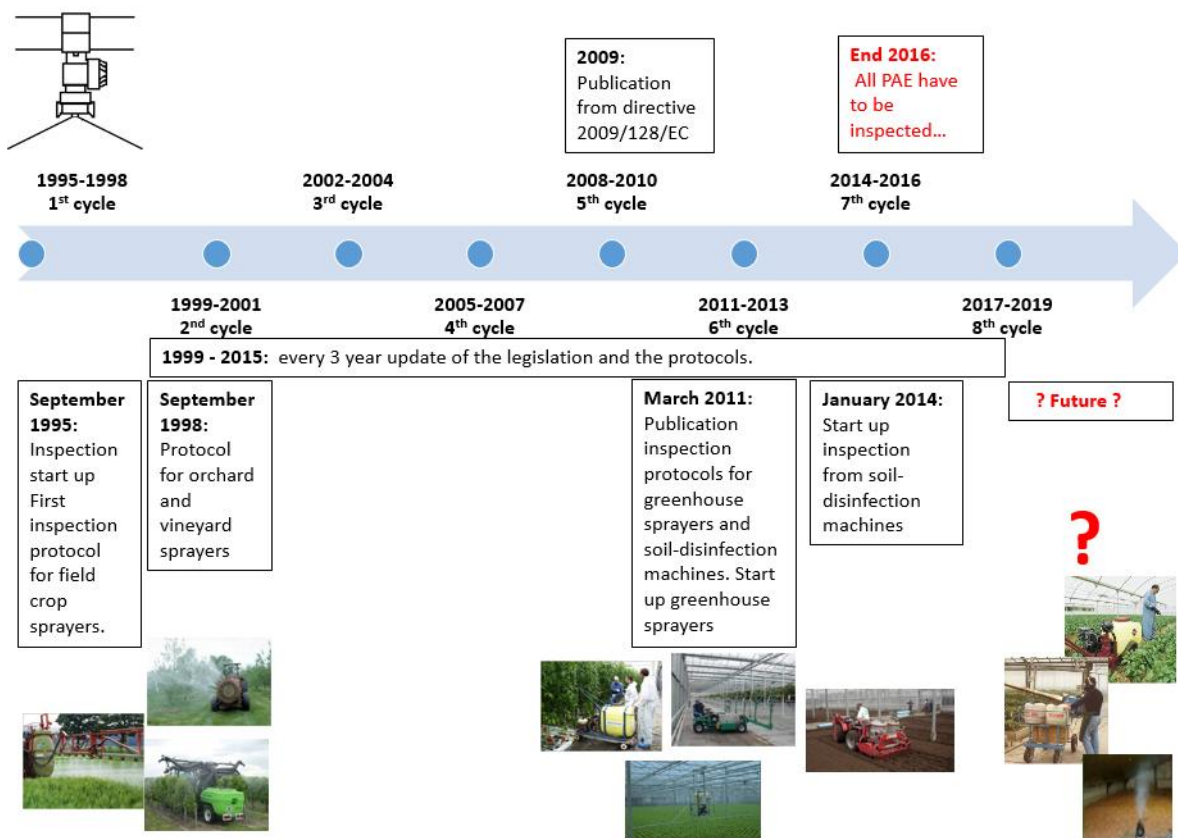

Figure 1: Evolution of the inspection in Belgium.

At the end of the eighties the execution of voluntary inspections was started up to gain the necessary experience. It soon became clear that a number of though-out choices had to be made at the start of the mandatory inspections. In order to guarantee the impartiality, professionalism and efficiency of the inspections, a centralized organization and implementation by region was chosen. Furthermore, the analytical inspection method (pressure and nozzle flow rate) was chosen because of the mobility of the test equipment that could be used. The benefits of the Belgian system are obvious. There are only ten experienced inspectors and two regional contact points for the inspection of all Belgian sprayers, and the inspections are carried out efficiently and at a fair price. The two regional Belgian inspection

services are also accredited according to ISO17020, guaranteeing the highest quality standard of the inspections that are carried out.

Despite the advantages of the Belgian system, some problems have arisen over the years. For example, the organization and the planning of the re-inspections require a lot of additional follow-up. Furthermore, there is a need for professional testing equipment that fulfils higher standards compared to that what is currently on the market, because of the intensive daily use. So the Belgian story is therefore an ideal example for other European inspection services.

Keywords: Sprayers, inspection, experience, Belgium

Introduction

In many ways, the mandatory inspection of sprayers in Belgium differs from inspections in other European countries. The FAVV/AFSCA (Federal Agency for Food Security) is responsible for the inspection, but it delegates the inspection to two regional bodies: ILVO (Flemish region) and CRA-W (Walloon region). Both official inspection bodies are BELAC accredited according to ISO 17020 which guarantees a maximum quality of the performed inspections. The inspection teams (3 in the Flemish region and 2 in the Walloon part) are equipped with a test van that contains all necessary equipment to perform the inspections according to the Belgian federal legislation. The inspections are carried out at a neutral location where farmers/contractors are invited at an exact date and time, to present their sprayer for testing. All over the country test locations are hired so that farmers/contractors do not need to travel distances above 15 km. Inspections are also performed at the farmyard on demand, but therefore an extra fee is charged. The inspection procedure is based on the analytical principle which means that all parts of the machine are tested separately. After the inspection the farmer/contractor receives a certificate and sticker confirming the approval of the sprayer for the next three years or specifying all the items that need to be repaired in case of a rejection. No repairs are made to the sprayer during the inspection. Consequently, the repaired sprayer has to be represented for a re-inspection. Despite the advantages of the Belgian system, some problems arose over the years which are discussed in the following chapters.



Figure 2: Inspection van with all test equipment (Flanders)

Organization

Despite the fact that the Belgian way of working and organization has a lot of advantages, there are also some difficulties.

Absences

Once a sprayer has been inspected the owner is automatically re-invited by the inspection service after 3 years at a date and time set by the inspection service. It happens regularly that the invited owner cancels the appointment, or does not show up. In the case of early cancellations, the inspection service can still change the planning slightly, but when the cancellations arrive too late changing the planning is impossible. As a consequence the inspectors are out of work for a while and no income is generated for the service. In recent years the number of absentees stagnated around 15% in Flanders, but as one can see this still means quite a significant loss of time and income.

Re-inspection

In case of the Belgian inspection the defects are not repaired during the inspection but the sprayer is rejected. When a sprayer is rejected the owner receives a temporary certificate with a validity of three months, and the inspection service is therefore assumed to re-invite the sprayer within 3 months. However, if there are not enough rejections in a particular test center, it is not economically viable to activate the test center if not even half a day of re-inspections can be planned (which is often the case). As a consequence, these re-inspections are carried out in the next semester. Furthermore, the inspection service has to send a temporary proof to prolong these certificates that could not be invited within 3 months for a re-inspection.

Finding suitable test centers

The Flemish inspection service is currently inspecting at about 130 locations that are rented on a temporary base (Figure 2). Every year, at least five new test centers have to be found for diverse reasons. Sometimes the test center and terrains changed owner, in other cases the locations are assigned a different destination and in some cases they became too small. Unfortunately, it becomes more and more difficult to find suitable locations for different reasons. First, spray boom widths increase with boom widths up to 45 m. This implicates that a fairly large area is required, which is not always evident in a strongly urbanized region like Flanders. Second, most owners prefer not to share their space with our inspection service. And last, the locations must be well reachable and well positioned between existing locations.



Figure 3: Test centers in Flanders, Belgium.

Testing equipment

Intensive use

The intensive daily use of the test equipment and the daily loading/unloading and transport poses high demands on the equipment used. The equipment should not only be solid and reliable, but it must also deliver quick and accurate work sometimes in difficult wet conditions. In most cases the commercially available standard test equipment that is available must be adjusted and strengthened to meet those requirements. In order to deal with problems, there is at least one spare device available at ILVO for each different test device. In case of a fall out the spare can be used immediately.

Limited offer

The supply from standard test equipment is limited and usually concerns basic material. As an example, Belgian inspection services have been searching for a decade for a system with wireless pressure sensors to read out boom section pressures remotely (Figure 4). Such a system would make the work for the inspectors a lot healthier, faster and accurate. Unfortunately, there is no manufacturer that offers this type of equipment. So out of necessity, such systems are developed in-house.

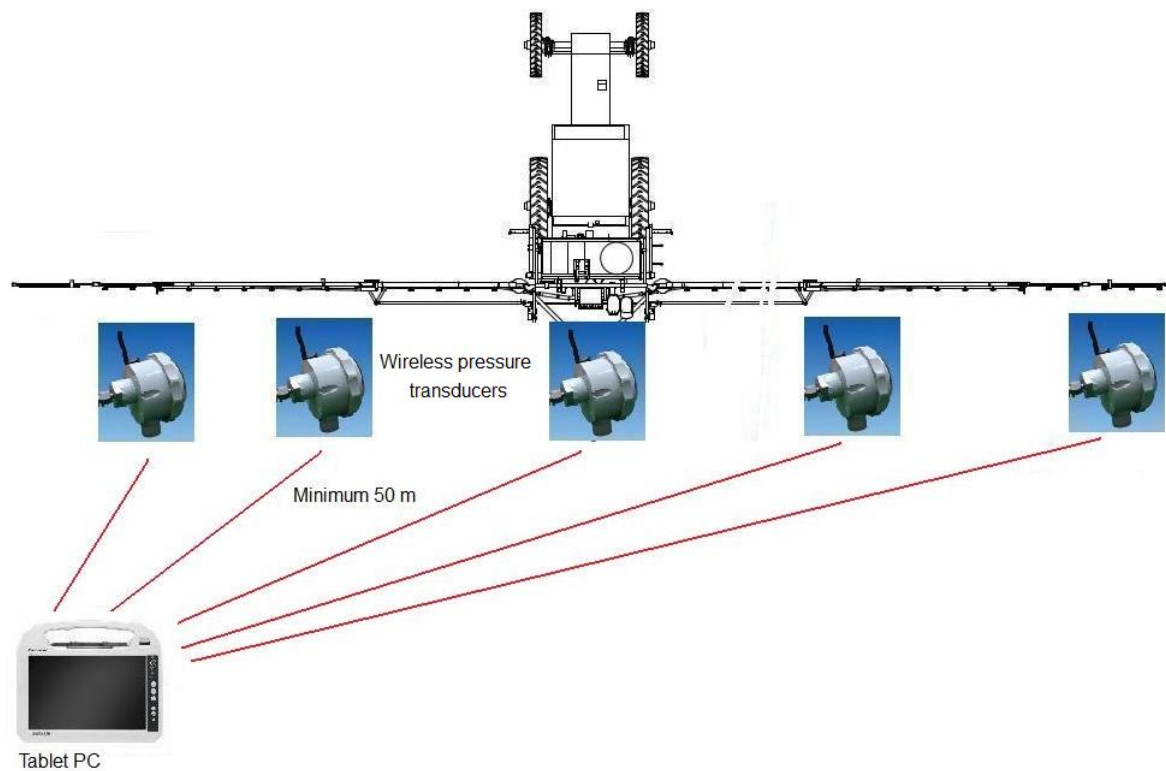

Figure 4: Principle of a wireless pressure measuring system.

Legislation

Review from the legislation

The legislation is revised each inspection cycle (every three years). Experiences show that approval of a new law takes a lot of time in Belgium. In practice the changes to be made for the next inspection cycle must be prepared approximately two years before the end of the ongoing cycle, which is not always evident. Implementation from problems encountered during an ongoing cycle can take up to 5 years before inclusion in the legislation.

Regional differences

Belgium is a federal state with two completely different regions. On the one hand there is the highly industrialized and densely populated Flanders and on the other hand the more rural Wallonia. In Flanders there are quite a lot of greenhouses and there is a lot of intensive livestock farming, while in Wallonia arable farming is the most important agricultural branch. So the agricultural policy also varies from region to region. On top of that, certain competences and responsibilities are at regional level and others at federal level. This makes decision making very complicated and slow.

Quality assurance

The Belgian inspection services are accredited according to ISO17020 and as a result the quality of the service is continuously assessed and improved where necessary. Despite the benefits of a quality system, the impact of the extra work and the additional costs may not be underestimated.

Start-up of an accreditation

When starting up an accreditation for an inspection service, there is a lot of extra work involved. The best scenario is the one where the service can be fitted into an existing ISO17020 or ISO17025 quality system. General structures will already exist and in house experience will be available.

The worst scenario is the one where there is no experience at all and a start up from scratch has to be made. This will require an enormous effort. The quality manager will have to gain experience, set up the required structures, foresee the adequate trainings, etc. So before starting up an accreditation pro's and con's should be well considered.

Once accredited

Once the accreditation is obtained and running there is still a considerable amount of work to keep it maintained. Quality management is a continuous process and requires a constant effort from everyone and especially from the quality manager to keep the system up to standard. Furthermore, one may also not underestimate the extra annual returning costs for the external audits.

Conclusions

Despite the fact that the Belgian way of working entails some problems, the disadvantages do not outweigh the benefits that the system offers. The centralization of the inspection services allows the inspections to be carried out efficiently with a limited number of inspectors and within a well-structured organization. This results into a qualitative and independent inspection at a competitive price.

References

- Braekman P., Huyghebaert B., Sonck B. (2004). The Belgian way of organizing a compulsory inspection of sprayers. *Julius-Kühn-Archiv*. 1st European Workshop on Standardized Procedure for the Inspection of Sprayers in Europe – SPISE I, 27-29 April 2004, Braunschweig, Germany **397**: 97-100.
- Huyghebaert B., Mostade O., Braekman P. (2004). Overview of the sprayer inspection in Belgium. 1st European Workshop on Standardized Procedure for the Inspection of Sprayers in Europe – SPISE I, 27-29 April 2004, Braunschweig, Germany **397**: 90-94.
- Declercq J, Huyghebaert B., Nuyttens D. (2009). An overview of the compulsory inspection of sprayers in Belgium. *Julius-Kühn-Archiv*. 3th European Workshop on Standardized Procedure for the Inspection of Sprayers in Europe – SPISE 3, 22-24 Sept 2009, Brno, Czech. **426**: 122.
- ISO 17020 (2012). General criteria for the operation of various types of bodies performing inspection.
- Wehmann H.-J. (2016). Status Quo of inspection in EU: the results of SPISE enquiry. *Julius-Kühn-Archiv*. 6th European Workshop on Standardized Procedure for the Inspection of Sprayers in Europe – SPISE 6, 13-15 Sept 2016, Barcelona, Spain : 9-19.
- Defays G., Declercq J, Huyghebaert B, Nuyttens D. (2016). Belgian quality assurance system according to ISO17020 illustrated by a practical example. *Julius-Kühn-Archiv*. 6th European Workshop on Standardized Procedure for the Inspection of Sprayers in Europe – SPISE 6, 13-15 Sept 2016, Barcelona, Spain: 131-137.
- ISO 17025 (2017). General requirements for the competence and calibration laboratories.

Assessment of the sprayer inspection results in Catalonia

Francesc Solanelles, Ferran Camp, Alba Fillat, Felip Gracia

Centre de Mecanització Agrària. DARP

Generalitat de Catalunya

Rovira Roure, 191

25198 Lleida. Spain

Abstract

The objective of the sprayer inspection is to reduce the risk for the environment and bystanders, since it is said that sprayers with malfunctions cause a reduction of the sprayer application efficiency. In order to know the condition of the sprayers before the inspection, the results of 11712 sprayers, inspected between 2014 and 2016 in Catalonia, were assessed. The average rate of unfavourable inspections was 38%

The most frequent defect found in the inspections was a wrong pressure gauge, mainly because its error was greater than the requirements of the inspection standard. Other common malfunctions were related with safety aspects, like missing or deteriorated guards in power transmission and other moving parts. In air-assisted sprayers, worn or clogged nozzles were also responsible for many unfavourable inspections, whereas in boom sprayers missing filters was a frequent cause for them.

Since an important number of faults and malfunctions are corrected during the inspection, it can be stated that the inspection of sprayers in use improve the efficiency of the spray application, both reducing the risk for the environment and allowing a good control of pests and diseases with the minimum pesticide input.

Key words: boom sprayer, air-assisted sprayer, inspection, Catalonia

1. Introduction

The 2009/128/CE directive for the sustainable use of pesticides makes the inspection of sprayers in use compulsory in all the member states. According to this directive, the reason for the compulsory inspection is the negative effects of pesticide application on the human health and the environment. The directive was incorporated into the Spanish law by and act in 2011. In this act it is established, among other things, what kind of sprayers have to be inspected. These are mobile application equipment for agricultural and other uses –horizontal boom sprayers, sprayers for bush and tree crops and dusters-, aerial application equipment and sprayers for greenhouses. Following the risk assessment requirements of the directive, handheld sprayers are excluded.

All the sprayers to be inspected –new or in use- have to be included in an official list since 2009, known as ROMA, for the Spanish acronym. This database has shown to be very useful for the implementation of the inspection programmes. It includes information about the kind of sprayer and its owner. In this way, the distribution of sprayers throughout the country can be known. To assure the accuracy of the list, if a sprayer is not included, the inspection workshop is not allowed to carry out the inspection.

As it is explained later, surprisingly there is an important number of sprayers included in the list, which have not passed the inspection yet. To tackle this issue, at the beginning of 2018, a field control of the sprayers was established in Catalonia. A working sprayer can be stopped to check if it has passed the inspection. If not, the owner can be fined.

2. Inspection workshops

As it is established in the Spanish law, inspections are carried out by the inspection workshops, which are authorised by the regions. At present, there are 18 authorised workshops in Catalonia to carry out sprayer inspections. Every inspection workshop has to be composed by at least one director and all the necessary inspectors and auxiliary workers for their inspection vehicles. The staff of the workshops has to pass a training course and have to have the required previous academic qualification, which is different for directors and inspectors.

The quality of the workshops activity is assured by the regional administration. In Catalonia, one control visit at the inspection site is scheduled to every 200 inspections or at least one every three months. In these controls, it is checked that the inspections are carried out according to the approved methodology and that the right inspection equipment is used.

3. The inspection programme in Catalonia

The Catalan inspection programme was set up to achieve the inspection of all the pesticide application equipment by the deadline established by the European directive. According to the number of sprayers included in the official list (ROMA) at the end of 2014 and taking into account their geographical distribution, a schedule for the inspection of the sprayers in a quarterly basis was prepared, starting at the second quarter of 2015. At the beginning of each quarter, communications were sent by post to the owners of the application equipment of the areas where the inspections were to be carried out. It was informed of the obligation of carrying out the inspection during the period and a list of the authorised inspection workshops was also included.

Figure 1 shows the comparison between the number of pesticide application equipment, which was planned to be inspected every term, and the number of inspections that were finally made. The amount of inspections carried out during the 4 quarters of the programme was lower than expected. However, it is noticed that at the beginning –third quarter of 2015- the number of inspections clearly increases. This must be triggered by the writing communications that were sent to the owners of the sprayers. Moreover, it can also be noticed that after the end of the programme, in the second quarter of 2016, inspections were also being carried out at a brisk pace. The inspections made before the beginning of the programme are related with a previous communication to sprayer owners in 2014.

The number of inspections carried out by the different workshops is depicted in figure 2, showing separately six of them, those who carried out most of the inspections. The trend in this figure is similar to that of the previous one, because the number of inspections of some of the workshops increases from the third quarter of 2015 on, when the inspection programme was started. The important differences in the number of inspections by some workshops in the same period of time, can be explained by the number of inspection vehicles used simultaneously by each workshop.

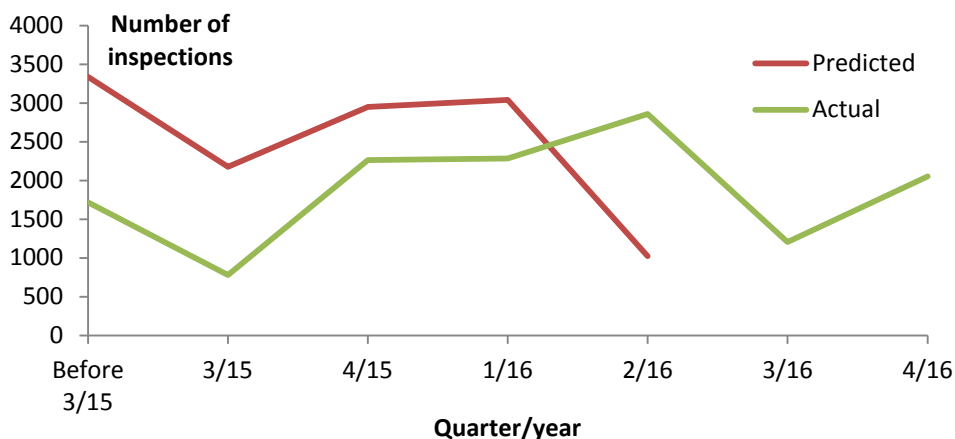

Figure 1. Quarterly evolution of the inspections predicted in the programme and the actual inspections

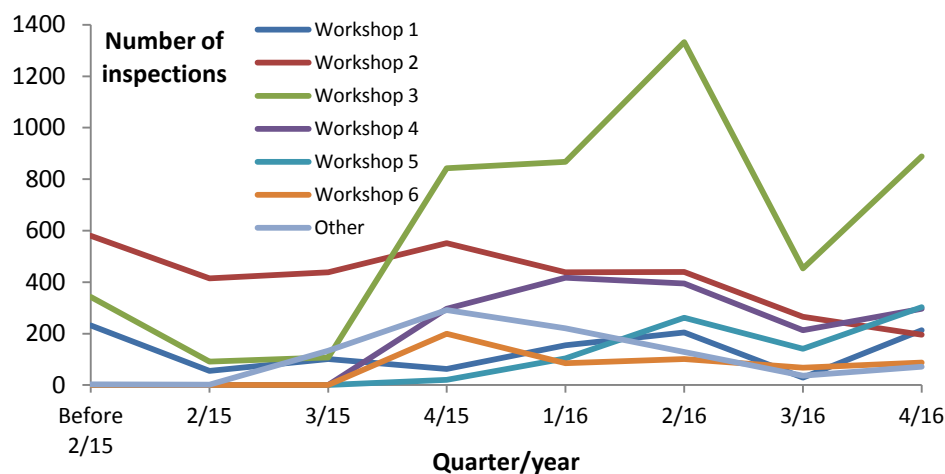

Figure 2. Quarterly evolution of the inspections carried out by the different workshops

The inspections used for this assessment were carried out according to the methodology established in the guidelines for the inspection of sprayers in use, available at the webpage of the Spanish Ministry. These guidelines were based on the EN standard 13790:2003, and they were intended for the inspections of boom and air-assisted sprayers, dusters and handheld spray guns and lances.

A software was also provided by the Ministry to the inspection workshops. By means of this software, it is possible to enter the information and measured values during the inspection and, at the end, it is possible to get a print out of the inspection report, which can be delivered to the sprayer operator. A text code, made up of 250 characters, is also automatically created for each inspection. It includes the sprayer identification, the date and the result of the inspection. Should the sprayer fail the inspection, information about the malfunction will also be recorded. All these codes have to be sent to the regulatory body, which keeps them in a database.

4. Assessment of the inspection results

A text file composed by all the codes of each inspection was analysed using the R software (The R Foundation). The objective was to get information about the development of the inspection programme and to assess the influence of the inspection of the sprayers in use in the improvement of the pesticide application equipment.

A pool of 11712 inspections carried out in Catalonia from 2014 to 2016 were used for the assessment. 4488 (38%) of them were reported as unfavourable inspections. Nevertheless, almost all passed a second inspection, after the malfunction had been repaired. The percentage of failed inspections provided by the different inspection workshops is similar, ranging from 35% to 45%. However, in some of them it doesn't reach 25%.

It has to be taken into account that many sprayers were already checked before the inspection. If some visual defects were spotted, it is thought that they were fixed before carrying out the inspection. Therefore, the actual percentage of non-compliant sprayers is likely to be higher than the one that is obtained from the inspection results. It is also possible that some sprayers with minor defects were not reported as unfavourable at the end of the inspection, because they were fixed in the same moment, instead of waiting for a second inspection.

4.1. Inspections according to the type of pesticide application equipment

Table 1 shows the number of the different types of inspected pesticide application equipment and, for each one, the percentage of unfavourable inspections is also depicted. It can be noticed that most of the inspections were made on boom and air-assisted sprayers, since they are the most used kinds of sprayers. Besides, the total numbers for both type of sprayers are very similar, as they are the corresponding percentages of unfavourable inspections. The third group by number of inspections is made up by the dusters, which are mainly used in vineyards. However the quantity of this kind of application equipment is low compared with the two previous groups. There is also a clear difference in the percentage of unfavourable inspections. In the case of dusters the percentage is around half of that of the sprayers. Some pneumatic sprayers, which are also mainly used in the vineyards, were also inspected. And just as an oddity, there is one reported inspection of a centrifugal sprayer and two of electrostatic sprayers.

Table 1. Number of inspected equipment and the corresponding percentage of unfavourable inspections

Type of pesticide application equipment	Number of inspected equipment	Percentage of unfavourable inspections
Boom sprayers	5291	39,6
Air-assisted sprayers	5671	39,4
Pneumatic sprayers	70	20,0
Centrifugal sprayers	1	0
Electrostatic sprayers	2	0
Dusters	677	20,2

4.2. Pesticide application equipment malfunction

Figure 3 shows the sprayer defect occurrence, which is reported in the unfavourable inspections. The most frequent malfunction is related with the measurements systems of the equipment, mainly faulty pressure gauges, which are not compliant with the requirements of the inspection standard. For instance, the scale of the pressure indicator can be inadequate –more than 0.2 bar in horizontal boom sprayers and more than 1.0 bar in sprayers for bush and tree crops. It is also frequently reported that the accuracy of the machine pressure gauge, which is measured during the inspection, is worse than required. Whatever the malfunction of the manometer, it has to be replaced by a new one.

The second group of defects spotted during the inspection is related with the protection of the operator. They are mainly related with the guards of the moving parts of the machine. These elements can be deteriorated or, in some cases, they are missing. The guard of the power take-off drive shaft, between the tractor and the machines, is usually deteriorated with the use. In many cases, however, it had been replaced before the inspection. Therefore, the faults that are more likely to be reported during the inspection are related with the guards of other power transmission parts. For instance, the power input connection before the sprayer pump and the fan power transmission. Other faulty safety devices are also reported in the sprayer fan itself, if guards to prevent the access are non-compliant.

Another important group of defects has to do with the filters. According with the inspection standard requirements, there shall be at least one filter on the discharge side of the pump –pressure section of the sprayer manifold, between the pump and the nozzles- and one filter on the suction side, if the sprayer is equipped with positive displacement pumps. Many small boom sprayers used for band spray applications in tree and bush crops, or equipped with guns and lances, don't have filters in the required position. It is also thought that, sometimes, the missing filters were mounted on the sprayers before the inspection and, therefore, the reported defects during the inspection are not an accurate indicator of the actual condition of the sprayers in use.

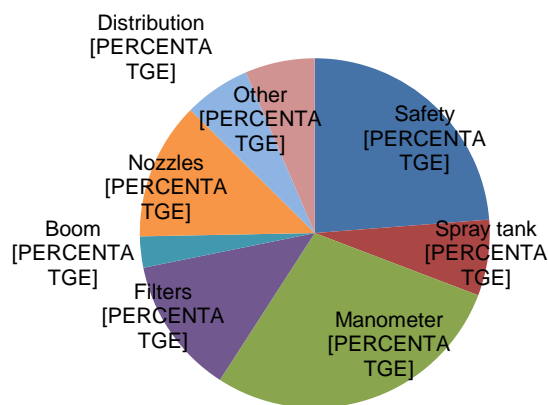

Figure 3. Percentage of defects found during the inspection of all types of pesticide application equipment

Nozzle malfunction reported during the inspections is mainly caused by the excessive deviation between the measured and the nominal nozzle flow rate. If the nominal flow rate is not known, the deviation is computed in relation to the average flow rate of all the nozzles of same type mounted on the sprayer. The cause of this excessive deviation can be either nozzle wear or clogging, depending if the measured values are higher or lower than expected. In case of excessive wear, the sprayer nozzles have to be replaced by new ones. Old hollow cone nozzles, with an adjustable spray jet width, are usually non-compliant with the flow rate deviation requirements of the inspection standard, since the flow rate depends on the jet width. In this case, it is recommended to replace these nozzles by new hollow cone models.

The reported faults related with the sprayer tank are mainly due to a bad condition of the tank contents indicator. It is very common that plastic sprayer tanks are equipped with a translucent band, through which the liquid level inside can be seen. With the use, this band becomes too dark to see through it. In this case, to pass the inspection it is necessary to mount another tank contents indicator, like a transparent plastic hose outside the tank, connected with the liquid inside.

Finally, the defects included in the distribution section are mainly caused by an excessive pressure loss between the measuring point, in the place where the sprayer manometer is mounted, and the position

of the nozzles. There can be many reasons for this, like for instance, an excessive pressure loss along the sprayer pipes and hoses, or a pressure loss in a point of the sprayer manifold, like an electro valve or a connection. If the cause cannot be found, the connection point of the manometer can be moved closer to the nozzles, so that the pressure loss will be reduced.

For a more detailed assessment of the defects and malfunctions reported during the inspections, figure 4 shows the differences found between horizontal boom and air-assisted sprayers. In relation with the filters, the percentage of defects is higher in boom sprayers. This may be caused, as it is said before, by the design of the small sprayers used for herbicide applications in tree and bush crops. On the other hand, air-assisted sprayer inspections report a higher number of nozzle defects than boom sprayers. For air-assisted sprayers, the malfunction of the blowing unit is also indicated, although the percentage is very low. This can be explained by the fact that defects in the blowing unit are mainly related with safety devices, which are already reported in the safety section.

In relation to the inspection of dusters, only defects related with the safety devices were reported, both in the power transmission and the blowing unit. Since these machines are designed for the application of pesticide dust, there are no pressure measuring devices, like the manometers of the sprayers. Besides, the flow rate of the application unit is not measured either. The compliance is checked by inspection and functional test.

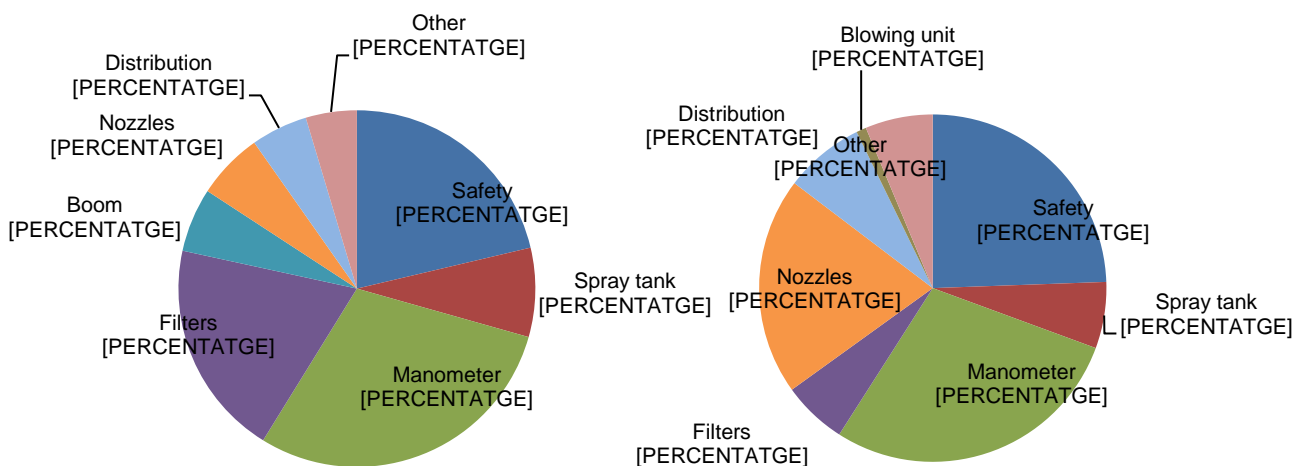

Figure 4. Percentage of defects found in the inspection of horizontal boom sprayers (left) and sprayers for bush and tree crops

5. Final comments

According to the 128/2009/CE directive, all pesticide application equipment should have been inspected by the end of 2016 in all member states. In Catalonia, as in other countries, there is still a significant number of sprayers that have not passed the compulsory inspection, but they are still used in crop protection.

As it has been shown in this paper, most of inspections were carried out in horizontal boom sprayers and in sprayers for bush and tree crops. In both types of machines, the percentage of unfavourable inspections was roughly 40%.

Therefore, the amount of defects and malfunctions that are corrected during the inspections is important. The improvement of the application equipment should have a clear positive effect on the quality of the pesticide applications, because of an improvement of the efficiency and a decrease of the risk on the human health and the environment.

Session 2: Common procedures for Pesticide Application Equipment (PAE) risk assessment and for the evaluation of environmental benefit of the inspection

Advise for risk assessment concerning the inspection of pesticide application equipment in use according to article 8 (3) of Directive 2009/128/EC

Bruno Huyghebaert¹ David Nuyttens² Marie Stas¹, Jens Karl Wegener³

¹Agricultural Research Centre (CRA-W), Belgium,

²Institute for Agricultural and Fisheries Research (ILVO), Belgium,

³Julius Kuehn-Institut, Germany

Introduction

Article 8 (3) of Directive 2009/128/EC (Sustainable Use Directive) demands a Risk Assessment (RA) for human health and the environment including an assessment of the Scale of Use (SU) of the equipment in order to apply different time tables and inspection intervals in selected cases for the inspection of pesticide application equipment (PAE) in use. These exemptions in regard to different time tables and inspection intervals are concerning PAE

- not used for spraying pesticides,
- which are handheld application equipment,
- knapsack sprayers,
- or additional PAE that represent a very low scale of use.

Furthermore, Directive allows derogations from the mandatory inspection for knapsack or handheld sprayers, also based on a Risk Assessment for human health and environment and an assessment of Scale of Use.

This considered, we believe it is necessary to provide a **SPISE advice** on how to make such a Risk Assessment and an assessment of the Scale of Use in a practical and harmonized way on European level.

Considering literature review, most publication about risk assessment methods agree on the general concept: *Risk depends on the exposure of a "target" to a hazard (then to an impact) and on the exposure frequency (Figure 1).*

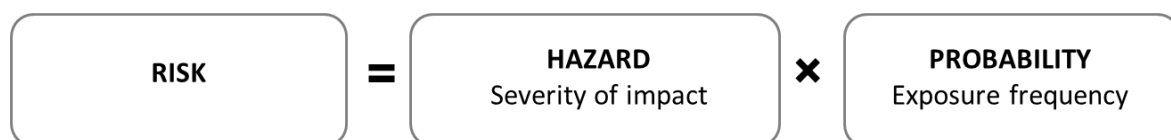

Figure 1: Parts of the Risk related to a hazard

Therefore to develop a RA process, some questions have to be precisely answered: (i) What is/are the hazard situation(s); (ii) who/what is concerned by the hazard situation(s); (iii) which impacts have to be taken into consideration; (iv) what is the exposure frequency of the subject at risk.

In the context of the PAE inspection, the risk related to the use of a PAE is clearly based on the technical dysfunctions or technical defects of this PAE, occurring during the pesticide application.

Even though the major part of the risk linked to the use of PAE is due to the pesticides itself; it is not practically possible to take into account the intrinsic toxicity of the applied pesticides. Indeed, a given PAE can apply different pesticides (active ingredients) presenting each different levels of toxicity. For that reason, the applied pesticide toxicity will be considered as an invariable factor.

In the framework of the Directive 2009/128/EC, the targets considered at risk are clearly the human health and the environment.

Impacts on human health or environment depend on the hazard source and of the way of exposure. In this case, hazards mostly are from wear or accident. They can be over- or under dosages or injuries induced by the use of PAE presenting technical defects.

The exposure is linked to the occurrence of a technical dysfunction. Depending on the RA method used, it can be determined by a statistical approach based on available data of the sprayer inspection scheme, or it can be determined by a linear scale relative to PAE number.

Thereby, in the context of PAE inspection, a technical risk is the product of probability of occurrence of a certain technical defect and the severity or extent of the subsequent impact (Figure 2).

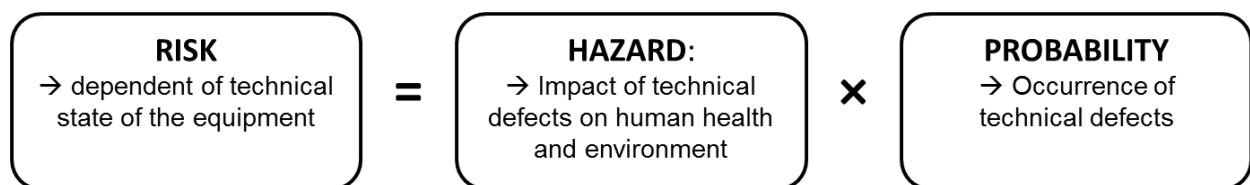

Figure 2: Part of Risk related to the use of PAE

The present SPISE Advice proposes two different approach to develop a Risk Assessment related to the use of PAE and their inspection: the Zurich method and the Apesticon method.

The first methodological basis is the risk matrix according to Nohl and Thiemecke (1988). This is a common method for technical risk assessment also known as Zürich-methodology. It is applied for the assessment of safety risks e.g. of aerial railways or for the assessment of risks arising from the operation of nuclear power plants. In SPISE context, it focusses on the risk evaluation of using different categories of PAE. Its advantage is to give results very quickly. It is accessible to every nation thanks to a simple process using little data that could be harvested by each country.

According to Stas et al (2016), the second method 'Apesticon' not only focusses on the risk evaluation of using PAE, but also on the risk reduction which can be achieved by inspecting different categories of PAE. This methodology offers a precise and complete risk assessment. Results are closer to reality and can be interpreted in several useful ways.

The results given by the two methods are not objectively equivalent and the degree of completeness of the results is different. The choice of one method to the other should be based on the available data in the country. Nevertheless, both approaches have been tested successfully in Germany and Belgium.

Zürich methodology

Concepts and assumptions of the methodologies

Aim of the matrix is to define how high a risk might be. Concerning the risk assessment of PAE in use the advantage of this methodology is that the risk assessment can be reduced to those technical parameters which are in the focus of the inspection of PAE in use (Wegener 2014).

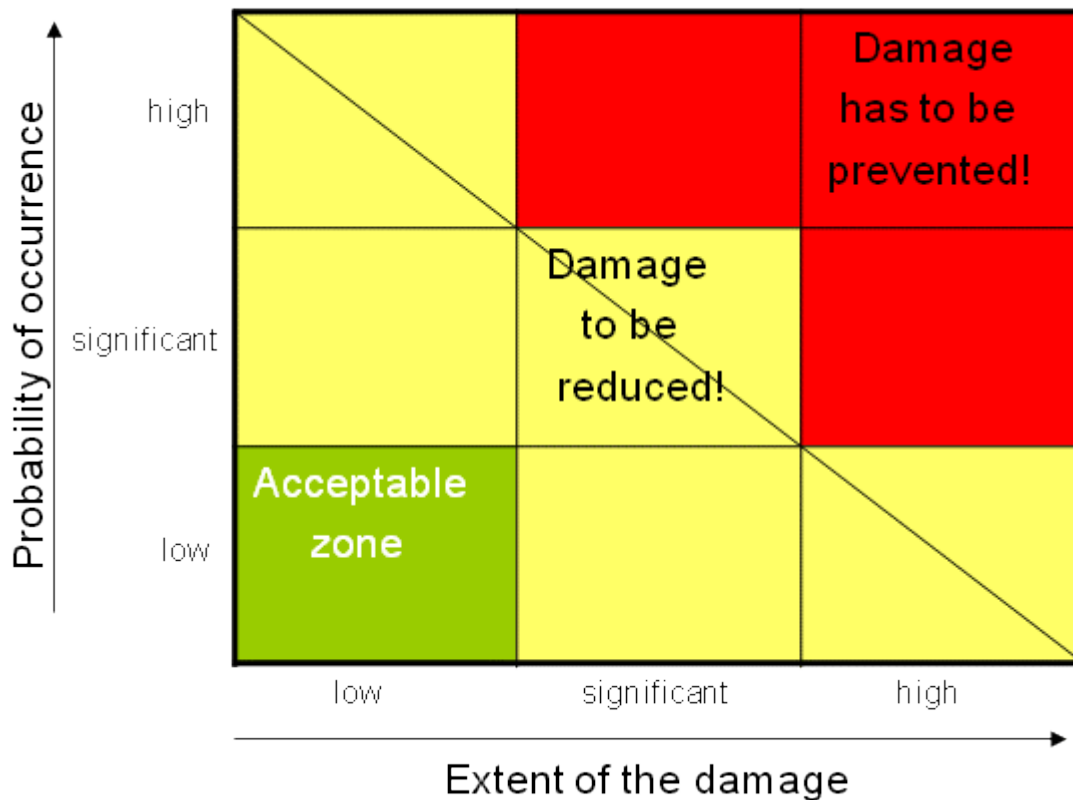

Figure 3: Risk matrix according to Nohl and Thiemecke (1988)

The extent of damage is discharged by a qualitative analyses of equipment components being part of the inspection (acc. ISO 16122) and their impact on human health and the environment in case of technical disorder.

Technical parameters – equipment

To apply the Zurich methodology, each category of PAE was judged by nine different experts of SPISE by using qualitative measures (++; +; 0; -; --) for the following equipment components: Power transmission parts; Pump; Agitation; Spray liquid tank; Pipes and hoses; Spray boom; Filter; Nozzles; Controls; Regulation System; Distribution / drift; Cleaning; Blowers. The qualitative measures were then transformed into a point system: ++ = 20 points, + = 15 points, 0 = 10 points, - = 5 points and -- = 0 points. Afterwards the judgment of each expert was added together for each category of PAE. Table 1 shows the average figures of judgment made by all experts for each category of PAE. These components correspond mostly to those of some spray application techniques. For other techniques which can potentially be exempted (PAE not used for spraying pesticides, handheld application equipment, knapsack sprayers or additional PAE that represent a very low scale of use) additional components need to be analyzed.

Table 1: Different categories of Pesticide Application Equipment and the proposed impact of their components on human health and the environment (Wehmann 2015a)

Pesticide Application Equipment (PAE)								
Equipment components	Handheld sprayers	Knapsack sprayers	Not used for spraying	Additio- nal/ low scale use	Hand operat- ed	Additio- nal/ aircraft	Additio- nal/ train	Spraying incl. fogging
Power transmission parts	0	3	12	13	9	12	9	16
Pump	8	8	11	11	13	13	11	15
Agitation	4	4	4	10	14	13	11	16
Spray liquid tank	9	8	8	12	13	14	11	18
Pipes and hoses	9	9	11	12	18	14	13	16
Spray boom	2	9	11	12	12	13	12	14
Filter	6	8	5	11	11	13	11	13
Nozzles	12	9	9	13	16	16	13	16
Controls	9	9	9	9	13	13	11	13
Regulation systems	7	8	10	11	12	15	12	14
Distribution/ drift	9	12	9	12	13	17	16	18
Cleaning	9	9	8	11	13	14	13	18
Blowers	2	6	7	7	4	1	2	13
Sum	87	105	114	143	161	170	184	199
Priority sum	by 1 th	2 nd	3 rd	4 th	5 th	6 th	7 th	8 th

Probability of occurrence and scale of use

The probability of occurrence is normally figured out by taking the number of incidents of each group of PAE into account. Since there are no such statistics available on a national level of all Member States (SPISE 2014) this lack of information can be solved in the Zürich methodology by taking the number of different PAE in professional use in practice into account. For this method, it should be supposed that these numbers are proportional to the frequency of incidents. Another expert survey was made to find out about the numbers of PAE in different Member States (Wehmann 2015b). In order to make the reported numbers comparable on a supranational level they were divided by the total sum of arable land per Member State according to national figures (Table 2)

).

Table 2: Reported numbers of PAE in professional use sorted by category and accounted per million hectare.

Member State	PAE per million hectare							
	Handheld	Knapsack-sprayer	Not used for spraying	Additio nal/ low scale use	Hand operated	Additio nal/ aircraft	Additio nal/ train	spraying (incl. fogging)
Belgium	22.091	14.728	74	147	2.946	*	1	16.281
Czech Republic	57.405	57.405	287	57	57	9	11	3.444
Germany	13.170	23.946	808	299	1.916	0	2	10.297
Italy	1.128	2.722	544	389	3.889	1	2	50.560
Luxemburg	534	22.901	382	1.527	1.527	*	*	10.053
The Netherlands	2.671	53.419	1.068	2.671	2.137	1	3	10.417
Norway	50.454	10.091	10.091	5.045	3.027	1	3	20.182
Spain	*	*	*	*	2.105	*	*	12.041
Sweden	2.935	24.462	326	294	326	1	1	5.219
United Kingdom	*	2.741	*	*	*	0	1	2.295
Average	15.039	21.242	1.358	1.043	1.793	1	2	14.709

*not reported

In a next step the risk matrix is established by using different levels for the probability of occurrence in a linear scale with an increment of 5,000 PAE per million hectares (Figure 4). Within the first level the sum of the extent of damage for each category is used. The figures within the next lines of the matrix are in each case just the first ones multiplied by the mentioned level.

Results integration and application

According to Article 8 (3) of Directive 2009/128/EC the categories of PAE being exempted from inspection, if operators are trained, are marked in green, the ones where the inspection is mandatory are marked in red and the ones where different time tables and inspection intervals can be applied are marked in yellow.

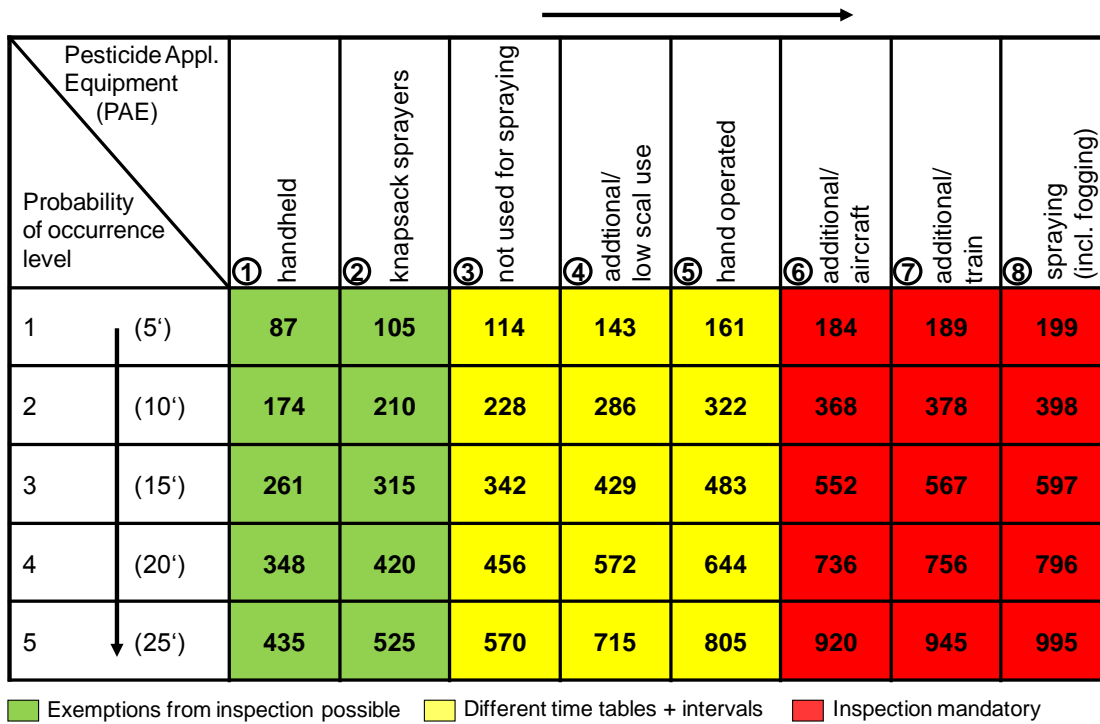

Figure 4: Risk matrix

Next the risk tolerance line has to be defined, which is a measure for what kind of risks are still acceptable or not. Therefore, the average numbers of PAE reported in

Table 2 are integrated into the risk matrix in a qualitative manner. To have an equal treatment of all PAE categories considered, the highest acceptable risk is the baseline for the risk tolerance which has to be applied (Wegener 2015). In this case, the numbers of “handheld” and “knapsack sprayers” are basis for the definition of the risk tolerance being acceptable.

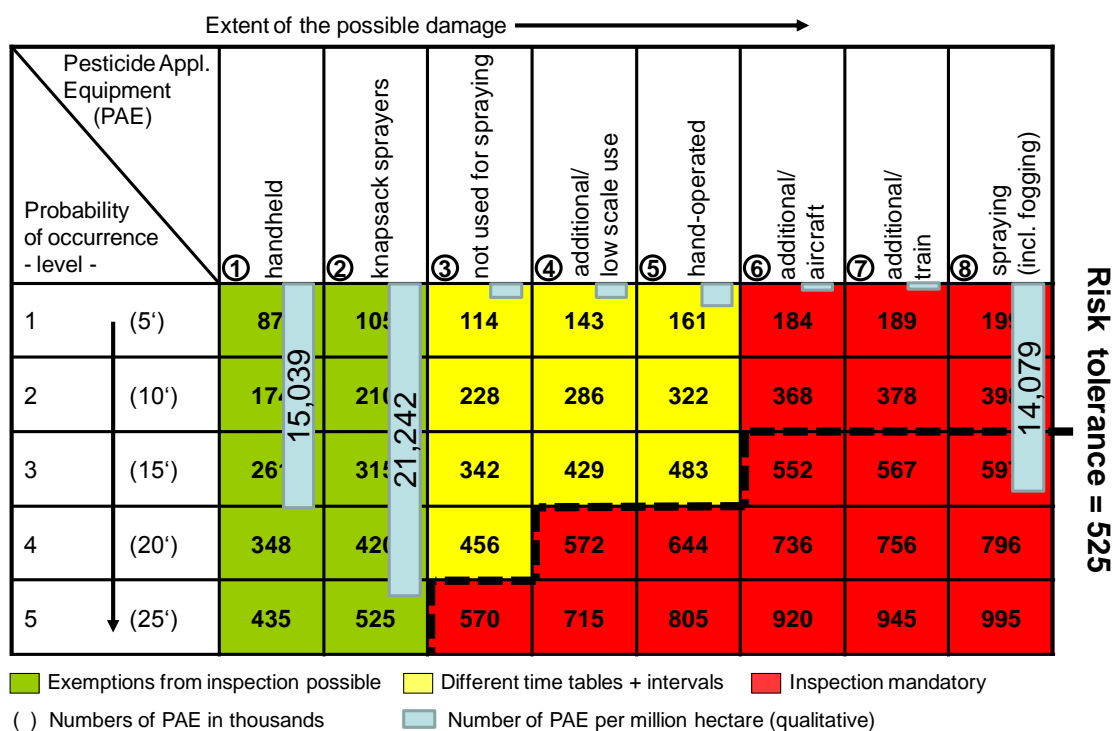

Figure 5: Risk matrix including the average figures of PAE per million hectare of nine Member States and the derived risk tolerance line

Following Figure 5 the highest acceptable risk is defined by the number of knapsack sprayers which is within the 5th probability of occurrence level. For this reason the risk tolerance line is 525.

Results interpretation

To apply the risk assessment on Member State level national figures for each category of PAE have to be integrated into the risk matrix presented in Figure 5. Different time tables and inspection intervals can be applied for those of the categories “not used for spraying”, “hand-operated” and “additional – low scale use” where the histograms does not intersect the risk tolerance line. According to Article 8 (3) of Directive 2009/128/EC the categories “additional/train”, “additional/aircraft” and “spraying incl. fogging” must be inspected even if the mentioned histograms does not intersect the risk tolerance line.

Apesticon risk assessment method (or Belgian method)

Concepts and assumptions of the methodologies

The Apesticon risk assessment is performed “before inspection” (presence of a defect, above inspection tolerance level and without defect correction) and “after inspection” (all defects are repaired regarding the inspection tolerance level). The general objective is to evaluate the potential risk reduction induced by the inspection. This process in two steps allows performing a complete RA according the ISO 12100 (2010). At the end for the authorities, only a notable risk reduction could justify the necessity to inspect the PAE type concerned.

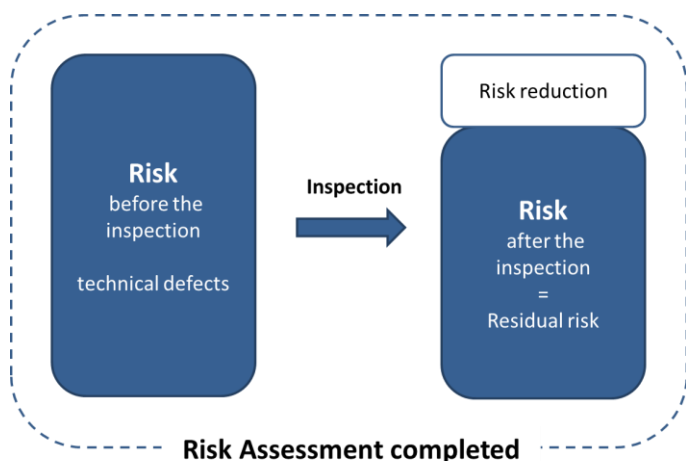

Figure 6: Complete Risk assessment related to the use of PAE and its inspection according to Stas et al. (2016).

The Apesticon methodology is based on actual data and experts judgment to gather data at the national level:

One makes use of the database of the inspection results and the amount of pesticides used (Eurostat).

Survey of stakeholders can be used to determine the scale of use of the different types of PAE, the technical and human contribution in the risk, and the risk reduction potential of the inspection.

It is considered that PAE are used following the Good Agricultural Practices. Because of their independence from the technical aspects, the local external conditions (as weather or cultural practices) are considered as invariable.

Considering the output and depending of the level of aggregation, this approach is able to provide the Risk (R) and the Risk Reduction (RR) caused by the inspection for: one defect, one PAE, one type of PAE at the national level, one type of PAE at national level taking account the human contribution in the risk and finally the distribution of the risk for the different types of PAE used at the national level (Figure 7). R and RR can be calculated separately and also aggregated for the different compartments considered at risk (human health, consumer, environment).

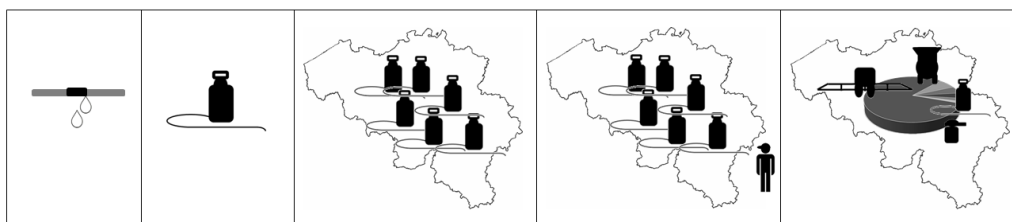

Figure 7: Different levels of aggregation for the calculation of Risk and Risk Reduction: one defect, one machine, one PAE type at national scale (only technical risk), one PAE type at national scale (technical+human risk), different PAE types at national scale (Stas et al., 2016).

Technical parameters - equipment

Based on the inspection protocol of each PAE type, the inspection parameters and the corresponding technical defects are listed. The basic rule of this method is to consider that one “defect” corresponds to each inspected parameters of the PAE. Since the consequences of the defects are the basis of the hazard and of the impact definition, the list was elaborated with the descriptions of the four data:

- Items
- Parameter
- Consequence
- Extent of the risk

“Items” are the requirements which are potentially subject to inspection. They are mostly components of the PAE, such as “filter” or “spray boom” but it also can be a direct defect such as “leaks” for example. “Parameters” are descriptions that refer to what is really inspected. These descriptions may contain the tolerance levels. “Consequences” are descriptions of the impacts on Environment and on Human Health. These are mostly under- and overdosages but they also can be injuries caused to the operator. “Extents” are evaluations of the surfaces impacted by the under- or overdosage. They can be “point” (one isolated place), “localized” (a strip) or “global” (on the whole parcel treated).

The list is available in a table called “inspection table”. It was elaborated based on Belgian data. As the PAE types in use are not necessarily exactly the same through the different countries, the list should be reviewed before application in other countries.

In theory, impact is the consequence of the hazard on the exposed subject. In the context of this paper, it is the consequence of technical defects on human health and environment: over-dosage, under-dosage, or injuries induced by the use of PAE during the pesticide applications. Severities of impact need to be evaluated to estimate the risk. In Belgium, a questionnaire was submitted for experts’ judgment (mixed panel of Belgian experts). “Severity” is presented as a relative value between 1 and 10, when 0 = no impact and 10 = maximum severity of impact, defined for each situation impacting human health or environment. Every potential technical defect corresponds to a specific situation of impact. Values (1-10) are defined by experts’ opinion.

Severity is evaluated in two situations: “before inspection” and “after inspection”. This evaluation is of a great importance to determine the Risk Reduction due to the inspection. In the case “before inspection”, the parameter is deficient and the level of deficiency is above tolerance level of inspection. In the case “after inspection”, the level of deficiency is below the tolerance level defined by inspection. It should be notice that it is absolutely possible that the Severity of impact of a defect “after inspection” (after reparation) can be different from 0. For example, a Severity is estimated at 7 for the impact of a leak on the operator (before inspection) and is estimated at 2 after inspection and reparation of that leak. Even after reparation, an inspected parameter can present a residual hazard.

The Severity values are defined to be valid for all PAE types. For example, a Severity value of 7 defined for a leak will remain “7” for field crop sprayers, knapsack sprayers, spray train, handheld sprayers and all other PAE.

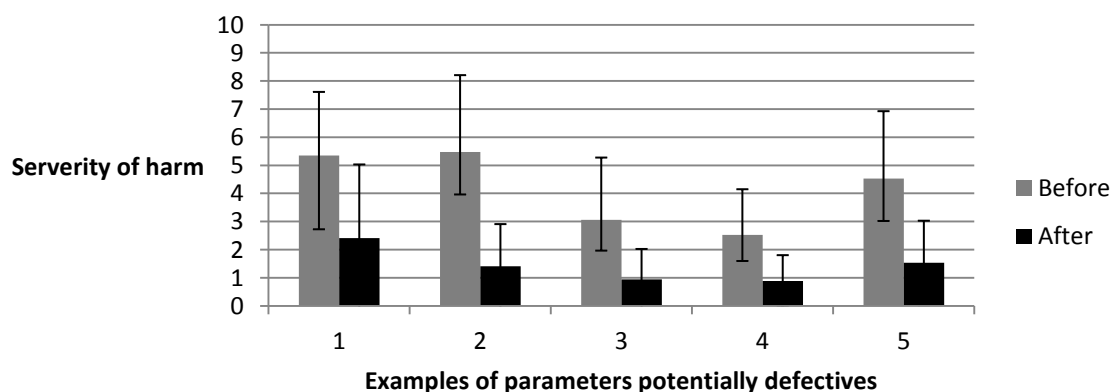

Figure 8: Examples of severities of harm on the environment. Grey=Before inspection ; Black=After inspection. Parameters: 1=General condition of the sprayer; 2=Presence and readability of the tank

content indicator; 3=Presence and condition of the tank filling strainer; 4=Presence and condition of the suction filter; 5=Presence and condition of the discharge filter

Belgian data are available in the “inspection table”. They can be used for the risk calculation of other countries. In this case it should be assumed that Severity values are the same whatever the PAE type and that the ways of exposure (to the operator, the consumer or the environment) are the same whatever the country.

Probability of occurrence and scale of use

The Belgian method takes into account the number of incidents (number of technical dysfunctions in a given interval of time) of each group of PAE. Occurrence illustrates the frequency of defect emergence during a complete inspection cycle. In Belgium it is three years. Therefore, the occurrences values given in this paper are obtained on that basis. They are defined for each inspected parameter thanks to the available data from the sprayer inspections in Belgium (Field crop sprayers, Orchards, Fixed and semi mobile sprayers). Since these data are expressed in percentage, they could be used in risk calculation whatever the country and its inspection cycle duration. It should be supposed that frequencies of defect emergence are the same for a machine in Belgium and for a machine in the country of study. If occurrence needs to be reconsidered in another country, it should be calculated based on the inspection data of that country and the inspection cycle duration.

The occurrence is combined with the Severity of impact of each defect in order to calculate the risk.

The scale of use reflects the amount of utilization of a specific type of PAE at national scale. It is based on 3 factors:

1. Amount of pesticides sold per year in the country of study. In the same way as for occurrences, for Belgium the scale of use is calculated every three years corresponding to the last complete inspection cycle (2011-2013). Important: These data should be specific to the country of study, so that the scale of use reflects the country scale.
2. Repartition of active substances potentially used among PAE types. This repartition was realized by Belgian experts specialized in pesticides and in PAE inspection and could be used for other countries. In that case, it should be supposed that a given PAE type is used with the same potential products in Belgium and in the country of study.
3. Frequency of use of each PAE type. In Belgium, a national enquiry allowed evaluating the number and frequencies of use of the PAE types in Belgium. It was conducted by professionals and farmers. 42 professional and more than 300 farmers answered. A similar national enquiry should be conducted in the country of study. Frequency of use of each PAE should be specific to the country, because farmers will use differently the PAE types regarding their activity.

Results of scale of use can be expressed in absolute values or in relative values (percentages) as in Figure 9.

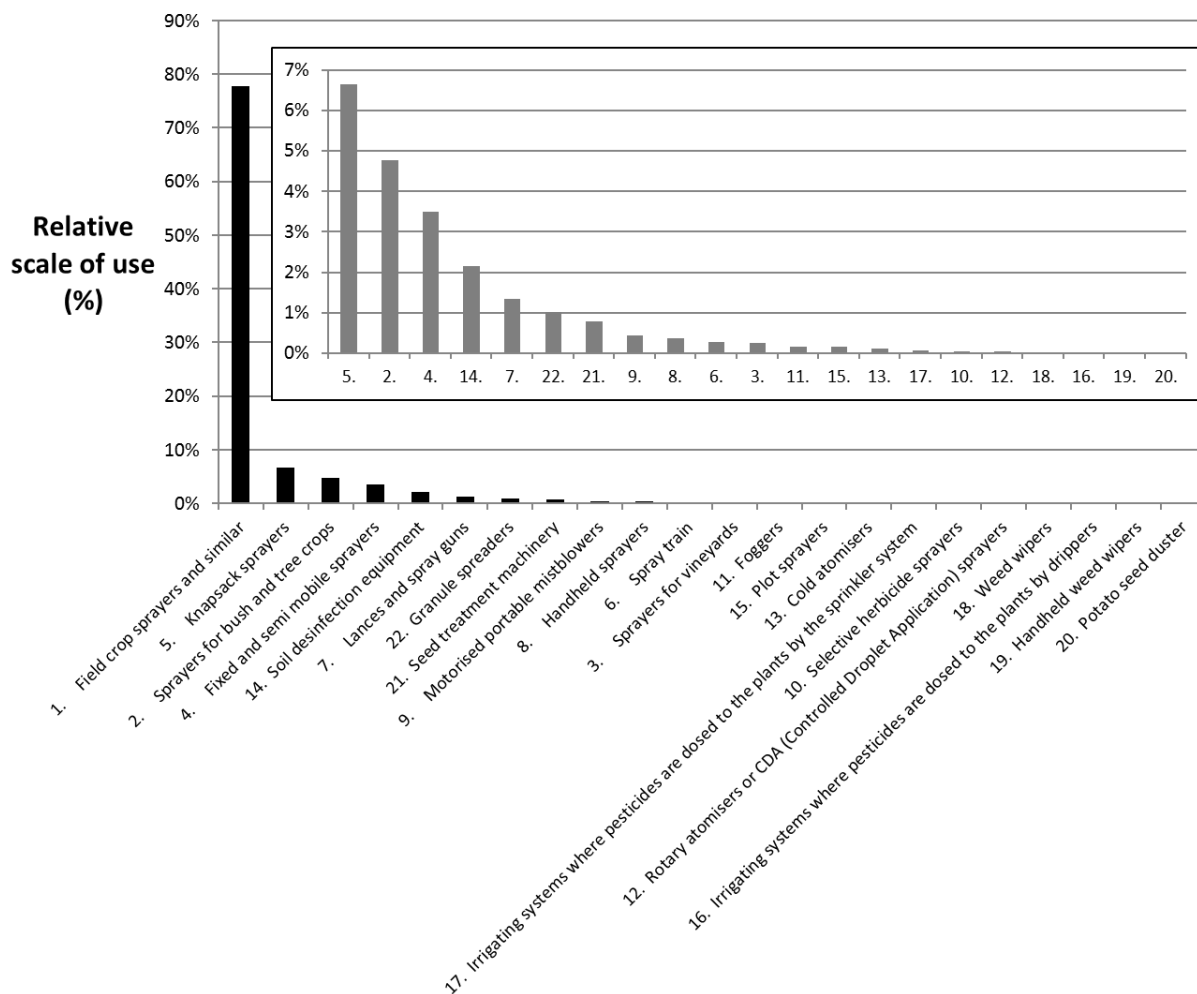

Figure 9: Scale of use of the different PAE types, calculated for Belgium. Results are expressed in percentage from the sum of scales of uses of all PAE types

Results integration and application

Within the whole risk assessment, risk is then calculated in different steps (Figure 10), as described below.

At the scale of the defect, the Severity of impact (to the environment, the operator or the consumer; before and after inspection) is combined with the probability of occurrence by two methods described below. The two methods are named "defects only" and "defects+residual risk":

1: "Defects only"

Risk (before/after inspection)	Calculation
Before inspection	occurrence*Severity before
After inspection	occurrence*Severity after

This method represents the risk, considering that all parameters studied are defectives.

2: "Defects + residual risk"

Risk (before/after inspection)	Calculation
Before inspection	Severity before *occurrence + Severity after*(1-occurrence)
After inspection	Severity after *occurrence + Severity after*(1-occurrence) = Severity after

This method represents the total risk (risk of defect + residual risk). The risk is calculated for the defective parameters and also for the correct parameters (for which a residual risk can remain).

→Risk for one defect is obtained.

- Risks of all defects of one machine (one PAE type) are summed.

→Total technical risk for one single and entire machine is obtained.

- The risk for one machine is extrapolated, by multiplying the scale of use (corresponding to the PAE type concerned) to the result.

→Technical risk for one type of PAE is obtained at the national scale.

- The technical risk for one type of PAE in the country can be completed by a human part of risk.

In this work, we assume that pesticide application is more dangerous when there are technical defects on PAE. By this RA method, only the risk due to technical defects is calculated. However, another source can cause an imperfection on the application: human mistake (or human behaviour). Those two sources of suboptimal application (technical defects part and a human behaviour part) can be gathered in a total risk for pesticide application.

In order to determine the size (% of the total) of each part, an enquiry was launched with experts, including inspection managers from 11 countries. Human behavior and technical defects parts were determined for every PAE type. Results are expressed in percentage.

→Then the total risk related to pesticide application for one PAE type at the scale of Belgium is obtained

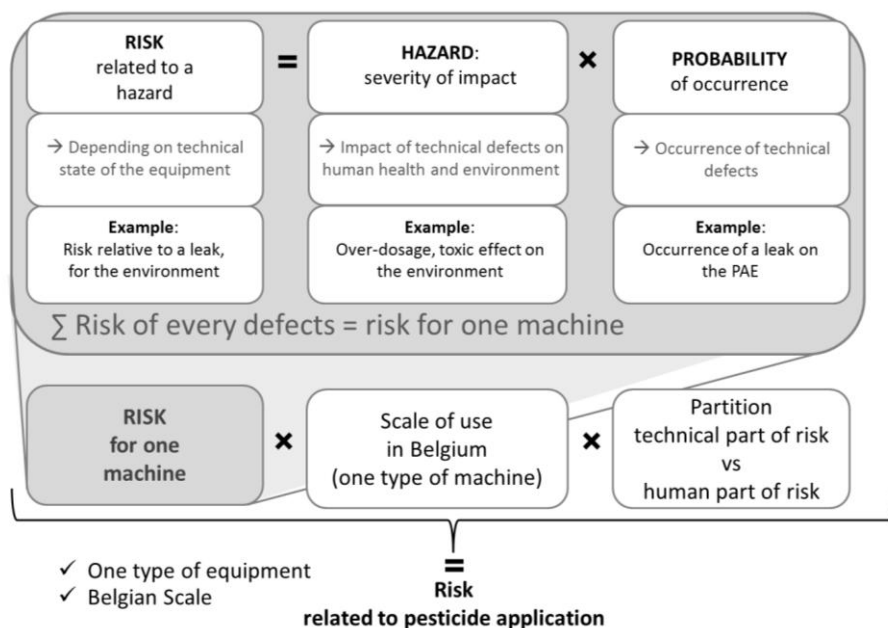

Figure 10: Risk Assessment, method of calculation

Results interpretation

The Apesticon method has been specially developed to realize a complete Risk Assessment according to the article 8 (3) of Directive 2009/128/EC. This method was developed within the Belgian case study, but can be quite easily transposed in other Member States. It can support decision making. The numerous results can be expressed in charts. Decision can be made by common sense rules, taking into account the levels of risks and the magnitudes of risk reductions, at every step of the risk assessment:

Scale of defects

The risks at the scale of the defect are useful to elaborate new inspection protocols. The defects for which the risk is almost zero could be exempted of inspection. The defects that present the biggest risks should be inspected. The decision about inspection of a defect can also be influenced by the risk reduction induced after inspection.

Scale of the machine

The risks at the scale of the machine have to be subjects of attention concerning the risk reductions because they directly reflect the effects of technical inspection when the “defects only” are analyzed. A maximum level of risk could be defined for the operator safety and a maximum level of risk can be tolerated in an exclusion of inspection. But it will be subject of discussion by taking account of the other analyzes of risk (with scale of Belgium) and for example the toxicity of substance applied and the partition between human and technical risk. Figure 11 gives an example with risk and risk reduction values for knapsack sprayers.

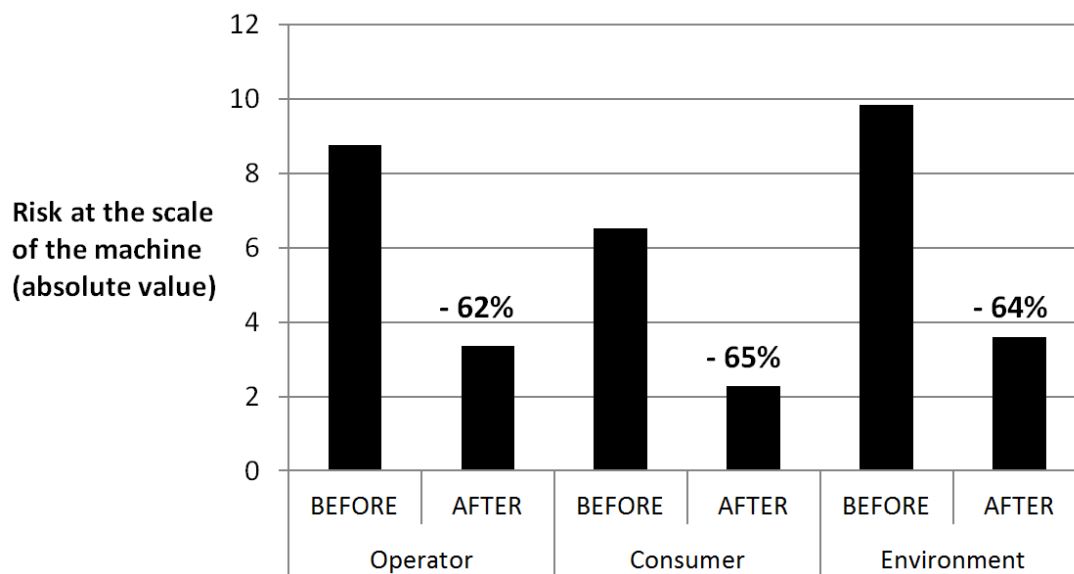

Figure 11: Results of risk calculation in absolute values for Knapsack sprayers. Risks for the operator, for the consumer and for the environment. Scale of the machine, method “defects only”. BEFORE=before inspection; AFTER=after inspection. Risk reduction between BEFORE and AFTER are indicated in percentage.

Scale of the country (technical)

The advantage here is the global vision offered by the total technical risk. The great differences in risk values between PAE types are due to the scales of use that are specific to each PAE type. In order to define the necessity (and the intervals) of technical inspection, a focus on the technical risk should be more relevant than the total “technical+human” risk. Indeed, the technical risk answers more directly to the question of inspection effect. Then, a maximum level of risk can be defined as tolerance level for an exclusion of inspection at the Belgian scale.

A maximum level of risk could be defined for the consumer and for the environment. Indeed, the consumer and the environment are targeted by a global pollution of the Belgian surfaces. An example of Belgian results is given in Figure 12.

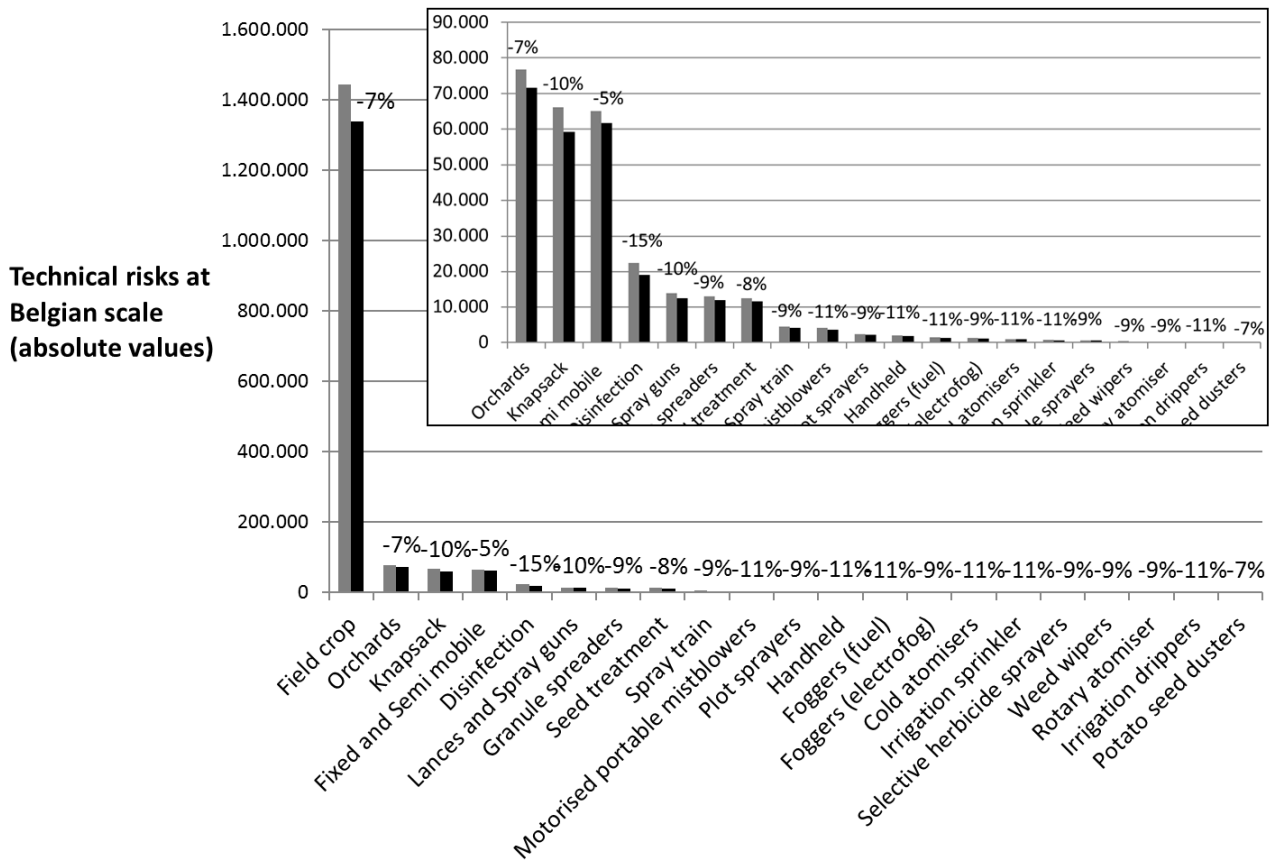

Figure 12: Results of risk calculation in absolute values for different PAE types. In this chart, risk for the operator, risk for the consumer and risk for the environment are gathered in an average. National (Belgian) scale, method “defects + residual risk”. Grey=before inspection; Black=after inspection. Risk reductions between before and after inspection are indicated in percentage.

Scale of the country (technical + human)

The total risk “technical+human” offers an overview about the risk of pesticide application in Belgium. It is interesting in terms of comparison of PAE types.

The partition between human and technical part of risk, in percentage of total risk, offers additional information very useful in decisions about mandatory inspection. That could justify the necessity (or not) to reduce the technical risk by the way of an inspection, in order to reduce significantly the risk total of pesticide application.

Conclusions for the two methodologies

The risk matrix according to Nohl and Thiemecke (1988), or the Zürich methodology has the advantage to be accessible to every nation thanks to a very simple process using data that could be easily harvested by each country. Results can be available quickly and limits of decisions are putted (imposed) clearly. Risks of 8 PAE types are evaluated for all target combined by the way of 13 technical components. Details of the method are available in a publication (Wegener, 2015).

A risk assessment can also be implemented following Belgian method (Stas et al., 2016). It requires some data gathering in the country of study: the sales or the use of pesticide active substances (in Kg); the frequency of use of each PAE type by professionals (this data can be obtained by a national

enquiry). According to the cultural practices of the country concerned, an update of the list of PAE and parameters associated should be achieved. By this method, risks can be calculated for an unlimited number of PAE types. It distinguishes different targets: operator, consumer, and environment. Risk reductions give an indication on the effect of an inspection for the different PAE types. Results can be obtained at the scale of the technical component, of the machine or the scale of the country. Risk values and risk reduction values at every step of the risk assessment deliver a strong theoretical basis to support decision making.

References

1. ISO 12100 (2010) Safety of machinery – General principles for design – Risk assessment and risk reduction, © ISO 2010 – 78 p.
2. Nohl J., Thiemecke H., 1988: Systematik zur Durchführung von Gefährdungsanalysen [Systematic for the execution of hazard analysis]. Bremerhaven: Wirtschaftsverlag NW (Schriftenreihe der Bundesanstalt für Arbeitsschutz Fb 536).
3. SPISE, 2014: Oral expert survey done during SPISE V during Session of TWG 2. Fifth European Workshop on Standardised Procedure for the inspection of sprayer – SPISE V– Montpellier, France, October 15.-17. 2014, unpublished.
4. Stas, M., Nuyttens, D., Zwertvaegher, I., Defays, G., Declercq, J., Mostade, O., Dekeyser, D., Huyghebaert, B., 2016. Development of a risk assessment procedure for pesticide application equipment within the framework of article 8 of the EU Directive 2009/128 and development of specific inspection procedures. APESTICON final report, 'FOD Volksgezondheid, veiligheid van de voedselketen en leefmilieu' (RT 14/8 Apesticon 1), December 2016.
5. Wehmann H.J., 2015a: Summary of an expert survey concerning the impact of components of PAE on human health and the environment. Personal communication between H.J. Wehmann (Julius Kühn-Institut) and nine experts from nine different European countries (Belgium, Czech Republic, Germany, Italy, Luxemburg, Spain, Norway, Sweden and The Netherlands), unpublished.
6. Wehmann H.J., 2015b: Expert survey about the numbers of PAE in different Member States. Personal communication between H.J. Wehmann (Julius Kühn-Institut) and ten experts from ten different European countries (Belgium, Czech Republic, Germany, Italy, Luxemburg, Spain, Norway, Sweden, The Netherlands, United Kingdom), unpublished.
7. Wegener J.K., 2014: Sprayer inspection parameters as a basis for risk assessment for human health and the environment. In: P. Balsari, H.J. Wehmann (Editor), Fifth European Workshop on Standardised Procedure for the Inspection of Sprayers in Europe - SPISE 5 -, Montpellier, Frankreich, 15.-17. Oktober, Julius Kühn-Archiv 449, Berlin, S. 144-149.
8. Wegener J.K., Rautmann D., Herbst A., Pelzer T., 2015: Application of the Zürich-methodology for risk assessment concerning the inspection of pesticide application equipment in use according to article 8 (3) of Directive 2009/128/EC at the example of Germany. Journal für Kulturpflanzen 67(10), S. 342-346.

An approach to fulfill art 8 of directive 2009/128: procedure of risk assessment for pesticide application equipment

M. Stas¹, G. Defays¹, D. Nuyttens², O. Mostade¹, J. Declercq², I. Zwervaegher², D. Dekeyser², B. Huyghebaert¹

¹Walloon Agricultural Research Center (CRA-W), Agricultural Machines and Facilities Unit. Chée de Namur, 146. 5030 Gembloux-Belgium

²The Institute for Agricultural and Fisheries Research (ILVO), Technology and Food Science Unit – Agricultural Engineering. Burgemeester Van Gansberghelaan, 115. 9820 Merelbeke-Belgium

Summary

The EU Directive 2009/128/EC on the sustainable use of pesticides requires that Member States (MS) shall ensure that all Pesticide Application Equipment (PAE) in professional use shall be subject to inspection at regular intervals. Article 8.3 of the Directive allows the MS to derogate from the mandatory inspection at regular intervals or to apply different timetables and inspection intervals for certain types of PAE based on a Risk Assessment (RA) for human health, food safety and environment and an assessment of the scale of use. In order to fulfill Article 8.3, a risk assessment protocol was developed in Belgium within the framework of the SIRA-APESTICON project. Risk is now evaluated for the human health and the environment on all Belgian equipment. It will offer guidelines about the necessity to carry out an inspection of every PAE in use. The protocol is based on technical parameters subject to inspections, their occurrences and severities, but also on national scale of use of the PAE types. Results are expressed at different scale levels: the defect, the machine and the country.

Keywords: pesticide application equipment, inspection, risk assessment, guidelines, exemption.

Introduction

The EU Directive 2009/128/EC on the sustainable use of pesticides requires that Member States (MS) shall ensure that all Pesticide Application Equipment (PAE) in professional use shall be subject to inspection at regular intervals (Article 8.1 and 8.2). The inspection of the material requested by the Directive concerns all types of PAE for all types of pesticides formulations (liquid, solid, gas, etc.) without any distinction. However, Article 8.3 of the Directive allows the Member States to derogate from the mandatory inspection at regular intervals or to apply different timetables and inspection intervals for certain types of PAE based on a Risk Assessment (RA) for human health and environment and an assessment of Scale of Use. The RA process should demonstrate the usefulness of the inspection to significantly decrease the risk of the use of the PAE. The SPISE Technical Working Group 2 (Spise TWG 2) developed a first protocol based on the Zurich method (Wegener, 2015). For the moment no standardized protocol of Risk Assessment is available in what concerns the risk decrease after PAE technical inspection for PAE types potentially concerned by the derogation. The Belgian method from the SIRA-APESTICON project defines the risk by a combination of two factors: 1. the severities of harm on exposed subjects and 2. the occurrences of hazard. In the context of this work, harm is the consequence of technical defects: over-dosage, under-dosage, or injuries induced by the use of PAE during the pesticide applications. Occurrences of defects are defined by PAE technical inspection. Risk is calculated for the health of the operator, the health of the consumer and for the environment. This paper shows an overview of the results for Belgium.

Materials and methods

A RA protocol was developed on basis of literature review and expert opinions. According to literature, risk is the result of the combination of occurrence and severity of harm: In this case, occurrence is

relative to PAE technical defect. They were extracted from the data of the Belgian inspection services. Harms result of the hazard and of the way of exposure. It can be over- or under-dosages or injuries induced by the use of PAE. Values of severities of harm were defined based on an international enquiry submitted in particular to European experts from the SPISE community.

Risk is calculated using two ways to combine the severity of harm and the occurrence: “Defects only” or “Defects + residual risk”. Formulations are given in Table 1. The “residual risk” is the risk induced by potential undetectable (at the inspection) small deficiencies combined with the risk inherent to the use of PAE even without any defect. Three different scales are considered: 1. the defect individually, 2. the entire machine (sum of defect’s risks) and 3. the country or for all machines of a given PAE type on the national territory (factor of scale of use) (Figure 13). These scales of use were based on a combination of the frequencies of use of the different PAE types and the weight (Kg) of pesticide potentially applied. Sales of active substances in Belgium (Kg) were selected from the Eurostat database. An estimation of the human part of risk (behaviour of the operator) can be added to the technical risk to obtain a total risk of pesticide application (Figure 13). Therefore, the partition between the technical part and the human behaviour part of risk was determined by a European enquiry. Each risk calculation is performed “before” and “after inspection”. In one hand, “Before inspection” illustrates the presence of a defect, above tolerance level of inspection and without defect correction. In another hand, “After inspection” illustrates a defect repaired regarding the inspection tolerance level or an absence of defect. Results allow evaluating the potential risk reduction induced by the inspection.

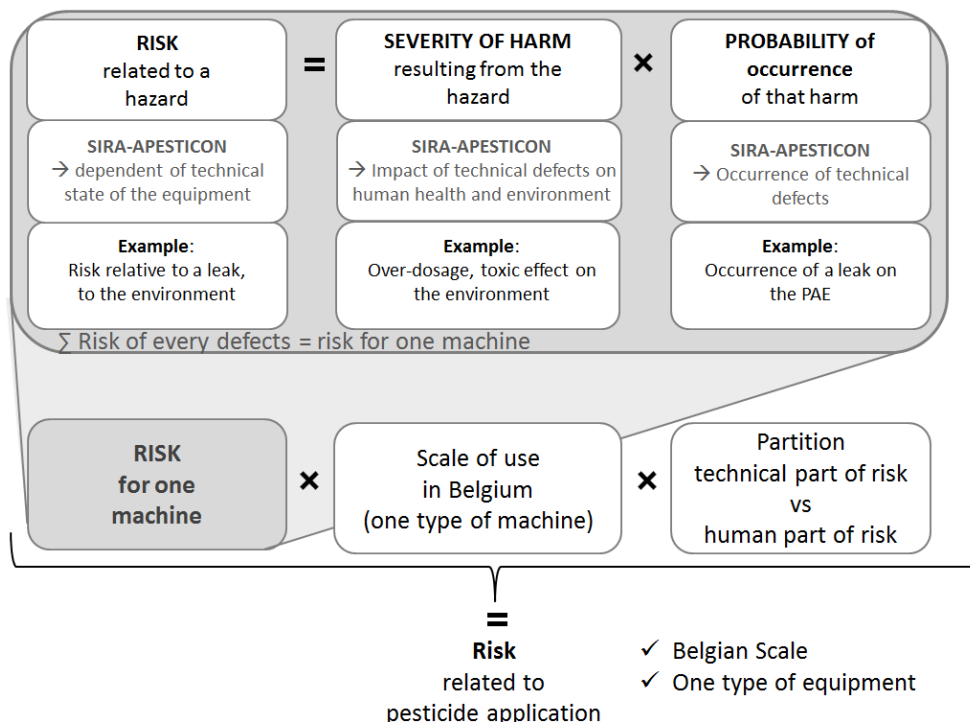

Figure 13 : Scheme of risk calculation in the framework of SIRA-APESTICON project

Table 1: Calculations used to apply the RA in Belgium. Two methods: Defects only and Defects+residual risk. Scales: defect, machine, Belgium, Belgium+human part. Two situations: before technical inspection and after technical inspection

Method / scale	Before technical inspection	After technical inspection
"Defects only" / scale of the defect	$occurrence * severity_{before}$ $= Risk_{defect.before}$	$occurrence * severity_{after}$ $= Risk_{defect.after}$
"Defects only" / scale of the machine	$\sum Risk_{defect.before}$ $= Risk_{machine.before}$	$\sum Risk_{defect.after}$ $= Risk_{machine.after}$
"Defects + residual risk" / scale of Belgium	$(\sum Risk_{defect+resi.before}) * scale_of_use$ $= Risk_{Belgium.before}$	$(\sum Risk_{defect+resi.after}) * scale_of_use$ $= Risk_{Belgium.after}$
"Defects + residual risk" / scale of Belgium, + human part	$(Risk_{defect+resi.before}) * scale_of_use * partition_human_vs_technical_part$ $= Risk_{Belgium+human.before}$	$(Risk_{defect+resi.after}) * scale_of_use * partition_human_vs_technical_part$ $= Risk_{Belgium+human.after}$

Results and discussions

Defects without residual risk, scale of the defect

Risk values are very useful to elaborate new inspection protocols at the scale of the defect. Defined before and after inspection, they inform about the risk reduction of every individual parameter by the way of inspection. Differences in risk values are observed between defects (then between parameters). That means that some defects give harms more severe than others and/or that some defects occur more often than other. For a given defect, the risk varies from a PAE type to another with the variation of occurrences between PAE types. The defects for which the risk before inspection is close to zero could be exempted from inspection. The defects that present the biggest risks should be inspected. The decision about inspection of a defect can also be influenced by the risk reduction induced by inspection. For example, the risk reductions induced by the replacement of an absent tank filling strainer are among the most important (-67% for the operator).

Defects without residual risk, scale of the machine

The method at the scale of the machine offers results illustrating direct effects of inspection. First, analysis at the machine's scale could be useful to evaluate the risk for the operator who is exposed to only one machine at a time. An illustration is given for knapsack sprayers in Figure 14. It can be observed that of risk values vary between subjects at risk. Relative risk reduction are calculated on the risk "after inspection" as a percentage of the risk value "before inspection". The type of defects listed influences the final risk value. When this RA method is applied to the case of Belgium, a clear effect of inspection is observed: risk reduction is about 63% (Figure 14).

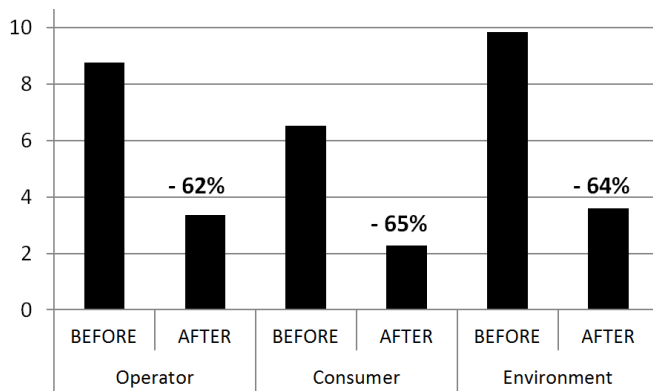

Figure 14: Results of risk calculation in absolute values for Knapsack sprayers. Risks for the operator, for the consumer and for the environment. Scale of the machine, method “defects only”. BEFORE=before inspection; AFTER=after inspection. Risk reduction between BEFORE and AFTER are indicated in percentage.

Defects with residual risk, scale of Belgium

The analysis at Belgian scale has the advantage of obtaining a global view on the total technical risk for one PAE type or to compare different PAE types (Figure 3). The differences of results (risk values) between PAE types are mainly due to the scales of use. Indeed, they are specific to each PAE type. In Belgium the field crop sprayers have the biggest scale of use with 78% of the total (all types of sprayers combined) scale of use. The orchard and knapsack sprayers have scales of use corresponding respectively to 5% and 7% of the total. Percentages of risk reductions with the method (“Defect with residual risk”) are smaller (~10%) than with the method “Defects without residual risk” (~65%). This is explained by the fact that “residual risks” is equally distributed between “before” and “after inspection” and take a big part in the total risk. Absolute values of risk are above 10.000 (results of calculation haven’t standard unit). National scale is interesting concerning the risk for the consumer and the risk for the environment because they are targeted by pollution related to broad crop surfaces.

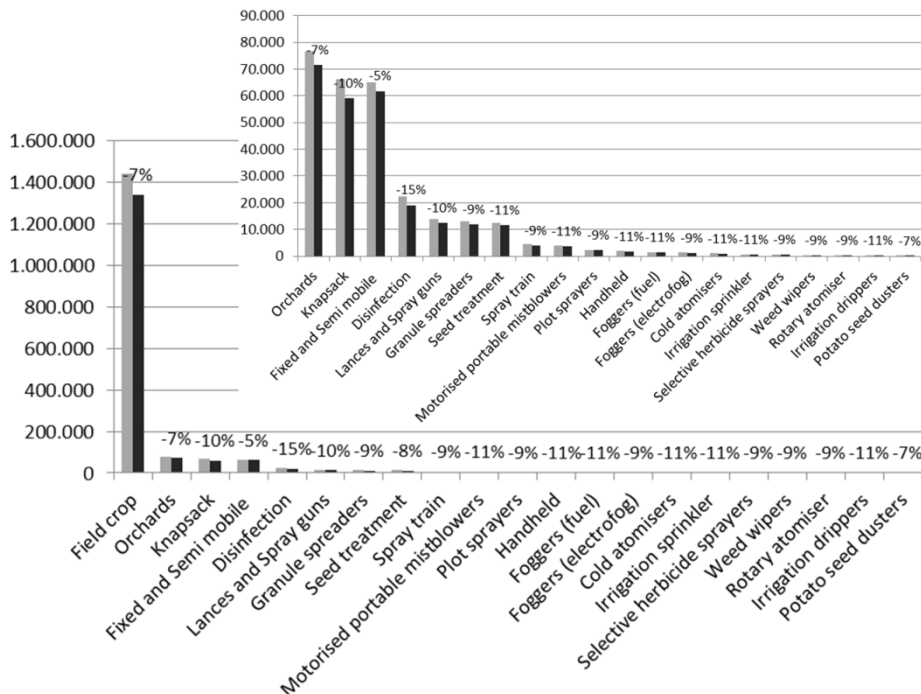

Figure 3: Risks calculated by the method “Defects only+residual risk” at the scale of Belgium for different PAE types (technical risk). Risk values are average of risk for the operator, risk of the consumer and risk for the environment. Grey: risk values before technical inspection; Black: risk values after technical inspection; Values in percentage: risk reductions between the risk before and risk after technical inspection

Defects with residual risk, scale of Belgium plus the human part of risk

This last method of risk calculation can be used to compare pesticide application of the different PAE types. That is the most complete, including defects and residual technical risks, scale of use and human behaviour part of risk. As previously, differences in risk values between PAE types are mainly due to the scale of use. However, risks related to pesticide application are, for some PAE types as knapsack sprayers, more dependent of user’s behaviour. For other PAE types, as spray train or irrigating systems, the technical part of risk is more dominating. The percentage of risk reduction is very low (5%) because the residual risk and the human part of risk are added equally to the risks value before and after inspection. The partition between human and technical part of risk could justify the inspection in order to significantly reduce the total risk.

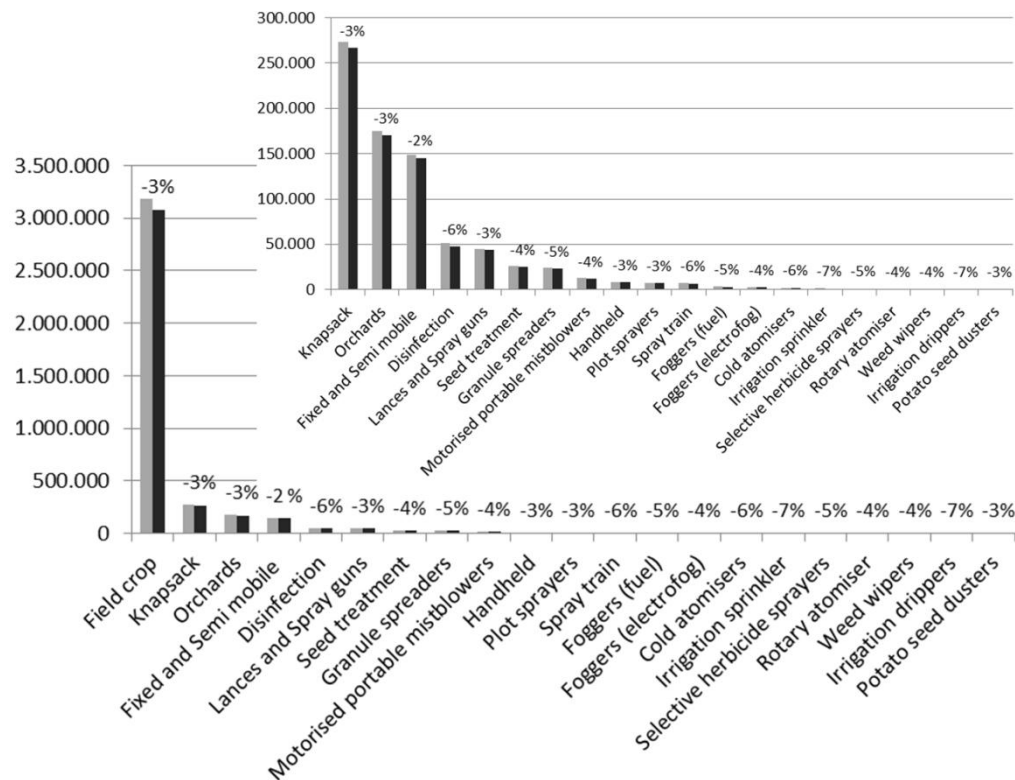

Figure 4: Risks calculated by the method “Defects only+residual risk” at the scale of Belgium for different PAE types and added to the human part of risk (technical risk + human risk). Risk values are average of risk for the operator, risk of the consumer and risk for the environment. Grey: risk values before technical inspection; Black: risk values after technical inspection; Values in percentage: risk reductions between the risk before and risk after technical inspection

Conclusion

The risk assessment method developed in Belgium is successfully applied on the case of Belgium. It illustrates the effects of inspection of each PAE type and the variation of scales of uses between all of them. Risk reductions give indication on efficiencies of inspection for all PAE types. It distinguished different targets (operator, consumer, and environment) and the results can be obtained at different scales of calculation (the technical defect, the machine or the scale of the country). Risk reductions expressed in percentage are similar trough all PAE types but absolute values of reduction are proportional to absolute value of risks that vary between PAE types. These last are mainly due to the complexity of the PAE and its inspection protocol when analysis is made at the scale of the machine. On the other hand, differences between absolute values are mainly due to scale of use when analysis is made at the scale of Belgium. Risk values and risk reduction values at every step of the risk assessment are strong theoretical basis to support decision making. For example, for the method “Defects without residual risk, scale of the machine”, a maximum level of risk could be defined for the operator safety

and another maximum level of risk can be defined for exclusion of inspection. Regarding risk results, PAE types already inspected in Belgium are those for that inspections are the most useful (field crop, orchard, fixed and semi mobile, disinfection equipment). Inspections of the others have to be discussed with the results of this work as a support.

References

Directive (CE) n° 2009/128 of the European parliament of the council of 21 October 2009 establishing a framework for Community action to achieve the sustainable use of pesticides, O.J.E.U., L.309/71, November, 24 2009.

European Commission. Eurostat - Your key to European statistics. [Online] [Cited: March 21, 2017.] <http://ec.europa.eu/eurostat/data/database>.

Ganzelmeier, H. (2012). Risk assessment for human health and the environment. Fourth European Workshop on Standardised Procedure for the inspection of sprayer – Lana (South Tyrol): SPISE Working Group. SPISE 4, 94-100.

IPCS. (2010). WHO Human Health Risk Assessment Toolkit: Chemical Hazards. Ottawa, Canada: World Health Organization.

ISO 12100 (2010) Safety of machinery – General principles for design – Risk assessment and risk reduction, © ISO 2010 – 78 p.

Marot, J. R. (2008). Contribution à l'actualisation des indicateurs de l'état de l'environnement wallon relatifs à l'utilisation des produits pharmaceutiques. UCL, Unité de phytopathologie, Louvain-la-Neuve, Belgique.

Stas, M., Nuyttens, D., Zwervaegeher, I., Defays, G., Declercq, J., Mostade, O., Dekeyser, D., Huyghebaert, B., 2016. Development of a risk assessment procedure for pesticide application equipment within the framework of article 8 of the EU Directive 2009/128 and development of specific inspection procedures. APESTICON final report, 'FOD Volksgezondheid, veiligheid van de voedselketen en leefmilieu' (RT 14/8 Apesticon 1), December 2016.

Vergucht, S. C. (2006). "Belgian Pesticide Risk and Use Indicators Methodology" Synthèse. Gand, Belgium: UGent.

Wegener, J. (2013). Application of the Zurich methodology for risk assessment according to article 8(3) of sustainable use directive (inspection of equipment in use) at example of German. 5th european workshop on standardised procedure for the inspection of sprayers in Europe-SPISE 5. Braunschweig, Germany.

Session 3: Harmonized test methods for PAE not included in ISO EN 16122 series

The SPISE Advice: Main goal and the activities done by SPISE TWGs

Paolo Balsari

DiSAFA, University of Turin, Largo Braccini 1 -Grugliasco (TO) Italy

Introduction

During the 4th SPISE workshop held in Lana (Italy) in 2012 it was again underlined the gap of harmonized standards necessary to fulfill the requirements of the art 8 of the SUD Directive and allow Member States to inspect the functionality of all type of Pesticide Application Equipment (PAE) in an appropriate and harmonized way. In order to try to solve that gap was decided to establish inside the SPISE community several Technical Working Groups (SPISE TWGs) with the goal to produce specific SPISE Advice on those topic and was ask for voluntaries to work inside of these SPISE TWGs. The SPISE TWGs established at that time were seven with the aim to develop SPISE Advices on those items_ related to the inspection of the PAE - considered of main importance for their diffuse presence in EU or for their environmental impact - not yet covered by the harmonized standards (ISO 16122 series) or for which were a need of clarification to improve the necessary harmonization of this activity. SPISE advices describe a procedure which *is not mandatory but can be voluntarily adopted* in the PAE functional inspection activities made by the national authorized workshops.

After several SPISE TWGs meetings (in total have made from 2013 till now eleven TWGs meetings hosted by different Institutions working on that Topic in EU- fig.1) SPISE community has decided to increase the number of TWGs to sixteen in order to cover all the main PAE in use in EU (tab 1).

From 2013 - 11 SPISE TWGs meetings have been held

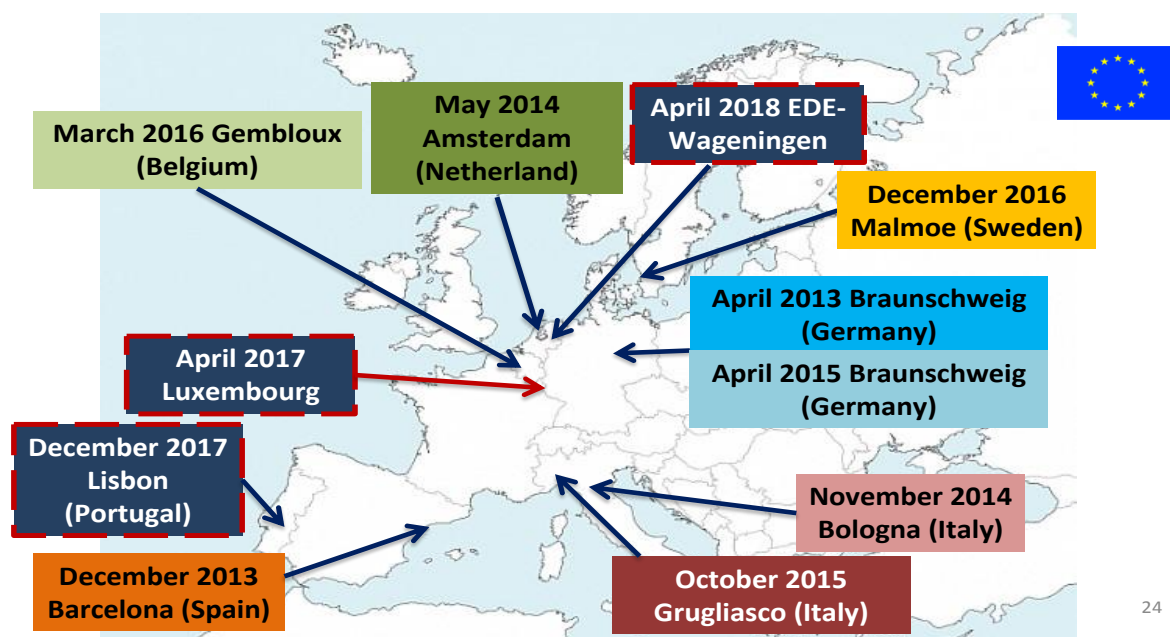

Figure 1 – The SPISE Technical Working Group (TWGs) meetings held from 2013 till now

- **TWG 1: *What to be considered when you buy a sprayer*** (Chairmen: E. Gil ; C. Schulze – Stentrop)
- **TWG 2: *Definition of a common risk assessment procedure for PAE to be exempted from the inspection*** (Chairmen: B. Huyghebaert, N. Bjugstad, J. Wegener)
- **TWG 3: *Practical implementation of sprayer inspection*** (Chairmen: J.P. Douzals; V. Polvéche)
- **TWG 4: *Quality assurance for workshop activities*** (Chairmen: J. Kole; P. Harasta)
- **TWG 5: *Training material*** (Chairmen: E. Nilsson; H. Kramer; H. Wehmann)
- **TWG 6: *Sprayer adjustment*** (Chairmen: P. Balsari; J. Lagenakens; A. Herbst)
- **TWG 7: *Train Application – State of the art and parameters to be inspected*** (Chairmen: J. Kole; P.Balsari; H. Kramer)
- **TWG 8: *Dusters - State of the art and parameters to be inspected*** (Chairmen:P.Balsari; E. Gil)
- **TWG 9: *Microgranulators - State of the art and parameters to be inspected*** (Chairmen: T. Bals; J. Kole)
- **TWG 10: *Soil fumigation equipment - State of the art and parameters to be inspected*** (Chairmen: B. Huyghebaert; J. Kole)
- **TWG 11: *Foggers and LVM*** (Chairmen: T. Bals; J. Kole)
- **TWG 12: *PAE for post harvest treatment*** (Chairmen: E. Nilsson; J. Kole; P. Balsari; B. Huyghebaert; E. Gil; F. Solanelles)
- **TWG 13: *Seed Treatment Equipment*** Chairmen: E. Nilsson; H.-J. Osteroth)
- **TWG 14: *Wiper applicators*** (Chairmen: P. Balsari; E. Gil)
- **TWG 15: *PAE “with compressor tanks” for experimental plot application*** (Chairmen: J. Kole; E. Nilsson)
- **TWG 16: *PAE with CDA atomizer*** (Chairmen: (J. Kole; T. Bals)

25

Table 1- The sixteen technical working groups established inside the SPISE community in order to produce SPISE Advices for those PAE not yet covered by harmonized standards or for which were a need of clarification to improve the necessary harmonization of the PAE inspection activity. (In red the TWGs that has been dismantled because of the Advice already produced)

The activities done

Prior to the coming into force of the SUD Directive the TWGs activities has been mainly concentrated on the PAE Adjustment made at the workshop as an important, also if not mandatory, activity to be done in addition to the functional inspection ones in order to guarantee a more efficient and environmental respecting pesticide application. Thanks to the more than valuable and voluntary activities made by the SPISE TWGs Chairmen and the great support of a group of voluntaries of the SPISE community, already in May 2015 the first SPISE Advice about *how to make the field crop sprayers’ adjustment at the workshop* was produced. After that additional three SPISE Advice has been produced (fig.2): *Advice for bush and tree crops sprayer adjustment*, *Advice for functional inspection of special spraying trains and other vehicles for chemical weed control on railways and public road*, *Advice for inspector’s training*, that have been presented also at SPISE 6th Workshop in Barcelona (2016).

Always following the SUD Directive requirements and the need of MS to have indication about the criteria to be mentioned/used in their National Action Plan for the exemption of same PAE from the mandatory periodical functional control, the SPISE TWG 2 have recently end to realize the Advice on “*Common risk assessment procedure for PAE to be exempted from the inspections*” that will be published by the end of this year and presented during this SPISE 7th Workshop.

Also following the suggestion of the EU Commission DG Sante F the SPISE WG in March 2017 has send a letter to CEN TC 144 General Director underling the necessity to have additional standards in the EN 16122 series concerning further “minor” PAE . In this letter were also mentioned the following priority in terms of PAE necessary to have indication about how to make their functional inspection: Dusters; Micro granulators; Soil fumigation equipment; Foggers and LVA equipment; PAE for seed treatment

and post-harvest treatments; Wiper applicators; PAE with rotary atomizers; PAE for experimental plot application.

All the advice concerning the functional inspection of these types of PAE will be presented by the related TWGs Chairmen during this SPISE 7th Workshop.

Some of them are already in a final version and will be soon published and freely downloaded, as for all the published Advice, from the JKI website:

<http://spise.julius-kuehn.de/>

It is expected that all the activities in charge of the present established SPISE TWGs will be finalized by the end of 2020.



28

Fig.2 : The SPISE Advices already produced

Conclusion

Four SPISE Advices have been already prepared by the voluntary and more than plausible activities done by the SPISE TWGs, two will be available by the end of 2018 and several more between 2019 and 2020. All the SPISE Advice can be freely downloaded at website: <http://spise.julius-kuehn.de/>

SPISE WG has asked the Commission DG Santé F for supporting the translation of the SPISE Advice in MS language by the SUD Working Group Members.

The SPISE Community hopes that thanks to use of these Advices, MS workshops will be able to fulfil the SUD art 8 requirements in a more harmonized way as long as EN harmonized standards will be not available. In that sense during the CEN TC144 meeting of 27-28 November 2017 where the content of SPISE letter addressed to CEN were examined after a SPISE WG presentation, CEN/TC 144 at unanimity has taken the following resolution (n°637/2017): *CEN/TC144 thanks SPISE for their initiative and invites Members bodies to provide NWI proposal to CEN TC144 in line with the priority presented during the meeting.*

Following the content of this resolution two New Working Item (NWI) proposals will be soon presented: one related to the functional requirements for brand new dusters the second one related to the new micro granulators. As soon this NWI will be accepted an additional NWI proposal will be made concerning the methods and requirements for the functional inspections of this type of PAE in use in EU. In both cases the SPISE Advices already defined for these two types of PAE will be used as base for the development of these new EN Standards.

References

<http://spise.julius-kuehn.de/>

EN ISO 16122-1 (2015) - Agricultural and forestry machinery - Inspection of sprayers in use - Part 1: General

Directive 2009/128/EC of the European Parliament and of the Council of 21 October 2009 establishing a framework for Community action to achieve the sustainable use of pesticides. <http://eur-lex.europa.eu/eli/dir/2009/128/2009-11-25>

The importance of a harmonized sprayers inspection: The SPISE manual

JP Douzals¹, V Polveche² and Z. Czaczyk³

¹Irstea, Montpellier, France

²GIPPULVES, Montpellier, France

³Poznan University, Poland

Introduction

Since the publication of EN ISO 16122 part 1 to 4 series in 2015, the framework for the inspection of sprayers is getting harmonized among EU member states. The standard series specifies mandatory requirements in terms of pre inspection (EN ISO 16122-1) and all the inspected items and functionalities of the sprayers (EN ISO 16122-2, 16122-3, 16122-4). The aim of this SPISE manual is to explain the reason for the requirements, to highlight some practical situations and to identify major defaults that can sometimes be observed. The SPISE Advice does not substitute existing standards but completes the EN ISO 16122 series standards in a practical way.

1. Principle of the SPISE Advice

First a brief description of the content of EN ISO 16122 standard series (mainly Part 2 for boom sprayers) is proposed and focuses on:

- (i) elementary components/parts to be inspected,
- (ii) function tests in order to inspect a circuit based on a group of components and ad hoc methodologies
- (iii) checking of the accuracy of measuring device of parameters involved in the determination and the verification of the application rate (gauges pressure, flowrate, forward speed, ...).

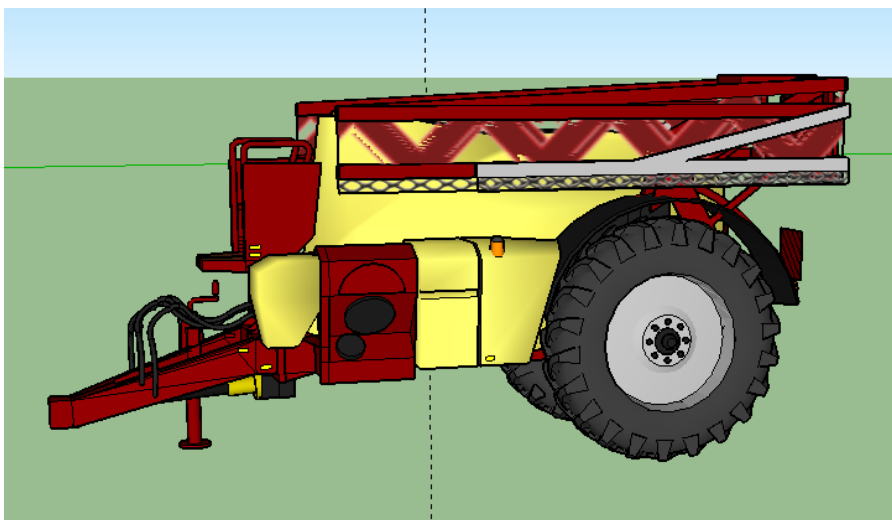

Figure 1: Schematic design of a trailed boom sprayer. Source Sketchup 3D Warehouse – Verkley design and modeling.

Second the SPISE Advice describes the different types of sprayers circuits and how to conduct a proper inspection in practice considering those circuits.

2. Structure and functioning of boom sprayers: what to know for a proper inspection

A boom sprayer is a typical machine used for broadcast spraying on row crops. Its structure is composed of:

- A framework (chassis) supporting all components (tank, pump,..) and moving parts (unfolded/folded and height adjusted booms). In many cases, the transmission allows the physical connection of the pump(s) and fans with the power supply through a PTO shaft.
- A spray mix circuit composed of tank(s), filters, pump(s), pressure valve, hoses and pipes, boom section valves, allowing the management of the spray mix from the main tank to the nozzle through boom sections and nozzle holders. Depending on the technology, the circuit may be more or less sophisticated with none up to 2 flow meters, the presence/absence of compensated returns, etc. Two main parameters are used to manage spray mix circuits: pressure and flow rate with the help of gauges or electronic sensors.
- The functioning of the boom sprayer is getting more complex with additional sensors for forward speed, boom height, GPS, etc. In general, the sprayer owns a control display used to activate/deactivate the sprayer and/or boom sections, set the pressure and read the information of the applied rate, flow rate, ...

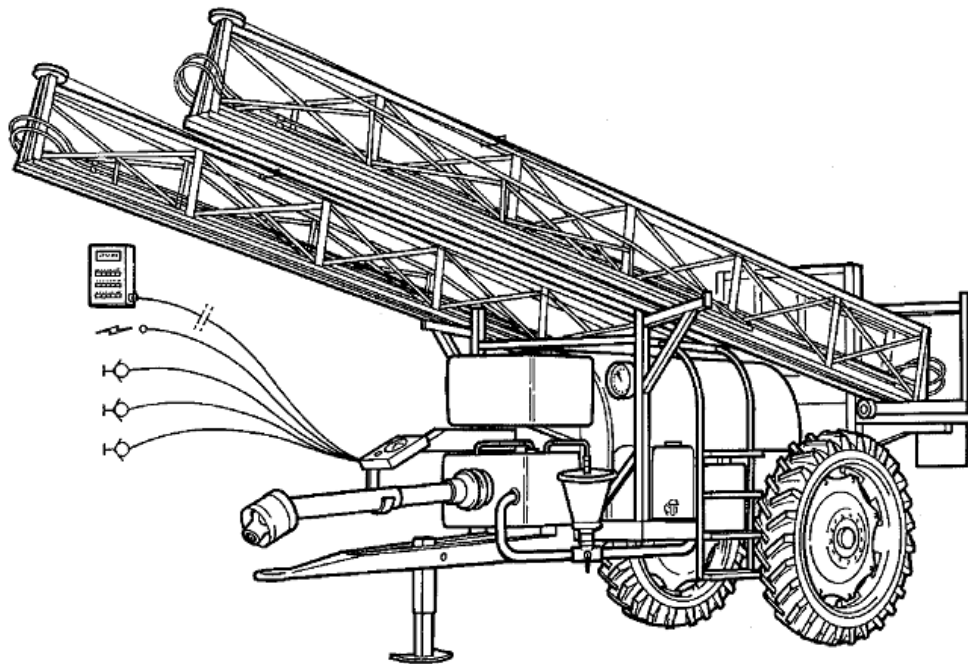

Fig 2 : Design of a trailed boom sprayer. Source: Cemagref.

Critical aspects of the inspection of a boom sprayer

Identification and classification of the sprayer

Boom sprayers can be classified according to three descriptors

(a) spray mix circuit type :

- Regular circulation with or without compensated returns, generally with a flow meter
- Semi-continuous or continuous circulation with or without compensated returns with 1 flow meter
- Regular circulation with 2 manometers...

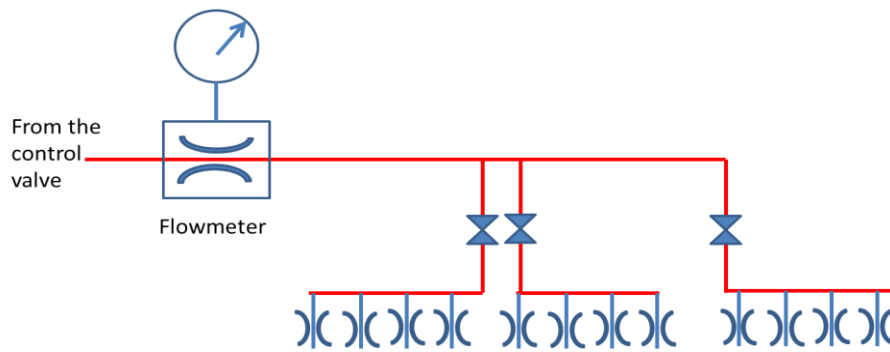

Figure 3 : Ex. boom sprayer with a regular circulation circuit – no compensated returns, 1 flow meter.
Source after GIPPulves.

(b) The type of control :

- Constant pressure with a simple 3 way pressure valve.
- Flow rate proportional to PTO revolution speed (DPM) using a pressure controller
- Flow rate proportional to forward speed (DPA) using a pilot operated control valve or a flow rate controller. In this case a mechanical or an electronic sensor provides the information of the forward speed (DPAe).

(c) The number of sections:

Hydraulic boom sections are generally different than what the mechanical structure of boom sections would suggest. For boom sprayers with regular/discontinuous circulation, the number of hydraulic sections corresponds to the number of section valves even though T connectors between subsections may be found. In this case a calibrated manometer can be mounted on each section. In the case of continuous circulation, the shut-off of the boom section is not achieved with control valves but by using pneumatic membranes (similar to antidrip systems). Feeding hoses to mount calibrated manometers can be less than the number of sections.

3. The inspection of the sprayer

3.1 Location and test equipment for the inspection

Prior to the inspection itself, the inspection workshop shall verify a number of requirements concerning practical location for a correct inspection:

- Dimensions, meteorological conditions
- Health and Safety of the inspectors (PPE provision)
- waste water management (indoor/outdoor)
- Power source management (tractor, electrical PTO...)
- List of equipment - Mobile truck/van

3.2 Preliminary inspection

EN ISO 16122 part 1 provides guidelines for the safety of the inspector, some mechanical parts can cause dangerous damages like the lack of protection of a PTO Shaft and damaged or absent connectors bowls.

The framework of the sprayer shall be in good shape, with according mechanical resistance. The presence of rust on surface of the chassis is not necessarily a major default. The structure shall not be bended, broken or loose and the sprayer components shall be tightly fixed.

9 pre-inspection items are listed and illustrated in fig 4.

1. Place for inspection
2. Clean sprayer
3. PTO shaft and Power input connectors (PIC), universal joints, locking systems
4. PTO shaft guard
5. Protections of any moving/rotating part
6. Pipes, hoses for hydraulic transmission
7. Structural parts and framework (incl. hitching)
8. Locking of foldable parts
9. Blower (blades, guarding)
10. blower clutch

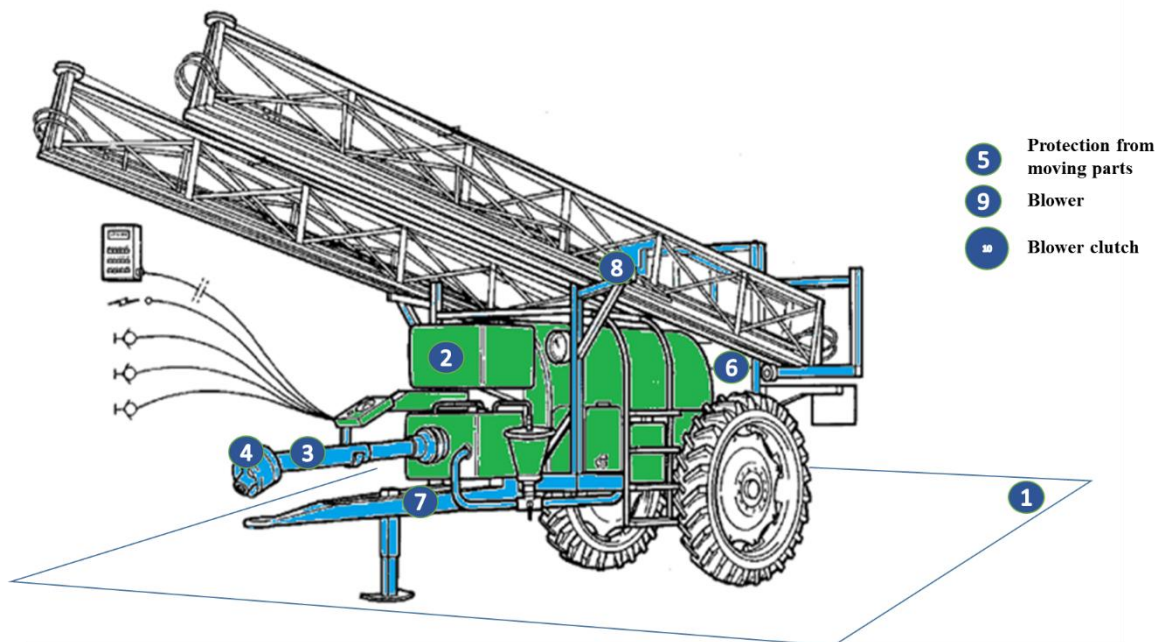

Figure 4: Sprayer shape components to be inspected during preliminary inspection. Source: Cemagref.

3.3 The inspection of sprayer

As mentioned earlier, the sprayer inspection encompasses 3 different stages: the inspection of elementary components from the structure of the sprayer to the hydraulic circuit, the verification of the correct functioning of the sprayer with ad hoc methods and finally the accuracy of all measuring devices needed to set and apply the desired application rate.

3.3.1 Elementary components to be inspected

Altogether, 25 elementary sprayer components have to be inspected regarding their presence, shape and integrity as illustrated by fig 5. Most of a time, a visual check or a simple function test may highlight the main defaults. Additional evaluation of the circuit is done during function tests. All components of the circuit that shall be dismantled (ex. suction and pressure filters) require attention from the inspector due to the risk of contamination.

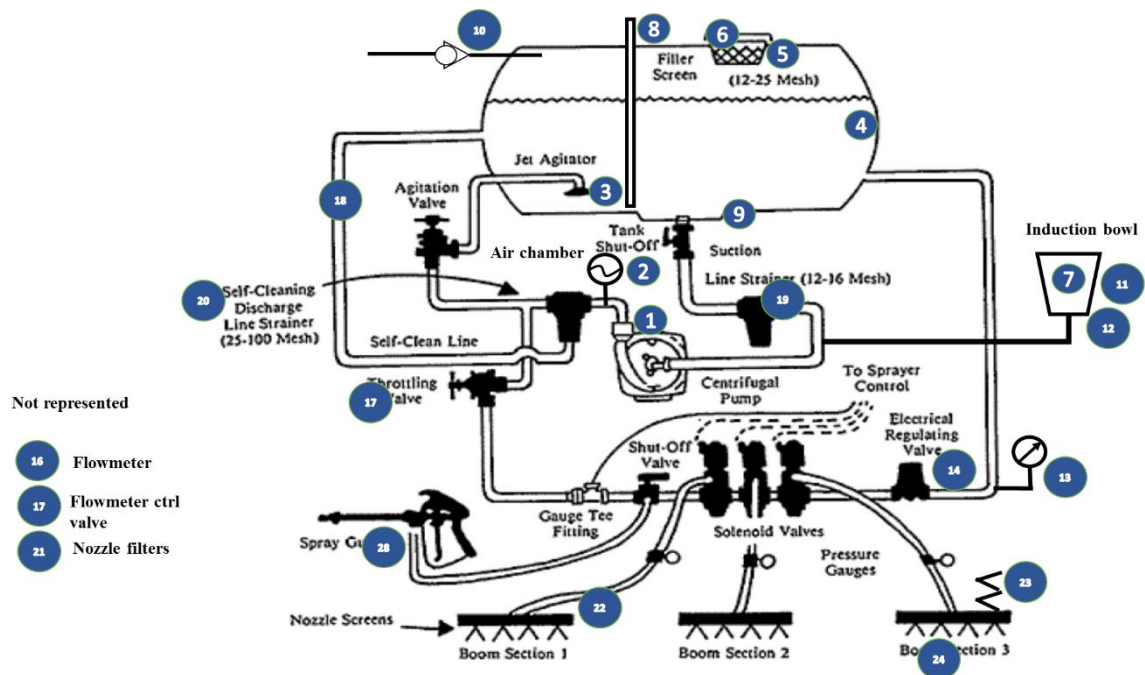

Figure 5 : Sprayer circuit components to be inspected according to EN ISO 16122-2. Circuit from Grisso et al, 1991.

The boom is one of the components that is mostly subjected to damages. Indeed the constrains on the boom are generally high during spraying due to the bouncing with horizontal and vertical forces. Most of the booms are now suspended and the suspension is also checked through a function test.



Figure 6: Boom suspension and horizontal tests. Source GIPPulves
 Along with the boom inspection, the protection of the last nozzle (fig 7) is a mandatory inspection item.

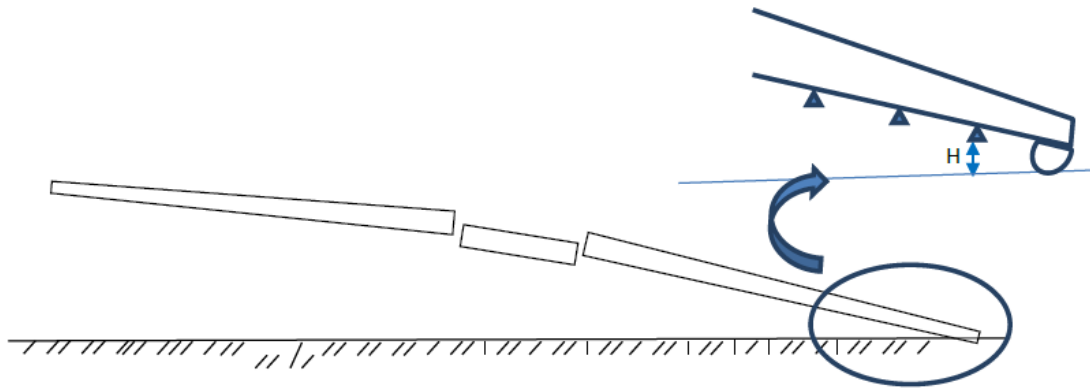

Figure 7: Practical test of the end-of-boom nozzle protection. Source GIPPulves

3.3.2 Function test to check the spray ability

16 specific function tests aim at verifying the correct functioning of the sprayer, the absence of major leaks or dripping, the quality of the agitation and the functioning of main valves (main on/off, boom sections, etc.) As each sprayer might be different from another, the presence of the user may avoid time losses trying to understand the functioning of the sprayer and the sprayer controller.



Figure 8: Boom section test, pressure homogeneity test, pressure drop test. Source GIPPulves

3.3.3 The accuracy of measuring devices to set and apply the application rate.

The main issue that needs measurement is to verify whether the chosen application rate can be set and verified. Altogether 14 methods of verification are proposed. Pressure gauge accuracy and pressure drop between the control valve and the nozzle are checked. All other sensors are also to be checked. A specific point relies on the homogeneity of the lateral distribution that can be checked either by using a distribution patternator (result method and direct verification) or by checking nozzle flow rate and pressure homogeneity along sections (analytical method and not direct verification).



Figure 9: Pressure drop during boom section shut-off/on. Source GIPPulves.



Fig 10: nozzle flowrate & nozzle homogeneity measurement (source GIPPulves)

3.4 The inspection report

Meanwhile to the inspection, an inspection test report is produced and gathers all necessary information on the owner, the inspection workshop and location, the sprayer identification and technical information including measuring results. The report is given to the owner together with a sticker placed on the machine. According to local/national regulations a copy of the test report is sent to the local/national responsible body.

Conclusion

The SPISE advice on sprayer inspection of sprayers, used together with the reference standards, may help to define a more harmonized inspection based on common knowledge, experience and practices from the different EU member countries.

References

- EN ISO 16122 – 1, 2015. Agricultural and forestry machinery -- Inspection of sprayers in use -- Part 1: General
- EN ISO 16122 – 2, 2015. Agricultural and forestry machinery -- Inspection of sprayers in use -- Part 2: Horizontal boom sprayers
- EN ISO 16122 – 3, 2015. Agricultural and forestry machinery -- Inspection of sprayers in use -- Part 3: Bush and tree crop sprayers
- EN ISO 16122 – 4, 2015 Agricultural and forestry machinery -- Inspection of sprayers in use -- Part 4: Fixed and semi-mobile sprayers
- Grisso, Robert D.; Varner, David L.; and Klein, Robert N., "G91-1020 Plumbing Systems of Agricultural Sprayers" (1991). *Historical Materials from University of Nebraska-Lincoln Extension*. 701.
<http://digitalcommons.unl.edu/extensionhist/701>

Advice for the functional inspection of the dusters

Paolo Balsari (DISAFA, Italy)

Paolo Marucco (DISAFA, Italy)

Emilio Gil (UPC, Spain)

SPISE

Standardized Procedure for the Inspection of Sprayers in Europe

ADVICE

compiled by :
SPISE Technical Working Group 8

Advice for the functional inspection of the dusters



Advice for the functional inspection of the dusters

This document has been compiled by the SPISE Technical Working Group 8.

Authors:

Paolo Balsari (DISAFA, Italy)

Paolo Marucco (DISAFA, Italy)

Emilio Gil (UPC, Spain)

Contents

1. FOREWORD	99
2. INTRODUCTION	99
3. PRE-INSPECTION	101
3.1 Cleaning	101
3.2 Power transmission parts and moving parts of the equipment	101
3.3 Structural parts and framework	101
3.4 Lockable foldable parts	101
3.5 Blower	102
3.6 Static discharge devices	103
4. INSPECTION	103
4.1 Tank	103
4.2 Filling hole	104
4.3 Tank agitation system	104
4.4 Pipes and hoses for the dust extraction and distribution (Equipment category A and B)	105
4.5 Controls and regulation systems	105
4.6 Blower	107
5 TEST METHODS	107
5.4.1 Duster with mechanical extraction	108
5.4.2 Duster with an air flow extraction	108
5.5.1 Air speed outlet (symmetry)	109
6. REFERENCES	89

Foreword

The SPISE Working Group was established in 2004 during the first SPISE workshop. There the participants welcomed the thought of Dr. Eng. Ganzelmeier (JKI) that a working group should work on further steps for the harmonization and mutual acceptance of equipment inspections. In the following years, thanks to SPISE engagement, a constant exchange of information has been made possible within the working group and consultations went on between the EC and MS on improving the sustainability of plant protection.

The founding members of the SPISE working group came from Belgium, France, Germany, Italy and the Netherlands.

In the ambit of SPISE working Group several Technical Working Groups (TWG) have been recently created with the aim to prepare **advice** about the items taken into account by the EU Directive 128/2009/EC but still not considered in the actual ISO/CEN Standards. SPISE TWG 8 in particular, has defined **advice** on what are the parts and the requirements of equipment and the criteria to use for the functional inspection of dusters.

The present document is intended to provide technical indications about the steps to follow for making the correct inspection of this equipment.

INTRODUCTION

It is estimated that about 200000 dusters are actually in use in Europe, especially in the Southern zone. As required the EU Directive 128/2009/EC, this type of machines, employed mainly for distributing dry sulfur dust in vineyards, are subject to a mandatory functional inspection as all other kinds of equipment used for pesticide distribution.

All types of dusters actually in use, are characterized by a tank where the sulfur dust is contained and by a radial fan to generate the air flow for the dust distribution. The main difference between these, is represented by the dust extraction system from the tank wherewith it is possible to divide the equipment in two different categories:

- A) provided with a tank with internal air flow;
- B) provided with a tank without air flow.

The first category includes machines featured by two type of dust extraction system (figure 1) that consist in an adjustable opening at the bottom of the tank, from which the dust can fall on the radial fan simply by gravity or by a mechanical system. The sulfur coming from the opening is conveyed towards the spouts on the two sides of the machine by the air stream of the radial fan. In the first case (fallen by gravity) the precise dosage of the dust, is difficult due to the poor precision of the control system. Also the quality of dust distribution is generally poorly uniform (Marucco and Balsari, 2004), with deposits on leaves and bunches that generally are below 50% of the amount applied. The second type of dust extraction system allow a more precise dosing of the sulfur dust and can improve the quality of dust distribution with respect to the first one.

The second category of dusters regards a more advanced type of machines (figure 2), featured by pneumatic systems to extract the powder from the tank. This category and these provided with the mechanical dust extraction system allow a more precise dosing of the sulfur dust and can improve the quality of dust distribution respect to the conventional models (Marucco and Balsari, 2004).

Actually no EN or ISO Standards concerning the requirements and methods of brand new dusters performances' verification or for the functional inspection of those in use are available. This considered,

SPISE working Group members believe it is necessary to provide a specific **SPISE Advice** on how to make the functional inspection of dusters following, when possible, the harmonized Standard EN ISO 16122 (parts 1 for general components and part 3 for dosing systems, if provided) and some of the referring documents realized and used by some Member States, where this type of equipment are already inspected (Spanish manual for the functional inspection of the sprayers in use downloading at: http://www.mapama.gob.es/es/agricultura/temas/medios-de-produccion/manualdeinspecciondeequiposdeacuerdoalanormaune-en13790_tcm7-422883.pdf).

This SPISE advice is divided in two different sections, which refer respectively to the pre-inspection and to the inspection.

The first regards all the preliminary controls made by the inspector at the beginning of the inspection and mainly consists of visual checks. The parts of this section are common to both categories of dusters previously described (A and B).

The second section regards the test methods and the procedures to realize the functional check of the equipment and the instruments necessary to carry out the measurements. For this reason, in some part of the section, the test methods described are specific referred to each of the two categories of dusters.



Fig. 1 - Example of conventional duster (category A) (Photo: DiSAFA)



Fig. 2 - Example of pneumatic duster (category B) (Photo: DiSAFA)

PRE-INSPECTION

3.1 Cleaning

The sprayer shall be clean externally and internally. Shall not be there any pesticide residues into the tank or on the external surface (figure 3) that can be a source of contamination for the inspector or the environment.

Method of verification: visual check.



Fig. 3 - Examp



3.2 Power transmission parts and moving parts of the equipment

The power take-off (PTO) drive shaft, the power input connection (PIC) and the universal joints shall be equipped with suitable and undamaged guards and protective devices, that shall work properly (figure 4).

Method of verification: visual check.



Fig. 4 - Example of t

AFA)

3.3 Structural parts and framework

Structural parts and framework of the duster shall be without permanent deformation, significant corrosion or considerable defects.

The hitching device shall be in good condition and shall work properly.

Method of verification: visual check.

3.4 Lockable foldable parts

Locking of foldable parts of the duster, if present, shall works properly and without defects.

Method of verification: visual check.

3.5 Blower

3.5.1 General

The blower (fan, casing) shall be without mechanical deformations, excessive wear and corrosion that could be able to significant vibration or malfunctions. (figure 5)

Moreover it shall be verified that:

- all blades are present and without damages;
- guarding to prevent access to the fan is present and in good conditions.

Method of verification: visual and functional check. Measurement according to 4.6.



Fig. 5 - Example of the blower and its guarding (Photo: DiSAFA; Spanish manual for the inspection of the sprayers in use)

3.5.2 Clutch

If the blower is provided with a clutch to switched off it separately from other driven parts of the sprayer, this device shall function properly (figure 6).

Method of verification: visual and functional check.



Fig. 6 - Example of the clutch to switched off the blower (Photo: Spanish manual for the inspection of the sprayers in use)

3.6 Static discharge devices

All metallic parts of the equipment that can conduct static electricity (framework, screw conveyor, blower, controls and regulation systems, cables) shall be connected with a static discharge device (figure 7).

Method of verification: visual check according to 5.1.



Fig. 7 – Example of static discharge devices (Photo: Spanish manual for the inspection of the sprayers in use)

INSPECTION

4.1 Tank

The inspection of the tank is different between the two dust extraction systems available.

- Tank without internal air flow (A- conventional duster: mechanical and gravity dust extraction) (figure 8)
- Tank with internal air flow (B- pneumatic duster: pneumatic dust extraction) (figure 9)

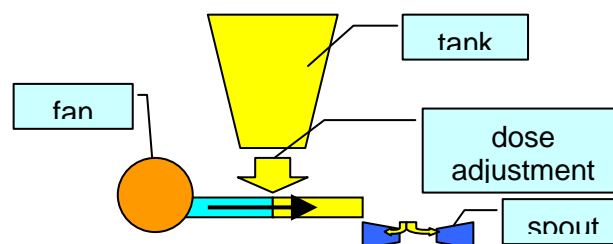

Mechanical dust extraction

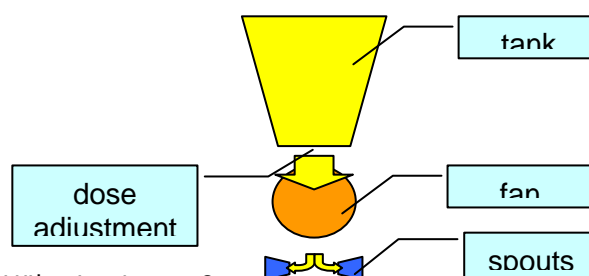

Gravity dust extraction

Fig. 8 – Scheme of the two type of tank without internal air flow (Photo DiSAFA)

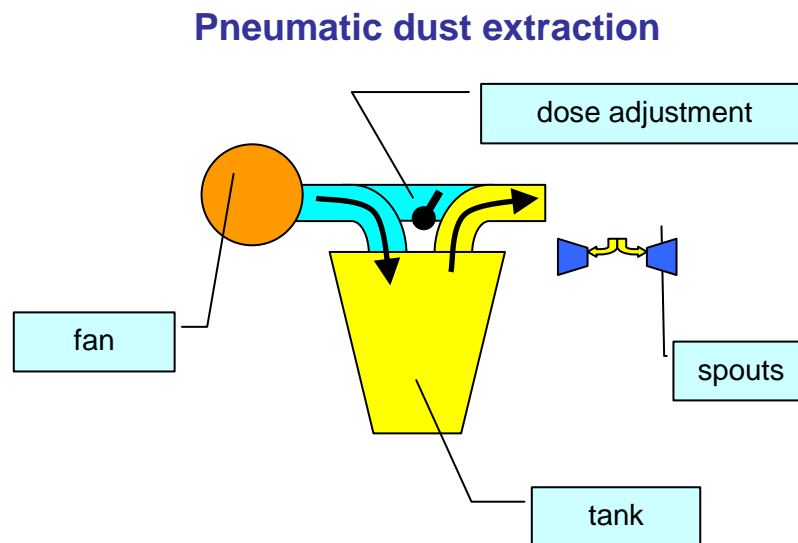

Fig. 9 – Scheme of the tank with internal air flow (Photo DiSAFA)

4.1.1 Lid (For tank category A and B)

The duster tank shall be provided with a suitable lid that shall be tightly sealed to prevent any dust dispersion and shall avoid unintended opening (figure 10).

Method of verification: visual check



Fig. 10 – Example of lid and filling hole (Photo DiSAFA)

4.2 Filling hole

The diameter of the tank filling hole should allow a safe and easy introduction of the dust in the tank.

Method of verification: visual check

4.3 Tank agitation system

4.3.1 Tank category A (tank without internal air flow)

The mechanical agitation system in the tank, if present, shall work properly (figure 11).

Method of verification: functional check. Measurement according to 5.2.1.



Fig. 11 – Example of mechanical agitation system (Photo DiSAFA)

4.3.2 Duster category B (tank with internal air flow)

The agitation system in the tank, generated by the internal air flow it shall assure a correct agitation (figure 12).

No leakages shall be present from the tank.

The lid shall be airtight (pressurized tank).

Method of verification: functional check. Measurement according to 5.2.2.



Fig. 12 – Example of agitation system generated by the internal air flow (Photo DiSAFA)

4.4 Pipes and hoses for the dust extraction and distribution (Equipment category A and B)

Shall not be present air leakages from pipes and hoses for the dust extraction.

Method of verification: functional check. Measurement according to 5.3.

4.5 Controls and regulation systems

4.5.1 System for switching on/off the dust distribution

The system for switching on or off the dust distribution shall operate properly.

The duster must be equipped with a system which allows to carry out the distribution from one side only (figure 13).

Method of verification: functional check.

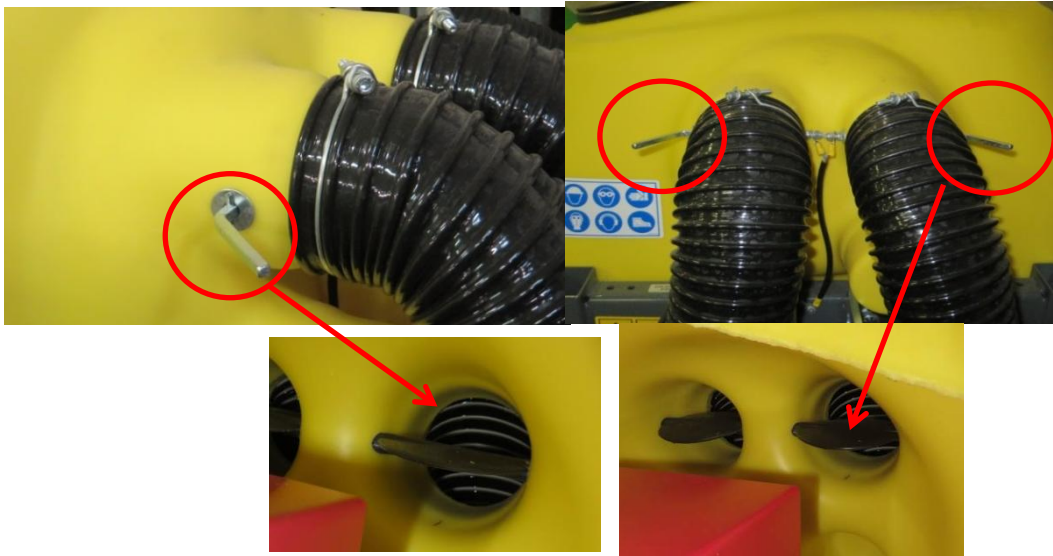

Fig. 13 – Example of system for switching on or off the dust distribution from one side only (Photo: DiSAFA)

4.5.2 Device for adjusting the dust rate

4.5.2.1 General

Device for adjusting the dust rate shall work properly.

This device shall be lockable in the intended dose rate position and shall be provided with a zero position that enables to switch off the machine without spreading any dust from the spouts (figure 14).

Method of verification: visual and functional check



Fig. 14 – Example of device for adjusting the dust rate provided with a zero position that enables to switch off the machine without spreading any dust from the spouts (Photo: DiSAFA)

4.5.2.2 Indications to select the intended rate

The device for adjusting the dust rate shall be provided with clear indications (marks) to select the intended rate and shall be operated from the operator's position during working (figure 15).

Method of verification: visual check.



Fig. 15 – Example of device for adjusting the dust rate (Photo: DiSAFA)

4.6 Blower

4.6.1 Air speed outlet symmetry

The air speed outlet shall be symmetrical on the left and right hand side

The measurement (optional) of the air speed has to be carried out at the spouts and 1.5 m away from them.

The maximum difference of the average air speed between the corresponding measurement position at the two sides shall be $\pm 20\%$.

Method of verification: Visual check. Optional functional check according to 5.5.1.

4.6.2 Fan rotational speed

The blower shall be checked verifying the absence of vibrations (due to imbalance), friction between the body and the fan or wrong orientation of the blades.

The fan rotational speed shall not differ by more than $\pm 10\%$ compared to values indicated by the manufacturer.

Method of verification: visual check. Optional functional check according to 5.5.2

TEST METHODS

Check of static discharge devices

The static discharge devices shall be checked with a visual inspection of the connection of all the metallic parts of the dusters.

Check of the agitation system

5.2.1 Tank category A (tank without internal air flow)

Verify the movement (rotation and frequency) of the mechanical agitation devices into the tank (without using dust) with the machine working at the PTO rotation speed indicated by the manufacturer.

5.2.2 Tank category B (tank with internal air flow)

Shall not be present air leakages from the tank. To check it, it is necessary to use the fan at the maximum velocity indicated by the manufacturer (without dust into the tank), measuring the leakages along the tank surface with an anemometer at a distance of 5 cm (figure 16).



Fig. 16 – Check of the tank leakages using an anemometer

(Photo: Spanish manual for the inspection of the sprayers in use)

Check of pipes and hoses for the dust extraction and distribution

The leakages have been checked with a functional/visual inspection.

Check of device for adjusting the dust rate

Duster with mechanical extraction

- If the device is equipped with an adjustable outlet, it is necessary to test that the different positions of the dosing system (maximum, minimum and average opening) corresponding with those indicated by the manufacturer.

- If the device depends on the rotation speed of the extraction system, with the rotation activated and the tank empty (without dust), it is necessary to test the velocity corresponding to each gear.

Then the gear sequence detected shall be checked with those indicated by the manufacturer.

Duster with an air flow extraction

With the tank empty (without dust), setting subsequently the maximum and minimum positions of the dosing system, and then check if these correspond to those indicated by the manufacturer.

5.5 Check of the blower (optional)

Air speed outlet (symmetry)

Measurements shall be carried out on the two sides of the machine with an anemometer.

The machine shall be positioned with the center of the spouts at a height of 0.5 m from the ground and with a PTO speed of 540 rpm.

The air velocity shall be measured in correspondence of the edge of the spouts.

The vane probe of the anemometer shall be positioned in at least 6 different positions along the spout profile and at a distance of 1.5 m from the center of the machine (considering a typical vineyard inter-row distance of 3 m) at three different heights from the ground (referred to typical vineyard canopy heights): 0.5; 1.0 and 1.5 m (figure 19).

Requirements of the instrument to be used for test (anemometer) are:

Accuracy: 0,1 m/s

Scale end value: 60 m/s

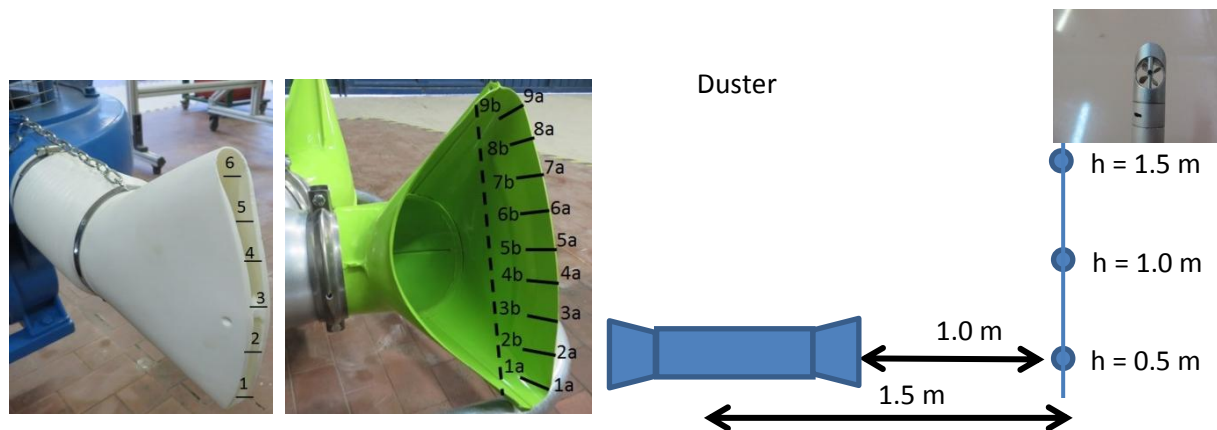

Fig. 17 – Positions of the anemometer along the spouts profile, and distance from the machine, during measures (optional) of the air speed outlet symmetry (Photo: DiSAFA tests, 2016).

Fan speed (optional)

The fan rotational speed shall be measured at the nominal working range of PTO velocity indicated by the manufacturer.

To carry out the test, using a tachymeter measuring the revolution of the fan shaft or considering the revolution of one of the fan blades (figure 18).

Requirements of the instrument to be used for test (tachymeter) are:

Accuracy: 1 rev/min

Scale end value: 5000 rev/min



Fig. 18 - Check of the fan rotational speed with the tachymeter (optional)

(Photo: Spanish manual for the inspection of the sprayers in use)

REFERENCES

EN ISO 16122-1 (2015) - Agricultural and forestry machinery - Inspection of sprayers in use - Part 1: General.

EN ISO 16122-3 (2015) - Agricultural and forestry machinery - Inspection of sprayers in use - Part 3: Sprayers for bush and tree crops.

Marucco P., Balsari P. (2004) – Tecnologie innovative per la distribuzione dello zolfo in polvere in vigneto. Atti Giornate Fitopatologiche 2004, Montesilvano (Pescara, Italia), 4-6 maggio 2004, Vol. 1, 273-278.

P. Balsari, P. Marucco, F. Matta (2016) - Assessment of the applicability of a test protocol for the inspection of dusters in use. Sixth European Workshop on Standardised Procedure for the Inspection of Sprayers in Europe (SPISE 6), Barcelona (Spain) , September 13-15 2016, – Julius –Kuhn-Archive (ISSN:1868-9892), 213-222

SPISE Advice of Periodical inspection Granulate application equipment

Ian Forman⁽¹⁾, Jaco Kole⁽²⁾

⁽¹⁾ NSTS, Samuelson House, 62 Forder Way, Peterborough PE7 8JB, UK

⁽²⁾ SKL (Foundation for Quality Control of Agricultural Equipment), Agro Business park 24, NL-6708PW Wageningen, the Netherlands

Summary

All types of machines used for the application of pesticides must be inspected because of the EU SUD directive. Also machines used for applying solid shaped pesticides. This can be machines what apply the product in bands or machines designed to distribute the product in a broadcast way. This machines are yet not covered by the present EN or ISO standards, therefore SPISE has produced a SPISE Advice about the inspection of this type of machines. This SPISE Advice covers all relevant inspection point for this type of machines.

Introduction

A granule applicator is a device to apply pesticides in a solid form, as a dry granule, pellets or micro granules. It typically consists of a hopper, a metering device and a distribution system to distribute the granules in a broadcast way or as a band application.

A granulate spreader can be configured in many different ways depending on the distribution system, on the size and quantity of hoppers, the number of outlets and the drive type. Hopper size is generally between 30 and 150 L. Working width for rotary spreaders can go up to 24 m.

Granule spreaders can be fitted in the front or rear section of a vehicle (tractor, ATV, jeep, ...) or one or more devices can be mounted on an implement.

Type A: Band applicators



Type B: Full-width applicators



Pre-inspection of the machine

For the safety of the test-operator and to protect the environment and the testing-equipment to get contaminated, the inspection of the machine shall only start when it is made clear that the machine is safe and clean. Here for the item listed in 5.3 of EN-ISO 16122:1 (2015) can be used, but special attention shall be given to the cleanliness of the machine because the products used with these machines are very dangerous, great attention shall be given to the personal protection of the test-operator.

Requirements of the inspected machine

Type A. Band applicators

Leakage

- With the machine not working and parked on a level surface, there shall be no leakage from any part of the machine.
- Working under normal working condition, there is no leakage of product from any part of the machine.

Metering unit(s)

- Check if the drive of the metering unit(s) is functioning correctly.
- Check if the electronic signal and GPS sensors and radar sensors (if present) are functioning correctly
- Check if the drive idlers-engagement (on/off) functions correctly (if fitted)
- The drive shaft is in correct alignment and rotated easily without binding.
- All rotors are made of a material suitable and recommended for the product being applied.
- The rotors are not damaged or dirty, any damaged rotor should be changed.
- All rotors and cassettes are fitted according to manufacturer's guidelines.
- All rotors are within manufacturer's specifications.

Hopper(s)

- The hopper(s) shall be free from any defects like holes, cracks, etc.
- All hopper(s) are fitted correctly to the machine.
- The hopper(s) is/are provided with a lid that is well adapted and in good condition, This lid
- shall avoid unintended opening.
- It is possible to empty the hopper(s) without the use of special tools or removing parts from the machine, without contamination of the environment and without the risk of contamination of the operator.
- All seals must function correctly.
- The hopper(s) is/are accessible on a safe way.
- The Closed Transfer (if present) connection cap must be fitted as per manufacturer's guidelines and correctly aligned. The seal is intact and complete.
- Agitator(s) (if present):
 - The agitators shall be free from wear and damage
 - The agitator drive is operating correctly

Measuring systems, controls and regulation systems

- All on the machine present instruments and controls needed for the correct functioning, measuring and regulating the machine are functioning properly.
- The provision for the switching on or off of the applicator are functioning properly, it is possible to switch all distributors simultaneously on or off.
- All controls and instruments needed to operate the applicator during operation, are reachable and visible placed he place of the operator.

Lines (pipes and hoses) (13)

- Hoses and pipes shall not show excessive bending, corrosion and abrasion through contact with surrounding surfaces. Lines shall be free from defects such as excessive surface wear, cuts, cracks, etc. Tubes are not pinched or kinked.
- All tubes between the meter outlet and the fish-tail/deflector plate is clear of internal obstructions.
- Any repairs should not affect air-flow or allow chemical spillage.
- On air machines, pipe work must be of the same type as per manufacturer's guidelines.
- The tubes are mounted in such a way so that accumulation of product in tubes will be prevented.

Delivery system

- The distance between fish-tails and the ground/target is as per manufacturers guidelines.
- All non-flexible pipe lengths and angled bends are within manufacturers guidelines.
- Spreader plates and heights of delivery tubes should be set according to machine manufacturers guidelines.
- All fish tails or spreader plates are in good condition.
- Fish-tails are clear of any obstruction and that internal vanes are correctly set to manufacturer's guidelines.

Output/Distribution (22)

- Output (for line applicators)
- The measured output per output shall be within +/- 10% of the average output.
- *Test method:*
- The output measurements should be carried out using blank/dummy material
- Collect the output of each outlet and compare with the average output.
- The output test must be carried out over the equivalent of 100 meters or a minimum of 100 grams per outlet, relevant to the product being used.
- Read manufacturers manual and product label for calibration advice.
- For air-assisted machines, collect granules using a bucket or suitable container which allows air to escape while retaining granules.





Pneumatic systems:

- Check the bearing and fouling of the fan.
- Check the fan is running in the correct direction, the wrong direction will affect air pressure.
- The blades of the fan shall not be damaged and in good condition.
- The fan speed/pressure shall be within manufacturers guidelines.
- All pipes, hoses and joints are free from wear or leaks.
- The venturi is clear and within manufacturer's guidelines.
- The alignment and deflection angle is according to manufacturer's guidelines.
- The nozzle insert length is as stipulated by the manufacturer.
- The nozzle spacing is to manufacturers guidelines
- The nozzle height above the intended application surface is correct to manufacturers guidelines.

Type B. Full-width applicators

Leakage

- With the machine not working and parked on a level surface, there shall be no leakage from any part of the machine.
- Working under normal working condition, there is no leakage of product from any part of the machine.

Metering unit(s)

- Check if the drive of the metering unit(s) is functioning correctly.
- Check if the electronic signal and GPS sensors and radar sensors(if present) are functioning correctly
- Check if the drive ids-engagement (on/off) functions correctly (if fitted)
- Metering shaft alignment (9)
- The drive shaft is in correct alignment and rotated easily without binding.
- All rotors are made of a material suitable and recommended for the product being applied.
- The rotor are not damaged or dirty, any damaged rotor should be changed.
- All rotors and cassettes are fitted according to manufacturer's guidelines.
- All rotors are within manufacturers specifications.

Hopper(s)

- The hoppers shall be free from any defects like holes, cracks, etc.
- All hoppers are fitted correctly to the machine.
- The hopper(s) is/are provided with a lid that is well adapted and in good condition, This lid shall avoid unintended opening.
- It is possible to empty the hopper(s) without the use of special tools or removing parts from the machine, without contamination of the environment and without the risk on contamination of the operator.
- All seals must function correctly.
- The hopper(s) are accessible on a safe way.
- The Closed Transfer connection cap (if present) must be fitted as per manufacturer's guidelines and correctly aligned. The seal is intact and complete.
- Agitators:
 - The agitators shall be free from wear and damage
 - The agitator drive is operating correctly

Measuring systems, controls and regulation systems

- All on the machine present instruments and controls needed for the correct functioning, measuring and regulating the machine are functioning properly.
- The provision for the switching on or off of the applicator are functioning properly, it is possible to switch all distributors simultaneously on or off.
- All controls and instruments needed to operate the applicator during operation, are reachable and visible placed he place of the operator.

Lines (pipes and hoses)

- Hoses and pipes shall not show excessive bending, corrosion and abrasion through contact with surrounding surfaces. Lines shall be free from defects such as excessive surface wear, cuts, cracks, etc. Tubes are not pinched or kinked.
- All tubes between the meter outlet and the fish-tail/deflector plate is clear of internal obstructions.
- Any repairs should not affect air-flow or allow chemical spillage.
- On air machines, pipe work must be of the same type as per manufacturer's guidelines.
- The tubes are mounted in such a way so that accumulation of product in tubes will be prevented.

Delivery system

- The number of fish-tails should be sufficient to cover the width of application required.
- The distance between fish-tails and the ground/target is as per manufacturers guidelines.
- All non-flexible pipe lengths and angled bends are within manufacturers guidelines.
- Spreader plates and heights of delivery tubes should be set according to machine manufacturers guidelines.
- All fish tails or spreader plates are in good condition.
- fish-tails are clear of any obstruction and that internal vanes are correctly set to manufacturer's guidelines.

- The fish-tail/deflector plate spacing is according to manufacturer’s guidelines and product label recommendations.
- The fish-tail/deflector plate height is according to the manufacturer’s guidelines.
- The deflector plate gap/angle is set to the manufacturer’s guidelines.

Disc spreading applicators

- The electric motor, disc, vanes and agitators are in good condition and correctly fitted.
- All shutter mechanisms must be complete and working correctly, and apertures correctly set according to manufacturer’s instructions
- The vanes shall be free from wear and damage
- The agitators shall be free from wear and damage
- The agitator drive is operating correctly
- All drop-on guides are complete and guides and apertures are set according to manufacturer’s instructions.

Output/Distribution (22)

- Output (for full-width applicators with multiple outlets – pneumatic devices)
- The measured output per output shall be within +/- 10% of the average output.

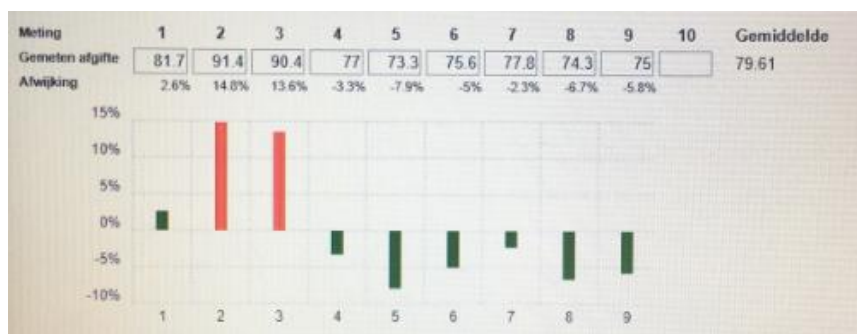

- Distribution - uniformity of spread (for full-width applicators)
 - The uniformity of pellets spread should be checked by tray testing.
- The number of pellets collected is counted and those collected from the left are compared with those collected from the right. This will confirm the distribution of pellets thrown to the left and right of centre is within the tolerance of +/-15% of the mean.
- The tray testing gives also information what the total width of spread is. The width of spread to left and right is not always the same and it gives the machine owner the knowledge of how wide the machine actually spreads which helps safeguard water courses or other non target areas.
- Diagram of test tray spacing (diagram shows layout for 24 metre spread width):

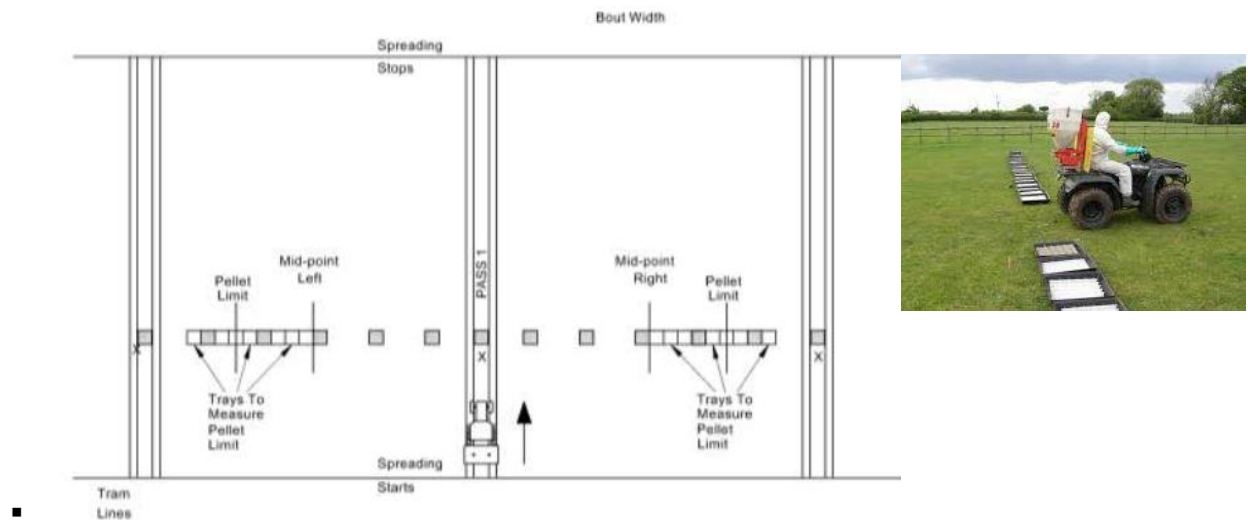

Pneumatic systems

- Check the bearing and fouling of the fan.
- Check the fan is running in the correct direction, the wrong direction will affect air pressure.
- The blades of the fan shall not be damaged and in good condition.
- The fan speed/pressure shall be within manufacturers guidelines.
- All pipes, hoses and joints are free from wear or leaks.
- The venturi is clear and within manufacturer's guidelines.
- The alignment and deflection angle is according to manufacturer's guidelines.
- The nozzle insert length is as stipulated by the manufacturer.
- The nozzle spacing is to manufacturers guidelines
- The nozzle height above the intended application surface is correct to manufacturers guidelines.

Test-equipment needed

Equipment needed for testing band-applicators

- Scale to weight 100 grams with min accuracy of +/- 2%
- Collecting trays
- Dummy material of micro granulate

Equipment required for testing pellet applicators

- Minimum number of trays – 20 (spaced as per ☐)
- Size of trays 0.5m X 0.5m X either 0.10m or 0.15m high (depth is not critical but all trays used MUST be the same size).
- Grader box (granulometer) – universal box to NSTS specification (four sections 2.00mm, 3.3mm and 4.75mm sizes)
- Hardness tester
- Litre measure
- Scales – to be calibrated annually by using a calibrated weight
- Optical and contact tachometer – to be calibrated annually by comparison with a calibrated tachometer
- Tape measure
- Dummy material of pellets

Research of an appropriate inert compound to use as an alternative to the granules of the plant protection products in the inspections of microgranulators

Marco Manzone, Davide Allochis, Paolo Balsari

Università degli di Torino – Disafa – L.go Braccini 2, Grugliasco (TO)

Summary

The goal of this experimentation was to find an appropriate inert and hydrophobic compound with physical-dimensional properties as close as possible to those of the granules of the plant protection products (particle size: 0,3-1,2 mm and density: 0,6-1,4 g/cm³) in order to allow the micro granulator periodical inspection following the incoming SPISE Advice related to this aspect. In addition, the inert should be also commercially available guarantee for a long time and not abrasive. During the test, four inert materials were analysed: corn flour, rubber granules, glass microspheres, and plastic granules.

Tests were performed in the laboratory using a specific device in order to drive the micro granulators. For each regulation, it was measured the amount of outlet every two rotations of the metering unit drive shaft, up to a maximum of 10 rotations (2, 4, 6, 8, 10). Moreover, It has been detected also the time every two rotation.

Tests have highlighted a good repeatability with all tested materials independently of the number of rotations or the rotation time of the metering unit drive shaft (CV max = 6% for corn flour, glass microspheres and plastic granules; CV max = 5% for rubber granules). In addition, a good linearity in relation with metering unit regulation, independently of the materials and the number of rotations, was pointed out. Considering that the rubber granules are hydrophobic (they are not Influenced by relative humidity of the air or by water) and show a low cost (about 2-3,00 €/kg), this material seems the more suitable inert compound , between those tested to be use in the periodical mandatory inspections of micro granulators.

Introduction

Micro-granulators are substantially composed by: one or more hoppers for containing the granules of chemical product; some metering units able to deliver a determined amount of granules. As required by the EU Directive 128/2009/EC (adopted in Italy with Dlgs n.°150 of 14/08/2012) and by the Italian National Action Plan (NAP), these type of equipment are subject to a mandatory functional inspection as for all the other type of Pesticide application equipment (PAE) with the exclusion of the knapsack sprayer . However, due to the lack of standardized test procedures to make functional inspection of these equipment, the Italian NAP establish only the interval between inspections that shall not exceeded six years, but it doesn't define the deadline for starting the mandatory inspections (DM n.4847 del 03/03/2015). Also in the others EU Members State it is still not possible to fully comply with the EU Directive 128/2009/EC requirements because of the lack of information also on how to make the inspection of this type of PAE

With the aim to try to find a solution to this situation SPISE have establish a specific technical working group (TWG 9) witch goal was to define an advice on how to inspect microgranulator and at the same time has ask CEN TC 144 to promote a specific EN standard related to this topic.

The present draft version of the SPISE Advice contain a description of the functioning, the usage and the working principle of micro-granulators, but has also a list of requirements and test methods of testing micro-granulators in use. At this regards, the goal of this experimentation was to find an appropriate inert with physical-dimensional properties as close as possible to those of the granules of the plant protection products (PPP) to be used during the inspections because of the considerable operator and environmental risks when chemical granules are used.

Materials and Methods

The present draft version of the SPISE Advice contain a description of the functioning, the usage and the working principle of micro-granulators, but has also a list of requirements and test methods of testing micro-granulators in use. At this regards, the goal of this experimentation was to find an appropriate inert with physical-dimensional properties as close as possible to those of the granules of the plant protection products (PPP) to be used during the inspections because of the considerable operator and environmental risks when chemical granules are used.

Table 1. Main physical properties of the PPP on the market and of the four inert materials used in the tests

Material	Density (g/cm ³)	Granules size (mm)
<i>Chemicals (granules) on the market (survey)</i>	0,6 - 1,4	0,3 - 1,2
Rubber granules	0,6	0,4 - 0,9
Corn flour	0,8	0,2 - 0,5
Glass microspheres	2,6	0,4 - 0,8
Plastic granules	1,1	0,6 - 0,8

For the tests was used mechanically driven micro-granulators mainly mounted by the three more important seeders manufacturers in Italy.

These three micro-granulators (X, Y e Z) are composed by: a plastic hopper with a nominal capacity between 12 and 25 l; some metering gravity units - consisting in a cylindrical small rotor with some teeth on its surface - located under the hopper.

The granules flow rate is regulated by the rotation of the rotor and by the opening present at the bottom of the hopper. During the distribution the granules are taken from the rotor and conveyed inside a PVC pipe that carries them close to the ground. In all 3 types of microgranulators tested, the adjustment of the opening width at the bottom of the hopper is guaranteed by a slide valve with a shutter connected to a special toothed ring nut keyed on a threaded shaft: screwing or unscrewing the ring nut it is possible to open or close the opening. With the flowrate regulation system of the micro granulators used in the tests it is possible to perform 5 macro adjustments (A, B, C, D and E) and for each of them 5 micro adjustments (0, 1, 2, 3, 4, 5, 6, 7, 8, and 9) (Table 2).

Table 2. Main technical features of micro granulators used in the tests

Microgranulator	Nominal capacity of the hopper	Metering unit	Activation mode	Macro-adjustments	Micro-adjustments
X	12	rotor	mechanical	5	10
Y	25	rotor	mechanical	5	10
Z	25	rotor	mechanical	5	10

For all the metering units, with the "Ao" adjustment the opening at the bottom of the hopper is in a close position.

The distribution uniformity of each micro granulator has been evaluated according to the different settings of the flow rate regulation system reported into the instruction handbook of the equipment.

For each setting (Ao, Bo, Co, Do, Eo), the quantity of output granules was measured by making several rotations of the drive shaft (2, 4, 6, 8, 10). In this way, the minimum number of rotations to be performed during a functional inspection with the micro-granulator mounted on the seeder, has been measured. To verify the results repeatability (CV) has been carried out three repetitions for each test.

For the tests, a specific experimental test device has been realized. It is consisting of: a steel frame with a fastening bracket for the micro-granulators; an electric gear motor with a chain drive system that activates the metering unit for a set time (Figure 1).

During the tests, granules were collected in a container and subsequently were weighed with a three decimal precision digital scale (accuracy: 0.005 g).

Figure 1. Experimental test device realized for the tests

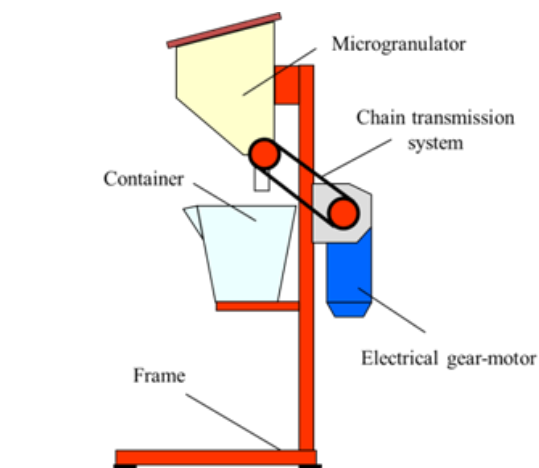

In order to check the correspondence between the quantity delivered with the different micro granulators used (X, Y and Z) with the same setting, a comparison was made between the three equipment tested using the rubber granules and making two rotations with the drive shaft of their metering units.

Data collected was analysed using IBM SPSS Statistics SSPS (Statistical Package for the Social Sciences). The tests repeatability was evaluated by the coefficient of variation (CV). Eventual differences between tests were checked by performing Tukey's multiple

Results

All types of inert used in the tests have highlighted a good repeatability of the results independently from the rotations number of the micro-granulator drive shaft and the metering unit setting. The coefficient of variation (CV) for all the tests made was always below 5%. (Tables 3, 4, 5, 6).

Only the corn flour has highlighted some problems, showing a high propensity to packing. When the amount of flour in the hopper was low, the dust get stuck to the hopper walls cause a significant reduction of the material delivered with an incorrect final dosage.

Table 3. Mean value of amount of corn flour (g) recorded according to the rotations number of the X micro-granulator drive shaft (2, 4, 6, 8 e 10 rotations) and to the setting of metering unit (Ao, Bo, Co, Do e Eo) and variability of the data value collected (CV).

Rotations	Ao		Bo		Co		Do		Eo	
	Mean	CV	Mean	CV	Mean	CV	Mean	CV	Mean	CV
2	0	0	3,642	5%	8,165	4%	13,225	5%	17,910	5%
4	0	0	7,383	6%	16,830	5%	26,550	4%	36,490	4%
6	0	0	11,052	5%	24,865	5%	40,215	5%	53,740	4%
8	0	0	14,493	5%	33,435	5%	53,485	5%	71,630	3%
10	0	0	18,223	6%	41,725	5%	66,460	5%	89,680	4%

Table 4. Mean value of the rubber granules distributed (g) according to the rotations number of the X micro-granulator drive shaft (2, 4, 6, 8 e 10 rotations) and to the setting of metering unit (Ao, Bo, Co, Do e Eo) and variability of the data value collected (CV)

Rotations	Ao		Bo		Co		Do		Eo	
	Mean	CV	Mean	CV	Mean	CV	Mean	CV	Mean	CV
2	0	0	2,088	5%	5,235	4%	7,745	2%	10,785	4%
4	0	0	4,172	4%	10,450	3%	16,065	2%	21,760	3%
6	0	0	6,433	5%	15,735	3%	24,030	3%	32,380	4%
8	0	0	8,318	2%	20,815	2%	31,945	1%	43,270	2%
10	0	0	10,192	1%	26,295	5%	39,865	1%	53,630	4%

Table 5. Mean value of the amount of plastic granules distributed (g) according to the rotations number of the X micro-granulator drive shaft (2, 4, 6, 8 e 10 rotations) and to the setting of metering unit (Ao, Bo, Co, Do e Eo) and variability of the data value collected (CV)

Rotations	Ao		Bo		Co		Do		Eo	
	Mean	CV	Mean	CV	Mean	CV	Mean	CV	Mean	CV
2	0	0	7,805	6%	12,645	5%	18,055	5%	23,650	4%
4	0	0	15,490	4%	25,450	4%	36,360	5%	47,955	3%
6	0	0	22,945	5%	36,480	4%	54,975	6%	72,300	3%
8	0	0	30,445	5%	51,040	6%	73,220	4%	96,495	2%
10	0	0	38,085	3%	63,925	3%	92,225	5%	120,400	1%

Table 6. Mean value of the amount of glass microsphere distributed (g) according to the rotations number of the X micro-granulator drive shaft (2, 4, 6, 8 e 10 rotations) and to the setting of metering unit (Ao, Bo, Co, Do e Eo) and variability of the data collected (CV).

Rotations	Ao		Bo		Co		Do		Eo	
	Mean	CV	Mean	CV	Mean	CV	Mean	CV	Mean	CV
2	0	0	20,765	5%	31,715	4%	43,370	5%	56,805	4%
4	0	0	42,085	5%	63,090	6%	87,530	5%	112,470	5%
6	0	0	63,240	5%	95,400	6%	131,800	5%	169,930	5%
8	0	0	84,745	4%	126,565	5%	176,475	6%	225,315	2%
10	0	0	105,945	5%	158,670	3%	222,135	4%	281,900	2%

The collected data also showed a good correlation between the amount of inert delivered and the different number of rotations of the drive shaft of the metering unit of the microgranulator X. In fact, for

the different adjustments the regression value obtained is close to 1 for all types of inert tested (Figures 2, 3, 4, 5).

Figure 2. Comparison between the amount of rubber granules distributed and the rotations number of the X micro-granulator drive shaft

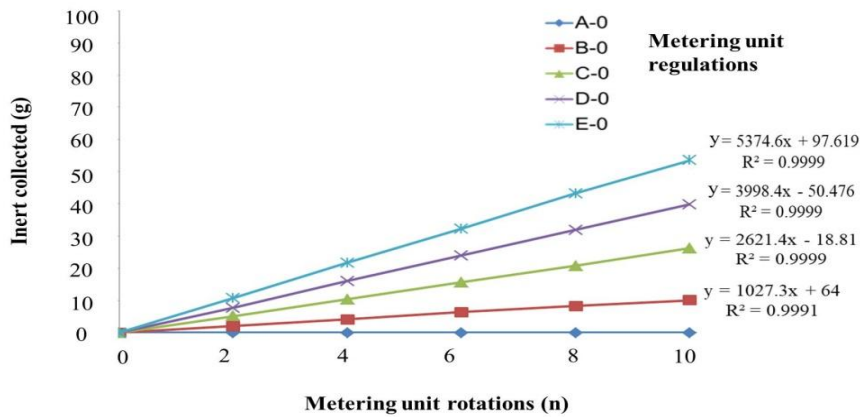

Figure 3. Comparison between the amount of corn flour distributed and the rotations number of the X micro-granulator drive shaft.

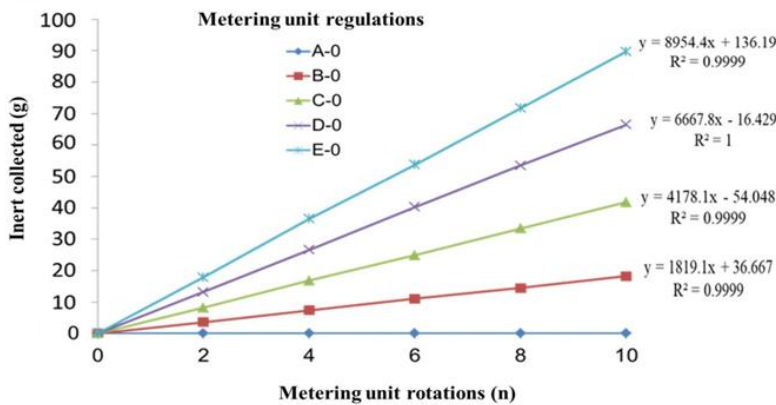

Figure 4. Comparison between the amount of plastic granules distributed and the rotations number of the X micro-granulator drive shaft.

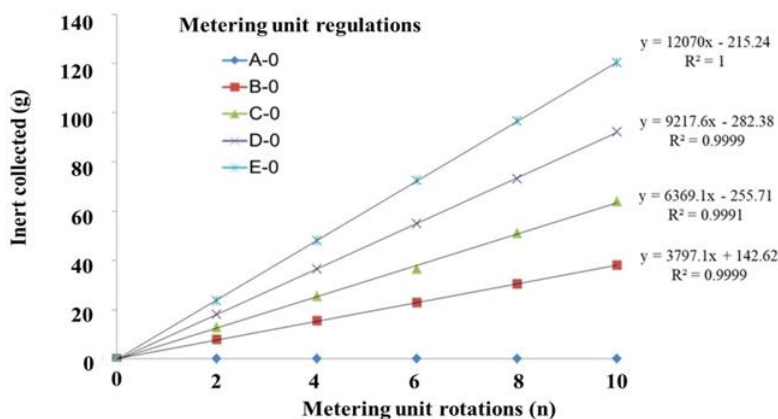
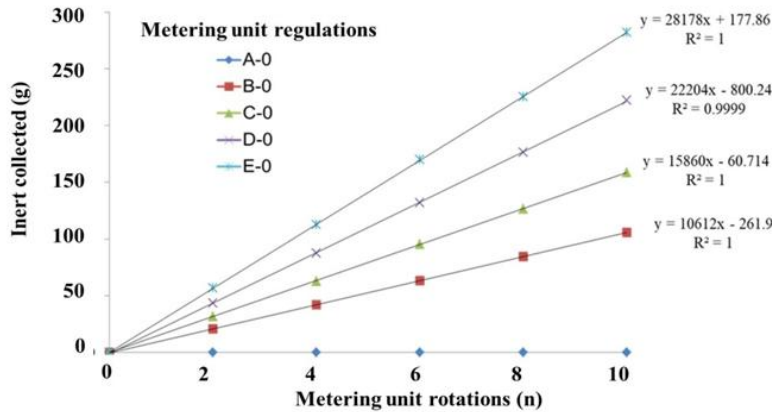
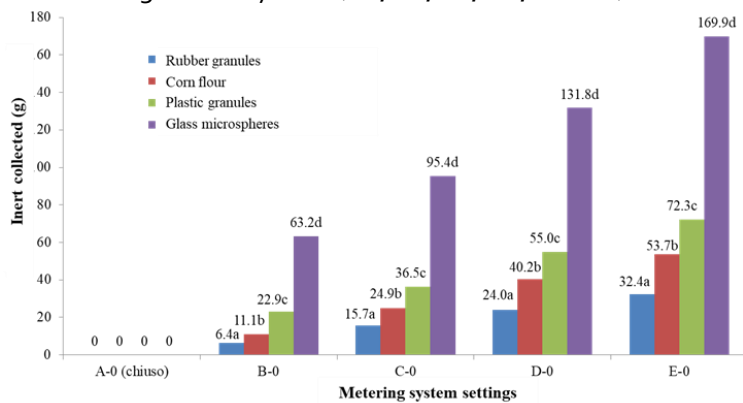

Figure 5. Comparison between the amount of glass microspheres distributed and the rotations number of the X micro-granulator drive shaft



Comparing the mass (g) of material delivered using the different materials tested with the different settings of the flow rate regulation system, a significant difference were show (Figure 6). This trend can be attributable to the different density of the materials used; in fact, that difference is reduced if the amount of inert material collected is expressed in terms of volume (settings Do and Eo) (Figure 7).

Figure 6. Mass (g) of material delivered using the four tests materials with the different settings of the flow rate regulation system (Ao, Bo, Co, Do, and Eo) and 6 rotations of the micro-granulator drive shaft.



Notes: Different letter indicate the eventual difference between values in each metering system setting.

Figure 7. Volume (cm³) of materials delivered using the four tests materials and the different settings of the flow rate regulation system (Ao, Bo, Co, Do, and Eo) and 6 rotations of the micro-granulator drive shaft.

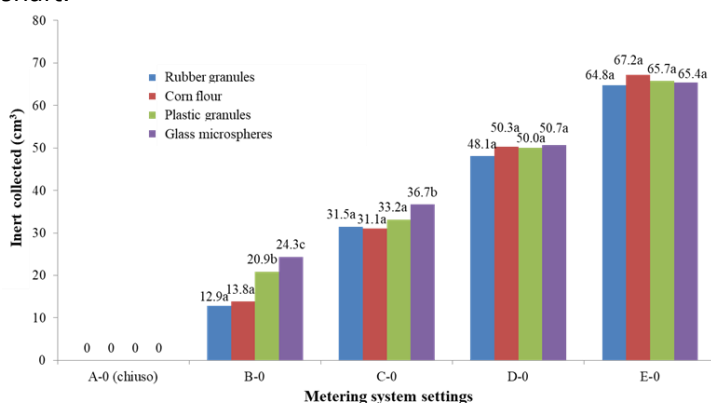

Notes: Different letter indicate the eventual difference between values in each metering system setting.

Regarding the quantity of material distributed by the three different micro-granulators, tests have highlighted some differences for the X micro-granulator, especially when rubber granules was used (Figure 8). However, also the amount distributed by this micro-granulator at the different settings were proportional to those indicated by the manufacturer (Figure 9).

Figure 8. Mass (g) of rubber granules distributed by the three types of micro-granulators (X, Y e Z) using the different settings of the regulation system.

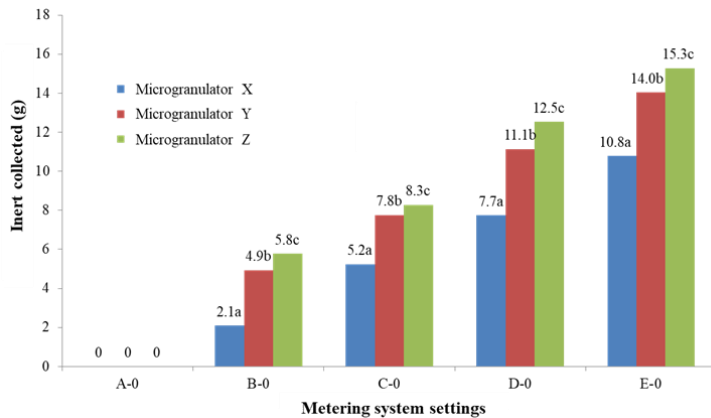

Notes: Different letter indicate the eventual difference between values in each metering system setting.

Figure 9. Difference in percentage between the quantity indicated by the manufacturer and that obtained with the rubber granules.

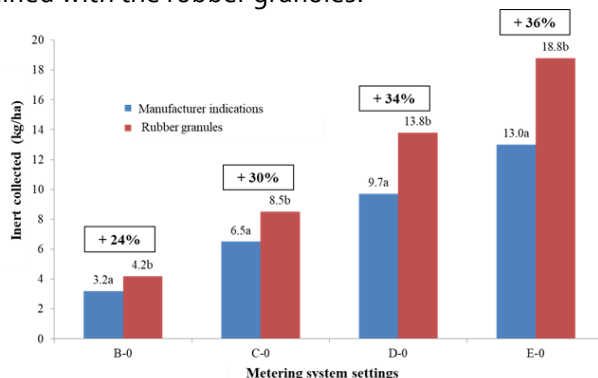

Notes: Different letter indicate the eventual difference between values in each metering system setting.

Conclusion

The tests carried out show a good performances of all the four different inert materials used with no significant differences emerged as regards the tests repeatability. Nevertheless, corn flour showed some problems due to a considerable sensitivity to humidity and to a high propensity to the packing with a limit amount of material in the hopper. Moreover, it is important to underline the potential abrasive effect on the micro- granulator dosage devices when glass microspheres are used. Therefore the rubber granules appear the most suitable inert material for this type of test to be done following the incoming SPISE Advice on the inspection of this type of PAE, also if the main physical characteristic of this material are not always comparable with those of all the granular insecticides present today on the market. For this reason, it is suggest to evaluate the relationship between the amount distributed using the rubber granules and that declared by the manufacturer before beginning the functional inspection and to perform this comparison in relative terms by calculating the difference in percentage between the two types of quantities.

References

- Directive 2009/128/EC of the European Parliament and of the Council of 21 October 2009 establishing a framework for Community action to achieve the sustainable use of pesticides.
<http://eur-lex.europa.eu/eli/dir/2009/128/2009-11-25>
- Dlgs n. 150 del 14 agosto 2012 – Attuazione della Direttiva EU 128/2009 che istituisce un quadro per l'azione comunitaria ai fini dell'utilizzo sostenibile dei fitofarmaci
- Italian National Action Plan (NAP), approved on 22 January 2014 and published on 12 February 2014 (Gazzetta Ufficiale n.35)
- Draft of SPISE Advise - Periodical inspection Granulate application equipment, version of July 2017 (concept 2)EN 13790-1:2003. Agricultural machinery. Sprayers. Inspection of sprayers in use. Field crop sprayers.

SPISE Advice of the Periodical inspection of misting equipment

Tom Bals⁽¹⁾, Jaco Kole⁽²⁾

⁽¹⁾ Micron Sprayers, Bromyard Industrial Estate, Bromyard HR7 4HS, UK

⁽²⁾ SKL (Foundation for Quality Control of Agricultural Equipment), Agro Business park 24, NL-6708PW Wageningen, the Netherlands

Summary

All types of machines used to the application of pesticides must be inspected because of the EU SUD directive. This includes fogging and misting equipment used in Europe for treatments in greenhouses and other specialist indoor and outdoor applications. This machines are not covered by EN-ISO 16122:2 (2015), therefore SPISE has produced a SPISE Advice about the inspection of this kind of machines. This SPISE Advice covers all relevant inspection point for this type of machines.

Introduction.

Foggers are mainly used to control pests in closed environments, such as greenhouses or storage rooms. In some cases, they are used for specific outdoor treatments. They are available in portable and stationary versions or even bigger versions carried by a tractor/vehicle. Foggers produce very fine droplets varying from 1-50 μm with a Volume Median Diameter (VMD) that varies from 5 to 25 μm . Because of these very small droplet sizes there are additional inhalation risks for the operator, particularly for indoor uses (although some units are remotely controlled), and great care must be taken in outdoor uses due to the high risk of drift.

There are foggers working with different principles. The most common are thermal fogs, based on the principle that the droplets are created and transported by means of hot air made by the burning of gasoline. But also electrical fogs are on the market, where the heat for the creation of droplets is made by an electrical heat element and the transport of the droplets is done by a fan. In greenhouses often cold foggers are used, there the droplets are created by means of pressured air created by an (external) compressor and the transport of the droplets is done by means of a fan.

The main advantage claimed by this principle is the dual action when used in closed environments. Due to the “flushing” effect obtained with a fogger, insects (thrips, whitefly, etc.) leave their hiding place and fly up and then receive a lethal dose from airborne droplets. This effect is called the ‘space fumigation’ obtained by the smaller droplets < 10 μm . The bigger droplets (30 to 50 μm) will deposit on the crop which is interesting when using systemic agents, foliage fertilizers, etc. This effect is called the “deposit treatment”. Another advantage claimed by the system is that it is not time consuming. The operator only needs to start up the fogger and the machine does the rest.

The disadvantage of the system is the uneven distribution, unintended contamination from other objects (walls, ceilings, etc.) and high losses. The room needs to be well ventilated before re-entering after pesticide application.

Some machines generate slightly larger droplets (VMDs of between 50 and 100 micron), referred to as mists, that will directly sediment and deposit on a crop or other surfaces. Again most use in Europe is for specialist indoor applications (greenhouses, fly control in stables, post-harvest treatments, etc) and extra care needs to be taken in any outdoor use due to the risk of drift. Some specialist atomisers eg rotary atomisers, twin fluid atomisers, are commonly used for misting and the manufacturer’s instructions/recommendations for use should be strictly followed.



Pre-inspection of the machine

For the safety of the test-operator and to protect the environment and the testing-equipment to get contaminated, the inspection of the machine shall only start when it is made clear that the machine is safe and clean. Here for the item listed in 5.3 of EN-ISO 16122:1 (2015) can be used, but with thermal foggers special attention shall be given to the safety of the fuel system, with electrical foggers to the electrical safety and with cold foggers to the condition of the compressor and also to the electrical safety.

Requirements of the inspected machine

Leakage

- With the engine of the machine not running, with the tank(s) filled with clean water, there is no leakage at any part of the machine.
- With an operating machine, with the liquid flow to the nozzle blocked, there is no leakage at any part of the machine.
- With an operating machine, working with normal flow rate, there is no leakage at any part of the machine.

Spray Mix Agitation

- If an agitation system in the spray liquid tank is present, this system is functioning properly.
- There is a clearly visible agitation in the spray liquid tank.

Spray liquid tank(s)

- The spray liquid tank(s) is/are provided with a lid that shall be well adapted, in good condition.
- The volume of liquid in the tank(s) is clearly visible from the place the machine is filled.
- It shall be possible to empty the tank(s) without the use of special tools and without contamination of the operator and the environment.
- If present, all on the machine present provisions for cleaning the machine and the inner side of the spray tank, shall function and be in good condition.
- With a working machine there should be enough pressure accumulation in the spray liquid tank(s). This pressure is in line with the specifications of the manufacturer (normally 0,3- 0,4 bar).

Measuring-, controls- and regulation systems

- All present instruments for controlling the flow rate are functioning properly.
- All controls for the adjustment of the flow rate are functioning properly.
- All controls for switching on and off the machine and the atomization function properly.

(if present) Pressure Indicator(s)

- All analogue pressure indicators for the reading of the spray liquid pressure have a minimal diameter of 50 mm (measured according EN837-1)
- The scale division of analogue manometers is minimal 0.1 bar in the range of 0-5 bar.
- The pressure can be read from the operator's position. The scale should be appropriate to the working pressure range of the machine.
- The accuracy of the pressure indicators is maximal +/- 10% relative to the value read on the reference manometer.

Lines (pipes and hoses)

- Hoses and Lines are in good condition. These do not show extreme bending and/or wear and are not kinked. They are free from exceptional wear, cuts and cracks. Couplings are in good condition.

Filtering

- In the suction line of the pressure line is at minimum one filter present.
- The filter elements are in good condition, have no holes or cracks and are clean.
- The mesh size of the filter elements are corresponding to the demands of the manufacturer.
- Filters can be checked without emptying the spray liquid tank.
- Filter elements are changeable.

Flowrate / function machine

- The ignition (thermal fog) is function properly
- Functioning burner
- The burning system (thermal fog) is functioning properly
- The compressor (LVM) is functioning properly
- A trial run of the machine should be undertaken at the intended operational settings to ensure, by visual check, that the droplets are sufficiently fine and uniform (no dripping, etc).
- The flow rate of the machine does not differ by more than +/- 15% from the nominal flow rate according to the manufacturer's specifications when the machine has the intended nozzles fitted and with the engine running as in use.

Advice for the functional inspection of plot sprayers with compression tanks

Eskil Nilsson (VISAVI, Sweden)

Jaco Kole (SKL, The Netherlands)

SPISE

Standardized Procedure for the Inspection of Sprayers in Europe

ADVICE

compiled by :
SPISE Technical Working Group15

Advice for the functional inspection of plot sprayers with compression tanks



Advice for the functional inspection of plot sprayers

This document has been compiled by the SPISE Technical Working Group 15

Authors:

Eskil Nilsson (VISAVI, Sweden)

Jaco Kole (SKL, The Netherlands)

CONTENTS

1. FOREWORD	99
2. INTRODUCTION	99
3. PRE-INSPECTION	101
3.1 Cleaning	101
3.2 Power transmission parts and moving parts of the equipment	101
3.3 Structural parts and framework	101
3.4 Lockable foldable parts	101
3.5 Blower	102
3.6 Static discharge devices	103
4. INSPECTION	103
4.1 Tank	103
4.2 Filling hole	104
4.3 Tank agitation system	104
4.4 Pipes and hoses for the dust extraction and distribution (Equipment category A and B)	105
4.5 Controls and regulation systems	105
4.6 Blower	107
5. TEST METHODS	107
5.4.1 Duster with mechanical extraction	108
5.4.2 Duster with an air flow extraction	108
5.5.1 Air speed outlet (symmetry)	109
6. REFERENCES	89

FOREWORD

The SPISE Working Group was established in 2004 during the first SPISE workshop. There the participants welcomed the thought of Dr. Eng. Ganzelmeier (JKI) that a working group should work on further steps for the harmonization and mutual acceptance of equipment inspections. In the following years, thanks to SPISE engagement, a constant exchange of information has been made possible within the working group and consultations went on between the EC and MS on improving the sustainability of plant protection.

The founding members of the SPISE working group came from Belgium, France, Germany, Italy and the Netherlands.

In the ambit of SPISE working Group several Technical Working Groups (TWG) have been recently created with the aim to prepare **advice** about the items taken into account by the EU Directive 128/2009/EC but still not considered in the actual ISO/CEN Standards. SPISE TWG 8 in particular, has defined **advice** on what are the parts and the requirements of equipment and the criteria to use for the functional inspection of dusters.

The present document is intended to provide technical indications about the steps to follow for making the correct inspection of this equipment.

INTRODUCTION

Plot sprayers are used in most European countries in trials for testing of plant protection products in various crops. They are designed to apply one specific product and/or dose in a plot in field trials. They are designed for one treatment only as manually driven or with multiple units as tractor mounted or self-propelled sprayers.

Each treatment in a trial needs cleaning of equipment or change to another separate unit with tank, valves, regulations and nozzles.

The plot sprayers are used as horizontal booms or on sprayers for bush and tree crops.

This SPISE Advice is focusing on plot sprayers with compression tanks. Other types of plot sprayers with pump, tanks, agitation are considered as sprayers that can be inspected according to EN ISO 16122 parts 1 plus 2 or 3.

The advice is based on methods described in EN ISO 16122 and ISO/DIS 19932:3 plus specific parts relevant for this specific type of sprayers

PRE-INSPECTION

3.1 Cleaning

The sprayer shall be clean externally and internally. Shall not be there any pesticide residues into the tank or on the external surface that can be a source of contamination for the inspector or the environment.

Method of verification: visual check.

3.2 Power transmission parts and moving parts of the equipment

The power take-off (PTO) drive shaft, the power input connection (PIC) and the universal joints shall be equipped with suitable and undamaged guards and protective devices, that shall work properly

Method of verification: visual check.

3.3 Structural parts and framework

Structural parts and framework of the equipment shall be without permanent deformation, significant corrosion or considerable defects.

The hitching device shall be in good condition and shall work properly.

Method of verification: visual check.

3.4 Lockable foldable parts

Locking of foldable parts of the equipment, if present, shall works properly and without defects.

Method of verification: visual check.

3.5 Blower

3.5.1 General

The blower (fan, casing) shall be without mechanical deformations, excessive wear and corrosion that could be able to significant vibration or malfunctions.

Moreover it shall be verified that:

- all blades are present and without damages;
- guarding to prevent access to the fan is present and in good conditions.

Method of verification: visual and functional check.

3.5.2 Clutch

If the blower is provided with a clutch to switched off it separately from other driven parts of the sprayer, this device shall function properly.

Method of verification: visual and functional check.

3.6 The sprayer shall be depressurised, empty (no visible puddles in the spray tank) and internally and externally clean to allow safe inspection.

Compliance shall be checked by inspection

3.7 The sprayer shall have no obvious serious damage that would cause failure (e.g. holes or cracks in the tank, severely abraded hoses).

Compliance shall be checked by inspection

3.8. Pressurising system

3.8.1 Tanks and regulators for compressed air shall have valid certificate of approval in national control system.

Compliance shall be checked by inspection.

NOTE: National regulations according to Pressure Equipment Directive 2014/68/ EU shall be regarded

3.8.2 Power take off and v-belts for air compressor, if present, shall be equipped with suitable and undamaged guards and protective devices, that shall work properly

Compliance shall be checked by inspection.

INSPECTION

4.1 Leaks and dripping

4.1.1 Static leaks

There shall be no visible leakage when the sprayer shall be filled with water to its nominal capacity.

With the sprayer parked on a level horizontal surface, a visual inspection for any leakage from the tank, pump and associated pipes shall be carried out.

Compliance shall be checked by inspection.

4.1.2 Dynamic leaks

4.1.2.1 Leak test when not spraying

With a pressure which is equal to the maximum obtainable pressure for the system, with the section valves closed, there shall be no leakage from any part of the sprayer.

Compliance shall be checked by inspection.

4.1.2.2 Leak test while spraying

While spraying at a pressure that is equal to the maximum working pressure recommended by the sprayer manufacturer, or the nozzle manufacturer for the nozzles mounted on the sprayer if lower, there shall be no leakage from any part of the sprayer or spray boom/-s.

Compliance shall be checked by inspection.

4.1.3 Spraying and dripping on parts

Regardless of the height of the boom above the ground, in the height range between the nozzles and the target surface, no liquid shall be sprayed directly on to the sprayer itself (e.g. parts of the sprayer, hoses).

This does not apply if needed by function (e.g. sensors) and if dripping is minimised.

Compliance shall be checked by inspection and function test.

4.2 Spray liquid tank/-s

4.2.1. The spray tank filling opening shall be fitted with a lid that does not leak air or liquid.

Compliance shall be checked by inspection and function test.

4.2.3 Filling hole

The diameter of the tank filling hole should allow a safe and easy introduction of liquid into the tank without spillage

A funnel with a strainer shall be available to fill the sprayer tank/ -s.

Compliance shall be checked by inspection.

4.3 Tank emptying

In case tank/-s are permanently mounted on machine it shall be possible to

— empty the tank/-s e.g. using a tap, and

— collect the liquid without contamination of the environment and without potential risk of exposure of the operator.

Compliance shall be checked by inspection

4.4 Tank agitation system (if present)

The agitation system in the tank, if present, shall guarantee a good agitation.

Compliance shall be checked by inspection.

4.5 Pressure release device

The spray tank/-s shall be equipped with a pressure relief device that prevents over pressurization of the spray tank. The device shall reseal to allow normal operation of the sprayer without leakage.

Compliance shall be checked by inspection and function test

4.6 Measuring systems, controls and regulation systems

4.6.1 General

All devices for measuring, indicating and/or adjusting the operating pressure of spray liquid and/or flow rate shall function.

The valves for switching on or off the spray shall function.

Switching on and off of all nozzles shall be possible simultaneously.

The controls to be operated during spraying shall be operable from the operator's position and the instrument displays shall be readable from this position.

NOTE Turning of the head and the upper body is acceptable to achieve these requirements.

Switching on and off individual boom sections shall be possible.

Compliance shall be checked by inspection and function test.

4.6.2 Pressure indicator for spray liquid

4.6.2.1 Scale and dimension of pressure indicator

At least one digital or analogue pressure indicator shall be fitted at a position where it is clearly readable from the operator's position. Pressure indicators shall be suitable for the working pressure range used.

Compliance shall be checked by inspection.

4.6.2.2 Scale of analogue pressure indicator

The scale of analogue pressure indicators shall provide graduations:

- at least every 0,2 bar¹⁾ for working pressures less than 5 bar;
- at least every 1,0 bar for working pressures between 5 bar and 20 bar;
- at least every 2,0 bar for working pressures more than 20 bar.

Compliance shall be checked by inspection.

4.6.2.3 Accuracy of pressure indicator

The accuracy of the pressure indicator shall be

- $\pm 0,2$ bar for working pressures at 2 bar and below,
- ± 10 % of the real value for pressures at 2 bar and above.

This requirement shall be achieved within the working pressure range suitable for the nozzles mounted on the machine under test.

Compliance shall be checked by measurement according to 5.2.2

4.6.2.4 Diameter of analogue pressure indicator

For analogue pressure indicators the minimum diameter shall be 63 mm, except for those mounted on spray guns and lances which shall have a minimum diameter of 40 mm.

Compliance shall be checked by measurement.

4.6.3 Other measuring devices

Measuring devices other than pressure indicators, especially flow meters and forward speed sensors used for controlling the volume/hectare rate, shall measure within a maximum error of $\pm 5\%$ of the value read on the reference instrument within the range of the measuring device.

Compliance shall be checked by measurement according to 5.3 and 5.4.

4.6.4 Pressure adjusting devices

All devices for adjusting pressure shall maintain a constant pressure with a tolerance of $\pm 10\%$ at constant setting and shall return within 10 s to the original working pressure $\pm 10\%$ after the sprayer has been switched off and on again.

Compliance shall be checked by function test and measurement according to 5.9.

4.7 Lines (pipes and hoses)

Lines shall not show excessive bending, corrosion and abrasion through contact with surrounding surface. Lines shall be free from defects such as excessive surface wear, cuts or cracks.

Compliance shall be checked by inspection.

4.8 Filters

4.8.1 Filter

At least one filter on the pressure side shall be present. Nozzle filters are not to be regarded as pressure-filters.

The filter(s) shall be in good condition and the mesh size shall correspond to the nozzles fitted according to the instructions of the nozzle manufacturer.

Compliance shall be checked by examination of specification and inspection.

4.8.2 Isolating device

It shall be possible, with the tank filled to its nominal volume, to clean filters without any spray liquid leaking out except for that which may be present in the filter casing and the suction lines.

Compliance shall be checked by function test.

4.8.3 Filter insert changeability

Filter inserts shall be changeable in accordance with the sprayer manufacturers' instructions.

Compliance shall be checked by inspection and function test.

4.9 Spray boom

4.9.1 Stability/Alignment

The boom shall be stable in all directions, i.e. no excessive movement caused by wear and/or permanent deformation.

The right and the left parts of the boom shall be of the same length except when the boom is intended for a special function, e.g. over beds in nurseries.

Compliance shall be checked by inspection and measurement.

4.9.2 Automatic resetting

When provided, the automatic resetting of booms shall operate to move backwards and/or forwards, in case of contact with obstacles.

Compliance shall be checked by inspection and function test.

4.9.3 Nozzle spacing/orientation

The nozzle spacing and their orientation shall be uniform along the boom.

The nozzle spacing (adjacent nozzle centre to centre distance) shall be within $\pm 5\%$ of their nominal distance.

The verticality of the nozzle body shall be achieved with a maximum deviation of 10° .

In case of special design or applications (e.g. border spraying), nozzle body spacing, orientation and configuration shall correspond to the manufacturer's design specification.

It shall not be possible to modify unintentionally the position of the nozzles in working conditions, for example by folding/unfolding the boom.

Compliance shall be checked by inspection and measurement.

4.9.4 Boom deformation

4.9.4.1 Vertical position

When measured with the sprayer stationary, the vertical distance between the lower edges of each nozzle and a horizontal reference line (e.g. on a level horizontal surface) shall not vary more than ± 10 cm or $\pm 0,5\%$ of the working width, whichever is the highest.

Compliance shall be checked by inspection and measurement.

4.9.4.2 Horizontal position

The boom shall not be bent in the horizontal plane: the maximum deformation d from the centre-frame to the boom end nozzle shall not exceed $\pm 2,5\%$ of the boom width. See Figure 1.

Compliance shall be checked by inspection and measurement.

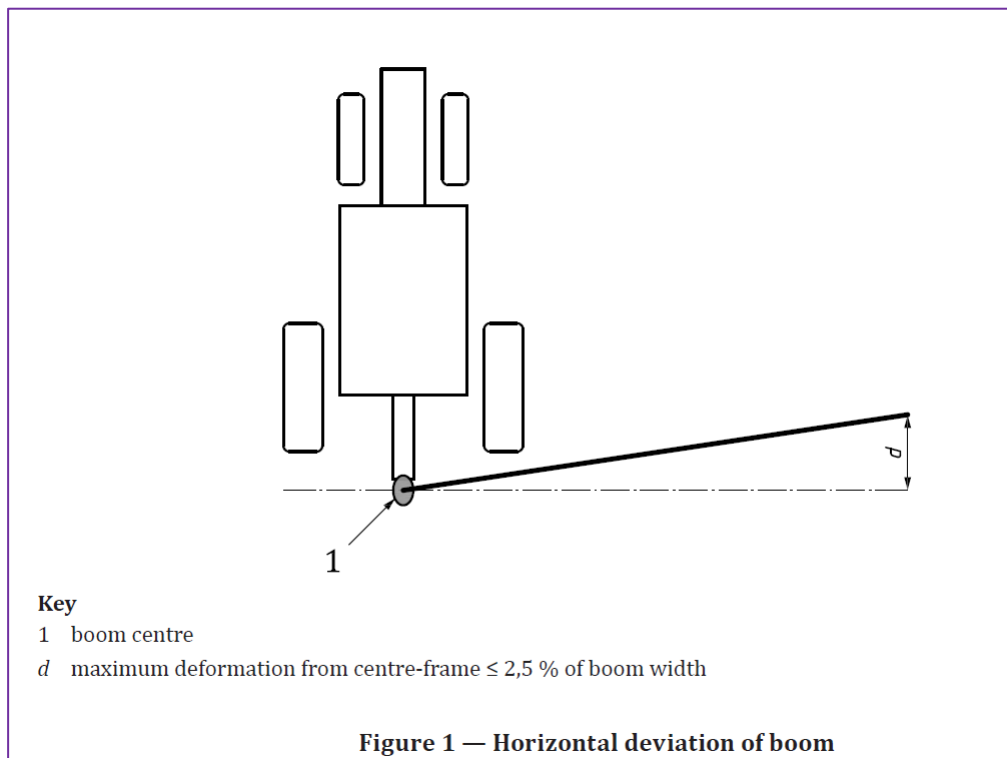

4.9.5 Prevention of nozzle damage

Booms ≥ 10 m in working width shall have a device to prevent damage of the nozzles if the boom hits the ground.

Compliance shall be checked by inspection and measurement.

4.9.6 Height adjustment

If provided, height adjustment devices shall function.

Compliance shall be checked by inspection and function test.

4.9.7 Damping, slope compensation and stabilization

When provided, devices for damping unintended boom movements, slope compensation and stabilization systems shall function.

Compliance shall be checked by inspection and function test.

4.9.8 Compensative returns

When measured at the inlet of each boom section or read on the sprayer pressure indicator, 10 s after a section has been closed, the pressure shall not vary more than 10 %, when the sections are closed one by one.

This requirement is only applicable for sprayers equipped with boom valves which can be set to return the same liquid volume to the tank when closed that would otherwise go through the nozzles on that boom section when the valve is open.

Compliance shall be checked by measurement according to 5.9.

4.9.9 Pressure drop

The pressure drop between the point on the sprayer where the indicated spray pressure is measured during working and the outermost end of each boom section shall not exceed 10 %.

In case of using measurement on a patternator (see 4.10.3.2), only one measuring point at one outer end of the boom is required.

Compliance shall be checked by measurement according to 5.8.

4.10 Nozzles

4.10.1.1 Similarity for boom sprayers

All nozzles fitted to the booms shall be of the same type, size, material and produced by the same manufacturer, except where they are intended for a special function (e.g. the end nozzles for border spraying, bed spraying or band spraying).

Other components (e.g. nozzle filters, anti-drip devices) shall be equivalent over the length of the boom.

Compliance shall be checked by inspection.

4.10.1.2 Symmetry for vertical booms

The nozzle arrangement (e.g. nozzle types, sizes, material and production by the same manufacturer) shall be symmetrical on the left and right hand sides, except where they are intended for a special function (e.g. spraying on one side, fitting of nozzles to compensate the air distribution asymmetry, etc.).

Compliance shall be checked by inspection

4.10.2 Dripping

After being switched off there shall be no continuous dripping from nozzles 5 s after the spray jet has collapsed.

Compliance shall be checked by inspection.

4.10.3 Liquid distribution

4.10.3.1 General

If hydraulic pressure nozzles are used on a horizontal boom to form a uniform spray, 4.10.3.2 or 4.10.3.3 applies; in other cases, 4.10.3.3 applies.

4.10.3.2 Measurement on a horizontal patternator

a) The transverse distribution, within the total overlapped range, shall be uniform. The uniformity of the transverse distribution is evaluated on the basis of the coefficient of variation which shall not exceed 10 %.

b) The amount of liquid collected by each patternator groove within the overlapped range shall not deviate more than ± 20 % of the total average value.

Compliance shall be checked by measurement according to 5.6.

4.10.3.3 Flow rate measurements for horizontal and vertical booms

4.10.3.3.1 General

For sprayers with only one spray liquid output, with adjustable flow rate nozzle, the flow rate has to be measured but no indication of wear can be provided.

Compliance shall be checked by measurement according to 5.7.

4.10.3.3.2 Nominal nozzle flow rate

The deviation of the flow rate of each nozzle of the same type and size shall not exceed — ± 10 % of the nominal flow rate indicated by the nozzle manufacturer for horizontal boom sprayers and ± 15 % for vertical booms, with a flow rate more than or equal to 1 l/min for the maximum working pressure given by the nozzle manufacturer, or — ± 15 % of the nominal flow rate indicated by the nozzle manufacturer with a flow rate less than 1 l/min for the maximum working pressure given by the nozzle manufacturer.

Compliance shall be checked by measurement according to 5.7

4.10.3.3.4 Pressure distribution

When the nozzle flow rate is measured according to 5.7.2 or 5.7.3:

— the pressure at each boom section inlet shall not exceed ± 10 % of the average pressure measured on all boom section inlets; — the pressure at the inlet and outer end of each boom section shall not drop more than 10 %, when spraying with the largest nozzle set mounted on the sprayer.

Compliance shall be checked by measurement according to 5.11.

4.11 Blower

4.11.1 Switching off

If the blower can be switched off separately from other driven parts of the sprayer, the switching off system shall function.

Compliance shall be checked by function test.

4.11.2 Adjustability

Adjustable air guide plates on the blower and on an additional blower casing shall function.

Compliance shall be checked by inspection and function test

4.12 Spray guns and lances

4.12.1 Trigger

The trigger shall function. It shall be lockable in the closed position.

The opening and closing system installed on the gun shall have a quick stop and opening. There shall be no continuous dripping when the trigger is "off" (closed position).

Compliance shall be checked by inspection and function test.

4.12.2 Adjustment of flow rate and angle

If the flow rate and/or spray angle of the spray gun is adjustable, the adjustment device shall function.

Compliance shall be checked by inspection and function test

5 Test methods

5.1 Test facilities

In complement to the test benches described below, the following test apparatus are needed for the inspection:

- tachometer (PTO) (with max error of ± 10 rpm);
- measuring tape (nozzle spacing and height);
- stop watch (flow rate; distribution);
- measuring cylinder (with measuring range 2 l; scale graduation 20 ml; error ± 20 ml);
- air pressure indicator (pressure pulsation damper).

Different test equipment and methods can be used, if at least the same measuring results and accuracy are achieved.

5.2 Sprayer's pressure indicators

5.2.1 Specifications of pressure indicators used for verification

Analogue pressure indicators used for verification shall have a minimum diameter of 100 mm. Other minimum requirements on pressure indicators used for verification are given in Table 1.

Table 1: Characteristics of pressure indicators used for verification (values in accordance with EN 837-1)

Pressure measure to Δp bar	Scale unit max. bar	Accuracy bar	Class required	Scale end value bar
$0 < \Delta p \leq 6$	0,1	0,1	1,6 1,0 0,6	6 10 16
$6 < \Delta p \leq 16$	0,2	0,25	1,6 1,0	16 25
$\Delta p > 16$	1,0	1,0	2,5 1,6 1,0	40 60 100
1 bar = 0,1 MPa = 0,1 N/mm ² = 10 ⁵ N/m ²				

5.2.2 Verification method of the sprayer pressure indicator

The pressure indicator(s) of the sprayer shall be tested mounted on the sprayer or on a test bench by comparison with a calibrated test pressure indicator.

Measurements shall be carried out with both increasing and decreasing pressure. In each case the accuracy of the pressure indicator of the sprayer shall be checked at a minimum of 4 equally spaced points within the relevant working pressure range.

The pressure shall be stable during measurement, e.g. no influence from pump rotation or pulsations.

5.3 Flow meters for controlling the volume/hectare rate

5.3.1 General

The error of the measuring instruments in the test equipment shall not exceed ± 2 % of the measured value with a minimum of 2 l/min.

During the test, the flow rate shall be steady, as indicated by the output of the flow rate sensor or the pressure indicator.

5.3.2 Operating procedure No. 1: Verification by nozzle flow rate measurement

The inspection shall be conducted as follows:

— The spray control shall be set to the correct PTO speed and at a pressure within the working range of the sprayer.

— For each of the following three tests, the average flow rate of at least 5 nozzles shall be measured with a measuring cylinder, or the single flow rate values for each nozzle obtained from the test in 5.6 shall be used in order to calculate the average value of a single nozzle.

— One or more spraying section(s) shall be turned on to give a total flow rate representing 30 % to 50 % of the full flow. The pressure value and the value displayed on the flow meter and the number of nozzles in use shall be recorded.

— Additional spraying section(s) shall be turned on to give a total flow rate representing 50 % to 75 % of the full flow. The pressure value and the value displayed on the flow meter and the number of nozzles in use shall be recorded.

— Additional spraying section(s) shall be turned on in order to reach 100 % of the full flow. The pressure value and the value displayed on the flow meter and the number of nozzles in use shall be recorded.

The pressures shall be read at the level of the sections.

For each flow rate, the reference outflow, Q , corrected for the pressure applied during the test (P_1), shall be calculated as follows:

$Q = \text{Number of nozzles} \times \text{average of single nozzle flow rates, l/min}$

The following formula can be used to calculate the adjusted single nozzle flow rate, d_1 , for the applied pressure P_1 :

$$d_1 = d_2 \cdot \sqrt{\frac{p_1}{p_2}}$$

where

d_2 is the single nozzle flow rate measured in 5.6 or with the measuring cylinder;

P_2 is the pressure during the measurement of the single nozzle flow rate d_2 .

Each value of Q shall be compared with the corresponding value reading taken from the sprayer's flow meter. The deviation between the measured value of Q and the corresponding value reading taken from the sprayer's flow meter shall be expressed as a percentage of the reference value Q.

5.3.3 Operating Procedure No. 2: Verification by installing a calibrated flow meter in the circuit

of the sprayer

On the pump outlet side of the sprayer and as close as possible to the flow meter to be checked, a calibrated flow meter shall be installed.

The inspection shall be conducted as follows:

— The spray control shall be set to the correct PTO speed and at a pressure within the working pressure range of the sprayer.

— One or more spraying section(s) shall be turned on to give a total flow rate representing 30 % to 50 % of the full flow. The values displayed on the sprayer's flow meter and the calibrated flow meter shall be recorded.

— Additional spraying section(s) shall be turned on to give a total flow rate representing 50 % to 75 % of the full flow. The values displayed on the sprayer's flow meter and the calibrated flow meter shall be recorded.

— Additional spraying section(s) shall be turned on in order to reach 100 % of the full flow. The values displayed on the sprayer's flow meter and the calibrated flow meter shall be recorded.

Corresponding recorded readings from the sprayer's flow meter and the calibrated flow meter shall be compared. The deviation between both values shall be expressed as a percentage of the reading from the calibrated flow meter.

5.4 System for controlling forward speed

The actual travel speed shall be measured with an error not exceeding $\pm 2,5$ %.

The measurement shall be carried out continuously over a distance of at least 50 m located on a flat area.

The beginning and the end of the test distance shall be clearly marked. A reference point shall be marked on the sprayer to assist in the identification of the start and finish of the test.

— The tractor or self-propelled sprayer shall be pre-set to achieve a constant forward speed close to the operating speed. The hand accelerator can be used to set the speed of the engine.

— The set test speed shall be achieved before the 1st mark on the test track is reached.

— Timing shall start, by means of the stop watch, when the reference point on the sprayer aligns with the 1st mark on the test track.

— During travel, the speed indicated by the sensor shall be recorded.

— Timing shall stop when the reference point on the sprayer aligns with 2nd mark on the test track.

The measured forward speed shall be calculated using the following formula:

$$v = 3,6 \cdot \frac{d}{t}$$

where

v is the measured forward speed, expressed in kilometres per hour (km/h) and compared with the speed indicated by the sprayer' sensor;

d is the distance travelled, expressed in metres (m);

t is the duration, expressed in seconds (s).

5.5 Uniformity of the transverse volume distribution with a horizontal patternator

5.5.1 Specification of horizontal patternators used for verification

A patternator with grooves 100 mm wide and at least 80 mm deep, measured as a distance between the top and the bottom of the groove, shall be used to measure the uniformity of the transverse volume distribution of the spray.

The groove patternator shall be at least 1,5 m long. The groove width shall be 100 mm ± 2,5 mm. The groove width of a patternator working in steps with electronic data sampling (e.g. scanners) shall be 100 mm ± 1 mm.

Prior to the start of the test, the grooves to be used shall be checked by suitable means such as a pattern to see whether the above tolerance limits are met. The graduated spray liquid measuring cylinders shall be of the same type and size and have a capacity of at least 500 ml. Scale graduation shall be a maximum of 10 ml.

The error of measurement shall not be more than 10 ml or ± 2 % of the measured value whichever is greater.

When passing the measuring track, positioning in single steps shall be completed with an accuracy of ± 20 mm. The measuring error of the volume of the single grooves at a flow volume of 300 ml/min shall be less than ± 4 %. The adjustment and calibration of the patternator shall be in accordance with the patternator manufacturer's instruction handbook.

The size of the patternator shall be suited to the size of the boom to be tested and to the type of sprayer. The patternator shall also ensure that the overlapping range of the spray is measured completely.

5.5.2 Verification method of the uniformity of the transverse distribution

From all nozzle sets present on the sprayer the transverse distribution of spray shall be verified for the complete working width of the sprayer.

The test shall be carried out at a standard testing height (measured from the tip of the nozzle to the top of the grooves of the patternator) following the recommendations of the nozzle manufacturer and a standard test pressure, within the pressure range given by the nozzle manufacturer.

The verification shall be carried out from the midpoint between the centre of the outermost nozzle and the centre of the penultimate nozzle on one side of the boom to the midpoint between the centre of the outermost nozzle and the centre of the penultimate nozzle on the other side of the boom.

5.5.3 Calculation of Coefficient of Variation (CV)

The following formula shall be applied:

CV s

$$s = \sqrt{\frac{\sum(x_i - \bar{x})^2}{n - 1}}$$

$$\bar{x} = \frac{\sum x_i}{n}$$

x_i is the volume of liquid in the tube;

n is the number of grooves;

s is the standard deviation of the volumes collected in the grooves;

\bar{x} is the average/mean volume collected per groove.

5.6 Flow rate of the spray nozzles

5.6.1 General

This test shall be performed either with nozzles mounted on the boom (see 5.6.2) or removed from the boom (see 5.6.3). It shall be ensured that the spray jets are correctly formed when nozzles are mounted on the boom and before dismounting.

The error in the measured flow shall not exceed $\pm 2,5$ % of the measured value or $2,5 \times 10^{-2}$ l/min, whichever is greater.

The test shall be carried out at a pressure within the pressure range given by the nozzle manufacturer.

5.6.2 Measurement with nozzles fitted on the boom

The flow rate of each nozzle shall be measured according to ISO 5682-2:1997, 8.1, except 8.1.1.

The pressure during flow rate test shall be measured at the nozzle position or as close as possible.

NOTE Specific methods for testing pneumatic nozzles are to be developed.

5.6.3 Measurement with nozzles removed from the boom

The measurement of the flow rate of each nozzle shall be carried out on a test bench.

The test bench consists of a pump which pumps water with a certain pressure through the nozzle, a pressure regulator, a pressure indicator (analogue or digital) by which the actual pressure can be monitored and a flow meter by which the actual flow rate can be measured. The pressure indicator shall meet the requirements of 5.2.1.

The liquid system, adapters, etc. shall not influence the flow rate.

5.7 Pressure drop

The test shall be carried out with the highest flow rate nozzle provided on the sprayer and at a pressure within the working pressure range given by the nozzle manufacturer.

A calibrated test pressure indicator (see 5.2.1) shall be fitted at the same position as a nozzle at the outermost end of each boom section.

Measurements shall be made at two pressures at the pressure indicator of the sprayer and the calibrated test pressure indicator.

The values indicated by the pressure indicator of the sprayer shall be compared with values measured by the calibrated test pressure indicator.

5.8 Pressure variation when the sections are closed

Pressure variation shall be checked with a calibrated test pressure indicator (see 5.2.1) at the location of the sprayer's pressure indicator.

Variations in the value indicated by the calibrated test pressure indicator shall be observed and recorded as the sections are closed one by one, with all sections that have been closed kept closed until all measurements have been made.

The pressure shall be observed before and 10 s after each section is closed.

5.9 Pressure variation when the spray is switched off

Pressure variation shall be checked with a calibrated test pressure indicator (see 5.2.1) at the location of the sprayer's pressure indicator.

Variations in the value indicated by the calibrated test pressure indicator shall be observed and recorded when the spray is switched off. The pressure shall be observed before and 10 s after the spray is shut off.

5.10 Pressure distribution

The test shall be carried out with the highest flow rate nozzle provided on the sprayer and at a pressure within the working pressure range given by the nozzle manufacturer.

A calibrated test pressure indicator (see 5.2.1) shall be fitted at the same position as a nozzle at the inlet of each boom section.

The average inlet pressure from all sections shall be calculated and compared to individual inlet pressures.

A calibrated test pressure indicator shall be fitted at the same position as a nozzle at the outermost end of each boom section.

For each section, the pressure drop between the inlet and the outermost end shall be calculated using the following formula:

$$pressure\ drop = 100 \cdot \frac{(p_0 - p_1)}{p_0}$$

where

P_0 is the inlet pressure of the section;

P_1 is the outermost end pressure of the same section.

REFERENCES

EN ISO 16122-1 (2015) - Agricultural and forestry machinery - Inspection of sprayers in use - Part 1: General.

EN ISO 16122-2 (2015) - Agricultural and forestry machinery - Inspection of sprayers in use - Part 2: Horizontal boom sprayers.

EN ISO 16122-3 (2015) - Agricultural and forestry machinery - Inspection of sprayers in use - Part 3: Sprayers for bush and tree crops.

ISO/DIS 19932:3 Equipment for crop protection — Knapsack sprayers —Part 3: Inspection of knapsack sprayers in use

SPISE Advice of the Periodical inspection of fixed and mobile Rotary atomizers pesticide application equipment for band application.

Tom Bals⁽¹⁾ Jaco Kole⁽²⁾

⁽¹⁾ Micron Sprayers, Bromyard Industrial Estate, Bromyard HR7 4HS, UK

⁽²⁾ SKL (Foundation for Quality Control of Agricultural Equipment), Agro Business park 24, NL-6708PW Wageningen, the Netherlands

Summary

All types of machines used for the application of Plant Protection Products must be inspected because of the EU SUD directive. This includes machines for band application equipped with rotary atomizers. Machines with this kind of atomizers are not covered by EN-ISO 16122:2 (2015), therefore SPISE has produced a SPISE Advice about the inspection of this kind of machines, both mobile machines as stationary machines. This SPISE Advice covers all relevant inspection point for this type of machines.

Introduction.

Machines with rotary atomizers are used for purposes where low application volumes have to be dosed with uniform droplets. Rotary atomizers are used both on stationary machines and mobile machines. The stationary machines are mainly used to apply PPP on a product (like potatoes) moving on a conveyor belt. The machine is then built onto a conveyor belt or hoppers. Mobile band sprayers using rotary atomizers can be used for applying herbicides for weed-control or killing potato halms.

The working principle of a rotary atomizer is that spray liquid fed on to a spinning disc will be thrown of the periphery in droplets of uniform - depending on even liquid feed to the edge of the atomiser disc and an undamaged disc, hence it is very important that the disc is kept both clean and undamaged. Droplet size is determined by diameter of the disc and its rpm. Most rotary atomizers are driven by a small electric motor but hydraulic or other power sources have been used. The spray solution is generally driven by a pump to the spinning disc. This can be a positive displacement pump or a peristaltic pump.



Pre-inspection of the machine

For the safety of the test-operator and to protect the environment and the testing-equipment to get contaminated, the inspection of the machine shall only start when it is made clear that the machine is safe and clean. Here for the item listed in 5.3 of EN-ISO 16122:1 (2015) can be used, but especially with stationary equipment attention shall be given to electrical safety.

Requirements of the inspected machine

Leakage

- With a switched off machine, with the spray tanks half-filled and the pump switched off, there shall be no leakage of liquid at any part of the machine. Besides this, the spray tank has no holes, cracks or other openings through which fluid could possibly leak any liquid.
- Working at normal conditions there shall be no leakage at any part of the machine.

Condition of the pump

- a. Peristaltic pump
 - The drive of the pump is in good condition
 - No unusual play on pressure mechanism
 - Pump hose(s) is/are in good condition
- b. Positive Displacement pump
 - The drive of the pump is in good condition
 - Membranes are in good condition
 - Pump springs and pump wheels are in good condition.



Functioning agitation (if present)

- There is a clearly visible agitation in the spray liquid tank under the following condition:
 - With the spray liquid tank half filled
 - With the agitation system switched on according to the instructions of the manufacturer.

Spray liquid tank(s) (applies only if a separate spray liquid tank is present and not if the pure product is directly sucked out of the product container)

- The spray liquid tank has a lid which is in good condition, well-fitting and not damaged
- In the opening of the tank a strainer is present. This strainer is well fitting in the hole and is in good condition (no cracks or holes in the material of the strainer)
- If there is a filling installation for plant protection products present on the machine, then:
 - Has a provision to prevent objects with a diameter of more than 20 mm to enter the spray tank
 - Function well and does not leak
- There is a well-functioning pressure compensation of the spray liquid tank to prevent over- or under pressure - not required if a gravity i.e. unpressurised, feed system is used.
- The marking of the level of the liquid in the spray tank or assembly of tanks is clearly visible and readable.
- It is possible to empty the tank(s) completely without the use of special tools or removing part of the machine without the risk of contamination to the operator or the environment
- If a filling connection on the machine is present to fill the tank with water, there must be a well-functioning provision present to prevent the back flow of any water out of the tank to the water source.
- If a cleaning device for cleaning empty containers is present on the machine, this installation shall function properly.

- All equipment/provisions on the machine to clean the machine and the inside of the spray tank, cleaning installation for empty containers and the complete machine are in good condition and shall function properly.

Condition and functioning of Measuring-, control- and operation systems

- All instruments and controls needed for measuring, control and operation of the machine are functioning well.
- The switching on or off of the atomizers function properly, it is possible to switch on or off or atomizers at the same time.
- All controls needed to operate during the application or reachable and visible from the operator's position.
- Measuring systems like flow- or speed meters needed for the regulation of the liquid flow present on the machine have an accuracy of +/- 10% in relation to a reference instrument/method.

Condition hoses and line

- All hoses and lines are in good condition. There is no extreme bending or wear on the outside. They are free from defect like exceptional wear, cuts, cracks and corrosion. The reinforcement of the hose is not damaged, appearing in swollen hoses.
- Couplings are in good condition

Filtering (if present)

- The filter elements are in good condition, have no holes or cracks in the filter material and the inserts are clean.
- The mesh size of the filter inserts is as prescript by the manufacturer
- Filters can be checked without draining the fluid tank.
- Filter inserts are changeable.

Atomizer mounting/connection

- The mounting of the atomizers is in good condition and there is no excessive play on all turning or hing points caused by wear or damage.
- There is no excessive play on all turning or hing points caused by wear or damage
- Measured with the machine in horizontal position, placed on a flat surface, the difference in distance between the underside of each atomizer and the floor is not more as 10 cm of +/- 5% of the machine width, what is the highest.

General / atomizers

- All atomizers on the machines are of the same type, size and brand, except when the atomizers are meant for a special function.
- 5 seconds after the supply to the atomizer is closed, there is no continuous dripping
- The machine should not be designed so that spray contaminates it directly, except if necessary to function. If needed for the protection and/or the well-functioning of the machine this shall be minimized.
- All atomisers shall produce a regular and reproducible spray pattern.
- If present and needed for a proper functioning, all parts needed to adjust the height of the atomizers are functioning safe and properly.

Flow rate of the metering system or - pump

- The flow rate is adjustable in a for the user relevant range. .
- The flow rate of the individual atomizer is within the range of +/- 10% or the average flow rate of all atomizers of the same.

Distribution atomizers

Mobile machines:

The adjustment of the working width by the atomiser, and/or spray shield/hood if present, shall comply with the intended function.

Stationary machines:

The mounting and adjustment, if any, of the atomiser and machine shall allow the intended spray width for the intended use e.g. matching the width of the conveyor belt to ensure correct treatment and minimum waste

- The adjustment of the shielding is such that the liquid (as less as possible) hits any parts of the machine or other parts (shielding). Advice for stationary machine: leaking gutter in the length direction of the conveyor belt to collect the dripped liquid
- To ensure good performance it is critical that the disc is in good condition so it should be clean and undamaged e.g. no damage to the surface or any serrations/teeth on the disc edge.
- To ensure protection for foliage from spray drift it is critical that all spray shields/hoods are in good condition i.e. undamaged (with no broken bits that could result in spray being emitted).
- It is essential that the atomiser/disc rotates at the correct/recommended speed to produce the correct/desired droplet size range. Discs should spin smoothly at a constant speed with no exceptional play on the motor. The discs should rotate at the correct/recommended rotational speed +/- 10%

The future demand for an inspection of more advanced features on pesticide application equipment

Christoph Schulze Stentrop (HARDI International A/S)

Summary

Modern sprayers have a long list of advanced features, which are not proven in the in-use inspection. This optional equipment makes the application safer for the operator and the environment. But is it necessary to test these features if these are on the sprayer or is it enough to make a note in the inspection report.

The presentation gives a short overview about some of the advanced solutions and rise questions what else could be required. The focus is here on horizontal boom sprayers as in this segment the more advanced pesticide application equipment (PAE) is used. But also bush and tree crop sprayer could use certain equipment.

The presentation shows that there will be always a demand for adaptation of the EU directive and also the consultant work of the SPISE group is important for a safer crop care in the future.

Keyword: Smart Farming, precision application, telemetric, autonomous sprayer, remote inspection

Situation:

The inspection of standard horizontal boom sprayers and bush and tree crop sprayers should be seen as common practice. But today the inspection level is more or less analogue technology from the 90th. The data handling has been improved over the years, but the tested equipment is still the basic components of a sprayer, as tank, pump, boom, fluid system and nozzles. The electronic features and sensor technology is not part of the inspection today.

There are two major challenges:

- How to test an equipment in an workshop
- Which standard should be the base for the inspection



Example of an advanced boom sprayer: HARDI COMMANDER i TWIN FORCE - with ISOBUS Terminal, AutoSectionControl, AutoWash, AutoHeight boom management system and remote data management

Technical features

On a modern sprayer are different technical features used to improve the performance, this could be only to support the operator, so he has less stress or to or he can drive faster for to cover more area in the same time. But mainly these systems are used for a more precise and safer application. Finally all equipment will support a possible reduction in pesticide use and gives in this way a better sustainability.

This paper is not giving technical details, as this would require more space, but in the presentation more details will be discussed.

Generally it can be mentioned that there are always one or more sensors, which are connected to control unit, which uses smart algorithms to optimise the functionality of the sprayer. This means in the case of inspections, that either the sensor function must be proven or the function of the whole equipment!

- Automatic GPS based switching of sections get more and more common. These systems lead towards a reduction of plant protection products, as the amount of overlapped areas is minimized; the amount of reduction is belonging to the field size, field shape and the width of the boom sections. The reduction of plant protection products is between 3 to 6 %. The difficulty is the calibration and adjustment of the systems. Simply said it must be proven if the technical dimensions are correct and is the system working in the correct way. On ISOBUS sprayers is the automatic section control a task controller function and the performance level is belonging to the terminal and not the sprayer ECU, which could be difficult to proof. But also simple questions as how to proof a GPS receiver, if an indoor inspection are done.
- **Boom height management systems** support the operator big time; and on new sprayers 75 % of the bigger boom versions have an automatic boom management system on. These allow higher driving speeds and also reduce drift as the booms can be driven lower to the target, which lowers the drift potential. But there are different technical solutions available, for example some systems work only over the slant cylinder, others use only the tilt function of the boom wings, and there are also system using both functions. There is also a wide variation in the performing level.

From the sprayer inspection view point the performance level can't be tested, only if a system, when it is present, it should work.

There is also a risk if the system is in automatic mode and has a wrong setting or sensor failure the boom could be also in a too high position, than the drift risk is higher and performance could be poor.

- **Smart Farming** is a broad area, but when focusing on application it is more or less the work with different volume rates per area. The area could be small, even down to m²; and the dose rate / flow rate could vary a lot. Which in a perfect world would require different flow rates per boom section or per nozzle? But how to proof solutions like this? There are different methods for nozzle inspection; here it would be ideal to use a combination of these. For the inspection at least a recommendation is required, how to verify sprayers like this in the case of inspection or a risk assessment must be done if systems are environmental safe. In Smart Farming a lot of **data management** is involved, as the application decision can either be taken before the spray job, then it is an application map which the spray control will followed. Or the application decision is taken by a sensor on the machine or on a drone and is than in real time managed on the sprayer. Nevertheless reaction time and precision are major players in that process, but how to measure this in a stationary inspection. Also automatic functions and processes of the fluid system as AutoWash and AutoFill can be documented.

In this application segment are also Pulse Width Modulation, Multi-nozzle variable application, curve control and also direct injection techniques in.

- Future sprayers will offer **telemetric** connectivity and could offer a **remote inspection** of correct functionality. But what inspection level is required, only the basic functionality or do we need specific requirements for the telemetric components.

It could be possible to do a real time observation on all electronic components, including boom height, spray pressure etc. Here it could be also a conflict with data security.

- **Autonomous sprayers** or a group of smaller sprayers in a swarm could or will be getting into the field. In which category are these PAE? Clear guidelines are demanded! Has an autonomous sprayer be tested more often, or does this need data locking? This is a wide area which will develop in the next years and it would be good to know what safety level is demanded. Who is the operator of an autonomous sprayer?

Remote inspection

Here is a big chance to improve the performance level of PAE. If all important electronic functions can be observed, the operator has a daily inspection possibility. This system must be able to group the data from different sensors to a readable value, as example data from flowmeter, pressure sensor, driving speed gives the volume rate l/ha. Here a definition is needed what data must be available for the inspection. It is a type of a traceability process.

A remote inspection could lead to a far higher level in food production, for example in the vegetable production, fresh food needs to have the highest security level, as it goes direct from the field to the consumer.

Conclusion

Advanced technical solutions offer a lot of opportunities, up to real time observation of the pesticide application equipment. But there is always a risk of wrong functionality, which could lead to environmental problems.

There are a lot of open questions, where a common understanding is needed, to do an environmental safe application.

The SPISE community is doing a lot of specific solutions for all type of application equipment as this is part of the requirement from the EU commission. But there will always be a demand for adaptation of the EU directive, but who can officially decide what the correct application is? Here the consultant work of SPISE is important for a safer crop care in the future.

Poster Session

INNOSETA – Innovative training and influence on the quality of inspections. An overview of training organization in EU

Emilio Gil

Department of Agri Food Engineering and Biotechnology - Unit of Agricultural Machinery - Universitat Politècnica de Catalunya - Esteve Terradas, 8 - 08860 - Castelldefels (Barcelona) - SPAIN

Abstract

Training and dissemination are key factors for the success in crop protection. The specific aspects related with the phase-use of Plant Protection Products (PPP) mainly linked to the spray technology, have been widely investigated and improved in the last years. A large list of research, extension and training projects supported by public funds have derived in a large list of developments, materials, tools, decision support systems and other interesting tools addressed to stakeholders (farmers, advisors, authorities...). Additionally, new developments and applied research carried out by sprayer's manufactures have been really impressive in the last years, being able to put into the market interesting developments and technologies for a safe and efficiency use of pesticides. However, in most cases, most of those developments never arrive to the final user, due to problems linked with lack of information, limited knowledge and practical difficulties as language. INNOSETA project, a European Project financed by H2020 program has been launched with the aim to create a universal platform where stakeholders can find, on an easy and practice way, all the materials already developed, considering practical aspects as crop, regional characteristics, language, level of complexity and other important aspects.

Introduction

Global agriculture relies on synthetic Plant Protection Products (PPP) for pest management including insecticides, fungicides, herbicides, rodenticides, molluscicides, nematocides, plant growth regulators and others to support sustainable yield productivity. Farmers and crop advisors/extension service personnel follow conventional crop protection strategies that were established after the Green Revolution during 1950-1960 maintaining, in general, significant use of PPPs with potential significant impact on the environment and human health. In the meantime, PPP industry and research entities have been developing more sustainable novel PPPs either biological or chemical that show high efficacy in lab environment, but their efficacy rate is reduced significantly, when applied in field conditions with the current spraying practices. Even more, spraying technologies have experimented in the last years an important improvement in terms of efficiency and safety, including in their development the latest advances in electronics, data management and safety aspects. New sprayers have experienced a revolutionary improvement allowing a better and safer use of PPPs.

New PPP developments and the latest advancements in intelligent sprayers have been complemented with a large list of Best Management Practices (BMP), alternative methods for dose/volume selection adapted to canopy structure, safe recommendations to reduce drift, resident exposure and point sources' contamination, development of electronic and web-based Decision Support Systems (DSS) to improve the phase-use of PPPs. But unfortunately, there is still an important gap between research developments and the actual use of the available tools and practices by the farmers, especially for this large number of small and medium producers with limited access to the information. If this gap closes, then European agriculture could become more sustainable with minimum environmental, socioeconomic and human health impact. Since new legislation has applied efforts to the use-phase of PPPs, it is now time to integrate all the disposable tools and practices that previous research has demonstrated to be interesting. However, there is still another key element that is absolutely needed to achieve success in the whole process: an adequate training of all the professionals involved in the

process, which represents the key factor for the whole integration. Therefore, only when agricultural stakeholders gain knowledge of existing and future technological advancements in spraying technology and adequate training is achieved in all of the European territory will the system be able to implement the policies in the legal framework and to produce food in a better and more sustainable way.



Figure 1. INNOSETA is a H2020 European Project

Objective of INNOSETA project

INNOSETA - Accelerating **INNO**vative practices for **S**praying **E**quipment, **T**raining and **A**dvising in European agriculture through the mobilization of Agricultural Knowledge and Innovation Systems

SETA - **S**praying **E**quipment, **T**raining and **A**dvising

The main objective of INNOSETA (Fig. 1) is to set up an Innovative self-sustainable Thematic Network on Spraying Equipment, Training and Advising to contribute in closing the gap between the available novel high-end crop protection solutions either commercial or from applicable research results with the everyday European agricultural practices by promoting effective exchange of novel ideas and information between research, industry, extension and the farming community so that existing research and commercial solutions can be widely communicated, while capturing grassroots level needs and innovative ideas from the farming community.

Detailed distribution of the objectives can be established as follows:

- Objective 1: Create an inventory of directly applicable spraying equipment and technologies, training materials and advisory tools available from the large stock of research results and commercial applications.
- Objective 2: Assess end-user needs and interests, and identify factors influencing adoption considering regional specificities.
- Objective 3: Generate interactive multi-actor, innovation-based collaborations among different stakeholders.
- Objective 4: Set up of an ICT tool for the on-line assessment of the Spraying Equipment, Training and Advising and the crowdsourcing of grassroots-level ideas and needs.
- Objective 5: Liaise with EIP-AGRI and its structures.

Representative consortium

INNOSETA consortium has been established trying to cover all the sectors involved in the process. From academia to the final user, going through sprayer’s manufacturers, pesticide companies, advisors and farmer’s associations, the main objective during the consortium creation was to cover all the strategic sectors. Fifteen partners from 7 countries have been organized in different strategic hubs (Fig. 2).

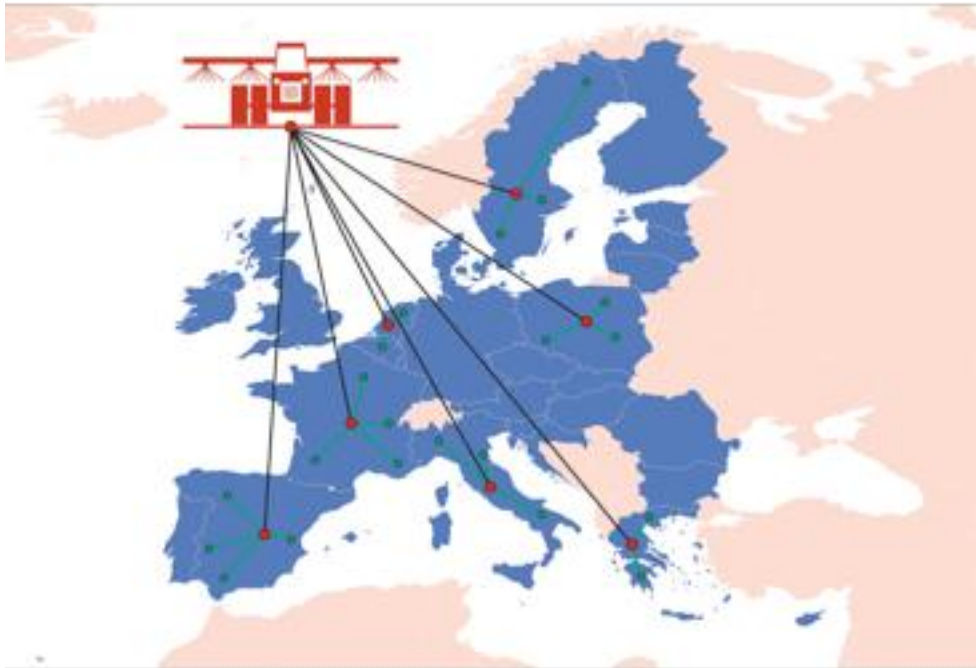

Figure 2. Seven hubs have been identified as main focus areas for the INNOSETA project.

Main reasons for creation of INNOSETA CONSORTIUM:

- INNOSETA gathers experts in both the technical part (spraying technology, extension and training), and social science and innovation to allow a holistic approach to the uptake of novel SETA and the capture of innovations.
- INNOSETA is based on a “Multi Actor Approach”, including farmers/extension organizations from 7 countries, which ensures that the end-users of SETA innovations are well represented.
- Six SETA partners are core partners of several flagship EU projects related to this Thematic Network in the fields of Spraying technology (H₃O and FITOVID: UPC) Spraying training (TOPPS and BTSF-PAE: UPC, UNITO and IFV), IPM strategies (EUCLID and SU.SA.FRUIT: UNITO), knowledge and innovation systems (PRO-AKIS: AUA), ICT in agriculture (Smart-AKIS: AUA and IoF2020: AUA and ILVO) and innovation brokering (AGRISPIN: AUA and ZLTO), which will allow the project to build on relevant results, leading to more targeted and effective exchanges among stakeholders, while optimizing EU funds use.
- Industry relating to SETA will participate in INNOSETA providing the contact of this thematic network with staff from the R&D and commercial departments of multinationals and SMEs from the countries involved in the project and other EU countries. More specifically, the farm machinery industry is represented through its umbrella organization (CEMA: European Association of Agricultural Machinery), while the Plant Protection Product industry will also join

forces (ECPA: European Crop Protection Association). Last but not least, COPA-COGECA will signify the farmers’ industry that is the final applicator of agrochemical in the field.

- A working group will be composed by staff from the R&D and commercial departments of multinationals and SMEs (both sprayers manufactures and pesticide producers) and farmers’ representatives from the countries involved in the project and other EU countries. The working group will exchange information and application experiences on the latest spraying technologies on the market and assess their adoption by farmers. It will also identify the most significant stakeholders at regional level and involve them in the project activities, including the participation in at least one of the three regional workshops.

INNOSETA is coordinated by Universitat Politècnica de Catalunya (<https://uma.deab.upc.edu>).

Why SETA solutions?

Novel SETA has a real potential to deliver a more productive and sustainable agricultural production, based on a more precise and PPP-efficient approach, especially in a scenario of farming labour shortage and climate change. However, novel SETA (Fig. 3) are not widely implemented throughout Europe, except in some advanced European countries (i.e. Germany, Netherlands, Sweden and Denmark), where there are still a large number of innovations in spraying technology to be adapted. Improvement of training activities have been widely underlined as the most efficient tools to improve the application-phase of PPP in EU members with lower technological level and higher number of small and traditional farmers (i.e. Mediterranean countries), while in large agriculture productions from the North of Europe, new technological improvements and developments are largely appreciated.



Figure 3. Examples of SETA (inner to outer circle: Spraying Machinery and their components, Software and hardware in sprayers and spraying application techniques, Best Management Practices adapted to particular requirements)

The underlying reasons for this implementation gap can be deduced from empirical adoption studies that have shown that individual adoption and the wider diffusion of technological innovations and new application techniques depend on characteristics of the innovation (e.g. cost, complexity), the innovator and his/her socio-economic background (e.g. preferences and educational level of farmer),

the perceived usefulness and ease of use, the informational, social and institutional environment, and, in particular the knowledge support system in place

Expected outcome of INNOSETA project

The strategic impact of INNOSETA is based on:

Its relevance to current needs to improve crop protection process and plant protection management.

- Its timeliness, as SETA poses a crucial part of crop production to improve the efficiency of pesticide application process, generating technical, economic and environmental benefits.
- Its multi-actor consortium, combining interdisciplinary spraying experts and rural sociology researchers, extension services, farmers' organizations in 8 EU countries, three umbrella European Associations having an extended network to farmers, sprayers manufacturers and pesticides companies, which will allow for broad and intense dissemination of the project outcomes
- Its systemic and interactive approach to innovation, including the social dimension, that will allow addressing all aspects related to the generation, introduction and diffusion of agricultural innovations to achieve the necessary shift to innovation-driven research in the area of SETA and a greater user acceptance.

INNOSETA will adopt strategies that will ensure long lasting impact on the spraying application of PPPs in agriculture beyond the project's lifespan. This will be achieved through:

- i) the commitment by the core project partners to allocate own resources for maintaining the Thematic Network as a stable collaborative platform (following i.e. the ENDURE model)
- ii) the maintenance of dedicated working groups within the three participating European associations (ECPA, CEMA, COPA-COGECA) which will allow mainstreaming the multi-actor and interactive innovation approaches in the implementation and innovations of SETA both by industry and research;
- iii) the cross-fertilization and in-depth collaborations achieved among actors in the SETA domain, which will lead to the sustainability of the knowledge flow and the mutual learning processes elicited; and iv) the link of SETA Platform with EIP-AGRI SP that will make all SETA solutions available at EU level.

INNOSETA in the media

INNOSETA project was officially launched May 1st 2018. Since this date, the project is already present in the most widely disseminated social networks, as Facebook, twitter and Instagram (Fig. 4).

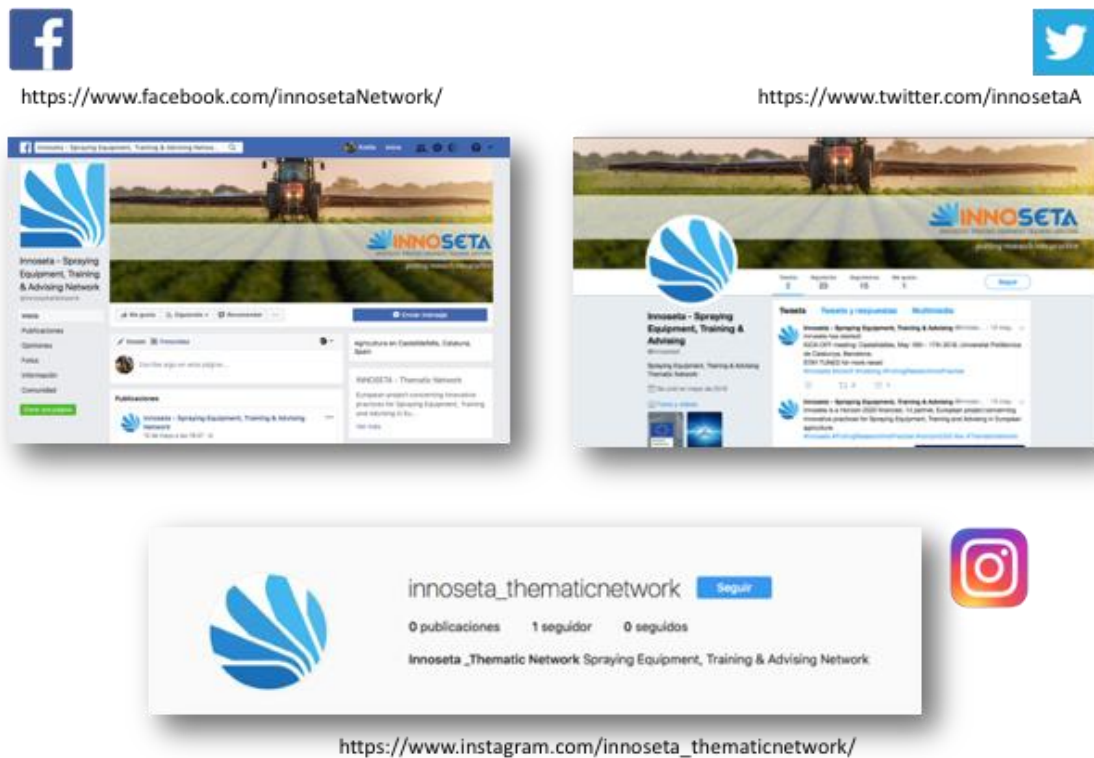

Figure 4. Social media networks of INNOSETA project

INNOSETA website (www.innoseta.eu) is also available.

Public funding

INNOSETA is an EU project located on H2020-RUR-2016-2017 (Rural Renaissance - Fostering innovation and business opportunities. Topic: RUR-10-2016-2017. Type of action: CSA (Coordination and support action))

This project has received funding from the (European Union's Horizon 2020 research and innovation programme) Euratom research and training programme 2014-2018] under grant agreement N° 773864.

Applicability evaluation of draft test protocol for functional inspection of solid fumigant applicators.

Gianluca Oggero¹, Paolo Balsari¹, Andrea Minuto², Paolo Vinotti²

¹ Torino University – DiSAFA – Crop Protection Technology Laboratory – Grugliasco (TO)

² CeRSAA – Experimentation and technical assistance in agriculture - Albenga (SV)

Summary

The applicability of draft test protocol for functional inspection of solid fumigant applicators has been checked.

Two widespread machine models, normally used in horticultural farm of Liguria Region (north-west Italy) for broadcast soil fumigation were tested.

Pre-inspection phase does not show specific problems; also the functional inspection phase, both for visual check operation -presence or not of some devices on the machines- and for test of they function if present, does not show specific hurdles.

In particular the test of distribution uniformity, performed using rubber granules as blank test, give some indications on how to modify the current test protocol draft. The modification consist in change the admissible threshold; the maximum deviation of each distribution pipe, relative to the mean value, have to be varied from 10% (current draft) to 15%. Furthermore, it is suggested an alternate method to assess the distribution uniformity of rubber granules; this method considers the use of horizontal patternator fitted by grooves similar to that used to check the distribution uniformity of boom sprayers. The proposed method will facilitate the coefficient of variation (CV) calculation.

Keywords: inspection, fumigant, pesticide application, SPISE, uniformity distribution

Introduction

Soil disinfection with solid fumigant applicators is pretty diffuse in several countries like Italy in horticultural area, both in open field and in protected crops, including glass-greenhouses, but walk-in-tunnels, and multispan plastic greenhouses too. Soil fumigation is periodically performed, also depending from the restrictions reported by the registered label [in accordance with Regulation (EC) No 1107/2009] with the aim to disinfested a soil layer of 30-35 cm depth against fungi, insects, nematodes and weeds.

A solid fumigant applicator is a device to apply fumigants (generally Dazomet) in a solid form, as dry granules or micro granules. It typically consists of a hopper, an agitation system, a metering system to deliver a measured quantity of granules and a delivery system. Delivery system refers to the part of the machine from the metering outlets to the point where the product is delivered

Applicator can be configured in many different ways depending on the distribution system, on the size and quantity of hoppers, the number of outlets, the drive type and the presence of a soil rototiller and of a compaction system. Hopper capacity is generally between 30 and 150 l and working width can go up to 3 m. Advanced applicators are equipped with a controller box to adjust the setting of the machine.

Applicators combined with a soil rototiller are used without any overlapped application. In principle, the applicator includes following parts:

fumigant hopper provided with a top cap firmly closing the hopper avoiding any accidental granules/dust leak,

mechanical or agitation mixer: the mechanical mixer delivers the solid fumigant to the soil trough distribution pipes or other driving device. The mechanical mixer can be mechanically or electronically driven during the solid fumigant delivery,

distribution pipes: distribution pipes drive the solid fumigant from the hopper throughout the mechanical mixer to the soil eventually throughout a soil injector. The number of distribution pipes might depend on mechanical mixer characteristics and on the injection/distribution system. When available the soil injector allows the distribution of the solid fumigant deep into the soil. Injection depth can be adjusted. The number of injector depends from working width,

soil mixer: the soil mixer is basically a rotary tiller made as common soil tiller,

soil compaction roll: such roll, mechanically driven or not, ensure a surface soil compaction aimed at limiting fumigants losses,

soil mulching system: this system, when present, ensure the complete soil mulching of the fumigated soil strip.

In applicator not combined with a soil rototiller, contrary to applicator combined with a soil rototiller, the solid fumigant is always delivered by injection into the soil. Application rate can be mechanically or electronically tuned.

In the framework of the Spise TWG 10 a specific Spise Advice draft concerning the functional inspection of soil disinfection machine for liquid (part 1) and solid (part 2) formulation distribution has been developed. The applicability of draft test protocol for solid fumigant applicator (part 2) has been checked on two machine models used on basil farms of Liguria Region (north-west Italy).

Materials and methods

The solid fumigant applicator OLIVER FPA 300 (Figure 1) is equipped with a 350 Kg single hopper. Eight metering units are placed on the hopper bottom; from each metering unit two pipes distributor deliver the fumigant product to the soil. The machine is equipped with front rototiller and rear soil compactor roller that are activated by PTO unit. The cage roller, due to the contact with soil, transmit the movement to the pinion that control the rotary movement of metering units; the fumigant application is allowed by machine forward progression. The metering units provide a fix volumetric dosage and the applied dose is determined varying the pinion dimension. Once distributed on the soil surface, the fumigant product is buried and mixed with soil by the rototiller action.



Figure 1. – Solid fumigant applicator model OLIVER FPA 300.

The solid fumigant applicator FORIGO Mix Tiller Dry 35 – 230 (Figure 2) is equipped with double hopper of 100 Kg each one. Each hopper is provided of six hopper draining pipes used to conduct the solid pesticide to the metering units placed near the soil surface. The machine hoppers are equipped with centrifugal fans that provide an air flow inside the hopper draining pipes, in order to supply a constant flow of solid fumigant granules to the metering units. The rotary movement of metering units determines the dosage that is proportional to the forward speed; it is detected by the trailing land-

wheel. An electronic device, placed inside the tractor cabin, allow to enable or disable the solid fumigant application. Also in this case the fumigant, once distributed on the soil surface, is buried and mixed with soil by the rototiller action. The tilled soil is finally compacted throughout a mechanically driven compaction roll.

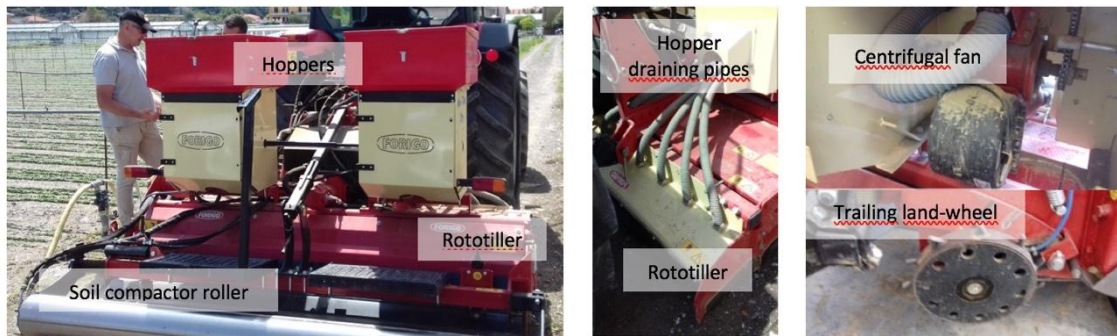

Figure 2. Solid fumigant applicator model FORIGO Mix Tiller Dry 35 – 230

Following the draft test protocol, contained in the current Spise advise, the pre-inspection and functional inspection were performed for both solid fumigant machines tested.

To simplify the data collections, “ad hoc” datasheet was created (Figure 3).

<p>Inspection of solid formulation fumigant application equipment</p> <p>Test station (workshop) _____</p> <p>Name of the inspector _____</p> <p>Owner's identity _____</p> <p>Owner's address _____</p> <p>Owner's signature _____</p> <p>Inspector's signature _____</p> <p>Date of inspection _____</p> <p style="text-align: center;">omissis</p>	<p>2 MACHINE DESCRIPTION</p> <p>Manufacturer: _____</p> <p>Model: _____</p> <p>Serial number or other identification: _____</p> <p>Year of construction: _____</p> <p>Drive: a) mounted [] b) trailed [] c) self-propelled [] d) hand operated</p> <p>Working width (m): _____</p> <p>Hoppers: Number _____ Volume (m³ – kg) _____</p> <p>Metering unit: a) Rotating cylinder [] b) Positive displacement rotor []</p> <p>If b)</p> <p>Speed of rotation governed by: trailing land-wheel [] electrical motor []</p> <p>Soil rototiller: a) yes [] b) no []</p> <p>Distribution set-up used _____</p> <p>Number of distributors (delivery system) _____</p> <p>Controller box: a) yes [] b) no []</p> <p>Speed sensor: a) yes [] b) no []</p> <p>GPS: a) yes [] b) no []</p> <p style="text-align: center;">omissis</p> <p>4 INSPECTION²</p> <p>4.1 Leakage</p> <p>Static - With the machine not working and parked on a level surface, there is no leakage from any part of the machine in all position of lift a) yes [] b) no []</p> <p>Dynamic - Working under normal working condition, there is no leakage of product from any part of the machine a) yes [] b) no []</p> <p>4.2 Metering unit</p> <p>4.2.1 Drive</p> <p>Drive of the metering unit(s) functions correctly: a) yes [] b) no []</p> <p>Electronic signal, GPS sensors and radar sensors (if present) function correctly: a) yes [] b) no []</p> <p>Drive ids-engagement) functions correctly (if fitted): a) yes [] b) no []</p> <p>4.2.2 Metering shaft alignment</p> <p>Drive shaft is in correct alignment and rotated easily without binding: a) yes [] b) no []</p> <p>4.2.3 Meter rotor condition</p> <p>The rotor is not damaged or dirty: a) yes [] b) no []</p> <p>All rotors and cassettes are fitted according to manufacturer's guidelines: a) yes [] b) no []</p> <p style="text-align: center;">omissis</p>
--	--

Figure 3. Extract of datasheet used during functional inspection.

The test protocol application procedure requires numerous qualitative evaluations (presence or absence of specific machine devices, function of that devices, etc.); the unique measurement required is the test on uniformity of distribution: “the measured output per output shall be within ±10% of the average output”.

So the trials of distribution uniformity were performed using rubber granules to simulate the solid fumigant product; this specific materials was chosen based on previously results obtained at Crop Protection Technology (DiSAFA, University of Torino) facilities testing the functional inspection of micro-granulator (Manzone et *al.*, in press). During all the trials the amount of rubber granules was enough to ensure the full coverage of granules supplier mechanical elements (Figure 4).



Figure 4. Rubber granules in the hoppers.

The distribution uniformity trials performed using OLIVER machine do not show any specific problem. A plastic bag was fixed at each hopper draining pipes output (12 in total) with the purpose to collect the rubber granules supplied (Figure 5). The machine supply system was manually activated through the revolution of cage roller (Figure 6). The distribution uniformity deriving from two different dosages were assessed: tested doses were determined by the activation of two pinion sizes (15 and 18 teeth pinion) and each trial duration was based on 10 completed revolutions of cage roller. Once finished the trials, the granules collected in each plastic bag were weighted to determine the precise amount supplied by each hopper draining pipes (Figure 5).



Figure 5. Rubber granules collection using plastic bags.



Figure 6. Manual rotation of the cage roller.

Different way was followed to measure distribution uniformity of FORIGO machine; the presence of air flow inside the hopper draining pipes did not allow to fix the plastic bag at they output. So, a horizontal patternator fitted by grooves, similar to that used to check the distribution uniformity of boom sprayers, was employed. The patternator was placed on the soil surface, directly under the machines that was lifted up 5 cm on the edge wall grooves level (Figure 7). The supplied dose was provided through the manually revolution of trailing land-wheel (Figure 6); also in this case the trail duration corresponds to 10 completed revolutions.



Figure 7. Rubber granules collection using horizontal patternator.

Results

For both pre-inspection and functional inspection phases where a visual control was required No problems were encountered during application of test protocol for both machines tested. In particular the application of pre-inspection, that requires only visual assessment of presence or absence of specific devices mounted on the machine, was easy and fast. Also the function qualitative evaluation, of above mentioned specific devices (metering unit characteristics, hopper/s, measuring system, pipes an hoses, delivery system, presence of leakage), did not show specifically trial difficulties.

Instead, some difficulties were encountered performing distribution uniformity trials.

The OLIVER machine show CV% results (for both tested dosages) little bit higher than 10% threshold fixed by test protocol. Given that the solid fumigant product supplied by the machine is left on the soil surface and buried/mixed with soil in a second step by machine rototiller, the uniformity of distribution acquires less importance because it has to be ensured the uniformity in the tilled/mixed soil. So, in this particular case, could be more suitable increase the CV% threshold from 10% to 15% because machines characterized by CV equal to 15% could guarantee the uniformity of distribution in the tilled/mixed soil.

The FORIGO machine showed the bad results in terms of distribution uniformity. Just the visual check of rubber granules collected by patternator grooves was enough to realize that the CV% not follow the threshold stated in the draft test protocol. In fact, some grooves contain two or three fold more than the lower amount collected (Figure 8): the distribution was not homogenous.

The deep differences of rubber granules amount collected by the grooves could be attributable to the uneven airflow rate, distributed by the centrifugal fan, inside hopper draining pipes; this results in different amount provided by the different hopper draining pipes. However, to provide an indication about distribution quality, the rubber granules amount supplied by each hopper was recorded; the two hoppers differed 5%.

The uniformity distribution problems encountered during trials were reported to the FORIGO manufacturer. The manufacturer was already aware about the uniformity distribution problems of the machine model inspected. Furthermore, the manufacturer confirmed that the problem is linked to the uniformity of distribution of fan airflow rate among the six hopper draining pipes. The fumigant product, once arrived in a unique collector, is divided between the six draining pipes, but only by the fan air flow. This means that a minimal physical variation (e.g. humidity, etc.) of fumigant product at the time of distribution is translated in deep differences between product amount supplied by each draining pipe resulting in uneven distribution uniformity. As reported by the manufacturer, high improvements were recently included in the last model of this solid fumigant applicator, modifying the collector with six elements that separate equally the fumigant products between the draining pipes; the fan is only intended to aid the transportation of product inside the draining pipes. It will be useful perform further trials using this last version of FORIGO fumigant applicator to check the improved distribution system.



Figure 8. Example of bad distribution obtained

Conclusions

The functional inspections were conducted on two representative models of solid fumigant applicators widespread in horticultural Italian farms; the main aspects emerged are:

- the draft protocol test provided by Spise advise is applicable and easy to follow;
- the rubber granules used to perform the uniformity distribution trials are suitable for these tests; furthermore, they are easy to recycle and no residuals inside the machine were detected at the end of trials;
- increase the CV threshold, of amount measured in each supplier and the mean of amounts supplied by the different suppliers, from 10 to 15%;
- the use of horizontal patternator with grooves, similar to that used for boom sprayers, is proposed as effective alternate test method to evaluate the distribution uniformity when rubber granules cannot be easily collected from delivering systems.

Acknowledgments

Authors wish to thank following farms:

- “Azienda Agraria Anfossi Società Agricola s.s” - via Paccini, 39 Fraz. Bastia, Albenga (SV)
anfossi@aziendaagrariaanfossi.it
- “Azienda Agricola Bracco Paolo” - Strada Piangrande 20/A Andora (SV)
www.facebook.com/aziendabraccopaolo

References

AA.VV. Regulation (EC) No 1107/2009 of the European Parliament and of the Council of 21 October 2009 concerning the placing of plant protection products on the market and repealing Council Directives 79/117/EEC and 91/414/EEC

Manzone M., Allochis D. and Balsari P. (in press). Research of an appropriate inert compound to use as an alternative to the granules of the plant protection products in the inspections of microgranulators – Spise 2018.

Requirements for plot trial equipment and how to control

Reinhard Friessleben

Bayer AG, Research & Development, Crop Science
Application Technology
40789 Monheim, Germany

Abstracts

Plot trial technology is an important element to guaranty high quality and reproducible trial results – this is relevant for all phases of the development of a Plant Protection Product. Beside proper calibration and homogenous distribution safety aspects play an important role. Calibration and homogenous distributions needs to be controlled before applying each individual trial. In a defined sequence preferable before the season starts these controls should be done and documented by an authorized quality assurance system.

Quality parameter should be:

- Distribution pattern controlled via patternator or alternatively individual nozzle flow rate
- Control of pressure gauges
- Control of leakage

Bayer is using the Herbst Sprayer test 1000.

Key words

Plot trial equipment; test requirements; calibration; sprayer inspection

Introduction and requirements for plot trial equipment

Small Plot research should be conducted on uniform experimental areas that minimize differences from soil and other not trial relevant parameters. Small plot research enhances the ability to detect true and repeatable differences among the experimental treatments. Another important requirement is that many treatments in a small area of land minimize land resource and chemical amount requirements.

Plot trial technologies have to follow the same principal application requirements like equipment used by farmers. In particular spray volume, droplet sizes, direction of the spray have to be as close as possible to farmers practice. One of the challenges is the simulation of higher speeds. However if spray volume and droplet sizes are tested in a relevant range, application speed should not be such a relevant factor for plot trial methodology. Nozzle manufacturers are offering various options to represent different spray volumes and droplet sizes as well usable for plot sprayer.

Plot trial methodology in research and development of Plant Protection Products (PPP) is based on long years' experience, Standard Operating Procedures (SOP's) and specific designed field trial equipment. For these application equipment used during the development of plant protection products following basic requirements needs to be analyzed and as precise as possible to be defined such as:

- Ability to apply small plots – plot size to be depending on crop, trial questions,
- Precision in distribution and calibration of PPP
- Reproducibility of spray operations
- Standardization
- comparability with farmers practice
- Documentation

Technical details need to be taken into consideration to fulfil plot trial officers specific requirements such as:

- high safety standards
- Technical rest liquid
- Cleaning processes
- Transportation limitations

Normally, small sprayers spray booms (spray booms sprayers developed for small plots) are used in many different trial types. By this, spray booms sprayers or atomizers are meant which are carried, pushed or pulled by the field trial officer, such as single nozzle apparatuses, spray booms which are carried or mounted on a frame and others.

The apparatuses can be motor-driven or operated using compressed-air. Additionally equipment can be equipped with a fan in particular for the application in high growing crops.

How to calibrate and control field trial equipment

One of the most essential steps regarding the conduct of field studies is the calculation of the product quantity which is to be applied on the trial area and the calculation of the quantity of spray liquid. This includes calculating the net and gross plot area, the starting and the rest liquid.

Here, calculation depends on both the application method (such as spraying, dressing etc.) and the reference (such as surface, band, individual plant etc.). Moreover, as far as these methods of application are concerned there are different references for each of them on which calculations are based. The respective reference is indicated in the study protocol.

The calibration/control of both small apparatuses and equipment which is used in the practice (farm-scale equipment) may be divided into the following steps comprising different tasks as far as a spray boom will be concerned:

- Measuring flow rate of the individual nozzles
- Measuring nozzle distance
- Measuring application speed

For the recording of calibration and calculation data specific documentation tools are available and will be consequently used by the field trial officers.

General check and calibration of equipment prior to the beginning of the season

Calibrations prior to the beginning of the season have to be carried out by a patternator test or at least the determination of the single nozzle flow rate for each equipment combination/water rate (nozzle type). They are not necessary; if the alteration of the water rate is only due to a change in pressure (only one pressure has to be set for annual checking).

This implies that for the pressure setting which was not inspected, the nozzle flow rate has to be measured twice right before the application.

Prior to the annual start of the field part of a trial, the application equipment has to be maintained and checked. This inspection may be carried out either by the field trial officer himself or by an internal/external quality assurance system. If necessary, essential parts of the application apparatus, such as

- manometer
- pressure supply
- nozzles

have to be replaced. If this is finalized the inspection has to be repeated. All operations which were carried out have to be documented.

Sprayer inspection procedures at Bayer AG – Crop Science with focus on equipment used for arable crops/vegetables and other horizontal spray boom application procedures

Booms will be inspected in an annual cycle using the Sprayer Test 1000 manufactured by Ernst Herbst Prüftechnik e.K. (picture 1). This is a mobile Electronic Sprayer Test Equipment for testing the distribution of agricultural field sprayer. This inspection will be recorded electronically. The connection between the testing device and the computer is radio controlled - wireless. The dimensions of the test device could be confirmed as practically usable even for a relative small spray boom length of maximum 3 m. These parameters are: groove width = 100 mm; groove depth = 100mm; 1500 table length. The existing software for sprayer inspection will be used – only adaptations for specific printout of the test protocol had been programmed. The complete spray width will be measured and recorded (picture 2). The positioning of the spray boom is horizontally adjusted and the spray boom distance to the grooves reflects the recommended distance during usage in the field. The test unit will normally be operated autonomously from the standard liquid bottles. Instead of these bottles a constant water supply is used, controlled by a pressure regulator and by a certified pressure gauge. It's important to control these booms at standard operating pressures. Due to the specific pipe dimensions pressure losses are relevant for plot trial spray booms. This procedure implies that booms and adjacent combined equipment components like pressurized bottles, connection pipes, trolleys, backpacks and others will be controlled separately. Technical deficiencies at the spray boom which might have an impact on horizontal distribution pattern and safety parameters are in the focus of these inspections such as:

- Leakages at membranes , valves and tubes and pipes
- Existence and functionality of filters
- Nozzle filters with different size and mesh number
- Nozzle filters with different functionalities (e.g. ball strain filters)
- Positioning of nozzles in particular after maintenance activities. It's recommended signaling a number at each nozzle to guaranty constant positioning
- Replace worn nozzles
- Utilize uniform nozzles at each spray boom (, distance, manufacturer, material, calibre, spray angle)
- Deformation of spray boom
- Distance to the target area

Other general requirements for plot trial spray booms

- Liquid supply should be in the centre of the spray boom
- Preferred working width 2 – 3m
- Preferred nozzle distance 50cm; 25cm possible
- Compact injector nozzles (e.g. AirMix; AI XR; IDK) will be more used as a standard in field trial operations
- The usage of specific asymmetric end nozzles needs to be finally checked, tested and approved

Conclusion

Plot trial technology for the application of Plant Protection products is important to guarantee high quality and reproducible test results. The regular inspection of these equipment is in the company

interest and should follow standardized procedures. Inspection of spray equipment needs to be documented. Beside safety aspects, leakage, calibration and homogeneity of spray liquid distribution should be in the focus of these tests. The Bayer AG had long years' experience using JKI certified patternator and in the documentation of test results.



Picture 1: plot spray boom patternator test system used at Bayer AG

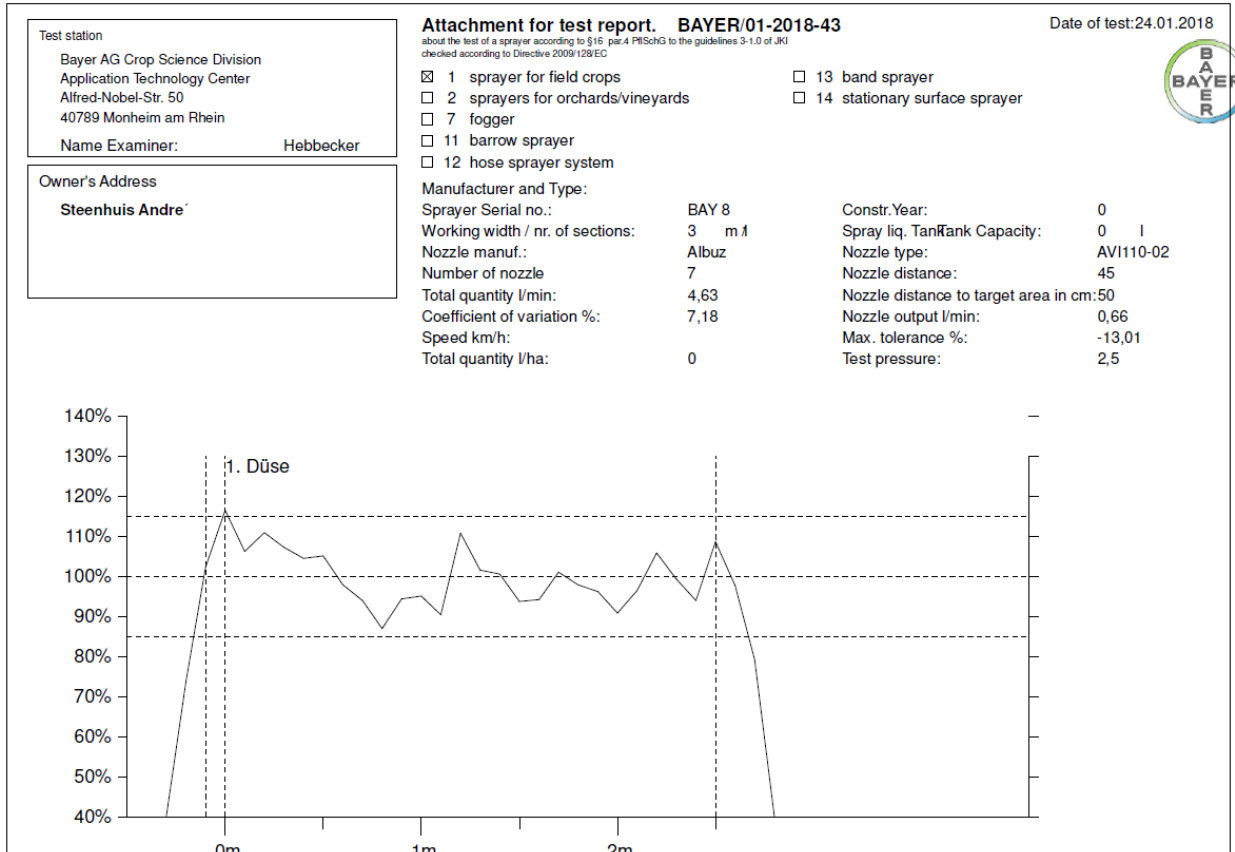

Picture 2: example of a test report of a 3 m boom

The effect of the type of sprayer bodies on the obtained coefficient of variation of sprayed liquid deposition

Stanisław Parafiniuk¹, Marek Milanowski¹, Witold Kowalik¹, Milan Koszel¹, Marek Kopacki²

¹ Department of Machine Operation and Management of Productive Process, University of Life Science in Lublin, ul. Głęboka 28, 20-612 Lublin, Poland.

² Department of Plant Protection, University of Life Science in Lublin, ul. Leszczyńskiego 7, 20-069 Lublin, Poland.

Summary

In this work, the study results of retention uniformity of sprayed liquid deposition obtained from three kinds of nozzles mounted in sprayer bodies of various constructions were presented. For the tests, a five-spray body with a rotation axis of a spigot parallel to the sprayed surface, a three-spray body with a retention axis perpendicular to the sprayed surface and one-spray body were used. Changes in individual spraying nozzles were done by three operators. It was stated that the biggest differences in repeatability and reproducibility of adjustments were noted for five-spray bodies, however, minimum changes not exceeding the value of one percentage point were noted for single bodies. For triple bodies repeatability of obtained CV regardless of mounted nozzles changed maximum up to 1,5 percentage point and reproducibility of measurement changed from 0,5 to 0,8 percentage point.

Key words: field sprayer, sprayers periodic testing, atomizer body, coefficient of variation

Introduction

In recent years farmers benefited from supporting programs aimed mainly at farms modernization. The farms were retrofitted with necessary equipment and the old worn-out equipment was replaced with new. Therefore, a lot of agricultural sprayers were bought, often equipped very well in different devices improving, above all, security of its service and quality of performed plant protection treatment. Field sprayers booms were equipped with bodies in which 3 to 5 different nozzles can be mounted. Such a solution enables a fast change of the spraying nozzle suitable for given conditions and recommendations concerning plant spraying. Conditions in which agricultural spraying is done play a very essential role. Bench tests on a patternator do not reflect uniformity of liquid depositing in field conditions. Changes of the angle of the field beam setting as well its horizontal and vertical movements influence the change of uniformity of liquid deposition (Nowakowski 2007, Szewczyk 2001). Work has been done to evaluate retention uniformity of sprayed liquid deposition in settings reflecting field conditions (Ludwik and Pietrzyk 2013).

The introduced Directive 2009/128/EC of 21 October 2009 refers to rational and safe pesticides application in agriculture. Pesticides should be applied with approved equipment. According to the Ministry of Agriculture of Poland concerning periodic testing of agricultural sprayers, from 2020, testing will be carried out on electronic or manual patternators as a criterion of testing spraying uniformity (Announcement of the Ministry of Agriculture 2016, Dz. U. poz. 924, - Official Law Journal, item 924). Uniformity of sprayed liquid deposition should be tested for all sets of nozzles mounted on the spraying field beam. Uniformity of sprayed liquid deposition will have to be defined as many times as many sets of spraying nozzles are used (PN-EN ISO 16122-2:2015-07).

Research objective

The objective of the study is to check if the kind of a multi-spray body influences the obtained coefficient of variance (CV), non-uniformity of a sprayed liquid deposition after switching in the position of work for each set of nozzles mounted in the body.

Material and methods

The studies were carried out on a test-bench equipped with a field sprayer of vessel capacity of 300 l and working width of the beam 12m. The sprayer is equipped with rotodynamic pump driven electrically and an electric valve controlling the pressure and flow. The sprayer field beam of a “wet” type was equipped alternately with three kinds of spray bodies; Case A (five-spray body), Case B (three-spray body), Case C (single body). All bodies were equipped with an anti-drop membrane valve. The studies were carried out on three types of spraying nozzles: I-Nozzles with ceramic insertion Agroplast 120 04 C, II –Ejector Nozzles with ceramic insertion Agroplast 6MS 04 C, III-Ejector nozzles HYPP DDB 04. The nozzles were numerated from 1 to 24 and mounted in the sprayer bodies from the left to the right side with numbers to the back of the sprayer. The change of the type of the nozzle for testing was done by three operators: X, Y, Z. Each operator changed nozzles in simple bodies and rotated the nozzle outlet on the position of work in the case of three-spray body and five-spray body and mounted nozzles in the case of one-spray body. For each nozzle type, measurement of CV was executed and then switched on another nozzle type. For each type of nozzles three measurements were done. Measurement of non-uniformity coefficient CV was done with the use of an electronic patternator (Herbst, Spray 2000), of 2m working width and profile width of groves of the test table equalling 100 mm. Repeatability and reproducibility of work adjustments of individual kinds of nozzles were analysed assuming:

- repeatability is a variability for a given measurement adjusted several times by the same operator in a short period of time
- reproducibility is a variability of a given measurement adjusted several times by different operators in a long period of time.

The test was done at working pressure of 0,3 MPa.

For the evaluation of CV, a spreadsheet program and statistical software written in R program were used (Parafiniuk et al. 2011; Parafiniuk and Tarasińska 2013).

Results

In the first variant (Case A- five-spray body) the measurement of uniformity of sprayed liquid deposition was done for the five-spray body in which the rotation axis is parallel to the sprayed surface. Each out of three operators switched the outlets position of work for three kinds of nozzles. The test results are presented in Table 1.

Table 1 Values of coefficient of variation (CV) for nozzles mounted in case A (five-spray body).

		Case A (five-spray body)			
Nozzle	Operator	measurement 1	measurement 2	measurement 3	Average
I	X	11,9	10,1	10,4	10,8
	Y	12,1	9,2	8,5	9,9
	Z	8,3	9,2	9,5	9,0
II	X	11,1	11,6	13,1	11,9
	Y	13,7	13,8	10,6	12,7
	Z	7,9	8,1	7,1	7,7
III	X	9,9	7,9	8,3	8,7
	Y	8,1	8,5	7,4	8,0

	Z	8,1	8,3	8,7	8,4
--	---	-----	-----	-----	-----

Analysing the obtained results it can be stated that obtained CV of sprayed liquid deposition is different for each nozzle type. The highest CV was obtained by nozzles of type II, however, the lowest value of CV was obtained was also found for nozzle type II, due to operator's capability. This difference was also seen in the other nozzle types. More particularly, taking into consideration that adjustments of spraying nozzles was done by three operators (X, Y, Z), it was observed that for each nozzle type different CV values were obtained, whereas the best repeatability and reproducibility of measurement were obtained by the operator Z regardless of the kind of the nozzle set under testing. However, the biggest discrepancy of obtained results was stated for the operator Y who had the lowest repeatability of adjustments and obtained high fluctuation of CV results between the three nozzle types.

In the second variant of the study, (Case B- three-spray body), whose rotation axis is perpendicular to the sprayed surface, were mounted on the sprayer field beam. Obtained results of CV are presented in Table 2.

Table 2 Values of coefficient of variation (CV) for nozzles mounted in case B (three-spray body).

		Case B (three-spray body)			
Nozzle	Operator	measurement 1	measurement 2	measurement 3	Average
I	X	9,2	10,1	9,1	9,5
	Y	9,4	9,1	8,8	9,1
	Z	9,7	9,2	9,3	9,4
II	X	13,1	12,2	12,3	12,5
	Y	13,6	11,9	11,5	12,3
	Z	13,1	11,6	13,1	12,6
III	X	9,2	7,9	7,7	8,2
	Y	7,9	8,2	8,5	8,2
	Z	8,4	7,9	9,3	8,5

In this variant the largest CV was obtained for measurements of nozzles of type II, the minimum value of this coefficient was 11,5% and the biggest was 13,1%. For nozzle type I, the minimum value of CV was 8,8% and the maximum 10,1%. However, for nozzles of type III the minimum value of obtained CV equalled 7,7%, and maximum 9,2%. In addition, in this case none of the operators changing the spraying nozzles obtained the repeatable test result. The biggest difference in repeatability of adjustments was 1,5 percent point for the operator Z. Reproducibility obtained by individual operators was also different for each operator and fluctuated from 0,5 to 1,6 percent point.

In the third variant (Case C – single body) each operator mounted nozzles in hubcaps and put them on spigots of the bodies at the same order from the left to the right side as they were mounted in multi-spray bodies. Results of these measurements are presented in Table 3.

The highest values of CV was noted for nozzles of type I for which CV fluctuated from 7,7 to 8,5%. However, CV for nozzles of type II and III were at the similar level and values from 7,0 to 7,9% were obtained. In all cases of measurements repeatability of obtained CV did not exceed the value of 1%, however, reproducibility of adjustments by different operators was at the similar level and was from 0,2 to 0,4%.

Table 3 Values of coefficient of variation (CV) for nozzles mounted in case C (single-spray body).

		Case C (single body)			
Nozzle	Operator	measurement 1	measurement 2	measurement 3	Average
I	X	8,1	8,3	7,8	8,1
	Y	7,9	8,3	8,5	8,2
	Z	7,7	8,1	8,2	8,0
II	X	7,6	7,5	7,8	7,6
	Y	7,4	7,7	7,3	7,5
	Z	7,5	7,7	7,8	7,6
III	X	7,3	7,6	7,8	7,6
	Y	7,0	7,8	7,9	7,6
	Z	7,2	7,7	7,5	7,5

It was seen that case A (five-spray body) had the biggest differences of repeatability and reproducibility of obtained coefficient CV were noticed.

Summary

Performed tests showed that there are sizeable differences concerning repeatability and reproducibility. In this type of tests the variations depend on abilities and accuracy of the operator doing adjustments (Sawa et al 2010, Huyghebaert and Planchon 2009). The tests also showed that the multi-spray body construction affects the obtained CV results of sprayed liquid deposition. Precision of bodies' manufacturing can be the reason for systematic mistakes which influence the value of obtained CV. Not in all multi-spray bodies there is precise positioning of the nozzle outlet to the sprayed surface. The biggest observed repeatability and reproducibility of adjustments were noted in bodies with the parallel rotation axis to the sprayed surface. The bodies with the perpendicular rotation axis to the sprayed surface have the nozzle outlet placed much more precisely. The most precisely situated nozzle outlet is in single bodies but this type of body requires considerable work output and, most of all, the time needed for changing the spraying nozzle. Similar variability of obtained CV results was noted during the tests of nozzle sets with the automatic device for complex test of agricultural nozzles (Parafiniuk et al 2011).

Comparative tests of distribution of uniformity of sprayed liquid deposition obtained from the automatic device for measuring distribution from single nozzles and test of the same sets of nozzles in the laboratory conditions gave also various results of CV equalling from several to dozen or so percent points (Parafiniuk and Tarasińska 2013). To sum up, it can be stated that both a technical state of used nozzles on the field sprayer boom and precision of making sprayer bodies influence the obtained CV of sprayed liquid deposition. In special cases, in spite of mounted new accessories of the sprayer field beam, working and unworn spraying nozzles, the measurement result may oscillate at the limits of admission or disqualification of the equipment for pesticide application.

References

1. Huyghebaert B. Planchon V. (2009). Repeatability and intra-lab reproducibility of the nozzles spraypattern measurement. IV International Scientific Symposium. Farm Machinery and Process Management in Sustainable Agriculture. Lublin. Poland 19-20 November. s. 35-36.

2. Nowakowski, T. (2007). Współdziałanie wybranych parametrów oprysku na współczynnik zmienności rozkładu poprzecznego cieczy. *Inżynieria Rolnicza*, 3(91), 135-141.
3. [Lodwik D., Pietrzyk J. \(2013\). Automated test station for transverse spray non-uniformity. *J. res. appl. agric. eng.*, vol. 58 \(2\) nr 2 s. 103-106.](#)
4. Obwieszczenie Ministra Rolnictwa (2016). Dz. U. poz. 924 w sprawie ogłoszenia jednolitego tekstu rozporządzenia Ministra Rolnictwa i Rozwoju Wsi w sprawie potwierdzania sprawności technicznej sprzętu przeznaczonego do stosowania środków ochrony roślin.
5. WE, 2009. Dyrektywa Parlamentu Europejskiego i Rady 2009/128/WE z dnia 21 października 2009r. ustanawiająca ramy wspólnotowego działania na rzecz zrównoważonego stosowania pestycydów. Dz. U. UE L 309/71, 24.11.2009.
6. Parafiniuk, S., Sawa, J., Huyghebaert, B. (2011) . Ocena stanu technicznego belki polowej opryskiwacza metodą badania pojedynczych rozpylaczy. *Inżynieria Rolnicza*, 5(130), 207-214.
7. Parafiniuk S. Tarasińska J. (2013). Work simulation of the sprayer field beam with the use of R program. *Journal of Central European Agriculture*. 14 (3). s.1019–1028.
8. Parafiniuk S. 2013. Konwersja wyników badań pojedynczych rozpylaczy do identyfikacji pracy belki polowej opryskiwacza. Wydawnictwo Libropolis Lublin. ss. 102. ISBN 978-83-63761-16-5.
9. Sawa, J., Parafiniuk, S., Tarasińska, J., Huyghebaert, B. (2010) . Zdatność procesu wykonania zabiegu ochrony roślin opryskiwaczami polowymi. *Inżynieria Rolnicza*, 4(122), 199-204.
10. PN-EN ISO 16122-2: 2015-07. Maszyny rolnicze i leśne -- Badania kontrolne opryskiwaczy w sferze użytkowania -- Część 2: Opryskiwacze z belką poziomą.
11. Szewczyk A. (2001). Wpływ ustawienia rozpylaczy na belce polowej na rozkład poprzeczny i stopień pokrycia opryskiwanej powierzchni. „Racjonalna Technika Ochrony Roślin”. Skierniewice 23-24 październik, s. 101-110.

Wireless flow-sensor to inspect spray rate controllers

J. Declercq¹, E. Matthys¹, G. Defays², B. Huyghebaert², D. Nuyttens¹

¹ Institute for Agricultural and Fisheries Research (ILVO), Technology & Food Science Unit - Agricultural Engineering – Burg. Van Gansberghelaan 115 – 9820 Merelbeke – BELGIUM. Contact: johan.declercq@ilvo.vlaanderen.be

² Agricultural Research Centre (CRA-W) – Agricultural Engineering Department Chée de Namur 146 – 5030 Gembloux – BELGIUM

Summary

In Belgium, the mandatory inspection of sprayers was already started up in 1996 and the 8th inspection cycle (2017-2018-2019) is currently running. The inspection of sprayers is performed by official and mobile teams ruled by two inspection authorities and the management is done by the Federal Ministry for Consumer Protection, Public Health and the Environment (FAVV). In the Flemish region the inspection is delegated to the Institute for Agricultural and Fisheries Research (ILVO).

In the past decade the number of field crop sprayers equipped with a spray rate controller increased significantly. In the first inspection cycle (1996-1998), only 4.58% of the field crop sprayers were equipped with a spray rate controller in Flanders. In the 7th inspection cycle (2014-2016), this percentage increased significantly to 26.92%.

As the original inspection method for spray rate controllers showed some lacks and was time consuming, ILVO developed a simple and reliable method to test rate controllers on field crop and orchard sprayers.

Key words: sprayers, inspection, rate controller, flow

Introduction

Since 1995 sprayer inspection is mandatory in Belgium which makes it one of the forerunners in Europe. The items that need to be inspected and the requirements are completely described in the Belgian legislation. This legislation also describes the inspection protocol for a limited number of items, but for most items there is no detailed description of the inspection methodology.

Consequently, inspection authorities need to develop procedures describing in detail how to perform the inspection. This is also one of the reasons why Belgian inspection authorities need to have an ISO17020 accreditation so that inspection methods are traceable and transparent.

One of the items to be inspected are spray rate controllers on sprayers. Due to the increasing number of sprayers fitted with a rate controller, ILVO felt the need to develop a time saving and accurate inspection method for spray rate controllers.

Belgian law: spray rate controllers inspection limits

The inspection of spray rate controllers is described as follows in the Belgian legislation: “Mechanical and electronic regulation systems with a flow equal with the driving speed and also the electronic indication from the sprayed volume per hectare are inspected (respectively D.P.A.m and D.P.A.e systems). The driving speed and the sprayed amount during a certain period are determined. The amount that is sprayed in reality is calculated and compared with the set values on the rate controller. When the difference between the actual amount sprayed and the set value on the rate controller is more than 10%, the sprayer is rejected.”

Hence, there is no description on how to inspect this item and as a consequence, inspection authorities need to set up an inspection protocol themselves.

Original inspection method for spray rate controllers (until 2009)

To check application rate and sprayer speed, the following method was used till 2009: Two marking points were placed with a distance of 100 m in between with at least 10 to 20 m of free "run in" track before the start of the 100 m track. Farmers/fruit-growers were asked to program their usual application rate and to start a first short run (e.g. about 20 m) at a constant speed. During this run, the rate controller could adjust the control valve to obtain the desired application rate. After this run, the farmer was asked to stop spraying by shutting of the main valve and the inspector placed 3 spray test sacs underneath three nozzles (Figure 2).



Figure 2: Spraytest bags

In a second run, the driver was asked to start driving again at constant speed and to open the main valve from the sprayer just after passing the first marking point and at the same moment the inspector started the stopwatch. When finishing the 100 m track, spraying and stopwatch were stopped. The spraytest bags were removed and the contents of the bags were poured into a measuring cup with accurate scaling. The mean value was calculated and all the measured values were putted into the inspection software to calculate the actual spray rate and compare it with the value set in the spray rate controller.

Computer	Gemeten waarden	Snelheid (km/h)	Volume (l/ha)
Afgelegde afstand (m)	50	Geprogrammeerde snelheid	6,8
Chronometer tijd (sec)	27	Reele snelheid	6,67
Liter per dop over afgelegde afstand (l)	0,18	Afwijking (%)	98,04
Aantal doppen (stuks)	30	Geprogrammeerde volume	300
Slip (%)	0	Reele volume	276,92
Afstand tussen de boomrijen (m)	3,9	Afwijking (%)	92,31

Figure 3: Screen shot from the spray rate calculation program as part of the inspection software

As one can see this method has a lot of disadvantages and also involves some inaccuracies. Firstly, when restarting and re-opening the main valve at the first marking point the rate controller has

(re)regulate some meters to obtain the desired rate. In addition, the driver needs to start and stop spraying exactly at the moment of passing the marking points and, at the same moment, he has to pay full attention on maintaining the desired speed. Finally, there is also the inaccuracy of the inspector to start-stop the stopwatch, and read out the measuring cup. To compensate those inaccuracies, a long test track is used (100m+20m). With a consequence that it is difficult to find suitable locations to perform this test.

New inspection method for spray rate controllers in Flanders: version 1 (from 2010-2017)

To overcome the problems involved with the original inspection method using the spraytest bags and the stopwatch, a new testing device was developed at ILVO. The main goal was to reduce the length of the test track and to decrease test time while improving measuring accuracy. Furthermore the test device needed to be easy to use even for a “non professional”.

To obtain these objectives, ILVO developed an accurate, reliable and online measuring method. In this way, the main inaccuracy caused by reopening the main valve at the first marking point and rate (re)regulation during the first meters of the test strip is eliminated.

As already mentioned, in Belgium nozzle flow is measured separately on a nozzle test bench during the inspection so the average nozzle flow of a nozzle set is known. Out of the measured nozzle set, a pre-measured nozzle with a flow rate close to the average flow rate is selected. So measuring the flow through this nozzle when mounted on the spray boom in combination with a stopwatch measurement when driving a fixed test track, makes it possible to determine the spray volume rate in an accurate way.

The first version of the measuring device consists of a flowmeter attached between a nozzle holder on the sprayer and the pre-measured nozzle (Figure 4). The flowmeter is wired by a 10 m long cable to a spray rate/volume read out unit by a double pole toggle switch which can interrupt the pulses from the flowmeter and also commands the stopwatch. So when passing the start marking on the test track the toggle switch is activated and flow and stopwatch start counting. At the last marking on the test track the toggle switch is deactivated and total flow and timing can be read to determine actual speed and flow rate.

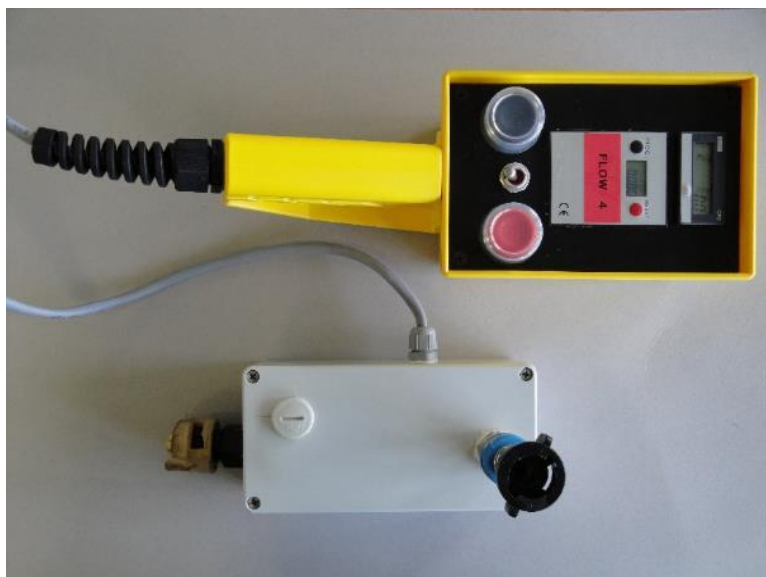

Figure 4: Spray rate controller inspection equipment (version 1)

New inspection method for spray rate controllers in Flanders version 2 (from 2018).

Despite the fact that the first version provided good work, there are some weak points. At first there is the long connection cable that has to be wired each test. In addition, some calculations are needed to

calculate the actual speed and spray volume. Those are the main reasons why ILVO searched for a wireless solution in combination with an app installed on a tablet or laptop.

After some research, a flowmeter readout module with integrated bluetooth was developed in house. The module reads out the pulses from the flowmeter and sends the values over bluetooth to a tablet. The values that are received are displayed and recalculated on the tablet with a dedicated app. The app has a start/stop button that replaces the toggle switch from the first version. During the test, the app shows the current sprayed volume and at the end of the test the sprayed volume and the actual speed are calculated. So after finishing the test, the inspector can evaluate the test immediately.

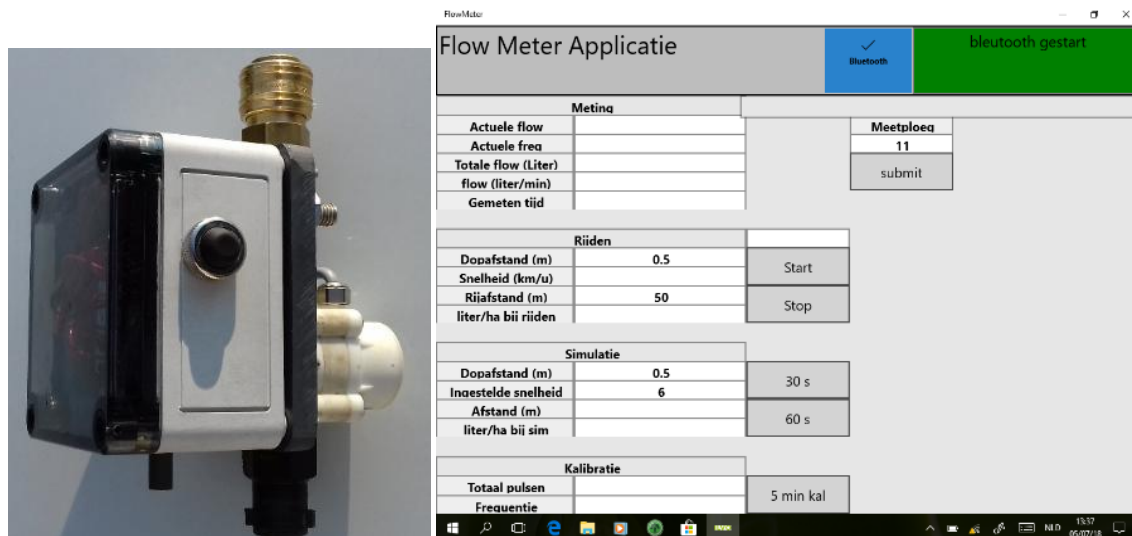

Figure 5: Spray rate controller (version 2) - Flowsensor and app screenshot

The flowsensor is calibrated in the accredited ILVO Spray Tech Lab (ISO17025) at a flowrate range from 0.75 to 2.5 l/min with a calibration accuracy of +/- 1% (ISO 16122 asks +/- 2%). So it is possible to test sprayers equipped with ISO02 up to ISO06 nozzles, used by 99% of the Flemish farmers.

The test procedure consists of different steps:

At first two marking points are placed but instead of 100 m used in the original method, 50 m is sufficient and even distances of 30 m give satisfying results on condition that the "run in" of the test track is long enough to obtain a stable rate and speed.

The farmer/fruit-grower is asked to program a spray application rate that lies in the range of 0.75 l/min to 2.5 l/min per nozzle.

The inspector mounts the flowsensor with the pre-measured nozzle on the spray boom and takes place in the tractor/sprayer cab with the tablet. The farmer/fruit grower is asked to start spraying at a constant speed.

When passing the first marking point the measurement is started up "on the go" by pushing the start button in the app. During spraying the real time flow, the actual flow and the stopwatch time are displayed simultaneously.

When passing the second marking point the stop button in the app is pushed and the farmer/fruit grower is asked to stop spraying.

Beside showing the total nozzle flow and the stopwatch time, the app also directly calculates the actual sprayrate in liters per ha and the exact driving speed. So the inspector can immediately evaluate the performed test.

Conclusions

As one can see the new equipment makes the spray controller test procedure less time consuming and easier with a higher accuracy.

The driver can completely concentrate on driving and maintaining a constant speed. There is also no need to stop and restart after positioning the spraytest bags. This results in a more accurate measurement and time savings even with shorter test tracks. Also important to mention is that while performing the test the real time flow rate can be read. So while driving, the inspector can already determine if the spray rate controller works correct. Furthermore after testing, the actual sprayed volume and drive speed can be read out directly with a known accuracy. Moreover, the device can also be used to measure the real time nozzle flow rate of all nozzles on the sprayer, although originally it was not designed for this purpose.

References

- BRAEKMAN P., HUYGHEBAERT B., SONCK B. (2004) The Belgian way of organising a compulsory inspection of sprayers. I European Workshop, Standardized Procedure for Inspection of Sprayers in Europe/SPISE, Braunschweig– Germany 5 pp.
- HUYGHEBAERT B., MOSTADE O., BRAEKMAN P. (2004). Overview of the Sprayer Inspection in Belgium. I European Workshop, Standardized Procedure for Inspection of Sprayers in Europe/SPISE, Braunschweig– Germany 5 pp.
- DECLERCQ J., HUYGHEBAERT B., NUYTTENS D.(2009). An overview of the compulsory inspection of sprayers in Belgium. III European Workshop, Standardized Procedure for Inspection of Sprayers in Europe/SPISE, Brno, 1pp.
- DECLERCQ J., NUYTTENS D.(2012). Inspection method for spray rate controllers in Flanders (Belgium) IV European Workshop, Standardized Procedure for Inspection of Sprayers in Europe/SPISE, Lana 5 pp.
- ISO 17020 (2012). General criteria for the operation of various types of bodies performing inspection.
- ISO 16122-2 (2015). Agricultural and forestry machinery – Inspection of sprayers in use -General criteria for the operation of various types of bodies performing inspection.
- ISO 17025 (2017). General requirements for the competence and calibration laboratories.

New challenges about pesticide application equipment in Serbia: Usage of new nozzles types for better deposition and coverage.

Višacki Vladimir¹, Sedlar Aleksandar¹, Bugarin Rajko¹, Radić Petar², Turan Jan¹, Ponjičan Ondrej¹, Ivanišević Mladen¹

¹University of Novi Sad, Faculty of Agriculture, Department of Agricultural Engineering, Education Developmental Center for Pesticide Application Equipment, Sq. D. Obradovića 8, 21000 Novi Sad, Serbia

²Cooperative Union of Vojvodina, Blvd M. Pupina 25, 21000 Novi Sad, Serbia

Summary

Unofficial results of inspections of pesticide application equipment stands out several parts of field crop sprayers. One of them are nozzles. Many producers (more then 90%) have bad nozzles. These elements are not in accordance with standard which means they have bigger flow rate and uneven horizontal distribution. Farmers don't change anything on field crop sprayers from the time of buying. For them there is only one nozzle type for all kind of pesticide applications in different crops. As nozzles plays major roll in coverage and deposition, new problem was indentified due to worn nozzles. New problem in Serbia became weeds and their herbicide resistance.

If one field has to be sprayed up to nine times, it is obviously that there is a problem. Using appropriate herbicides in acceptable weather conditions don't lead to weeds eradication. During many field tests and sprayers inspections, suspicions were confirmed. Main reason of presence of weeds resistance is exploitation factors and nozzles. It is better to say, many years of using non appropriate nozzles in combinations of unacceptable exploitation factors lead to poor and unacceptable coverage and total depositions on weeds. For Serbian farmers there is only one nozzle, T nozzle. Several years ago, for richer farmers air injector nozzle with single flat fan known as anti wind nozzle became a star. They are using this nozzle for everything as poor farmers using single flat fan T nozzle. Additionally, low pressure between 2 bar and 3 bars enlarge the effect and small amount of droplets doesn't make good coverage especially in high speed as 10 to 15 km/h. In combinations of mentioned speed and pressure, nozzles deposition was between 23 to 37% of total amount of pesticide. Remaining amount was drifted to non target, soil or evaporated.

Due to that, Faculty of Agriculture in Novi Sad and Educational developing centre of PAE started with field testing of new brand nozzles, double flat fan low drift and air injector double flat fan nozzles. Research were conducted in open fields in many crops such as, corn, soya, sunflower, wheat by changing of nozzles, traveling speed and working pressure. At any time, suggested pesticide dosage was used. Combinations of aforementioned factors gave as results better coverage and bigger deposit on weeds. Due to higher pressure more droplets cause better coverage, less drift due to anti drift nozzles and air injector nozzles, resulting as bigger deposit up to 78%.

Key words: weeds, nozzles, coverage, pressure, deposit

Introduction

Economic agricultural production can not be imagined without use of plant protection products. The use of pesticides reduces the population or suppresses weeds, insects and pests. In recent years, the climate in Serbia has been favorable to the intensive growth of weeds and the development of various insects and diseases. Increased air humidity of more than 70% and temperatures up to 35 °C during the day and tropical nights are the main characteristics of spring and summer months in Serbia. Additionally, short splashes also favor development of diseases and pests as well as weeds. Faced with such weather conditions, farmers are increasingly applying different pesticides in wheat, soybean or corn, and application of pesticides in sugar beets is every week.

Additional pressure on farmers is a very short period of days suitable for the application of pesticides as well as large agricultural areas under different cultures. For this reason, in order to protect all surfaces,

the application of pesticides is carried out at high speeds of movement between 10 and 15 km/h. Self-propelled machines range from 15 km/h to 23 km/h, which is extremely fast. As the operator's training is at an extremely low level on the basic principles of efficient and economical application of pesticides in the framework of sustainable agricultural production, often exploitation parameters are very unsuitable. At the given speeds of movement, the same nozzles are used as in the previous application. By increasing the working speed, working pressure is increased in order to satisfy the given norm, which is usually between 150 and 180 l/ha. So the operating pressure very often comes to the level of 8 bar and sometimes 10 bar. Valve locks and breaks of working fluid lines are everyday situation in the field. The second indication is much more problematic than the first one. It is about the amount of pesticide deposits, or the amount of active substance that reach the target surface. The quantity of active substance, ie the amount of deposits, is in direct correlation with the efficiency of the pesticide application. With increasing speed, there is an increase in air turbulence behind the sprayer, and often this turbulence reaches a speed of 7 m/s, which is beyond the acceptable drift limits for the most common nozzles with one flat fan. The droplet spectrum of a spray nozzles with a flat fan at a pressure of up to 5 or 6 bar can only be such that the droplets are very fine. Very fine droplets of a medium volume diameter below 150 µm are ideal for drifting with wind and evaporative drift.

It is precisely the drift of use of bad and inadequate nozzles in Serbia. Vieira et al. (2018) states that the use of a single jet nozzles creates drift up to almost 15 m at a treatment norm of 150 l/ha. The satisfactory reduction of the drift is mentioned by the author in his experiment using corn as a barrier, but also by using an injector spray nozzle with a single reflective jet. Cody et al. (2018) obtained results for other types of nozzles, flat spray nozzle, one air injector nozzle, single air injector with single and two flat fan. The test was carried out in corn and soybean during herbicide application. The results of the test related to the amount of deposits showed that the largest deposit was achieved with the use of a single jet spray nozzle in a soybean (28%). In the corn, the best deposit was obtained using T nozzles (50%). Deposition across the row, beginning in-between the row crop and ending in the row of crop was 44%, 18%, and 8% for soybean and 59%, 50%, and 36% for corn. For both crops, more than half of the herbicide application was captured in the crop canopy. Proper nozzle selection for canopy type can increase herbicide penetration and increase the carrier volume will increase penetration proportionally conclude Cody et al. (2018). Given claims are related to Forester et al. (2010) which describe behavior of droplets of many used nozzles. Forest et al. (2012, 2013), in its further research, publishes a model that should predict the penetration of working fluid and the amount of deposits using different sprays in different agricultural cultures.

Material and method of work

The Educational Development Center for Pesticide Application Technology at the Faculty of Agriculture, University of Novi Sad, took concrete measures that are related to the described problems. Thus, measures have been taken in relation to the training of agricultural producers on the use of appropriate nozzles for different weather conditions and exploitation factors.

Firstly, field testing about deposit quality under different operating conditions of different nozzles was performed. The application of pesticides in soybean was performed. Soya was in the flowering stage. The central part of the tree is splintered with formed lateral branches and the rows almost completely closed. Sampling was carried out in 5 repetitions on all the above leaves, on the central and lower leaves. After that, the average values of all deposit measurements were taken.

An overview of the used nozzles is given in the following table:

1 - Turbo Drop ADF (Sl. 1):

Angle of spraying: 2 X 110 °

Operating pressure: 1.5 to 8 bar

Best working pressure: 2 to 6 bar

Nozzle height: 40 to 60 cm

Advantages: Asymmetrical spray jet orientation, easy folding, compactness, good drift control, operation at speeds of 6 to 15 km / h.



2 - Turbo Drop Hi Speed (Sl. 2):

Angle of spraying: 2 X 110 °

Working pressure: 2 to 8 bar

Best working pressure: 3 to 7 bar

Advantages: Asymmetric orientation of spray jets, easy disassembly, durable ceramic parts, need for treatment with fungicides and insecticides, work at speeds up to 30 km / h.



3 – Air Mix (Sl. 3):

Spraying angle: 110 °

Operating pressure: 1 to 6 bar

Best working pressure: 2 to 6 bar (for pesticide), 1 to 2 bar (for mineral fertilizer)

Nozzle height: 40 to 90 cm

Advantages: Reduction of drift up to 90%, no closing, compact design, easy assembly.



4 – TFA:

Spray angle: 90 °

Operating pressure: 1.5 to 8 bar

Nozzle height: 50 cm

Advantages: High drift reduction, excellent surface coverage, compactness and easy assembly.



In this test, a 8% water solution of brilliant blue tracer was used. The solution is continuously mixed during the test, regardless of the extremely good water soluble solubility. When applied, the solution was collected in petri dish or washed from plants parts and then washed with 0.1 l of deactivated and deionized water. The concentration was read using the Shimadzu UV-Vis 1100 spectrophotometer at a wavelength of 565 ± 2 nm. All tests were done with water whose pH was slightly acidic.

In the experiment, Agromehanika AGS 800 sprayer was used, which was aggregated for CASE Farmall 115U tractor. The volume of the sprayer is 800 l and the boom width is 15 m. Swing wings were attached to the frame at one point and two springs are leveling and made up a mechanical system for terrain copying. The low-pressure pump BM 105 of the same manufacturer, type piston-membrane with a capacity of 105 l / min at 20 bar and 540 rpm, powered 30 nozzles with a working fluid and mixes it. The height of the application was 0.5 m, which is the recommended and most frequently adjusted height of the application in Vojvodina. Spray nozzles can carry a maximum of 3 nozzles, triplex carrier. The treatment norms were 150 l/ha, 180 l/ha and 220 l/ha at 10 km/h tractor speed and application

pressure of 2 bar, 3 bar and 4 bar. Wind speed was 3-4 m/s. The temperature was around 26 °C, and the air humidity was about 60%. The environmental conditions were not changed during testing. The samples were taken by washing the tracer from parts of the plants.

Results of the discussion with the discussion

Field conditions were fully acceptable for pesticide application. The quantities of the measured deposits shown in the following table are given in percentages. Date values provide information on how much pesticide has reached the target surface or penetrated on the plant. For example, if the value is 40%, this means that only 40% of the total amount of pesticide to be found on this surface (possible 100%) is due. The maximum amount of preparation that can reach this surface is obtained based on the norm and unit area.

Tab. 1. Pesticide deposit in soybean by using different nozzle types with given coefficient of variation.

No.	Nozzle	Average amount of deposit
1.	TD ADF	40,67 ± 64,16%
2.	TD HS	37,56 ± 67,22%
3.	AM	22,56 ± 77,34%
4.	TFA	41,78 ± 65,79%

Due to the Turbo drop technology, the ADF nozzles does not have the best result since the effect of this nozzles is recorded only at higher speeds. As always, two-jet spray nozzle with 41.78% of the average amount of deposits on the leafs had more quantities up to 11% of pesticide than of TD HS nozzle. The average coefficient of variation of these nozzles ranged from 64.16% to 67.22%. The smallest deposition had AM nozzles with the average deposit amount of 22.56% and the coefficient of variation of 77.34% which proved to be the worst. This is also to be expected given that the AM nozzles is injector type and has only one jet while all other nozzles have two jets.

The following figure gives a glossy overview of the average amount of deposits on the plants of all tested nozzles.

Fig. 1. Total deposit depending on different nozzles

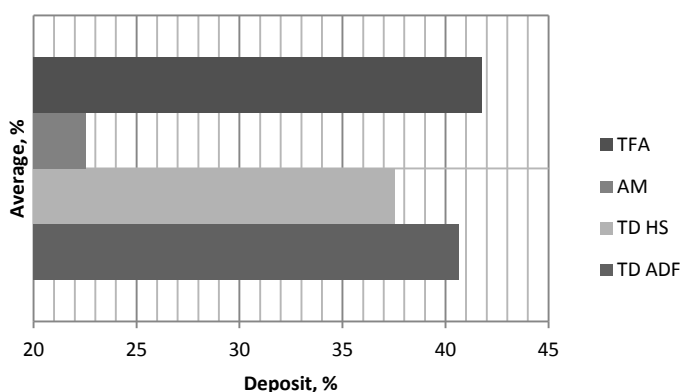

Conclusion

Agricultural producers must be aware that effective plant protection can be achieved if the work assemblies or elements such as the pump or nozzles are completely correct. This will ensure uniform distribution of pesticides to targeted areas. When selecting a nozzles, they must select the appropriate nozzles for its purpose as well as the operating pressure to reduce the risk of drift and polluted

environment. Using modern and improved nozzles, an effective pesticide application is achieved that is in line with the principles of good agricultural practice. An expedient selection of nozzles will increase efficiency and reduce the need for reuse of pesticides. Only in this way will sustaining the sustainability of agricultural production from the aspect of controlling the population of diseases and pests. Continuous training of agricultural producers, as well as research aimed at the local efficiency of various nozzles and the appropriate selection of exploitation parameters will ensure the production of health-safe food.

Note: This paper is part of the research on the project TR 31046: "Improving the quality of tractors and mobile systems in order to increase competitiveness, conservation of land and the environment" (2011-2018), financed by the Ministry of Science and Education of the Republic of Serbia.

Literature

1. Forster W A, Mercer G N, Schou W C, (2010). Process driven models for spray droplet shatter, adhesion or bounce. In: Proc. 9th Int. Symp. Adj. Agrochem, pp. 277-285.
2. [Cody F. Creech](#), [Ryan S. Henry](#), [Andrew J. Hewitt](#) and [Greg R. Kruger](#), (2018). Herbicide Spray Penetration into Corn and Soybean Canopies Using Air-Induction Nozzles and a Drift Control Adjuvant. *Weed Technology* 32(1):72-79. <https://doi.org/10.1017/wet.2017.84>
3. Forster W A, Mercer G N, Schou W C, (2012). Spray droplet impaction models and their use within AGDISP software to predict retention. *N. Z. Plant Prot.* 65, 85-92.
4. Forster W A, Schou W C, Mercer G N (2013). In: Evaluation of a Modified AGDISP Model to Predict Spray Canopy Retention. Proc. ISAA 2013, pp. 301-309. Foz do Iguaçu, Brazil April 22-26, 2013.
5. Fritz B K, Hoffmann W C, Bagley W E, Kruger G R, Czaczyk Z, Henry R S. (2014). Measuring drop size of agricultural spray nozzles - measurement distance and airspeed effects. *Atomization Sprays* 24:474-760
6. [Vieira B C](#), [Butts T R](#), [Rodrigues A O](#), [Golus J A](#), [Schroeder K](#), [Kruger G R](#). (2018). Spray particle drift mitigation using field corn (*Zea mays* L.) as a drift barrier. *Pest Manag Sci.* 2018 Apr 24. doi: 10.1002/ps.5041.

Effect of air distribution and spray liquid distribution of a cross-flow fan orchard sprayer on spray deposition in fruit trees

J.C. van de Zande, J.M.G.P. Michielsen, H. Stallinga, P. van Daltsen, M. Wenneker

Wageningen University and Research, P.O. Box 16, 6700 AA Wageningen, The Netherlands.

Summary

In a 4-year ongoing research programme in the Netherlands, we focus to maximise spray deposition in pome fruit trees and minimise spray deposition underneath the trees on the ground and minimise spray drift. For a cross-flow fan orchard sprayer we therefore measured spray deposition in the tree as an effect of different air settings and nozzle types. Nozzle types chosen were the Albus ATR lilac (as a reference) and the Albus TVI8001, both sprayed at 7 bar spray pressure. The orchard sprayer was a Munckhof cross-flow fan sprayer with a 2.75 m high cross-flow construction on top of the axial fan, equipped with 8 nozzles on both sides. At a forward speed of 6.5 km/h the spray volume was 200 L/ha and 290 L/ha, for respectively the Albus lilac and Albus TVI8001 nozzles. Air settings were: High air setting - 540 rpm PTO; and Low air setting - 540 rpm, 400 rpm, and 300 rpm PTO. Liquid distributions were measured with an AAMS-Salvarani Vertical patternator with discs, and air distribution was measured with a self-constructed measuring device equipped with ultrasonic anemometers and a handheld vane-anemometer. Liquid distribution in the apple trees (cv. Elstar) was measured in the full leaf growing stage (following ISO 22522).

First results show a good correlation between air distribution and liquid distribution. Vertical liquid distribution measured on the liquid measuring device correlates also very good with the liquid distribution at different heights in the tree. However, air distribution and especially air speed of the orchard sprayer showed that decreasing air assistance increased the spray deposition in the fruit trees. Showing that air assistance is an important parameter to be taken up in the advice to fruit growers.

Key words: orchard sprayer, cross-flow fan, spray deposition, air distribution, liquid distribution, air assistance

Introduction

To improve the current practice of spray application in fruit crops a research programme was setup. Spray and liquid distribution of nowadays often used single- and multiple-row orchard sprayers were assessed, and spray deposition and distribution in orchard trees were measured (Michielsen *et al.*, 2017; Wenneker *et al.*, 2014, 2018). Potential pathways –for improvement are: air amount, air distribution, nozzle type and therefore liquid distribution as the spray is transported by the moving air into the tree canopy. Improved spray deposition may lead to reduced use of agrochemical and reduced emission to the environment while maintaining high levels of spray drift reduction (Wenneker *et al.*, 2005) and biological efficacy. To quantify the air and liquid distribution in a 3D space together with AAMS-Salvarani (Maldegem, Belgium) a measuring platform was developed (Zande *et al.*, 2017). The setup and first results of these 3D air- and liquid distribution measurement platforms are presented. In this paper, results are presented of a single row cross-flow fan sprayer for air distribution, liquid distribution and the effect of two nozzle types and different air settings on the spray deposition for leaf canopy spraying of an apple orchard.

Materials and Methods

Spray and air distribution

The base part of the measuring device consists of a two-rail traverse system positioned parallel (x-axis) alongside the sprayer on which a measuring platform can move up- and downwards and a two-rail

traverse system on which the traverse system can manually be positioned at distances up to 5 m from the centre (x) axis of the sprayer. At the traverse system, the measuring platform can move in 10 cm steps over a range of 6 m length or in a continuous way at a set speed up and down the traverse system. The stepwise mode is used for the airflow distribution measurements. The continuous speed is used for the liquid distribution measurements using an AAMS-Salvarani patternator with discs (up to 4.5 m height) which is moved up and down (x-axis) through the spray fans until measuring tubes are filled for 80%. With a double sided discs



Figure 1. 3-D liquid distribution setup (left) and air-flow distribution setup (right).

distribution also multi-row orchard sprayers can be assessed. The air distribution measurement uses three ultrasonic anemometers (Gill Windmaster) which sample air speed in 3 directions (x,y,z) at 20 Hz positioned above each other at 50 cm spacing (y-axis). The combined three ultrasonic sensors can be positioned manually from 40 cm height (lowest sensor) up to 4.5 m height (highest sensor) in 10 cm steps (z-axis). Through steering and data sampling electronics and software the three sensors are moved through the air flow in 10 cm steps sampling the air flow at each x,z-axis position for 30 sec. In this way a full scan of the air flow at one side of an orchard sprayer can be made. Measurements are repeated for the y distances 1.00 m, 1.25 m, 1.50 m, 2.00 m, 3.00 m and 4.50 m from the centre axis of the sprayer. Results can be presented as a grid (matrix) presentation showing mean vector air speed per grid cell, as interpolated speed distribution charts per y-distance, as speed vector distributions in the x, y or y, z planes.

Spray deposition in tree canopy

Spray deposition measurements were performed in an apple orchard (Randwijk, The Netherlands) to quantify the effect of a reference cross-flow fan orchard sprayer (Munckhof 105) in a full leaf situation (June-October 2017). Apple trees (cv. Elstar) are of the spindle type spaced at 1 m in the row and at 3 m row spacing. The sprayer was equipped with standard hollow cone nozzles (Albus ATR lilac) and a 90% drift reducing (Zande *et al.*, 2008, 2012) venturi hollow cone nozzle (Albus TVI8001) both operated at 7 bar spray pressure and a forward speed of 6.7 km/h. Eight nozzles were used on both sides of the sprayer resulting in a spray volume of respectively 200 L/ha and 290 L/ha. Air setting during the experiments was in the high (540 rpm PTO) or low settings of the fan gear box (540, 400, 300 rpm PTO). To measure the spray deposition in the apple tree a single row was sprayed with a fluorescent tracer (BSF 0.3 g/L) from both sides spraying consecutively from the left and right hand side of the sprayer (same driving direction). To sample the spray distribution the tree was divided in 7 compartments: top, middle-east, middle-west, bottom-east-outside, bottom-east-inside, bottom-west-inside and bottom-west-outside. From four trees the leaves in each compartment were counted and every tenth leaf was picked and put in a sample bag. Number of leaves per compartment were recorded and in the laboratory 10 leaves were taken from the sample and washed with a fixed amount of deionised water to recollect the tracer from the leaf surface. The surface area of the individual leaves was measured (Licor). Tracer amount in the solution was measured using a fluorimeter (Perkin-Elmer LS50) and

expressed as $\mu\text{l}/\text{cm}^2$ and percentage of applied spray volume per tree compartment and for the whole tree. Specific parameters as mean, median, CV of leaf samples per compartment of 40 leaves, CV per compartment in the tree and CV between mean total deposition in the trees were calculated.

The effect of the different air settings and nozzle types on spray deposition in tree leaf canopy is presented.

Results

Spray and air distribution

The average liquid and air speed distribution at the left and right hand side of the cross-flow fan sprayer is presented in Figure 2 for the full air fan setting and the Albus ATR lilac nozzles (7 bar). Liquid distribution over height was different for both sprayer sides. Air speed distribution was also not similar on the left and right hand side and shows a gap with reduced air speeds at 2-3 m height.

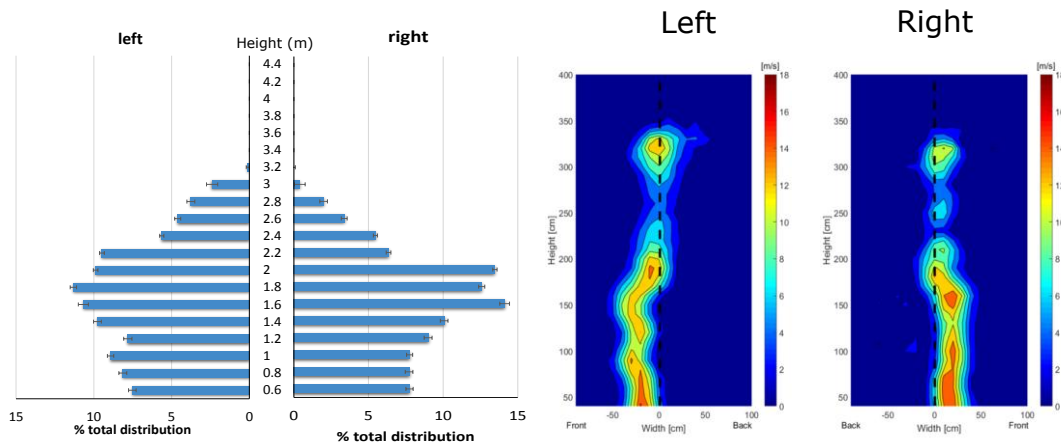

Figure 2. Liquid (left; % of total spray volume) and air speed (right; m/s) distribution over height (m) at 1.5 m distance from the centre line of the sprayer of the left and right hand side of the cross-flow fan sprayer (Munckhof ATRlilac@7 bar; full air).

The result of the liquid and air distribution (Figure 2) is the input for the measured spray deposition in tree canopy of an apple orchard as the spray plume moves over larger distances. The average liquid distribution at the left and right hand side of a cross-flow fan sprayer is presented in Figure 3 for distances up to 4.5 m from the centre axis of the sprayer. Showing that liquid distribution over height was different for both sides and the maximum liquid deposit was at higher heights at further distances from the sprayer.

The air distribution, at the right hand side of the Munckhof cross-flow fan sprayer (Figure 4) showed a gap in the air speed profile at 2.0-2.5 m height which widened at larger distances from the sprayer. The gap rose to higher heights up to 2.5-3.0 m at 3 m distance and 3.5 m at 4.5 m distance from the centre-axis of the sprayer.

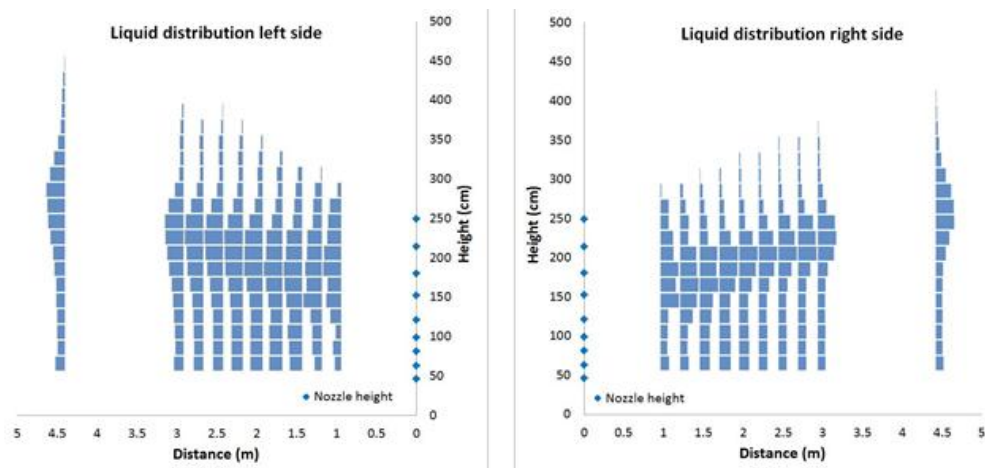

Figure 3. Liquid distribution in the x,z plane of the left and right hand side of a cross-flow fan sprayer.

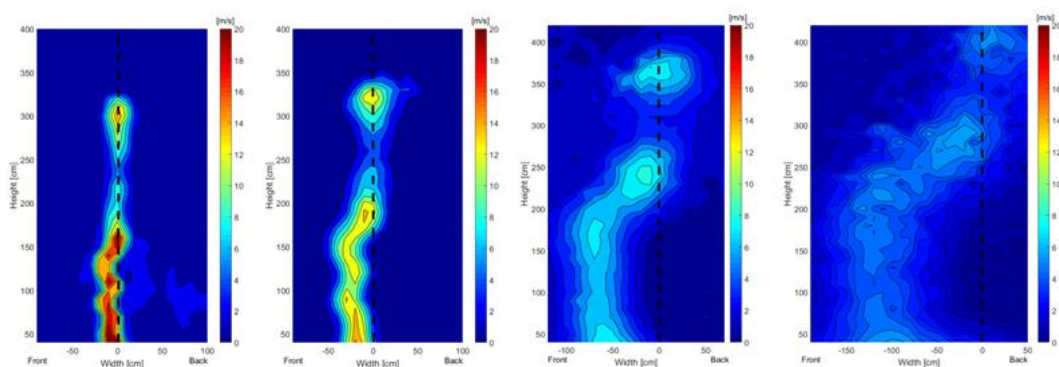

Figure 4. Air distribution (m/s) in x,z plane at 1.0 m, 1.5 m, 3.0 m and 4.5 m from the centre axis (x,z plane) of a cross-flow fan orchard sprayer (right hand side).

Spray deposition in tree canopy

As an example of the spray deposition in the apple tree, the results of July 4th 2017 (Figure 5) measurements are given for the Munckhof ATR lilac (7 bar) at full air setting. This is presented as the average spray deposition per compartment of the four sampled trees (10 leaves per compartment). Spray deposition was between $0.37 \mu\text{L}/\text{cm}^2$ in the top of the tree and $0.17 \mu\text{L}/\text{cm}^2$ in the bottom-inside compartment of the tree. Average spray deposition for all compartments of the four trees was $0.25 \mu\text{L}/\text{cm}^2$ with a coefficient of variation (CV) between the four trees of 17%. Variation in spray deposition between the compartments of the four trees varied between 13% in the middle-west part of the tree and 49% in the bottom outside part of the tree. Within a compartment a large variation was observed between spray deposition at individual leaves CV for the 40 leaves per compartment picked was from 41% in the bottom outside compartment to 68% in the bottom inside compartment of the tree. Spray deposition in the top of the tree was between 0.04 and $0.76 \mu\text{L}/\text{cm}^2$, which is a 20-fold difference. On average only 20-30% of applied spray volume was traced back on the leaves in the tree canopy.

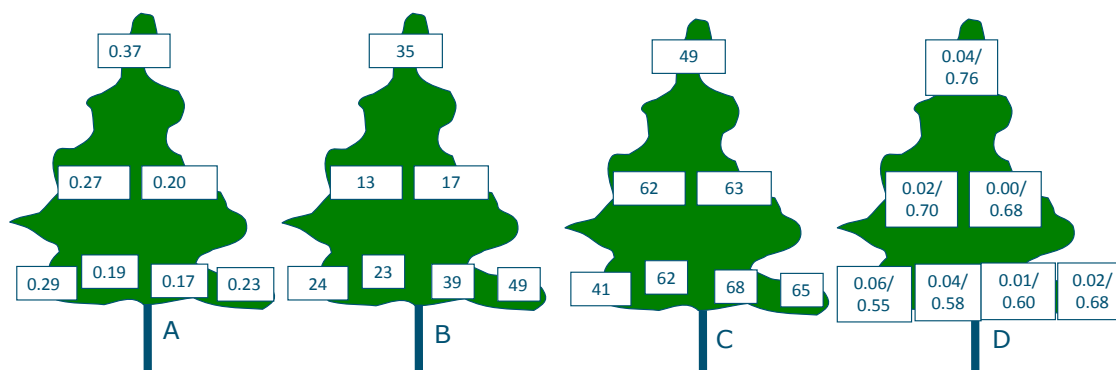

Figure 5. Spray deposition ($\mu\text{L}/\text{cm}^2$) of a cross-flow fan sprayer (Munckhof with ATR lilac nozzles at 7 bar; full air) in full leaf apple tree (4 July 2017); distribution in compartments (A), coefficient of variation per compartment of 4 trees (B), coefficient of variation inside a compartment (C) and min/max deposition per compartment of 4 trees (D).

Total spray deposition in the tree

Effect of air settings

The correlation between air amount of the air settings of the Munckhof cross-flow fan sprayer and the spray deposition in the total tree leaf canopy of an apple orchard is presented in Figure 6. Total spray deposition in tree canopy was similar or increased with lower air settings of the Munckhof cross-flow fan sprayer. This was observed for the 90% drift reducing venturi type nozzle (TVI8001) as well as for the standard hollow cone nozzle (ATR Lilac). Maximum increase in spray deposition of the ATR Lilac hollow cone nozzle was 34% and for the 90% drift reducing venturi hollow cone nozzle was 46% both at Low gear setting of the Munckhof cross-flow fan sprayer and with 300 rpm PTO.

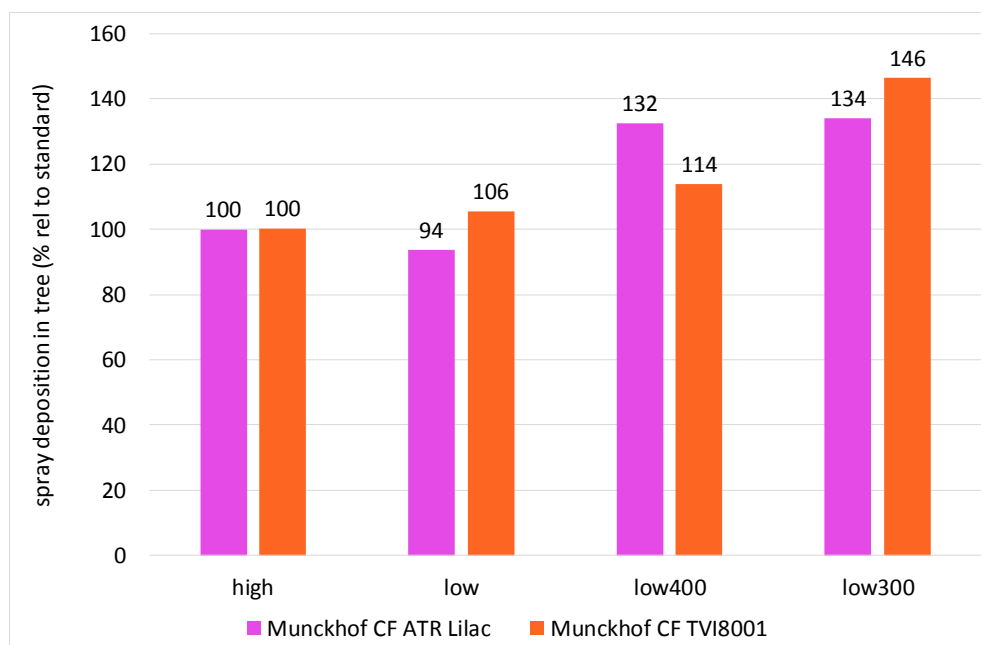

Figure 6. Effect of air settings of the Munckhof cross-flow (CF) fan orchard sprayer on total spray deposition in leaf canopy (% relative to deposition of standard setting).

The measured air speed at the air outlet of the Munckhof cross-flow fan sprayer at different settings ranged from 25.5 m/s for the standard High gear full air setting at 540 rpm PTO to 13.4 m/s for the Low gear air setting at 300 rpm PTO. The reduced air settings of the sprayer resulted in a relation between air outlet speed and total spray deposition in the tree leaf canopy of an apple orchard in the full leaf

stage (Figure 7). Reducing air outlet speed with 1 m/s increased spray deposition in leaf canopy with 3.5 %. This relation was similar for both nozzle types used in the experiments; the Very Fine hollow cone nozzle (Albuz ATR Lilac) and the 90% drift reducing venturi hollow cone nozzle (Albuz TVI8001) both operated at 7 bar spray pressure (Figure 7).

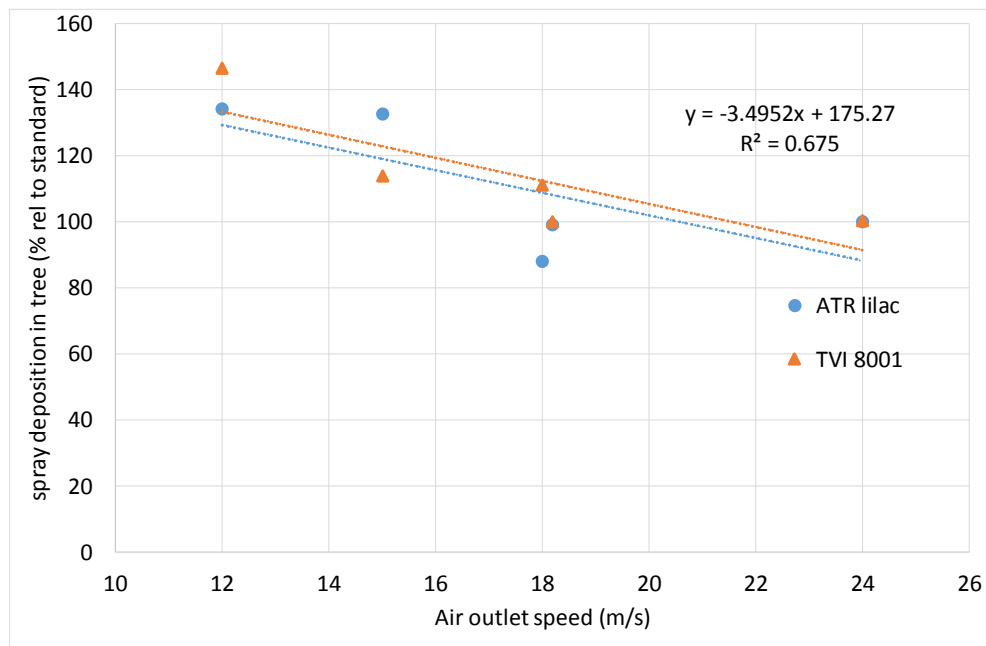

Figure 7. Relation between air outlet speed (m/s) of the Munckhof cross-flow fan sprayer and the spray deposition in tree leaf canopy relative to the deposition of the standard setting (540 rpm PTO High fan setting – 25.5 m/s air outlet speed)

Conclusion

Characterizing the air distribution and the liquid distribution is necessary to get more insight in the spray deposition process when spraying a fruit orchard. It appears that air and liquid distribution at different heights and distances from a cross-flow fan sprayer is not similar at the left and right hand side. Gaps in the air speed profile can be recorded only when small enough measuring grids are used, for example at a 10 cm square grid sampling, whereas these gaps are hardly detected at close distance of the air outlet. The spray deposition in tree leaf canopy is for a 90% drift reducing nozzle type (Albuz TVI8001) similar or higher as for a standard hollow-cone nozzle (Albuz ATR Lilac). Spray deposition in the tree leaf canopy increased with reduced air settings of the cross-flow fan sprayer. Lowering the air outlet speed from the standard Full leaf setting (High fan gear, 540 rpm PTO) to a low air setting (Low fan gear, 300 rpm PTO) increased spray deposition in the tree leaf canopy. Increase was 34% for the standard cross-flow fan nozzle (ATR Lilac) and 4,6% for the 90% drift reducing venturi hollow cone nozzle (Albuz TVI8001) both operated at 7 bar spray pressure. The relation of reduced air outlet speed of the cross-flow fan sprayer and increased spray deposition in the leaf tree canopy is for both nozzle types similar. Air settings and distribution seems to be more important for spray deposition in the tree leaf canopy than nozzle type.

Acknowledgement

Research presented in this paper is part of a Public Private Partnership project Innovative Efficient Application Technologies (PPS KV 1406044) and financed by Topsector Tuinbouw & Uitgangsmateriaal, Dutch Horticultural Board (Productschap Tuinbouw), Munckhof (Horst, The Netherlands) and various other companies and organisations. Acknowledged is the contribution of

Munckhof for supplying the sprayer and AAM-Salvarani (Maldegem, Belgium) for assistance in the development of sprayer air and liquid distribution measurement methodologies.

References

ISO22522: 2006. Crop protection equipment — Field measurement of spray distribution in tree and bush crops. Geneva: International Standardisation Organisation.

Michielsens, J.M.G.P., Stallinga, H., van Velde, P., van Daltsen, P., Wenneker, M., and van de Zande, J.C., (2017). Spray deposition and distribution of a cross-flow fan orchard sprayer in spindle apple trees. In: Program and Abstracts of the 14th Workshop on Spray Application in Fruit Growing. SuproFruit2017 14th Workshop on Spray Application in Fruit Growing 10-12 may 2017 Hasselt Limburg, Belgium. p. 21-22

Wenneker, M., Heijne, B., and van de Zande J.C. (2005). Effect of air induction nozzle (coarse droplet), air assistance and one-sided spraying of the outer tree row on spray drift in orchard spraying. *Annual Review of Agricultural Engineering*, 4(1): 116 – 128.

Wenneker, M., van de Zande, J.C., Stallinga, H., Michielsens, J.M.G.P., van Velde, P., and Nieuwenhuizen, A.T., (2014). Emission reduction in orchards by improved spray deposition and increased spray drift reduction of multiple row sprayers. *International Advances in Pesticide Application. Aspects of Applied Biology* 122: 195-202.

Wenneker, M., van de Zande, J.C., Michielsens, J.M.G.P., Stallinga, H., van Daltsen, P. and van Velde, P., (2018). Improvement of spray deposition in orchard spraying using a multiple row tunnel sprayer. *International Advances in Pesticide Application. Aspects of Applied Biology* 137: 101-108.

Zande, J.C. van de, Holterman, H.J., and Wenneker, M. (2008). Nozzle Classification for Drift Reduction in Orchard Spraying: Identification of Drift Reduction Class Threshold Nozzles. *Agricultural Engineering International: the CIGR Ejournal*. Manuscript ALNARP 08 0013. Vol. X. May, 2008.
<http://www.cigrjournal.org/index.php/Ejournal/article/viewFile/1256/1113>

Zande, J.C. van de, Wenneker, M., Michielsens, J.M.G.P., Stallinga, H., Van Velde, P., and Joosten, N., (2012). Nozzle classification for drift reduction in orchard spraying. *International Advances in Pesticide Application. Aspects of Applied Biology* 114: 253-260.

Zande, J.C. van de, Schlepers, M., Hofstee, J.W., Michielsens, J.M.G.P., and Wenneker, M., (2017). Characterization of the air-flow and the liquid distribution of orchard sprayers. In: Program and Abstracts of the 14th Workshop on Spray Application in Fruit Growing. SuproFruit2017 14th Workshop on Spray Application in Fruit Growing 10-12 may 2017 Hasselt Limburg, Belgium. p. 41-42

Assessment of some measurement methods for the inspection of spray application equipment

Francesc Solanelles, Ferran Camp, Alba Fillat, Felip Gracia

Centre de Mecanització Agrària. DARP

Generalitat de Catalunya

Rovira Roure, 191

25198 Lleida. Spain

Abstract

Several measurement methodologies used for the determination of the uniformity of the spray distribution are assessed. Nozzle adaptors used for flow rate measurements of the nozzles mounted on the sprayer cause a deviation of the measured values from the real ones, mainly in flat fan nozzles working at low pressures. According to the inspection standard, the transverse distribution uniformity in a horizontal boom sprayer can be measured in two ways. If a horizontal patternator is used, less favourable inspection results are found than if the distribution uniformity is estimated in the same conditions from the nozzle flow rate and pressure drop measurements. Finally, it was seen that the shorter overlapping length for the measurement of the boom transverse distribution established in the current standard, provide more favourable inspections compared with the overlapping length of the former one. The results of this work should be taken into account when establishing inspection procedures by the authorities and could also provide useful information for a future revision of the technical standards.

Key words: sprayer inspection, spray distribution, patternator, nozzle adaptor

1. Introduction

According to the annex II of the 2009/128/CE directive for the sustainable use of pesticides, and the corresponding methodologies established in the harmonised standard series EN ISO 16122:2015, the uniformity of the spray distribution has to be measured in a sprayer inspection.

In sprayers for bush and tree crops, this standard establishes the measurement of the nozzle flow rate and pressure drop as the only way to assess the liquid distribution uniformity. The requirements are a maximum allowed deviation from the nominal flow rate of each nozzle and a maximum pressure drop. Nozzle flow rate measurements can be made detaching the nozzles from the sprayer and measuring the flow rate of each single nozzle on a measuring bench or with the nozzles mounted on the sprayer using, if required, different kinds of nozzle adaptors to convey the liquid flow to the measuring device. In order to make measurements easier, water-tight adaptors are often used in several manual and electronic benches.

These kind of adaptors are said to cause inaccuracies in the flow rate measurement of spray nozzles. Osteroth (2007) showed that the nozzle flow rate measured with water-tight adaptors is higher than the real value in the case of air injection nozzles working at less than 10 bar. Besides, the measured error is higher with flat fan nozzles than with hollow cone nozzles.

Vanella et al. (2011) tested many flat fan and some hollow cone nozzle models with several models of water-tight adaptors and showed that the use of this kind of adaptors increased the flow rates of air induction and extended range flat fan nozzles.

On the other hand, for horizontal boom sprayers, there is also the possibility of determining the spray distribution uniformity of the booms by means of spray scan devices. They have to be build according to the requirements of the inspection standard, so that they collect the spray from the boom on 100-mm wide grooves. The coefficient of variation (CV) of the volumes collected by all the bench grooves along the overlapping length of the boom has to be lower than 10%. Besides, all the measured volume

values have to be within the $\pm 20\%$ interval around the average volume. It is said that the two standardized methodologies for the measurement of the spray distribution don't provide the same inspection results (Godyn et al., 2014).

The current inspection standard has also changed the measuring length for the distribution uniformity of horizontal booms, in relation to the former one, EN 13790:2003. The verification of the uniformity has to be carried out from the midpoint between the centre of the outermost nozzle and the centre of the penultimate nozzle on one side of the boom to the midpoint between the centre of the outermost nozzle and the centre of the penultimate nozzle on the other side of the boom.

The objective of this work is to assess some sprayer inspection methodologies, related with the measurement of the uniformity of the spray distribution, in the following aspects:

- To establish the error induced by the nozzle adaptors in the measurement of the flow rate
- To compare the spray distribution measurement results obtained with the use of both inspection methodologies for spray booms.
- To know the effect of the new shorter overlapping length in the measurement of the spray distribution uniformity in spray booms.

2. Methodology

2.1. Nozzles

Eleven nozzle models were chosen from four manufacturers (table 1), in order to determine the effect of the nozzle type (flat fan or hollow cone) and the air injection technology on the results of the inspection measurements.

Three different nozzle sizes were selected from each nozzle model, randomly taking four nozzle units for each combination of nozzle model and size. The flow rate for each single nozzle was measured at three different pressures on a two replication basis. The working pressures for each nozzle model were selected within the pressure range advised by the sprayer manufacturer.

Table 1.- Nozzle models and working pressure used in the tests. Air injection nozzles are depicted in italics

Manufacturer	Nozzle models and size	Pressure (bar)
Albuz®	API 110 02, 03, 04 ⁽¹⁾	2, 3, 4
	AVI 110 02, 03, 04 ⁽¹⁾	3, 5, 7
	ATR yellow, orange, red ⁽²⁾	5, 8, 10
	<i>TVI 80 015, 02, 03</i> ⁽²⁾	5, 8, 10
Teejet®	XR 110 02, 03, 04 VS ⁽¹⁾	2, 3, 4
	TXA 80 015 VK, TXB 80 02, 03 VK ⁽²⁾	5, 8, 10
Hardi®	F 110 02, 03, 04 ⁽¹⁾	2, 3, 4
	<i>INJET 02, 03, 04</i> ⁽¹⁾	3, 6, 8
Lechler®	<i>IDK 120 02, 03, 04</i> ⁽¹⁾	2, 4, 6
	TR 80 015, 02, 03 ⁽²⁾	5, 8, 10
	<i>ITR</i> ⁽³⁾ 80 015, 02 ⁽²⁾	5, 8, 10

⁽¹⁾ Flat fan; ⁽²⁾ hollow cone; ⁽³⁾ only two nozzle sizes were selected for this model

2.2. Measuring devices

Nozzle flow rate measurements were carried out with water-tight adaptors mounted at the sprayer nozzle outlet. These adaptors are required to convey the liquid from the nozzles to the measuring device, without leaks (figure 1). The measured values were compared with those obtained with a graduated cylinder and a stopwatch, using a hose for liquid collection at the nozzle outlet.



Figure 1. Water-tight adaptors for the measurement of the nozzle flow rate (left) and horizontal patternator for the measurement of the transverse distribution in boom sprayers.

The transverse spray distribution uniformity measurements in horizontal booms were carried out with the boom placed above a horizontal patternator, built according with the requirements of the ISO 5682-2:1997 standard (figure 1). The bench has a measuring surface of 2200x3000-mm and is equipped with 50-mm-wide grooves. The collected volume in each groove in a given time is measured with an electronic system and stored in a computer file. For each combination of nozzle, pressure and working height, measurements were carried out on a two replication basis.

For every transverse distribution measurement made with the patternator, the values of the coefficient of variation (CV, %) and the deviation (D, %) of each measured volume from the mean value were computed, as indicated in the EN ISO 16122-2:2015 standard. Besides, the deviation between the measured and the nominal flow rate of every nozzle was also determined, as it was the pressure drop in the spray boom.

More information about the methodology used and the results obtained can be found in Solanelles et al., 2012 and 2016.

3. Results and discussion

3.1. Flow rate measurement with nozzle adaptors

In most cases, the use of water-tight adaptors for the measurement of the nozzle flow rate, caused a deviation of the measured values from the real ones. Significant positive deviations were measured mainly when flat fan nozzles were used (figure 2). It was clearly seen that deviations for flat fan nozzles – especially air injection nozzles – working at a lower pressure are significantly higher than those obtained at higher pressure. This trend was also noticed when air injection hollow cone nozzles were used, but not for the standard hollow cone nozzles.

According to the results, it is difficult to establish a clear pattern for the measured deviations. In general, but not in all the cases, the difference is higher when the measurements are carried out at

lower pressures. In the case of standard hollow cone nozzles, however, the deviations were not significantly affected by pressure changes. Therefore, measurements with water-tight adaptors are in general more reliable when they are carried out at the higher pressures of the nozzle working range.

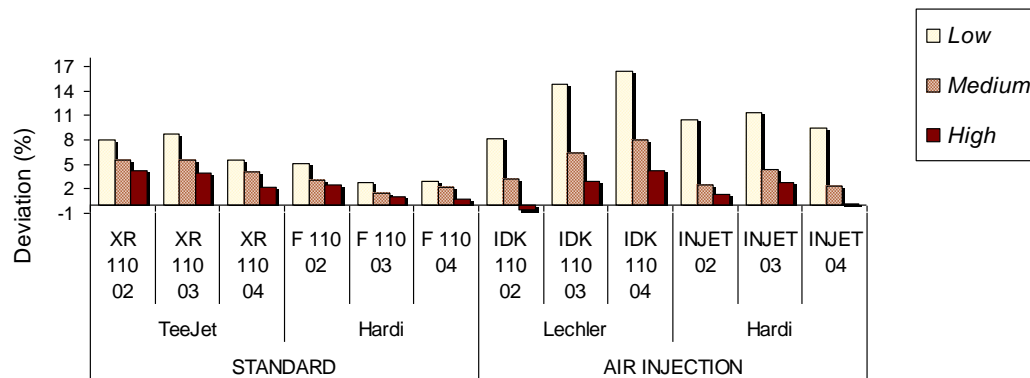

Figure 2. Deviation between the nozzle flow rate values measured with the adaptors and the real values (% of the real value), for different nozzle models at three working pressures within the corresponding pressure range for each nozzle

The possibility of a measurement error, in the case of using adaptors for nozzle flow rate measurement in the inspection of sprayers in use, should be taken into account. However, the fact that these devices have got clear advantages in relation to other methodologies, make them widely used by the inspection workshops, mainly for air-assisted sprayers. In the case of horizontal boom sprayers, hand held flow meters are also very common in use. Since they are able to collect the liquid without the use of any kind of adaptor, the error caused by the adaptor is suppressed.

3.2. Transverse distribution measurement in horizontal booms. Results with the two alternative methods

A clear difference is seen between the inspection results obtained with the two methodologies accepted in the inspection standard. In all the measurements carried out in this work, if the transverse distribution is determined from the nozzles flow rate and the pressure drop in the boom, the results of the inspection are favourable. The measured flow rates are within the $\pm 10\%$ interval around the nominal flow rate for every single nozzle. Besides, the pressure drop in the horizontal boom, where the nozzles were mounted, is very low, well within the 10% maximum variation required by the inspection standard.

However, if the traverse distribution is measured by means of the patternator, the values of the CV and of the deviation from the mean volume (D) lead to the fact that the inspection results are not always favourable. Therefore, the use of the patternator makes the inspection of horizontal boom sprayers more difficult to pass. In some cases, it is only the value of D that causes the inspection to fail. The different results obtained with the two methodologies should be considered when comparing the inspection results between workshops.

3.3. Transverse distribution measurement in horizontal booms. New measurement zone with the patternator according to EN ISO 16122-2:2014

If only the CV value of the measured volumes are taken into account, no significant differences are found between the inspection results obtained with the former and the current inspection standard. Nevertheless, when D values are also considered – as it is required in the inspection – the number of favourable results is significantly higher, if the overlapping length is defined according to the current inspection standard – EN ISO 16122-2:2015. Besides, with the shorter overlapping length defined in this

standard, the results of the inspection is also less affected by changes in the boom height. So, the current inspection standard makes the inspection easier to pass for horizontal boom sprayers.

In general, the nozzle working pressure has no significant effect on the number of favourable inspections, obtained from the transverse distribution measurement in horizontal booms carried out with a patternator. The fact that the working pressure does not affect the inspection result, as long as it is kept within the working range for each kind of nozzle, makes the inspection easier.

4. References

- Godyn A., Holownicki R., Doruchowski G., SWIECHOWSKI, W. (2014). The comparison of the nozzle inspection methods in the field crop sprayers: Nozzle flow vs. spray traverse distribution –methodology and some results. SPISE 5. Montpellier. France. 172-174.
- Osteroth, H.J. (2007). Influences of single nozzle adapters on the flow measurements results. Second European Workshop on Standardized Procedure for the Inspection of Sprayers - SPISE 2-, Straelen, April 10-12. Mitt. Biol. Bundesanst. Land-Forstwirtschaft. 412: 145-148.
- Solanelles, F., Tarrado, A., Camp, F., Gracia, F. (2012). Assessment of nozzle flow rate measurement methods for the inspection of sprayers in use. SPISE 4. Lana. South Tyrol. 186-190.
- Solanelles, F., Camp, F., Fillat, A., Gracia, F. (2016). Assessment of the traverse distribution measurement in the inspection of horizontal boom sprayers. SPISE 6. Barcelona. 139-145.
- Vanella, G., Masoud, S., Balsari, P. (2011). Effect of the nozzle adaptor of sprayer calibrator on flow rate measurements. Crop Protection 30. 1043-1047.

Sprayers inspection in Venetian Region: experiences, issues and future perspectives

Cristiano Baldoïn

Dept. TeSAF, University of Padua, Agripolis, viale dell'Universita', 35020 Legnaro Italy

Abstract

Italy fully adopted the 2009 Directive on Sustainable Use of Pesticides (SUD) only in 2014 with the publication of the National Action Plan (NAP), but some regions had started to put the service on immediately after the enter into force of the Directive as well. Venetian Regional administration issued a deliberation early in 2011 in order to re-organise the existing voluntary-based service according to the new legislation, train inspectors and authorize appointed workshops. Between 2011 and 2014, four training coursed were set up and 132 inspectors were licensed; in the following years, 41 testing centres were acknowledged in the Region, in addition to 11 extra-regional centres by mutual acknowledgement.

On the deadline of 26th November 2016, over 25.000 inspection were performed. The present work reports the results of the activity of the inspection service, the Issues and criticalities that emerged about the application of the protocols established by the NAP.

Keywords

Pesticides application equipment, sustainable use of pesticides

Introduction

In 2009, European Commission issued the European Directive 2009/128 on the sustainable use of pesticides, aiming to fill the existing regulatory gap on the use on field of equipment for the distribution of plant protection products, an operation known to be affected by serious shortcomings in efficiency. In fact, pesticide losses during spray application on vineyards and orchards are often higher than 50% of spray mixture. To improve spray technology, thus achieving a better efficiency of the process, Italy started some local and national actions since the end of 1990s; in this framework, Regional administrations established a voluntary-based service of inspection and calibration of sprayer, using the EN13790 as guideline for the workshops appointed for the service. During the following years, while the Thematic Strategy for the sustainable use of pesticides was developed and the SPISE Group started its activity, in Italy the ENAMA Working Group, co-ordinated by Prof. Paolo Balsari (Crop Protection Technology Research Group – dept. DISAFA, University of Turin) operated to set up an operational framework for the application of the upcoming SU Directive 2009/128. The full adoption of the SUD in Italian legislation occurred only in 2014 with the publication of the National Action Plan, but in the meanwhile, some Regions had already taken on some local initiatives anticipating the contents of the Directive.

In 1996, the Ministry of Agriculture and Forestry launched an interregional program named "Agriculture and Quality", with the aim of increasing the competitiveness of the agricultural sector by improving the quality of production. In that context, one of the actions had the aim to improve the efficiency of pesticide distribution, also through the promotion of initiative like the training of inspectors and the institution of a service of functional verification and calibration of sprayers on a voluntary basis. The service operated in the following years, mainly due to the possibility for farmers to get financial benefits by agro-environmental measures (eg: European Regulation 2078/92). In that context, a number of inspectors were trained and 12 testing centres were authorized to carry out the inspection and calibration service. The centres went on with their activity until 2011, although operating with a certain continuity only until the end of the aforementioned agro-environmental measures. In fact, the service was requested only by a few farmers, mostly those who sell their products to the great retailers,

which require the inspection and calibration of the equipment for the distribution of crop protection products.

Experiences and issues

In 2011, the Phytosanitary Office of Venetian Region, in co-operation with Department of Land, Environment, Agriculture and Forestry (TeSAF) of University of Padua, started the full rearrangement of the existing service of functional inspection of the sprayers; the previously released authorizations to the testing centres expired on 14 December 2011. The first initiative was a training course, carried out in November 2011, for new inspectors and a refreshing course for those ones who were already authorised to operate inside the previous service. The program of the course, held by Dept. TeSAF and consisting into a theoretical and a practical section, was prepared according to the guidelines developed by the abovementioned ENAMA Working Group (Document n. 1). The course was afterwards repeated in April 2012 and in February and April 2014, leading to the qualification of 132 inspectors; 33 of them came from out of Veneto, due to the delay of most of Italian regions to start the service.

From 14 December 2011 to date, the Regional administration released 41 authorisations to new testing centres; out of them, 21 are workshops or retailers, 10 are manufacturers and 10 other structures (wine cooperatives, unions of producers, etc.), while 11 further ones from other Regions are approved to operate in Veneto by mutual recognition (fig. 1).

During this first phase of the adoption of the SU Directive, some local initiatives have helped to speed up the start of the process, such as the issue of a specific local police regulation by the municipalities of the Prosecco vines cultivation area, that anticipated the contents of the Directive.

The correct operation of the testing centres, authorized and recognized in the regional area, has been continuously tested, both through the analysis of quarterly reports, and through targeted inspections that, in almost all cases, have highlighted the full compliance with the provisions of the law. Only in very few cases, the controls made it possible to avoid the occurrence of irregular situations.

As resulting from the processing of the data transmitted quarterly to the regional authority, 25.004 inspections were carried out as at 30 September 2017, with a sharp increase in activity, as expected, as the deadline set by the NAP approached. This was also due to the Region's decision to restrict the grant of the subsidized diesel fuel for spraying operations to the presentation of the certificate of control.

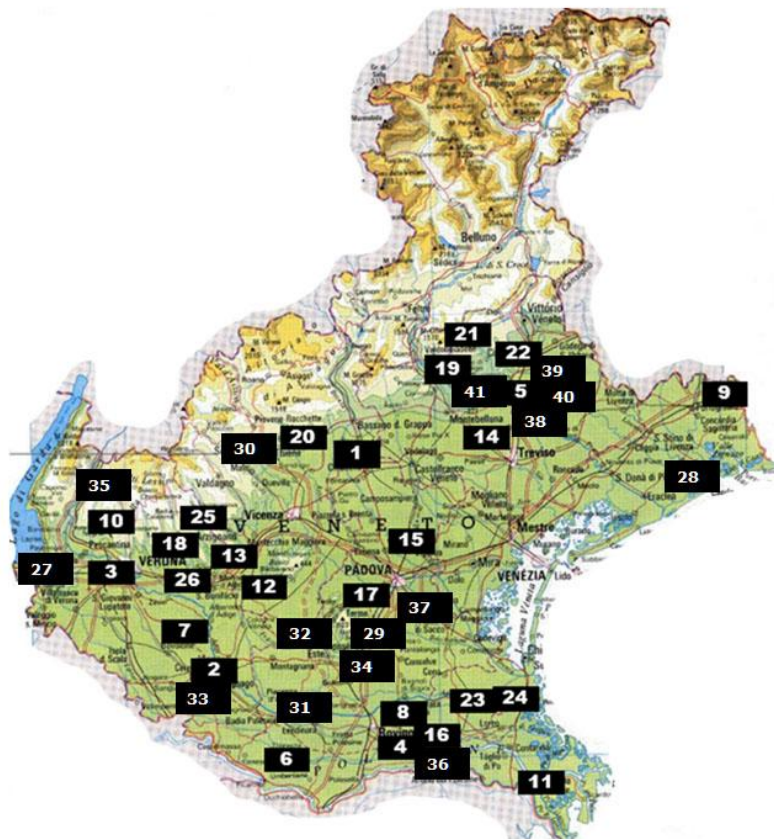

Fig. 1 – distribution of the testing centres in Veneto Region

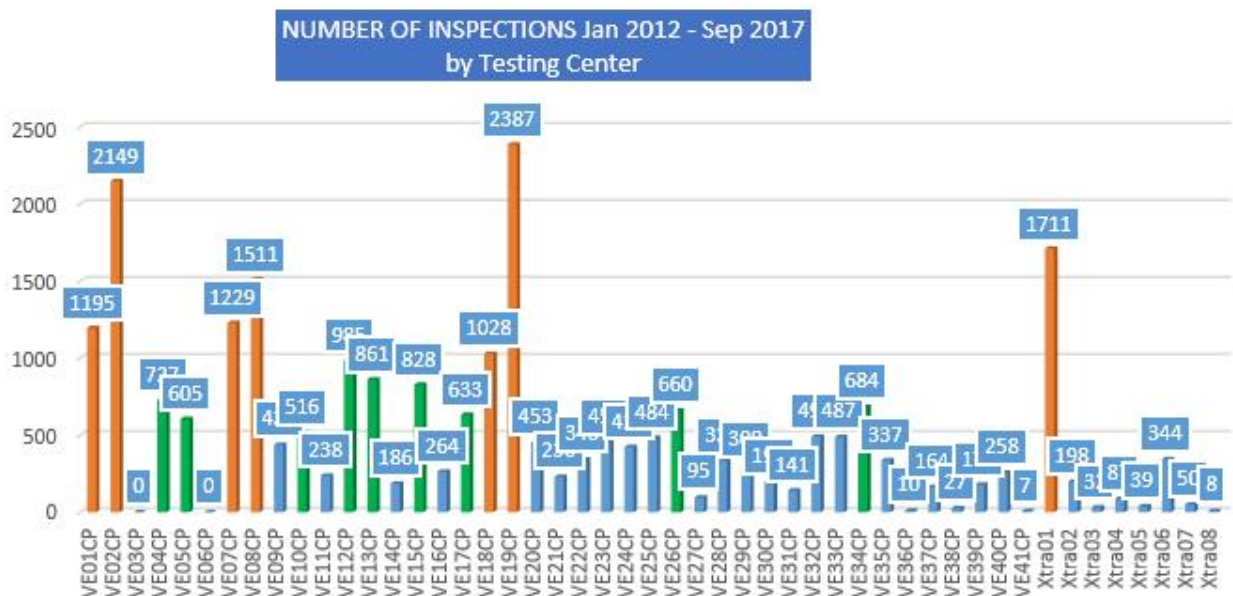

Fig. 2 - total number of inspections carried out in Veneto from 2012 to September 2017

The elaboration includes the controls carried out by the 41 test centres based in Veneto, and the 11 of other Regions authorized by mutual recognition. An estimate of the percentage of inspections carried out on the total number of sprayers in use on the territory is impossible, as their number is not known; however, considering that many equipment used in small farms have been likely to be abandoned, the result obtained in terms of the number of checks is to be considered more than satisfactory. Figures 2

and 3 show a synthesis of the number of inspections carried out from 2012 to 2017, grouped by testing centre, by province and by type of sprayer.

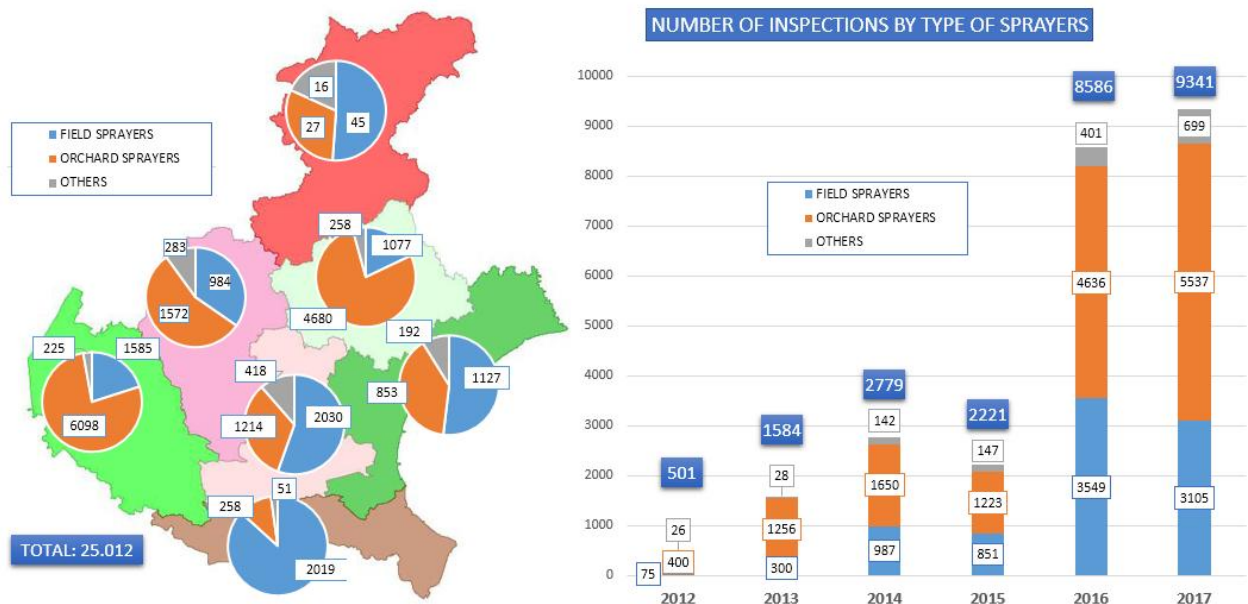

Fig. 3 – number of inspections by province and type of sprayers

As shown in the graph, only 16 out of 49 active test centres have carried out more than 500 inspections, thus contributing over 70% of the total; only seven centres (highlighted in orange in graph), one of which is extra-regional, carried out more than 1.000 inspections. Taking a precautionary view of the availability of 100 working days and a theoretical operating capacity that can be assessed in six checks per day, it can be observed that the three most productive centres performed, in almost six years, on average less than three inspections a day, thus largely below their potential. It is therefore clear that the coverage of the regional control service can be considered adequate to the amount of work required in the territory, when fully operational. Considering the above parameters, the current regional service would theoretically allow to carry out at least 20,000 checks a year, i.e. exactly the number of machines to be inspected every three years according to regulations. For this reason, no new qualification courses were planned during this period.

Since 2012, personnel appointed by Regional administration performed periodical inspections to evaluate the correctness of the testing centres performance.

Issues and technical concerns

During their activity, testing centres have highlighted some technical and administrative problems, which were analysed by experts of University and Phytosanitary Office, also in co-operation with Crop Protection Technology research group of University of Turin. In fact, on several instances, the instructions given in the NAP, if interpreted literally, can make it hard, if not impossible, to pass the functional check, also in case of sprayers not particularly old or even new.

The first issue concerns the functionality of the measuring, control and regulation systems. The first point of attention is the respect of the points 1.5d and 2.6d ("Pressure stability at the closure of the boom sections"), a parameter that must not increase more than 10% of the working pressure when the sections supply are closed one by one. This requirement, if intended as mandatory in all cases, is a problem for sprayers, especially those for tree crop, equipped with control units without compensative returns, since in the absence of such devices, compliance with the requirement is impossible. In this regard, the Enama documents no. 6 and 7, which form the basis for the Annex II of the NAP, report at the end of the aforementioned period the sentence "The outcome of this test is not binding for the

overcoming of control, but the extent of the pressure drop must be reported in the test report.". Furthermore, the ISO 16122 standard, which was not yet issued at that time, stated: *"This requirement is only applicable for sprayer equipped with specific devices for compensative returns in the tank"*. Therefore, considering the need to complete the controls on the territory, Test Centres were given instruction, in the case of sprayers not equipped with compensative returns and pressure variation exceeding 10%, to pass the sprayer while recording the measured values in the test report. Obviously, the Test Centre can suggest, if necessary, interventions to improve the sprayer, evaluating costs and benefits with the owner, also in relation to the use of the machine, the magnitude of the pressure variation, etc.

The third issue pointed out by some technicians refers to the method to measure of the pressure drop at the end of the last spraying section; it should be noted that, unlike the old standard, ISO 16122 makes the result of the test mandatory to pass the inspection. However, the test methodology is not specified accurately, merely prescribing the placement of a calibrated manometer *"at the same position as a nozzle at the outermost end of each boom section"* (ISO 16122, part 2 – 3). In this regard, it should be noted that there are two ways to perform this measurement: in fact, the reference manometer can be placed "near" the terminal nozzle or "in place" of the latter, using two different versions of the calibrated gauge, regularly on the market, as shown in fig. 4 (source: AAMS Salvarani catalog).

In the first case, the pressure gauge is placed "near" the terminal holder of the bar section, with the nozzle mounted at the drain of the pressure gauge, while in the second it is placed "in place" of the nozzle, thus occluding the discharge. In general, the pressure gauge placed in line with the terminal nozzle is used more frequently during the functional check of the boom sprayers, but nothing prevents the same method from being used on the orchard sprayers, for example to simultaneously measure the flow rate and pressure drop through a special adapter.

The two measurement techniques obviously provide different results: given the same pressure at the inlet of the boom section, the occlusion of the terminal nozzle by the blind pressure gauge causes a reduction in the overall flow rate of the section proportional to the capacity of the closed nozzle. Consequently, the pressure drop is lower than the measurement carried out with the nozzle mounted. The variation in the value of the pressure drop is not high, but since this test, according to ISO 16122, is required to pass the inspection, it was considered interesting to evaluate if, and possibly, under what conditions, the carrying out the test in one way rather than the other can affect the result.



Fig 4 – manometers for measurement of pressure drop

The experimental verification was made on a new air-carrier sprayer with six nozzles per side, using five sets of nozzles at increasing pressures, as shown in table 1.

In absolute terms, the decrease in flow rate resulting from closing the terminal nozzle during the measurement of the pressure drop is not so high to cause a particularly huge increase in the measured parameter. However, as shown in the table, under some conditions (highlighted in the table) this variation is enough to exceed the value of 10%, thus causing the machine to fail the inspection. It must also be said that the sprayer used for the test was new and of rather simple construction, but it is not unlikely that, on a machine with a more complex hydraulic system, the probability that the threshold value will be exceeded increases.

TYPE	FLOW RATE	INLET PRESSURE	TERMINAL NOZZLE			
			CLOSED		OPEN	
			OUTLET PRESSURE	PRESSURE DROP %	OUTLET PRESSURE	PRESSURE DROP %
DISC/CORE 1.0/-	LOW	5	4,9	2,0	4,8	4,0
		10	9,9	1,0	9,5	5,0
		15	14,8	1,3	14,5	3,3
		20	19,6	2,0	19,3	3,5
		30	28,0	6,7	27,0	10,0
ISO 80 015 GREEN	LOW	5	4,8	4,0	4,6	8,0
		10	9,8	2,5	9,2	8,0
		15	14,6	2,7	14,2	5,3
DISC/CORE 1.2/-	MEDIUM	20	19,6	2,0	18,8	6,0
		30	28,0	6,7	27,0	10,0
		5	5,0	1,0	4,8	4,0
		10	9,9	1,0	9,7	3,0
		15	14,9	0,7	14,7	2,0
ISO 80 03 BLUE	HIGH	5	4,7	6,0	4,5	10,0
		10	9,6	4,0	9,1	9,0
		15	14,4	4,0	13,9	7,3
ISO 80 04 RED	HIGH	5	4,6	8,0	4,2	16,0
		10	9,3	7,0	8,6	14,0
		15	14,0	6,7	12,9	14,0

Table 1 – results of the test on the measurement of pressure drop

Finally, by placing another pressure gauge immediately after of the pressure regulator, it was observed that the pressure indicated was almost identical to that measured by the manometer at the end, confirming that the primary source of the pressure drop is the regulator itself. This also confirms the widespread perplexities about the decision to make such proof binding for the passing of the functional control. In fact, it is not possible in almost all cases to implement any corrective action in case of overrun of the 10% threshold; moreover, two identical machines can obtain different results only for the different location of the main pressure gauge.

Inspection of greenhouse spraying equipment

A further in-depth analysis focused on fixed and semi-mobile equipment for spraying protected crops (horticultural and mushrooms), for which no specific guidelines have been published so far; therefore, these inspections are carried out by adapting the protocols provided for the open field equipment. However, given some specific features present on these plants, some inspectors pointed out some operational criticalities, therefore some investigation was made to elaborate some practical suggestions.

For the distribution of plant protection products on greenhouse crops, generally on the ground or on benches, the most common system is based on booms installed on suspended rails that allow the movement along the greenhouse. From a functional point of view, this type of spraying system is completely similar to a generic traditional sprayer for field crops, since the operating principle is identical. The main difference, in addition to the dislocation of the construction parts, concerns the dosing of the pesticide, which does not take place by preparing a diluted mixture contained in the main tank, but is carried out by injecting a concentrated suspension of commercial formulation at the inlet of the boom by a proportional volumetric dosing device (*dosatron*, see fig. 5).



Fig. 5 – spraying equipment in greenhouse and proportional dosing device

The general layout of the plant generally vary depending on the arrangement of the greenhouse and its dimensions, but in principle it includes a series of "spraying units", each consisting of a group of booms connected to a *dosatron* unit for the distribution of the concentrated phytosanitary mixture. There is not a dedicated tank, as the water comes from the central plant; this one may eventually be equipped with tanks, but they are aimed at preparing the fertilizing solution distributed with irrigation and do not fall, therefore, among the constructive elements to be included in the functional check. It is also noted that often, since the same plant is used both for fertigation and for the distribution of plant protection products, the boom has a double line of diversified nozzles, intended for the two different uses; therefore, in this case the functional check concerns only the dedicated line. With regard to the individual points of the functional check, reference was made to the Enama document no. 6 related to field sprayers, making the appropriate modifications. The first operation concerns the identification of the power supply units and the related spraying elements (modules), generally consisting of one or more bars, each stably located on a lane of the greenhouse; these lanes are, in general, uniquely numbered within the farm, so that this number can be referred to for the identification in the testing report. To facilitate operations, an ad-hoc test report has been prepared, based on the official regional forms for field crop sprayers, taking into account the observed specificities. The report consists of two parts, the first one dedicated to the identification and verification of the main mixing unit, the second one for the collection of data relating to the bars belonging to the main unit; this second form is filled in as a number of copies corresponding to the bars in question. Each test report therefore refers to an autonomous unit, supplied by a mixing group, which will be identified, and eventually stamped by the Test Centre. The stamping can be placed on the frame or on the platform where the dispenser is firmly fixed.

The first page of the test report collects the data relating to the mixing unit (typically the *dosatron*), with the description of the type, the identification number and the description of the distribution system; the number of distribution bars / modules supplied by the group and the relative working width

must also be indicated. The elements common to traditional sprayers, such as the manometer, filters and pipes are inspected in the same way; the functionality of the *dosatron* is assessed by measuring the time taken by the device to draw a known volume of water and relating it to the flow rate of the boom in which the product is injected. The attached sheet is compiled for each bar supplied by the mixing unit to which it relates and reports, as in the case of traditional sprayers, the results of checks of horizontality, symmetry, absence of contamination, and data on the nozzle flow rate and anti-drip functionality. The requirements for passing control are the same as sprayers for field crops.

Inspection of mushroom greenhouse equipment

Mushroom plants are not very common, but they also represent important productive situations. The cultivation is carried out in air-conditioned buildings on multi-storey pallets, spaced about 50 cm from each other, on which the cultivation substrate is placed. Each production cycle, lasting six weeks, involves a fungicidal treatment, distributed using the same equipment used for the irrigation of the substrate. A commonly used system is based on mobile carriages as shown in fig. 6. The carriages are hooked to the upper edge of the highest pallet, connected to a tube that carries water at very low pressure (0.5 bar) which feeds - for each pallet - a pair of manifolds that branch off from a central vertical tube. Each of them has four cone nozzles, arranged so as to discharge their jet horizontally, plus a fifth nozzle, of the mirror type, arranged on the upper part of the manifold and also oriented so as to wet the pallet horizontally for its full width (fig. 6).

The movement of the nozzle holder takes place manually; the operator walks backwards, taking care to adjust the speed to distribute the right dose; also, the supply pressure can be adjusted to obtain the correct range of the nozzles to wet the pallet without passing over it.

In the case of the distribution of plant protection products, also in this case a proportional metering device is used.

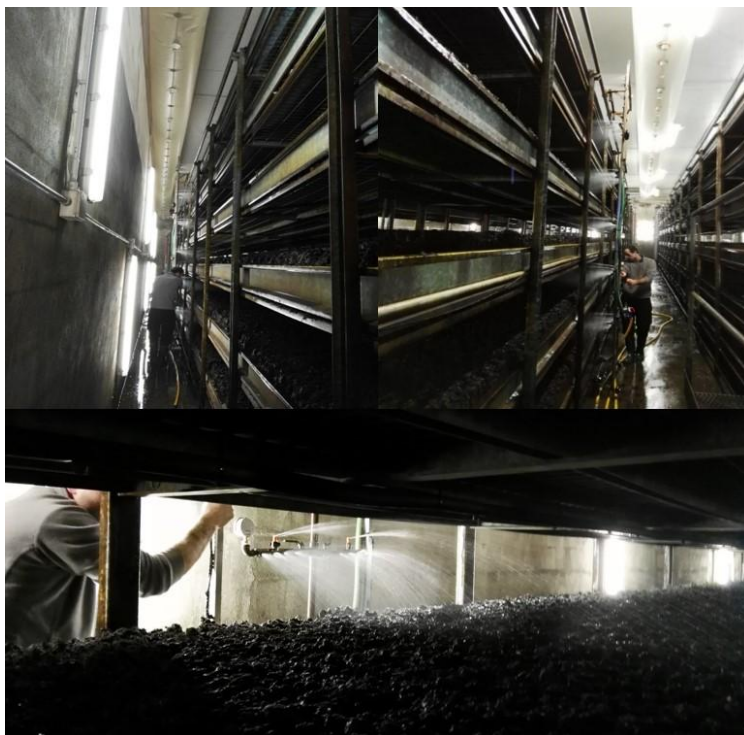

Fig. 6 – carriages for spraying mushroom benches

Compared to the equipment for greenhouse spraying, there are some constructive and functional peculiarities. First, the nozzle carriage is not fixed in the shed, but is moved from a rack of benches to another and between the sheds. No particular problems arise to measure of the nozzle flow, since it is possible to collect it with a specially designed manifold. A complication concerns the very low water

supply pressure, which makes it impossible to fit a traditional anti-drip device, as these operate at pressures above 1-1.5 bar; the problem arises for the first two collectors from below, which drip for about 8 seconds from the moment the tap is closed. The proposed solution is the unloading of the entire column into a container, so that it is possible to re-use the mixture for subsequent treatments, or possibly dispose it according to regulations.

For the functional check, it is therefore possible to use the same test report prepared for the equipment for the greenhouses, taking care to note the construction and functional features in the appropriate spaces. Also in this case, reference will be made to the functional unit constituted by the metering unit, to which all the nozzle carts will be combined, which must be uniquely identified and possibly stamped.

Conclusions and future perspectives

The results of the activity carried out in the Veneto Region allow drawing some considerations.

First, the quality of the services provided by the Centres in this first step of the service was more than satisfactory, as confirmed by the inspections carried out by the Regional authority: all of the accredited facilities resulted in compliance with the requirements of the regional legislation to continue their activity.

Unfortunately, the delayed approval of the National Action Plan, expected by the end of 2011 and approved only at the beginning of 2014, has led to a delay in the start of demands for inspections by agricultural operators. This was due to the missing of a scheduling of the expiration dates for the inspection, together with the false expectation of an extension of the deadline among the operators.

For the above, the progress of the activity of the centres has undergone a certain inertia in the first year, and then accelerated in the following years. A further acceleration of activities, as the expiry date set by the NAP approached, occurred due to the decision of the Region to restrict the concession of the subsidized diesel fuel to the presentation of the certificate of control.

This decision led to a predictable overload for the Test Centres; anyway, they were able to face without excessive problems, considering that no penalties were imposed on companies that did not comply with the obligation of control by the expiration date, provided that the machines were not used before they had been checked, thus granting a *de facto* extension for the duration of winter.

The percentage of completion of inspections at the deadline of 25 November 2016 is almost impossible to assess with precision, given the unavailability of the total number of sprayers involved in the control. However, the initial assessment that assumed this number in about 50,000 units, today appears decidedly overestimated, considering that probably a high number of equipment used in marginal farms, or obsolete and / or requiring heavy interventions to make them suitable for overcoming control, are being scrapped or abandoned. There was also a clear increase in sales of new equipment in 2016 and 2017, as confirmed by Test Centres operating at dealers.

Considering the extension of the full activity of the Centres throughout the spring of 2017, it can be estimated that most of the "professional" companies have fulfilled the obligation; this means that in the Italian situation, Veneto is among the regions that have better implemented the provisions of the SU Directive.

With regard to the activity of the Centres in detail, it has suffered from a strong inertia in the start-up due to the lack of scheduling of the controls, thus resulting overall well below potential capacity. However, considering the large number of recognized Centres, it is likely to expect that, after the first round of inspections, there will be a progressive normalization of the activity, also in consideration of the awareness of the operators that functional control is not to be considered as a further tax, but as an opportunity to improve the efficiency, and indirectly the low cost, of their machinery.

It is also appropriate to point out that the updating activities of the operational protocols by the SPISE and Enama Working Groups are still ongoing, in view of the improvement of the control services implemented by the Regions. Furthermore, it is to be considered that the drift mitigation measures

elaborated by the specific Ministry of Health Commission are now entering the scheme, when authorizing or revising the phytosanitary product labels. These measures will have an impact on the classification of sprayers based on the components installed on them, and consequently on the calibration; the Test Centres will be called to provide indications to users, therefore it will be necessary to plan initiatives for further training and updating of already qualified operators.

Acknowledgments

The Author wishes to thank Dr. Gabriele Zecchin, Venetian Regional Phytosanitary Office, for the effective collaboration provided.

20% reduction of crop protection products in the five main grapes of Sardinia (Cannonau, Carignano, Cagnulari, Nuragus, Vermentino)

Marcello Onorato;¹ Salvatore Aresu;¹ Francesca Fantola;¹ Paolo Schirru;¹

¹ Regional Agency Laore Sardegna - Italy

Summary

The European directive (127/2009 /CE) sets the standards for the sustainable use of pesticides, reducing risks to human health and the environment. It promotes integrated pest management and the use of different techniques related to the use of phytosanitary products, whose consequences converge directly in a reduction of costs in general, thanks to an increase in the efficiency and effectiveness of the processes.

In Sardinia, during the activities related to the functional control of spray machines, we noted that comparing what was declared by the agricultural operator, most companies used different quantities, often in excess, compared to what the spraying machine actually dispersed.

After a careful evaluation of the collected data, it was necessary to assess what action and how to intervene to improve the use of pesticides through the volumes and its relative doses adopted by the companies.

Therefore it was decided to prepare a project capable of achieving the objective to reduce the use of phytosanitary products of 20% in Sardinia's agriculture starting with one of the most important sectors of production, viticulture.

Introduction

The project involves the viticultural companies of the region, and by consulting the register of treatments in use on the farm, it will be possible to know the situation of the cultivated areas, the typologies of phytosanitary products used and the quantities used in phytosanitary defense.

The subsequent adjustment of the sprayer machines, based on the characteristics of the crop, with the help of the apps, the new parameters will be provided for the phytosanitary interventions with the calculation of the appropriate volume and dosage.

The agricultural company will be able to examine and compare all the reference values, such as the declared volume, the volume actually used, and finally, the recommended volume and dose.

By comparing the data we can define the percentages of reduction and savings through the innovative agricultural practice for crop protection.

This is a fundamental issue for appropriate use and rational use of pesticides in three-dimensional crops, as in the case of the vineyard. The progress achieved within the European group "Dose Expression" in the proposal of new models for the expression of the dose of plant protection product (and volume of water) in this type of crops have led to the conclusion of alternatives such as the LWA (Leaf Wall Area) or the TRV (Tree Row Volume). This topic should be dealt with in depth, in both, theoretical and practical sessions, with technicians and consultants directly in contact with farmers. We propose to carry out specific training, in which all the aspects related to the above-mentioned methods will be examined, the criteria for the quantification of vegetation, in comparison with the current recommendations on the labels of phytosanitary products. In this section we will also examine the new technologies applied to this concept (sensors, variable application based on maps, app ...). It is a topic of absolute importance in Europe that will lead to changes in product label instructions.

Through the support of the WebGis system, as a cartographic platform, it will be possible to view, read and examine information on the management of the farm and in particular to observe the volumes adopted in the grape-growing areas involved in the project.

Materials and Methods

The correct use of equipment for phytosanitary applications is a key element and has an enormous influence on the final result. The initial actions of the project will be.

1. Information campaign on the mandatory inspection program: it is proposed to launch an information campaign on the benefits of equipment inspections, with particular attention to the economic benefits for the farmer. This is critical to ensure a good reception of the program by the farmers, preventing the process from becoming a mere administrative obstacle.
2. Information campaign (conventional drift and anti drift) nozzles: the choice of nozzles and proper maintenance of the same for successful applications in phytosanitary defense. Training campaigns on the use of nozzles and the selection procedure will be promoted. Information campaigns will also be conducted on the interest and benefits of using anti-drift nozzles. In these campaigns will be distributed leaflets to explain the operation of the nozzles and economic and environmental benefits, in particular resulting from the significant reduction of drift.
3. Promotion and adoption on the use of new apps: training activities and dissemination of different tools to adjust the nozzle selection, application and determination of the phytosanitary mixture. A personalized print of the atomizer calibration disk and the new DOSAVIÑA application will be published to determine the volume of the dose and of the plant protection product, both realized by the Polytechnic University of Catalonia.
4. New technologies for drift reduction and promotion campaigns will be implemented: training on appropriate use of available technologies for drift reduction. Aspects relating to the adaptation of the aerial assistance will be studied. Advantages and disadvantages of various equipment, demonstration of the effect of air on the deposition and drift.
5. Launch of "demonstration farms" or pilot farms.

"Seeing is believing."The experience of similar programs for the improvement of the application of phytosanitary products demonstrates the interest of having pilot exploits or "demonstration farms" in which to carry out all the recommendations. It is proposed to identify and select some farms in which the cooperating farmers will work with all the recommendations established for the reduction of the use of phytosanitary products, so that other farmers in the area can verify the correct functioning of the measures implemented and the economic results of these. These farms must meet the recommended requirements for compliance with BMP (Best Management Practices).

Results

With the monitoring of the areas and the management of phytosanitary defense interventions in viticultural areas, the evolution of the project regarding the concrete reduction of volumes and doses can be visualized, allowing the interested companies know the progress of the project, so that they feel fully involved in actions that confirm the success of the initiative, with a real economic and environmental advantage.

Conclusion

Sardinia focuses on environmental sustainability and wants to provide companies with the best development opportunities in harmony with current legislation.

The Regional Agency Laore plays a strategic role in supporting local companies and in this sense intends to transfer the methodological innovations of the phytosanitary defense in order to contain the consumption of phytosanitary products, improving the quality of production and reducing the environmental impact in favor of the company and of the society in general.

Homologation and inspection of spray drones in Switzerland

Thomas Anken

Agroscope, Tänikon 1, CH-8356 Ettenhausen

Introduction

Drone technology has made great progresses in recent years. Unmanned multicopters can follow a predetermined flight route very accurately and offer very interesting potential for plant protection in steep slopes of vineyards. Under such conditions, they can replace a lot of manual work and are a promising alternative to applications by helicopters. As no drones are homologated for spraying in Europe so far, standardized procedures are needed to fill this gap. In Switzerland a first type of drone has been homologated. This drone now underlies the same regulations as standard orchard sprayers. As drift measurements have proven a low drift potential of this technique, drones offer an interesting potential for the application of plant protection products.

Multicopters work very accurately

In very steep vineyards the application of plant protection products with hand-held devices is the only alternative to the helicopter. For this reason, airborne application is still important in Switzerland and has been regulated by the federal offices (BAFU 2016). However, the noise emissions as well as the pesticide drift caused by helicopter applications lead to many discussions. In contrast to the strong air stream of big and heavy helicopters, the drones which currently weigh between 20 and 40 kg create a relatively weak airstream. Probably due to their counter rotating 6-8 propellers, no vortex has been detected so far for multicopters. This seems to be an advantage compared to helicopters with one single rotor.

With their horizontally rotating rotors, multicopters cause a vertical air stream that accelerates water drops towards the ground. In contrast to the air flow of conventional orchard sprayers, which is oriented in the orchard in a horizontal or upwards direction, the vertical, soil oriented air stream of drones seems to be advantageous in terms of drift reduction. First measurements of pesticide drift in Switzerland have shown a low drift potential.

These positive properties motivated the different actors to establish a simple procedure to homologate drones for the application of plant protection products in Switzerland.

Elements of the homologation in Switzerland

A homologation procedure was developed in collaboration with the federal offices for environment, agriculture, health, economic affairs and aviation. The drafts have been elaborated and are currently being finalized. The procedure shall be definitively implemented in the coming year. This homologation should consist of the following steps:

Agroscope carries out the technical tests of spray drones

The results are sent to the Federal Office for the Environment, which makes a decision regarding the environmental aspects.

In last instance, the Federal Office of Civil Aviation examines if the regulations of the civil aviation are respected. The Swiss Civil Aviation rules for drones can be found under the following link. <https://www.bazl.admin.ch/bazl/en/home/good-to-know/drones-and-aircraft-models/allgemeine-fragen-zu-drohnen.html>

In case of a successful homologation, the drones are treated as standard orchard sprayers and have to pass the sprayer inspection every three years.

Technical criteria for the homologation in Switzerland

Based on the ISO standard protocols, for the inspection of sprayers a new protocol for the inspection of spray drones has been established (Table 2).

Table 2 Draft of the technical characteristics for the homologation of spraying drones in Switzerland.

Element	Characteristics
Pump and tubes	The entire spray system must be leak-proof at the maximum achievable system pressure. No pressure regulation is requested. Hoses must be arranged so that no kinks and frictions occur.
Agitation system	Circulation of the spray mixture to agitate the spray mixture and to rinse the spray tank must be possible. The agitation does not have to take place at the same time as the application.
Nozzles	The pressure generated by the pump must be such that the working range of the nozzles is within the approved range according to JKI nozzle tables. Flow rate of the individual nozzles compared to the ISO nozzle table: +/- 15% Deviations of the individual nozzle output from the mean output: +/- 10%. Anti-drip: No dripping of the nozzles more than 5 seconds after the spraying has stopped.
Lateral distribution	Testing on a groove patternator with a width of at least 3 m, length 6 m and at least 1.5 times the length of the application width of the drones. Coefficient of variation of the quantities of all grooves: max. 15% (mean of 3 individual measurements)
Tank	The tank has to be leak-proof and its level should be easy to read. Residual volume should be lower than 4%.
Pressure gauge	A pressure gauge is to be carried as an accessory. It should be coupled directly into the spray circuit for control and not alter the flow of the system. The scale must have at least a subdivision of 0.1 bar for working pressures up to 5 bar. The accuracy of the manometer must be at least +/- 0.1 bar of the real value.
Strainer	No separate strainer is necessary on the drone, nozzle filters are sufficient.
Drone-port	The spray drone must be able to land on a drone-port covered with a grid or a perforated plate for filling, emptying and rinsing. The content must be at least 100% of the sprayer tank volume of the drone and cover the entire length and width of the spraying equipment. This drone port must allow lossless rinsing of the drone. The complete emptying of the drone port should be carried out by means of a tap or a pump into lockable containers.
Autonomous navigation	The drone must be equipped with a precise navigation system. Deviation from a predefined flight route: max. +/- 50 cm. The decisive factor is the nozzle height and the center of the application system. The flight route has to be planned before the flight. Afterwards, the drone has to fly the route automatically without further human intervention and execute the spraying process within the predefined perimeter. Switching on and off of the spraying process must be fully automatic. For take-off and landing, human intervention is allowed. In case of more than one flight on the same perimeter (ex. after an empty tank), the drone must automatically restart the spraying process with a precision of +/- 50 cm from where it finished the spraying at the previous flight. Manually switching off the spraying process and human takeover of the drone must be possible at all times.

Wind speed	Wind speed of the drone's airflow is measured on an open field covered with grass by means of tridimensional wind-speed sensors at distances of 10 and 20 m laterally from the drone. The tank of the drone has to be filled completely. Maximum allowed wind speeds are indicated in Table 3
------------	---

To estimate the risk of the spray drift, the wind speeds of the airflows of drones are measured in different distances from the drone. Compared to standard orchard sprayers, which often show speeds of the air stream around 8 m/s, lower maximum speeds for drones between 2 and 5 m/s are proposed to allow their homologation without extra drift measurements (Table 3). This procedure shall allow for the quick testing of drones and make it possible to estimate the risk of drifts of new models.

Table 3 Proposed speed limits for the airflow of drones.

Distance to drone	Height above soil	Maximum speed of the air flow m/s
10 m	1 m	5 m/s
	2 m	3 m/s
20 m	1 m	3 m/s
	2 m	2 m/s

Outlook

Goal of the proposed homologation process for drones is to allow an efficient, simple and non-bureaucratic process. As aerial applications of plant protection products underlie specific rules, supplementary restrictions have to be taken into account. As the first experiences are very positive and several companies are already demanding the homologation of their drone, we expect to put the new homologation process into force for 2019.

Nevertheless, we hope that standardized protocols will be established on a European level very soon. They should allow to simplify the whole process and to guarantee the mutual recognition of spray drones like this is implicitness for all other sprayers.

Literature

BAFU (Hrsg.) 2016: Ausbringen aus der Luft von Pflanzenschutzmitteln, Biozidprodukten und Düngern. Vollzugshilfe für Vollzugsbehörden und Anwendung. Bundesamt für Umwelt, Bern. Umwelt-Vollzug Nr. 1623: 41 S.

Session 3: Harmonized test methods for PAE not included in ISO EN 16122 series (continue)

The SPISE Advice for functional inspection of wiper applicator.

Paolo Balsari¹, Gianluca Oggero¹ Jaco Kole²,

¹DiSAFA, University of Turin, Largo Braccini 1 -Grugliasco (TO) Italy

²SKL, Agro Business Park 24, 6708PW Wageningen, The Netherlands

Introduction

The weed wiping technique is widely used in arable crops and grassland to control volunteer crops like weed beet and general weed populations like bracken, rushes, thistles and ragwort in grassland, red rice in rice field (www.monsanto-ag.co.uk) and volunteer potatoes in sugar beets. The working principle of the machine is generally based on the difference in height between the weed plants and the crops. The European Directive 128/2009 provides that also wiper devices are subject to a mandatory functional inspection.

In these type of in Pesticide Application Equipment (PAE), herbicide/chemical mixture concentrated (up to 60%, fig 1 – type A) or herbicide/chemical product not diluted (fig 3 – Type B) is supplied to an absorbent surface (e.g. cotton, sponge roller with carpet for type A, fig 2, and cord for type B). The herbicide/chemical product soaked surface only contacts targets that in same case (e.g. weed control in rice -sugar beets) can be taller than the crop. Chemical is transferred to the surface of the target as the applicator "wipes" over them.



Fig. 1–Example of weed wiper (distribution of mixture concentrated – Type "A"). Photo: <http://www.fwi.co.uk> and <http://grassworksmanufacturing.com>





Fig. 2 - Examples of sponges. Photo: <http://www.fwi.co.uk> and <http://www.forestry-suppliers.com/>



Fig. 3 - Example of weed wiper (distribution of herbicide not diluted using a cord – Type “B” – Photo: MAR snc).



Fig. 4 – Particular of cord (Photo G. Oggero)



Fig. 5 – Particular of tank for herbicide open and closed whit pulley system (Photo: G. Oggero)

At present no EN or ISO Standards for functional inspections are available. This considered, a **Spice Advice** on how to make their functional inspection, following when possible the harmonized Standard EN ISO 16122 part 1& 2, has been developed inside the SPISE TWG.

1. Pre-inspection

Test suitable for both types of wiper (A&B)

It is important that the inspection can be executed in a way that is safe for the inspector and the environment, and for allowing that a pre-inspection shall be performed. The real inspection can only start when the requirements in the pre-inspection are fulfilled. These last shall be checked following EN ISO 16122-1 (when applicable).

2. Requirements and method of verification

2.1 Leaks

Test suitable for both types of wiper (A&B)

The tank(s) for chemical mixture/herbicide should be filled with water to its nominal capacity.

With the pump, if provided, not running and the machine parked on level horizontal surface, a visual inspection for any leakage shall be carried out.

Method of verification: visual check.

2.2 Dripping

Test suitable for both types of wiper (A&B)

With the pump, if provided, running at a pressure which is equal to the maximum obtainable pressure for the system, with the section valves closed, there shall be no leakage from any part of the machine.

Method of verification: visual check

2.3 Pump

Test suitable for wiper "A"

2.3.1 Pump capacity

The pump capacity shall be suited to the needs of the equipment.

Method of verification: visual check.

2.3.2 Pulsations (if pressure gauge is provided)

The pulsations shall not exceed 10 % of the working pressure.

Method of verification: visual check, measurement and function test. (see clause 3.1)

2.3.3 Air chamber (if provided)

The membrane shall not be damaged. There shall be no appearance of liquid when operated at the maximum pressure recommended by the manufacturer. The air pressure shall be the pressure recommended by the manufacturer. Normally 1/3 of the spray pressure is used.

Method of verification: measurement and function test

2.4 Agitation

Test suitable for wiper "A"

If the wiper only is used with chemicals which go into a solution (e.g. Glyphosate), no agitation is needed. Often these small wipers only have pump capacity for operating, not for agitation. Agitation systems are usually not installed in this type of machine.

If an agitation system is present it shall be work as is indicated in 2.4.1-2.4.2

2.4.1 Hydraulic

A clearly visible agitation shall be maintained:

- when operating at the maximum working pressure as recommended by the manufacturer;
- with pump rotation speed as recommended by the manufacturer;
- with the tank filled to half its nominal capacity.

Method of verification: visual check

2.4.2 Mechanical

A clearly visible agitation shall be maintained when the agitation system is working as recommended by the manufacturer, with the tank filled to half its nominal capacity.

Method of verification: visual check

2.5 PPP tank

2.5.1 Lid

Test suitable for both types of wiper (A&B)

The tank shall be provided with a lid that shall be well adapted and in good condition.

This lid shall be tightly sealed to avoid unexpected opening.

If a vent is fitted in the lid it shall prevent spillage.

Method of verification: visual check.

2.5.2 Filling hole(s)

Test suitable for wiper "A"

There shall be a strainer in good condition in the filling hole(s).

If the filling hole is smaller than 100 mm (smaller wipers), there shall be a funnel with sieve.

Method of verification: visual check.

2.5.3 Pressure compensation

Test suitable for wiper "A"

There shall be a pressure compensation device to avoid over-pressure and under-pressure in the tank.

Method of verification: visual check.

This is not a requirement for machine that operate at very low pressure

2.5.4 Tank content indicator(s)

Test suitable for wiper "A"

The volume of liquid in the tank shall be clearly readable from the operator's position and/or from where the tank is filled.

Method of verification: visual check.

2.5.5 Tank emptying

Test suitable for both types of wiper (A&B)

It shall be possible to

— empty the tank e.g. using a tap, and

— collect the liquid without contamination of the environment and without potential risk of exposure of the operator.

Method of verification: visual check.

2.5.6 Tank filling

Test suitable for wiper "A"

If there is a water filling device on the machine, water from the machine shall be prevented from returning to the water source, e.g. by means of a non-return valve.

Method of verification: visual check

2.6 Cleaning device for plant protection product container

Test suitable for both types of wiper (A&B)

If provided, the cleaning device for plant protection product container shall work properly.

Method of verification: visual check function test.

2.7 Cleaning equipment

Test suitable for both types of wiper (A&B)

If provided, tank cleaning devices, devices for external cleaning, devices for cleaning of induction hoppers, and devices for the internal cleaning of the complete machine, shall function.

Method of verification: visual check and function test.

2.8 Controls

2.8.1 General

Test suitable for both types of wiper (A&B)

All the devices for measuring and/or adjusting the pressure and/or flow rate shall function. The valves for switching on or off the distribution shall operate properly.

Only if the machine shall be adjusted during operation the controls shall be operable from the operator's position and the instrument displays shall be readable from this position.

Method of verification: visual check and functioning test.

Note: Turning of the head and the upper body is acceptable to achieve these requirements

Switching on and off individual machine sections, if provided, shall be possible.

Method of verification: visual check and function test.

2.8.2 Pressure indicator (if provided)

Test suitable for wiper "A"

The scale of the digital or analogue pressure indicator shall be clearly readable from the operator's position and suitable for the working pressure range used.

Method of verification: visual check.

The scale of **analogue pressure indicators** shall provide graduations at least every 0,2 bar for working pressures less than 5 bar;

Method of verification: visual check.

The accuracy of the pressure indicator shall be

— $\pm 0,2$ bar for working pressures at 2 bar and below,

— ± 10 % of the real value for pressures at 2 bar and above.

Method of verification: according to clause 3.2

For analogue pressure indicators the minimum diameter shall be 63 mm

Method of verification: measuring

2.8.3 Pressure adjusting devices (if provided)

Test suitable for wiper "A"

All devices for adjusting pressure shall maintain a constant pressure with a tolerance of 10 % at constant setting and shall return within 10 s to the original working pressure ± 10 % after the equipment has been switched off and on again.

Method of verification: function test.

2.9 Hoses

Test suitable for both types of wiper (A&B)

Hoses shall not show excessive bending and abrasion through contact with surrounding surfaces. They shall be free from defects such as excessive surface wear, cuts or cracks.

Method of verification: visual check.

2.10 Filters

Test suitable for wiper "A"

2.10.1 Presence

If using Glyphosate only, no filters are required

If pump is provided there shall be at least one filter on the discharge side of the pump and, in case of positive displacement pumps, one filter on the suction side.

The filter(s) shall be in good condition.

Method of verification: examination of filter specification and visual check.

2.10.2 Isolating device

It shall be possible, with the tank filled at its nominal volume, to clean filters without any spray liquid leaking out except for that which may be present in the filter casing and the suction lines.

Method of verification: function test.

2.10.3 Filters insert changeability

Filter inserts shall be changeable in accordance with the machine manufacturers' instructions.

Method of verification: visual check and function test.

2.11 Boom

Test suitable for both types of wiper (A&B)

2.11.1 Stability/alignment

Horizontal boom shall be stable in all directions, i.e. no excessive movement caused by wear and /or permanent deformation.

Method of verification: visual check.

2.11.2 Automatic resetting

When provided, the automatic resetting of horizontal boom shall operate to move backwards and/or forwards, in case of contact with "critical" obstacles.

Method of verification: visual check and function test.

2.11.3 Vertical position

When measured with the machine stationary, the difference between maximum and minimum distance from boom and a horizontal reference line (e.g. on a level horizontal surface) shall not vary more than ± 10 mm or ± 0.05 % of the working width, whichever is the highest.

Method of verification: measurement.

2.11.4 Height adjustment

When provided, height adjustment devices shall function.

Method of verification: visual check and function test.

2.11.5 Damping, slope compensation and stabilization

When provided, devices for damping unintended boom movements, slope compensation and stabilization systems shall function.

Method of verification: visual check and function test.

2.12 Weed detection system and other electronic/mechanical devices

When provided, shall work properly.

Method of verification: visual check

2.13 Condition of the cloth/roll/cord

The cloth, the material where the roll is covered with or the cord shall be in good condition and shall have no visible damages.

Method of verification: Visual check

2.14 Humidification of the cloth/roll/cord

All provisions which ensure the correct wetting of the cloth / roll / cord shall function properly.

Method of verification: Functional test

3. Test methods

3.1 Pump pulsations

Pulsations shall be checked:

- with nominal rotation speed of the pump;
- at the location of the machine's pressure indicator (with calibrated test pressure indicator).

3.2 Machine pressure indicator

3.2.1 Specifications of pressure indicators used for verification

Analogue pressure indicators used for testing shall have a minimum diameter of 100 mm and shall be damped. Other minimum requirements on pressure indicators used for testing are given in Tab. 1.

Pressure to measure Δp bar	Scale unit max. bar	Accuracy bar	Class required	Scale end value bar
$0 < \Delta p \leq 6$	0,1	0,1	1,6	6
			1,0	10
			0,6	16
$6 < \Delta p \leq 16$	0,2	0,25	1,6	16
			1,0	25
$\Delta p > 16$	1,0	1,0	2,5	40
			1,6	60
			1,0	100

1 bar = 0,1 MPa = 0,1 N/mm² = 10⁵ N/m².

Tab. 1 – Characterization of pressure gauge used for testing (in accordance with EN 837-1)

3.2.2 Verification method of the machine pressure indicator

The machines' pressure indicator shall be tested mounted on a test bench.

Measurements shall be carried out with both increasing and decreasing pressures in each case as a minimum at 4 equally spaced points within the relevant working pressure range.

The measurements require a stable pressure (no pump pulsations).

Conclusion

Wiper applicator are of different type, with different hydraulic circuit, boom dimension and this made difficult to give a general address about how to made their functional control. Otherwise been detailed standards specification/requirements not available for new wiper applicator equipment, those indicated in this draft SPISE Advice are necessary limited and has been developed in cooperation with users, manufacturers and testing stations of this type of equipment.

The specification/ requirements mentioned in this SPISE Advice could be also taken as guidance in design of new equipment till standard requirements for new equipment will be not available.

References

EN ISO 16122-1 (2015) - Agricultural and forestry machinery - Inspection of sprayers in use - Part 1: General.

EN ISO 16122-2 (2015) - Agricultural and forestry machinery - Inspection of sprayers in use - Part 2: Horizontal boom sprayers.

The SPISE Advice for functional inspection of seed treatment equipment

Hans-Jürgen Osteroth¹ Eskil Nilsson²,

¹ Julius Kühn-Institute, Institute for Application Technique in Plant Protection, Messeweg 11-12, 38104 Braunschweig, GERMANY

² Visavi God Lantmannased AB, Verkstadgatan 2, 235 32 Vellinge, SWEDEN

Summary

The new SPISE Advice for the inspection of seed treatment equipment (STE) which deals with requirements for mobile and stationary equipment will be presented. As there are no European or international standards for these types of devices available up to now, the requirements had to be developed first. For mobile seed treatment equipment such as equipment on potato planters the requirements are strongly based on comparable requirements for sprayers in use, EN ISO 16122-series. For stationary systems special requirements apply. Seed treatment equipment is relative to field spraying used in minor scale. According to Directive 128/2009/EU Article 8, 3.a, it could be possible for Member States to apply a different timetables and inspection intervals for such equipment. E.g. equipment for laboratory use or industrial use already engaged in quality assurance systems could be situations where such exemptions could be regarded. For Germany it is planned, to exempt STE with a batch weight of less than 5 kg from the inspection.

In the course of the processing of the requirements, various companies and groups were involved in the discussion, e.g. STE manufacturers SUET, Niklas, Petkus, SATEC, Grimme, plant protection product (PPP) manufacturers like BAYER, SYNGENTA, ADAMA and BASF and other groups e.g. UNIKA (union of the German potato industry).

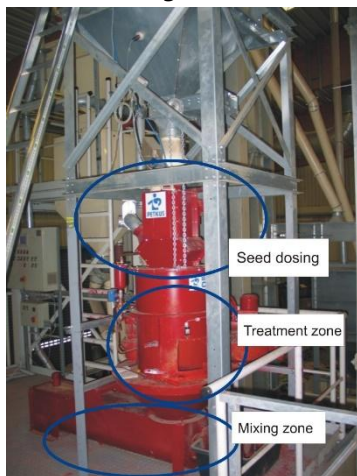

Pic. 1: Principle for continuous seed treatment equipment included in inspection process: Seed dosing, treatment zone, mixing chamber.

The Advice is divided into general requirements (before inspection and during the inspection), test methods and test report.

First, it is important to define the devices to be controlled, e.g. which equipment belongs to the STE and which equipment is part of the machinery which are used to prepare and transport the seed to the STE and after treatment transport to the bagging station. As STE are in this sense regarded all parts which coming into direct contact with the treatment liquid such e.g. hoses, lines and pumps from the PPP-container (or separate mixing container) to the spray and mixing chamber, the treatment zone, post-mixing device(s), seed and liquid dosing systems and provided mixing container. Not included in the inspection are parts of facilities before or after the seed treatment process such as fans for aspirators, augers or conveyer for transport of seeds, balances for weighing seeds packages as well as storage for plant protection products.

In the following some seed treatment equipment are presented.

1. Continuous treatment: stationary equipment for cereals: Rotary atomizer followed by mixing auger in mixing chamber

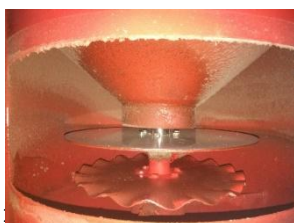

Pic. 2: Rotary atomizer in a continuous seed treatment system.



Pic. 3: Mixing chamber

2. Semistationary equipment for treatment of potatoes, transport conveyer with rotary atomizer under hood.



Pic. 4 and 5: Rotary atomizer under a hood

3. Continuous treatment in auger: "eg Transmix"



Pic. 6: Continuous treatment in auger like "Trans-Mix"

4. Batch seed treatment principle

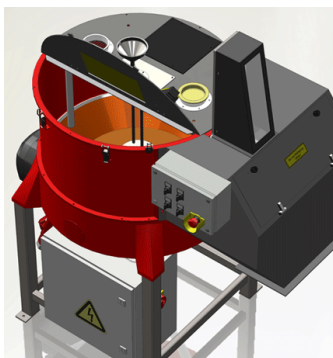

Pic. 7 (left): Mixing chamber (rotating drum, cone with funnel for manual dosing or automatic dosing and introduction of PPP. Picture from SATEC (Germany).



Pic. 8 right): Mixing chamber with rape seed with introduction of PPP via pump to a rotating disc atomizer

5. Mobile spraying on seeds



Pic. 9: Mobile spraying on seeds: Potatoe planter with nozzle between hopper and soil

Not regarded as STE in Spise Advice are bandspraying equipment like spraying on potatoes laying in soil or on soil. Memberstates have different principles of what should be regarded as sprayers or as seed treatment equipment. E.g. Germany will regard Rotary atomizer under hood (pic 5) as a sprayer and thus inspected according to EN-ISO 16122-2.

The Spise Advice for seed treatment equipment is to be used for functional inspection of equipment for seed treatment in professional use. This means equipment for applying plant protection products (PPP) in liquid form on seeds to prevent or treat diseases. For seed treatment equipment using PPP in solid form as powders, applicable parts of this Spise Advice can be used together with applicable parts of Spise Advice for granular spreaders.

In the following the requirements and test methods for seed treatment equipment are given. Due to the very different equipment (stationary devices and mobile devices on seeders or potato planters) not every requirement may apply. In such cases, a note should be included in the test report.

Requirements and method of verification

General:

As Some of the tests could lead to a hazardous situation, any inspector performing tests in accordance with this standard should be appropriately trained in the type of work to be carried out. National or local regulations regarding health and safety may apply e.g. on availability of personal protective equipment. As the inspections are carried out in contaminated environment, it is important that the inspector wears appropriate protective clothings.

The operator of the equipment should be present at the inspection. Visible and other known faults should be repaired before the inspection start.

All necessary inspection equipment shall be checked at regular intervals with certified equipment according to national or local regulations. Proof of results of checks shall be available.

Place for inspection

The inspection shall be made in a location avoiding any risk of pollution of environment, this means that at least the sprayed/leaked liquid shall be collected and transferred back into the equipment's tank at the end of the test.

Inspection materials

All inspection measurements shall be carried out without seed and with water as substitute for PPP. Provided that the dosage should still be checked with seeds and chemicals, it shall be possible to collect the material separately and without treating any seed e.g. by collecting before treatment zone in the equipment.

1. Pre-Inspection

1.1 General. A preliminary inspection shall be carried out so that the inspection can not be continued because of heavy contamination, incrustations etc. and incidents that could result in either injury or damage to the health of the inspector.

1.2 Cleaning. The seed treatment equipment shall be cleaned in order to be able to perform the inspection without risks for the inspector. Cleaning shall include internal parts including present filters, filter inserts and external parts giving special consideration to areas of contamination to which the inspector could be exposed during the inspection.

Method of verification: visual check.

1.3 Unintended discharge of PPP during operation shall be prevented. PPP containers (original containers) shall be placed so that spillage is collected.

Method of verification: visual check.

1.4 Moving parts and power transmission parts. Power transmission parts s.a. rotating shafts, chains, belts etc driven by mechanical, hydraulic or electrical means shall be protected to necessary level. All guards provided for protection of the operator shall be present and be functioning correctly. Where possible or when not required for the function of the equipment, all access to other moving parts shall be prevented by specific safety devices to prevent any risk to the inspector.

Method of verification: visual check.

1.5 Pipes and hoses for hydraulic transmission. If present, there shall be no visible leakage from the hydraulic system. Hydraulic hoses shall not show excessive bending and abrasion through contact with surrounding surfaces. They shall be free from defects such as excessive surface wear, cuts or cracks. Hydraulic pipes shall be retained in position and be free of significant corrosion or damage.

Method of verification: visual check.

1.6 Electric power transmission. If present, electrical connections for electrical drive (connectors, cables) shall be free from bruises, cracks, deformations or exposed wires.

Method of verification: visual check.

1.7 Structural parts and framework. All structural parts and the framework shall be in good condition, without permanent deformations, significant corrosion or other defects which could affect the rigidity or the strength of the equipment.

Method of verification: visual check.

1.8 Lockable foldable parts. Locking of foldable parts of the equipment shall secure these parts in their intended positions.

Method of verification: visual check.

1.9 Blower/fan. If provided, on the seed treatment equipment (e.g. aspiration), the blower (fan, casing, air deflectors) shall be in good condition and mounted in a functional manner. Inspection shall verify in particular that:

- blades are not missing or damaged;
- all parts are free of mechanical deformation, excessive wear, corrosion sufficient to interfere with safe operation and significant vibration;
- guarding to prevent access to the fan is present.
- the blower shall work properly at the nominal working range of PTO speed, e.g. no vibrations due to imbalance, no friction between the body and the fan or wrong orientation of the blades.

Method of verification: inspection.

2. Requirements

2.1 Leaks

2.1.1 Static leaks. For spraying equipment equipped with a tank or mixing container, the tank should be filled to its nominal capacity.

With the pump not running and a visual inspection to determine any leakage from all part of the machine (tank, pump and associated pipes...) shall be carried out. No leakage is allowed.

Method of verification: visual check.

2.1.2 Pump leakage. There shall be no leakages (e.g. dripping) from any parts of the pump while pumping clean water at its normally used rotation frequency. For equipment not equipped with a tank, water is pumped from an external container or tank.

Method of verification: visual check and function test

2.1.3 Lines leakage. There shall be no visible leakage from pipes or hoses including their coupling when used at the normally flow for the system.

Method of verification: visual check and function test

2.2 Pump(s)

2.2.1 Capacity. The pump capacity shall be suited to the needs of the equipment.

Method of verification: visual check

2.2.2 Air chamber. If an air chamber is present, the air pressure shall be the pressure recommended by the equipment manufacturer or from 30 % to 70 % of the working pressure.

The membrane shall not be damaged (no liquid shall appear when testing the air valve).

Method of verification: function test and measurement.

2.3 Spray mix agitation (in case of a present tank or mixing container). A clearly visible agitation shall be maintained when the agitation system is working as recommended by the manufacturer, with the tank or mixing container filled to half its nominal capacity. For hydraulic agitators, the following specifications apply:

- operate at the maximum working pressure of the spraying equipment,
- use the largest nozzles and all nozzles mounted on the spraying equipment are in use,
- pump rotation frequency as recommended by the manufacturer,
- with the tank filled to half its nominal volume.

Method of verification: visual check.

2.4 Mixing tank or tank for spray liquid. There shall be a pressure compensation device to avoid over-pressure and under-pressure in the tank. If present, the tank shall be provided with a lid that shall be well adapted and in good condition, free of deformations, holes etc. This lid shall be tightly sealed to avoid unexpected opening and lose.

If present, the tank-emptying valve shall operate reliable and it shall be possible to collect the tank content without contamination of the operator or environment.

Method of verification: visual check.

2.5 Mixing device for continuous seed treatment equipment. If a mixing device is present: The state of the mixing device shall be in good condition to assure its correct functioning. Note: The condition of the components of a mixing device such as a brush, auger or paddle shall be checked. The function of the mixing device shall be noted.

Method of verification: visual check.

2.6 Cleaning

2.6.1 Cleaning device for plant protection product container. If provided, the cleaning device for plant protection product container shall work properly.

Method of verification: function test.

2.6.2 Cleaning equipment. If present, tank cleaning device, device for external cleaning and device for cleaning of additional equipment s. a. induction hopper, and devices for internal cleaning of complete equipment shall work properly.

Method of verification: visual check and function test.

2.7 Measuring systems, controls and regulation systems

2.7.1 General. It shall be possible to collect the operated seeds and PPP independently to determine the amounts in order to check the dose rate. For continuous seed treatment equipment the flow of seed or PPP shall automatically stop if one or the other is interrupted.

All devices for measuring and/or adjusting the pressure and/or flow rate shall operate properly. The valves for switching on or off the spray shall operate properly.

Method of verification: visual check and function test.

2.7.2 Controls. All controls shall operate reliably and be able to be operated from the operator's position during operation. Instrument displays shall be readable.
Method of verification: visual check, function check.

2.7.3 Scale of pressure indicator. Digital or analogue pressure indicator used for the dosing of PPP, if present, shall be clearly readable from the operator's position and suitable for the working pressure range used.

NOTE: For analogue pressure indicators the recommended minimum diameter is generally 63 mm.

Method of verification: visual check.

The scale of **analogue pressure indicators** shall provide graduations:

- at least every 0.2 bar for working pressures less than 5 bar;
- at least every 1.0 bar for working pressures between 5 bar and 20 bar;
- at least every 2.0 bar for working pressures more than 20 bar.

Method of verification: visual check.

2.7.4 Accuracy of pressure indicator. The accuracy of the pressure indicator shall be

- ± 0.2 bar for working pressures at 2 bar and below,
- $\pm 10\%$ of the real value for pressures at 2 bar and above.

Method of verification: according to 3.3.

2.7.5 Pressure or flow adjusting devices. All devices for adjusting pressure or flow shall maintain a constant pressure or flow with a tolerance of 10 % at constant setting. Pressure or flow shall return to the original working pressure or flow $\pm 10\%$ after the equipment has been switched off and on again.

NOTE: The inspection is not possible on equipment where seed and PPP flow must run at the same time and cannot be shut off individually.

Method of verification: function test and measurement according to 3.3.3 and 3.3.4.

2.7.6 Other measuring devices. Other measuring devices especially flow meters and forward speed sensors used for controlling the volume rate, shall measure within a maximum error of $\pm 5\%$ of the value read on the reference instrument within the range of the measuring device.

Method of verification: measurement according to 3.4.2.

2.8 Lines (pipes and hoses)

2.8.1 Bending / abrasion. Hoses shall not show excessive bending and abrasion through contact with surrounding surfaces. They shall be free from defects such as excessive surface wear, cuts or cracks. They shall be mounted in a way to avoid blockage or damages.

Method of verification: visual check.

2.9 Filtering

2.9.1 Filters presence. If present, filter(s) shall be in good condition and the mesh size shall correspond to the nozzles fitted according to the instructions of nozzle manufacturers.

Method of verification: examination of specification and visual check.

2.9.2 Filter inserts changeability. Filter inserts shall be changeable in accordance with the equipment manufacturers' instructions. Method of verification: visual check and function test.

2.10 Application units

2.10.1 Stability. Holders for nozzles or atomizers, if present, shall be stable in all directions, i.e. no excessive movement and not be bent.

Method of verification: visual check.

2.10.2 Nozzle /atomizer spacing / orientation. It shall not be possible to modify unintentionally the position and direction of the nozzles in working conditions.
It shall be possible to collect flow from nozzles or atomizers for measurement and calibration.
Method of verification: visual check.

2.11 Nozzles / atomizers

2.11.1 General. The atomizers for PPP shall not be affected in their function e. g. by encrustations or dirt.
Method of verification: visual check.

2.11.2 Dripping. After being switched off there shall be no continuous dripping after the liquid flow has been shut off.
NOTE: Dripping may occur for a maximum of 5 seconds after the liquid flow has been shut off.
Method of verification: visual check.

2.11.3 Flowrate.

Nominal nozzle-/ atomizer flow rate known:

The deviation of the flow rate of each nozzle shall not exceed 10 % of the nominal flow rate at the working pressure.
Method of verification: measurement according to 3.4.

Nominal nozzle flow rate unknown:

The flow rate of a single nozzle/atomizer shall not exceed ± 10 % of the average flow rate of the nozzles/atomizers of the same type mounted on the equipment.

In case of only two nozzles of a same type and size, the average value is not considered but the deviation between the two nozzle.

In case of only one nozzle, a measurement is performed at a normally used setting to give the operator information about flow.

Method of verification: measurement according to 3.4.

2.12 Chemical dosing system

Dosing systems shall:

- not leak;
 - have no backflow leakage through the chemical pathway or water inlet of the dosing unit;
- Setting of dose adjustment shall be clearly readable.

Method of verification: inspection, function test.

2.13 Other electronic devices. When provided, shall work properly. Examples of equipment are level indicators, level control, level switches, flow control, flow switches

Method of verification: visual check and function test.

2.14 Other equipment. When provided shall function according to original design and shall not be influenced by wear and damages.

Method of verification: visual check and function test.

3 Test methods

3.1 Pump capacity test (optional)

3.1.1 Test method. The pump capacity shall be measured using the following procedure:

a) On equipment not fitted with a test adapter, when the pump capacity is not given by equipment manufacturer for the pump mounted on the equipment or for pumps for which the maximum working pressure is not known, a calibrated pressure indicator shall be placed at an end nozzle and the

maximum working pressure recommended by the equipment manufacturer or the nozzle manufacturer during test shall be established and used.

b) The tank shall be filled with clean water to half its nominal volume. A correct and clean filter shall be placed on suction side of the pump in accordance with the equipment manufacturer’s instructions. All connections shall work properly without leakage at maximum operating pressure and without air inlet.

Connect the measuring device as close as possible to the pump outlet or at a position provided by the equipment manufacturer.

In case of multiple pumps with separate outlets, one for agitation and one for nozzles, the measuring device shall be connected according to the equipment manufacturer’s instructions, either on each outlet separately or to both outlets connected together.

Water discharged from the measuring device shall be fed back into the main tank or mixing tank. The pump shall be operated at the nominal rotation speed given by the pump manufacturer. Pumps with variable flow, driven by wheels, shall be operated according to the instructions given by the manufacturer.

The flow shall be measured at free outlet at one pressure between 8 (± 0.2) bar and 10 (± 0.2) bar, or if lower at the highest permitted working pressure for the pump.

3.1.2 Test equipment. The error of the flow meter shall not exceed 2 % of the measured value when the capacity of the pump is >100 l min⁻¹ and 2 l min⁻¹ when the capacity of the pump is < 100 l min⁻¹. The flow measuring device shall have a transparent part to identify air leakages on the pumps suction side.

3.2 Pump pulsations. Pulsations shall be checked:

- with nominal rotation speed of the pump;
- at the location of the equipments pressure indicator (with the calibrated test pressure indicator).

3.3 Verification of pressure indicators

3.3.1 Specifications of pressure indicators used for verification

Analogue pressure indicators used for testing shall have a minimum diameter of 100 mm and shall be damped. Other minimum requirements on pressure indicators used for testing are given in Tab. 1.

Tab. 1 – Characterization of pressure gauge used for testing in accordance with EN 837-1

Pressure to measure	Scale unit max. (bar)	Accuracy (bar)	Class required	Scale end value (bar)
Δp (bar)				
$0 < \Delta p \leq 6$	0,1	0,1	1,6	6
			1,0	10
			0,6	16
$6 < \Delta p \leq 16$	0,2	0,25	1,6	16
			1,0	25
$\Delta > 16$	1	1	2,5	40
			1,6	60
			1,0	100

1 bar = 0.1 MPa = 0.1 N/mm² = 10⁵ N/m²
 Source: EN ISO 16122-2:2015

3.3.2 Verification method of the pressure indicator. The pressure indicator shall be tested mounted on the equipment or on a test bench. Measurements shall be carried out with both increasing and decreasing pressures in each case as a minimum at 4 equally spaced points within the relevant working pressure range.

The measurements require a stable pressure (no pump pulsations).

3.3.3 Measurement of the pressure variation when the spray is switched off. Pressure variation shall be checked at the location of the equipments pressure indicator. The variation of the value indicated by the calibrated test pressure indicator is observed and recorded when the spray is switched off and on again. The pressure shall be observed 10 s after spray is shut off.

3.3.4 Measurement of flow variation when the spray is switched off. Flow variation shall be measured by measuring flow as described in 3.4.2 two times; first during spraying and second after the spraying has been shut off and then on again. The measured values are compared to each other.

3.4 Measurement of the flow rate of the spray nozzles / atomizers

3.4.1 General. This test may be performed with nozzles mounted on the equipment or removed from the equipment. It shall be ensured that the spray jets are correctly formed when nozzles are mounted on the boom and before dismounting.

The error in the measured flow shall not exceed 2.5 % of the measured value. The test shall be carried out at a working pressure relevant for the use of the equipment.

3.4.2 Measurement with nozzles fitted on the equipment. Agricultural nozzle:

The flow rate of each nozzle shall be measured according to ISO 5682-2:2017, 8.1, *except 8.1.1*.

The measuring device shall have an accuracy of maximum 1 % error of the measured value.

3.4.3 Measurement with nozzles removed from the equipment. Agricultural nozzle:

The measurement of the flow rate of each nozzle shall be carried out on a test bench.

The test bench consists of a pump by which water with a certain pressure can be pumped through the nozzle, a pressure regulator, a pressure indicator (analogue or digital) by which the actual pressure can be monitored and a flow meter by which the actual flow rate can be measured.

The pressure indicator shall meet the requirements in 3.3.1.

The liquid system, adapters, etc. shall not have an influence on the flow rate.

Conclusion

Due to the missing standard for the inspection of used equipment, requirements for seed treatment equipment (STE) have been developed under discussion with equipment manufacturers and associations. Because the design of the devices can be very different, special requirements are required for stationary STE, while the requirements for mobile equipment, mostly used on potato planters or in storage houses for potatoes are based on the existing requirements for sprayers according ISO 16122-2. Due to the very different devices, not every requirement will be applicable.

References

Directive 2009/128/EC of the European Parliament and of the Council of 21 October 2009 establishing a framework for Community action to achieve the sustainable use of pesticides. <http://eur-lex.europa.eu/eli/dir/2009/128/2009-11-25>

EN ISO 16122-2 Agricultural and forestry machinery – Inspection of sprayers in use – Part 2: Horizontal boom sprayers (ISO 16122-2:2015)

JKI Guideline 1-1.5, Requirements for seed treatment equipment, 04-2013

Advice for functional inspection of postharvest application equipment

Francesc Solanelles

Centre de Mecanització Agrària. DARP
Generalitat de Catalunya
Rovira Roure, 191
25198 Lleida. Spain

1. Introduction

Postharvest pesticide applications are made just before fruits and vegetables are put in the market. So, the risk for the consumer health of using equipment not well adjusted or in bad condition is very high.

There are different kinds of equipment for postharvest pesticide application, with clear differences in design, use, adjustment, etc. So, the inspection methodology should be able to adapt to each case.

The guideline is based mainly on the EN ISO 16122-4 standard, which has been adapted to the special features of postharvest pesticide application equipment, not considered in the inspection standard of fixed and semi-mobile sprayers

Mainly, the following kind of equipment for postharvest applications can be found,

- Drencher. Fruit containers are sprayed with high amounts of water. The containers can be static or moving along a belt, but the application time has to be always monitored. There are also on-line drenchers, where the fruits, without containers, go through small “waterfalls” of the application liquid, with the help of brushes.
- Bath. Fruits are immersed in a container full of application liquid. The duration of the application is the time fruits take to go through the container.
- Pesticide application equipment with or without wax. Fruits are sprayed by means of nozzles. Wax can be used as well to get a film that protects the fruits and make them more attractive. This equipment is usually placed in the sorting and packaging line.
- Washers. Fruits are washed using water with soap and a fungicide. The products are applied as foam. Afterwards fruits can be rinsed and dried.

2. Preinspection

2.1. Presence of the operator during the inspection

The operator of the application equipment has to be present during the inspection. All the previously spotted defects have to be repaired before the inspection

2.2. Assessment of the risk for the inspector

The inspector has to check the application equipment, in order to avoid risks during the inspection, which can result on health problems or injuries.

The guards of the moving parts of the transmission have to work properly.

All the guards for the protection of the operator have to be in place and be in good condition.

2.3. Cleaning

The application equipment has to be clean, so that the inspector cannot be exposed to contamination hazard.

2.4. Equipment framework

The framework and other similar elements have to be in good condition. Defects that can affect the resistance of the equipment are not allowed.

2.5. Air unit

If available, the blowing unit has to be in good condition. It has to work properly, without any vibration of friction.

3. Inspection

3.1. Leaks

3.1.1. Static leaks

With the application unit off and the spray tank filled to its nominal capacity, there has to be no leaks in the tank, the pump or the associated pipes and hoses.

3.1.2. Dynamic leaks

With the application unit working at the pressure indicated by the manufacturer, there shall be no visible leaks.

If available, the direct injection systems have to avoid any backflow that can contaminate the water source with chemicals.

3.2. Pump capacity

The pump capacity has to be suited to the sprayer requirements. The pump has to provide enough liquid flowrate to allow the spray application and, at the same time, a visible agitation.

3.3. Agitation

3.3.1. Hydraulic agitation

The agitation has to be visible:

- when spray application is made at the maximum working pressure
- with the largest nozzles mounted on the application unit
- with the pump rotation speed recommended by the manufacturer
- with the tank filled to half the nominal capacity.

3.3.2. Mechanical agitation

A clearly visible agitation has to be maintained with the spray tank filled to half the nominal capacity.

3.3.3. Pneumatic agitation

A clearly visible agitation has to be maintained with the spray tank filled to half the nominal capacity.

3.4. Spray tank

3.4.1. Lid

All the spray tanks shall be provided with a lid. The lid has to adjust properly to the filling hole and it has to be in good condition.

3.4.2. Induction hopper

If available, the induction hopper has to prevent any object with a diameter higher than 20 mm from entering the sprayer tank.

3.4.3. Pressure compensation

If required, it has to be a pressure compensation device to avoid over-pressure and under pressure inside the spray tank.

3.4.4. Tank contents indicator

The volume of liquid in the tank has to be readable from where the tank is filled.

3.4.5. Tank emptying

It has to be possible to empty the tank in a way that the remaining liquid can be collected without contamination of the environment and without risk of exposure of the operator.

3.5. Measurement and regulation systems. Other control systems

Devices for the measurement, reading or regulation of the working pressure or the liquid flowrate have to work properly. All the control systems, which have to be operated during the application, shall be operable from the operator's position. Also, it shall be possible to read all the displays from this position.

3.5.1. Pressure indicators

Pressure indicators have to be placed so that it is possible to read the pressure.

The pressure range of the pressure indicators has to match the working pressure of the application equipment.

It is recommended that the minimum diameter of the analogue pressure indicators is 63 mm.

The scale of the analogue pressure indicators shall provide graduations at least every 0.2 bar for working pressures less than 5 bar and at least 1.0 bar for working pressures between 5 and 20 bar.

The accuracy of the pressure indicators shall be a ± 0.2 bar for working pressures less or equal to 2 bar and 10% of the real value for working pressures higher than 2 bar.

3.5.2. Pressure adjustment devices

Pressure adjustment devices have to be able to keep a constant pressure with a tolerance of $\pm 10\%$ and return to the original pressure $\pm 10\%$, 10 s after the application unit has been switched off and on again.

3.5.3. Direct injection and dosing systems

The injection dose of the chemicals shall not deviate more than 10% from what is set on the injection device.

3.5.4. System to switch off the application in the absence of fruits

In all the application equipment without liquid recirculation, it shall be a device to switch off the application system, whenever no crop is present in the application zone.

3.5.5. System to control the duration of the application

It has to be possible to control the duration of the application time.

3.5.6. Position control system

The different devices (sensors, actuators) to control the position of the application system have to work properly.

3.5.7. Temperature control system

If available, devices to adjust the temperature have to work properly.

The range and accuracy of the temperature measuring systems have to be suitable for the working conditions.

The temperature measurement error has to be less than 10% of the real value.

3.5.8. Other control devices

All the other regulation and control systems of the application equipment have to work properly and be in good condition.

3.6. Pipes and hoses

Lines shall not have excessive bending, corrosion and abrasion because of contact with surrounding elements. They shall not either show excessive wear or cracks.

3.7. Filters

All required filters have to be in good condition and the size of the mesh shall correspond to the nozzles fitted.

It shall be possible to clean the filters with the spray tank filled to its nominal volume, without leaks, except for the liquid contained in the filter casing and suction lines.

Filters shall be changeable according to the manufacturer instructions

3.8. Application unit

3.8.1. Nozzles identification

All the nozzle have to be clearly identifiable

3.8.2. Dripping

After switching off the spray, there has to be no continuous dripping from nozzles 5 s after the spray jet has collapsed.

3.8.3. Spray boom. Stability and alignment

The boom has to be stable in all directions, without excessive movements caused by wear or permanent deformation.

The vertical distance, between the bottom of each nozzle tip and a reference horizontal plane, shall not deviate more than 10 cm or 0.5% of the working width.

3.8.4. Spray boom. Nozzle similarity

All the nozzles mounted in a spray boom have to be of the same type, size, material and manufacturer, except if they are intended for a special function

3.8.5. Spray boom. Nozzles. Orientation and separation

The separation and orientation of the nozzles shall be uniform.

The separation between de nozzles (distance between the centre of two neighbouring nozzles) shall not deviate more than 5% from the nominal distance.

For special functions, the separation between the nozzles shall agree with the manufacturer instructions.

It shall not be possible to modify unintentionally the position of the working nozzles.

3.8.6. Vertical spray boom. Symmetry

The nozzle arrangement on both sides of the boom must be symmetric, except for special functions.

3.9. Distribution

3.9.1. Uniformity

The spray jet of each nozzle must be uniform.

Holes and other liquid application devices different of nozzles shall not be clogged.

Other application devices, such as foam or jet curtains and liquid falls shall produce a uniform application.

3.9.2 Nozzle flow rate

Nominal flow rate known

The deviation of the flow rate of each nozzle of the same type and size shall not exceed $\pm 15\%$ of the nominal flow rate indicated by the manufacturer.

Unknown nominal flow rate

The flow rate of each single nozzle shall not deviate more than $\pm 5\%$ of the mean flow rate of all the nozzles of the same type and size mounted on the application equipment.

In the case of only two nozzles of the same type and size, the mean value is not considered, but the deviation between the two nozzles.

If there is only one nozzle, with adjustable flow rate, the flow rate will only be measured as information.

3.9.3. Pressure distribution

3.9.3.1. Pressure drop

The pressure drop between the point of the sprayer where the pressure is measured and the outermost end of each boom section shall not exceed 10%

3.9.3.2. Compensative returns

If compensative returns are available, 10 s after a boom section has been closed, the pressure shall not vary more than 10% when the sections are closed one by one.

3.10. Rollers. Brushes

Rollers, brushes and other devices that carry fruits through the application zone, shall work properly, at the intended velocity, and be in good condition

3.11. Cleaning devices

If available, devices for cleaning the spray application equipment have to work properly.

If available, pesticide can cleaning devices have to work properly.

It is recommended that a clean water container or source (e.g. a tap) is available for the equipment operator

4. Test report

A test report shall include the results of the pre-inspection and the specific part of the equipment and shall be given to the owner.

The test report shall give at least the following information: Test station;

Name and contact details of the inspector and, where different, the testing organization and signature;

Date of inspection;

Owner's identity;

Owner's address;

Equipment type (drencher / bath / spray application, etc.);

Serial number or other identification;

Year of construction/production;

Any malfunction of the equipment. If the malfunction is a result of the design this should be noted;

Any information on malfunctions of the equipment useful to identify the corrective work required;

Results of measurements.

NOTE National or local regulations may give additional requirements for reporting of inspections

5. References

1. EN ISO 16122, 2015. Agricultural and forestry machinery - Inspection of sprayers in use. Parts 1, 4.
2. Directive 128/2009/EC Article 8 and Annex II

Session 4: Inspection quality: “Certification” of the Workshop activity (quality assurance) included the certification of devices/instruments used for the inspections

“Certification” of the Workshop activity (quality assurance) included the certification of devices used for the inspections

Petr Harasta¹, Jaco Kole²

¹Czech Phytomedical Society, Czech Republic

²SKL, Agro Businesspark 24, NL6708PW Wageningen, The Netherlands

Summary

Quality and uniformity of the inspections are very important. When the inspections are not done in the right way or with testing equipment not in good condition, the goal of the establishment of an inspection scheme will not be reached. Therefore a system of quality assurance is needed. This scheme shall cover the whole procedure and all aspects related to the inspection of sprayers. It starts with clear guidelines for all types of sprayers, well trained test-operators and testing equipment what is good condition. Then the inspections shall be performed in the right way by workshops/testing teams according to the right procedures with the right use of the testing equipment, therefore periodical control on their activities is needed.

Introduction.

When introducing an inspection scheme for the periodical inspection of sprayers in use, important for the effectiveness of this system and for the support of these inspections amongst the farmers, is the quality and uniformity of the performed inspections. The inspection scheme needs to have checks and balances in order to create this quality and uniformity.

Quality Assurance

The base of the inspections are the requirements in the European Directive 2009/128 article 8 and Annex 2. These requirements in Annex 2 are for the most common sprayer types in detail specified in the harmonized standards of the EN-ISO 16122 series for the different types of sprayers. The inspections have to be executed by inspectors who are well trained in how to use these standards and from who the knowledge is also kept up to date by means of periodical refreshing courses. The measuring equipment used during the inspections has to be accurate, in line with the harmonized standards, but it must be ensured that during time, the accuracy and condition of the testing equipment stays on an acceptable level.

To keep the quality of the performed inspections good and the output uniform, a system of quality assurance is needed. This system also has to include elements of quality control, both on the performed inspections as on the testing equipment.

For a good mutual recognition of performed inspections between the different member states in the EU, a uniform basic system of quality assurance in all member states is needed. Therefore SPISE has created this Working group to define a SPISE Advice which contains guidelines on how to certify the activities of the workshops who perform the inspections. The guideline will contain an example of a quality assurance scheme, what will include the activities of the workshops but also the activities in the total inspection scheme needed to guarantee the constant quality of the performed inspections.

The basic elements of a quality assurance scheme need to be implemented through all European countries in order to reach a working system of mutual recognition and a meaningful output of the

effort to establish a system of periodical inspection of all sprayers in use with support of the users of sprayers.

Outline of the total inspection scheme:

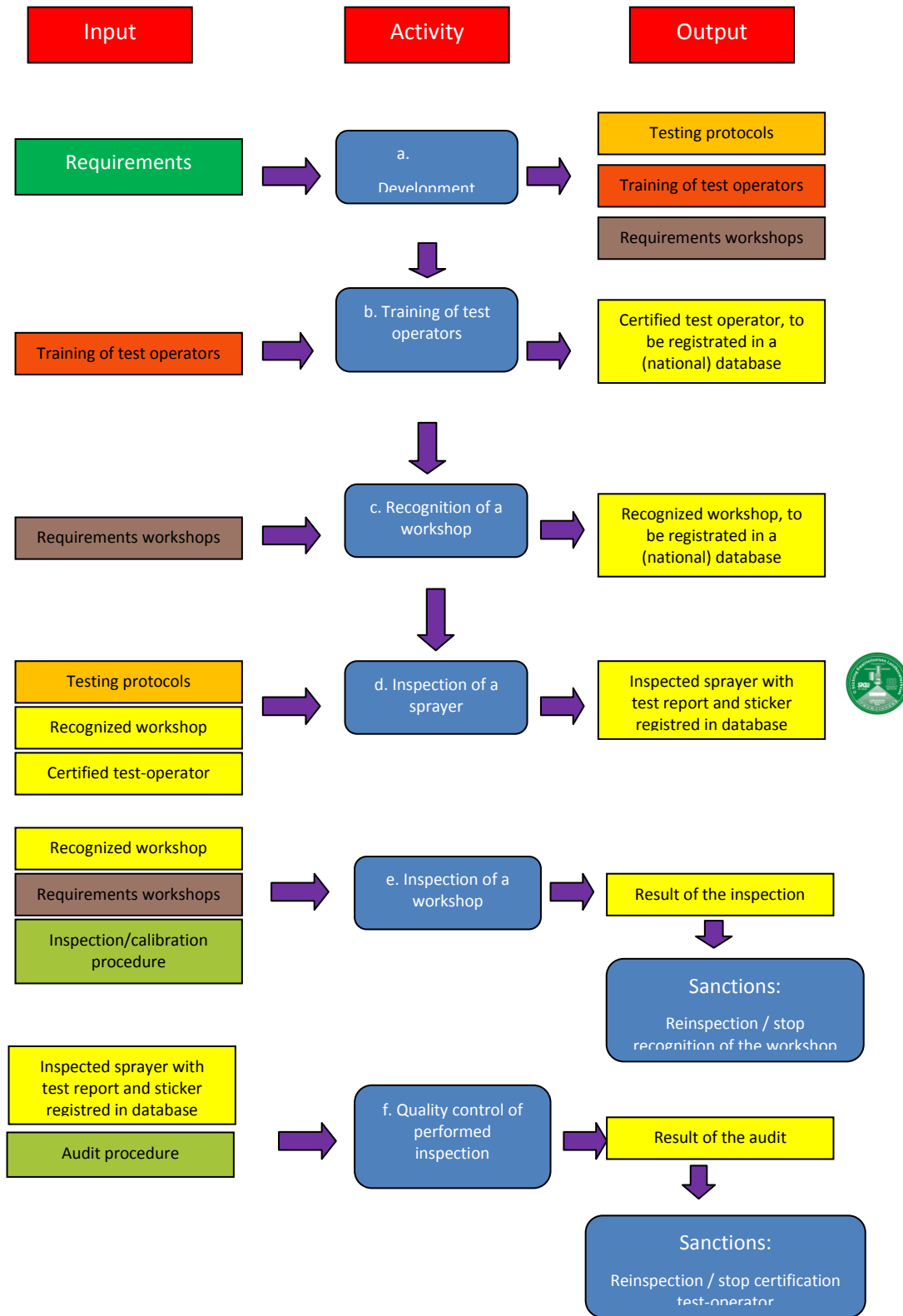

QMS: Activities

In the Quality Management System (QMS) the following activities are present:

a. Management/development documents and procedures

The objective of this activity is to manage the system, to develop and maintain the procedures and to develop and maintain the guidelines gathered around 3 theme's:

1. Testing protocols
 - a. Testing protocols for all types of sprayers
 - b. Inspection procedure (incl. registration of the results)
 - c. Test – reports (content / layout) and stickers (content / layout)
2. Training of the inspectors
 - a. Entrance level
 - b. Content and length of the training
 - c. Definition of the entrance level and the end level the trainees have to reach.
 - d. Refreshing courses (frequency / content)
3. Requirements workshops
 - a. Requirements workshops
 - b. Requirements testing equipment
 - c. Requirements for the periodical calibration of the testing equipment

b. Training of the test-operators

The aim of this activity is a proper training of the test operators. Important is that they have enough skill to perform the inspections in line with the formulated testing protocols, give the correct interpretation of the measuring results of the testing equipment, give the owner of the sprayer a clear advice and fill in the test report in the right way.

Therefore a basic trainings course with both clear entrance – and end levels is needed. To keep the knowledge and skills of the test operators' periodical refreshing courses are needed.

Independency between the inspector and the owner of a sprayer is important

c. Recognition of the workshops

The aim of this activity is to establish workshops who full fill the defined requirements, have the correct, calibrated and maintained testing equipment. The process is the initial audits of a potential workshop and the recognition if this workshop full fills all requirements.

It must be possible that the inspector can take independently decisions regarding the inspection of the machines, that there is no psychological or economical pressure on the inspector what can influence his decisions. The organisation of the workshop has to be in such a way that this is possible.

d. Inspection of the sprayers

This activity is the heart of all the defined activities. A trained test operator at a recognized workshop (which includes well calibrated testing equipment) inspect the sprayer following

the guidelines and register the results of the inspection in the right manner. This registration of the results includes the issuing of the test reports. In article 8.6 of 2009/128/EC is stated that the national organisation issues the certificates of approved sprayers. But this registration system is also needed to create an overview of the issued certificates to inform the European Commission. The statistical information gathered from the test reports can also be used to both improve the inspection scheme and inform the owners of sprayers.

e. Inspection of the workshop

To have valid tests of the sprayers, it is important that the workshops and the inspectors follow the right procedures and that the testing equipment is in good condition and well calibrated. Therefore workshops have to be inspected periodically to make sure that the workshops still fore fills all requirements and that their testing equipment is in good condition. During this visits workshops will audited on the following areas:

- Condition and calibration of the testing equipment, only with reliable and accurate testing equipment good tests of sprayers can be made.
- The testing site shall meet the minimum requirements regarding influence of weather on the testing results, treatment of used water and working circumstances for the inspectors
- The workshop management should be verified
- The inspectors shall be supervised, to check if they follow the agreed procedures before, during and after the execution of an inspection and to see if they have a valid certificate of training.

Input from the workshops and the inspectors can also be used to improve the inspection scheme.

f. Quality control of the inspected sprayers

The keep the quality of the performed inspections uniform, audits of the result of the inspections (i.e. inspected sprayers) are needed. The results of this audit can used both for improvement of the system and for a sanctioning system for the workshops and/or test-operators.

This audit can be done in different ways:

- By means of an administrative control, this will be an analysis of the results of the performed inspections of the workshop, eventually compared to the national results or the results of comparable workshops or from other years
- By means of visits of the workshops while they are performing an inspection, during this visit an inspector can overlook the real execution of an inspection.
- By means of audits of already inspected machines at the farmyard. This audit has to be as short after the inspection has been done as possible.

Also a mixture of these three possibilities can be chosen.

QMS: documents

As input for the other activities in the first activity some basic documents have to be developed. But not only developed, they have to be maintained, following the Continuous Improvement Circle. Input can

come from different sources: from participants in the inspections scheme, from audits, from owners of sprayers or from developments in National or European legislation or standardisation.

The different documents are:

1. Testing protocols

a. Testing protocols for all types of sprayers

For all relevant types of sprayer specific testing protocols have to be developed. This protocol can be based on harmonized standards (like EN-ISO 16122) or Annex 2 of 2009/128/EC combined with elements from harmonized standards for types of sprayers for which no harmonized standard is available. This testing protocol should contain also the pre-inspection as mentioned in EN-ISO 16122:1 (2015)

b. Test –report (content / layout)

Based on EN-ISO 16122:1 (2015) the test report shall contain a minimum information:

c. Sticker (content / layout)

By means of the content of the sticker it shall be clear for the owner of the sprayer:

d. Testing procedure (incl. registration of the results)

In this procedure the procedure how the test shall be performed, including preparation aspects as announcing an inspection in advance to authorities, formal order confirmation to the owner of the sprayers.

Also the registration aspects and the processing of the results of the test shall be part of this procedure. Included shall also aspects how to deal with stickers to be placed on the approved sprayers.

2. Training of the inspectors

a. Content and length of the training

Central in the course shall be how to implement the testing protocols for the different types of sprayers and how to use the testing equipment and interpreting the measuring results. Extended by knowledge about the testing scheme and legislation. Dependent on the entrance level it can be extended by knowledge of sprayers/spraying technique or it can be extended with knowledge about calibration/adjustment of sprayers.

b. Definition of the entrance level and the end level the trainees have to reach.

Important is that there are general entrance levels for the participants of the courses. General knowledge about and practical skills with sprayers, spraying technique and nozzle should be known.

The end level to trainees shall reach shall be clear defined and tested by means of a clear theoretical and practical examination.

c. Refreshing courses (frequency / content)

To keep the level of the test operators up to date, refreshing courses with a reasonable interval are important. The content should focus on new developments and new techniques but also a rehearsal of the testing protocols.

3. Requirements workshops

a. Requirements workshops

The requirements the workshops have to meet shall be clear defined:

- Type, size and focus of the enterprise
 - Number of test operators
 - Test location (safe and environmentally friendly testing)
- b. Requirements testing equipment

The requirements for the testing equipment are mostly defined in relevant parts of the standard EN-ISO 16122. Important to define is if a type approval is needed, how to deal with testing equipment what is already certified in another Member State and how to deal with homemade testing equipment.

QMS: procedures

The following procedures are needed:

1. Development of documents

Input of this procedure are the requirements as defined in 4.1 General. The output are the documents. This is a continuous process fed by input from sources like results from audits workshops and inspected sprayers, developments in legislation, standardisation, spraying technique and testing equipment.

2. Training of test operators

Input of this procedure are the documents with the demands for the content and end-levels of the training. Result shall be certified test operators. Based on the evaluation of the trainings and changing demands from technique, standards and legislation the content and lay-out of the training can be changed/ The certified test operators shall be registered in a central database in a uniform way. This information is used both for the recognition of workshops and for the registration of results of the inspections. SPISE TWG 5 is dealing with this subject.

3. Recognition of a workshop

Workshops shall be recognized following the demands for the workshops, the testing equipment, the testing area and the availability of a certified test-operator a potential workshop can be recognized and become an authorized workshop. This workshops has to registered in a central database.

4. Inspection of sprayers

Sprayers shall be inspected by recognized workshops by certified test operators following the relevant testing protocol. The results of the inspection shall put on a test report. Only sprayers what meet all requirements shall be approved.

5. Calibration of testing equipment

Testing equipment shall be periodical calibrated or checked on correct and accurate operation. This calibration can be done by independent laboratories, the official organisation or other to be defined organisation. Important is to describe the asked accuracy of reference methods / instruments used to the calibration.

6. Registration of recognized workshops

The recognized workshops shall be registered in a central database, this list of workshops shall be visible for the owners of sprayers.

7. Inspection of a workshop procedure

Workshops shall be periodically inspected. Their condition and calibration shall be checked and measured. The exact procedure can be found in Annex 1.

8. Inspection audit procedure

Periodical audits of the process the test operator is following when testing a sprayer or the result of this inspection (the tested and approved (or disapproved) sprayer) are needed in order to keep the quality uniform. The output of this procedure will be used in the procedure of recognition of the workshops.

Conclusion

The requirements for the sprayers in Annex 2 of the EU directive 2009/128/ec and the harmonized standards of the EN-ISO 16122 series are a good base for testing sprayers in the EU. But to have within a member state and between member states uniform inspections of a high level of quality, which is needed to reach enough support among the owners of sprayers and for an effective mutual recognition, a system of Quality Assurance is needed. This paper gives an outline and base of a future SPISE Advice on this topic. It is based on the harmonized EN-ISO standards and includes other SPISE advises on the different topics.

Quality assurance of the workshop activity - including test facilities

Harald Kramer

Chamber of agriculture North Rhine Westphalia, Nevinghoff 40, 48147 Münster,

Especially for MS with various borders it is essential to know the state of the testing system in the neighbour countries. In North Rhine Westphalia a well-established system is working well since years. But how is the situation in other Federal States like Rhineland Palatinate, Hessen or Lower Saxony? All three federal states are following the same EU Directive, but the responsibility of the local authorities is different compared to North Rhine Westphalia. But in all cases we are accepting a sticker on a sprayer throughout the whole Europe. Or how is the quality system in the Netherlands? Following that question a developed questionnaire and parameters for quality control of accepted workshops was provided in the shape of a SPISE Advice. This SPISE Advice was adapted to the local situation in North Rhine Westphalia. With this system a visit of a recognized workshop in the Netherlands was conducted in collaboration with local authorities (SKL). The reason for this visit was to be sure that there will be no problem with the mutual recognition of a tested sprayer. This review showed a good result with a comparable system between the Netherlands and North Rhine Westphalia. Especially in the case for establishing a new system the SPISE Advice was really helpful.

Keywords: Quality assurance, mutual recognition, workshop activity, testing facilities

Introduction:

When introducing an inspection scheme for the periodical inspection of sprayers in use, important for the effectiveness of this system and for the acceptance and support of the inspections amongst the farmers, is the quality and uniformity of the performed inspections. The inspection scheme needs to have checks and balances in order to create this quality and uniformity. The base of the inspections is the requirements in the European Directive 2009/128 article 8 and Annex 2. For the most common sprayer types this requirements in Annex 2 are in detail specified in the harmonized standards of the EN-ISO 16122 series. The inspections have to be executed by inspectors who are well trained in how to use this standards and whose knowledge is also kept up to date by means of periodical refreshing courses. The measuring equipment used during the inspections has to be in line with the harmonized standards and accurate, but it must ensure that during time, the accuracy and condition of the testing equipment stays on the required level. To keep the quality of the performed inspections good and the output uniform, a system of quality assurance is needed. This system also has to include elements of quality control, both on the performed inspections as on the testing equipment. For mutual recognition of performed inspections between the different member states in the EU, trust in the different systems in Member States is essential. Therefore a uniform system of quality assurance in all Member States is needed. This system will include elements like training of the inspectors, requirements of the workshop facilities, inspection procedure, quality control on the performed inspections, calibration of testing equipment, registration of the performed inspections and a procedure about how to deal with non-conformities. The basic elements of such quality assurance scheme needs to be implemented through all European countries in order to reach a working system of mutual recognition and a meaningful output of the effort to establish a system of periodical inspection of all sprayers in use with full support of the owners of sprayers.

Material and methods:

The bases for the mandatory sprayer testing in North Rhine Westphalia (NRW) besides the European requirements are a lot of national and local laws and decrees. First of all there is a need for harmonization between the Federal States. But also harmonized practices between different European countries like the Netherlands, Belgium etc. and Germany. Because of the missing of such a standard NRW wants to install a quality assurance system to improve the acceptance of the Dutch testing

scheme in its federal state. Therefore the SPISE Advice was adapted to the local situations. A checklist was established to help the inspector on-site.

Checklist for a on-site visit of a inspector

Administrative demands:		
Is the workshop recognized	Yes	No
Has the inspector a valid certificate	Yes	No
Has the workshop the correct documents	Yes	No
Test site:		
Is the testing site protected against weather circumstances (wind/rain)	Yes	No
Is the used water collected and given back to the farmer or treated properly	Yes	No
Are the exhaust gasses discharged properly (when testing inside)	Yes	No
Has the test site enough space to perform the inspection properly (folding booms) and safe?	Yes	No
Testing equipment:		
A. Reference manometer(s)		
Diameter (analogue)	Yes	No
Scale (analogue)	Yes	No
Class	Yes	No
Accuracy (valid certificate)	Yes	No
Functioning test bench/connection to sprayer	Yes	No
B. Reference flow meter/pump tester		
Scale (analogue)	Yes	No
Range	Yes	No
Accuracy	Yes	No
General functioning complete testing installation (connecting to sprayer/transparent part/safety valve/pressure adjusting device/pressure gauge)	Yes	No
C. Patternator (mechanical)		
General condition/functioning/dimension	Yes	No
Condition gutters	Yes	No
Distance gutters	Yes	No
Condition and accuracy measuring glasses	Yes	No
D. Patternator (electronic)		
Condition of rails (general condition/flatness/spacing reference points)	Yes	No
Condition and functioning of measuring wagon	Yes	No
Distance upper points separation plates	Yes	No

Condition and tightness of measuring glasses (incl. opening/closing system)	Yes	No
Accuracy of the measurements	Yes	No
E. Nozzle flow-rate tester (mechanical)		
Condition and functioning of the connection to nozzles	Yes	No
Condition of hoses	Yes	No
Condition and accuracy of measuring glasses	Yes	No
General condition	Yes	No
F. Nozzle-flow rate tester (electronic)		
Condition and functioning of the connection to nozzles	Yes	No
Accuracy of the measurements	Yes	No
G. measuring glasses (certified)	Yes	No
H. Types of sprayer can be tested in the workshop		
Horizontal boom sprayer	Yes	No
Vertical boom sprayer, mist blowers and similar	Yes	No
Fixed and semi mobile sprayers	Yes	No
Micro granulators	Yes	No
Wiper	Yes	No
Seed treatment equipment	Yes	No
Duster	Yes	No
Post harvest equipment	Yes	No

Discussion

For verification and testing a scheme for mutual recognition of workshops and testing facilities a visit in Lottum, NL was carried out. During this visit the certified workshop Coenders Lottum B.V. was inspected by the SKL. The testing of the testing equipment is different from the way in NRW. SKL is doing the inspection/calibration of the testing facilities on site in the workshop with its own testing equipment. On the basis of these test results a report is filled and given to the workshop.



On-site inspection of a mobile patternator

During the visit it was possible, with the help of the above shown checklist, to receive an overview that the workshop follows all the relevant guidelines, rules, laws and local decrees. This knowledge is the basis for a reliable, mutual recognition of tested sprayers in other countries. Also the discussion with the test engineer during the test of an asparagus sprayer gave a good impression of the testing quality.



Testing the pump capacity with a certified flow meter

During the inspections of the workshop the following items have been audited:

1. Administrative demands, including skills of the test-operators.
2. Testing site meets the requirements.
3. Registration, check of the presence, condition and performance of the testing equipment.
4. Discussion of the results of the inspection visit with the test-operators and responsible person at the workshops.

For all the different requirements for a workshop to fulfil all the legal requirements the author would like to refer to SPISE Advise (TWG 4) and the local situation. The visit showed the need of such two-way inspections. Especially in the discussion with the testing staff and the farmers the acceptance of foreign stickers and reports will increase. The visit shows also the need of a summary report of the results coming out of the examination of the workshop. This report should be best in the appropriate language

or at least in English. Also for a tested sprayer there should be the possibility to give in case of an international sale an English summary to facilitate the local acceptance. The basis for all the different tested sprayers is the EN/ISO 16122, part 1-4. If there are some other types of plant protection equipment that is not covered by the EN 16122 SPISE Advises can help for the testing and also for a mutual recognition.

Acknowledgements:

I would like to thank the TWG 4 Team for the preparation of the SPISE Advice for quality assurance. It gives a great help for installing a local system and improve the confidence in the reliability of the system used in the Netherlands. During the visit in Lottum at the test station I would like to thank the test engineer Bernard van Horck and Jaco Kole from SKL

References:

KOLE and HARASTA, 2018, Quality assurance of the workshop activity including test facilities, SPISE Advice (TWG 4)

Quality control of the workshops, the Danish approach

Hans Henrik Pedersen¹, Bo Grubov¹, Anita Fjelsted², Jaco Kole¹

¹ SKL - Stichting Kwaliteitseisen Landbouwtechniek, Agro Businesspark 24

NL - 6708 PW Wageningen

² Ministry of Environment and Food of Denmark, Environment Protection Agency, Haraldsgade 53 DK - 2100 København Ø

Summary

To fulfil European legislation, inspection of sprayers in Denmark started in 2014. The Danish Environment Protection Agency has authorised approximately 120 workshops with educated inspectors to carry out the inspections.

It was a priority to implement an IT solution to cover all inspection reports, data about the workshops and inspectors as well as all data on the inspection equipment. It was chosen to translate and modify the IT system SYS that has been developed and used in the Netherlands.

In SYS statistics from performed inspections by each workshop and each inspector can be compared with country average as regards repairs made during inspections. Statistics reports on workshop repairs are made on regular basis and these are discussed with inspectors and workshop managers during visits at the workshops. As types, brands, age and condition of sprayers differ between the sprayers inspected at different workshops there are often good reasons why number and type of repairs differ between workshops. The statistic report are however good for discussions with workshops.

Introduction

The introduction of sprayer inspections and the first experiences in Denmark was presented at the 5th and the 6th Spise workshop (Fjelsted, 2014 and 2016). Inspection reports layout and further description of the IT system SYS are described as well in Spise workshop reports (Kole & Harasta, 2014 and 2016).

Materials and Methods

From 2014 until July 2018 approximately 120 workshops have carried out 11,297 inspections. Of these 277 are mist blowers, 587 are greenhouse sprayers, and the rest are field crop sprayers.

Control, guidance and support of workshops

The Danish Environmental Protection Agency (Danish EPA) has contracted an external company to carry out technically support of the workshops as well as to control and inspect the workshops and their testing equipment. This work in addition includes a hot-line service to answer technical questions as well as the use of the administrative system SYS. Also the company will visit the workshop once every second year. The Dutch company SKL including two Danish subcontractors has carried out this type of control and technical support of the Danish workshops since 2016.

Workshop visits

During a workshop visit, SKL consultants will check if the testing equipment and facilities are OK. The purpose of physical visits is to ensure that the inspections are carried out evenly throughout the country and that the testing is carried out with accurate testing equipment. If possible irregularities are corrected right away and measuring equipment is calibrated. During the visit SKL will give guidance to inspection companies and distribute good practices between inspection companies. Any challenges in the inspection processes are discussed during the visits. Based on a sprayer present at the workshop or at a farmers address the inspection requirements known to cause difficulties by some inspectors are discussed with the inspectors of the workshop.

Prior to each visit a report with data/statistics on inspections and repairs of the individual workshop is extracted from the SYS system. The SKL consultants bring as well prints of 5-10 recent inspection reports for discussions with inspectors.

The workshop visit is finalised by a talk with the inspectors and the workshop manager. Both major as well as any minor challenges or irregularities are discussed. If any major irregularities are found these are reported to the Danish EPA to take action.

The report with data/statistics on performed repairs of sprayers made by the workshop is presented during the discussion. Causes of deviations compared to country average are discussed.

Results

For any of the inspection points the inspector has to report whether e.g. the pump capacity is “OK”, “Repaired” or “Defect”. If any inspection requirements are termed as Defect the sprayer cannot be accepted.

During the first years of inspections, many inspectors reported inspection points as OK even if repairs had been made. The visits, seminars with all workshops, letters to workshops and other contacts between the workshops, the consultants and the Danish EPA have caused the workshops to increase their reporting of the repairs made on sprayers. See table 1.

Table 1. Average number of repairs and percentage of inspected field crops sprayers where repairs were made during inspection.

Year	2014	2015	2016	2017	2018 until July
Inspected sprayer, No	1,583	2,582	3,483	2,635	285
Sprayers with repairs%	47%	72%	81%	92%	91%
Average no of repairs	1.6	3.0	3.8	5.6	5.3

The three types of repairs most often reported are: 1: Filters (blocked or defect), 2: Wear and leakages on pipes and hoses, 3: stability and symmetry of the boom.



Photo 1: Boom stability, as well as nozzle orientation are defects often found on older sprayers.

Testing equipment

We have now checked all manometers and flowmeters at the workshop at least once.

We have found few errors on test manometer, although some workshop needed to invest in a new test manometer for field crops sprayers (below 6 bar), as the 25 bar manometers used did not meet the 0.1 bar accuracy requirement and 0.1 bar scale requirement.

Some workshop have built their own equipment for testing pump capacity. We have calibrated most of these. We also found flow sensors that needed replacement, as the sensor did not meet the accuracy specifications.

Only few workshops have bought patternators, so most nozzle flow test are made by use of nozzle flow sensors of which most were calibrated during our first visit to the workshop. We are now visiting workshops for the second time, and we do still find flow sensors with deviations that require calibrations.



Photo 2: SKL brings two flow sensors at workshop visits. One is used to test the flowmeter used for pump capacity measurements. The other flow meter (behind the tank) is used to test the hand held nozzle flowmeter.

Discussion

Both SKL and EPA have focussed on building a good relationship with the inspectors and the workshop managers. It is very important to support the workshops in any challenges that arise during inspections. Communication with workshops is in general open and honest.

When visiting workshops, we first check the flow meters and the test manometers. We hereby ensure the quality of tools used by the inspectors and at the same time, we try to build a positive personal relationship. We require at least one inspector available to help make the equipment ready for checking.

As we have all inspection reports available in SYS, we can prepare our visits by reading through a number of inspection reports and extracting the report on earlier repairs.

If some major deviations on repairs are found compared to the country average, this is discussed during the visit where good explanations are often found. In a few cases, the inspectors are asked to change procedures. It is more often the case, that we instruct inspectors to report the performed repairs correctly.

All workshops are to fulfil the requirements in the guidelines to ensure even quality of inspections on all workshops. It is however not an aim that the number and type of repairs should be the same for all inspectors. The condition and type of the sprayers often differ between workshops. Some workshops

mainly inspect sprayer of a specific brand. This brand may have typical errors whereas other errors are seldom seen. The condition of the sprayer can also differ due to how the workshops instruct the owners to prepare the sprayer for inspections. There are a lot of workshop that are not authorised to inspect sprayer. These workshops often make repairs before they ask an authorised workshop to do the inspection. In this case the repairs are often not registered.

The statistics on repairs are however useful in pointing out where inspections procedures may require changes.

Self-inspection of sprayers and seed treatment machines in Poland – proposal of instruction manual

Grzegorz Doruchowski, Artur Godyń, Ryszard Hołownicki, Waldemar Świechowski

INHORT - Research Institute of Horticulture – Dept of AgroEngineering, Skierniewice, Poland

Summary

The long period of 5 years between the purchase of plant protection equipment and the first mandatory inspection, and then 3 or 5 years between the follow-up inspections, as practiced in Poland, may result in considerable deterioration of technical condition of the machines, and in consequence in the increased risk for the operators and the environment. This risk may be mitigated by regular self-inspections of such equipment performed by the users themselves. In order to promote such good practice and help the operators to carry out their own inspections of sprayers and seed treatment machines two dedicated manuals were developed and approved by relevant authorities. In these manuals the procedures of self-inspection are outlined in form of check-list of control points followed by relevant illustrations and comments on evaluation criteria. Only basic tools and a calibration kit are needed to carry out the self-inspection. The manuals also include a lot of additional information making them valuable training materials.

Introduction

In Poland the mandatory inspection of plant protection equipment covers field and fruit crop sprayers, railway sprayers, aerial spraying systems and other sprayers with tanks of volume greater than 30 l, as well as greenhouse equipment, seed treatment machines and granule applicators (Dz.U. 2016 r. pos. 760). Handheld and knapsack sprayers have been exempted from the inspection by way of derogation from art. 8 of the Directive on Sustainable Use of Pesticides (EU 128/2009/EC, hereinafter: SUD). This was possible after reporting the results of research on risk assessment for human health and the environment, and the assessment of the scale of the use of this equipment (Godyń et al., 2010; Bańkowski et al., 2013). According to the SUD the exemption of small equipment from mandatory inspection has to be followed by providing the users with information materials on the use, maintenance and specific risk linked to the equipment. Such materials must be available to operators who are trained for the proper use of the equipment. Thus, the manual including the required information plus instruction of self-inspection of handheld and knapsack sprayers has been developed and made available to the operators. The concept and the contents of this manual was presented and discussed at the 6th SPISE Workshop (Godyń et al., 2016).

According to the regulations regarding mandatory inspection of plant protection equipment in Poland (Dz.U. 2016 r. pos. 760) the first inspection of brand new machines is required not later than 5 years after the purchase. The follow-up inspections of field and fruit crop sprayers have to be made in time intervals not longer than 3 years, while the seed treatment machines have to be inspected not later than every 5 years. The 5 year period for the initial inspection represents 70% of the normal depreciation of the plant protection equipment or 50% of the normal use period assumed for such equipment in the economic analysis of the farm management. During such long periods between the inspections the intensively operated machines may get significantly used and if they are not properly diagnosed and maintained there is a high risk of considerably reduced technical efficiency, reliability and capacity of the machines. This in turn poses high risk for the operators and the environment due to possible contamination by plant protection products.

The most common faults identified during the inspections concern worn, clogged or damaged nozzles, defective manometers, worn or damaged liquid hoses and leaking connections in the spray liquid circuit. All these items may easily be checked and repaired by the sprayer operator himself in the course of self-inspection of the equipment that can be performed with simple methods and basic tools available on the farm. In order to provide the users of field and fruit crop sprayers, and seed treatment

machines with an instruction for such self-inspection two dedicated manuals were developed in INHORT-Skierniewice. They follow the concept of the earlier manual on self-inspection of handheld and knapsack sprayers, and have been approved by the Polish Ministry of Agriculture and Rural Development as an official instructional and promotional material.

Approach and scope of self-inspection

The main objective of the self-inspections is to maintain the technical condition of plant protection equipment and by that ensure that it does not pose risk for the humans and the environment. An operator performing the inspection himself has an opportunity to better learn about the machine he operates and about the demands imposed on it. He gains skills that may be used in case of emergency and need for repair of the equipment. These skills also allow appropriate preparation of machines for the successful mandatory inspection.

The self-inspection is recommended to be carried out at least once a year, preferably before the first sprayer use at the start of plant protection season. It should be considered a good practice being an introduction to calibration of the equipment. Therefore the procedure of the self-inspection only requires use of basic tools and the standard calibration kit. No professional diagnostic equipment is needed because most of the inspected items are evaluated visually or checked for functionality. The sparse measurements are simplified and they only apply to the size of manometer, the flowrate of nozzles, boom height in three points to check its straightness, or driving time and distance to determine the driving speed of sprayer. In case a calculation is needed to evaluate stability and repetitiveness of pressure, driving speed, or deviation of nozzle flowrate the formula is given in a straightforward form.

As far as the scope is considered the self-inspection follows closely the procedure of the mandatory inspection as determined by two decrees of Minister of Agriculture and Rural Development: (i) on requirements regarding technical condition of plant protection equipment (Dz.U. 2016 r. pos. 760); (ii) on validation of technical condition of plant protection equipment (Dz.U. 2016 r. pos. 924). Both decrees were elaborated in the year 2013, so in the part regarding sprayers they were based on the standards EN 13790:2003 (Part 1 and 2), currently amended by the standards EN-ISO 16122:2015 (Part 1, 2 and 3). Thus, the proposed self-inspection covers the condition and performance of all components of sprayers and seed treatment machines that are contained in legal regulations related with the inspection of plant protection equipment.

The self-inspection is carried out based on the check-list of questions (table 1 and 2). Each question is followed by relevant illustration, brief explanation of the meaning of the inspected item, technical requirements, possible malfunctions and instruction how to check and ensure that it meets the required criteria. The whole material is elaborated in form of manuals of best practices (Godyń et al., 2017a; Godyń et al. 2017b). In order to broaden the knowledge and skills of the intended recipients, being mainly the users of sprayers and seed treatment machines, the manuals include also discussion of legal regulations and standards that are relevant with regard to the inspection of plant protection equipment, information on construction, operation and common faults of this equipment, instruction on its calibration, as well as risk to humans and environment, and personal protection equipment to be used during inspection, calibration and repair of the machines.

Field and fruit crop sprayers

The manual of self-inspection of sprayers (Godyń et al., 2017a) includes the check-list of control points as presented in table 1. It applies to all types of field and fruit crop sprayers that are subject to mandatory inspections.

The manual of A5 format has 88 pages with 139 illustrations (Fig. 1). It is available as PDF file at:

http://www.inhort.pl/files/sor/technika-ochrony-roslin/badanie-sprawnosci-technicznej/Broszura-DOBRA_PRAKTYKA-Samodzielna_kontrola_opryskiwaczy_polowych_i_sadowniczych.pdf

Table 1. Check-list of questions for self-inspection of field and fruit crop sprayers

FIELD CROP SPRAYERS	FRUIT CROP SPRAYERS
GENERAL OVERVIEW	
<p>Is the housing of PTO (power-take-off shaft) complete and properly fitted?</p> <p>Is the sprayer properly and safely aggregated with the tractor?</p> <p>Are components of the sprayer in good shape?</p> <p>Are tank(s) and liquid circuit tight?</p> <p>Is the sprayer clean?</p>	
TECHNICAL CONDITION OF SPRAYER COMPONENTS	
Pump	
<p>Is the pump tight (no liquid and oil leakage)</p> <p>Is the oil level in accordance with manufacturer's recommendation?</p> <p>Is the pressure pulsation dumping system working properly?</p> <p>Is the hydraulic agitation system working properly?</p>	
Main tank	
<p>Is the cover of filling hole in good shape and properly fitted?</p> <p>Is the air valve for in-tank pressure compensation working properly?</p> <p>Is the strainer the filling hole in good shape?</p> <p>Is the liquid level indication visible and readable?</p> <p>Is the drain valve working properly, ensuring complete emptying of the tank?</p> <p>Are rinsing devices in good shape and working properly?</p> <p>Are mixing and filling devices in good shape and working properly?</p> <p>Are container flushing devices in good shape and working properly?</p>	
Measuring and control devices	
<p>Is the manometer of appropriate size (diameter)?</p> <p>Is the reading range of manometer adapted to the nozzles used and the graduation in accordance with requirement ?</p> <p>Is the pressure indication on manometer stable?</p> <p>Is the manometer of reacting for pressure change?</p> <p>Is the pressure indication repetitive after turning off and on the main liquid valve?</p> <p>Are the pressure compensation valves working properly?</p> <p>Is the measurement of driving speed correct?</p>	
Liquid circuit	
<p>Are the components of the liquid circuit in good shape, tight and tightly connected?</p> <p>Are the components of sprayer protected from being sprayed on?</p>	

Table 1. (continuation)

FIELD CROP SPRAYERS	FRUIT CROP SPRAYERS
Filtration Is the filtration system complete? Are the filters in good shape?	
Field boom 2.6.1. Is the boom stable and in good shape? 2.6.2. Are the boom folding elements working properly? 2.6.3. Is the transport position of the boom properly secured from unfolding? 2.6.4. Is the precise boom height adjustment possible and working properly? 2.6.5. Is the boom straight? 2.6.6. Are the nozzles installed properly? 2.6.7. Are the boom breakaway hinges working properly? 2.6.8. Are the boom stabilization and damping systems working properly? 2.6.9. Are the anti-drip valves working properly?	Spray sections 2.7.1. Are the nozzles installed solidly on both sections? 2.7.2. Are the anti-drip valves working properly?
2.8. Nozzles on field boom 2.8.1. Are the nozzles clean, in good shape and all of the same type, size and material? 2.8.2. Are all the nozzle filters of the same type and size? 2.8.3.1. Is the spray curtain smooth and even? 2.8.3.2. Is the nozzle flowrate correct?	2.9. Nozzles on spray sections 2.9.1. Are the nozzles clean, in good shape and installed symmetrically on both sections regarding type, size and material? 2.9.1. Is the nozzle flowrate correct?
2.10. Fan on field boom 2.10.1. Are the fan and the air-sleeve in good shape and working properly (adjustments)?	2.11. Fan on fruit crop sprayer 2.11.1. Is the fan in good shape and working properly (transmission, adjustments)?

Seed treatment machines

The manual of self-inspection of seed treatment machines (Godyń et al., 2017b) includes the check-list of control points as presented in table 2. It applies to the devices being subject to mandatory inspections, i.e. that are used at farms for the farmers' own purposes and for local services. The industrial systems for seed dressing are excluded from the plant protection equipment inspection scheme. They should be inspected by a qualified service rather than by the users themselves.

The manual of A5 format has 48 pages with 103 illustrations (Fig. 2). It is available as PDF file at:

http://www.inhort.pl/files/sor/technika-ochrony-roslin/badanie-sprawnosci-technicznej/Broszura-DOBRA_PRAKTYKA-Samodzielna_kontrola_zaprawiurek_do_nasion.pdf

Table 2. Check-list of questions for self-inspection of seed treatment machines

GENERAL OVERVIEW
Are the housings of moving and rotating elements complete and properly fitted? Is the tank for seed dressing clean and securely fitted? Are the structural and electric elements complete, undamaged and properly fitted? Is the machine clean? Are tank(s) and liquid circuit tight? Is the sprayer clean?
TECHNICAL CONDITION OF MACHINE COMPONENTS
Tank for seed dressing or product solution 2.1.1. Is the cover of the tank and drain valve undamaged and properly fitted?
Measuring and control devices Are the valves and control devices undamaged and working properly? Are the systems of automatic cutting-off seed or dressing flow undamaged and working properly? Are the control devices (eg. manometer) undamaged and working properly?
Liquid circuit Are the components of liquid circuit tight, undamaged and properly fitted? Are the external parts of the machine protected from being contaminated by seed dressing?
Filtration Are all required filters in place, undamaged and working properly? Are the dust extraction units undamaged and working properly?
Wetting/Mixing chamber Are the wetting/mixing chambers working properly? Is the dosing device for seed dressing or product solution undamaged and working properly? Is the chamber discharge unit working properly?
Agitation Is the agitator undamaged and working properly?

Conclusions

The good practice manuals on self-inspection of sprayers and seed treatment machines are to help the users to maintain their plant protection equipment in good technical condition during long periods between mandatory inspections and in consequence to reduce risk linked with the use of this equipment for human health and environment. They complement the instruction manuals on

professional inspection of plant protection equipment and with their contents and illustrations may well be used as training materials for advisors, machinery dealers and students.

The presented manuals follow the earlier developed manual on self-inspection of handheld and knapsack sprayers. There are also in preparation manuals on self-inspection of railway sprayers, aerial spraying systems, greenhouse equipment, and granule applicators.

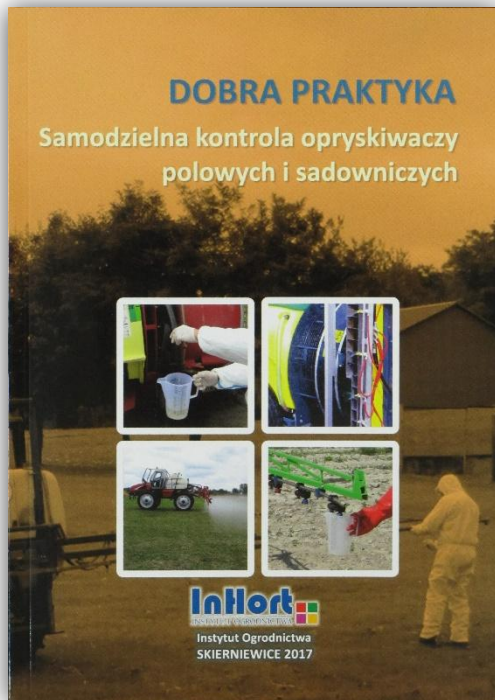

Figure 1. GOOD PRACTICE Manual
Self-inspection of field and fruit crop sprayers

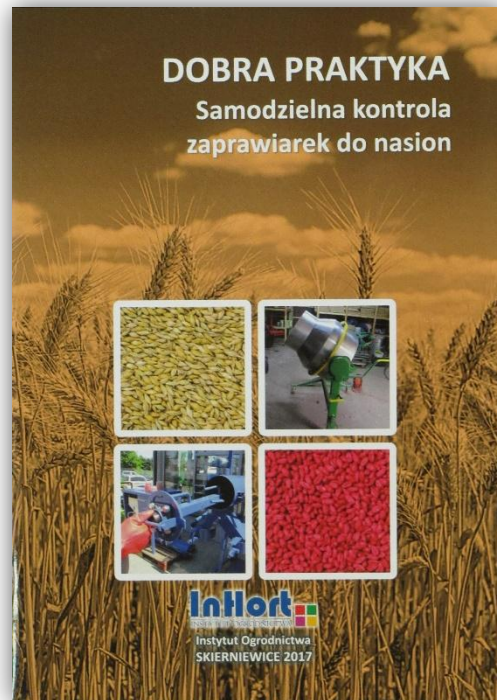

Figure 2. GOOD PRACTICE Manual
Self-inspection of seed treatment machines

Acknowledgements

This work was performed within the framework of Multi-annual Programme "Actions to improve the competitiveness and innovation in the horticultural sector with regard to quality and food safety and environmental protection", financed by Polish Ministry of Agriculture and Rural Development.

References

Bańkowski, R., Wiadrowska, B., Beresińska, M., Ludwicki J. K., Noworyta-Głowacka, J., Godyń, A., Doruchowski, G., Hołownicki, R., 2013. Computer modelling as a tool for the exposure assessment of operators using faulty agricultural pesticide spraying equipment Roczniki Państwowego Zakładu Higieny; 64(4): 271-6

Godyń, A., Doruchowski, m G., Hołownicki, R. 2010. Potencjalne uszkodzenia opryskiwaczy ręcznych i plecakowych oraz ich wpływ na ekspozycję operatora opryskiwacza. Expertise for Polish Ministry of Agriculture and Rural Development, Research Institute of Pomology and Floriculture, Skierniewice 2010, 101 pp. <https://www.gov.pl/documents/912055/913531/ekspertyza1.pdf/33e6b12b-abd8-f247-63d6-8aa5dda260a2>

Godyń A., Doruchowski G., Hołownicki R., Świechowski W. 2016. Self-inspection of spraying equipment not covered by official inspection system in Poland. 6th European Workshop on Standardized Procedure for the Inspection of Sprayers in Europe – SPISE 6, Barcelona, Spain, September 13 - 15, 2016. Paolo Balsari, Emilio Gil, Hans-Joachim Wehmann [ed.]. ISBN: 978-84-491-1476-2, Deposito Legal: M-21532-2017, p: 161-168.

Godyń A., Hołownicki R., Doruchowski G., Świechowski W. 2017a. DOBRA PRAKTYKA - Samodzielna kontrola opryskiwaczy polowych i sadowniczych. Instytut Ogrodnictwa, Skierniewice 2017, ISBN 978-83-65903-07-5: 88 pp.

Godyń A., Hołownicki R., Doruchowski G., Świechowski W. 2017b. DOBRA PRAKTYKA - Samodzielna kontrola zaprawiarek do nasion. Instytut Ogrodnictwa, Skierniewice 2017, ISBN 978-83-65903-06-8: 48 pp.

Dz.U. 2016 r. pos. 760. Rozporządzenie Ministra Rolnictwa i Rozwoju Wsi z dnia 18 grudnia 2013 r. w sprawie wymagań dotyczących sprawności technicznej sprzętu przeznaczonego do stosowania środków ochrony roślin

Dz.U. 2016 r. pos. 924. Rozporządzenie Ministra Rolnictwa i Rozwoju Wsi z dnia 13 grudnia 2013 r. w sprawie potwierdzania sprawności technicznej sprzętu przeznaczonego do stosowania środków ochrony roślin.

EN 13790-1: 2003. Agricultural machinery – Sprayers – Inspection of sprayers in use – Part 1: Field crop sprayers.

EN 13790-2: 2003. Agricultural machinery – Sprayers – Inspection of sprayers in use – Part 2: Air-assisted sprayers for bush and tree crops.

ISO 16122-1: 2015 Agricultural and forestry machinery -- Inspection of sprayers in use -- Part 1: General

ISO 16122-2: 2015 Agricultural and forestry machinery -- Inspection of sprayers in use -- Part 2: Horizontal boom sprayers

ISO 16122-3: 2015 Agricultural and forestry machinery -- Inspection of sprayers in use -- Part 3: Sprayers for bush and tree crops

Session 5: Additional Workshops activities including PAE adjustment

What to be considered when you buy a sprayer: the SPISE advice

Emilio Gil¹ and Christoph Schulze-Stentrop²

¹ Department of Agri Food Engineering and Biotechnology - Unit of Agricultural Machinery - Universitat Politècnica de Catalunya - Esteve Terradas, 8 - 08860 - Castelldefels (Barcelona) – SPAIN

² HARDI INTERNATIONAL A/S - Herthadalvej 10, 4840 Nørre Alslev, Denmark

Abstract

Since the publication of European Directive (2009/127/EC), environmental requirements for new orchard sprayers are mandatory. Only equipment which has successfully accomplish the specifications can be placed into the EU market. For this purpose, the new harmonized ISO 16119 series represents an interesting tool to fulfil the requirements. However, not all the sprayers placed in the market after the publication of the Directive are in line with it. SPISE community has developed a practical guideline in order to guarantee a clear and universal dissemination among farmers and other stakeholders about the main requirements to be accomplished by the sprayers.

Introduction

Mandatory inspection of sprayers in use became mandatory in Europe since the official publication of the European Directive for a Sustainable Use of Pesticides (EC, 2009). From the technical point of view, the official procedure for the inspection is very well defined after the publication of the harmonized standard EN ISO 16122 (ISO, 2015). At the same time, the European Directive 2009/127/EC amending 2006/42/EC with regard to the spraying equipment was also published, establishing the essential environmental and safety requirements to be accomplished for new sprayers. European sprayer's manufacturers shall take all appropriate measures to be sure that their machinery may be placed on the market and put into service accomplishing the relevant provisions established in the legislation. In a similar way, the harmonized standard EN ISO 16119 (2014) was also published as a technical reference document.

However, there is still an important lack of information among the involved stakeholders (manufacturers, farmers, advisors...) concerning the mandatory requirements to be accomplished by new sprayers. It is still possible to find in the market new sprayers with defaults in some important aspects (cleaning, agitation, measuring devices...) that should be avoided. In most cases these defaults have been produced as a consequence of a lack of information by small and medium manufacturers. This fact, linked with the difficulty to arrive to farmers with clear information about the official requirements, derive in the selection of new sprayers with technical default with great influence on quality of applications, generating also difficulties during the mandatory inspection process.

For those reasons, SPISE community decided to develop a practical guideline with the main objective to inform on an easy and clear way, which are the main requirements that farmers should check before to acquire a new sprayer. This guideline cannot be considered as a law. It is just a practical document where main requirements are clearly explained in order to help farmers, and also other stakeholders, during the selection process of the most accurate sprayer for their interests.

Structure of the SPISE guideline for new sprayers

The guideline has been developed in a practical way, avoiding too many texts and providing farmers with clear descriptions, schemes and figures. Along the guideline, the main aspects addressed are included in table 1.

Table 1. Main aspects considered in the SPISE advice about new sprayers

Aspect	Requirements according ISO 16119-1
Inspection of sprayers	Sprayers shall be provided by adequate devices in order to facilitate the connection of special devices for the mandatory inspection of sprayers in use (ISO 16122 series)
Adjustment of sprayer	It shall be possible to adjust the sprayers for the intended volume application rate. The sprayer shall be delivered with adequate and reliable measuring systems.
Spray distribution	Characteristics of the sprayer shall allow to obtain a uniform distribution of the sprayed liquid according the intended target, while minimizing losses and drift and avoid contamination of non-target areas.
Information	The sprayer shall contain a specific placement where operator will write the name and specifications of PPP in use
Filling, emptying and cleaning	All the sprayers shall be provided with reliable and safe systems for filling and emptying the tank without environmental risk. Sprayers shall incorporate devices for cleaning the whole machine (inside and outside) after the application process.
Marking	Specific spare parts as nozzles and filters shall be clearly identified (manufacturer, size, type...)
Instruction handbook	It is mandatory to provide a clear, precise and useful instruction book with all the sprayers. Information about calibration, cleaning and maintenance shall be provided.

All the aspects described in table 1 are in accordance with the official requirements established in the European Directive 2009/127.

Contents of the SPISE guideline

It is obvious that not all the technical requirements included in ISO 16119 can be explained briefly and easily on a practical guideline as it is. For that reason, this SPISE guideline includes the most relevant a practical aspect to be considered. The included items are:

- Required characteristics of the spray tank
- Technical requirements of the pump
- Spray boom (for field sprayers)
- Filters and nozzles
- Devices for avoiding drift
- Measuring systems
- Provisions for connecting test equipment
- Air and liquid adjustments
- Cleaning devices
- Induction hopper

All the included aspects have been selected due its possibility to be easily checked over a sprayer, without any kind of measurement or instrument. The SPISE guideline includes also a special chapter dedicated to band sprayers and its special requirements.

Figures and schemes

As a practical guideline, most of the items included on it have been accompanied with explanatory figures or schemes. The main objective of this guideline is to be used as a practical document to help farmers during the process of sprayer selection. Figures 1 and 2 are some examples of graphical information included on the guideline.



Figure 1. The sprayer shall be provided with a device for an easily connection of instruments used during the mandatory inspection of sprayers in use according ISO 16122. Left: easy adaptor for pump tester; right, easy plugging adaptor for testing manometer.



Figure 1. Main aspects to be considered on a sprayer tank

Instruction handbook

As a mandatory requirement established in EU Directive 2009/127, all the sprayers must be provided with a instruction handbook. This document shall incorporate diverse aspects in order to help the users for a proper use of the sprayer. For this reason, a specific chapter concerning instruction handbook has been included in the SPISE guideline. Table 2 shows the mandatory information to be included.

Conclusions

Following the aim of SPISE community, the development of the advises' guidelines collection follows to increase the knowledge and dissemination of all aspects related with inspection of sprayers in use, knowing the importance of the topic directly related with a good a safe use of pesticides. The entire collection of the guidelines can be downloaded at <https://spise.julius-kuehn.de/index.php?menuid=34&getlang=en>

Table 4. Main aspects to be included in the instruction handbook

Subject	Information to be included in the instruction handbook
Adjustment and calibration process	Detailed explanation about how to adjust the working pressure Complete calibration procedure information Folding/unfolding method of boom sprayer How to proceed in case of blocked nozzle, or other problems during the spraying process in the field.
Maintenance	Maintenance and updating process of the sprayer after the Winter break Practical information about how to prepare the sprayer for the winter break Precautions to be considered during the cleaning process, especially those concerning to environmental contamination Detailed information about maintenance procedure and safety measurements before dismounting pieces. Practical information concerning pump substitution
Safety	Practical recommendations to avoid direct contact with plant protection products, or inhalation dangerous vapours. Practical information about safe use of front spray boom (if applicable) Information about risk of a complete entry on the sprayer's tank Check the presence of other persons close to the sprayer before starting; special concerns must be indicated about blower Information about potential accident with high electrical lines. Information about maximal working pressure of the circuit

References

EC/127. Directive 2009/127/EC of the European Parliament and of the Council of 21 October 2009 amending Directive 2006/42/EC with regard to machinery for pesticide application; 2009 [Of. J. EU, 25.11.2009, L 310/29].

EC/128. Directive 2009/128/EC of the European Parliament and of the Council of 21 October 2009 establishing a framework for Community action to achieve the sustainable use of pesticides; 2009 [Of. J. EU, 24.11.2009, L 309/71].

Effect of sprayer boom curvature on spray distribution: test on spray distribution bench

M. Stas¹, G. Defays¹, P. Bienfait¹, G. Dubois¹, A. Delooz J¹, O. Mostade¹

¹Walloon Agricultural Research Center (CRA-W), Agricultural Machines and Facilities Unit. Chée de Namur, 146. 5030 Gembloux

Introduction

Since the establishment (1995) of the control of pesticide application equipment in Belgium, the boom curvatures are appreciated only qualitatively. Where there is a doubt, a string is stretched on the extension of the imaginary line of the boom. Until now, limits have been set arbitrarily. So far, a large curvature is the cause of a refusal of the sprayer to control. In front of this lack of accuracy in measurement, pertinence was needed for justification of the sanctions. A study that specifically targeted the effects of boom curvatures on spray quality was missing. Scientific results should help to objectively determinate legal tolerances.

Materials and methods

A boom of 6 meters is used: The structure is suspended above a splitter bench. The nozzles mounted on the ramp are 110 ° slotted nozzles. The "curvature" tested in this test actually is a straight slope of the boom. The 6 m boom is considered a half boom, one end of which corresponds to the center of the spray. The angles of inclination are made into the vertical and horizontal planes. In addition, combinations of the two planes are also tested. The boom is inclined at the angles of 0 °, 1 °, 3 °, 5 ° and 6 °. The working height is fixed at 60 cm. It corresponds to a commonly used height and also to a test height recommended in standard 5682-2. The 0° angle defines the ideal position of the ramp.

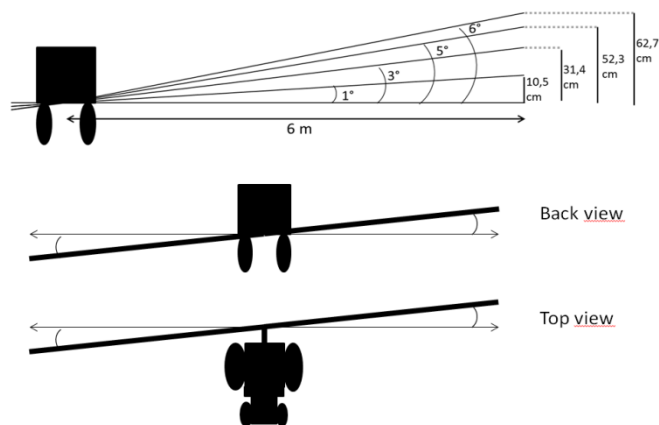

Figure 15 : boom positions into two planes tilts

Spraying is carried out on a static boom, inside a closed room, guaranteeing the absence of wind and a stable ambient temperature and hygrometry. The spray pressure is set at 2 bar. Three theoretical working heights are fixed: The most used height = 60 cm; a lower value = 50 cm; a higher value = 75 cm. The spraying time is 120 seconds. Three repetitions are performed for each measurement.

The total spray width on the bench is 7.5 m for a boom at 60 cm working height on horizontal position. At the ends of the boom there are edge effects of about 1.5 m because the jets of the last nozzles do not benefit from overlays as those of their neighbors. Delimitations were set so that within the range of 4.5 m wide, no edge effects are observed.

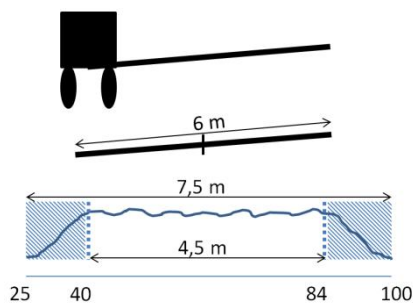

Figure 16 : spray pattern in the 75 collecting tubes. Hatched = edge effect. Numbers under repartition = collecting tube numbers

The 6 m boom is used to simulate a half ramp of a 12 m hypothetical sprayer. At the extremity that represents the theoretical center of the 12 m ramp, the edge effect is not taken into account. Indeed, it is non-existent in the center of a ramp. On the other hand, the edge effect on the extremity that represents the boom end is maintained in the results because it corresponds to a field reality (Figure 16). From all water volumes of collecting tubes, charts are made representing distribution of each measurement. To simplify the reading of these graphs, three points are defined on the ramp: A = nozzle of the left end; B = nozzle of the right end; C = center of ramp (Figure 17). Point C is always fixed at working height. In the case of vertical angles, point A is always pointing downwards and the point B always upwards. These points A, B and C are shown on the distribution charts.

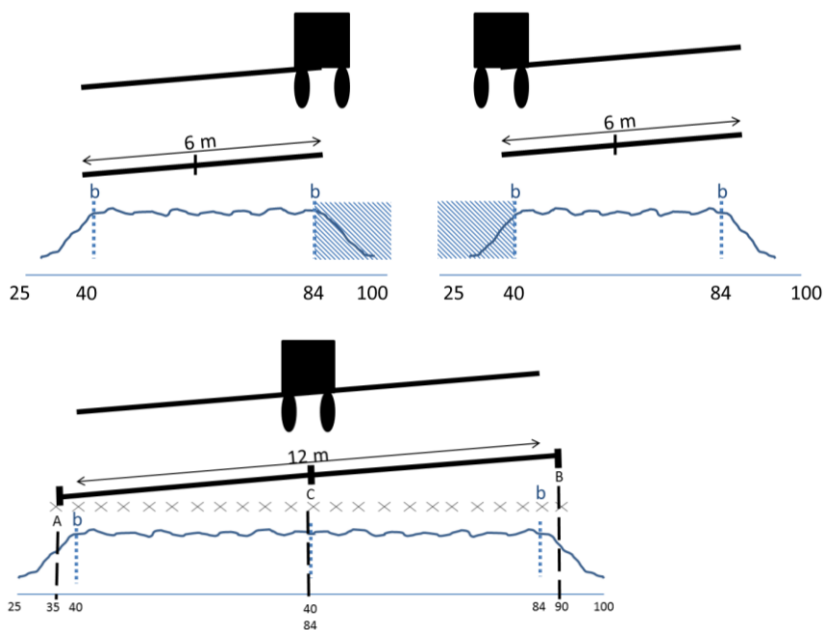

Figure 17 : Simulation of the distribution for a 12 m boom by combination of two half-boom of 6 m. The unwanted edge effects of the center of the boom are removed beyond the tube 84 and before the tube 40. "b" = boundary of the edge effect. Hatched = edge effect deleted from the data. Cross = location of a nozzle

Results and discussion

Coefficients of variation (C.V.)

The coefficient of variation (C.V.) is calculated as the ratio of the standard deviation to the mean and it is expressed as a percentage. In the analysis of C.V., edge effects were deduced.

In theory, for slit nozzles of 110 ° and spaced 50 cm apart, the overlap is double from 35 cm working height and triple from 50 cm working height. The coverage of the jets on the ground increases with the

height of the nozzles. As a result, C.V. decreases with height. Unsurprisingly, C.V. from this work also increases with the amplitude of the vertical angle facing down because the working height decreases. On the other hand, C.V. obtained with vertical angles upward are all similar to each other beyond 60 cm in height. That could be explained by the fact that the recovery reaches its maximum beyond 60 cm. However, the quality of repartition (in term of C.V.) is not affected by any horizontal deviation (until 6°).

Distribution

At a working height of 50 cm, the distribution difference between the horizontal position and 1 ° of inclination is barely visible. On the other hand, from 3 ° inclination, the disturbance of the distribution is well marked. It is located at the lower end of the ramp (left on the Figure 18). No effect is observable on the upper part (right), except for a slight increase in the width sprayed at the end. At an average working height of 60 cm, the effect of the inclination 3 ° is reduced compared to the working height of 50 cm. This is because the nozzles are higher and the overlap is better. On the other hand, spectacular effects are visible as soon as the inclination of the boom is stronger. On chart, the disturbances due to the angles 5 ° and 6 ° are visible as of the 5th nozzle starting from the end left.

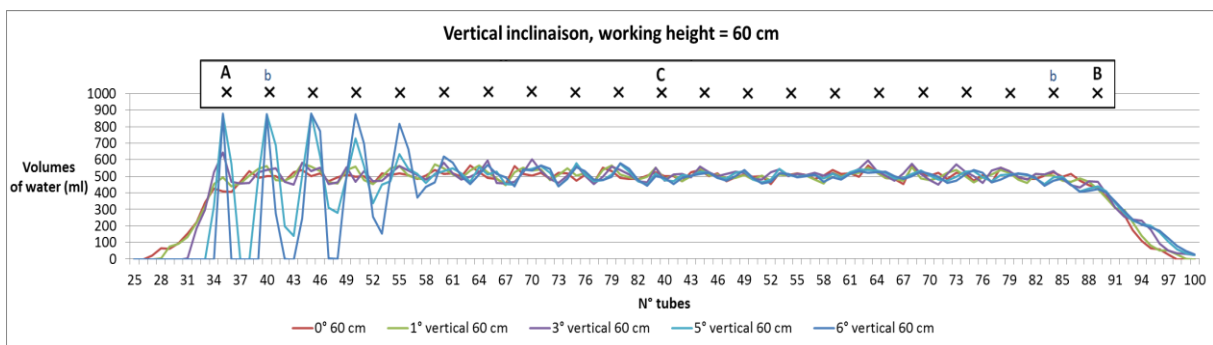

Figure 18 : spray pattern for a ramp inclined vertically. The simulation is carried out from 2 half-ramps of 6 m which meet at point "C" as on Figure 3. "A" = nozzle at the low end. "B" = nozzle at the high end. "b" blue = limits of edge effects. Cross = nozzle location. Working height = 60 cm fixed at point "C"

Similar observations to those of the height 60 cm can be made on the graph of the working height of 75 cm. Again, distribution disturbances are generally reduced by the higher spraying.

By observing these graphs, interesting information emerges about the width of work. This latter increases slightly with the working height. When boom is perfectly horizontal, liquid is projected beyond the end nozzles ("B" points). The additional widths are 70 cm, 80 cm and 100 cm for the respective working heights of 50 cm, 60 cm and 75 cm (Figure 18). If the boom is tilted downwards, working widths are lost. In this test these lost are similar regardless of the working height, but variations are observable according to the angles.

Effects of back and forth on field

The following charts simulate sum of two boom-end sprays crossings on field, for side-by-side or for back and forth. The example is given for a working height fixed at 60 cm on the half-boom of 6 m. Between 1 and 3 degrees of angular amplitude, only one occasional accident appears in the distribution for side-by-side passage (Figure 19): a slight underdosing and a slight overdose.

From 5 ° angle amplitude, the effects are clearly observable. Since a vertical angle is directed downwards, the over- and under-dosages are spectacular despite the summation of the two passes. Already when passing side by side a boom that is deformed upwards and another deformed downwards, the distribution quality is reduced by about 2.5 m wide (Figure 19). During the passage of two deformed booms downwards side by side, some areas are not treated at all and the occasional overdose peaks are doubled over a total width of nearly 4.5 m (Figure 20). On the contrary, when two upward booms pass side by side, the distribution quality is almost undisturbed (Figure 21).

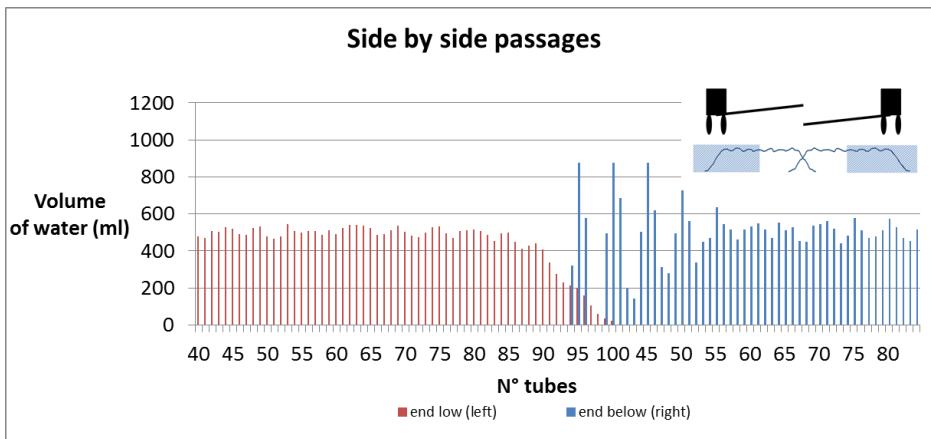

Figure 19 : sprays at the boom ends during two side-by-side passages: chart shows the decomposition of the liquid sprayed by each of the two passages. Half booms are inclined 5 ° upwards and downwards respectively. Working height = 60 cm

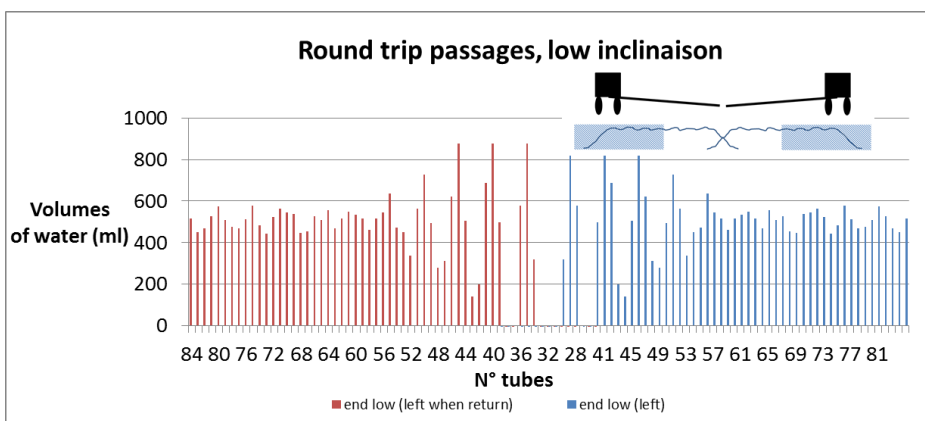

Figure 20 : sprays at the boom ends during two round trip passages: chart shows the decomposition of the liquid sprayed by each of the two passages. Half booms are inclined 5 ° downwards. Working height = 60 cm

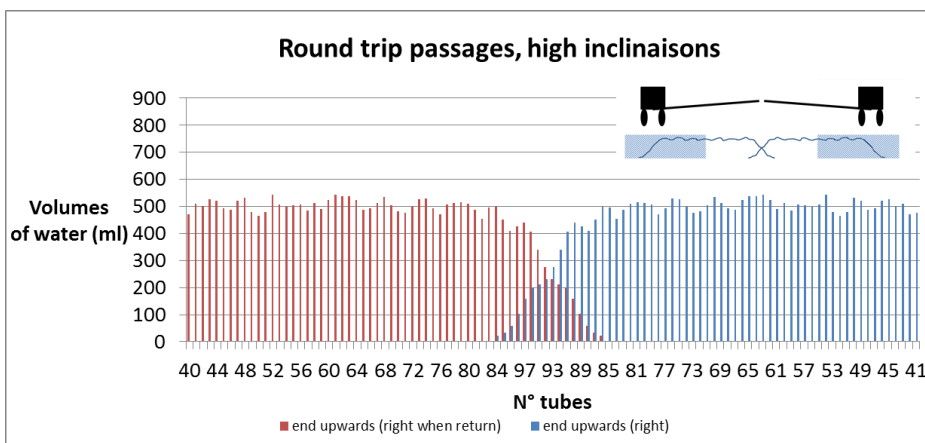

Figure 21 : sprays at the boom ends during two round trip passages: chart shows the decomposition of the liquid sprayed by each of the two passages. Half booms are inclined 5 ° upwards. Working height = 60 cm

Conclusion

Results of this study provide quantitative information on the effects of boom inclination. The main conclusions are the following:

- Inclinations of the boom in horizontal plane from the angle of 1° to 6° have no effect on spray distribution. This criterion considered in the context of mandatory control could therefore be re-evaluated.

- Inclinations of the boom in vertical plane induce different effects following it is directed upwards or downwards.

Upwards, even the strong inclination (63 cm of deflection for a 6 m of boom length), does not affect the distribution out of edge effects. At the boom end, only a very slight increase in the distribution area is observable. This causes a negligible effect on the crop by the round trip of the tractor in the field.

Oriented downwards, the inclination of the half ramp of 6 m induces significant disturbances from an angle of 3° . The importance of these disturbances does not only depend on the deviation that is measured at the control, but depends on the initial working height, the angle and the length of the boom. This work shows that the disturbances of the distribution are in reality strongly dependent on the height of the nozzles at the end of the boom. A too low height induces a lack of covering sprays and a decrease of surface sprayed by each nozzle. The return of the tractor in the field on the neighboring pulverized strip reduces the distribution fault for parallel passages but increases it for round-trip passages. In addition, it should be noticed that the study was performed in a laboratory in a static situation. In the field, distribution is inevitably strongly variable: the boom moves continuously by effect of ground irregularities and the wind modifies sprays of droplets. So, it can be retained from all results that downward inclination is an important point in the control of the sprayers. However, the way of measuring it and the way of setting the acceptable limits could be reconsidered.

Sprayers adjustment at the workshop thanks to the use of a dedicate software

Gianluca Oggero¹, Paolo Balsari¹, Fabrizio Stefano Gioelli¹, Luisa Cavargna Bontosi², Federico Spanna³

¹ Torino University – DiSAFA – Crop Protection Technology Laboratory – Grugliasco (TO)

² CSI Piemonte - Information System Consortium of Piemonte Region – Torino

³ Piemonte Region – Regional Ministry of Agriculture - Torino

Summary

In Piemonte Region, the instrumental adjustment of sprayers is compulsory when the farm comply with sustainable production standards and for this reason draws European subsidies. To ease the task of technicians involved in this assignment, the regional administration - in collaboration with the Information System Consortium (CSI) and the DiSAFA (Torino University) - developed a dedicated on line software as an integration of the current one that is suitable for functional inspection only.

The software is accessible to qualified technicians only and is split into two parts according to the type of sprayer (either boom sprayer or sprayer for bush/tree crops). Data concerning type of crops, treatment, crop canopy (for orchards only), nozzles, operative parameters (pressure, forward speed, applied volume etc.) are initially collected on a paper form and then typed into the software. The last section of the software is dedicated to the sprayer instrumental adjustment and it provides the results achieved with the use of the test benches (optimal boom working height for field crop sprayers and vertical distribution pattern for air assisted sprayers). The result of the adjustment can be print as a report and delivered to the farmer.

Introduction

Article 8 of the EU Directive 128/2009/EC foresees that professional users have to be properly trained about the procedures to be followed for an appropriate sprayer calibration/adjustment. Sprayer calibration made at farm level is however limited due to the lack of specific instruments/devices necessary for this operation.

An off-field sprayer adjustment can therefore be made from time to time at the authorized workshops as a complement of the mandatory sprayer functional inspection. This activity should be carried out for the main crop type present in the farm by using specific test benches to verify if the emitted spray plume matches the target crop shape and dimension (bush and tree crops sprayers) or if a sufficient evenness of the transversal spray distribution (field crops sprayers) is achieved.

The Piemonte Regional Administration, considering that a correct sprayer adjustment is a key factor to achieve an effective reduction of the environmental impact related to the plant protection products application, has promoted this operation through the assignment of economic incentives for farmers based on EU funds. Off field sprayer adjustment should be made at least once every 5 years.

To facilitate the authorized workshops in managing such activity, following also the indication reported in the Spise Advices for sprayers adjustment (Balsari *et al.*, 2015 and 2016), a dedicated on line software was developed by the Information System Consortium of the Piemonte Region (CSI) with the support of DiSAFA – University of Torino.

This software is a web application inside the Internet portal of CSI and developed with a Java technology. It is located in the application server JBoss. Data are stored on DB Oracle. It is available with main internet browsers like Mozilla, Chrome, Safari.

Materials and Methods

The regional official procedure requires that data concerning sprayers adjustment are at first recorded at the workshop by using a specific paper form. Data are afterwards uploaded to the on line software by authorized technicians who successfully passed a specific examination (complementary to the authorization for sprayers' functional inspection).

The software is suitable only for brand new sprayers or for sprayers that already successfully passed the functional inspection (mandatory for five or more years old sprayers). Furthermore, the software can be used only for those sprayers which specifications (e.g. brand, model, type, vehicle identification number) have already been uploaded to the regional informatic tool used for issuing their functional inspection.

Software utilization

As a first step, the technician has to identify on a pre-loaded list the farm owning the sprayer that has to be adjust. From that point on the software' screenshots are different according to the type of sprayer (either for field crops or for bush/tree crops). The software is not designed yet for lances, cannons knapsack mistblowers, foggers, etc...

Once all space have been filled up with the requested data, it is possible to print the adjustment report and delivered it to the farmer.

Below the information concerning the use of software according to the type of crops are schematically summarized.

Field crop sprayers

Information concerning working width, utilized configuration are already available as they are pre-loaded into the software during functional inspection.

As a second step, the main crops treated by means of the sprayer have to be selected from a list of options grouped into homogeneous categories (table 1).

Afterwards, the type of treatment (herbicide pre or post emergence, fungicide or insecticide) has to be selected (table 2).

Table 1. Possible crops to be choice as those in which the sprayer is used

maize/sorghum/sunflower/soya
wheat/barley/oats
rice
horticultural crops and strawberries
horticultural crops and strawberries in greenhouse
other

Table 2. Type of Target and treatments

paddy field ground (pre-emergency) weed with vegetation up to 10 cm high (post-emergency) weed vegetation over 10 cm high (post emergency) other treatments (fungicides, insecticides)
--

For all selected cases (besides case “a”) it is also necessary to indicate whether the operation is performed: broadcast or on band.

For each type of crops/target-choice shall be performed a specific sprayers adjustment and the additional following data have to be provided:

Nozzle type (flat fan, twin flat fan, hollow cone, mirror, pneumatic, centrifugal), model and manufacturer;

Nozzle distance (m);

Working pressure (bar);

Flow rate (l/min)

Forward speed (km/h);

Application rate (l/ha).

Some of these data can be recovered from the sprayer functional inspection report. Nevertheless, the inspector can discretionally suggest different settings to achieve better performances.

If the sprayer is equipped with an air sleeve, its main purpose (drift reduction or better canopy penetration) has to be indicated in the report as well as its suggested inclination (if adjustable).

The indication about the air speed adjustment within the air sleeve is not compulsory. Nevertheless, when the necessary instruments are available at the workshop it is possible to include this data in the dedicated software space

A blank space is also available in the software for further indication the technician consider to be useful for the farmer in order to allow him to appropriate use the sprayer.

As last step, the optimal boom working height with respect to the considered operative conditions (those choice in table 2) is indicated. The latter is the result of a measurement made thanks to an horizontal patternator.

For each selected treatment and crop (from points “a” through “e” of table 2) it is necessary to perform an instrumental measurement (even though the others operative conditions – those of table 1- don’t change) and fill the relative software space.

Bush and tree crop sprayers

Information concerning the number of treated rows per each sprayer passage and related to the fan main characteristics (when it is present) are already available on the software and visible on the screen as they were pre-loaded into the software during sprayer functional inspection.

Similarly, to field crops, the main crops treated by means of the sprayer have to be selected as well as the treatment type (Table 3):

Table 3. Possible crops to be choice as those in which the sprayer is used

Vine
fruits
hazelnut, walnut
kiwifruit
blueberry, raspberry, currant, etc
olive
other

For each crop it is also necessary to indicate (choosing between those of figure 1) the shape of the crop profile most close to the farm real situation.

Figure 1. The shape of the crop profiles between those the software ask to identify the one more close to the farm real situation

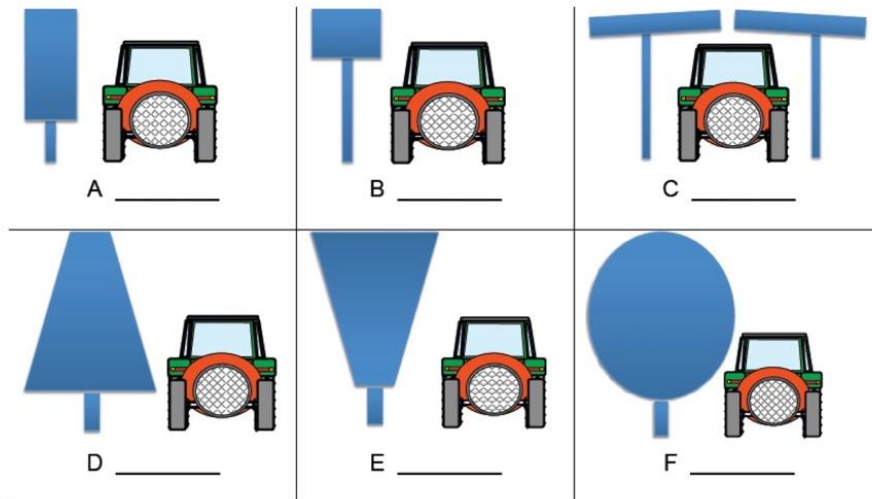

The software also ask the following information:

- Crop Training system;
- Crop vegetative stage for which the adjustment is reliable;
- Maximum crops height;
- Main target (trunk, leaves, grapes);
- Inter-row distance (m) ;
- Number of rows treated with a single sprayer passage;
- Type and number of nozzles fitted on the sprayer;

- Working pressure (bar);
- Total flow rate (l/min)
- Forward speed (km/h);
- Volume application rate (l/ha);

Data concerning the fan main operative parameters like: type of gear, blades inclination, upper and lower air deflectors positioning (when they are present);

Also in this case several of the mentioned data can be recovered from the functional inspection report. Nevertheless, the technician can discretionally suggest different sprayer settings to achieve better performances. A blank space is also available for further indication the technician consider to be useful for the farmer in order to allow him to appropriate use the sprayer.

As a last step, data concerning the vertical distribution pattern achieved by the use of a vertical patternator are typed into the system. An aid for technicians to choose the most suitable nozzles to achieve the intended distribution pattern is available at the following URL: <http://www.laboratorio-cpt.to.it/diagramma-atomizzatori>. The latter consists in a software that – according to the sprayer and nozzles type – provides in real time the achievable distribution pattern (Tamagnone et al., 2015; Tamagnone et al., 2017).

For each combination - crop type/selected profile – (Table 3 + Figure 1) it's necessary to provide a minimum of two instrumental adjustments (one for young and reduced canopy trees, and a second one for adult and maximum canopy development trees) by filling up further software dedicate space.

Results and conclusions

The software entered into operation in September 2017. So far 176 sprayers (78% of those being air assisted sprayers) were calibrated. A total of 278 setting have been uploaded, 114 of which related to sprayers for vineyards.

The software resulted to be user friendly for technicians and has the advantage of having a simple and easily understandable report as an output. The report – besides the main identification data of both the farm and the sprayer – includes all the main sprayer adjustment suggested and, for air assisted sprayers, the results of the measured vertical distribution patterns. In the following annex is reported an example of the adjustment report to be deliver to the farmer/owner of the sprayer at the end of the adjustment procedure.

References

- AA.VV. Directive 2009/128/EC of the European Parliament and of the Council of 21 October 2009 establishing a framework for Community action to achieve the sustainable use of pesticides.
- Tamagnone M, Calvo A., Savoia S. (2015). Development of a software for supporting the adjustment of vertical spray pattern of air assisted sprayers. *Julius Kuhn Archiv*, 448: 19-20.
- Balsari P., Herbst A., Langenakens J. (2015). Advice for crop sprayers adjustment. ISSN 2364-7574 – DOI 10.5073/spise.en.2015.01
- Balsari P., Herbst A., Langenakens J. (2016). Advice for sprayers for bush and tree crops adjustment. ISSN 2364-7574 – DOI 10.5073/spise.en.2016.01
- Tamagnone M., Calvo A., Godone M. (2017). Adjustment of vertical spray pattern of orchard sprayers with Ve.S.Pa. 2.0 application. Book of Abstracts of Suprofruit 2017 -14th Workshop on Spray Application in Fruit Growing, 45-46

ANNEX



REGOLAZIONE STRUMENTALE IRRORATRICI

(Ai sensi dell'Azione A3.7 del Piano d'Azione Nazionale per l'uso sostenibile dei prodotti fitosanitari - DM 22/01/2014)

RIEPILOGO

FARM INFORMATIONS

AZIENDA

CUAA 02500020066 Partita IVA 02500020066

Denominazione BATETTA CLAUDIO & DEMARTINI LUISELLA SOCIETA' SEMPLICE SOCIETA' AGRICOLA

Indirizzo sede legale VIA SAN GIACOMO 16-LU-AL

PEC BATETTASOC@LEGALMAIL.IT

Mail Telefono

CONTROLLO

Data rilievo 13/02/18

Esito controllo Esito positivo

Rilevatore AMERELLI MASSIMILIANO

Centro di controllo SATA SRL

INSPECTOR AND TEST

MACCHINA

Tipo macchina Atomizzatore o assimilabile - aeroassistita

Marca UNIGREEN

Modello EXPO 6801

Telajo 1870

Anno 2005

SPRAYER INFORMATIONS

UTILIZZO DELLA MACCHINA

Progressivo regolazione	Principali colture trattate	Eventuale valore "altro"	Profilo colture trattate	Eventuale valore "altro"
1	frutta in guscio	HAZELNUT	E - profilo trapezio capovolto - piena vegetazione/piante grandi	
2	frutta in guscio		E - profilo trapezio capovolto - vegetazione ridotta/piante piccole	
3	vite	GRAPEVINE	A - profilo rettangolare - piena vegetazione/piante grandi	
4	vite		A - profilo rettangolare - vegetazione ridotta/piante piccole	

MAIN CROPS

NUMEBER OF ADJUSTMENTS

TREE PROFILE (SEE FIG 1) AND GROWTH STAGE

DATI DI DETTAGLIO DELLE REGOLAZIONI

REGOLAZIONE 1 **ADJUSTMENT 1**

Principale Coltura Trattata

Profilo Coltura Trattata

MAIN OPERATIVE PARAMETERS

Velocità avanzamento (km/h) Portata erogata (l/min)

Pressione di esercizio (bar) Volume distribuito (l/ha)

Numero ugelli Disposizione simmetrica degli ugelli/regolatori di portata

NOZZLES USED

Ugello	Facciata 1	Facciata 2
1	PIASTRINA 1.2 ALBUZ	PIASTRINA 1.2 ALBUZ
2	PIASTRINA 1.2 ALBUZ	PIASTRINA 1.2 ALBUZ
3	PIASTRINA 1.2 ALBUZ	PIASTRINA 1.2 ALBUZ
4	PIASTRINA 1.2 ALBUZ	PIASTRINA 1.2 ALBUZ
5	PIASTRINA 1.2 ALBUZ	PIASTRINA 1.2 ALBUZ
6	PIASTRINA 1.2 ALBUZ	PIASTRINA 1.2 ALBUZ

FIELD CONDITIONS

Forma di allevamento Altezza max vegetazione (m)

Epoca vegetativa Filari trattati con unico passaggio (n)

Bersaglio Interfila (m)

Diagramma di distribuzione del liquido **VERTICAL PATTERN**

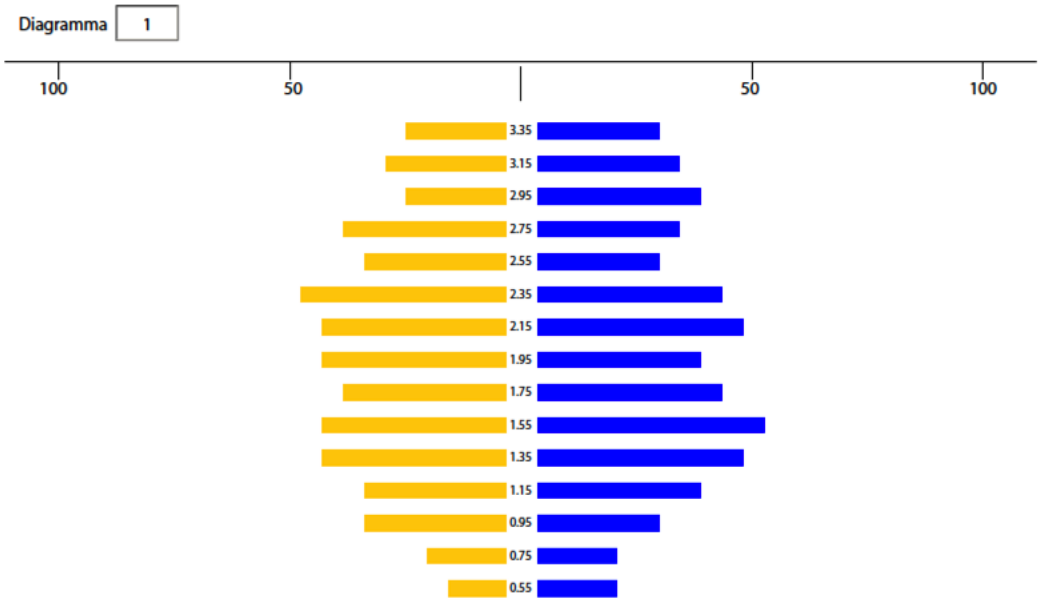

REGOLAZIONE 3 **ADJUSTMENT 3**

Principale Coltura Trattata

Profilo Coltura Trattata

MAIN OPERATIVE PARAMETERS

Velocità avanzamento (km/h) Portata erogata (l/min)

Pressione di esercizio (bar) Volume distribuito (l/ha)

Numero ugelli Disposizione simmetrica degli ugelli/regolatori di portata

NOZZLES USED

Ugello	Facciata 1	Facciata 2
1	ATR 80 GIALLO	ATR 80 GIALLO
2	ATR 80 GIALLO	ATR 80 GIALLO

FIELD CONDITIONS

Forma di allevamento Altezza max vegetazione (m)

Epoca vegetativa Filari trattati con unico passaggio (n)

Bersaglio Interfila (m)

Diagramma di distribuzione del liquido **VERTICAL PATTERN**

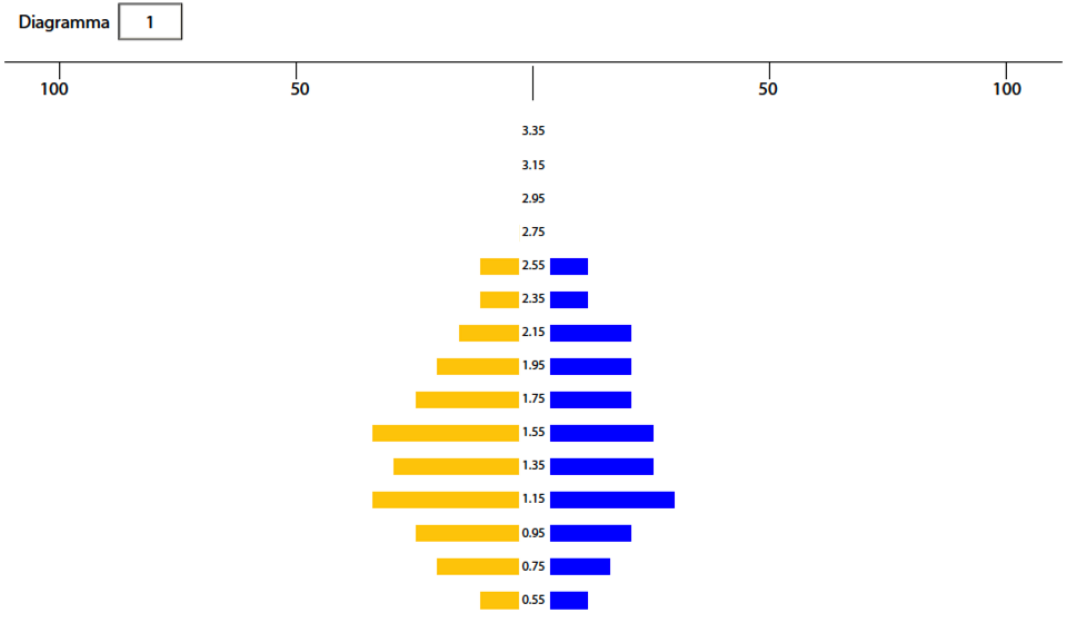

A test method to assess operator safety using Closed Transfer Systems

Jens Karl Wegener, Matthias Kemmerling, Jan-Philip Pohl, Eckhard Immenroth

Institute for Application Techniques in Plant Protection, Julius Kühn-Institute, Federal Research Center for Cultivated Plants, Messeweg 11/12, 38104 Braunschweig.

Summary

Closed transfer systems (CTS) are devices for the contactless transfer of plant protection products (PPP) into pesticide application equipment (PAE). They are intended to protect the operator against contamination with undiluted PPP during filling of the sprayer. CTS are universal and can be mounted on a wide range of different types and sizes of PAE. They are able to transfer the PPP from container of diverse sizes, enable also partial draining and containers can be easily rinsed after complete emptying.

At the moment there is no reliable information about the contribution of CTS to operator safety. For this reason a test method was established in order to compare the operator's contamination after the dosing process using CTS and conventional filling into the PAE. Aim of the project was to quantify the dermal exposure at different parts of the operator's body.

Instead of PPP a mixture of water and a fluorescent tracer (Pyranin) was used. It was filled into 10-Liter-containers and sealed. The operator was equipped with Personal Protective Clothing which was washed after the filling process in order to determine the amount of contamination on different parts of the body by using fluorometry. The different filling processes were performed by 3 different persons with 5 repetitions per setting using an attached field crop sprayer (RAU D2) with a CTS mounted on the induction hopper and also on the dome shaft.

The results show that CTS can significantly help to minimize operator exposure in comparison to conventional filling and that the test procedure established is able to fulfil the defined aims of testing CTS.

Introduction

In a draft paper (EU 2015) the European Commission demands the assessment of negligible exposure to an active substance in a plant protection product (PPP) under realistic conditions of use. Among other things this applies for the exposure of humans in particular during the filling process of pesticide application equipment (PAE) when the operator is exposed to contamination by undiluted PPP. These new requirements concerning negligible exposure can have an impact on the future capability for the approval of PPP. Against this background Closed Transfer Systems (CTS) can due to their working principle contribute to operator safety and could be a technical solution to fulfill the requirements of negligible exposure.

CTS are devices for the contactless transfer of PPP into PAE. The working principle is based on a connection port which can be mounted on the sprayer and an adaptor on the sealed PPP canister. Once both units are connected to each other the system is ready for filling and it protects the operator against contamination with undiluted PPP. The unsealing of the canister happens with an internal mechanism within the system. CTS are universal and can be mounted on a wide range of different types and sizes of PAE. They are able to transfer the PPP from containers of diverse sizes, enable also partial draining with precise dosing and allow an easy rinsing of the containers within the closed system once they have been emptied. Before the connection between port and adaptor is unlocked the contact surfaces can be rinsed, too. The adapter remains on the container until it has been completely emptied.

At the moment there is no reliable information about the contribution of CTS to operator safety. In order to consider the advantages of CTS within the process of authorization of PPP it is necessary to make an assessment comparing the operator exposure based on conventional filling against those using a CTS under realistic conditions of use. Aim of this work was to develop a testing routine for the assessment of operator exposure using CTS in comparison to conventional fillings.

Materials and Methods

In order to determine the operator exposure different varieties of fillings of a field crop sprayer (RAU D2) were simulated by different persons wearing protective clothes. Instead of PPP, water and a fluorescent tracer (Pyranin from Lanxess company, concentration of 5g/l) was filled into PPP-canisters of different sizes (1, 5, 10 liters) which have been sealed afterwards. After the filling routine of PAE done by a person in protective clothes the protective clothes were rinsed off by hand or washed separately in a washing machine (Miele W1 classic). Afterwards, the collected rinsing/washing water was analyzed using fluorescence spectroscopy (Kontron Instruments SFM 25).

The distribution of the exposition on the operator was detected by using five different dosimeter: a whole-body counter consisting of an overall (65% cotton, 35% polyester) and long underwear (95% cotton, 5% elastane), one-way laboratory gloves (semper guard nitrile powder free) worn beneath nitrile protective gloves (KCL Camatril) and a protective visor (EKASTU k1 plus). The long underwear and the one-way laboratory gloves were used in order to determine the total body exposure even for the case that the protective clothes are not free of leakage.

The experimental setup was divided into two steps. First, seven different operators had to do a conventional filling using the induction hopper of the field crop sprayer using all different sizes of the PPP-canisters. The canister size leading to the highest operator exposure was then chosen as worst-case scenario for further experiments.

In a second step three operators did a conventional filling of PAE using a) the dome shaft and b) the induction hopper of the field crop sprayer which was then compared against a filling with a CTS mounted on top of c) the dome shaft and d) the induction hopper. Each setup was carried out with five repetitions. After each repetition the protective clothes were taken off and boxed for later analysis.

The washing of the overalls and underwear was carried out three times directly after each other for each piece by using the program "Express 20" at a water temperature of 30°C and a water volume of 17 liters. The water from the first and second washing was used for the determination of the tracer content, the water from the third washing for the definition of the blank value. In order to avoid measuring errors due to different water qualities the washing water was completely demineralized (AFT VE-Station 100 Mono) and the electrical conductivity was measured continuously for monitoring the quality. Cause of textiles fibers within the washing water influencing the working quality of fluorescence spectroscopy and its results the washing water was filtered before analysis using a stainless steel filter (Retsch test sieve) with a mesh size of 250µm.

The protective gloves, the one-way laboratory gloves and the protective visor were rinsed off by hand (protective and one-way laboratory gloves: 200ml; visor: 400ml) with distilled water.

In order to achieve reliable results it is necessary to calculate the detection limit and the determination limit. The detection limit is defined to be the sum of blank value plus triple standard deviation. Only if results of fluorescence spectroscopy are higher than the detection limit (LOD) it can be assured that there is tracer within the tested sample. A quantification of the tested sample is possible, when the result is above the quantification limit (LOQ). This is defined to be the sum of blank value plus nine fold the standard deviation. In terms of the results this means that all values beneath LOD are defined to be zero. Values measured between LOD and LOQ are considered to be at the average value between both limits. After calculating the concentration based on the aforementioned data the absolute tracer mass can be determined:

$$m = \frac{(x - B)}{a} \cdot V_{wf} = c_p \cdot V$$

with

m = mass of tracer

x = measured value (including limit definitions)

B = blank value

a = gradient of calibration curve

V = volume of rinsing/washing fluid

c_p = concentration of probe

For the determination of tracer amount which could be found on the dosimeter the volume was calculated with the above mentioned tracer concentration (5g/l):

$$V_d = \frac{m}{c_0}$$

with

V_d = volume of tracer on dosimeter

m = mass of tracer

c₀ = initial concentration of tracer within canister

Within pretests the retrieval rate was determined for all dosimeters, too. For this purpose an amount of 50µl tracer was dripped onto the specific dosimeter, washed out and analyzed as described before. The retrieval rate defines the analyzed amount of contamination compared to the amount of the known contamination:

$$R = \frac{V_d}{V_0} \cdot 100\%$$

with

R = retrieval rate

V_d = measured volume of tracer

V₀ = initial volume of tracer

The statistical analysis was done by calculating mean value and standard deviation of the results. As usual for considerations of operator safety under long term conditions a 75-percentile evaluation was done afterwards (EFSA 2014).

Results

The result of the first experimental setup is that the exposure for the operator is the highest using a 10-liter-canister (fig. 1). Against the background of conventional filling tracer was found predominantly on the protective gloves. Contaminations of the overall were detected in several cases but not with the 1-liter-canister. Furthermore, a small contamination of the underwear was found. These figures were all between the detection and determination limits. For this reason the diagram shows the average value between those two limits. But, pre-trials have shown that washing and drying the underwear had a small effect on the basic fluorescence of the material. Since the contamination of the underwear does not fit with the values found for the overall using a 1-liter-canister, and the values for the other canisters are at same level, the measured values are in all probability not due to contamination with tracer. Because of these results the 10-liter canister was chosen as worst-case scenario for the second experimental setup.

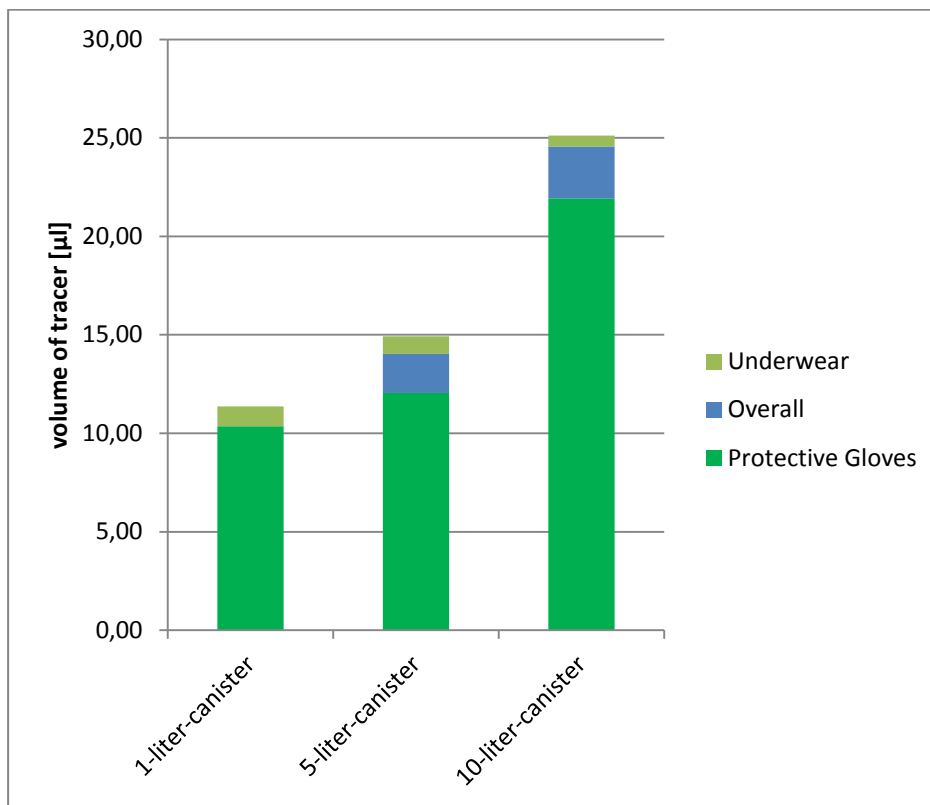

Figure 1. Exposure of different dosimeters by performing a conventional filling using the induction hopper of a field crop sprayer (RAU D2) in dependency of different canister sizes

Figure 2 shows the results of the second experimental setup. One can see that contamination on level of 75-percentile could only be found on the protective gloves and on the overall. A small contamination of the underwear between detection and determination limit was found in one case. This contamination is probably based on material effects as already mentioned above. There was no contamination on other dosimeters (visor, one-way laboratory gloves) used. From these results one can conclude that CTS can reduce the exposure of the operator significantly. If the CTS is mounted on the induction hopper instead on the dome shaft the expected exposure can be reduced further.

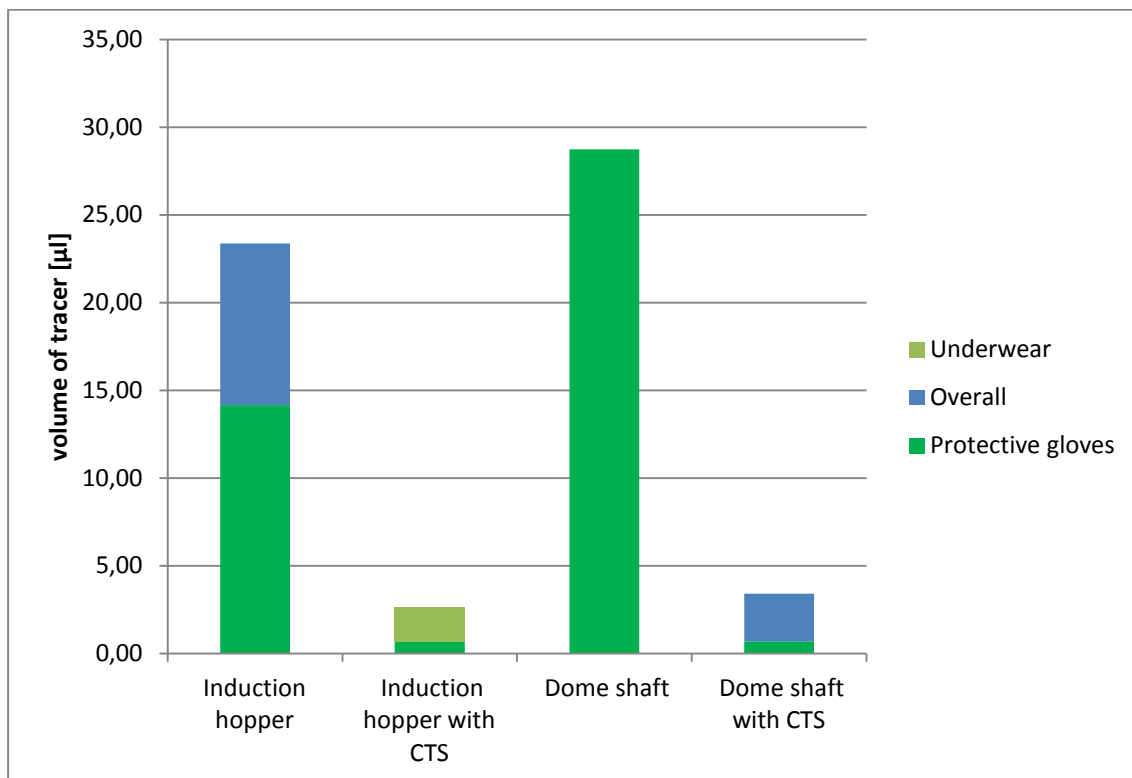

Figure 2. Total exposure of the operator performing different filling procedures on a PAE (RAU D2) with and without using CTS

The retrieval rate of the dosimeter was determined in separate experiments under field conditions. The mean retrieval rate was 83,22% for overall and 99.9% for the protective gloves.

Conclusion

The method presented in our study is able to assess operator exposure when using CTS in comparison to conventional filling of a PAE. It can be shown which parts of the operator's body are endangered for contamination with PPP. Furthermore, the developed method is able to quantify the operator exposure in an ensured and reproducible way. Based on the results only protective gloves and overall are needed as dosimeters for future assessments of CTS performance.

References

EU (2015): Commission Notice - Technical guidance on the interpretation of points 3.6.3. to 3.6.5, and 3.8.2 of Annex II to Regulation (EC) No 1107/2009, in particular regarding the assessment of negligible exposure to an active substance in a plant protection product under realistic conditions of use. DRAFT - May 2015, 17 pages.

Hilz, E., and Vermeer, A.W.P. (2013). Spray drift review: the extent to which a formulation can contribute to spray drift reduction. *Crop Protection*, 44: 75-83.

Directive 2009/128/EC of the European Parliament and of the Council of 21 October 2009 establishing a framework for Community action to achieve the sustainable use of pesticides. <http://eur-lex.europa.eu/eli/dir/2009/128/2009-11-25>

BS EN 13790-1:2003. Agricultural machinery. Sprayers. Inspection of sprayers in use. Field crop sprayers.

ISO 16119-1:2013. Agricultural and forestry machinery - Environmental requirements for sprayers - Part 1: General.

EFSA (2014): Guidance of EFSA – Guidance on the assessment of exposure of operators, workers, residents and bystanders in risk assessment for plant protection products. EFSA Journal 2014

Session 6: Inspectors training harmonization and refreshment

Inspector's training and influence on the quality of inspections. An overview of training organization in EU

Emilio Gil

Department of Agri Food Engineering and Biotechnology - Unit of Agricultural Machinery - Universitat Politècnica de Catalunya - Esteve Terradas, 8 - 08860 - Castelldefels (Barcelona) – SPAIN

Abstract

Inspector's training represents one of the most important factors affecting the effectiveness of the process. It is important to guarantee a well-trained inspector to offer a clear, objective and useful service to the farmers. But not only inspector's training is important for the success of the global process. In order to guarantee a good dissemination of the knowledge, CHAFEA (Consumers, Health and Food European Agency) launched BTSF training courses (Better Training for Safer Food) focused on inspection and calibration of pesticide application equipment. This paper shows the experience and results after 12 three-days training courses where more than 400 official stakeholders have been trained.

Great differences have been observed in the last years in the organization, contents and procedure of the inspector's training at different EU members. In order to have an objective overview of the situation, a survey was conducted among all the EU members, through more than 200 attendants to BTSF training courses. Results will be presented in this paper.

Introduction

Mandatory inspection of sprayers in use became mandatory in Europe since the official publication of the European Directive for a Sustainable Use of Pesticides (EC, 2009). From the technical point of view, the official procedure for the inspection is very well defined after the publication of the harmonized standard EN ISO 16122 (ISO, 2015). This standard series covers the most important pesticide application equipment and establishes the technical procedure for a complete inspection. This fact, however, implies two important actions: the first one is related to the knowledge and expertise on international standards for those officially involved. The new harmonized SO 16122-series establishes the technical procedure for the mandatory inspection of sprayers in use. However, its knowledge is not very well extended among the expertise and responsible bodies; the second aspect to be considered is related with technical knowledge among the official responsible in all the EU members concerning the use-phase of pesticides, it means, technical aspects related with spray technology (nozzles, air assistance, drift reduction techniques...) and with the calibration process, one of the most important aspects included in the European Directive linked to a safe and efficient use of pesticides.

These two important aspects, technical and legal requirements concerning inspection of sprayers in use, and calibration process, have been the two main topics included in the official call launched by CHAFEA (Consumers, Health And Food European Agency) through BTSF (Better Training for Safer Food) program: CHAFEA/2014/BTSF/02: "*Organisation and implementation of training activities on inspection and calibration of pesticide application equipment in professional use under the Better Training for Safer Food initiative*". The call covered the organisation and implementation of training activities on inspection and calibration of plant protection product application equipment in professional use in compliance with the provisions of Directive 2009/128/EC under the Better Training for Safer Food initiative. Once again, this official initiative launched by the European Commission demonstrates the importance and interest of training as one of the most important tools for an adequate accomplishment of the European legislation.

This paper presents a global overview after the organization of twelve three-days training courses organized in five different countries with more than 200 attendants from all EU members.

Attendants from all EU Members

More than 200 official stakeholders attended the twelve training courses that have been organized Universitat Politècnica de Catalunya (Spain), University of Turin (Italy), IRSTEA (France), JKI (Germany) and SKL (The Netherlands). All the EU Member States (28) have been widely represented during the training courses, including some representatives from third countries as Norway, Bosnia & Herzegovina, Albania, Kosovo and Switzerland (Figure 1).

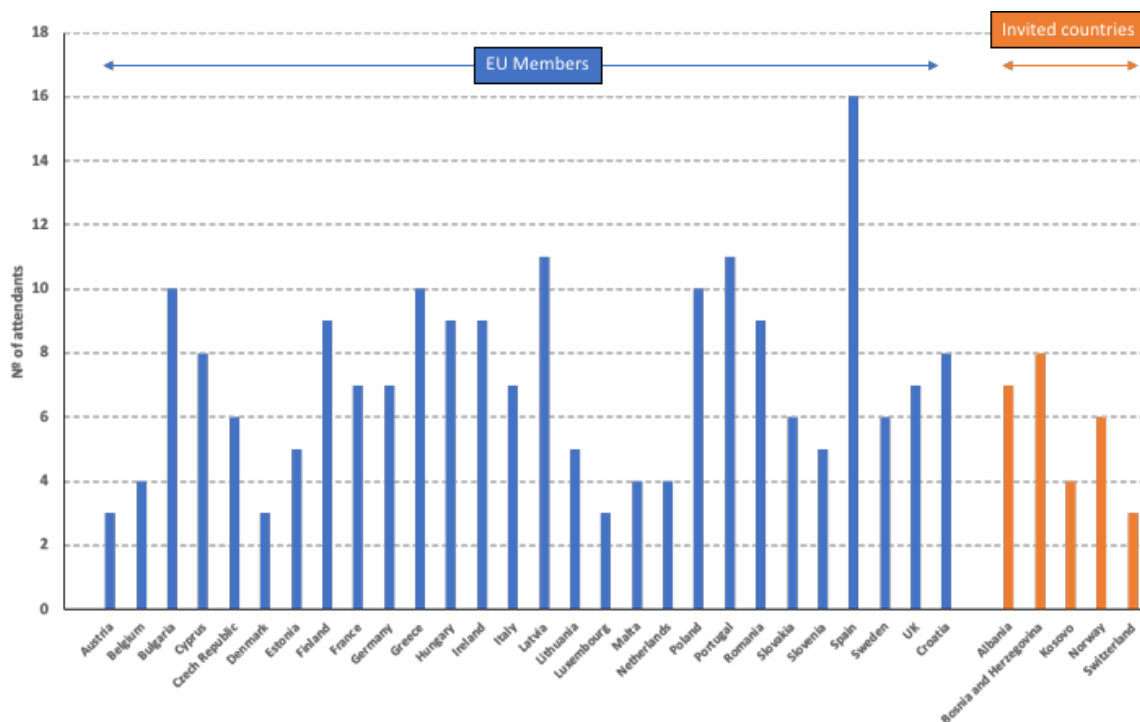

Figure 1. Distribution of the attendants to BTSF training courses, including all 28 MS and 5 invited countries

In global terms, the background of the attendants was wide, ranging from authorities' bodies, technical and administrative responsible of the inspection program, advisor bodies and academia.

Before and after questionnaire

As requested by the European Commission, an anonymous questionnaire was developed in order to evaluate the technical knowledge of the group. The main objective of the questionnaire was to evaluate and to quantify the efficiency of the training course. Fifteen multi-answer's choice were arranged, combining both technical and legal/administrative aspects. Results (Fig. 2) indicated an important increasing of number of attendants able to pass the exam (at least 50% of questions were asked correctly).

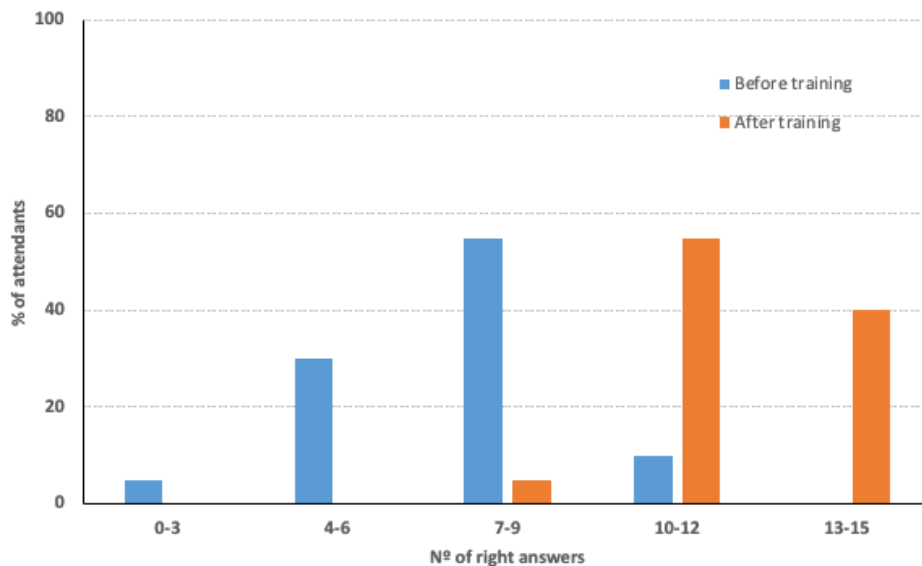

Figure 2. Percentage of attendants with number of positive answers before and after the training

Results on Fig. 2 indicated clearly the positive effect of training. Before the training courses, only 55% of the attendants were able to pass the exam. Results after the training courses increased up to 100%.

A detailed analysis of the results (Fig. 3) allows to identify big problems related with technical aspects of the sprayers or spraying application process. The 7 questions dedicated to technical aspects (Fig. 3 left) showed a great increment on success. This is especially important and allows to remark a clear default in knowledge on technical aspects related with inspection and calibration of pesticide application equipment.

However, not only technical aspects showed improvement in knowledge. Also, important improvements were detected in aspects directly related with international standard's knowledge. Important gaps were detected in knowledge concerning procedure and interpretation of inspection protocol.

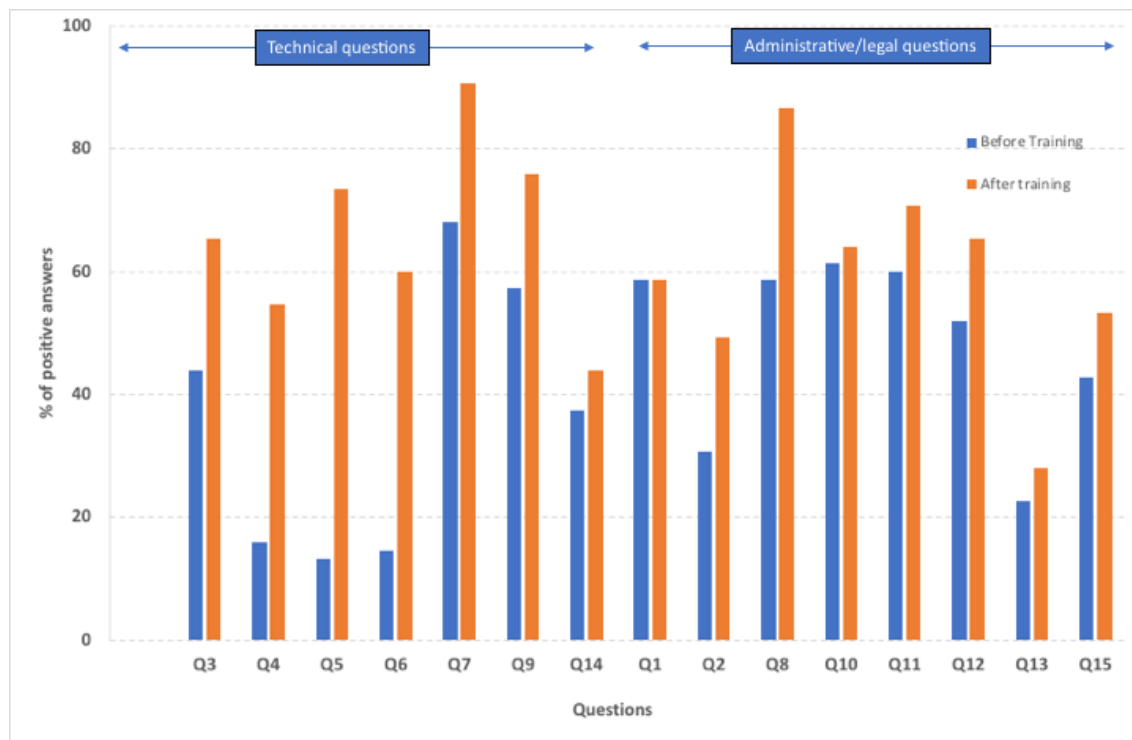

Figure 3. Percentage of positive answers before and after the training, classified according the type of question (technical or legal/administrative)

Expected benefits from the training course

A general survey was also sent to attendants before every course, with the aim to identify the most important expectations by attending the training. From a large list of answers received, it is important to remark the followed extracted aspects, directly pointed by the attendants:

- Information from experienced countries
- New contact with experts on this subject
- Information about practical aspects to implement inspections and training
- Exchange of experiences/opinions concerning PAE inspection
- Information and better understanding about new regulations/standards
- To see inspection procedure not only in the room, but in the workshop
- New ideas for inspection/calibration PAEs other than boom/orchard sprayers

In general, these expectations can be directly linked with the results obtained after the preliminary questionnaire, where most of the selected topics showed important deficiencies in terms of knowledge.

Identified problems at different Member States

The same preliminary survey was used with the aim to identify the most important problems detected by the attendants at their own countries. Here enclosed is the selected list of the most important issues addressed:

- We are expecting many problems in process implementation this program, because we don't have properly knowledge and experience.
- Not all the sprayers are covered by standards and all sprayers must be inspected
- Lack of knowledge about inspections
- Management of the transition process from old to new rules, especially in training and authorization
- EU does not lay down uniform requirements for PAE inspectors
- Farmers are not interested in the inspection before deadline December 2016
- Difficulties to implement the standards (EN 13790)
- Inspections are expensive for farmers and cheap for workshops
- Absence of practical information (n° of sprayers to be inspected)
- Acceptance of mandatory inspection for farmers
- Competition between private workshops and workshops owned by Farmer's Associations, Cooperatives...
- Difficulties to guarantee whole coverage of the zones (low benefits)

A quick reading of the selected answers indicated a clear importance of training activities as the organized by BTSF training courses. Most of the expected benefits and encountered problems at different Member States can be clearly addressed through a clear and objective training program, both at European or national level. Training has been clearly identified as one of the most, if not the most, tools to guarantee the success of the mandatory process, with no differences among EU members.

Inspector's training course: one of the most appreciated activities

As a practical example of the organization of the BTSF training courses, it can be selected as one of the most appreciated by the attendants, the one focused on the organization and implementation of training courses for the official inspectors. This topic has been identified as one of the most influencing on the success of the program. Every MS should guarantee an objective, clear and efficient training program for their inspectors. During the course, the corresponding lecture focused on this topic was followed by a practical activity in groups, where attendants were in charge to organize a complete

training course. Discussions concerning the main topics to be included, practical and theoretical balance and background of the attendants were the most discussed aspects. In general, inspector's training was clearly identified as one of the key points for the success of the process.

Conclusions

After the organization of twelve three-days training courses, the most important conclusions derived can be listed as follows:

- Combination of practical and theoretical activities represents one of the most appreciated aspect of the courses. The possibility to put in practice the aspects previously explained in lectures gave the attendants a very well appreciated opportunity to complete the training process.
- BTSF training courses allowed a good opportunity to share problems, difficulties and experiences among different Member States, being a clear advantage specially for those MS less experienced in the inspection procedure.
- Great differences among MS were observed, both in terms of inspection's organization and in legal and administrative aspects. It was detected also that, even if deadline for mandatory inspection program was already overpassed, still there are some MS where process must still be arranged.
- Difficulties on interpretation and application of harmonized international standards were detected
- Special interest was detected concerning the inspection procedure for other minor pesticide application equipment other than boom sprayers and orchard sprayers.
- Material, experience and knowledge acquired after the training course attendance have been positively appreciated by the attendants. Also, a good European network has been started among the attendants from different EU MS.
- Accurate information focused on farmers was really identified by most of the attendants, in order to convince them about the interest and benefits of mandatory inspection. Training was selected as one of the most profitable investments to guarantee the success of the process.

The experience, in general, has been very well appreciated by the attendants. According to the survey conducted after the training courses, most of them gave a very positive opinion about the courses, being one of the most valuable aspects the possibility to practice with real devices and the relationship among other experts from other MS.

References

EC/128. Directive 2009/128/EC of the European Parliament and of the Council of 21 October 2009 establishing a framework for Community action to achieve the sustainable use of pesticides; 2009 [Of. J. EU, 24.11.2009, L 309/71].

http://ec.europa.eu/chafea/food/tender-02-2014_en.html

Spanish's experience on improving inspection of sprayers: official manual for ISO 16122 and ISO 16119

Emilio Gil, Javier Campos and Paula Ortega

Department of Agri Food Engineering and Biotechnology - Unit of Agricultural Machinery - Universitat Politècnica de Catalunya - Esteve Terradas, 8 - 08860 - Castelldefels (Barcelona) - SPAIN

Summary

Mandatory inspections in Spain are organized following ISO 16122. In order to guarantee a clear and comprehensive inspection's procedure in all of the official inspection's workshops, the Spanish Ministry of Agriculture published an official inspection's manual based on ISO 16122 in order to improve and harmonize the process.

On the other hand, and considering the more and more cases of new sprayers with difficulties to fulfill the mandatory inspections requirements, an official manual for sprayer's manufacturers have been published in collaboration with the Spanish Association of Agricultural Machinery Manufacturers (ANSEMAT) giving them a practical document to fulfill the requirements established in ISO 16119.

Both documents have been written by the research team of UMA-UPC. In this paper will be presented the objectives, structure and success of the two official manuals.

Introduction

Since the official publication of European Directive for a Sustainable Use of Pesticides (SUD) (EC, 2009a), the inspection of sprayers in use in Europe became mandatory in all EU members. Since that date, the mandatory process was adopted in a different way in all countries, with great differences among them, both in terms of experience, capabilities and resources.

Concerning the technical aspects of the inspection procedure, the requested mandate from the European Commission to the CEN (Committee European of normalization) started a large and intense process in order to produce new harmonized standards to be adopted in all EU members for the inspection of all pesticide application equipment (PAE), in line with the specifications of Annex II of the SUD (EC, 2009).

Before the official publication of SUD, inspection of sprayers in use was already arranged in some countries, either on a voluntary basis or linked to specific national requirements. Technically, the process followed European Standard documents, as EN 13790-1&2. These standards, only available for boom and orchard sprayers (parts 1 and 2 respectively) have been deeply reviewed and finally published as EN ISO 16122 (parts 1,2,3 and 4) (ISO, 2015). This new series of harmonized standards requires technical skills for a complete interpretation and application. That's was the reason why Ministry of Agriculture in Spain started a process to elaborate an official Manual for inspection of sprayers in use, in order to provide to all the official inspector's workshops a practical guide for a fully application of ISO 16122 series. This paper offers a detailed explanation about the

Difficulties to follow International Standards on a daily inspection activity

Official documents establishing the technical procedure for a complete inspection of sprayers in use (EN ISO 16122 series) are not a good example of clear, objective and easy to read documents. These facts lead to a difficulty in the interpretation and application of technical requirements during an inspection process. Especially for those non-frequent standard-readers, by the way the larger number of official inspectors and workshop's directors in Spain. This fact leads into practical problems that can be upgrade into administrative failures, due to absence of objectivity during the inspection process. This feeling is widely disseminated in general among technicians when talking about the official standard documents and its difficulties to be implemented. For all these previous reasons, it was

decided in Spain to develop an official guideline to help the users in the application of the official standards.

Manual for inspection of sprayers: structure and contents

This tool is mainly focused and dedicated to facilitate the comprehension of the whole procedure for the future inspectors and inspection’s workshop responsible. The manual (Figure 4) has been developed by *Universitat Politècnica de Catalunya* and *Centre de Mecanització Agrària* (Generalitat de Catalunya), and includes detailed explanation (with graphical and pictures support) of every single action to be developed during the inspection procedure. The main objective of this manual is to facilitate all stakeholders involved in the inspection process the detailed knowledge and abilities to manage the international standards officially in use for the purpose (EN ISO 16122-1,2 & 3). The structure of the manual has been established as a guideline during the practical process of the inspections. During the whole document, the information and contents have been structured as indicated in Figure 1. The left part of the book includes specific pictures/graphics concerning the subject explained in the right part. Pictures with “good or bad marks” indicate good or bad thinks on different aspects to be considered. The right part of the book contains, for every specific aspect during the inspection process, the official wording according the EU standards, the established procedure (measurement, checking, control...), some practical recommendations for the inspector and the evaluation process depending on the inspection results. The Manual contains all aspects concerning the inspection of sprayers in use, according EN ISO 16122, for field crop sprayers (part 2) and orchard and bush trees sprayers (part 3). First part of the manual is dedicated to a complete explanation of part 1 of the standard.

This manual has been adopted as the official reference document in the Spanish legislation concerning the mandatory inspection program (BOE, 2011), and it has been distributed during the official inspector’s training courses.

The new version of the manual includes all the changes, new incorporations and new evaluation criteria appeared in the new harmonized standard ISO 16122.

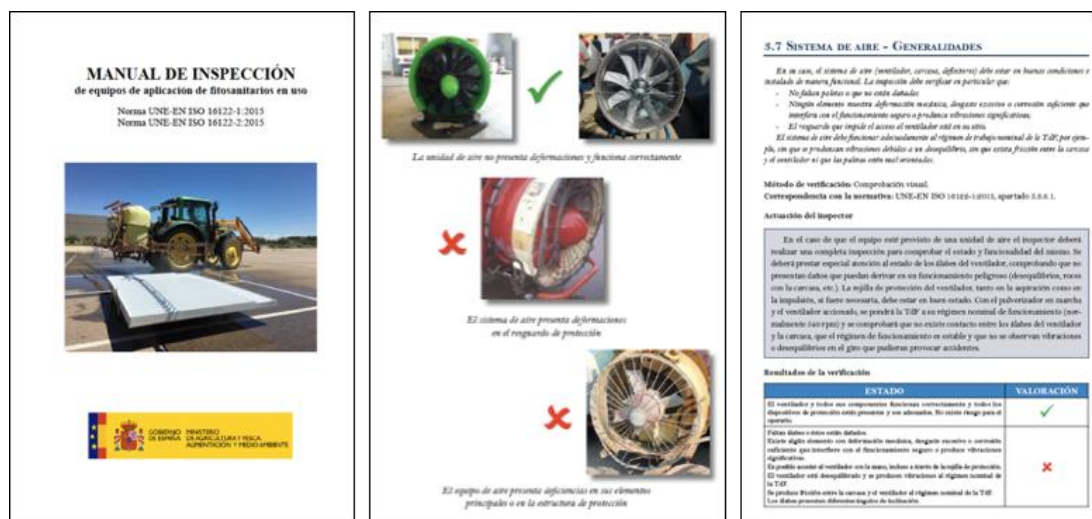

Figure 1. Manual for inspection of sprayers in use. Main page (left) and structure (right). Available at www.uma.deab.upc.edu and www.magrama.es)

Software for inspections and structure of manual

As it was arranged previously, the Spanish authorities allocated the manual of inspections as the official reference book for the process. Linked to that, it was also adopted as official software the one developed by Universidad de Zaragoza (Gil et al. 2014) (<https://eps.unizar.es/priteaf>) (Fig. 2).

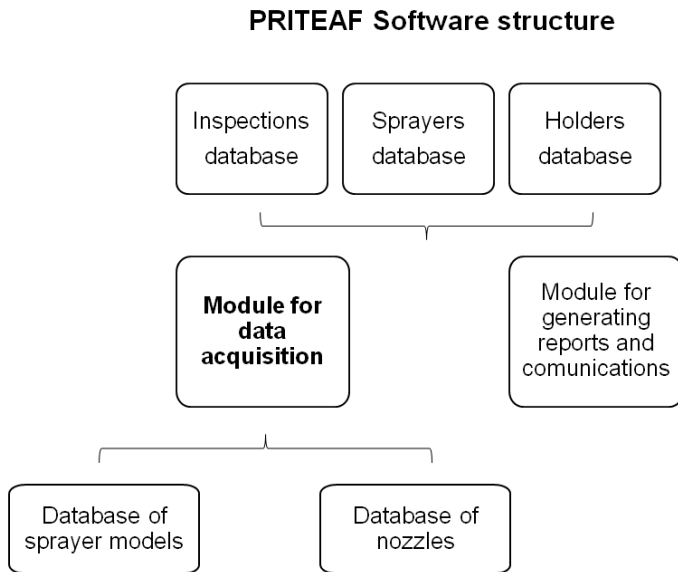

Figure 2. Architectonic structure of PRITEAF software

After the official publication of new harmonized standard ISO 16122, and once the new manual for inspection of sprayers has been updated and officially published as the reference book, also the software has been modified. With the main objective to clarify and simplify the inspection process, the new software has been adapted according the structure of the new manual of inspections.

Importance of guarantee the quality of new sprayers: Manual for manufactures

Technical characteristics of the sprayers have an important effect during the inspection process being. Theoretically, a new sprayer should simplify the inspection process by accomplishing the mandatory requirements. However, more often than expected, some difficulties have been observed with new or close to new sprayers, showing difficulties to accomplish the technical requests established in ISO 16122. More often than expected, also, failures in accomplishment of ISO 161109 have been observed.

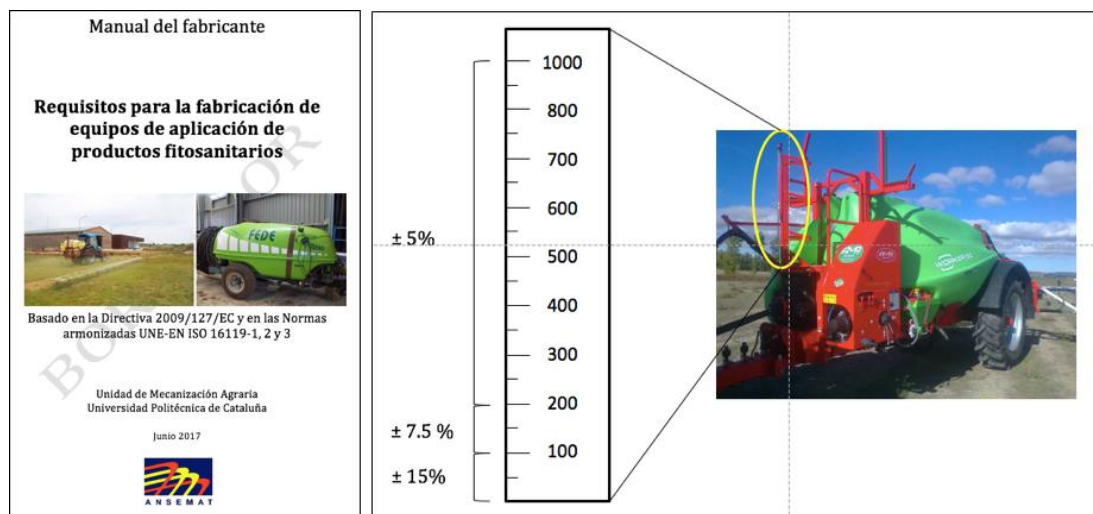

Fig. 3. Practical guideline for the application of ISO 16119 developed by UMA-UPC in collaboration with the Spanish Association of Agricultural Machinery Manufacturers/Dealers (ANSEMAT).

This fact leads to an official arrangement with the Spanish Association of Sprayer’s manufacturers with the main objective to guarantee the complete accomplishment of the official requirement for new sprayers (ISO 16119). This collaboration allowed to demonstrate the difficulties encountered by medium/small manufactures in the total accomplishment of the requirements, in most cases due to the absence of information of need for additional explanation. Also, it has been proved the difficulties of evaluate the sprayers following the ISO 16119-3. The assays were expensive, time-consuming and complex (Gil et al, 2018) A complete application of the standard may require a lot of resources. This can be a serious problem for a large number of European sprayer’s manufacturers bellowing to SME group., with limited resources and facilities. Even more, another not quantified difficulty is related with the lack of knowledge of most of those medium/small sprayer’s manufactures, with important difficulties to understand all the established requirements. It is important to improve the communication and feedback from national representative on International Standardization Bodies and local manufacturers, in order to guarantee a clear and useful information channel. In this sense, as a requirement of the Spanish Association of Agricultural Machinery Manufacturers (ANSEMAT), UMA-UPC has developed a practical guideline (Fig. 3) with clear and practical information including real examples, in order to help the Spanish sprayer’s manufactures in the complex process of the accomplishment of ISO 16119 series. This practical guide includes, in more than 80 pages, a complete description of all the requirements and tests procedured to guarantee a complete accomplishment of ISO 16119. This guideline (Fig. 4) has been written with the main objective to help sprayer’s manufacturers in the accomplishment of the mandatory requirements derived from the European Machine Directive (EC, 2009b).

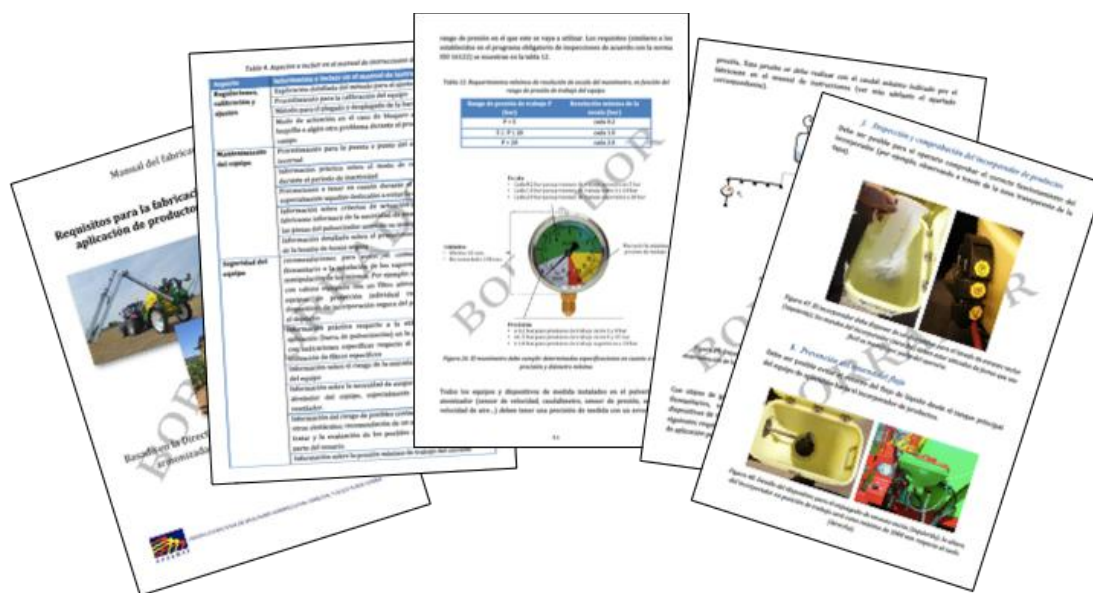

Figure 4. Technical guideline (87 pages) with detailed explanation about test methods, material, procedure and evaluation results following ISO 16119 (1,2&3)

Conclusions

The Spanish experience has widely demonstrated the interest for a good guideline as support for the fully accomplishment of the official international standards. Due to different reasons, unfortunately in some cases, ISO 16122 result unclear and tricky interpretable, resulting on a difference criterion of interpretations. For that reasons, the implementation and official publication of a manual for inspections resulted clearly well appreciated by all the official inspection’s workshops in Spain. For all those technicians not very well experienced with the international standards, the manual of inspections represents a clear and useful tool.

Concerning the difficulties to apply the ISO 16119 specially in the case of small and medium size manufacturers, it has been clearly detected deriving in an unintentional non accomplishment of the technical requirements.

It is important to improve the communication and feedback from national representative on International Standardization Bodies and local manufacturers, in order to guarantee a clear and useful information channel. In this sense, as a requirement of the Spanish Association of Agricultural Machinery Manufacturers (ANSEMAT), UMA-UPC has developed a practical guideline with clear and practical information including real examples, in order to help the Spanish sprayer's manufactures in the complex process of the accomplishment of ISO 16119 series.

References

BOE 2011 Real Decreto 1702/2011, de 18 de noviembre, de inspecciones periódicas de los equipos de aplicación de productos fitosanitarios. BOE Nº 296, 9 diciembre de 2011, secc. I pag. 130569. Available at: www.boe.es

EC/127. Directive 2009/127/EC of the European Parliament and of the Council of 21 October 2009 amending Directive 2006/42/EC with regard to machinery for pesticide application; 2009 [Of. J. EU, 25.11.2009, L 310/29].

EC/128. Directive 2009/128/EC of the European Parliament and of the Council of 21 October 2009 establishing a framework for Community action to achieve the sustainable use of pesticides; 2009 [Of. J. EU, 24.11.2009, L 309/71].

Gil, E., Jiménez, A., García-Ramos, J. 2014. Manual for inspection of sprayers in use and PRITEAF, dedicated software for inspection of sprayers: success tools developed for the inspector's training process in Spain. Fifth European Workshop on Standardised Procedure for the Inspection of Sprayers in Europe - SPISE 5. Die Deutsche Nationalbibliothek verzeichnet diese Publikation In der Deutschen Nationalbibliografie: detaillierte bibliografische Daten sind im Internet über <http://dnb.d-nb.de> abrufbar. ISSN 1868-9892 ISBN 978-3-95547-021-0

Gil, E., Salcedo, R., Campos, J., Llop, J., Ortega, P., Gallart, M. 2018. Orchard sprayer's evaluation according ISO 16119-3. Need to support manufacturer's procedure. In P. Balsari, S. E. Cooper, E. Gil, C. R. Glass, W. Jones, B. Magri, J. Van de Zande (Eds.), Aspects of Applied Biology 137 International Advances in Pesticide Application. Brighton (UK).

International Standardization Organization. 2015. ISO 16122. Agricultural and forestry machinery – Inspection of sprayers in use – Parts 1, 2 & 3. Geneva, Switzerland: ISO.

ISO - International Standardization Organization. 2013. ISO 16119. Agricultural and forest machinery – Environmental requirements for sprayers – Parts 1, 2 & 3. Geneva, Switzerland: ISO.

Excursion - the program of the 27th September 2018

Technical Visit to Epidaurus

For the second day of the 7th SPISE Workshop (Thursday, 27/09/18), a technical visit to Epidaurus has been arranged.

Departure

The day starts with the departure from Athens. At 08:00 in the morning, all participants will gather at Syntagma square, in the city centre, where two buses will be there to take them to Epidaurus.

The meeting point, Syntagma square (Image 1), is the most famous square, and amongst the most historic ones in the centre of Athens. It is right in front of the Greek House of Parliament and has always been a hot spot for Athenians and visiting tourists. The square is named after the Constitution that Otto, the first King of Greece, was obliged to grant after a popular and military uprising on 3 September 1843. It is located in front of the 19th century Old Royal Palace, housing the Greek Parliament since 1934. The name Syntagma (Greek: Σύνταγμα) also refers to the neighbourhood surrounding the square.



Image 1. Syntagma Square

Arrival at Olive farm & Orange farm

After a 2-hour trip (Image 2a), the participants will arrive at Epidaurus, and more specifically at a village near Epidaurus, named Dimaina (Greek: Δήμαινα) (Image 2b). In this small and traditional village the olive and orange farms are located.

There, after a coffee break, attendants will be divided in three groups and three demonstrations will take place, as described below:

Group 1 (40 min): Brief introduction about the farm with special focus on pesticide application.

Group 2 (40 min): Orange tree mist blower sprayers' inspection (one old and one new).

Group 3 (40 min): Olive tree mist blower (new one) and lance (demonstration and adjustment, with pole and sensitive paper).

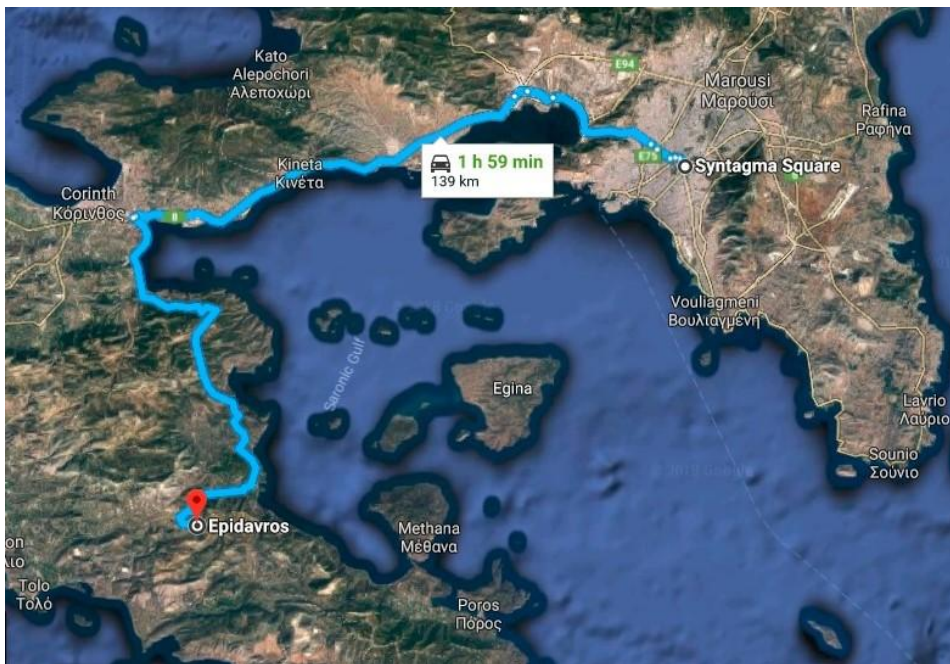

(a)

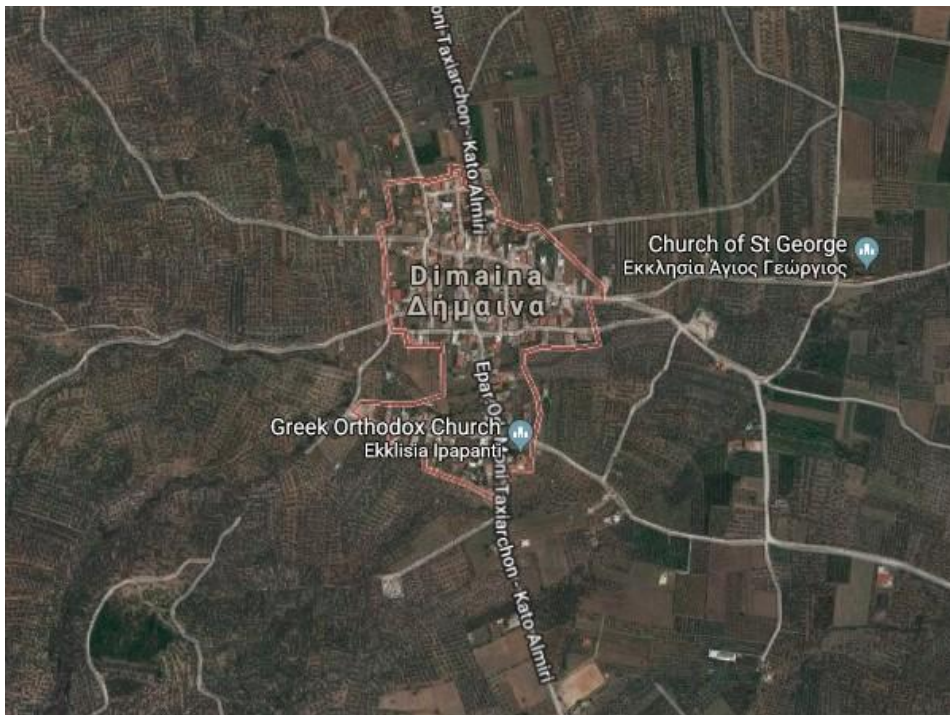

(b)

Image 2 (a) Root to from Athens to Epidaurus, (b) Village of Dimaina

Visit at the Olive Mill

After departing from the farm at 12:30, a visit at “Melas” Olive Mill (Image 3) is programmed. There, attendants will have a light lunch and, then, will be divided in two groups to participate in inspection demonstrations in two field stations in the olive grove of the mill.

Station 1 (30 min): CDA inspection demonstrations (Jaco Kole)

Station 2 (30 min): Micro granulator & slug pellet applicator inspection demonstration (P. Balsari, H. Wehmann, M. Manzone, R. Crook)

Discussion will follow about “Minor PAE inspection Workshop quality assurance”, chaired by J. Kole and H. Kramer.



(a)



(b)



(c)

Image 3. “Melas” Olive Mill

Visit to Epidaurus archaeological site

Right after the demonstrations and discussions in the fields and at the olive mill, participants will have the opportunity to admire the ancient sites of Ancient Epidaurus (Greek: Αρχαία Επίδαυρος) (Image 4).

Reputed to be founded by or named for the Argolid Epidaurus, and to be the birthplace of Apollo's son Asclepius the healer, Epidaurus was known for its sanctuary situated about five miles (8 km) from the town, as well as its theatre, which is once again in use today. The cult of Asclepius at Epidaurus is attested in the 6th century BC, when the older hill-top sanctuary of Apollo Maleatas was no longer spacious enough. The asclepeion at Epidaurus (Image 5) was the most celebrated healing centre of the Classical world, the place where ill people went in the hope of being cured. To find out the right cure for their ailments, they spent a night in the enkoimeteria, a big sleeping hall. In their dreams, the god himself would advise them what they had to do to regain their health. Within the sanctuary there was a guest house with 160 guestrooms. There are also mineral springs in the vicinity, which may have been used in healing.



Image 4. Archaeological site of Epidaurus

The prosperity brought by the asclepeion enabled Epidaurus to construct civic monuments, including the huge theatre (Image 6) that delighted Pausanias for its symmetry and beauty, used again today for dramatic performances, the ceremonial hestiatoreion (banqueting hall), a stadium (Image 7) and a palaestra. The ancient theatre of Epidaurus was designed by Polykleitos the Younger in the 4th century BC. The original 34 rows were extended in Roman times by another 21 rows. As is usual for Greek theatres (and as opposed to Roman ones), the view on a lush landscape behind the stage is an integral part of the theatre itself and is not to be obscured. It seats up to 14,000 people.

The theatre is admired for its exceptional acoustics, which permit almost perfect intelligibility of unamplified spoken words from the proscenium or skênê (stage) to all 14,000 spectators, regardless of their seating. Famously, tour guides have their groups scattered in the stands and show them how they can easily hear the sound of a match struck at centre-stage. A 2007 study by Nico F. Declercq and Cindy Dekeyser of the Georgia Institute of Technology indicates that the astonishing acoustic properties may be the result of the advanced design: the rows of limestone seats filter out low-frequency sounds, such as the murmur of the crowd, and also amplify the high-frequency sounds of the stage.



Image 5. Ancient Asclepeion of Epidaurus



Image 6. Ancient theatre of Epidaurus



Image 7. Ancient stadium of Epidaurus

Workshop dinner at Akrogiali Restaurant in Ancient Epidaurus

Akrogiali restaurant is a beautiful traditional restaurant at the seashore of Ancient Epidaurus, where the workshop dinner will take place at the end of the day. There, participants will have the opportunity to taste the traditional Greek cuisine.



(a)



(b)

Return to the hotel at 22:00.

General

Scientific Committee

Thanos Balafoutis
Tom Bals
Nils Bjugstad
Jean-Paul Douzals
Spyros Fountas
Emilio Gil
Petr Harasta
Bruno Huyghebaert
Harald Kramer
Paolo Marucco
Eskil Nilsson
Vincent Polvêche
Ari Ronkainen
Aleksandar Sedlar
Francesc Solanelles
Jens Karl Wegener

Organizing Committee

Thanos Balafoutis
Paolo Balsari
Guillaume Defays
Jean-Paul Douzals
Spyros Fountas
Bruno Huyghebaert
Jaco Kole
Jens Karl Wegener
Hans-Joachim Wehmann

Sponsors

GOLDEN SPONSORS



SILVER SPONSORS



BRONZE SPONSORS



COMMUNICATION SPONSORS



This is a Sponsored EurAgEng Event



„Berichte aus der Biologischen Bundesanstalt für Land- und Forstwirtschaft“ erscheinen seit 1995 in zwangloser Folge

Seit 2008 werden sie unter neuem Namen weitergeführt:
„Berichte aus dem Julius Kühn-Institut“

- Heft 171, 2013: Sechstes Nachwuchswissenschaftlerforum 2013, 27. - 29. November in Quedlinburg - Abstracts -, 52 S.
- Heft 172, 2013: Netz Vergleichsbetriebe Pflanzenschutz, Jahresbericht 2012, Analyse der Ergebnisse der Jahre 2007 bis 2012. Bearbeitet von Bernd Freier, Jörg Sellmann, Jörn Strassemeyer, Jürgen Schwarz, Bettina Klocke, Hella Kehlenbeck, Wolfgang Zornbach, 111 S.
- Heft 173, 2014: Statusbericht Biologischer Pflanzenschutz 2013. Johannes A. Jehle, Annette Herz, Brigitte Keller, Regina G. Kleespies, Eckhard Koch, Andreas Larem, Annegret Schmitt, Dietrich Stephan, 117 S.
- Heft 174, 2014: 47th ANNUAL MEETING of the SOCIETY FOR INVERTEBRATE PATHOLOGY and INTERNATIONAL CONGRESS ON INVERTEBRATE PATHOLOGY AND MICROBIAL CONTROL, 176 S.
- Heft 175, 2014: NEPTUN-Gemüsebau 2013. Dietmar Roßberg, Martin Hommes, 44 S.
- Heft 176, 2014: Rodentizidresistenz. Dr. Alexandra Esther, Karl-Heinz Berendes, Dr. Jona F. Freise, 52 S.
- Heft 177, 2014: Siebentes Nachwuchswissenschaftlerforum 2014, 26. - 28. November in Quedlinburg - Abstracts -, 57 S.
- Heft 178, 2015: Netz Vergleichsbetriebe Pflanzenschutz, Jahresbericht 2013, Analyse der Ergebnisse der Jahre 2007 bis 2013. Bearbeitet von Bernd Freier, Jörg Sellmann, Jörn Strassemeyer, Jürgen Schwarz, Bettina Klocke, Hella Kehlenbeck, Wolfgang Zornbach, 103 S.
- Heft 179, 2015: Fachgespräch: „Kupfer als Pflanzenschutzmittel“ Berlin-Dahlem, 21. November 2014. Stefan Kühne, Britta Friedrich, Peter Röhrig, 56 S.
- Heft 180, 2015: Fachgespräch: „Gesunderhaltung von Pflanzen im Ökolandbau im Spannungsfeld von Grundwerteorientierung, Innovation und regulatorischen Hemmnissen“ Berlin-Dahlem, 20. November 2014. Stefan Kühne, Britta Friedrich, Peter Röhrig, 40 S.
- Heft 181, 2015: Achtes Nachwuchswissenschaftlerforum 2015, 19. - 21. Oktober in Quedlinburg - Abstracts -, 42 S.
- Heft 182, 2015: Netz Vergleichsbetriebe Pflanzenschutz, Jahresbericht 2014, Analyse der Ergebnisse der Jahre 2007 bis 2014. Bearbeitet von Bernd Freier, Jörg Sellmann, Jörn Strassemeyer, Jürgen Schwarz, Bettina Klocke, Silke Dachbrodt-Saaydeh, Hella Kehlenbeck, Wolfgang Zornbach, 42 S.
- Heft 183, 2016: Pflanzen für die Bioökonomie – Welche Herausforderungen ergeben sich für die Qualität nachwachsender Rohstoffe? 50. Vortragstagung - Abstracts -, 94 S.
- Heft 184, 2016: 23rd International Symposium of the International Scientific Centre of Fertilizers Plant nutrition and fertilizer issues for the cold climates. Bearbeitet von/ Compiled by Silvia Haneklaus, Peder Lombnæs, Ewald Schnug. Son (Norway), September 8-10, 2015, 30 S.
- Heft 185, 2016: 24th International Symposium of the International Scientific Centre of Fertilizers Plant nutrition and fertilizer issues for specialty crops. Bearbeitet von/ Compiled by Silvia Haneklaus, Eduardo Rosa, Ewald Schnug. Coimbra (Portugal), September 6-8, 2016, 65 S.
- Heft 186, 2016: 9th Young Scientists Meeting 2016, 9th - 11th November in Quedlinburg – Abstracts –, 2016, 59 S.
- Heft 187, 2017: Handlungsempfehlung zur Anwendung von Glyphosat im Ackerbau und der Grünlandbewirtschaftung der Bund-Länder-Expertengruppe. 11 S.
- Heft 188, 2017: 2. Symposium Zierpflanzenzüchtung 13./14. März 2017 in Quedlinburg – Abstracts –, 2017, 48 S.
- Heft 189, 2017: Bericht über Erkenntnisse wissenschaftlicher Untersuchungen über mögliche direkte und indirekte Einflüsse des Pflanzenschutzes auf die Biodiversität in der Agrarlandschaft. Bearbeitet von/ Compiled by Bernd Freier, Sandra Krengel, Christine Kula, Stefan Kühne, Hella Kehlenbeck, 2017, 72 S.
- Heft 190, 2017: Schlussbericht zum Vorhaben Thema des Verbundprojektes: Untersuchung zur Epidemiologie bodenbürtiger Viren in Triticale mit dem Ziel der Entwicklung von virusresistenten Sorten mit hohen Biomasserträgen für die Biogas- und Ethanolgewinnung. Ute Kastirr, Angelika Ziegler, 2017, 50 S.
- Heft 191, 2017: 25th International Symposium of the Scientific Centre for Fertilizers “Significance of Sulfur in High-Input Cropping Systems” Groningen (Netherlands), September 5-8, 2017. Bearbeitet von/ Compiled by: Luit J. De Kok, Silvia Haneklaus, Ewald Schnug, 2017, 58 S.
- Heft 192, 2017: 9th Young Scientists Meeting 2017, 6th – 7th November in Siebeldingen - Abstracts -, 2017, 80 S.
- Heft 193, 2018: Sekundäre Pflanzenstoffe – Rohstoffe, Verarbeitung und biologische Wirksamkeiten, 52. Vortragstagung, 2018, 65 S.
- Heft 194, 2018: Netz Vergleichsbetriebe Pflanzenschutz, Zwei-Jahresbericht 2015 und 2016, Analyse der Ergebnisse der Jahre 2007 bis 2016. Bearbeitet von/ Compiled by: Silke Dachbrodt-Saaydeh, Jörg Sellmann, Jörn Strassemeyer, Jürgen Schwarz, Bettina Klocke, Sandra Krengel, Hella Kehlenbeck, 2018.
- Heft 195, 2018: Abschätzung der Habitatwirkung veränderter Produktionsverfahren auf Indikatorvogelarten der Ackerbaugebiete im Forschungsvorhaben „Maisanbau für hohen Ertrag und biologische Vielfalt“ am Beispiel der Feldlerche (*Alauda arvensis*). Jörg Hoffmann, Udo Wittchen, 2018, 48 S.

