



EFFECT OF DOUBLE FUZZY LOGIC CONTROLLER (DFLC) BASED ON POWER SYSTEM STABILIZER (PSS) ON A TIE- LINE TWO GENERATORS SYSTEM

Hayfaa Mohammed Hussein, Marizan Sulaiman, Rosli Omar and Mohd Shahrieel Mohd Aras
 Faculty of Electrical Engineering, Universiti Teknikal Malaysia Melaka, Hang Tuah Jaya, Durian Tunggal, Melaka, Malaysia
 E-Mail: hayfaa1970@yahoo.com

ABSTRACT

This research was proposed a new type of power system stabilizer based on fuzzy set theory, to improve the dynamic performance of a multi-machine power system. To have good damping characteristics over a wide range of operating conditions, speed deviation and its derivative of a machine are chosen as the input signals to the fuzzy stabilizer on that particular machine. Fuzzy logic controller (FLC) Two area symmetrical systems connected via tie-line are measured to show via performance of these controllers. This research presents the analysis of change of speed ($\Delta\omega$), change of angle position ($\Delta\delta$) and tie - line power flow (Δp). In tie-line system two generators control arrangement single fuzzy logic controller (SFLC) have been used as a primary controller, whereas double fuzzy logic controller (DFLC) used as a secondary controller. In addition to this, the system shows comparative between two controller single and double fuzzy controller has been used for the system to achieve the best results using Simulink/MATLAB. Double fuzzy controller has a greater effect on the tie-line system and become more smoothing than single fuzzy controller because has increased the damping of the speed $\Delta\omega$, angle rotor $\Delta\delta$ and power Δp .

Keywords: self-tuning controller, fuzzy logic controller, tie-line oscillations, multi-machine stability, two area power system.

1. INTRODUCTION

The modern power systems are highly integrated, large scale interconnections and highly nonlinear system that operate in an uncertain environment where loads, generator output and key operating parameters changes continuously [1]. Power systems operating conditions are essentially nonlinear and load level functions in a complex manner. Actually the system goes over a broad range of conditions, causing low frequency oscillations (LFOs). The LFOs of small magnitudes due to insufficient damping caused by undesirable operating conditions sustain longer and shrink power transfer capability [2]. Power systems are gradually rising with ever larger capability. Formerly known separated systems are interrelated to each other, while modern power systems have developed into systems of very large size. With rising generation capability, different areas in a power system are often added with even large inertia. Power systems are known as heavy nonlinear and often have low frequency oscillations, primarily in weakly tie- line [3]. Fuzzy logic controllers (FLCs) are gradually applied to many systems with nonlinearity and improbability and it is based on experience of a human operator. While controlling a plant a skilled human operator uses the output of the controller based on error and change in error with an aim to reduce the error with a shortest possible time. There is a need to put little efforts on the tuning of input scaling factors for FLCs as they affect directly on performance measure and controller part. The input scaling factors affect the performance measure and the controller part while the output scaling factor affects only the output of the controller. The modulating signals may be derived from tie-line power flow, relative angular deviations of the machines, relative speed deviations of the

machines and average difference in accelerations of the machines [4],[5].

A fuzzy logic controller (FLCs) have concerned significant consideration as contenders for novel computational systems because of the variety of the advantages they offer over the conventional computational systems. Different other classical control methods, FLCs are model-free controllers, i.e. they do not require an exact mathematical model of the controlled system. Furthermore, quickness and forcefulness are the most profound and interesting properties in comparison to the other classical arrangements. FLCs have been successfully applied to the control of non-linear dynamical systems mainly in the field of adaptive control by making use of on-line training. A fuzzy logic controller (FLC) uses fuzzy logic as a design methodology, which can be applied in developing linear and non-linear systems for surrounded control. The most common fuzzy logic controllers are based on constant parameter fuzzy logic (CPFL). The CPFL controller has already been successfully implemented in high performance vector controlled drive [6], [7]. Low frequency oscillations have been detected with the progress of power network, through weak tie lines, in the form of long interrelated network. These oscillations convert important as the network remains to amplify and the damping of these oscillations becomes more important and critical to retain stable and reliable operation. These oscillations may occur between two synchronous generators (inter machine oscillations) or between the generators in distant areas oscillations [8].

Recently, fuzzy logic control (FLC) is considered as a powerful tool in power system control theory. It appears to be the most suitable one whenever a well-defined control objective cannot be specified, the system to be controlled is a complex one, or its exact



mathematical model is not available. Fuzzy logic controllers have been proposed to reduce power system oscillations. However, fuzzy controller parameters are usually obtained by human experts or by trial and error method [9]. Power system stability may be generally defined as that property of a power system that allows it to remain in a state of operating equilibrium under normal operating conditions and to recover satisfactory state of equilibrium after being subjected to a disturbance. Since power systems depend on synchronous machines for generation of electrical power, a necessary condition for satisfactory system operation is that all synchronous machines remain in synchronism. This aspect of stability is influenced by the dynamics of generator rotor angles and power-angle relationships. Electric power systems are highly complicated systems that contain nonlinear and time changing elements. Their dynamics cover a wide spectrum of phenomena, which are electrical, electromechanical, electro-magnetic, and thermal in nature. As power systems become more interrelated and complex, analysis of dynamic performance of such systems become more important. Synchronous generators play a very important role in the stability of power systems. The requirement for electric power stability is increasing along with the popularity of electric products. So, an AVR is needed to enhance a stable voltage while using precisely designed electric equipment or in areas where power supply is not constantly stable. The use of power system stabilizers has become very common in operation of large electric power systems. The conventional PSS which uses lead-lag compensation, where gain settings designed for specific operating conditions, is giving poor performance under different loading conditions. Particle Swarm Optimization (PSO) is one of most excellent optimization technique to obtain optimum parameter for a system. The basic PSO is developed based on behaviors of fish schooling and bird flocking in order to search and move to the food with a certain speed and position [10], [11], [12].

2. SYSTEM MODEL

2.1 Tie-line control

After two services interrelate their systems, they do so for several details. One is to be able to buy and sell power with neighbouring systems whose operating costs make such transactions gainful. More, even if no power is being transmitted over ties to neighbouring systems, if one system has a sudden loss of a generating unit, the units throughout the interconnection will experience a frequency change and can help in restoring frequency. Interconnections present a very motivating control problem with admiration to allocation of generation to see load. The hypothetical situation in Figure-1 will be used to show this problem. Assume both systems in Figure-1 have equal generation and load characteristics.

Such a control system must use two pieces of information; the system frequency and the net power

flowing in or out over the tie lines. Such a control scheme would, of requirement, have to know the following [11].

- a) If frequency decreased and net interchange power leaving the system increased, a load increased has occurred outside the system.
- b) If frequency decreased and net interchange power leaving the system decreased, a load increased has occurred inside the system.

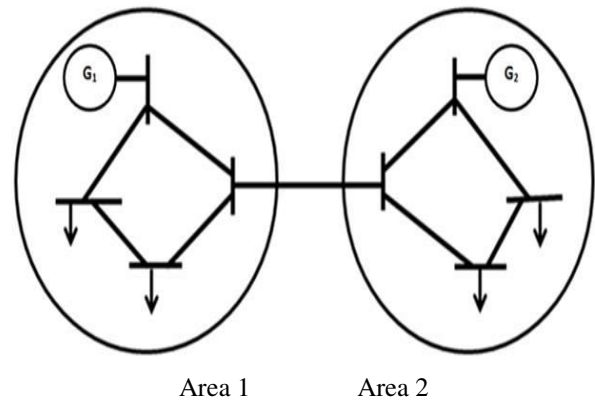

Figure-1. Two - Area system connected via tie-line.

Electrically the machines are modelled as a voltage behind a sub transient reactance. These machines have usually wound rotors and are signified with two damper windings on the *q*- axis and one on the *d*- axis. The *d*- and *q*- axes are attached to the major and minor reluctance axes of the rotor respectively. Figure-2 is a schematic diagram of a machine model with fuzzy logic based PSS [12].

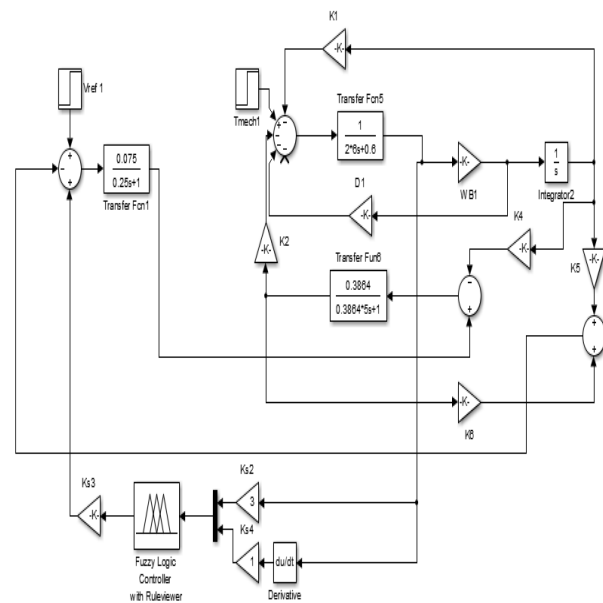

Figure-2. Schematic diagram of a machine model with FLC.



The differential equations used to model the sub transient machine. The model assumes that [2]:

- a) The synchronous machines have sinusoidal air-gap mmfs and linear magnetic circuits.
- b) The system is balanced.
- c) Zero sub transient saliency ie. $X_d'' = X_q'' = X''$.
- d) Effects of the $p\Psi_d$ and $p\Psi_q$ terms are neglected.

2.2 Tie-line model

The flowing mathematical modeling are taken from references [13].

$$P_{tie\ flow} = \frac{1}{X_{tie}}(\theta_1 - \theta_2) \tag{1}$$

where

- X_{tie} is represented reactance tie- line two generators
- θ_1 is represented phase angle for generator 1
- θ_2 is represented phase angle for generator 2

This tie flow is a steady-state quantity. For purpose of analysis here, we perturb Equation (1) to obtain deviations from nominal flow as a function of deviations in phase angle from nominal.

$$P_{tie\ flow} + \Delta P_{tie\ flow} = \frac{1}{X_{tie}} [(\theta_1 + \Delta\theta_1) - (\theta_2 + \Delta\theta_2)]$$

$$= \frac{1}{X_{tie}}(\theta_1 - \theta_2) + \frac{1}{X_{tie}}(\Delta\theta_1 - \Delta\theta_2) \tag{2}$$

Then

$$\Delta P_{tie\ flow} = \frac{1}{X_{tie}}(\Delta\theta_1 - \Delta\theta_2) \tag{3}$$

where $\Delta\theta_1$, and $\Delta\theta_2$ are equivalent to $\Delta\delta_1$, and $\Delta\delta_2$, as defined in Eq. 4. Then, using the relationship of Eq. 4.

$$\Delta\omega = \alpha t = \frac{d}{dt}(\Delta\delta) \tag{4}$$

$$\Delta p_{tie\ flow} = \frac{T}{S}(\Delta\omega_1 - \Delta\omega_2) \tag{5}$$

where $T = 377 \times \frac{1}{X_{tie}}$ for a 60 – Hz system.

Notethat $\Delta\theta$ must be in radians for Δp_{tie} to be in per unit megawatts, but $\Delta\omega$ is in per unit speed changes. therefore, we must multiply $\Delta\omega$ by 377 rad/sec (the base frequency in rad/ sec at 60 Hz). T may be thought of as the “tie-line stiffness” coefficient [13].

3. DESIGN OF FUZZY LOGIC CONTROLLER

The fuzzy control systems are rule based systems in which a set of fuzzy rules represent a control decision mechanism to adjust the effects of certain system stimulation. With the help of effective rule base, fuzzy control systems can replace a skilled human operator. The fuzzy logic controller provides an algorithm which can

convert the linguistic control strategy based on expert knowledge into an automatic control strategy. The Figure-3 illustrates the schematic design of a fuzzy logic controller which consists of a fuzzification interface, a knowledge base, control system (process), decision making logic and a defuzzification interface [14].

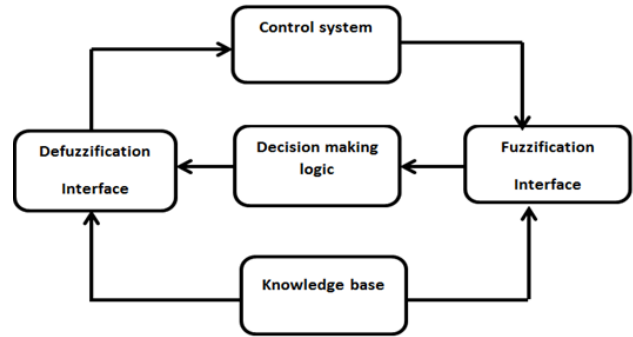

Figure-3. Principle design of fuzzy logic controller.

The fuzzy logic controller block contains of fuzzy logic block and scaling factors. Scaling factors inputs are two and one for each input and one scaling factor for output which determine the extent to which controlling effect is produced by the fuzzy logic controller shown in Figure-3. Performance of fuzzy logic controller is studied for the scaling factors having the values of $K_{in1} = 1$, $K_{in2} = 3$ and $K_{out} = 2$, as obtained from (1) the piecewise linear method (2) the linear approximate technique [15]. The parameters for fuzzy logic controller (FLC) will be tuned by PSO. Figure-4 shows the proposed technique that is an output feedback observer tuning by using fuzzy logic controller (FLC) for single machine infinite bus (SMIB) [12].

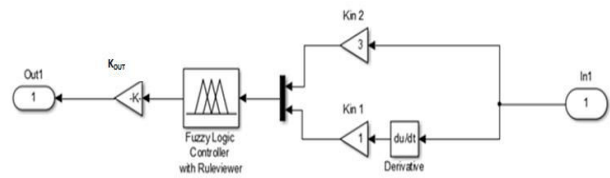

Figure-4. Fuzzy logic controller based PSS.

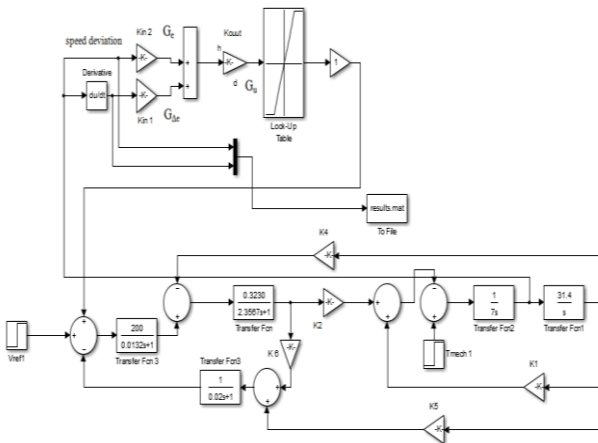

Figure-5. Output feedback observer tuning using single input fuzzy logic controller.

3.1 Fuzzy inference system

Fuzzy logic block is prepared using fuzzy inference system file in Matlab (R2013) (8.1.0.604) and the basic structure of this FIS editor file as shown in Figure-6. This is implemented using following FIS (Fuzzy Inference System) properties as shown in Figure-6 - 7 [14]. Table-1 presents 16 rules base for fuzzy logic controller. Figure-8 shows rule viewer of fuzzy logic controller.

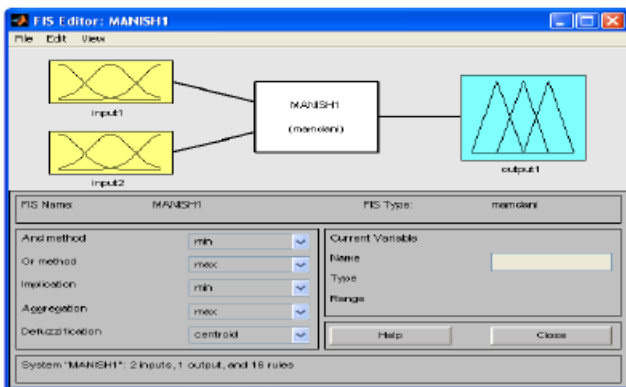

Figure-6. Fuzzy inference system.

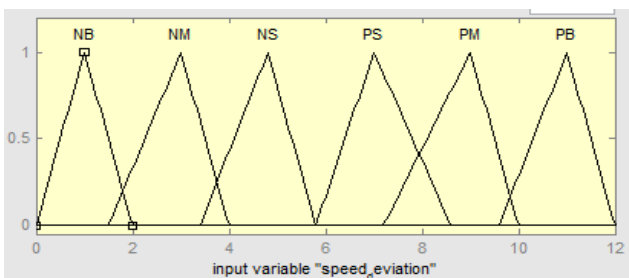

Figure-7(a). Membership functions for speed deviations.

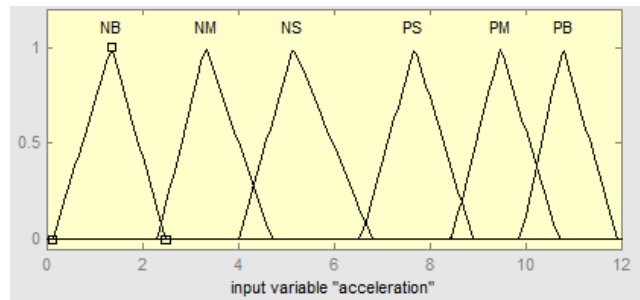

Figure-7(b). Membership functions for acceleration deviations.

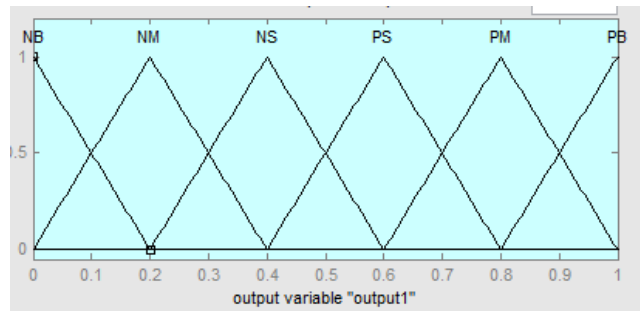

Figure-7(c). Membership functions for voltage.

Table-1. 16-Rule base for fuzzy logic controller.

Speed deviation	Acceleration					
	NB	NM	NS	PS	PM	PB
NB	NB	0	0	0	0	0
NM	0	0	0	0	0	0
NS	0	0	0	0	0	0
PS	NM	NS	0	PM	PB	PB
PM	NS	0	PS	PB	PB	PB
PB	0	PS	PM	PB	PB	PB

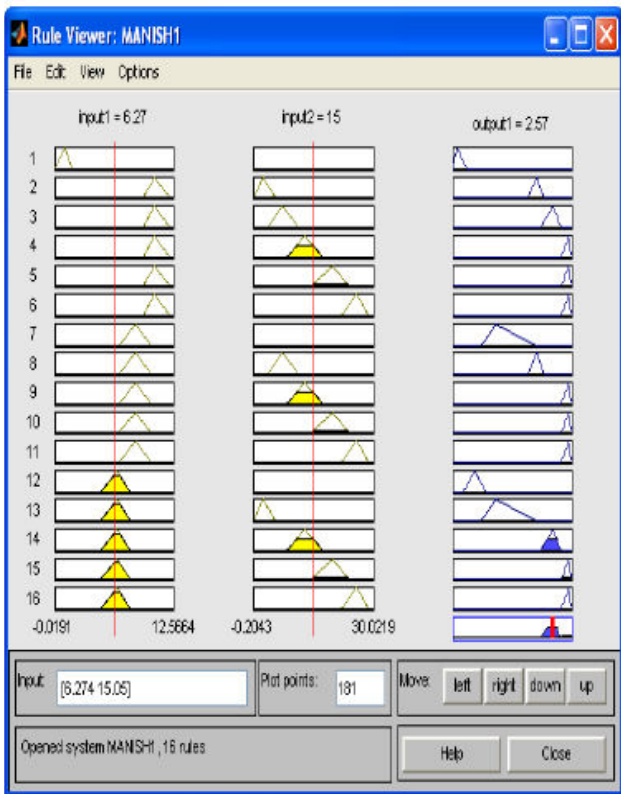

Figure-8. Rule viewer of fuzzy logic controller.

4. RESULTS AND DISCUSSIONS

The studies were implemented using MATLAB/SIMULINK based on the system shown Figure-9 performance of a-two generator system has been studied using 16 rules firstly single fuzzy logic controller and secondly double fuzzy logic controller (FLC). Machine data is taken from references [17] in Table-2 and Table-3 Part 1(a and b), Part 2 (c and d) present the change of input torque.

Table-2. Machine data.

parameters	Numerical value
K1	0.9831
K2	1.0923
K3	0.3864
K4	1.4746
K5	- 0.1103
K6	0.4477
K_E	0.075
T_E	0.25
K_D	0

Part 1

Table-3(a). Change of input torque.

case	G ₁			1-FLC			
	H	D	T	T _{L1}	K _{in1} (FLC)	K _{in2} (FLC)	K _{out3} (FLC)
1	6	0.6	5	0.1	1	3	2
2	6	0.6	5	0	1	3	2

Part 1

Table-3(b). Change of input torque.

case	G ₂			2-FLC			
	H	D	T	T _{L2}	K _{in1} (FLC)	K _{in2} (FLC)	K _{out3} (FLC)
1	8	0.9	7	0.2	1	3	2
2	8	0.9	7	0.2	1	3	2

Part 2

Table-3(c). Change of input torque.

case	G ₁			1-FLC			
	H	D	T	T _{L1}	K _{in1} (FLC)	K _{in2} (FLC)	K _{out3} (FLC)
1	6	0.9	5	0.1	1	3	2
2	6	0.9	5	0	1	3	2
3	6	0.9	5	0.2	1	3	2

Part 2

Table-3(d). Change of input torque.

case	G ₂			2-FLC			
	H	D	T	T _{L2}	K _{in1} (FLC)	K _{in2} (FLC)	K _{out3} (FLC)
1	8	0.6	3	0.2	1	3	2
2	8	0.6	3	0.2	1	3	2
3	8	0.6	3	0	1	3	2

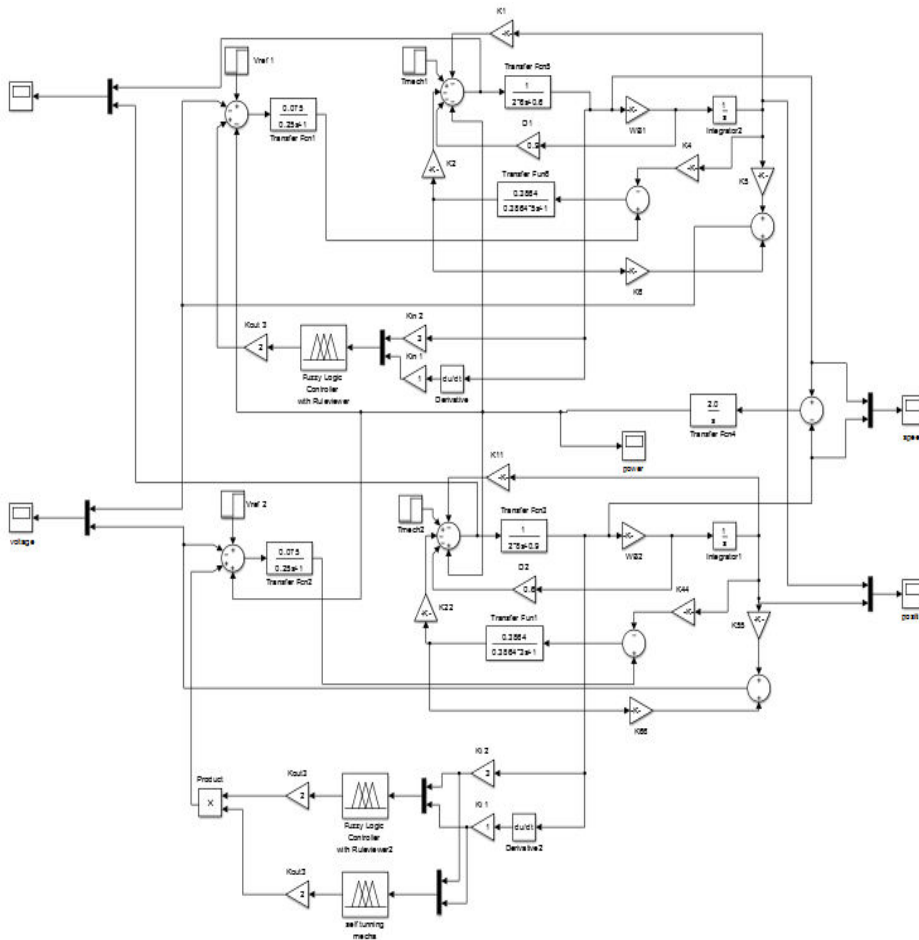

Figure-9. Simulation model of a 2- generator single and double - fuzzy logic controller (DFLC).

Part 1

Case 1: $K5 = - 0.1103$, $T_{L1} = 0.1$ pu and $T_{L2} = 0.2$ pu.

The variations of angular speed, angular position (angle rotor) and tie – line power flow (P_{1-2}) are displayed in Figure-10(a),(b) and (c)for the system with for 10% change of input torque for generator 1 and 20% for generator 2. Time is 120 sec using 16 rules in fuzzy logic controller.

Figure-10(a), (b) and (c) show angular speed variations, angular position (angle rotor) variations and power flow (P_{1-2}) variations of a 2-generators connected via tie-line respectively. The results show the smoothing effects of the double - FLC on generator 2.

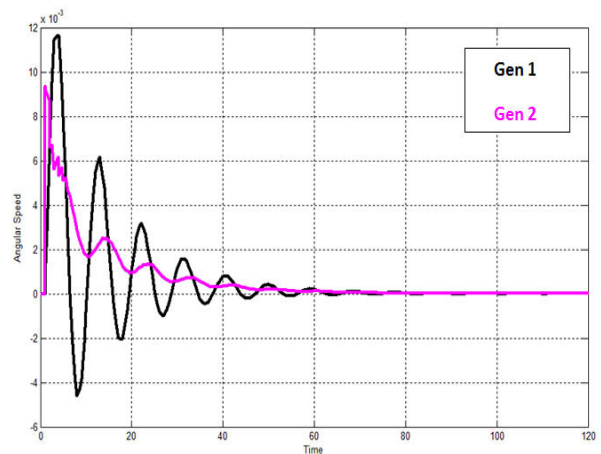

Figure-10(a). Angular speed variations.

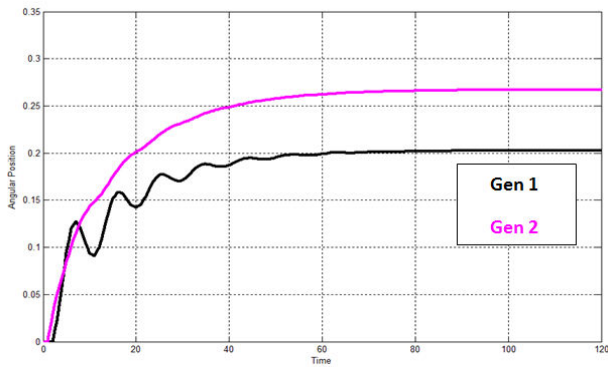

Figure-10(b). Angular position (angle rotor) variations.

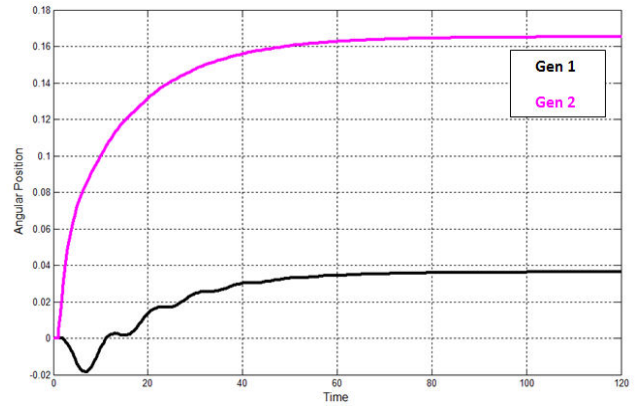

Figure-11(b). Angular position (angle rotor) variations.

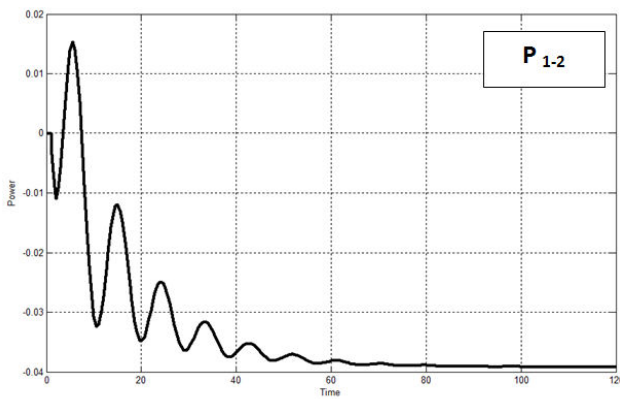

Figure-10(c). Tie - line power flow variations.

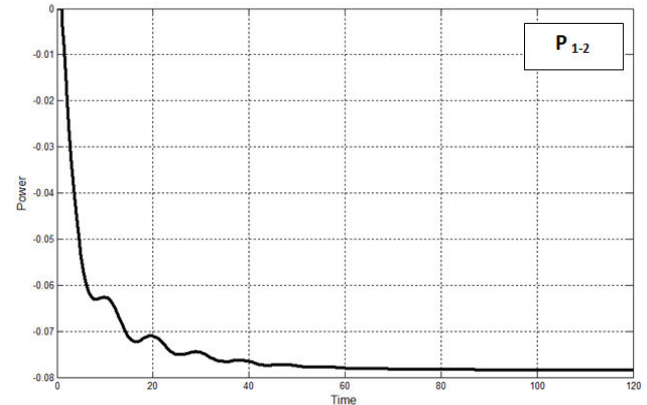

Figure-11(c). Tie - line power flow variations.

Case 2: $K_5 = -0.1103$; $T_{L1} = 0$ pu and $T_{L2} = 0.2$ pu.

The variations of angular speed, angular position (angle rotor) and tie - line power flow (P_{1-2}) are displayed in figure 11(a), (b) and (c) for the system with 0% change of input torque for generator 1 and 20% for generator 2. Time is 120 sec using 16 rules in fuzzy logic controller.

Figure-11 (a), (b) and (c) show angular speed variations, angular position (angle rotor) variations and power flow (P_{1-2}) variations of a 2-generators connected via tie-line respectively. The results show the smoothing effects of the double - FLC on generator 2.

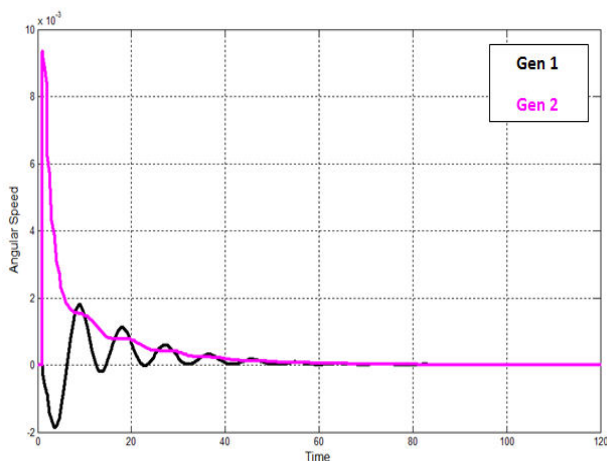

Figure-11(a). Angular speed variations.

Part 2

Case 1: $K_5 = -0.1103$; $T_{L1} = 0.1$ pu and $T_{L2} = 0.2$ pu.

The variations of angular speed, angular position (angle rotor) and tie - line power flow (P_{1-2}) are displayed in figure 12(a), (b) and (c) for the system with 10 % change of input torque for generator 1 and 20 % for generator 2. Time is 120 sec using 16 rules in fuzzy logic controller.

Figure-12 (a), (b) and (c) show angular speed variations, angular position (angle rotor) variations and power flow (P_{1-2}) variations of a 2-generators connected via tie-line respectively. We can see that, the results show the smoothing effects of the double - FLC on generator 2.

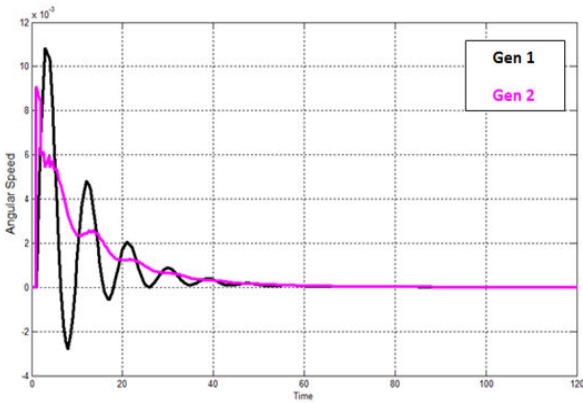

Figure-12(a). Angular speed variations.

show the smoothing effects of the double - FLC on generator 2.

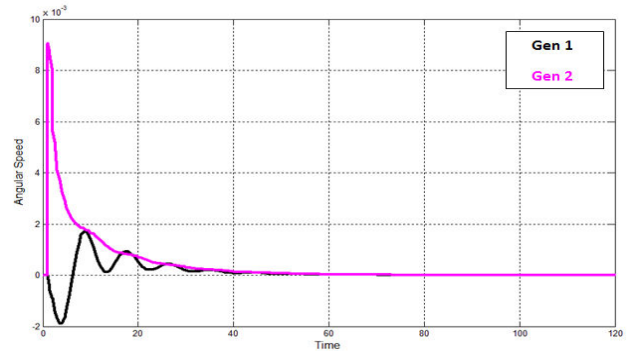

Figure-13(a). Angular speed variations.

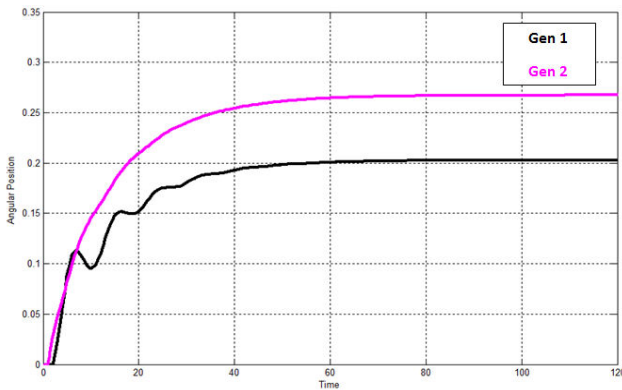

Figure-12(b). Angular position (angle rotor) variations.

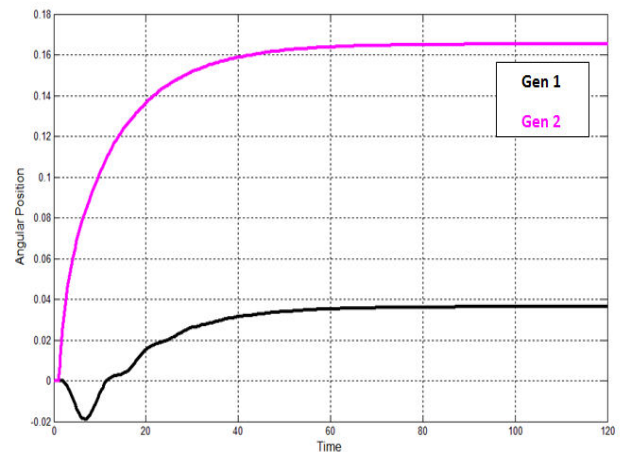

Figure-13(b). Angular position (angle rotor) variations.

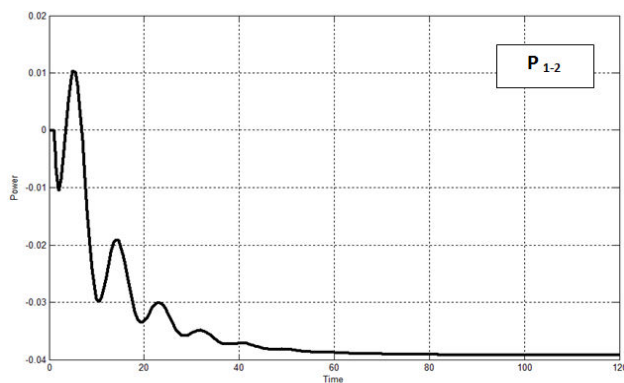

Figure-12(c). Tie - line power flow variations.

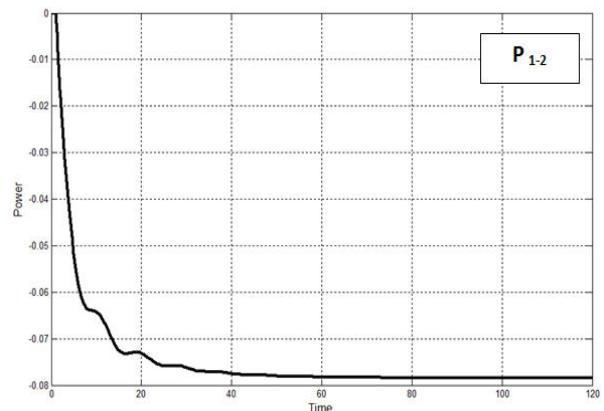

Figure-13(c). Tie - line power flow variations.

Case 2: $K_5 = -0.1103$; $T_{L1} = 0$ pu and $T_{L2} = 0.2$ pu.

The variations of angular speed, angular position (angle rotor) and tie - line power flow (P_{1-2}) are displayed in Figure 13(a),(b) and (c) for the system with 0 % change of input torque for generator 1 and 20% for generator 2. Time is 120 sec using 16 rules in fuzzy logic controller.

Figure-13 (a), (b) and (c) show angular speed variations, angular position (angle rotor) variations and power flow (P_{1-2}) variations of a 2-generators connected via tie-line respectively. Therefore, we can see the results

Case 3: $K_5 = -0.1103$; $T_{L1} = 0.2$ pu and $T_{L2} = 0$ pu.

The variations of angular speed, angular position (angle rotor) and tie - line power flow (P_{1-2}) are displayed in Figure-14(a), (b) and (c) for the system with 20% change of input torque for generator 1 and 0% for



generator 2. Time is 120 sec using 16 rules in fuzzy logic controller.

Figure-14 (a), (b) and (c) show angular speed variations, angular position (angle rotor) variations and power flow (P_{1-2}) variations of a 2-generators connected via tie-line respectively. Likewise, can see the results show the smoothing effects of the double - FLC on generator 2.

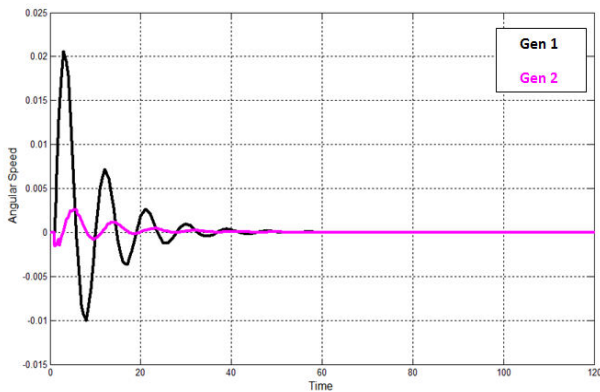

Figure-14 (a). Angular speed variations.

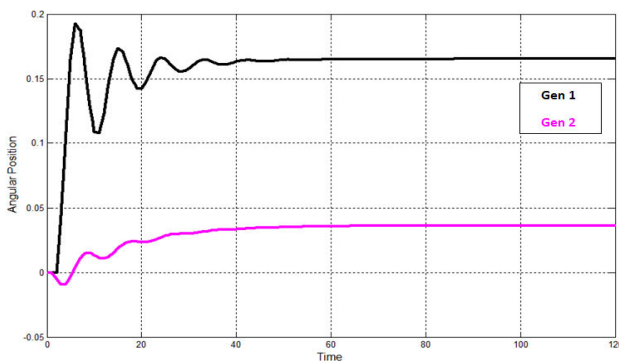

Figure-14 (b). Angular position (angle rotor) variations.

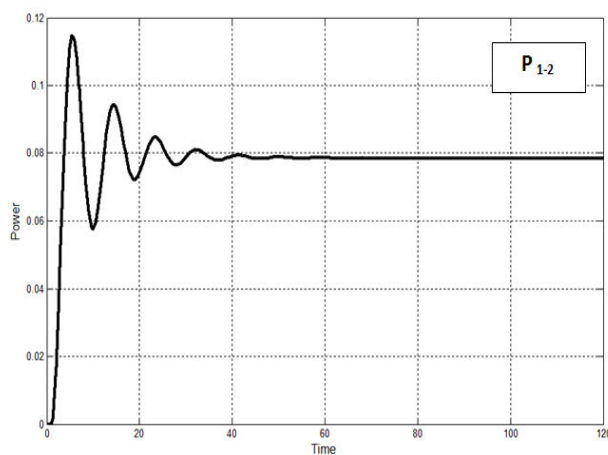

Figure-14 (c). Tie - line power flow variations.

CONCLUSIONS

This research studies the effects of different two controllers connected via tie-line. A single fuzzy logic controller (SFLC) was used for generator 1 and double fuzzy logic controller (DFLC) was used for generator 2. The input signals to the fuzzy logic controllers were taken from speed deviation and acceleration of synchronous generators. The performances of the power system with a double fuzzy logic controller (DFLC) based power system stabilizer had been effectively improved for all test. The simulation results had shown that the double fuzzy logic controller based power system stabilizer can decrease maximum overshoots and oscillations via smoothing effects compared to the single fuzzy logic controller. Therefore, the double fuzzy logic controller behaved more as a smoothing filter.

ACKNOWLEDGEMENT

The Authors are grateful to Universiti Teknikal Malaysia Melaka (UTeM) and university of Baghdad, Iraq for providing the research platform and financial assistance.

REFERENCES

- [1] K. Ben Meziane, M. Ben Abdellah and M. Ben Abdellah. 2015. An Interval Type-2 Fuzzy Logic PSS with the optimal H_{∞} tracking control for multi-machine power system. 2015 2nd Int. Conf. Inf. Sci. Control Eng.
- [2] M. Ahmed. 2016. Design of a Power System Stabilizer Using Adaptive- Neuro Fuzzy Logic for a Multi-Machine System Having Dynamic Loads. 2016 5th Int. Conf. Informatics, Electron. Vis. pp. 402-407.
- [3] T. Hussein and A. Shamekh. 2013. Adaptive Rule-base Fuzzy Power System Stabilizer for a Multi-machine System. 2013 21st Mediterr. Conf. Control Autom. Plataniias-Chania, Crete, Greece, June 25-28. pp. 1514-1519.
- [4] S. Chopra, R. Mitra, and V. Kumar. 2006. A robust scheme for tuning of fuzzy PI type controller. IEEE Intell. Syst., no. September. pp. 300-305.
- [5] M. Uma Vani and P. V. Ramana Rao. 2010. Fuzzy logic controller for enhancement of transient stability in multi machine AC-DC power systems. Proc. - 2010 Int. Conf. Comput. Intell. Commun. Networks, CICN, pp. 99-104.
- [6] Z. M. M. Ali. 2012. Improving Power System Stability Using A Fuzzy Logic Control. 2012 11th Int. Conf. APEIE – 30057, pp. 182-186.



- [7] M. Sulaiman, Z. Salleh, and R. Omar. 2015. Effects of Parameters Variation in Fuzzy based Induction Motor Drives. TELKOMNIKA Indones. J. Electr. Eng. 16(2): 701-711.
- [8] H. Mohammed, M. Sulaiman, M. Rasheed, R. Omar, S. Arasand, and A. Fateh. 2017. Stability Studies Of Fuzzy Logic Based Power System Stabilizer In Enhancing Dynamic Stability Of A Two Generators Tie-Line System. Vol. 12, No. 5, March 2017 ISSN 1819-6608 ARPN J. Eng. Appl. Sci. ©2006-2017 Asian Res. Publ. Netw. (ARPN). All rights Reserv. 12(5): 1-8.
- [9] F. Mayouf, F. Djahli, A. Mayouf and T. Devers. 2013. Multi-machine fuzzy logic excitation and governor stabilizers design using genetic algorithms. 2013 13th Int. Conf. Environ. Electr. Eng. IEEEIC 2013 - Conf. Proc. pp. 336-341.
- [10] K. C. Rout and P. C. Panda. 2011. Performance Analysis of Power System Dynamic Stability Using Fuzzy Logic Based PSS For Positive and Negative Value of K5 Constant. Comput. Commun. Electr. Technol. (ICCCET), 2011 Int. Conf., no. March. pp. 430-435.
- [11] A. P. R. Ramya, Ph. D Scholar Dr. K.Selvi. 2011. A Simple Fuzzy Excitation Control System for Synchronous Generator. 978-1-4244-7926-9/11/\$26.00 ©2011 IEEE 35. pp. 35-39.
- [12] M. S. M. Aras, S. S. Abdullah, H. I. Jaafar, A. R. Razilah, and A. Ahmad. 2013. A Comparison Study between Two Algorithms Particle Swarm Optimization for Depth Control of Underwater Remotely Operated Vehicle. Int. Rev. Model. Simulations (I.RE.MO.S.). 6(5).
- [13] A. J. Wood. 1996. Power generation, operation, and control. Print. United State Am.
- [14] M. Kushwaha. 2013. Dynamic Stability Enhancement of Power System using Fuzzy Logic Based Power System Stabilizer. 2013 Int. Conf. Power, Energy Control. pp. 213-219.
- [15] M. Shahrieel, M. Aras and S. Shah. 2015. Adaptive Simplified Fuzzy Logic Controller for Depth Control of Underwater Remotely Operated Vehicle. Indian J. Geo-marine Sci. 44(no. December): 1995-2007.
- [16] P. Gupta, V. Kumar, K. P. S. Rana and P. Mishra. 2015. Velocity and position forms of self-tuning Fuzzy PI controller applied to jacketed CSTR. 12th IEEE Int. Conf. Electron. Energy, Environ. Commun. Comput. Control (E3-C3), INDICON 2015. pp. 1-6.
- [17] M. and S. M. A.-H. A. S. Al-Hinai. 2009. Dynamic Stability Enhancement using Particle Swarm Optimization Power System Stabilizer. IEEE 2009 2nd Int. Conf. Adapt. Sci. Technol. pp. 0-4.