



MODEL IDENTIFICATION AND CONTROLLER DESIGN FOR AN ELECTRO-PNEUMATIC ACTUATOR SYSTEM WITH DEAD ZONE COMPENSATION

¹ N. H. Sunar, ¹ *M. F. Rahmat, ²Zool Hilmi Ismail, ²Ahmad Athif Mohd Faudzi, ³Sy Najib Sy Salim

¹Department of Control and Mechatronics Engineering, Faculty of Electrical Engineering, Universiti Teknologi Malaysia, 81310 Skudai, Johor, Malaysia

²Center of Artificial Intelligence and Robotic,

Universiti Teknologi Malaysia, Jalan Semarak, Kuala Lumpur, Malaysia

³Department of Control, Instrumentation and Automation, Faculty of Electrical Engineering, Universiti Teknikal Malaysia Melaka, Hang Tuah Jaya, 76100 Durian Tunggal, Melaka Malaysia

Emails: fuaad@fke.utm.my

*Corresponding author: M.F. Rahmat, fuaad@fke.utm.my

Submitted: Mar. 5, 2014

Accepted: Apr. 15, 2014

Published: June 1, 2014

Abstract- Pneumatic actuator system is inexpensive, high power to weight ratio, cleanliness and ease of maintenance make it's a choice compared to hydraulic actuator and electromagnetic actuator. Nonetheless, the steady state error of the system is high due to the dead zone of the valve. In this paper, an Auto-Regressive with External Input (ARX) model structure is chosen to represent the pneumatic actuator system. The recursive least square method is used to estimate the model parameters. The pole-assignment controller is then developed for position tracking. To cater the problem of high in steady state error, the dead zone compensation is added to the system. The dead zone controller was designed based on the inverse dead zone model and the dead zone compensation designed based on the desired error. The proposed method is then experimentally with varies load and compares with Nonlinear PID

controller. The result shows that the proposed controller reduced the overshoot and steady state error of the pneumatic actuator system to no overshoot and 0.025mm respectively.

Index terms: System identification, recursive least square, ARX, dead zone compensator, pneumatic actuator.

I. INTRODUCTION

In the past few years, there are many experimental methods have been identified by using system identification method to obtain a mathematical modeling of the pneumatic actuator system [1]. In the late of 1900s, the least square method has been used to identify an Auto-Regressive with External Input (ARX) model of pneumatic actuator system [2-4]. Then, the work in [5] enhanced the model by considering the forgetting factor. The third order Auto-Regressive Moving Average (ARMA) model has been identified as a model structure. In [6], by using a different order, a fourth order ARMA model has been obtained. In order to avoid complexity of nonlinear of the system, the mix reality environment has been employed to the Recursive Least Square (RLS) method for the identification method. Recently, a Modified Recursive Least Square (MRLS) method has been proposed [7]. The MRLS method was improved by adaptively changes the coefficient of forgetting factor with respect to the input and output signal.

On the other hand, the design for proper controller is also important in order to achieve an accurate position tracking of pneumatic system. For the perfect tracking controller, the basic idea is to achieve unity transfer function from the desired trajectory to the output of the system [8]. There are several approaches have been investigated and applied to the pneumatic system such as PID controller, pole assignment controller, sliding mode controller [9-10], adaptive controller [7, 11], back stepping controller [12-13], fuzzy [14-15] and neural network controller [16-17]. The tuning of the PID controller parameter have been investigated and applied to the pneumatic system. The tuning PID controller parameters approach such as Isermann's approach [3, 18], optimal tuning based on ITAE criteria [2] and automatic nonlinear gain PID controller [19].

Another linear control technique is the pole-assignment controller. The pole-assignment controller is a well-known technique to control linear dynamic system. A multi-rate adaptive pole-assignment controller has been proposed and has been experimentally proven to eliminate the influence of the constant disturbance caused by the additive external forces[20]. In 2005, a

pole-assignment controller has been applied to a pneumatic robot. The proposed controller has been improving the rise-time and reducing the overshoot of the step response system. The robot also tracked the desired position with small error by using the proposed controller [21]. Next, an adaptive self-tuning pole-assignment controller has been investigated to the pneumatic artificial muscles [22]. In 2013, a linear active disturbance rejection controller based on the pole assignment controller have been applied to the pneumatic servo system [23]. The results show that the proposed controller is robust against modeling uncertainty and external disturbance.

However, in this study, an ARX model structure identified by using RLS algorithm was chosen as the initial of the project study. Then, a pole assignment controller was developed based on the ARX model. A dead zone compensator is added to the system to overcome the nonlinearity of the proportional valve.

This paper is organized as follows. Section II provides the model identification of the pneumatic system. ARX models and the RLS method are presented. The pole-assignment method is presented in section III. Section IV described the dead zone compensation method. The experimental setup is provided in Section V. Section VI presented the obtained results and discussion and finally the conclusion of overall system in Section VII.

II. METHODOLOGY

a. Modeling

System identification (SI) is a method to obtain a mathematical model of the dynamic system based on experimental data. The identification was first introduced by Zadeh [24-25]. The other method to obtain a mathematical model is by implementing the known law of nature. It requires the knowledge regarding the system laws of physic, which is extremely complex for a system likes electro-pneumatic. This makes the SI advantaged compare to the derived mathematical from known law of nature.

The least square (LS) parameter estimator is one of the most popular estimation algorithms. The least squares estimation was first formulated by Karl Friedrich Gauss in 1975 for astronomical computation purposed. This method basically based on minimizes the sum of the squares of the residual. In this paper, an online LS parameter estimation is estimated in a recursive manner. The

recursive least square (RLS) is developed based on the batch processing algorithm using some matrix manipulation. This method can be done at every sampling interval.

There are four steps to determine model using SI:

- (1) The input and the output data
- (2) The model structure
- (3) The identification method
- (4) The model validation

a.i Input and Output data

In order to capture the dynamic of the system, the input signal must be chosen so that the maximum information regarding the system response is contained in the input and output data.

The sinusoidal signal is chosen with multiple frequencies as follows:

$$u(t) = 0.5 \cos(2\pi \times 0.07t) + 1.5 \cos(2\pi \times 0.1t) + 0.25 \cos(2\pi \times 0.5t) \quad (1)$$

a.ii The model structure

In this paper, a discrete time ARX model is chosen for the model structure of the electro-pneumatic actuator system. The discrete time system used is in the form:

$$y(k) = \frac{B}{A} u(k) \quad (2)$$

where

$$A = 1 + a_1 z^{-1} + \dots + a_{n_a} z^{-n_a} \quad (3)$$

$$B = b_0 + b_1 z^{-1} + \dots + b_{n_b} z^{-n_b} \quad (4)$$

a.iii The identification method

RLS algorithm can estimate the parameter b_0, \dots, b_{n_b} & a_1, \dots, a_{n_a} by first transforming (2) into a regression equation.

$$y(k) = \begin{bmatrix} y(k-1) & \dots & y(k-n_a) & u(k) & \dots & u(k-n_b) \end{bmatrix} \begin{bmatrix} a_1 \\ \vdots \\ a_{n_a} \\ b_0 \\ \vdots \\ b_{n_b} \end{bmatrix} \quad (5)$$

$$= \phi^T(k)\theta$$

The regression equation in (5) is then used in the RLS algorithm. The RLS algorithm can be summarized as in Table 1.

Table 1: Recursive least square method algorithm

Equation	Description
$\hat{\theta}(k) = \hat{\theta}(k-1) + L(k)\varepsilon(k)$	The current estimated is obtained by adding a correction to the previous estimate
$L(k) = \frac{P(k-1)\phi(k)}{\rho + \phi^T(k)P(k-1)\phi(k)}$	L is the Least Squares weighting factor. L tells how the correction and the previous estimates should be combined
$\varepsilon(k) = y(k) - \phi^T(k)\hat{\theta}(k-1)$	Current estimation error
$P(k) = \frac{1}{\rho} [P(k-1) - L(k)\phi^T(k)P(k-1)]$	P is a matrix that is proportional to the variance of the previous estimates. ρ is the forgetting factor that determines how fast old data are forgotten.

a.iv The model validation

Two sets data of were taken. The first data are used for estimation process. The estimation model then was validated with the second set of data. The best fit percentage of the estimation model over the validation data are compare and the final prediction error is calculated. The estimated model with highest best fit percentage and smallest final prediction error is chosen for the model of the electro-pneumatic system in this paper.

b. Pole-assignment Controller

In this research, the pole assignment controller is used to control the position tracking of the pneumatic actuator system. The controller output used is:

$$u = \frac{1}{F} [Hr(t) - Gy(t)] \tag{6}$$

where:

$$F = 1 + f_1z^{-1} + \dots + f_{n_f}z^{-n_f} \tag{7}$$

$$G = g_0 + g_1z^{-1} + \dots + g_{n_g}z^{-n_g} \tag{8}$$

$$H = h_0 + h_1z^{-1} + \dots + h_{n_h}z^{-n_h} \tag{9}$$

The closed loop of the system is depicted in the Figure 1.

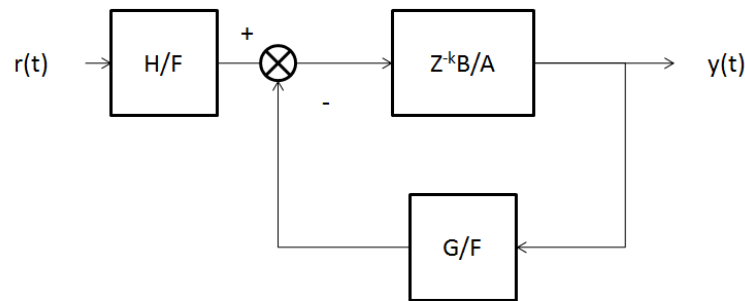

Figure 1. The closed loop of the system.

The closed loop of the system can be represented as:

$$y(t) = \frac{z^{-k}BH}{AF + z^{-k}BG} r(t) \tag{10}$$

For pole-assignment controller, the Diophantine equation is defined as [26]:

$$AF + z^{-k}BG = T \tag{11}$$

where:

$$T = 1 + t_1z^{-1} + \dots + t_{n_t}z^{-n_t} \tag{12}$$

In order to have a unique solution for the controller coefficient, the order of F and G must follow below condition:

- (1) A and B are co-prime, where A and B do not have common zeros
- (2) $n_f = n_b + k - 1$
- (3) $n_g = n_a - 1$
- (4) $n_t \leq n_a + n_b + k - 1$

For $y(t) = r(t)$, at steady state, the value of H can be obtained as follow:

$$H = \frac{T(z^{-1})}{B(z^{-1})} \Big|_{z^{-1}=1} \quad (13)$$

c. Dead Zone Compensator

The asymmetric dead zone was considered in this paper as in [27] and [28]. Figure 2 shows dead zone of the valve model.

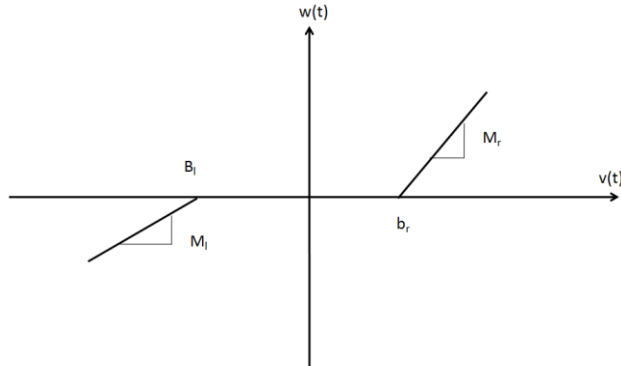

Figure 2. Dead Zone Model

The dead zone model can be represented as follow with input $v(t)$ and output $w(t)$:

$$w(t) = \begin{cases} m_r v(t) - m_r b_r & \text{for } v(t) \geq b_r \\ 0 & \text{for } b_l \leq v(t) \leq b_r \\ m_l v(t) - m_l b_l & \text{for } v(t) \leq b_l \end{cases} \quad (14)$$

where m_r , m_l , b_r and b_l are the right slope, left slope, right break point, and left break point respectively. The based on the model of the dead zone, inverse dead zone model is shown in Figure 3.

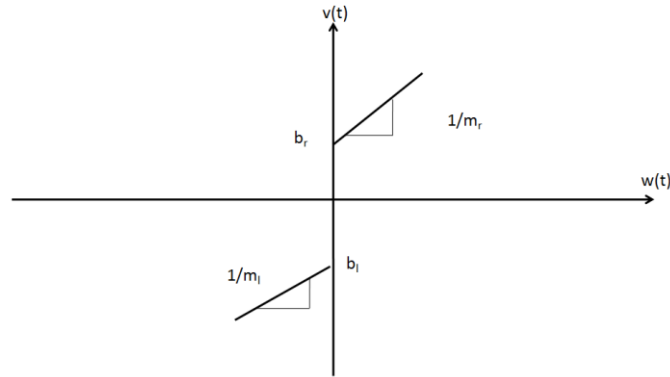

Figure 3. Inverse dead zone model

The inverse dead zone model can be write as in (15).

$$v(t) = \begin{cases} \frac{w(t) + m_r b_r}{m_r} & \text{for } w(t) \geq 0 \\ \frac{w(t) + m_l b_l}{m_l} & \text{for } w < 0 \end{cases} \quad (15)$$

However, the inverse function may lead to chattering of the control input signal $v(t)$ between the values of b_l and b_r when $w(t)$ is equal to zero. For solution, a compensator as in [29-30] was applied when $w(t)$ is near to zero. The Figure 4, show the flow chart for the dead zone compensator used in [30].

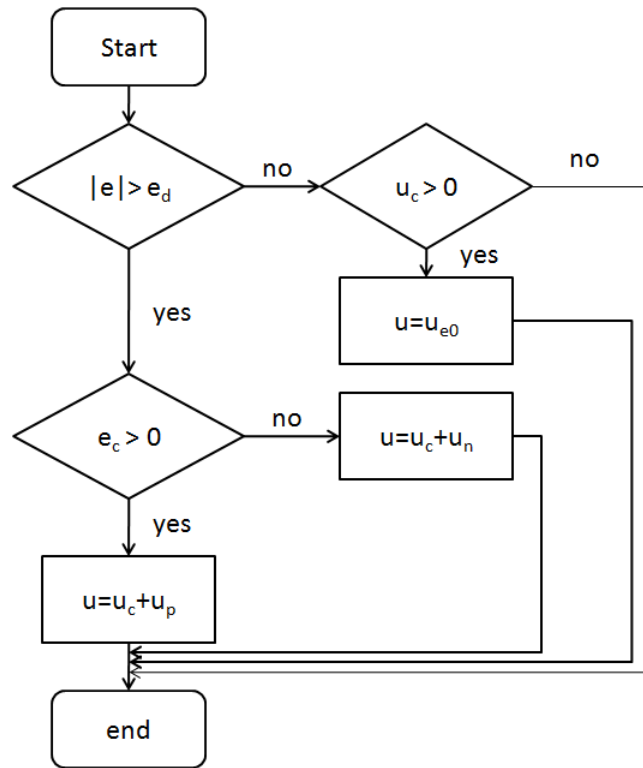

Figure 4. Dead zone compensator flow chart

In [30], when the position error (e), exceeded the desired steady state error (e_d), positive dead zone compensation (u_p) and negative dead zone compensation (u_n) are added to the controller output (u_c) either in positive or negative direction respectively.

III. EXPERIMENTAL SETUP

a. Identification

The input used is showed in Figure 5 (a). Meanwhile, the output of the system is showed in Figure 5(b). The input of the system is in unit voltage to the control valve: while the output of the system is in unit position in millimeter.

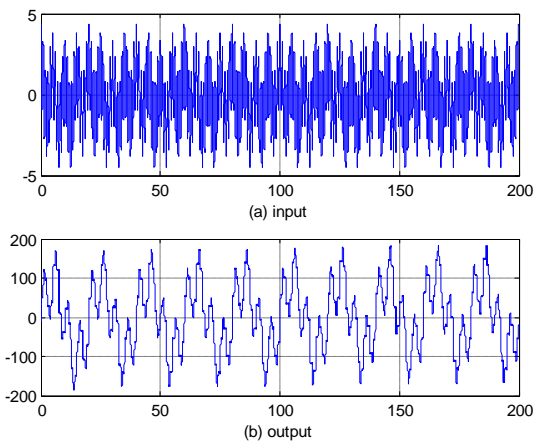

Figure 5. Input and Output data of the Electro-pneumatic actuator system

A third order ARX model used in this study can be expressed as follow:

$$y(t) = \left(\frac{z^{-k} (b_0 + b_1 z^{-1} + b_2 z^{-2})}{1 + a_1 z^{-1} + a_2 z^{-2} + a_3 z^{-3}} \right) r(t) \tag{16}$$

The estimated parameter a_1, a_2, a_3 and b_0, b_1, b_2 are shown as in Figure 4 and Figure 5 respectively.

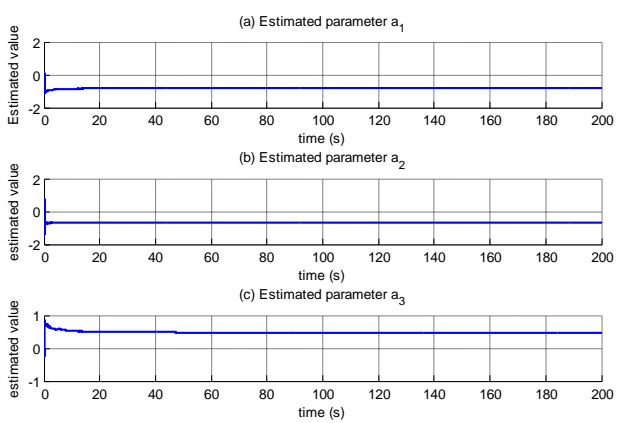

Figure 6. Estimated parameter a_1, a_2 and a_3

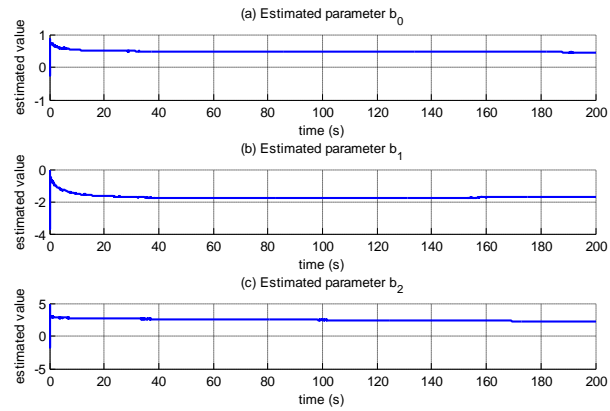

Figure 7. Estimated parameter b_0, b_1 and b_2 .

The parameter model value is shown in Table 2.

Table 2: The estimated value of the ARX model using RLS method.

Parameter	Value
a_1	-0.7969
a_2	-0.6616
a_3	0.4586
b_0	-1.7080
b_1	2.2300
b_2	-0.1470

Figure 7 show the experimental output and simulation output of the electro-pneumatic actuator system. The simulation is based on the estimated value model given in Table 2. Based on the result, the best fit percentage between simulation and experimental output is 85.7%. The final prediction error is 0.0136.

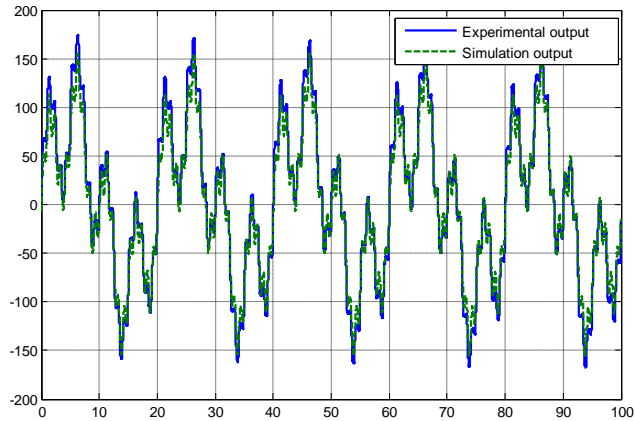

Figure 8. Measured and Simulated Output

b. Pole-Assignment Controller

From (16), the value of n_a , n_b and n_k is 3, 2 and 1 respectively. The order of F and G can be obtained as follow:

(1) A and B are co-prime, where A and B do not have common zeros

$$(2) n_f = n_b + k - 1 = 2 + 1 - 1 = 2$$

$$(3) n_g = n_a - 1 = 3 - 1 = 2$$

$$(4) n_t \leq (n_a + n_b + k - 1 = 3 + 2 + 1 - 1 = 5)$$

The desired pole location must be chosen in the unit circle. Figure 8 shows the desired characteristic equation pole location used in this paper. The value of t_1 is -1.9469 and t_2 is 0.9481.

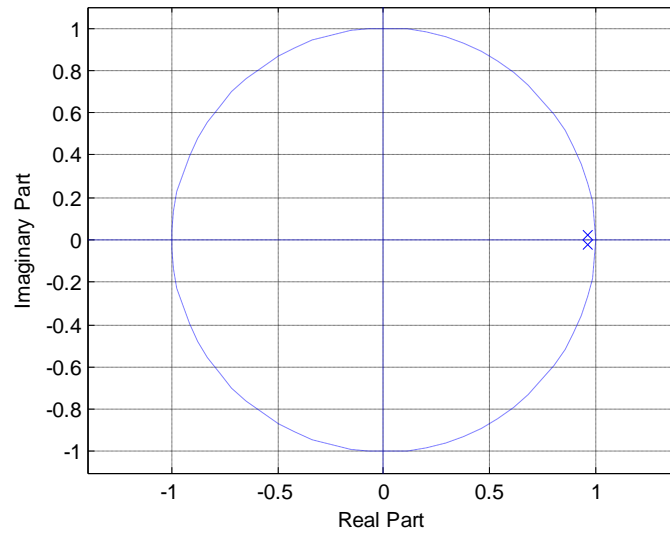

Figure 9. Desired characteristic equation pole location

The value of parameter F and G are solved using matrix as in (17) and H as in (13)

$$\begin{bmatrix} 1 & 0 & b_0 & 0 & 0 \\ a_1 & 1 & b_1 & b_0 & 0 \\ a_2 & a_1 & b_2 & b_1 & b_0 \\ a_3 & a_2 & 0 & b_2 & b_1 \\ 0 & a_3 & 0 & 0 & b_2 \end{bmatrix} \begin{bmatrix} f_1 \\ f_2 \\ g_0 \\ g_1 \\ g_2 \end{bmatrix} = \begin{bmatrix} t_1 - a_1 \\ t_2 - a_2 \\ t_3 \\ t_4 \\ t_5 \end{bmatrix} \quad (17)$$

The value of parameter F , G and H are showed in Table 3.

Table 3: Obtained parameter F , G and H

Parameter	Value
f_1	-0.9459
f_2	-0.0617
g_0	0.1195
g_1	-0.3090
g_2	0.1925
H	0.0030

c. Dead Zone Compensator

The left break point and right break point can be determined by giving a negative ramp input voltage and positive ramp input voltage to the system. Figure 9 shows the position output in unit voltage when given a negative ramp input voltage while Figure 10 shows the position output in unit voltage when given a positive ramp input voltage.

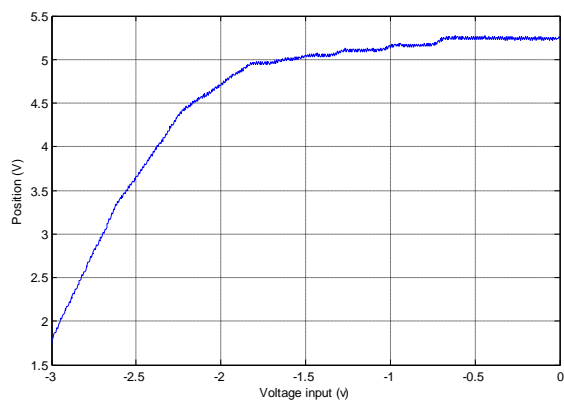

Figure 10. Position output when giving negative ramp input

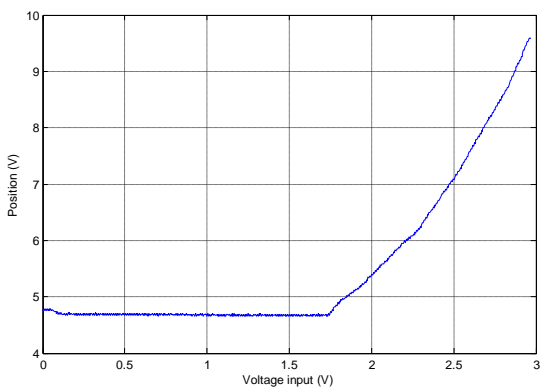

Figure 11. Position output when giving positive ramp input voltage

The break points and slopes can be summarized as in Table 4.

Table 4: Dead zone parameter value

Break point left, b_l (V)	Slope left (m_l)	Break point right, b_r (V)	Slope right (m_r)
-1.7913	2.6459	1.6713	4.4169

The u_n and u_p is 1V and 0.65V respectively.

IV. RESULTS AND DISCUSSION

a. Simulation Result Pole assignment Controller

Figure 12 shows the simulation output when giving a square input at 50mm. From the Figure 12, the overshoot of the system is 1.99% and steady state error is greater almost zero. The time rise and settling time is 0.90s and 2.65s respectively.

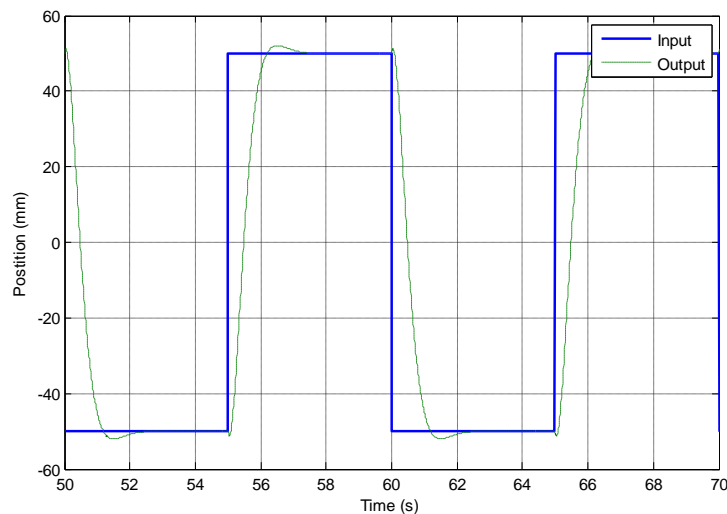

Figure 12. Simulation position output when injected with square input.

b. Experimental result pole-assignment controller with dead zone compensator

The pole assignment controller with dead zone compensator was experimentally tested to the pneumatic actuator system. Table 5 shows the comparison of the controller performance between the simulation result of the pole-assignment controller with experimental result of the pole-assignment controller with dead zone compensator.

Table 5: The comparison controller performance of simulation result of pole assignment controller with experimental result of pole-assignment controller with dead zone compensator

Control Performance Criterion	Simulation Pole assignment Controller	Hardware Pole assignment with dead zone compensator
Rise Time (s)	0.90	1.13
Settling Time (s)	2.65	1.40
Overshoot (%)	1.99	0
e_{ss} (mm)	$\cong 0$	0.025

c. Pole-assignment controller with dead zone compensator with varies load

The robustness of the proposed controller were tested by performing an experimental with different payload from 0 kg to 31 kg. Figure 13 shows the position controller output with varying loads.

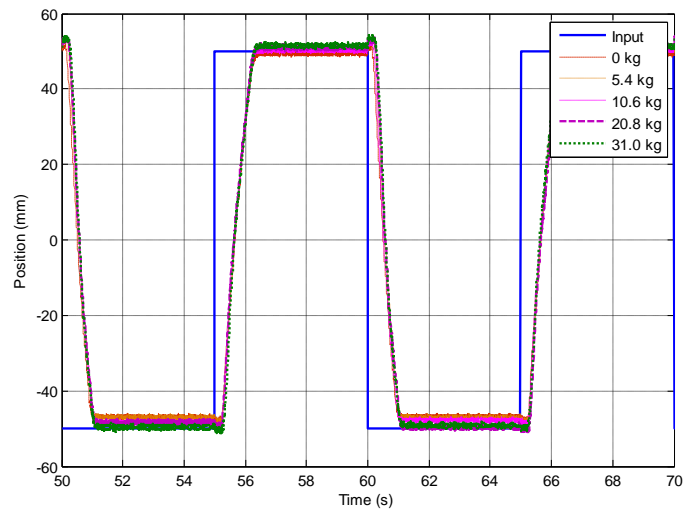

Figure 13. Position output when injected with square input with varies load

From Figure 13, as the load weight increase, the rise time and its settling time become faster. The steady state error of the system is higher when the load weight increased. The proposed controller results no overshoot maximum up to 31 kg. The step response characteristic can be summarized as in Table 6.

Table 6: Step response characteristic with varies payload

Load (kg)	0	5.4	10.6	20.8	31.0
Rise Time (s)	1.13	1.12	1.10	1.10	1.13
Settling Time (s)	1.40	1.30	1.29	1.27	1.28
Overshoot (%)	0	0	0	0	0
e_{ss} (mm)	0.025	0.15	0.52	0.21	1.09

The proposed controller was also tested to sine input for position tracking. Figure 14 shows the position output of the proposed controller with respect to sine input under different payloads.

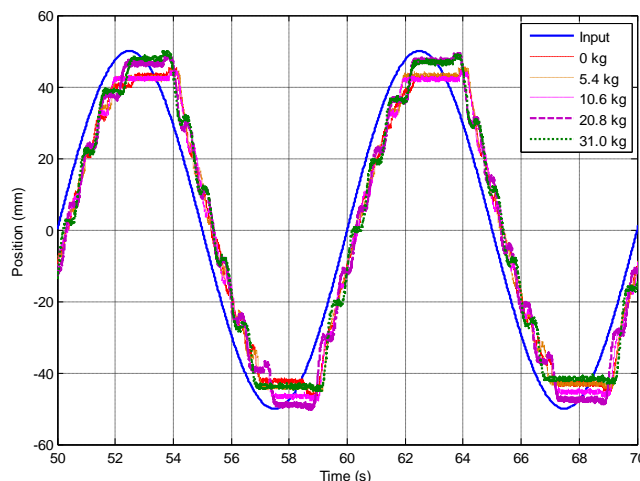

Figure 14. Position output when injected with sine input with varies load

The Figure 13 and Figure 14 shows that the proposed controller can track the given desired input.

d. Pole-assignment controller compared with Nonlinear PID

To verify with other controller method, the proposed controller was compared with the Nonlinear PID (NPID) that was proposed in [19]. The summary of the comparison between the proposed controller with NPID is shown in Table 7

Table 7: Comparison the performance of the pole-assignment controller with NPID controller for the electro-pneumatic actuator system.

	Pole-Assignment with dead zone compensator				NPID without dead zone compensator			
Load (kg)	0	5.4	10.6	20.8	0	5.4	10.6	20.8
Overshoot (%)	0	0	0	0	0	0	5.68	5.69

The Table 7 shows that the proposed pole-assignment controller with dead zone compensator improved the overshoot of the system.

V. CONCLUSIONS

In this study, an ARX model was identified by using an RLS method. For the position tracking of the pneumatic actuator system, a pole-assignment controller was incorporated with dead zone compensator. The dead zone compensation was a combination of inverse dead zone model and the dead zone compensator to cater the steady state error. Result shows a good position tracking performance with 0.025mm steady state error and no overshoot. The Pneumatic system was also tested under different loads and it has been proven that the proposed controller can improved the steady state error and the overshoot of the system. Compared with the NPID controller, the proposed controller is robust in terms of overshoot when tested with different load. However, the proposed controller results slower rise time and settling time. For the future work, the rise time and the settling time can be improved to achieve the best performance of the position tracking of the electro-pneumatic actuator system.

ACKNOWLEDGEMENT

This research is supported by the Universiti Teknologi Malaysia (UTM) and Ministry of High Education (MOHE) through CUP grant TIER 1 vote number Q.JI30000.2523.00H36 which is greatly appreciated. The authors are grateful for the MyPhD scholarship under the MyBrain15 program by MOHE for author scholarship.

REFERENCES

- [1] M. F. Rahmat, N. H. Sunar, Sy Najib Sy Salim, Mastura Shafinaz Zainal Abidin, A. A. Mohd Fauzi, and Z. H. Ismail, "Review on Modeling and Controller Design in Pneumatic Actuator Control System," *International Journal On Smart Sensing and Intelligent Systems*, vol. 4, pp. pp 630-661, 2011.
- [2] M.-C. Shih and S.-I. Tseng, "Identification and position control of a servo pneumatic cylinder," *Control Engineering Practice*, vol. 3, pp. 1285-1290, 1995.

- [3] S. Aziz and G. M. Bone, "Automatic tuning of an accurate position controller for pneumatic actuators," in *Intelligent Robots and Systems, 1998. Proceedings., 1998 IEEE/RSJ International Conference on*, 1998, pp. 1782-1788 vol.3.
- [4] W.K. Lai, M.F. Rahmat, and N. A. Wahab, "Modeling and Controller Design of Pneumatic Actuator System with Control Valve," *International Journal on Smart Sensing and Intelligent Systems*, vol. 5, pp. 624-644, 2012.
- [5] P. Chaewieang, K. Sirisantisamrit, and T. Thepmanee, "Pressure control of pneumatic-pressure-load system using generalized predictive controller," in *Mechatronics and Automation, 2008. ICMA 2008. IEEE International Conference on*, 2008, pp. 788-791.
- [6] A. Saleem, S. Abdrabbo, and T. Tutunji, "On-line identification and control of pneumatic servo drives via a mixed-reality environment," *The International Journal of Advanced Manufacturing Technology*, vol. 40, pp. 518-530, 2009.
- [7] H. P. H. Anh and N. T. Nam, "Modeling and Adaptive Self-Tuning MVC Control of PAM Manipulator Using Online Observer Optimized with Modified Genetic Algorithm," *Engineering*, vol. 3, p. 130, 2011.
- [8] R. Ghazali, Y. M. Sam, M. F. Rahmat, Zulfatman, and A. W. I. M. Hashim., "Perfect Tracking Control with Discrete LQR for a Non-minimum Phase Electro-Hydraulic Actuator System," *International Journal On Smart Sensing and Intelligent Systems*, vol. 4, pp. pp 424-439, 2011.
- [9] M. Taleb, A. Levant, and F. Plestan, "Twisting algorithm adaptation for control of electropneumatic actuators," in *Variable Structure Systems (VSS), 2012 12th International Workshop on*, 2012, pp. 178-183.
- [10] C. Hong-Ming, C. Zi-Yi, and C. Ming-Cheng, "Implementation of an Integral Sliding Mode Controller for a Pneumatic Cylinder Position Servo Control System," in *Innovative Computing, Information and Control (ICICIC), 2009 Fourth International Conference on*, 2009, pp. 552-555.
- [11] A. Grigaitis and V. A. Gelezevicius, "Electropneumatic servo system with adaptive force controller," in *Power Electronics and Motion Control Conference, 2008. EPE-PEMC 2008. 13th*, 2008, pp. 1144-1148.

- [12] L. Chia-Hua and H. Yean-Ren, "A study on tracking position control of an pneumatic system by backstepping design," in *Control Automation Robotics & Vision (ICARCV), 2010 11th International Conference on*, 2010, pp. 721-726.
- [13] M. Smaoui, X. Brun, and D. Thomasset, "A study on tracking position control of an electropneumatic system using backstepping design," *Control Engineering Practice*, vol. 14, pp. 923-933, 2006.
- [14] H. M. L. Eng, "Control og a Pneumatic Servosystem Using Fuzzy Logic," in *Proc. of 1st FPNI-PhD Symp. Hamburg*, 2000, pp. 189-201.
- [15] S. Kaitwanidvilai and P. Olanthichachat, "Robust loop shaping-fuzzy gain scheduling control of a servo-pneumatic system using particle swarm optimization approach," *Mechatronics*, 2010.
- [16] G. Kothapalli and M. Y. Hassan, "Design of a neural network based intelligent PI controller for a pneumatic system," *IAENG International Journal of Computer Science*, vol. 35, pp. 217-222, 2008.
- [17] K. Ahn and B. Lee, "Intelligent switching control of pneumatic cylinders by learning vector quantization neural network," *Journal of Mechanical Science and Technology*, vol. 19, pp. 529-539, 2005.
- [18] R. B. Van Varseveld and G. M. Bone, "Accurate position control of a pneumatic actuator using on/off solenoid valves," *Mechatronics, IEEE/ASME Transactions on*, vol. 2, pp. 195-204, 1997.
- [19] M. Rahmat, S. N. S. Salim, N. Sunar, A. A. M. Faudzi, Z. Hilmi, and I. K. Huda, "Identification and non-linear control strategy for industrial pneumatic actuator," *International Journal of Physical Sciences*, vol. 7, pp. 2565-2579, 2012.
- [20] K. Tanaka, Y. Yamada, A. Shimizu, and S. Shibata, "Multi-rate adaptive pole-placement control for pneumatic servo system with additive external forces," in *Advanced Motion Control, 1996. AMC '96-MIE. Proceedings., 1996 4th International Workshop on*, 1996, pp. 213-218 vol.1.
- [21] R. Richardson, M. Brown, B. Bhakta, and M. Levesley, "Impedance control for a pneumatic robot-based around pole-placement, joint space controllers," *Control Engineering Practice*, vol. 13, pp. 291-303, 2005.

- [22] A. Kyoung Kwan and A. Ho Pham Huy, "System Identification and Self-Tuning Pole Placement Control of the Two-Axes Pneumatic Artificial Muscle Manipulator Optimized by Genetic Algorithm," in *Mechatronics and Automation, 2007. ICMA 2007. International Conference on*, 2007, pp. 2604-2609.
- [23] W. Bo, W. Tao, J. Ying, F. Wei, and W. Yu, "Study of pneumatic servo system based on linear active disturbance rejection controller," in *Advanced Intelligent Mechatronics (AIM), 2013 IEEE/ASME International Conference on*, 2013, pp. 1170-1174.
- [24] J. Micheal, M. F. Rahmat, N. Abdul Wahab, and W. K. Lai, "Feed Forward Linear Quadratic Controller Design for an Industrial Electro-Hydraulic Actuator System with Servo Valve," *International Journal On Smart Sensing and Intelligent Systems*, vol. 6, pp. pp 154-170, 2011.
- [25] C. Kaddissi, J. P. Kenne, and M. Saad, "Identification and Real-Time Control of an Electrohydraulic Servo System Based on Nonlinear Backstepping," *Mechatronics, IEEE/ASME Transactions on*, vol. 12, pp. 12-22, 2007.
- [26] R. Ghazali, Y. M. Sam, M. F. Rahmat, K. Jusoff, Zulfatman, and A. W. I. M. Hashim., "Self-Tuning Control of an Electro-Hydraulic Actuator," *International Journal On Smart Sensing and Intelligent Systems*, vol. 4, pp. pp 189-204, 2011.
- [27] X.-S. Wang, C.-Y. Su, and H. Hong, "Robust adaptive control of a class of nonlinear systems with unknown dead-zone," *Automatica*, vol. 40, pp. 407-413, 2004.
- [28] H. Chuxiong, Y. Bin, and W. Qingfeng, "Performance-Oriented Adaptive Robust Control of a Class of Nonlinear Systems Preceded by Unknown Dead Zone With Comparative Experimental Results," *Mechatronics, IEEE/ASME Transactions on*, vol. 18, pp. 178-189, 2013.
- [29] G. Sen Gupta, S. C. Mukhopadhyay, C. H. Messom, and S. N. Demidenko, "Master–Slave Control of a Teleoperated Anthropomorphic Robotic Arm With Gripping Force Sensing," *Instrumentation and Measurement, IEEE Transactions on*, vol. 55, pp. 2136-2145, 2006.
- [30] Sy Najib Sy Salim, M. F. Rahmat, A. A. M. Fauzi, N. H. Sunar, Z. H. Ismail, and S. I. Samsudin, "Tracking Performance and Distrubance Rejection of Pneumatic Actuator System," in *9th Asian Control Conference Istanbul, Turkey*, 2013.