

International Journal of Applied Engineering Research
ISSN 0973-4562 Volume 9, Number 21 (2014) pp. 11151-11162
© Research India Publications
<http://www.ripublication.com>

EMG Signal Features Extraction of Different Arm Movement for Rehabilitation Device

M. H. Jali¹, I.M. Ibrahim², M. F. Sulaima³, T. A. Izzuddin⁴, W. M. Bukhari⁵

Faculty of Electrical Engineering, Universiti Teknikal Malaysia Melaka, Malaysia
¹*mohd.hafiz@utem.edu.my*, ²*iffamastura@gmail.com*, ³*fani@utem.edu.my*,
⁴*tarmizi@utem.edu.my*, ⁵*bukhari@utem.edu.my*

Abstract

Rehabilitation device is used as an exoskeleton for people who had failure of their limb. Arm rehabilitation device may help the rehab program to who suffer from arm disability. The device used to facilitate the tasks of the program should improve the electrical activity in the motor unit and minimize the mental effort of the user. Electromyography (EMG) is the techniques to analyze the presence of electrical activity in musculoskeletal systems. The electrical activity in muscles of disable person is failed to contract the muscle for movements. To prevent the muscles from paralysis becomes spasticity the force of movements should minimize the mental efforts. To minimize the used of mental forced for disable patients, the rehabilitation device should analyze the surface EMG signal of normal people that can be implemented to the device. The signal is collected according to procedure of surface electromyography for non-invasive assessment of muscles (SENIAM). The EMG signal is implemented to set the movements' pattern of the arm rehabilitation device. The filtered EMG signal were extracted for features of Standard Deviation(STD), Mean Absolute Value(MAV), Root Mean Square(RMS) in time-domain. The extraction of EMG data is important to have the reduced vector in the signal features with less of error. In order to determine the best features for any movements, several trials of extraction methods are used by determining the features that can be used in classifier. The accurate features can be applied in future works of rehabilitation control system in real-time and classification of the EMG signal.

Keyword – Electromyography, Features Extraction, Time-domain Analysis, Arm Rehabilitation Device, Upper Limb, Bilateral Movement

I. INTRODUCTION

Human support system is known as an endoskeleton. Endoskeleton plays a role as a framework of the body which is bone. Our daily movements are fully depends on the functionality of our complex systems in the body. The disability one or more of the systems in our body will reduce our physical movements. Exoskeleton device is known as rehabilitation device to facilitate disable person. The functionality of the rehabilitation device has to smooth as the physical movement of normal human.

People who have temporary physical disability have the chances to recover. The rehabilitation programs provide the suitable plan for conducting the nerve and stimulate the muscles. Nowadays, rehabilitation program are using rehabilitation devices in their tasks. The functionality of devices depends on muscle contraction. Electromyogram studies help to facilitate the effectiveness of the rehabilitation device.

The technique of measuring electrical activity that produced by muscles during rest or contractions known as electromyography (EMG). The electrical signal generates from the brain and sends to the muscles via motor neuron. The EMG could detect the dysfunctional of the muscles or failure in signals transmission from nerves to muscles. The failure of sending the electrical signal from the brain to the conducting nerves requires electrical stimulation from the external source to muscles. Electrodes are used for signal detection of electrical activity in muscles. The study of this electrical activity is important for combination of electromyogram into the rehabilitation device.

The rehabilitation device is a tool that used to help the movements for daily life activities of the patients who suffer from the failure of muscle contractions, due to the failure of the muscles contractions the movements is limited. The ability of the patients to do the tasks in the rehabilitation programs need to be measured. The rehabilitation programs have to assure whether the tasks will cause effective or bring harm to the patients[2].

Historically, the rehabilitation tasks have been avoided due to a belief that it would increase spasticity [1]. In this research, the analysis of the data will be focusing on upper limb muscles contraction consisting of biceps muscles only. The experiment is limited to the certain of upper limb movements that use in training. EMG is a division of bio signal; the bio signal analysis is the most complex analysis. Thus, the signal analysis is a complicated process that has to be through many phases of analysis [3]. Therefore, the challenge of this study to assure that the signal processing is conducted properly to overcome the environment noise during data collection [11].

II. SIGNAL PROCESSING

The output of the system commonly is defined by the input. The output is the main achievement of the system. However, the EMG input is always a raw signal that needs to be process into several plants until it can produce the desired output. EMG signal is one type of bio signal that contains lot of noise from many factors. The noise may come from the skin at the electrode placement, type of electrode that may use for data collecting and also the environment. There are various type of size and pattern of electrodes, depends on the muscle area would like to detect and the thickness of the

skin layer. The EMG noise signal can be reduced by choosing the gelled electrode which were Silver –Silver Chloride(Ag-AgCl) as the substance. Ag-AgCl introduces less electrical noise into the measurements [13]. However, these noise should be eliminate to have a better signal for analysing purpose, the noise can be eliminate by many factors such as control environment, electrode placements and signal acquisition circuitry and configuration.[1][2] As for the features extraction there were various types in terms of frequency domain, time frequency domain and time scale domain. These types are chose based on the purpose of the analysis of the signal. In signal conditioning for time domain analysis, there is some features that can be applied. These features are described briefly as follows:

i) Root-Mean-Square (RMS)

RMS is the square root of the mean over time of the square of the vertical distance of the graph from the rest state. It much related to the constant force and non-fatiguing contraction of the muscle. In most cases, it is similar to standard deviation method.

$$RMS = \sqrt{\frac{1}{N} \int_{i=1}^N EMG(i)^2}$$

ii) Mean Absolute Value(MAV)

Mean absolute value is calculated by taking the average of the absolute value of EMG signal. Since it represents the simple way to detect muscle contraction levels, it becomes a popular feature for myoelectric controlled applications.

$$MAV = \frac{1}{n} \sum_{i=1}^n |x_i - \bar{x}|$$

iii) Standard Deviation(STD)

Standard deviation is a measure of the dispersion of a set of data sample from its mean. The more spread apart the data, the higher the deviation. Standard deviation is calculated as the square root of variance.

$$STD = \sqrt{\frac{1}{N-1} \sum_{i=1}^N (x_i - \bar{x})^2}$$

III. DATA ACQUISITION IN SEMG

Surface EMG is the technique that had been applied in this study for recording the electrical activity in the muscles by the electrodes. The sEMG provide an easy, safe and non-invasive method that allow the quantification of the muscles' energy. Recording the signal are depends on several criteria that need to be considered before the signal is recorded. According to Zahak Jamal *et al.* on his studies, the electrode placements are an important issue that need to be considered, the placements is depends on the type of the muscles as the muscles at each limb is different. The quality of the sEMG signal that generates from the muscles' energy can be maximizes

by placing the electrodes at the belly of the muscles not at or near the tendon and motor unit. If the electrodes is bipolar configuration(Fig 1.), which have three detecting surfaces, both electrode need to be placed nearly to each other within 1-2cm [4]. These two detecting surfaces are connected to differential amplifier while another one electrode is placed at the reference(bone).

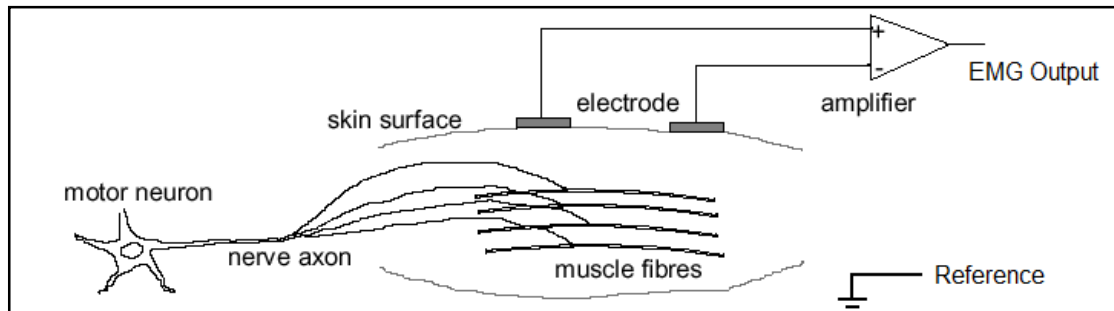

Fig 1. Bipolar configuration

The aim for this study to have the EMG signal for analysis purpose by reduce all the unwanted noise from the electrode, hardware and the environment to maximize the quality of the EMG signal. There have a lot of noise factor that can be categorized as follows;

- i) *Causative Factors*: This is the direct affected on signals.
 - a. *Extrinsic* – The signal get affected by the electrode placement, structure, surface detection, distance between electrode(bipolar configuration), and location of the surface detection on the skin.
 - b. *Intrinsic* – It may due to physiological, biochemical and anatomical factors.
- ii) *Intermediate Factors*: This is the phenomena of influencing by one or more causative factors.
- iii) *Deterministic Factors*: This is influenced by the intermediate factors.

By reducing all these factor of noises, the quality of EMG signal will be enlarge and the analysis of the information will be less of error and easy to obtain. However, the precautions of handling the hardware and the electrode are needed. Acquisition data play the important role to maximizing the quality of the EMG signal, such as minimizing the distortion in EMG signal, using any filtering tools are not recommended. In terms of signal-to-ratio(SNR) the information that carried in SNR should contain the maximum information of EMG signal[3][10]. Moreover, the quality of EMG signal is affected by the environment,has to set by minimizing the noise factor, this method also known as control environment. The ambient noises sourced by electromagnetic device such as radio transmission, fluorescent lights and power line interference from electrical wires[10][4]. These ambient noise and motion artifact can be reduced by the proper electrode placements, circuit configuration and control environment. The signal recorded in Fig 2. shows the appearance of electrical activity in muscles cannot be differentiate by any muscles contraction, because of not

following the criteria to reduce the noises and the electrode placements detection surface range.

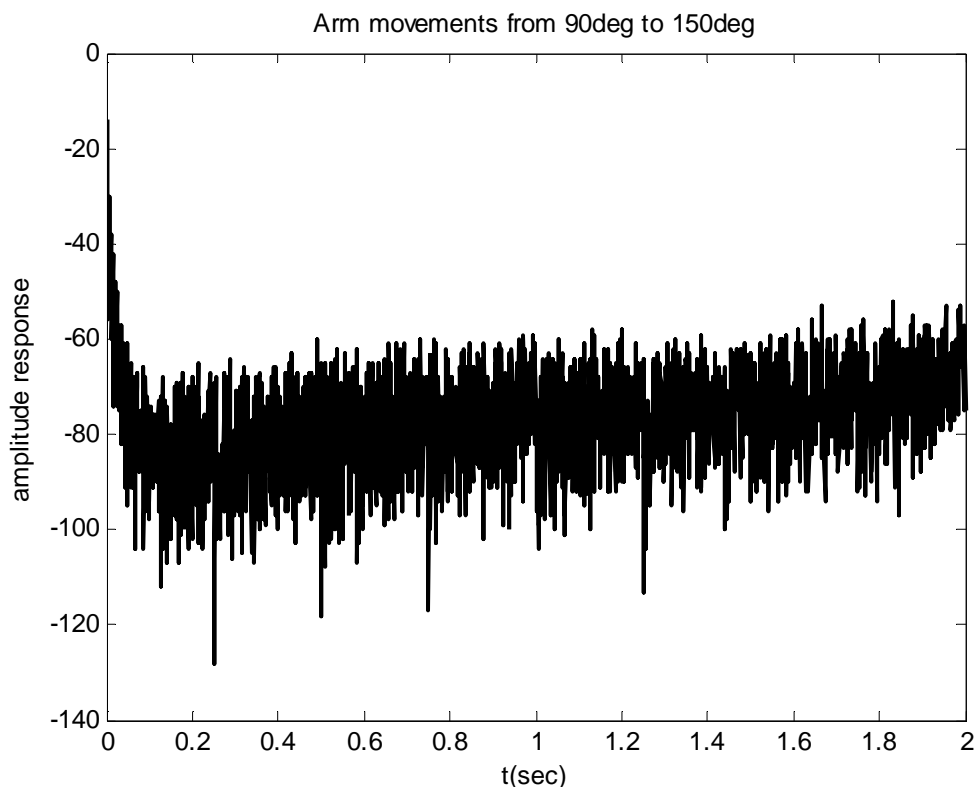

Fig.2.The effects of placement the bipolar electrodes not within 1-2cm and without environment control (ambient noise).

IV. EXPERIMENTAL SETUP

The experiment's environment is in a room with low lighting especially the fluorescent light, any electromagnetic devices is away from the experiment equipment and the environment is in soundless room. Then, the experimental is set up with the subject sit on the chair while the hand is on the table. The subject has to complete the task of lift up the dumbbell with 2.27kgs of weigh in Figure 5 for 10 times. Mostly, the EMG signal is obtained after several trials of the movements. Normally, the appearance of EMG signal is chaos and noisy depends on the type of electrodes also the noise factor. To simplify the difference of amplitude response's motion, the dumbbell is functioned to amplify the amplitude in analyzing the electrical activity during rest and contract. The rehabilitation devices(white in colour on Fig. 3) helps to keep the position of the elbow joint and the wrist joint in line without being affected by the weight of the dumbbell during lift up motion. These movements are specified from angle of 0° (arm in rest position), up to 120° (arm is fully flexion) [12][14]. The experiment will go through several phases as explained in the next section.

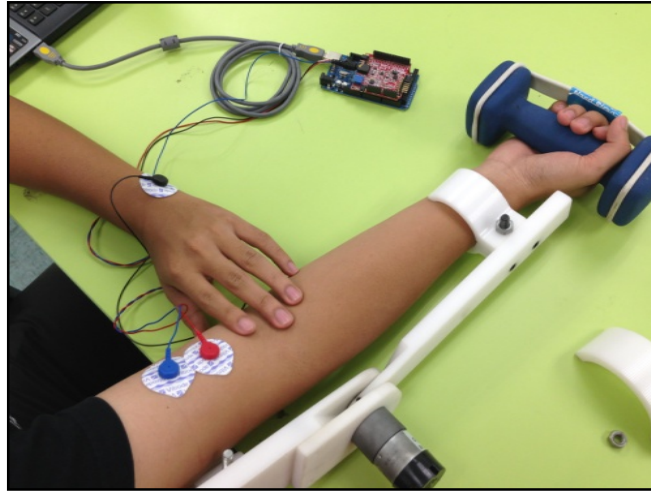

Fig. 3. Subject Is Set-Up with Arm Rehabilitation Assistive Device for Experiment

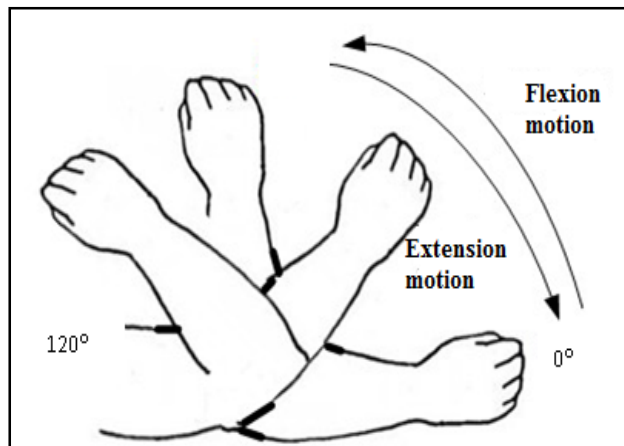

Fig.4. Simulation of Subject Has To Lift Up the Dumbbell 2.27 Kgs of Weight

1) Phase 1: Skin Preparation and Electrode Placements.

The placement of the electrode is followed after skin preparation. The preparation of the skin is needed before placing the electrodes. The subject's skin has to shave using small electrical shaver and cleaned with sterile alcohol swabs saturated with 70% Isopropyl Alcohol as shown in Fig 5(a). This step is to be taken for minimising the noise and to have a good contact with the electrodes of the skin. The skin has to be clean from any contamination of body oil, body salt, hair and the dead cells. The preparation of skin can be done by wipe the alcohol swab into the area of skin that electrode placement to be applied. The placements of the electrode have to be at the belly of the muscles not in the tendon or motor unit. Electrode leads and gelled electrode (Fig 5(b)) is used to collect the data. The combination of Arduino Mega and the OLIMEX shield, simplified the hardware. As the EMG signals are too sensitive

towards magnetic devices, the neatness of the hardware is needed. The neatness ensured the electrode leads and the detecting surface intersects most of the same muscle on subject as in Fig 6(b) at biceps, and as a result, an improved superimposed signal is observed. Reference electrode has to be at the body where no muscles exist as the ground signal, for this experiment it placed at wrist on the unaffected hand(refer Fig 6(b)).



Fig. 5.The Alcohol Swab(a) and the Gelled Electrode(b) That Used in This Experiment.

2) Phase 2: sEMG Signal Acquisition

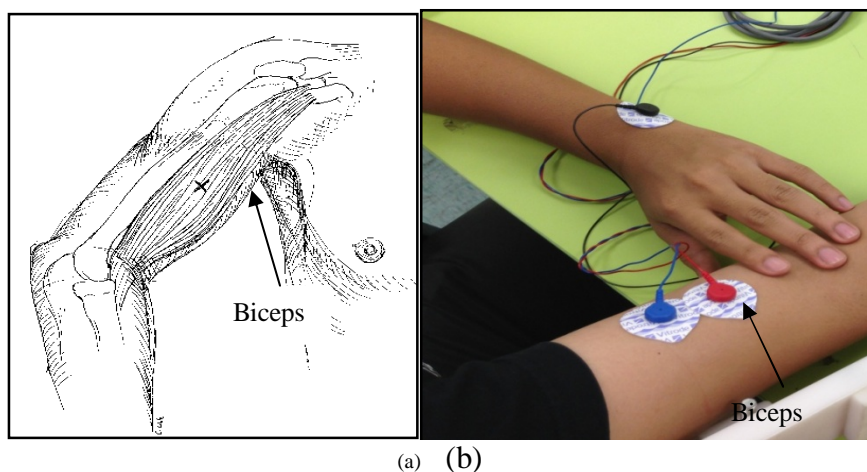

Fig.6. The Biceps Brachii Muscles For Electrode Positions(a), The Electrode Placements On Subject Skin(b)

Gelled electrode has two leads detecting surfaces and one lead as reference electrode. These two detecting surface need to be placed in range of less than 1-2 cm from each of it at the biceps muscle as in Fig 6(b). The gelled electrode for the blue lead and red lead are placed at the biceps skin for detection purpose, meanwhile the gelled electrode with black lead is placed at area with no muscles exist and unaffected hand.[1] The grounded electrode hand is placed at the leg to have a better grounding purpose. From Figure 8 these EMG signals will go through into high voltage protection to protect any electrical surge that may bring harm to the user and the hardware. These signals are available for signal conditioning process as the next step to be taken. The circuit that be used in this experiment is provided by the OLIMEX shield. The signals via the OLIMEX shield through the analogue circuit are very weak the voltage is around $10\mu\text{V}$, full of noise and contain primarily 60Hz of frequency. The signals are next need to be filter and rectify, reducing the noise and amplifying the signals for analysis purpose. After the signals is filtered and amplified the signals is sent to the digital board and yet ready to display into the MATLAB software.

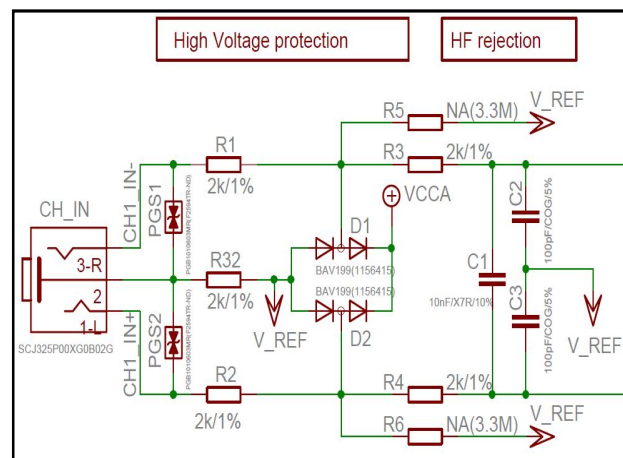

Fig.7.The Electrical Diagram of Electrode Sensor, High Voltage Protection and Frequency Rejection.

3) Phase 3: Signal Conditioning

The signals from the board are gathered in the SIMULINK software. Signals from the OLIMEX shield need to be filtered by using the peak notch filter and the high pass filter. Peak notch filter is used for filtering the interference from the line AC and radio frequency from the devices frequency nearby. Meanwhile, the high pass filter is used for placed the baseline of EMG signals display in the scope(SIMULINK) at the zero line, also known as DC offset. Block diagram for collecting the EMG signal is showed in Figure 9. The raw EMG signals is next to filter by using Butterworth filter. The Butterworth filter is set to 5th order and 10/1000 Hz frequency. The filtered signal is accessed for features extraction. This EMG signal evaluated in time domain features. The analysis of this study soon to be applies in real-time application. Thus, the time-domain suits this study for better future work. These features are Root-Mean-

Square(RMS), Mean Absolute Value(MAV), Standard Deviation(STD), Variances(VAR), and Zero Crossing(ZCS). This statistical information of the features evaluations were run in the MATLAB R2013a. The signals that gathered from the SIMULINK is next to be apply for features extraction. The features are extracted using MATLAB 2013a programming.

V. RESULTS AND DISCUSSIONS

The filtered signal goes into features extraction process. The features extraction is set into five types which were RMS, MAV, STD, ZCS and VAR. These features are extracted from each movement of individual EMG signal. The data of the features is accumulated in Table 1. The suitable features that may use in classifying the movement are MAV, RMS and STD. ZCS and VAR value are not applicable in classifying the features. ZCS produced the whole numbers, meanwhile the VAR produced the scientific number that smaller in range of 10^{-6} . However, the ZCS and VAR features may be used as it is, in its own class of features. The results are various except the feature is preset.

TABLE I The Features of Degree Movements by Angle.

Subjects	Angle	MAV	RMS	STD	ZCS	VAR
S1	60°	0.001903	0.001981	0.001329	50	1.68E-06
		1.61E-03	0.001777	0.001329	48	1.99E-06
		1.42E-03	1.75E-03	0.001325	44	0.001325
	90°	0.00232	0.0027	0.0022	58	2.66E-06
		0.00231	0.00267	0.00219	43	2.15E-06
		0.00228	0.00254	0.00215	37	2.189E-06
	120°	0.00318	0.00363	0.00311	39	3.13E-06
		0.00317	0.00365	0.0031	41	2.71E-06
		0.00317	0.00339	3.16E-03	51	3.71E-06
S2	60°	0.00174	0.00219	1.42E-03	65	9.50E-07
		0.00165	0.00189	1.38E-03	65	9.75E-06
		0.00164	0.00188	1.21E-03	31	1.76E-06
	90°	0.00244	0.00286	0.00238	81	2.35E-06
		0.00237	0.00285	0.00231	85	2.62E-06
		0.00232	0.00277	0.00228	54	1.62E-06
	120°	0.00315	3.99E-03	0.00316	13	3.56E-06
		0.00316	3.98E-03	0.00318	33	3.93E-06
		0.00315	0.00384	0.00314	45	3.42E-06
S3	60°	9.75E-04	0.0019	0.00124	27	8.34E-07
		9.15E-04	0.00162	0.00133	19	1.22E-06
		9.13E-04	1.61E-03	1.10E-03	19	8.38E-07
	90°	0.002	0.00239	0.00209	23	1.24E-06
		0.00189	0.00231	0.00207	17	1.93E-06

		0.00186	0.00228	0.00205	41	1.75E-06
	120°	0.00282	0.00318	0.00314	31	2.49E-06
		0.00291	0.00316	0.00307	50	2.53E-06
		2.98E-03	0.00315	0.00302	23	2.60E-06
S4	60°	0.00161	0.00198	0.00133	15	1.89E-06
		0.00154	0.00185	0.00129	19	1.46E-06
		0.00141	1.73E-03	0.00127	20	2.00E-06
	90°	0.00233	0.00246	2.44E-03	30	2.21E-06
		0.00231	0.00243	0.00237	25	2.75E-06
		2.23E-03	0.00242	0.0026	27	2.06E-06
	120°	0.0033	0.00391	0.00317	34	3.05E-06
		0.0032	0.00382	0.00313	36	3.16E-06
		0.00327	0.00378	3.11E-03	37	3.01E-06

ZCS and VAR formed the whole and 10^{-6} scientific numbers that would not achievable to be class into the classifier because of the distance value of features itself. Data from Table 1 is plotted into scatter graph in Fig. 8. Sample 1 up to sample 4 be owned by movement of 60°, sample 5 to sample 8 is belong to movement of 90° and sample 9 to sample 12 is fit in movement 120°. The green, yellow and red outline colour in Fig. 8 shows that the scatter features is obviously been clustered by its angle of movements' class. Even though the clustered movements is scattered in its class, the objective of this study is achievable. The features of movements are belongs in their movement group. The learning of the features is continued in data classification [15][16]. The time-domain features for STD, MAV and STD shows in Fig. 8 useful for future works such as classification of the features. The classification of time-domain features provide reliable information that might be use with combination these three features for research in many type of classification technique.

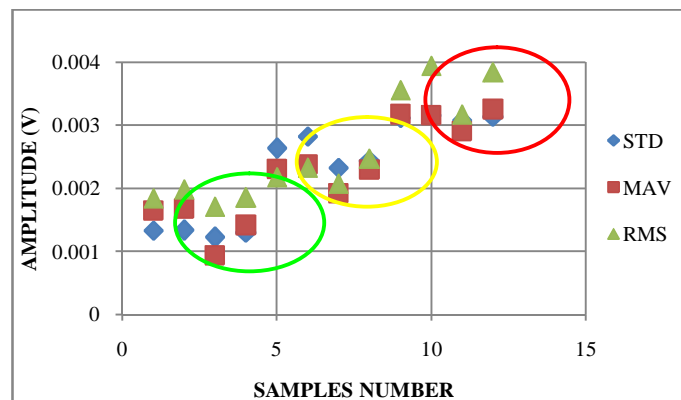

Fig. 8.The Scatter Graph of Features versus Amplitude Voltage.

VI. CONCLUSION

In this study has further discussed on the noise and the environment that affects the EMG signal during data collection. The surface electrodes contain lot of noise compared to needle insertion procedure, noise from the skin itself and the environment have been discussed in this study for better understanding to get a better quality of EMG signals.

The objectives of this study is to extract the features have successfully obtained from the experiment are MAV, STD, RMS, ZCS and VAR. On the other hand, not all the features can be classified into the class of several degrees of movements. The suitable features for classification are MAV, STD and RMS. The features are obtained by signal processing phase. The features of time-domain are extracted by using programming software use in MATLAB software. MAV, STD and RMS verified in scatter graph that it can be use for several movements of classification in future works. The uses of these features might be separately or combination among the all three.

ACKNOWLEDGMENT

The authors would like to thanks UniversitiTeknikal Malaysia Melaka (UTeM) and Ministry of Education, Malaysia for the financial supports given through Research Grant.

REFERENCES

- [1] B. B, "Adult Hemiplegia: Evaluation and treatment.," Oxford, Butterworth-Heinemann., 1990.
- [2] S. D. C. G. C. Louise Ada, "Strengthening interventions increase strength and improve activity after stroke: a systematic review," *Australian Journal of Physiotherapy*, vol. 52, pp. 241-248, 2006.
- [3] J. Muthuswamy, "Biomedical Signal Analysis," In *Standard Handbook Of Biomedical Engineering And Design*, Mc-Graw Hill, 2004, pp. 18.1 - 18.30.
- [4] M. Z. Jamal, "Signal Acquisition Using Surface EMG and Circuit Design Considerations for Robotic Prosthesis," in *Computational Intelligence in Electromyography Analysis –A Perspective on Current Applications and Future Challenges*, InTech, 2012, pp. 427-448.
- [5] S.-P. L. Sang-Hui Park, "EMG Pattern Recognition Based on Artificial Intelligence Techniques," *IEEE Transactions On Rehabilitation Engineering*, vol. 6, no. 4, 1998.
- [6] C. L. a. P. P. Angkoon Phinyomark, "A Novel Feature Extraction for Robust EMG Pattern Recognition," *Journal Of Computing*, vol. 1, no. 1, pp. 71-80, 2009.
- [7] K. Mahaphonchaikul, "EMG Signal Feature Extraction Based on Wavelet Transform".
- [8] P. M. S. K. Mr. Santosh S. Patil, "Feature Extraction of MES (MyoElectricSignal) using Temporal approach for prosthetic arm control," *International Journal of Electronics and Computer Science Engineering*.

- [9] L. Oujamaa, "Rehabilitation of arm function after stroke. Literature review," *Annals of Physical and Rehabilitation Medicine*, vol. 52, pp. 269-293, 2009.
- [10] M. B. I. Reaz, "Techniques of EMG signal analysis: detection, processing, classification and applications," Cyberjaya, Selangor, www.biologicalprocedures.com, 2006, pp. 11-35.
- [11] M. H. Jali, M. F. Sulaima, T. A. Izzuddin, W. M. Bukhari, M. F. Baharom., "Comparative Study of EMG based Joint Torque Estimation ANN Models for Arm Rehabilitation Device", **International Journal of Applied Engineering Research (IJAER)**, vol. 9(10), pp. 1289-1301, 2014.
- [12] MH Jali, TA Izzuddin, ZH Bohari, H Sarkawi, MF Sulaima, MF Baharom, WM Bukhari, "Joint Torque Estimation Model Of sEmg Signal For Arm Rehabilitation Device Using Artificial Neural Network Techniques", *ARPN Journal of Engineering and Applied Sciences*, vol 9(7), pp 1170 - 1176, 2014
- [13] M.H.Jali, I.M. Ibrahim, M.F.Sulaima, W.M Bukhari, T.A.Izzuddin and M.N.M. Nasir, "Features Extraction of EMG Signal using Time Domain Analysis for Arm Rehabilitation Device", *International Conference on Mathematics on Mathematics, Engineering and Industrial Applications (ICoMEIA)*, 2014.
- [14] M.H.Jali, T.A.Izzuddin, Z.H.Bohari, M.F.Sulaima, H.Sarkawi, "Predicting EMG Based Elbow Joint Torque Model Using Multiple Input ANN Neurons for Arm Rehabilitation " ,UKSim-AMSS 16th International Conference on Modelling and Simulation, 2014
- [15] M.H.Jali, Z.H.Bohari, M.F.Sulaima, M.N.M.Nasir and H.I.Jaafar, "Classification of EMG Signal Based on Human Percentile using SOM", *Research Journal of Applied Sciences, Engineering and Technology (RJASET)*, 2014.
- [16] M.H.Jali, I.M.Ibrahim, Z.H.Bohari, M.F.Sulaima, M.N.M.Nasir, "Classification Of Arm Movement Based On Upper Limb Muscle Signal For Rehabilitation Device", *Journal of Theoretical and Applied Information Technology (JATIT)*, 2014.