

Hindawi Publishing Corporation
ISRN Mechanical Engineering
Volume 2014, Article ID 240942, 6 pages
<http://dx.doi.org/10.1155/2014/240942>



Research Article

Prediction of Waste Heat Energy Recovery Performance in a Naturally Aspirated Engine Using Artificial Neural Network

Safarudin Gazali Herawan,¹ Abdul Hakim Rohhaizan,¹ Azma Putra,¹ and Ahmad Faris Ismail²

¹ Centre for Advanced Research on Energy, Universiti Teknikal Malaysia Melaka, Hang Tuah Jaya, 76100 Durian Tunggal, Malacca, Malaysia

² Department of Mechanical Engineering, Faculty of Engineering, International Islamic University Malaysia (IIUM), P.O. Box 10, 50728 Kuala Lumpur, Malaysia

Correspondence should be addressed to Safarudin Gazali Herawan; safarudin@utem.edu.my

Received 3 January 2014; Accepted 3 March 2014; Published 30 March 2014

Academic Editors: T. Basak and K. Ismail

Copyright © 2014 Safarudin Gazali Herawan et al. This is an open access article distributed under the Creative Commons Attribution License, which permits unrestricted use, distribution, and reproduction in any medium, provided the original work is properly cited.

The waste heat from exhaust gases represents a significant amount of thermal energy, which has conventionally been used for combined heating and power applications. This paper explores the performance of a naturally aspirated spark ignition engine equipped with waste heat recovery mechanism (WHRM). The experimental and simulation test results suggest that the concept is thermodynamically feasible and could significantly enhance the system performance depending on the load applied to the engine. The simulation method is created using an artificial neural network (ANN) which predicts the power produced from the WHRM.

1. Introduction

The number of motor vehicles continues to grow globally and therefore increases reliance on the petroleum and increases the release of carbon dioxide into atmosphere which contributes to global warming. To overcome this trend, new vehicle technologies must be introduced to achieve better fuel economy without increasing harmful emissions. For internal combustion engine (ICE) in most typical gasoline fuelled vehicles, for a typical 2.0 L gasoline engine used in passenger cars, it was estimated that 21% of the fuel energy is wasted through the exhaust at the most common load and speed range [1]. The rest of the fuel energy is lost in the form of waste heat in the coolant, as well as friction and parasitic losses.

Since the electric loads in a vehicle are increasing due to improvements of comfort, driving performance, and power transmission, it is therefore of interest to utilize the wasted energy by developing a heat recovery mechanism of exhaust gas from internal combustion engine. It has been identified in [2] that the temperature of the exhaust gas varies depending on the engine load and engine speed. The higher

the engine speed the higher the temperature of the exhaust gas. Significant amounts of energy that would normally be lost via engine exhausts can thus be recovered into electrical energy. Theoretically, the energy from the exhaust gas can be harnessed to supply an extra power source for vehicles and will result in lower fuel consumption, greater efficiency, and also an overall reduction in greenhouse gas emission.

The recovery and conversion of this heat into useful energy is a promising approach for achieving further reductions in fuel consumption and, as a result, reduction of exhaust emission. Among other technologies for waste heat recovery such as thermoelectric generators [3–5], secondary combustion for emission reduction [6], thermal storage system from heat exchanger [7], and pyroelectric using heat conduction [8], the Organic Rankine Cycle (ORC) has shown promising results and is already well established in many applications on automotive field [2, 9–14]. However, the construction, weight, and control system of the ORC still encounter some problems when installed in the motor vehicle.

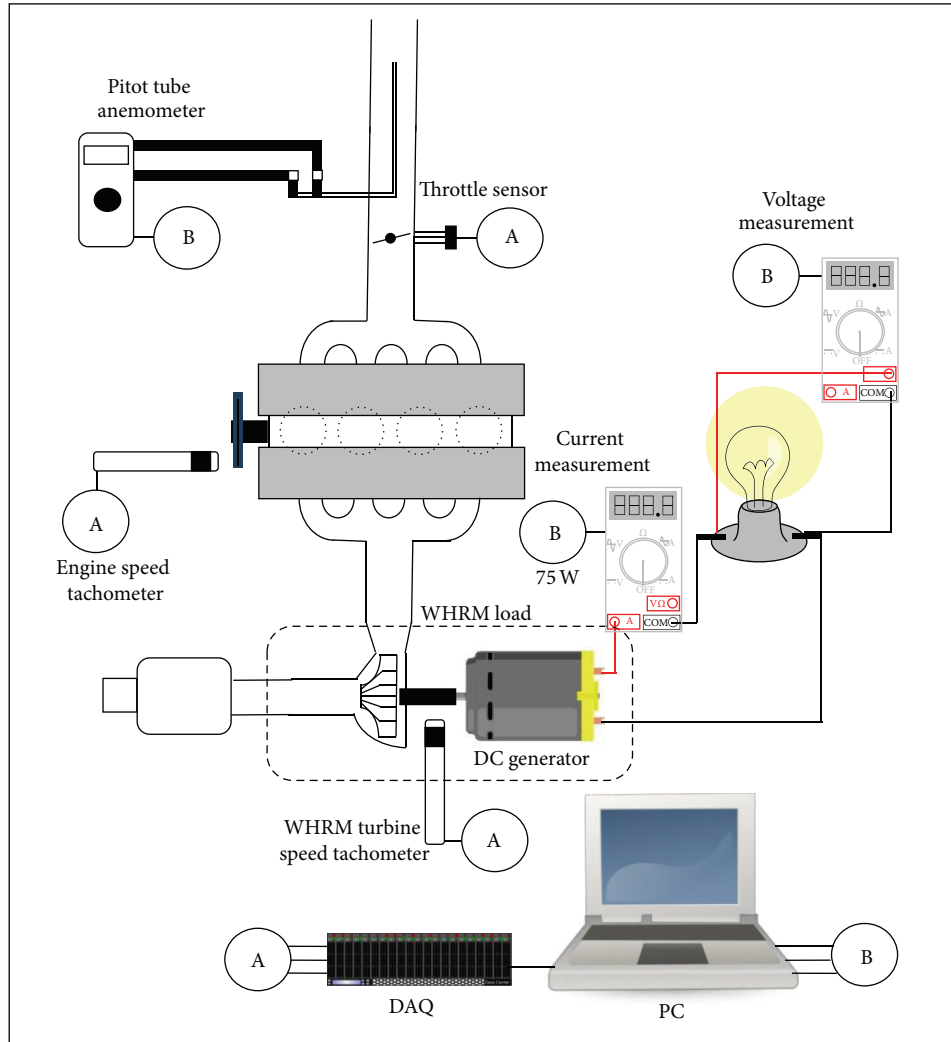

FIGURE 1: The schematic layout of the experimental setup of the WHRM.

TABLE 1: Specification of the test engine.

Type	Specification
Valve train	DOHC 16 valves
Fuel system	Multi point fuel injection
Displacement	1587 cc (in-line)
Compression ratio	9.4 : 1
Bore	81 mm
Stroke	77 mm
Power	112 Hp @ 6600 rpm
Torque	131 Nm @ 4800 rpm

The number of components of ORC and their volume have to be reduced due to restrictions in costs, space and weight, as well as complexity of steam pressure and temperature control during the transient operation.

In this study, a simple novel waste heat recovery mechanism (WHRM) is proposed. The WHRM is a device adapted from a turbocharger module, where the compressor part is

replaced with a DC generator to produce an output current and voltage. This simple and low cost structure with straight forward energy recovery and with complexity-free control system is expected to be a great alternative application for an energy recovery system.

In order to predict this output power, the artificial neural network (ANN) is employed. This ANN approach has been applied in a spark ignition engine to provide good estimation of the desired output parameters when sufficient experimental data were provided [15–25]. The ANN can create a model of physical behavior in a complex system without requiring explicit mathematical models.

2. Experimental Setup and Testing Procedures

The experiment was performed on a Toyota vehicle having 1.6 liter in-line four-cylinder gasoline engine. Table 1 shows the specification of the test engine.

A schematic diagram of the experimental setup is shown in Figure 1. A 75 Watt bulb was used as a load causing

TABLE 2: Details of the instrumentation used in the experiment.

Measured variable	Instrument	Brand	Range	Uncertainty
Air volume flow rate [m^3/min]	Pitot tube anemometer	Extech	0–99,999	$\pm 3\%$ rdg
Throttle angle [degree]	Existing throttle sensor	—	—	—
Engine speed [rpm]	Optical tachometer	Compact	100–60,000 rpm	$\pm 0.5\%$
WHRM turbine speed [rpm]	Optical tachometer	Compact	100–60,000 rpm	$\pm 0.5\%$
Voltage [V]	USB multimeter	Pros'Kit	0–600 V	$\pm(0.5\% + 4 \text{ d})$
Current [A]	USB multimeter	Pros'Kit	0–10 A	$\pm(1.2\% + 10 \text{ d})$

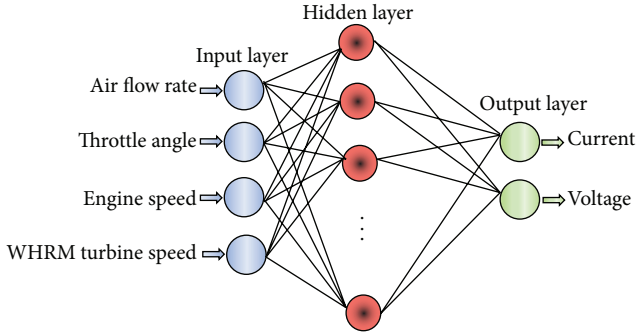
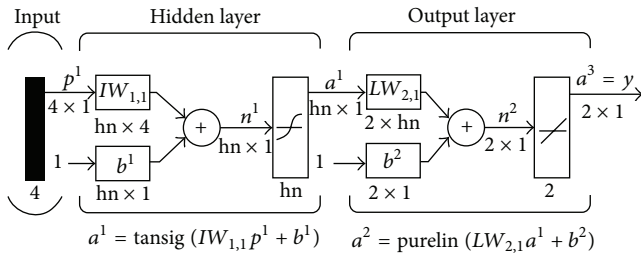

FIGURE 2: The architecture of the ANN.



*hn = hidden neuron (5, 6, 10, 20, 30)

FIGURE 3: Detailed structure of the ANN.

the DC generator to produce an output current and voltage which were recorded in a computer through USB digital multimeter. The air duct to the intake manifold of engine was equipped with a pitot tube digital anemometer to measure the volume flow rate of the intake air. The engine speed and the WHRM turbine speed were continuously monitored using an optical tachometer allowing the digital data to be recorded in a computer through USB data acquisition module. This was also applied for the data of the throttle position for intake air captured using the existing throttle sensor in the experimental vehicle. The test was conducted on the road with variable vehicle speed up to 70 km/h with normal driving. Some features of the instrumentation are summarized in Table 2.

3. Artificial Neural Networks (ANN)

Artificial neural networks (ANN) have been used in a broad range of applications, including identification, optimization, prediction, and control processes [15–25]. The ANN basically

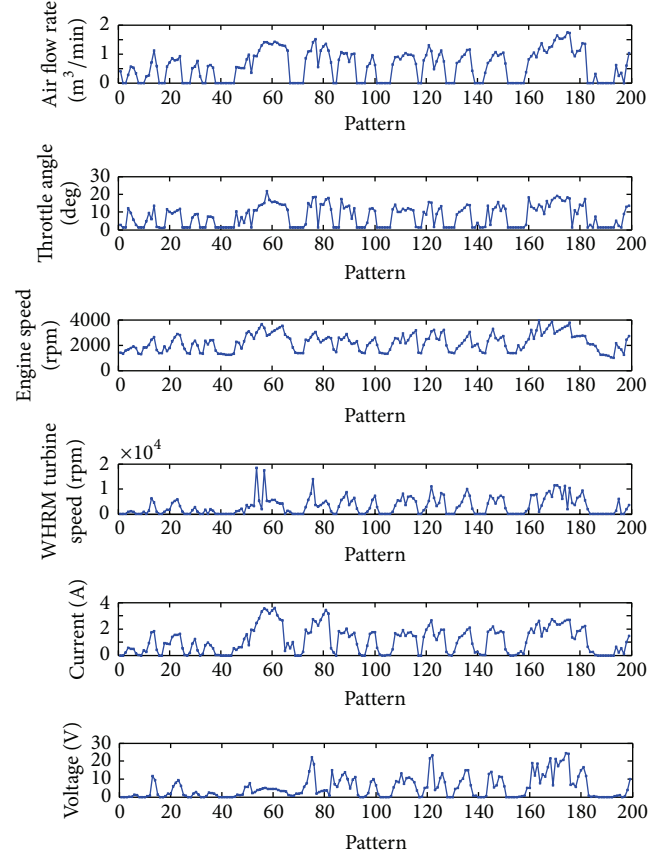

FIGURE 4: The measure data from experimental vehicle.

uses the data input and data output to generate algorithm that consists of interconnected processing nodes known as neuron. Each neuron accepts a weighted set of inputs and responds with an output.

The data in this study were obtained from the experimental results with 235 measurements (termed here as pattern). The ANN is used to model the output voltage and current produced from the WHRM. The inputs for the ANN network are the air volume flow rate, throttle angle, engine speed, and WHRM turbine speed, while the outputs are voltage and current produced from WHRM.

The data from the experimental tests were used to train and test the ANN algorithm. As many as 199 patterns were employed as the data sets to train the network, while the remaining 36 patterns were used as the test data. The

architecture of ANN is 4-5-2 corresponding to 4 input values, 5 hidden neurons on one hidden layer with the tan-sigmoid (tansig) transfer function, and output layer with purelin transfer function for 2 output values as shown in Figure 2.

The back-propagation learning algorithm was used in a feed-forward network where the training procedure adjusted the weighting coefficients using Levenberg-Marquardt algorithm (LM). This learning algorithm has also been employed in [19–25].

The structure of the ANN is shown in Figure 3. The computer program was performed under MATLAB environment. In the training, increasing number of hidden neuron (5, 6, 10, 20, and 30) was implemented in the hidden layer. When the network training was completed, the network was tested with the train patterns and the test patterns. The statistical methods of correlation coefficient (R) and root mean square error (RMSE) were implemented for comparison.

4. Results and Discussion

Figure 4 shows the measured data of the air volume flow rate, throttle angle, engine speed, WHRM turbine speed, and the output voltage and output current from the experiment. Note that the results were taken in the actual measurement. Therefore all the measured parameters are in full dynamic condition, meaning that none of the parameters was under control. Correlations between all the parameters can be clearly observed, for example, those between the 160th and 180th patterns. The change of throttle angle affects directly to the air flow rate, engine speed, and WHRM turbine speed, which eventually changes the output current and voltage accordingly.

From Figure 4, it can be seen that the maximum current produced by the DC generator can reach up to 3.5 A and the output voltage of up to 24 V. Note that the experiment tests were conducted in the residential area with limited straight line road. The output current and voltage might be greater if the test is performed on a full straight road and with optimum load.

These results were used as the data input and output for the ANN. All these input and output values were pre-processed to weight the data to have values between -1 and 1 . The simulation was performed with a fast training, which was located around 50 epochs to observe the simulation results with fast iterations.

Table 3 summaries the error values of the train and the test from the ANN. It shows that increasing the hidden neuron increases the values of R training and decreases those of RMSE training. This means that the network was able to accurately learn the training data sets. However, due to the lack of number of data sets for the training, the RMSE of the test values increases leading to greater error. This means that the present data sets for the training were not sufficient to handle the data test. As the results from the experimental vehicle were obtained from a dynamic, nonlinear condition, which might lead to greater uncertainty in the measured results; thus, sufficient data set for the training is highly important in this case.

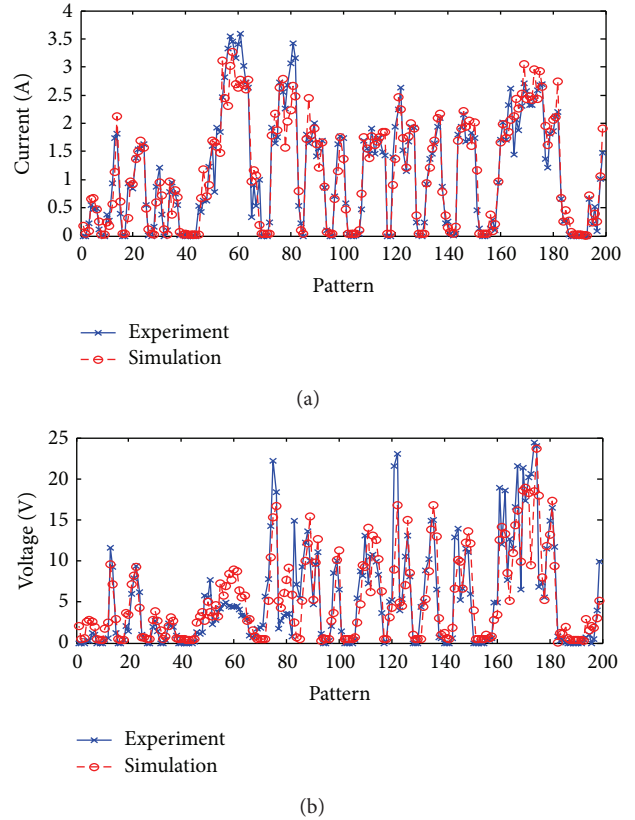

FIGURE 5: Comparisons of simulation train data and experimental results for current and voltage in 5 hidden neurons.

TABLE 3: Error values of the ANN approach for the output current and voltage used in training and test.

Neuron	R training	RMSE training	RMSE test
5	0.91777	2.164879	2.02931
6	0.924	2.09122	2.576063
10	0.9452	1.750057	4.447449
20	0.97384	1.087244	9.648938
30	0.98225	0.791896	19.30999

Comparisons between experimental results and ANN simulation for the output current and voltage in the data train sets using 5 hidden neurons are presented in Figure 5. It can be seen that the ANN simulates the two parameters for the entire range of the patterns with good agreement, although the number of the data training sets is only 199 patterns.

For the data test sets, comparisons between experimental results and ANN prediction for the output current and voltage using 5 hidden neurons are presented in Figure 6. The simulation can be seen to follow the trend of the experimental data, although disagreement can be observed for example between the 25th and 30th pattern, particularly for the output current in Figure 6(a) where the simulation overestimates the experimental result. To improve the prediction result, more data sets are therefore required.

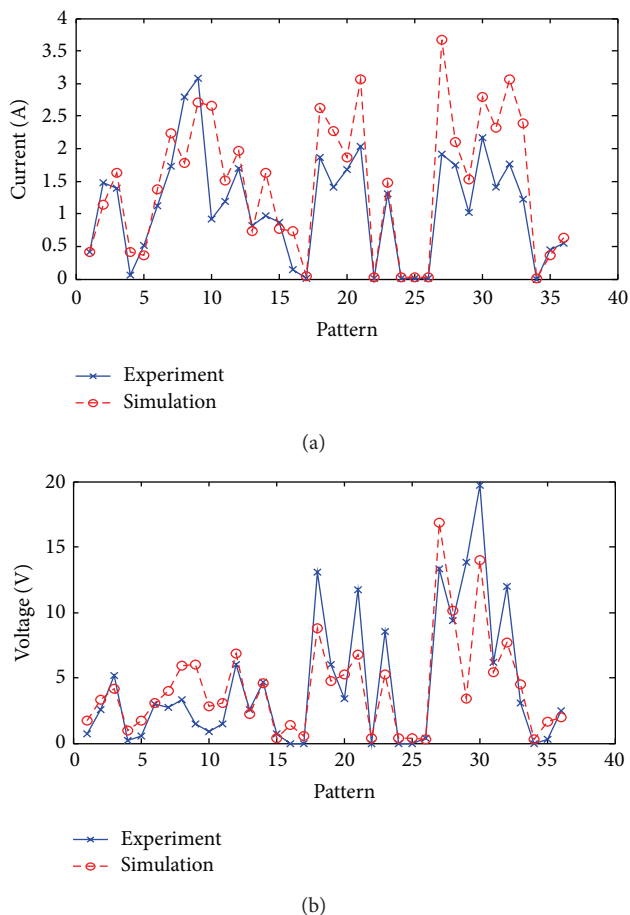

FIGURE 6: Comparisons of ANN predictions (test data) and experimental results for current and voltage in 5 hidden neurons.

5. Conclusions

Utilization of waste heat energy from the exhaust gas using a WHRM system in a spark ignition engine has been reported. The system has been proven to produce current up to 3.5 A and voltage up to 24 V at normal driving in rural environment. As many as 235 test data were used as the input for the ANN network where the ANN prediction has been shown to give reasonably good agreement with the measured data, although more data sets are required to improve the simulation. The proposed system could become a potential energy recovery that can be stored in the auxiliary battery to be used for electrical purposes such as air conditioning, power steering, or other electrical/electronic devices in an automotive vehicle.

Conflict of Interests

The authors declare that there is no conflict of interests regarding the publication of this paper.

Acknowledgment

The authors would like to acknowledge the Universiti Teknikal Malaysia Melaka (UTeM), for funding support

and facilities through the short-term research project no. PJP/2010/FKM(13B)/S00704.

References

- [1] R. E. Chammas and D. Clodic, "Combined cycle for hybrid vehicles," SAE Paper 2005-01-1171, 2005.
- [2] Z. Peng, T. Wang, Y. He, X. Yang, and L. Lu, "Analysis of environmental and economic benefits of integrated Exhaust Energy Recovery (EER) for vehicles," *Applied Energy*, vol. 105, pp. 238–243, 2013.
- [3] Y. Y. Hsiao, W. C. Chang, and S. L. Chen, "A mathematic model of thermoelectric module with applications on waste heat recovery from automobile engine," *Energy*, vol. 35, no. 3, pp. 1447–1454, 2010.
- [4] C. Yu and K. T. Chau, "Thermoelectric automotive waste heat energy recovery using maximum power point tracking," *Energy Conversion and Management*, vol. 50, no. 6, pp. 1506–1512, 2009.
- [5] H. Lu, T. Wu, S. Bai et al., "Experiment on thermal uniformity and pressure drop of exhaust heat exchanger for automotive thermoelectric generator," *Energy*, vol. 54, pp. 372–377, 2013.
- [6] D. H. Lee, J. S. Lee, and J. S. Park, "Effects of secondary combustion on efficiencies and emission reduction in the diesel engine exhaust heat recovery system," *Applied Energy*, vol. 87, no. 5, pp. 1716–1721, 2010.
- [7] V. Pandiyarajan, M. Chinna Pandian, E. Malan, R. Velraj, and R. V. Seeniraj, "Experimental investigation on heat recovery from diesel engine exhaust using finned shell and tube heat exchanger and thermal storage system," *Applied Energy*, vol. 88, no. 1, pp. 77–87, 2011.
- [8] F. Y. Lee, A. Navid, and L. Pilon, "Pyroelectric waste heat energy harvesting using heat conduction," *Applied Thermal Engineering*, vol. 37, pp. 30–37, 2012.
- [9] W. M. S. R. Weerasinghe, R. K. Stobart, and S. M. Hounsham, "Thermal efficiency improvement in high output diesel engines a comparison of a Rankine cycle with turbo-compounding," *Applied Thermal Engineering*, vol. 30, no. 14-15, pp. 2253–2256, 2010.
- [10] T. A. Horst, H.-S. Rottengruber, M. Seifert, and J. Ringler, "Dynamic heat exchanger model for performance prediction and control system design of automotive waste heat recovery systems," *Applied Energy*, vol. 105, pp. 293–303, 2013.
- [11] S. Quoilin, R. Aumann, A. Grill, A. Schuster, V. Lemort, and H. Spliethoff, "Dynamic modeling and optimal control strategy of waste heat recovery Organic Rankine Cycles," *Applied Energy*, vol. 88, no. 6, pp. 2183–2190, 2011.
- [12] P. Bombarda, C. M. Invernizzi, and C. Pietra, "Heat recovery from Diesel engines: a thermodynamic comparison between Kalina and ORC cycles," *Applied Thermal Engineering*, vol. 30, no. 2-3, pp. 212–219, 2010.
- [13] A. Boretti, "Recovery of exhaust and coolant heat with R245fa organic Rankine cycles in a hybrid passenger car with a naturally aspirated gasoline engine," *Applied Thermal Engineering*, vol. 36, no. 1, pp. 73–77, 2012.
- [14] C. Sprouse III and C. Depcik, "Review of organic Rankine cycles for internal combustion engine exhaust waste heat recovery," *Applied Thermal Engineering*, vol. 51, pp. 711–722, 2013.
- [15] J. Czarnigowski, "A neural network model-based observer for idle speed control of ignition in SI engine," *Engineering Applications of Artificial Intelligence*, vol. 23, no. 1, pp. 1–7, 2010.

- [16] S. W. Wang, D. L. Yu, J. B. Gomm, G. F. Page, and S. S. Douglas, "Adaptive neural network model based predictive control for air-fuel ratio of SI engines," *Engineering Applications of Artificial Intelligence*, vol. 19, no. 2, pp. 189–200, 2006.
- [17] Y.-J. Zhai and D.-L. Yu, "Neural network model-based automotive engine air/fuel ratio control and robustness evaluation," *Engineering Applications of Artificial Intelligence*, vol. 22, no. 2, pp. 171–180, 2009.
- [18] S. Shivakumar, P. Srinivasa Pai, and B. R. Shrinivasa Rao, "Artificial Neural Network based prediction of performance and emission characteristics of a variable compression ratio CI engine using WCO as a biodiesel at different injection timings," *Applied Energy*, vol. 88, no. 7, pp. 2344–2354, 2011.
- [19] H. M. Kamar, R. Ahmad, N. B. Kamsah, and A. F. Mohamad Mustafa, "Artificial neural networks for automotive air-conditioning systems performance prediction," *Applied Thermal Engineering*, vol. 50, no. 1, pp. 63–70, 2013.
- [20] H. Mohamed Ismail, H. K. Ng, C. W. Queck, and S. Gan, "Artificial neural networks modelling of engine-out responses for a light-duty diesel engine fuelled with biodiesel blends," *Applied Energy*, vol. 92, pp. 769–777, 2012.
- [21] T. F. Yusaf, D. R. Buttsworth, K. H. Saleh, and B. F. Yousif, "CNG-diesel engine performance and exhaust emission analysis with the aid of artificial neural network," *Applied Energy*, vol. 87, no. 5, pp. 1661–1669, 2010.
- [22] C. Sayin, H. M. Ertunc, M. Hosoz, I. Kilicaslan, and M. Canakci, "Performance and exhaust emissions of a gasoline engine using artificial neural network," *Applied Thermal Engineering*, vol. 27, no. 1, pp. 46–54, 2007.
- [23] G. Najafi, B. Ghobadian, T. Tavakoli, D. R. Buttsworth, T. F. Yusaf, and M. Faizollahnejad, "Performance and exhaust emissions of a gasoline engine with ethanol blended gasoline fuels using artificial neural network," *Applied Energy*, vol. 86, no. 5, pp. 630–639, 2009.
- [24] Y. Çay, A. Çiçek, F. Kara, and S. Sağıroğlu, "Prediction of engine performance for an alternative fuel using artificial neural network," *Applied Thermal Engineering*, vol. 37, pp. 217–225, 2012.
- [25] N. Kara Togun and S. Baysec, "Prediction of torque and specific fuel consumption of a gasoline engine by using artificial neural networks," *Applied Energy*, vol. 87, no. 1, pp. 349–355, 2010.

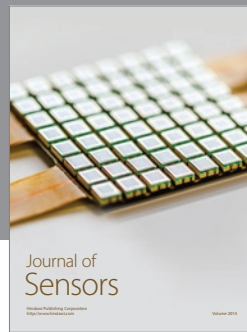
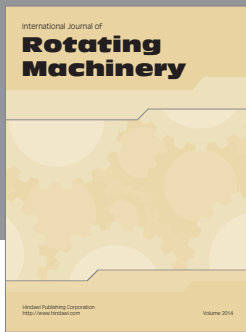

Hindawi

Submit your manuscripts at
<http://www.hindawi.com>

