

UTeM's Amphibious Hybrid Vehicle: Ride and Handling Analysis

Muhammad Zahir Hassan^{1,a}, Muhammad Zaidan Abdul Manaf^{1,b},
Mohd Shazni Halid^{1,c}, Muhammad Nadzeer Alehan^{1,d},
and Amjad Saddar Md Isa¹

¹Department of Automotive Engineering, Faculty of Mechanical Engineering, Universiti Teknikal
Malaysia Melaka Durian Tunggal 76100 Melaka, Malaysia

^azahir@utem.edu.my, ^bmuhammadzaidan@utem.edu.my, ^cb040910073@utem.edu.my,
^db040910206@utem.edu.my, ^eb040910104@utem.edu.my

Keywords: Ride and handling, buoyancy and stability, double lane change test, bounce sine sweep test

Abstract. The vehicle ride and handling analysis is one of the important aspects in vehicle dynamics. This paper takes a model of amphibious vehicle to establish the exact virtual behavior of vehicle's riding and handling base on the virtual design parameter. This vehicle can operate both on ground and water, therefore the analysis model is developed using seven degree of freedom model for ground operation and one degree of freedom model for water operation. The seven DOF are moment of roll, pitch, yaw and all four tires motion while the rest is buoyancy. Therefore, the ability and limitation of the vehicle demonstrate the behavior of unexpected case happened. These facts in turn to be used to improve the ride and handling level during acceleration, deceleration, cornering and step steer. The model also capable to function on the water where as the design of the body work considers the buoyancy concept for stability on every condition of wave surface. The analysis of buoyancy and stability for this model shows the vehicle ability to perform in the state of equilibrium condition under heeling and capsizing on water surface.

Introduction

Vehicle ride and handling is the description of the vehicle body and way vehicles wheel perform transverse to its effect and motion during accelerating, braking, cornering and swerving in form of roll, pitch and yaw moment [1]. The study of the ride and handling level for the amphibious is a complicated matter in the vehicle simulation. This is because the analysis is not only valid on the road surface or on the water, but it should be to control wisely. To stimulate the vehicle performance, the lumped single mass vehicle reference model is required. The analysis for this vehicle is conducted based on the lumped parameter model to stimulate driving characteristic of vehicle behavior accurately [2]. The mass acting on the vehicle should be taken out to verify the analysis which is classified into sprung (m_b) and unsprung mass (m_w) for body and wheel respectively. The equation of motion involving parameter like stiffness constant, damping ratio, wheel base, track width and moment inertia is considered in this model [3]. While in the water mode, the vehicle is simulate using Matlab software to analyze the buoyancy force on the water surface. The parameter of body hull is obtained from the equation of buoyancy equilibrium force base on the Archimedes principle where the weight of body is equal to the weight of water displaces [4].

Vehicle Modeling: Parameters of Studies

Road surface analysis. The simulation is conducted on the vehicle model using Mcs Carsim software. The centre of gravity position is obtained using equilibrium force and moment equation based on both front and rear tires. Fig. 1 shows the fitted amphibious vehicle body design with parameters and in Table 1 shows the constant parameters that appear in the vehicle. Based on lumped parameter in Fig. 1, two test of simulation is conducted with constant velocity 70km/h . The value of yaw angle and lateral force is obtained from double lane change test while pitch and roll angle value is collected base on the bounce sine sweep test.

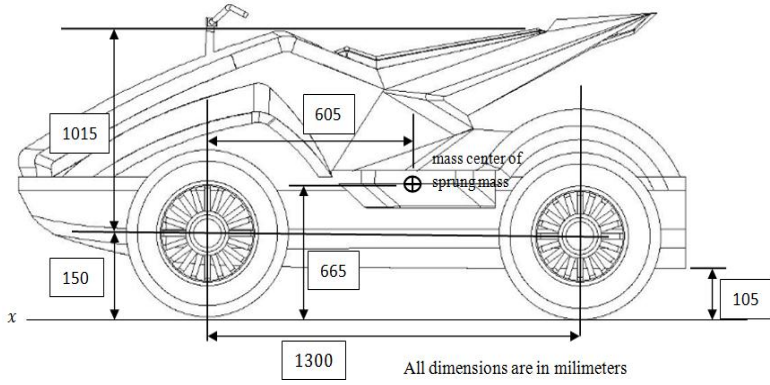

Fig. 1: Parameter of vehicle body model

Table 1: Constant parameter in vehicle

Parameter	Value
Track width	1.2 m
Sprung mass	400 kg
Roll inertia	200 kgm ²
Pitch inertia	1100 kgm ²
Yaw inertia	1100 kgm ²
Spring stiffness	20 kNm ⁻¹
Damping constant	2 kNsm ⁻¹
Tire stiffness	150 kNm ⁻¹

The results obtained from road surface simulation are roll, pitch & yaw angle and lateral force at each tire [5]. Fig. 2 shows the mathematical model of the vehicle for ride and handling analysis. Eq. 1 – 7 shows the vehicle model equations. The vehicle model should be consider as lumped mass model and equivalent with stiffness model [6]. The suspension between sprung mass and unsprung mass are modeled as passive viscous dampers and spring elements. [7] Table 2 shows the parameters description for each symbols for Eq. 1 – 7.

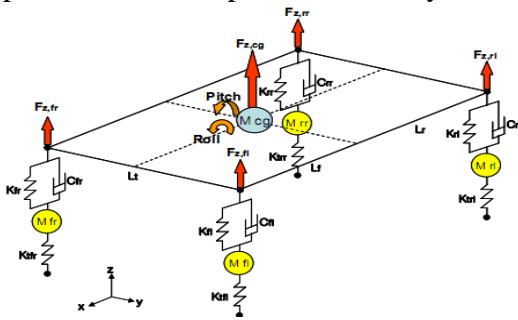

Fig. 2: Free body diagram of the vehicle.

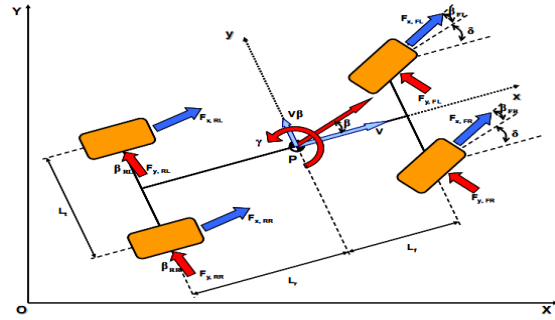

Fig. 3: Three degree of freedom of horizontal vehicle model.

To get the yaw value, it must have the slip between the tire and the road surfaces either the vehicle turning or taking corner. Fig. 3 shows an additional lateral force and there is the new degree of freedom for ride and handling analysis as in Eq. 8 – 10.

$$I_{xx}\ddot{\phi} = 0.5L_t F_{z,fl} - 0.5L_t F_{z,fr} + 0.5L_t F_{z,rl} - 0.5L_t F_{z,rr} + M_{\phi,l} + M_{\phi,r} \tag{1}$$

$$I_{yy}\ddot{\theta} = -L_f F_{z,fl} - L_f F_{z,fr} + L_r F_{z,rl} + L_r F_{z,rr} + M_{\phi,f} + M_{\phi,r} \tag{2}$$

$$I_{zz}\ddot{\psi} = L_f (F_{y,fl} - F_{z,fr}) - L_r (F_{u,rl} + F_{y,rr}) \tag{3}$$

$$m_w \ddot{z}_{w,fl} = F_{z,fl} - \frac{0.5M_{\theta,r}}{L_f + L_r} + \frac{0.5M_{\phi,r}}{L_t} + F_{t,fr} \tag{4}$$

$$m_w \ddot{z}_{w,fr} = F_{z,fr} - \frac{0.5M_{\theta,r}}{L_f + L_r} + \frac{0.5M_{\phi,l}}{L_t} + F_{t,fr} \tag{5}$$

$$m_w \ddot{z}_{w,rl} = F_{z,rl} + \frac{0.5M_{\theta,f}}{L_f + L_r} + \frac{0.5M_{\phi,r}}{L_t} + F_{t,rl} \tag{6}$$

$$m_w \ddot{z}_{w,rr} = F_{z,rr} + \frac{0.5M_{\theta,f}}{L_f + L_r} - \frac{0.5M_{\phi,l}}{L_t} + F_{t,rr} \tag{7}$$

$$m\ddot{x} = F_{x,fl} + F_{x,fr} + F_{x,rl} + F_{x,rr} \quad (8)$$

$$m\ddot{y} = F_{y,fl} + F_{y,fr} + F_{y,rl} + F_{y,rr} \quad (9)$$

$$I_{zz}\ddot{\psi} = L_f(F_{y,fl} + F_{y,fr}) - L_r(F_{y,rl} + F_{y,rr}) \quad (10)$$

Table 2: Explanation of symbols

Symbol	Parameter
I_{xx}, I_{yy}, I_{zz}	Longitudinal, lateral and vertical axis moment inertia
$\ddot{\phi}, \ddot{\theta}, \ddot{\psi}$	Roll, pitch and yaw angular acceleration
M, m_w	Total mass and wheel mass
\ddot{z}, \ddot{z}_w	Body and wheel vertical acceleration
L_f, L_r	Front and rear wheel base
$F_{z,fl}, F_{z,fr}, F_{z,rl}, F_{z,rr}$	Vertical force at each suspension
F_t	Vertical force at each tire
I_{zz}	vertical axis moment inertia
$\ddot{\psi}$	yaw angular acceleration
M, m_w	Total mass and wheel mass
\ddot{x}, \ddot{y}	Longitudinal and lateral axis acceleration
L_f, L_r	Front and rear wheel base
F_x, F_y	Longitudinal and lateral force of each tire

Water surface analysis. To simulate the ride and handling behavior on the water surface, the buoyancy and the stability analysis is performed using Archimedes principle. The total weight of the float object is equal to the buoyancy force acted as in Eq. 11 below.

$$F_B = F_G \quad (11)$$

where F_B is the buoyancy force and F_G is the total weight of the object on water. The Eq. 11 is used to obtain the parameter of the body hull for the generated design concept. Then, the design of the body is simulate using the Matlab software to verify the level of buoyancy and stability on the water surface accurately. Parameters in defining vehicle buoyancy are center of gravity and buoyancy, meta center, area and depth of the hull and the stabilization ability angle. The Eq. 11 is derived base on the buoyancy force equilibrium [8]. Eq. 12 shows the derivation to identify the area and depth of hull body in design generation.

$$\rho_{water} \times A \times L \times g = m_{vehicle}g \quad (12)$$

where A is the area of water surface, L is depth of water submerged, $m_{vehicle}$ is the maximum assumption vehicle mass which $400kg$ and g is the gravity acceleration $10ms^{-2}$. The value of A and L is the manipulated variable which is refer to the vehicle parameter. Fig. 4 shows the hull design with the value of surface area and length of depth and Table 4 shows the values of surface area and depth length of hull body base on three different concept designs.

Results

The result value of yaw angle and lateral acceleration for each tires was obtain from double lane change test in Carsim simulation. The unit of the angle is in radian. Fig. 5 shows the pattern of yaw angle of the vehicle during operations as taking a different lane before going back to the same lane after few seconds. It is stable with maximum speed without over steer out of lane in about 10 to 12

degree. However, during ongoing back to first lane, the vehicle encounters some yaw angle due to the lateral force acted by the front tire. Fig. 6 shows the graph of lateral force which effect from yaw moment due certain angle on the tire.

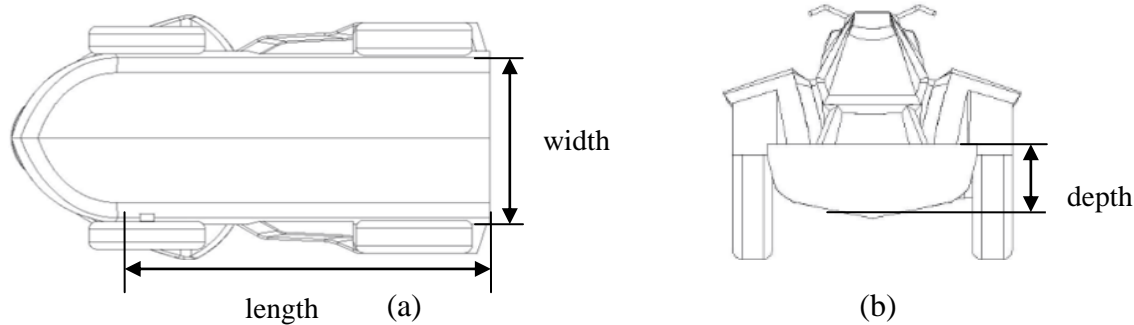

Fig. 4: Design of hull body; (a) Bottom view, (b) Rear view

Table 4: Value of surface area refers to the depth length.

Concept	Depth, L (m)	Area surface, A (m ²)	Length (m) × width (m)
1	0.45	0.89	2 × 0.45
2	0.30	1.33	2 × 0.67
3	0.20	2.00	2 × 1.00

Its mean, the tire was still back into equilibrium state after all of the force acted is resolved. L1, R1, L2 and R2 show the tire is at front left, front right, rear left and rear right respectively. When enter the second lane at the left side, the front tires play a role to turn left in certain angle and effect from that the force of body is focused on the right tire. Therefore, the lateral forces of tire on the right side have bigger value than the left side at the beginning.

While the result value of pitch and roll angle is obtain due to the bounce sine sweep test. Fig. 7 shows the graph pattern of pitch angle against with time. Later go through the bounce of bump, the angles starts to decay after 7 seconds and obey the under damped condition [9]. The value of pitch angle is quite bigger because the test uses high bumps in range of 0.7 - 0.8 radian in period of 3 to 6 seconds but it starting to decay after 7 seconds. After going through the bump with speed of 70km/h, the moment of pitch is bigger due to the force acted at high speed. Therefore, the pitch angle starts increasing to 1.5 radian in short gap before decaying to equilibrium state. Fig. 8 shows the pattern of roll angle against time. In roll moment, the amplitude is reach the maximum value which is 0.05 radian and starting to stable after 7 seconds. At the beginning the roll angle starting low followed by the sine bounce bump. When it reach the 3 seconds the roll angle start increasing with high degree amplitude which is 0.03 radian due to the force distribution from the both sides of tire and being stable at 7 seconds. The value of stiffness and damping constant at the vehicle affect the value of roll angle. The roll angle is smaller when using higher values of stiffness and damping constant.

There are four analyses which are yaw moment during taking cornering, roll and pitch moment during pass through the disturbance road and lateral forces of the four tires during some angle happen in cornering. The first two analyses are determined using double lane change test while the rest are determined using the bounce sine sweep test. The parameter of hull body is obtained from the Eq. 12 with three different values of depth which is referring to the density of fresh water which is 1000 kg/m³. Based on the equation, the surface area is inversely proportional to the density of water. The value in Table 3 shows of ideal area surface base on fresh water test. When the vehicle is modeled on the sea water or tropical water, the density is higher than fresh one. Therefore, the capability of body to float also becomes higher with using the constant area surface. In addition, the small value of gravity center height makes the vehicle become more stable on the water surface. Fig. 9 shows the graph of the buoyancy and the weight force acted on the vehicle using the third

concept. It turns out that the force of buoyancy was much bigger than the weight force acted by body in all time which assume the maximum mass of the vehicle is 400kg. The buoyancy force does not depend on the density of the submerged object but the force is only depends on the density of the water and the volume shape of the submerged object. As result, the floatability of this vehicle is based on fresh water density.

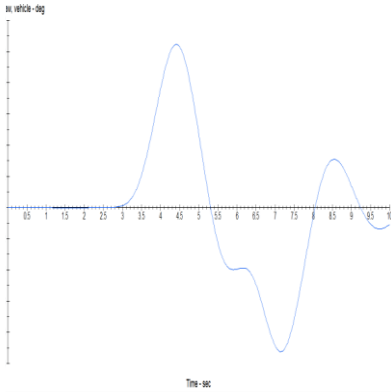

Fig. 5: Plot yaw angle against time.

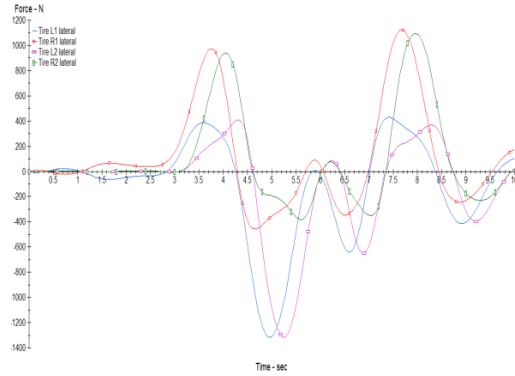

Fig. 6: Plot lateral force with time

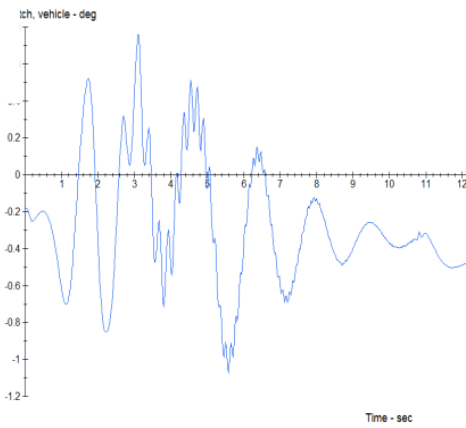

Fig. 7: Plot pitch(deg) against time.

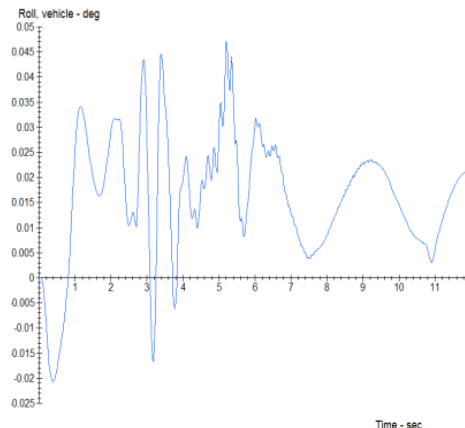

Fig. 8: Plot roll(deg) with time.

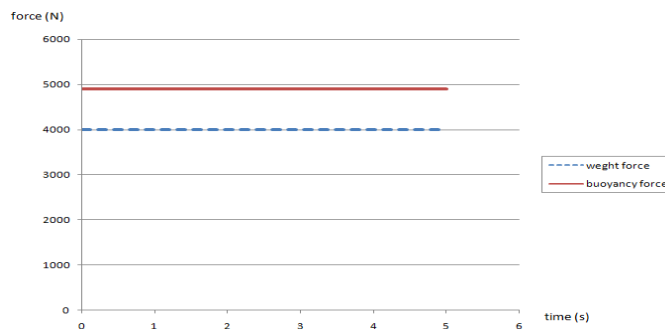

Fig. 9: Buoyancy and weight force of vehicle at water density $1000kgm^{-3}$

The vehicle was considered as 4000 N as the maximum weight. Despite that, the weight of the vehicle was taken to analyze on the water so that the vehicle was able to float. The analysis was held by using the fresh water as the reference which is density is equal to $1000kg/m^3$. The parameter of the vehicle was design and all of the three concepts are around $0.4m^3$. So that, using the Archimedes equation, the buoyancy force with normal gravity, fresh water and the volume displace (assume first with $0.4m^3$) is around 5000N. Therefore, there was comparison gap between the both forces. It is not meaning it like air balloon keep increasing at all time. When the object is in equilibrium, the object was half submerged and half rest on the top. In this case, when the buoyancy

force is much bigger, thus the floatability of the object become higher with the parameter and volume that have been set up. Both weight and buoyancy force was assumed as the density of water, gravity, volume and mass of object.

Conclusion

Analysis of vehicle's ride and buoyancy model were successfully done. In vehicle's ride analysis, 5 degree-of-freedom involve yaw analysis showed maximum yaw angle of 12 degrees in double lane change test. This results show good vehicle performance in performing such driving action. The other 2 degree-of-freedom involve in pitch and roll angles. From bounce sine sweep test, vehicle attain full stability from pitch and roll in 7 seconds which shows moderate performance of vehicle in pitch and roll driving action. Therefore this lack of performance will be enhanced in the next development of this research. Furthermore, new analysis of vehicle's buoyancy was made by using Archimedes principles. This research proves that floatability of amphibious vehicle is based on two parameters; water density and hull's surface area. Result shows that floatability of vehicle become higher in denser water compared to fresh water. Position of vehicle's center of gravity also play important role in providing stability during water operation.

Acknowledgement

This work is supported by the University Teknikal Malaysia Melaka (UTeM) through Short-Term Project PJP/2012/FKM(17C)/S01109 entitled "Development of Hybrid Amphibious Vehicle Propulsion System for Marine and Rescue Operation". This financial support is gratefully acknowledged.

References

- [1] Goh, M.Y., What is car handling, CATS Classified in The Straits Times (2010).
- [2] Lee, J.H., Lee, J.H. and Heo, S.J. Full Vehicle Dynamic Modeling for Chassis Controls. F2008-SC-021 (2008).
- [3] Kamalakannan K., ElayaPerumal A., Mangalaramanan S. and Arunachalam K., Performance Analysis and Behaviour Characteristics of CVD (Semi Active) in Quarter Car Model. (JJMIE) Vol. 5, No. 3, pp 261-265. (2011).
- [4] Yunus A. Cengel and John M. Cimbala. Fluid Mechanics: Fundamental and Application. New York: Mc Graw Hill (2nd Edi.). pp 97-105. (2010).
- [5] Vehicle Aerodynamic. World Congress. Cobo Center. SAE International. (SP-2066). Detroit MI, USA. (2007).
- [6] Dae Crolla A., Automotive Engineering Powertrain, Chassis System and Vehicle Body. Butterworth-Heinemann, 1st Ed. Oxford, UK. (2009).
- [7] Ahmad F., A. B. Kadir Z., Tamaldin N., Aparow V. R., Vehicle system Modeling and Simulation. Module 4. Penerbit Universitit, UTeM. (2012)
- [8] Kaarstad B., Aadnoy B. S., Theory and Application of Buoyancy in Wells. Model Applied Science. Vol. 5, N0. 3, June 2011, pp. 15-19. (2011).
- [9] Ogata K., Modern Control Engineering. United State, America. PEARSON. (5th Edi.). pp. 140-148. (2010)