

Reports

11-1985

**Baltimore Harbor and channels aquatic benthos investigations :
final technical report**

Robert J. Diaz
Virginia Institute of Marine Science

Linda C. Schaffner
Virginia Institute of Marine Science

Robert J. Byrne
Virginia Institute of Marine Science

Robert A. Gammisch
Virginia Institute of Marine Science

Follow this and additional works at: <https://scholarworks.wm.edu/reports>

 Part of the [Marine Biology Commons](#), [Sedimentology Commons](#), and the [Terrestrial and Aquatic Ecology Commons](#)

Recommended Citation

Diaz, R. J., Schaffner, L. C., Byrne, R. J., & Gammisch, R. A. (1985) Baltimore Harbor and channels aquatic benthos investigations : final technical report. Virginia Institute of Marine Science, College of William and Mary. <https://doi.org/10.25773/v5-6k0b-ec25>

This Report is brought to you for free and open access by W&M ScholarWorks. It has been accepted for inclusion in Reports by an authorized administrator of W&M ScholarWorks. For more information, please contact scholarworks@wm.edu.

Final Technical Report

Baltimore Harbor and Channels
Aquatic Benthos Investigations

Robert J. Diaz
Linda C. Schaffner
Robert J. Byrne
Robert A. Gammisch

Virginia Institute of Marine Science
College of William and Mary
Gloucester Point, VA 23062

Contract Monitor

Mr. Robert Blama

U.S. Army Corps of Engineers
Baltimore District
P.O. Box 1715
Baltimore, MD 21203

November 1985

TABLE OF CONTENTS

	Page
TABLE OF CONTENTS.....	i
PREFACE.....	iii
ACKNOWLEDGEMENTS.....	iii
LIST OF FIGURES.....	v
LIST OF TABLES.....	xiv
PART I INTRODUCTION.....	1
Background.....	1
Scope.....	1
PART II FIELD SAMPLING DESIGN.....	3
Overview.....	3
Cruise 1: Fall 1983.....	4
Cruise 2: Winter 1984.....	5
Cruise 3: Spring 1984.....	5
Cruise 4: Summer 1984.....	6
Cruise 5: Fall 1984.....	8
REMOTS Imagery.....	9
PART III METHODS.....	41
Positioning of Stations and Relocation.....	41
Field Methods.....	43
Laboratory and Quality Assurance Procedures.....	45
REMOTS.....	54
PART IV WOLF TRAP STUDY RESULTS AND DISCUSSION.....	64
Faunal Composition.....	64
Abundance.....	65
Diversity.....	66
Community Patterns.....	67
Species Patterns.....	69
REMOTS.....	71
Sediments.....	75
PART V RAPPAHANNOCK STUDY RESULTS AND DISCUSSION.....	167
Faunal Composition.....	167
Abundance.....	168
Diversity.....	169
Community Patterns.....	170
Species Patterns	171
REMOTS.....	172
Sediments.....	176

	Page
PART VI CONCLUSIONS	251
PART VII REFERENCES.....	254
APPENDICES.....	256

PREFACE

This report describes work performed by the Virginia Institute of Marine Science, School of Marine Science of the College of William and Mary, Gloucester Point, VA, to document the existing preoperational conditions at four locations in the Chesapeake Bay selected as possible dredged material disposal areas for the deepening of the Baltimore Channel. The work was sponsored by the Baltimore District Corps of Engineers.

The objectives of this work were at each of the four potential disposal sites:

- 1 - document the surface (0-15 cm) sediment conditions spatially and temporally.
- 2 - document macrobenthic communities spatially and temporally.
- 3 - empty the REMOTS sediment profile camera to document visible vertical sediment structure.

The Corps of Engineers contract monitor for the study was Mr. Robert Blama. We thank him for his continuous support throughout the project.

ACKNOWLEDGEMENTS

The results described in this report could not have been obtained without the dedicated efforts and teamwork of the many people who manned the vessels, or who carried the tons of bottom sediments retrieved, or who performed the tedious sorting and counting of the benthos, and analysis of the sediments.

Thanks are due to the captains and crews of the R/V TERN and R/V JOHN SMITH; George Pongonis, Charles Machen, Paul Oliver, Durand Ward, David

Rollins, Robert Hudgins, Richard Tomlinson, Ruth Williams, Sharon Miller, Daniel Gouge, Kenneth Worrell, James Cumbee, and Grover Lee Owens. To Jack Greer, professional cook, we offer special thanks.

To the scientific party, many of whom served on board and in the laboratory, we offer particular thanks. These were Kay Howard-Strobel, Rosalie Vogel-Cumbee, Tracy Eanes, Betty Bieri, Brett Burdick, Doug Huggett, B. K. Fowler, George LaPointe, Brian Meehan, Ken Finklestein, Jean Fulton, Roberto Llanso, Martha Norris, Leigh McDougal, John Fields, Ann Brewer, Irene Ulm, Joanna Bennett, and Ken Sulak. Cindy Fischler was in charge of the analysis of sediments, and Adam Frisch gave very generously of skills in developing computer software for data management and sediment analyses. Dr. David Evans generated the software for triangulation.

John Lunz and David Kendall of the Waterways Experimental Station assisted us on several cruises, in addition to performing the BRAT analyses. George Ruddy, of the U. S. Fish and Wildlife Service, provided assistance on two cruises. Special thanks are due to Joe Germano, President, and Dr. Don Rhoads and other staff of Marine Surveys, Inc., in their performance of REMOTS cruises and analysis. Robert Blama, Corps of Engineers, Baltimore District, was technical contract monitor. Throughout the study he provided very helpful guidance and assistance. As well, he assisted on the first cruise.

Shirley Sterling and Agnes Lewis typed the several reports generated in the course of the study.

To all of those above our special thanks.

LIST OF FIGURES

<u>Number</u>		<u>Page</u>
II-1A	Location of Wolf Trap Disposal Areas.....	10
II-1B	Location of Rappahannock Shoals Disposal Areas.....	11
II-2A	Sampling Grid at Wolf Trap Disposal Areas.....	12
II-2B	Sampling Grid at Rappahannock Shoals Disposal Areas.....	13
II-3	Station locations sampled during Fall, 1983 Cruise, No. 1; Wolf Trap Primary Disposal Area (upper), and Wolf Trap Alternate Disposal Area (lower). Scale 1:80,000.....	14
II-4A	Cruise 2, Winter, 1984. Stations sampled in the Rappahannock Shoals Deep Disposal Area (Primary, upper), and Rappahannock Shoals Alternate Disposal Area (lower). Scale 1:80,000.....	15
II-4B	Cruise 2, Winter, 1984. Stations sampled in the Wolf Trap Primary Disposal Area (upper), and Wolf Trap Alternate Disposal Area (lower). Scale 1:80,000.....	16
II-5A	Cruise 3, Spring 1984. Stations sampled in the Rappahannock Disposal Areas (Primary, Upper, and Alternate, lower).....	17
II-5B	Cruise 3, Spring, 1984. Grid sampling locations. See Figure II-5A for location within disposal area.....	18
II-5C	Cruise 3, Spring, 1984. Line sampling locations. See Figure II-5A for location within disposal area.....	19
II-5D	Cruise 3, Spring, 1984. Stations sampled in the Wolf Trap disposal areas. Scale 1:80,000.....	20
II-5E	Cruise 3, Spring, 1984. Grid sampling locations in Wolf Trap Primary Disposal Area. See Figure II-5D for location within disposal area.....	21
II-5F	Cruise 3, Spring, 1984. Line sampling stations in Wolf Trap Alternate Disposal Area. See Figure II-5D for location within disposal area.....	22
II-6A	Cruise 4, Summer, 1984. Stations sampled in the Rappahannock Disposal Areas. Note inclusion of stations on west fringe and external of Primary area (upper); RSS014, RSS074, RSS134 and RSP194, RSP204, and RSP214.....	23

<u>Number</u>		<u>Page</u>
II-6B	Cruise 4, Summer 1984. Stations sampled in the Wolf Trap areas.....	24
II-6C	Cruise 4, Summer 1984. Stations sampled in the Wolf Trap Disposal <u>test</u> site. See Figure II-6B for location in disposal area.....	25
II-6D	Cruise 4, Summer 1984. Stations sampled in the Wolf Trap Special Sand Search. See Figure II-6B for location within disposal area.....	26
II-6E	Cruise 4, Summer 1984. Stations sampled in Rappahannock Recon North (RRN), Rappahannock Recon South RRS, and Rappahannock Recon West-East, RWE.....	27
II-6F	Cruise 4, Summer, 1984. Stations sampled in Wolf Trap Recon South (WSP), and Wolf Trap East Recon (WER).....	28
II-6G	Cruise 4, Summer 1984. Stations sampled at Rappahannock Shoals Channels. See Figure II-6E for location.....	29
II-6H	Cruise 4, Summer 1984. Stations sampled at York Spit Channel. See Figure II-6F for location of grid.....	30
II-7A	Cruise 5, Fall, 1984. Stations sampled in the Rappahannock Disposal Areas.....	31
II-7B	Cruise 5, Fall, 1984. Stations sampled in the Wolf Trap Disposal Areas.....	32
II-7C	Cruise 5, Fall, 1984. Stations sampled in the Rappahannock Disposal Test Site. See Figure II-7A for location within disposal area.....	33
II-7D	Cruise 5, Fall, 1984. Stations sampled in the Wolf Trap Disposal Test Site. See Figure II-7B for location within disposal area.....	34
II-7E	Cruise 5, Fall 1984. High density sample locations at WTP10.....	35
II-7F	Cruise 5, Fall 1984. High density sample locations at WTP14.....	36
II-7G	Cruise 5, Fall 1984. Stations sampled at Rappahannock Recon North (RRN) and Rappahannock Recon South (RRS).....	37
II-7H	Cruise 5, Fall 1984. Stations sampled at Wolf Trap Recon South (WSP).....	38
II-7I	Cruise 5, Fall 1984. Stations sampled at Rappahannock Shoals Channels. See Figure II-7G for location.....	39

<u>Number</u>		<u>Page</u>
II-7J	Cruise 5, Fall 1984. Stations sampled at York Spit Channel. See Figure II-7H for location.....	40
III-1	Schematic of transponder installation for high density sampling at WTP10 (SIS) and WTP14 (TIP).....	58
III-2	United States Naval Electronics Laboratory spade box core. This core samples a surface area of 0.06 m ² to a maximum depth of 60 cm.....	58a
III-3	Samples resulting from the field processing of box core replicates A, B, and D.....	58b
III-4	Flowchart for sediment analyses.....	59
III-5	Regression of percent weight in 4 ϕ to 8 ϕ size range versus percent weight finer than 10 ϕ	60
III-6	Scatter plot of the <u>observed</u> percent weight finer than 10 ϕ (X), against the <u>predicted</u> percent weight finer than 10 ϕ	61
IV-1	Station cluster groups formed by classification of all stations for each cruise at the Wolf Trap Study Region.....	79
IV-2	Station cluster groups formed by classification of all cruises combined by station at the Wolf Trap Study Region.....	80
IV-3	Species cluster groups formed by classification of all stations for each cruise at the Wolf Trap Study Region.....	81
IV-4	Seasonal abundance of <u>Chaetopterus variopedatus</u> averaged by site, and disposal or fringe areas for Wolf Trap Study Region.....	82
IV-5	Seasonal abundance of <u>Clymenella zonalis</u> averaged by site, and disposal or fringe areas for Wolf Trap Study Region.....	83
IV-6	Seasonal abundance of <u>Listriella barnardi</u> averaged by site, and disposal or fringe areas for Wolf Trap Study Region.....	84
IV-7	Seasonal abundance of <u>Notomastus latericeus</u> averaged by site, and disposal or fringe areas for Wolf Trap Study Region.....	85

<u>Number</u>		<u>Page</u>
IV-8	Seasonal abundance of <u>Glycera americana</u> averaged by site, and disposal or fringe areas for Wolf Trap Study Region....	86
IV-9	Seasonal abundance of <u>Gyptis brevipalpa</u> averaged by site, and disposal or fringe areas for Wolf Trap Study Region....	87
IV-10	Seasonal abundance of <u>Ampelisca abdita</u> averaged by site, and disposal or fringe areas for Wolf Trap Study Region....	88
IV-11	Seasonal abundance of <u>Tubulanus pellucidus</u> averaged by site, and disposal or fringe areas for Wolf Trap Study Region.....	89
IV-12	Seasonal abundance of <u>Bhwanina goodei</u> averaged by site, and disposal or fringe areas for Wolf Trap Study Region....	90
IV-13	Seasonal abundance of <u>Macoma tenta</u> averaged by site, and disposal or fringe areas for Wolf Trap Study Region....	91
IV-14	Seasonal abundance of <u>Macoma</u> spp. averaged by site, and disposal or fringe areas for Wolf Trap Study Region.....	92
IV-15	Seasonal abundance of Total <u>Macoma</u> spp. averaged by site, and disposal or fringe areas for Wolf Trap Study Region....	93
IV-16	Seasonal abundance of <u>Nephtys picta</u> averaged by site, and disposal or fringe areas for Wolf Trap Study Region....	94
IV-17	Seasonal abundance of Nephtyidae averaged by site, and disposal or fringe areas for Wolf Trap Study Region.....	95
IV-18	Seasonal abundance of Total <u>Nephtys</u> spp. averaged by site, and disposal or fringe areas for Wolf Trap Study Region.....	96
IV-19	Seasonal abundance of <u>Loimia medusa</u> averaged by site, and disposal or fringe areas for Wolf Trap Study Region.....	97
IV-20	Seasonal abundance of <u>Paraprionospio pinnata</u> averaged by site, and disposal or fringe areas for Wolf Trap Study Region.....	98
IV-21	Seasonal abundance of <u>Glycinde solitaria</u> averaged by site, and disposal or fringe areas for Wolf Trap Study Region.....	99
IV-22	Seasonal abundance of <u>Sigambra tentaculata</u> averaged by site, and disposal or fringe areas for Wolf Trap Study Region.....	100
IV-23	Seasonal abundance of Cirratulids averaged by site, and disposal or fringe areas for Wolf Trap Study Region.....	101

<u>Number</u>		<u>Page</u>				
IV-24	Seasonal abundance of <u>Mulinia lateralis</u> averaged by site, and disposal or fringe areas for Wolf Trap Study Region.....	102				
IV-25	Seasonal abundance of <u>Polydora ligni</u> averaged by site, and disposal or fringe areas for Wolf Trap Study Region.....	103				
IV-26	Seasonal abundance of <u>Pseudeurythoe paucibranchiata</u> averaged by site, and disposal or fringe areas for Wolf Trap Study Region.....	104				
IV-27	Seasonal abundance of <u>Polycladia</u> averaged by site, and disposal or fringe areas for Wolf Trap Study Region.....	105				
IV-28	Seasonal abundance of <u>Acteocina canaliculata</u> averaged by site, and disposal or fringe areas for Wolf Trap Study Region.....	106				
IV-29	Seasonal abundance of <u>Listriella clymenellae</u> averaged by site, and disposal or fringe areas for Wolf Trap Study Region.....	107				
IV-30	Frequency distributions of boundary roughness values at the Wolf Trap Site from all four surveys. Note scale differences on the X axis between sampling times....	109				
IV-31	Frequency distributions of the mean RPD depths (cm) at the Wolf Trap Site for all surveys. Note the scale differences on the X and Y axes.....	111				
IV-32	Contour maps of RPD depth (1 cm intervals), averaged by station, at the Wolf Trap Site for each survey. The maps are arranged in the following order:					
	<table border="0" style="margin-left: auto; margin-right: auto;"> <tr> <td style="padding-right: 40px;">February</td> <td>May</td> </tr> <tr> <td>August</td> <td>October</td> </tr> </table>	February	May	August	October	
February	May					
August	October					
	Location of disposal area within the Wolf Trap site is shown approximately.....	113				
IV-33	Frequency distributions of the percentage areal cover of each 1 cm RPD contour interval at the Wolf Trap Site from February to October.....	115				
IV-34	Frequency distributions of benthic index values at the Wolf Trap Site from February to October. Note scale differences on the Y axis between graphs.....	117				
IV-35	Frequency distributions of boundary roughness values at the Wolf Trap Alternate Site. Note scale differences on the Y axis between sampling times.....	119				

<u>Number</u>		<u>Page</u>				
IV-36	Frequency distributions of the mean RPD depths (cm) at the Wolf Trap Alternate Site. Note the scale differences on the X and Y axes.....	121				
IV-37	Contour maps of RPD depths (1 cm intervals), averaged by station, at the Wolf Trap Alternate Site for each survey. The maps are arranged in the following order:					
	<table border="0" style="margin-left: auto; margin-right: auto;"> <tr> <td style="padding-right: 20px;">February</td> <td>May</td> </tr> <tr> <td>August</td> <td>October</td> </tr> </table>	February	May	August	October	
February	May					
August	October					
	Location of the disposal site within the Wolf Trap Alternate site is shown approximately.....	123				
IV-38	Frequency distributions of the percentage areal cover of each 1 cm RPD contour interval at the Wolf Trap Alternate Site from February to October.....	125				
IV-39	Frequency distributions of benthic index values at the Wolf Trap Alternate Site from February to October. Note scale differences on the Y axis between graphs.....	127				
IV-40	The distribution of sand in surface sediments in the Wolf Trap study region during November 1983 and February 1984.....	128				
IV-41	Map of the distribution of sediment types, lower Chesapeake Bay (from Byrne, et al., 1982).....	129				
IV-42	Distribution of sand content (0-5 cm horizon) in vicinity of WTP16.....	130				
IV-43	Wolf Trap Primary Disposal Area. Plot of percent weight sand in upper and lower horizons.....	131				
IV-44	Wolf Trap Alternate Disposal Area. Plot of percent weight sand in upper and lower horizons.....	132				
V-1	Station cluster groups formed by classification of all stations for each cruise at the Rappahannock Shoals Study Region.....	180				
V-2	Station cluster groups formed by classification of all cruises combined by station at the Rappahannock Study Region.....	181				
V-3	Species cluster groups formed by classification of all stations for each cruise at the Rappahannock Study Region.....	182				
V-4	Seasonal abundance of <u>Acteocina canaliculata</u> averaged by site, and disposal or fringe areas for the Rappahannock Shoals Study Region.....	183				

<u>Number</u>		<u>Page</u>
V-5	Seasonal abundance of <u>Ampelisca abdita</u> averaged by site, and disposal or fringe areas for the Rappahannock Shoals Study Region.....	184
V-6	Seasonal abundance of <u>Cistena gouldii</u> averaged by site, and disposal or fringe areas for the Rappahannock Shoals Study Region.....	185
V-7	Seasonal abundance of Total Nephthyids averaged by site, and disposal or fringe areas for the Rappahannock Shoals Study Region.....	186
V-8	Seasonal abundance of <u>Nephtys picta</u> averaged by site, and disposal or fringe areas for the Rappahannock Shoals Study Region.....	187
V-9	Seasonal abundance of Nephthyidae averaged by site, and disposal or fringe areas for the Rappahannock Shoals Study Region.....	188
V-10	Seasonal abundance of Total <u>Macoma</u> Spp. averaged by site, and disposal or fringe areas for the Rappahannock Shoals Study Region.....	189
V-11	Seasonal abundance of <u>Macoma tenta</u> averaged by site, and disposal or fringe areas for the Rappahannock Shoals Study Region.....	190
V-12	Seasonal abundance of Juvenile Pelecypoda averaged by site, and disposal or fringe areas for the Rappahannock Shoals Study Region.....	191
V-13	Seasonal abundance of <u>Mediomastus ambiseta</u> averaged by site, and disposal or fringe areas for the Rappahannock Shoals Study Region.....	192
V-14	Seasonal abundance of <u>Polydora ligni</u> averaged by site, and disposal or fringe areas for the Rappahannock Shoals Study Region.....	193
V-15	Seasonal abundance of <u>Sayella</u> spp. averaged by site, and disposal or fringe areas for the Rappahannock Shoals Study Region.....	194
V-16	Seasonal abundance of <u>Mulinia lateralis</u> averaged by site, and disposal or fringe areas for the Rappahannock Shoals Study Region.....	195
V-17	Seasonal abundance of <u>Lyonsia hyalina</u> averaged by site, and disposal or fringe areas for the Rappahannock Shoals Study Region.....	196

<u>Number</u>		<u>Page</u>				
V-18	Seasonal abundance of <u>Glycinde solitaria</u> averaged by site, and disposal or fringe areas for the Rappahannock Shoals Study Region.....	197				
V-19	Seasonal abundance of <u>Sigambra tentaculata</u> averaged by site, and disposal or fringe areas for the Rappahannock Shoals Study Region.....	198				
V-20	Seasonal abundance of <u>Paraprionospio pinnata</u> averaged by site, and disposal or fringe areas for the Rappahannock Shoals Study Region.....	199				
V-21	Seasonal abundance of <u>Pseudeurythoe paucibranchiata</u> averaged by site, and disposal or fringe areas for the Rappahannock Shoals Study Region.....	200				
V-22	Seasonal abundance of <u>Phoronis</u> spp. averaged by site, and disposal or fringe areas for the Rappahannock Shoals Study Region.....	201				
V-23	Frequency distributions of boundary roughness values at the Rappahannock Shoals Site. Note scale differences on X and Y axes between sampling times.....	203				
V-24	Frequency distributions of the mean RPD depths (cm) at the Rappahannock Shoals Site. Note the scale differences on the X and Y axes.....	205				
V-25	Contour maps of RPD depths (1 cm intervals), averaged by station, at the Rappahannock Site for each survey. The maps are arranged in the following order:					
	<table border="0" style="margin-left: auto; margin-right: auto;"> <tr> <td style="padding-right: 40px;">February</td> <td>May</td> </tr> <tr> <td>August</td> <td>October</td> </tr> </table>	February	May	August	October	
February	May					
August	October					
	Location of the disposal area within the Rappahannock Shoals Site is approximate.....	207				
V-26	Frequency distributions of the percentage areal cover of each 1 cm RPD contour interval at the Rappahannock Site from February to October.....	209				
V-27	Frequency distributions of benthic index values at the Rappahannock Site from February to October. Note scale differences in the X and Y axes between graphs.....	211				
V-28	Frequency distributions of boundary roughness values at the Rappahannock Alternate Site. Note scale differences on X and Y axes between sampling time.....	213				
V-29	Frequency distributions of the mean RPD depths (cm) at the Rappahannock Alternate Site for all surveys. Note the scale differences on the X and Y axes.....	215				

LIST OF TABLES

<u>Number</u>		<u>Page</u>
III-1	Values of R and I for Sand, Clay and Graphic Mean.....	62
III-2	Estimates of the Range and Industrial Statistic, I of % Sand, % Clay, and Graphic Mean.....	63
IV-1	Total taxonomic listing for both the Wolf Trap and Rappahannock Shoals Study Regions. Number are the total occurrences of the taxa at each site.....	133
IV-2	Mean abundance of dominants from the Wolf Trap Study region by season per 0.12 m ²	139
IV-3	Average abundance of dominant species from the Wolf Trap Study region for all cruises.....	141
IV-4	Community structure parameters for the Wolf Trap Study Region.....	144
IV-5	Ecological characteristics of dominant fauna collected from both the Wolf Trap and Rappahannock Study regions. Guild designations as in Fauchald and Jumars (1979). First letter - major feeding mode, second letter - motility mode. Position 1: B - subsurface deposit feeder, C - carnivore, F - filter feeder, S - surface deposit feeder, O - omnivore 2: D - discretely motile, M - motile, S - sessile.....	147
IV-6	Summary statistics and ANOVA results for boundary roughness, mean RPD depth, and benthic index values at the Wolf Trap Primary Site for all surveys.....	150
IV-7	Summary statistics and ANOVA results for boundary roughness, mean RPD depth, and benthic index values at the Wolf Trap Alternate Site for all surveys.....	151
IV-8	Weight percent of gravel, sand, silt and clay; by station...	152
IV-9	Total organic carbon, Wolf Trap Disposal Areas; Cruise 1 = Fall, 1983, Cruise 2 = Winter, 1984; Cruise 3 = Spring, 1984; Cruise 4 = Fall, 1984 (Stations without analyses coded 99999).....	165
V-I	Mean abundance of dominants ₂ from the Rappahannock Study region by season per 0.12 m ²	226
V-2	Average abundance of dominant species from the Rappahannock Study region for all cruises.....	227

<u>Number</u>		<u>Page</u>
V-3	Community structure parameters for the Rappahannock Shoals Study Region.....	229
V-4	Summary statistics and ANOVA results for boundary roughness, mean RPD depth, and benthic index values at the Rappahannock Shoals Site for all surveys.....	232
V-5	Summary statistics and ANOVA results for boundary roughness, mean RPD depth, and benthic index values at the Rappahannock Alternate Site for all surveys.....	233
V-6	Weight percent of gravel, sand, silt, and clay; by station...	234
V-7	Total organic carbon, Rappahannock Shoal disposal areas; Cruise 2 = Winter, 1984; Cruise 3 = Spring, 1984; Cruise 4 = Summer, 1984; Cruise 5 = Fall, 1984. (Stations without analyses coded 99999).....	248

BALTIMORE HARBOR AND CHANNELS AQUATIC BENTHOS INVESTIGATIONS

PART I: INTRODUCTION

Background

The Corps of Engineers is planning to deepen the main navigation channel in the Chesapeake Bay (the Baltimore Channel) from 42' to 50'. From the Virginia portion of the Bay approximately 33 million cubic yards of dredged material will need to be disposed of in two open water disposal areas.

Three channel reaches will be deepened. The Cape Henry channel at the mouth of the Bay is mostly sand. The York Spit channel ranges from sand to muddy sand. The Rappahannock Shoal channel is sandy mud. Some of the Cape Henry material will be stock piled for future beach nourishment but most of the dredged material from Cape Henry and all the material from the York Spit Channel will go to the Wolf Trap disposal area. The material from the Rappahannock Shoals Channel will go to the Rappahannock disposal area.

Since the benthos provided both; a very important trophic link between primary production in the Bay and commercial species harvested from the Bay, and the best biological indicator of dredging and disposal effects their existing preoperational conditions were evaluated. Sediments were also evaluated because of their close link to benthic community structure and function, and as an means to evaluate the potential stability and dispersion of the dredged material.

Scope

The environmental evaluation of existing conditions at the potential disposal sites included four major approaches. They were intended to

provide the background data needed to conduct an efficient and reactive monitoring program during the dredging operations:

- 1 - Quantitative box-coring for sediments
- 2 - Quantitative box-coring for macrobenthic community composition
- 3 - REMOTS sediment profile camera for in situ evaluation of vertical sediment structure
- 4 - Benthic Resource Assessment Technique (BRAT) for evaluating the relative resource value of benthos to fisheries species.

This report deals with the first three approaches. While we provided field support for the BRAT analysis the interpretation of BRAT is the subject of a separate report by Lunz and Kendall (1982), Kendall et al. (1984), and Kendall et al. (1985).

These four approaches will allow for the most comprehensive evaluation of existing conditions at the disposal sites and provide a solid baseline from which to judge effects of the disposal operation. Historical data of these types are an essential part of any environmental evaluation that hopes to at some point separate natural from unnatural variation.

PART II: FIELD SAMPLING DESIGN

Overview

Benthic sampling was conducted within four potential dredged material disposal sites in the Virginia Chesapeake Bay (Fig. II-1 A and B), and within a one nautical mile "fringe area" enclosing each site. As well, sampling was conducted in regions external of the disposal areas (site plus fringe). The purpose of this section is to explain the sampling layout for each of the five cruises conducted:

Cruise 1: Fall - November 1983

Cruise 2: ✓ Winter - February 1984

Cruise 3: Spring - May 1984

Cruise 4: ✓ Summer - August 1984

Cruise 5: Fall - October, November 1984

The sequence of sampling was designed to encompass the biological "seasons" important to the benthic communities. The sampling pattern varied between successive cruises in response to data obtained from previous cruises. All changes were made in accordance with plans agreed upon by the principal investigators and the contract technical monitor.

The initial framework of the sampling design was centered upon the disposal areas. As indicated in the contract scope of work a sampling grid was established as shown in Fig. II-2 A and B. In each of the disposal areas 36 sampling stations were identified. In addition, for each area two external sampling stations were established as control or reference stations. One-half of those stations within a disposal area were occupied for quantitative box-core sampling while all stations were to be occupied for REMOTS imagery.

For ease in logging samples a code was developed, as follows:

- * **Wolf Trap Primary Disposal Area**
Box-cores; Controls - WTC
Internal - WTP
REMOTS; WTS + WTP + WTC
- * **Wolf Trap Alternate Disposal Area**
Box-cores; Controls - WAC
Internal - WAP
REMOTS; WAS + WAP + WAC
- * **Rappahannock Shoals Primary Disposal Area**
Box-cores; Controls - RSC
Internal - RSP
REMOTS; RSS + RSP + RSC
- * **Rappahannock Shoals Alternate Disposal Area**
Box-cores; Controls - RAC
Internal - RAP
REMOTS; RAS + RAP + RAC

The code could then be expanded to cover replicate cores at a station (as many as four; A, B, C, D);

ie., RAPO4A

and the cruise number (1 through 5)

ie., RAPO4A2

RAPO4A2 would be interpreted as Rappahannock Shoals Alternate Area (RAP), station 04, replicate A, cruise 2 (winter, 1984).

Cruise 1: Fall 1983

This cruise was a shakedown cruise from 1 November to 15 November. Benthic box-core samples and REMOTS were executed from the 93 ft. R/V TERN. This cruise demonstrated that use of the NEL Deep-Sea Box-Corer was more effective than the Grey-O'Hara box-corer when operating from a large vessel. As well, this cruise demonstrated that dual ship operation was most effective to execute, separately, the REMOTS from the box-core sampling. Sampling was limited to the Wolf Trap Disposal Areas (Primary and

Alternate). The stations sampled are shown in Fig. II-3. The coordinates of the stations and those of later cruises are shown in Appendix A.

Cruise 2: Winter 1984

This cruise was executed in the period 1-10 February, 1984. All four disposal areas were sampled in the initial grid configuration (Fig. II-2A,B). The station positions occupied are shown in Figure II-4 A and B (and listed in Appendix A). This cruise served to define the gradients in sediment grain size and winter benthic assemblages.

Cruise 3: Spring 1984

Based upon the results of Cruise 2 in defining sediment and benthic faunal assemblage gradients the sampling pattern was modified, with concurrence of the technical contract monitor. The modification established stations which would be fixed and occupied throughout the study as a means of following temporal variations within the disposal areas. Other stations were randomly selected within the area to make a basic comparison between a type I fixed effects model, which is what the grid design is, and a type II random effects model. The remaining stations were arrayed in grids (7 x 4) and lines. The grid and line arrays were used to define spatial gradients at the scale of less than a kilometer. The intense cluster of stations at each of the sites was to determine the smaller scale spatial patterns to be expected along a transect. When the disposal operations start it is likely that a transect approach would be most effective in locating and tracking the movement of dredged material. We therefore needed to determine the natural variation to be expected at the scale of disposal, which is on the order of 100's of meters.

The cruise was conducted during the period 30 April - 10 May, 1984. The stations occupied and the number of cores at each station were as listed below, and locations are shown in Figure II-5A through II-5F:

Station Array -----	Number of Stations -----	Number of Cores per Station -----
Rappahannock Shoals		
Primary Area		
RCS Control	2	4
RSP Primary	9	4
RGP Grid	28	1
Rappahannock Shoals		
Alternate Area		
RAC Control	2	4
RAP Primary	9	4
RFP Random	4	4
RLP Line	15	1
Wolf Trap Primary Areas		
WTC Controls	2	4
WTP Primary	9	4
WGP Grid	28	1
Wolf Trap Alternate Area		
WAC Control	2	4
WAP Primary	8	4
WFP Random	4	4
WLP Line	9	1

Cruise 4: Summer 1984

This cruise was conducted during the period 6 through 16 August, 1984. The sampling design was again modified to incorporate new information obtained from previous cruises. Elements of change were discussed between the contract monitor and the principal investigators. Specifically these items included:

- a. The possibility that the Rappahannock Shoals Primary Area might be shifted to the west. Accordingly additional stations were located on the western side of that disposal area.

- b. A concentration of stations in the northeast corner of the Wolf Trap Primary Area which was identified as the area where initial disposal tests would be conducted.
- c. Additional stations in the vicinity of WTP16 where sampling in cruises 1 and 2 indicated an anomaly in sediment type.
- d. Addition of a station grid at a section of each of the channels to be dredged. The sections selected represented those likely to be dredged first in conjunction with the plume and sediment disposal monitoring. This work thus provided early baseline information at those sites.
- e. Additional reconnaissance lines of stations external to the four disposal areas. These lines provide further insight as to what degree the areas enclosed in the disposal areas are representative of the Bay stem bottom.

The stations occupied and the number of cores at each station are listed below, and the locations are shown in Figure II-6A through II-6H.

<u>Station Array</u>	<u>Number of Stations</u>	<u>Cores per Station</u>
Rappahannock Shoals Primary Area		
RCS Control	2	3
RSP Primary	9	3
RSS Westward	3	3
RSP Extension	3	3
Rappahannock Shoals Alternate Area		
RAC Control	2	3
RAP Primary	8	3
Rappahannock Shoals Channel Recon		
RCR	15	1
Rappahannock Recon North		
RRN	6	1
Rappahannock Recon South		
RRS	9	1

Rappahannock Recon West-East RWE	9	1
Wolf Trap Recon South WSP	9	1
Wolf Trap Recon East WER	6	1
York Spit Channel Recon YSC	12	1
Wolf Trap Disposal Area		
WTC Control	2	3
WTP Primary	9	3
WTT Disposal Test Site	6	1
WSR Sand Anomaly	15	1
Wolf Trap Alternate Disposal Area		
WAC Control	2	3
WAP Primry	8	3

Cruise 5: Fall 1984

The final cruise of the study was conducted during the period 29 October through 7 November, 1984. The sampling design was similar to that of Cruise 4. However, three important additions were incorporated. A station grid was added for the initial disposal tests at the Rappahannock Primary Area in the southeast corner. Moreover, in order to ascertain smaller scale variability, high density sampling was conducted at WTP14 and WTP10. In each case 18 cores were obtained within the 50 meter target radius of the stations.

The stations occupied and the number of cores at each station are listed below. The station positions are shown in Figures II-7A through 7J.

<u>Station Array</u>	<u>Number of Station</u>	<u>Cores per Station</u>
Rappahannock Shoals Primary Area		
RCS Control	2	3
RSP Primary	9	3
RSS Westward	3	3
RSP Estension	3	3
RTT Disposal Test Site	6	1
Rappahannock Shoals Alternate Area		
RAC Control	2	3
RAP Primary	8	3
Rappahannock Recon North		
RRN	3	1
Rappahannock Recon South		
RSS	9	1
Rappahannock Shoals Channel Recon		
RCR	15	1
Wolf Trap Primary Area		
WTC Control	2	3
WTP Primary	7	3
WTT Disposal Test Site	6	1
SIS High Density at WTP 10	18	1
TIP High Density at WTP 14	18	1
Wolf Trap Alternate Area		
WAC Control	2	3
WAP Primary	8	3
Wolf Trap Recon South		
WSP	3	1
York Spit Channel Recon		
YCS	12	1

REMOTS Imagery

With few exceptions REMOTS imagery was obtained following the same station locations listed for Cruises 1 through 5. In addition REMOTS imagery was obtained at all of the "secondary" stations in each of the four disposal areas.

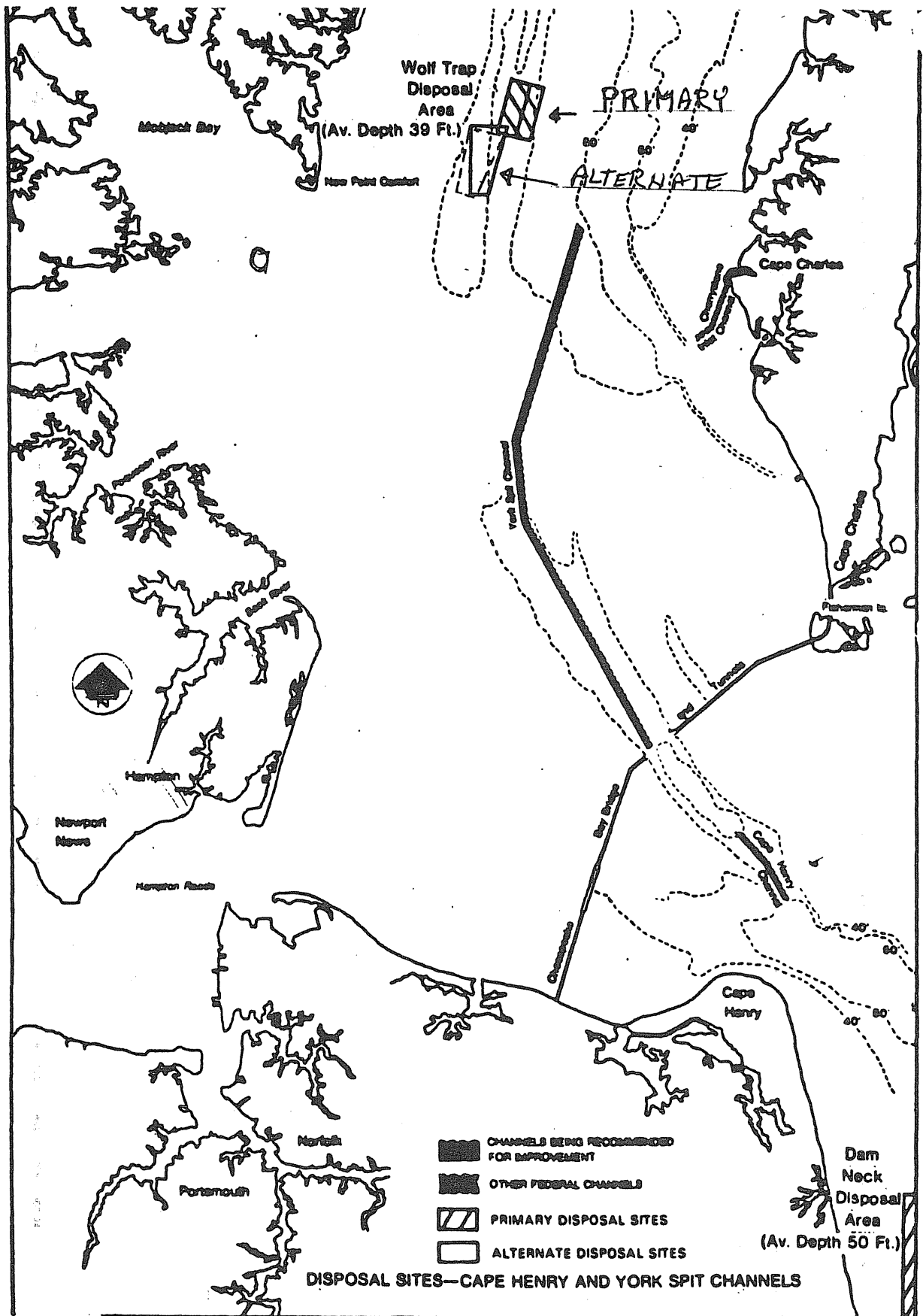

Figure II-1A. Location of Wolf Trap Disposal Areas.

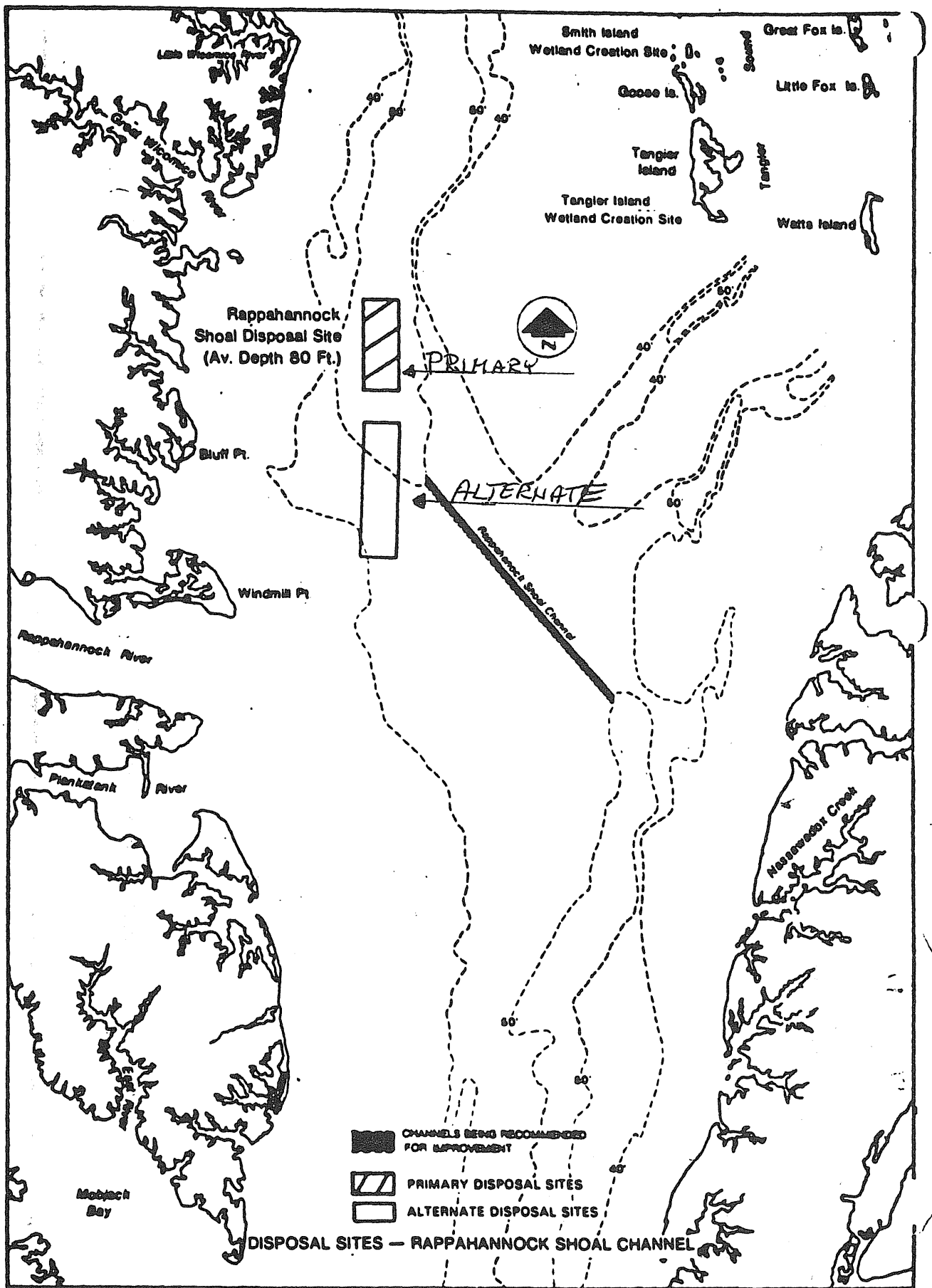

Figure II-1B. Location of Rappahannock Shoals Disposal Areas.

CFR Parts 220-229. Additional information regarding the regulations and requirements for use of the sites may be obtained from the Environmental Protection Agency (EPA). See U.S. Coast Pilot appendix for addresses of EPA offices.

Consult U.S. Coast Pilot 3 and 4 for important supplemental information.

general area of plashed by the NUA. by Commander C-7

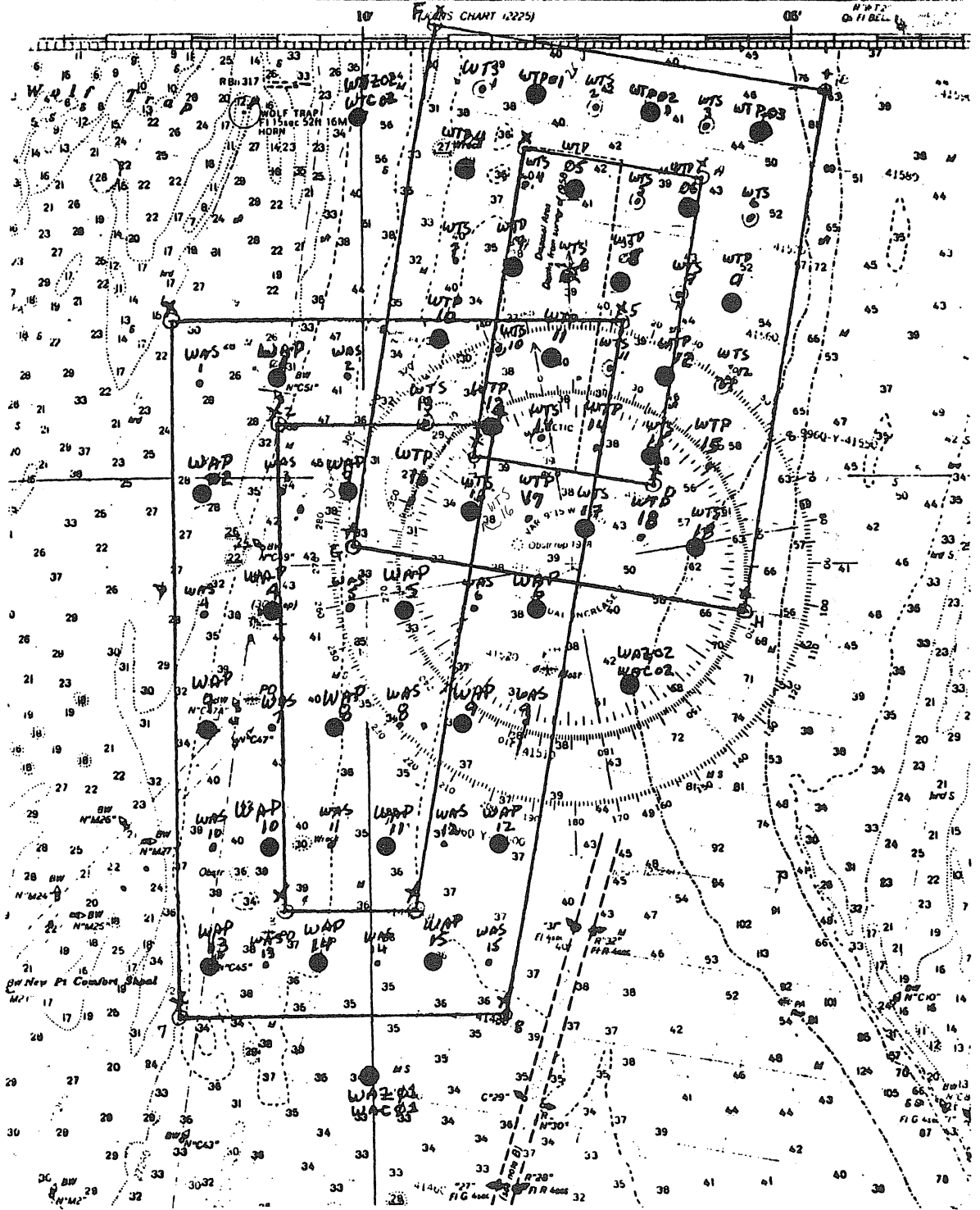

Figure II-2A. Sampling Grid at Wolf Trap Disposal Areas.

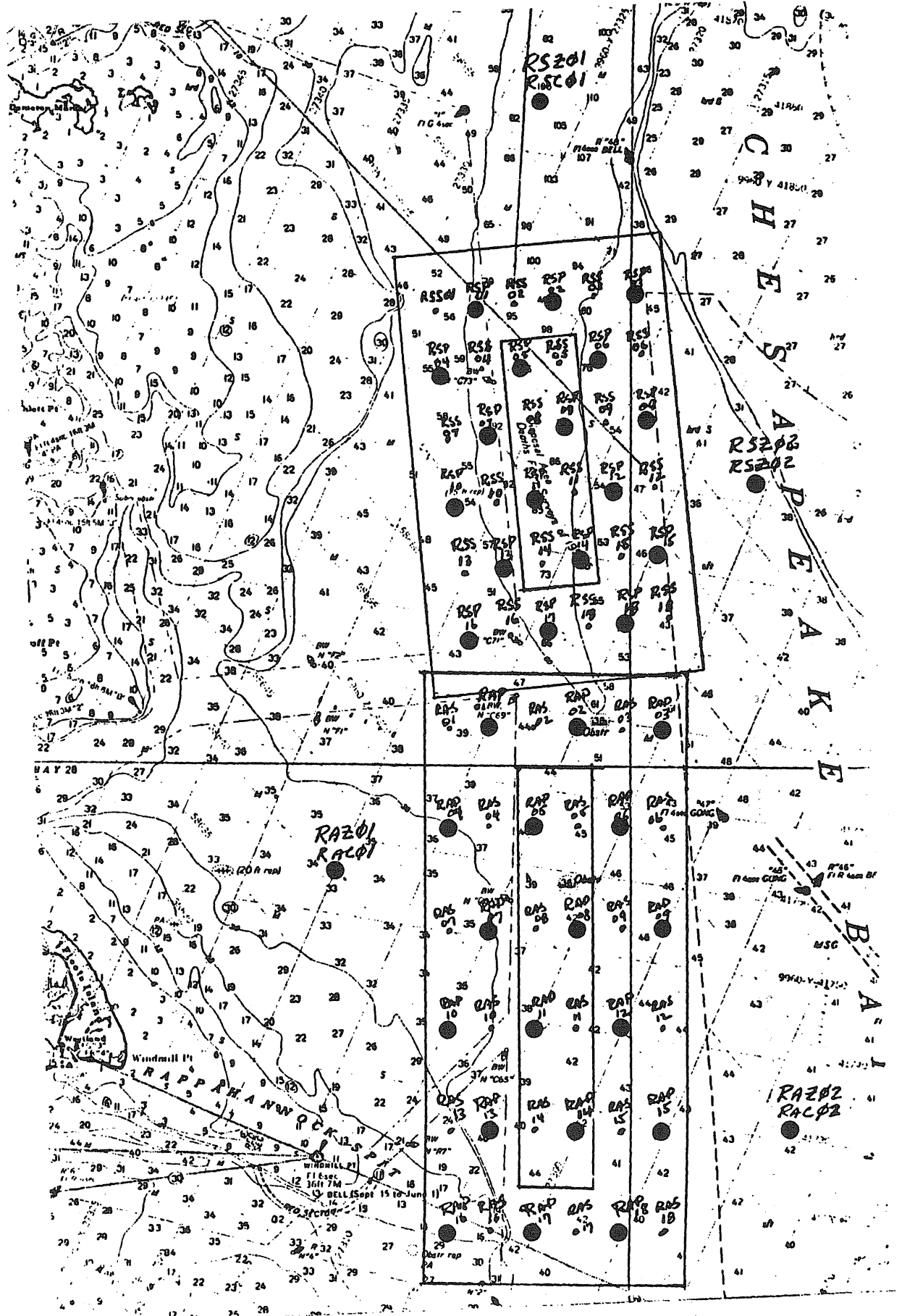

Figure II-2B. Sampling Grid at Rappahannock Shoals Disposal Areas.

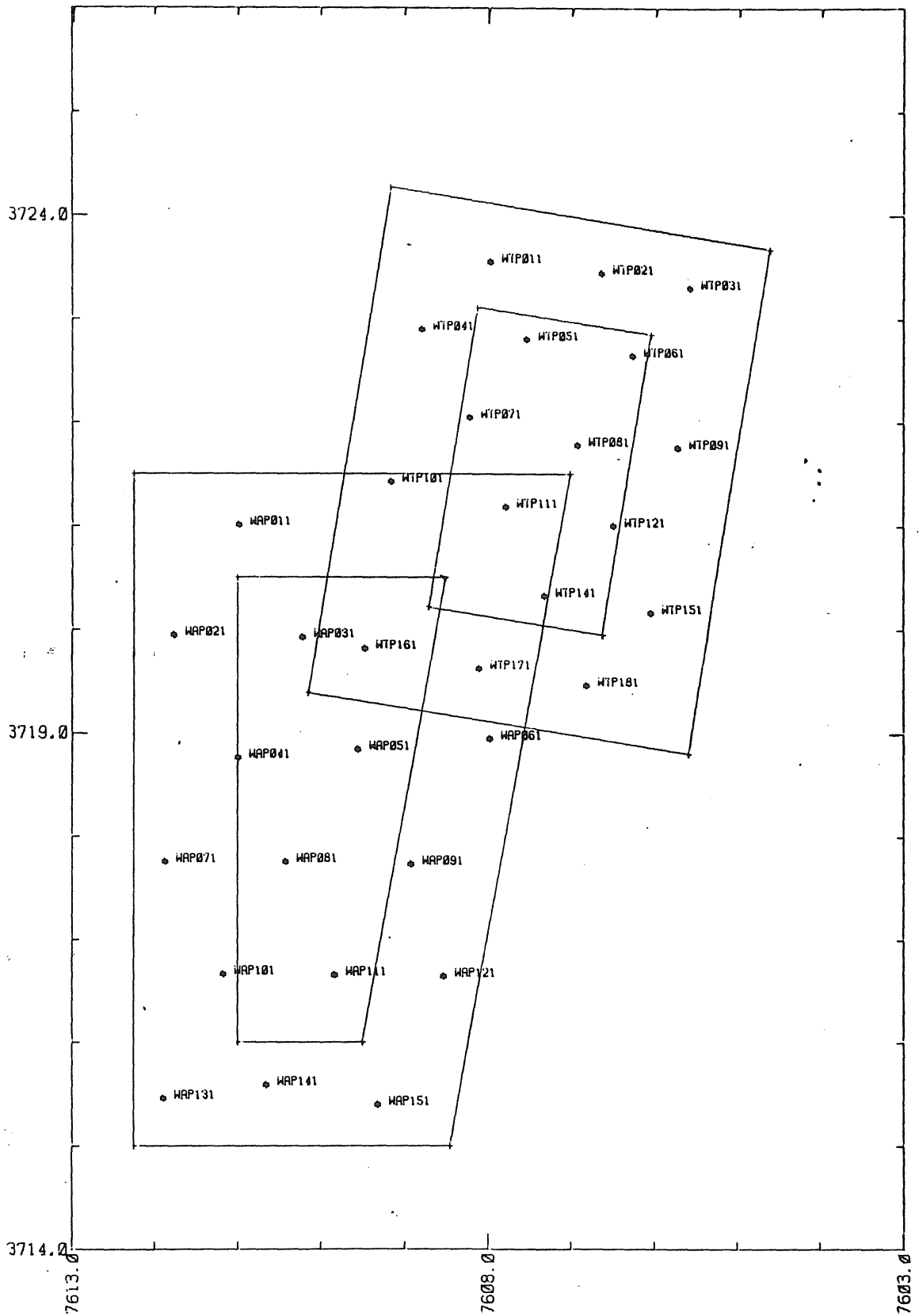
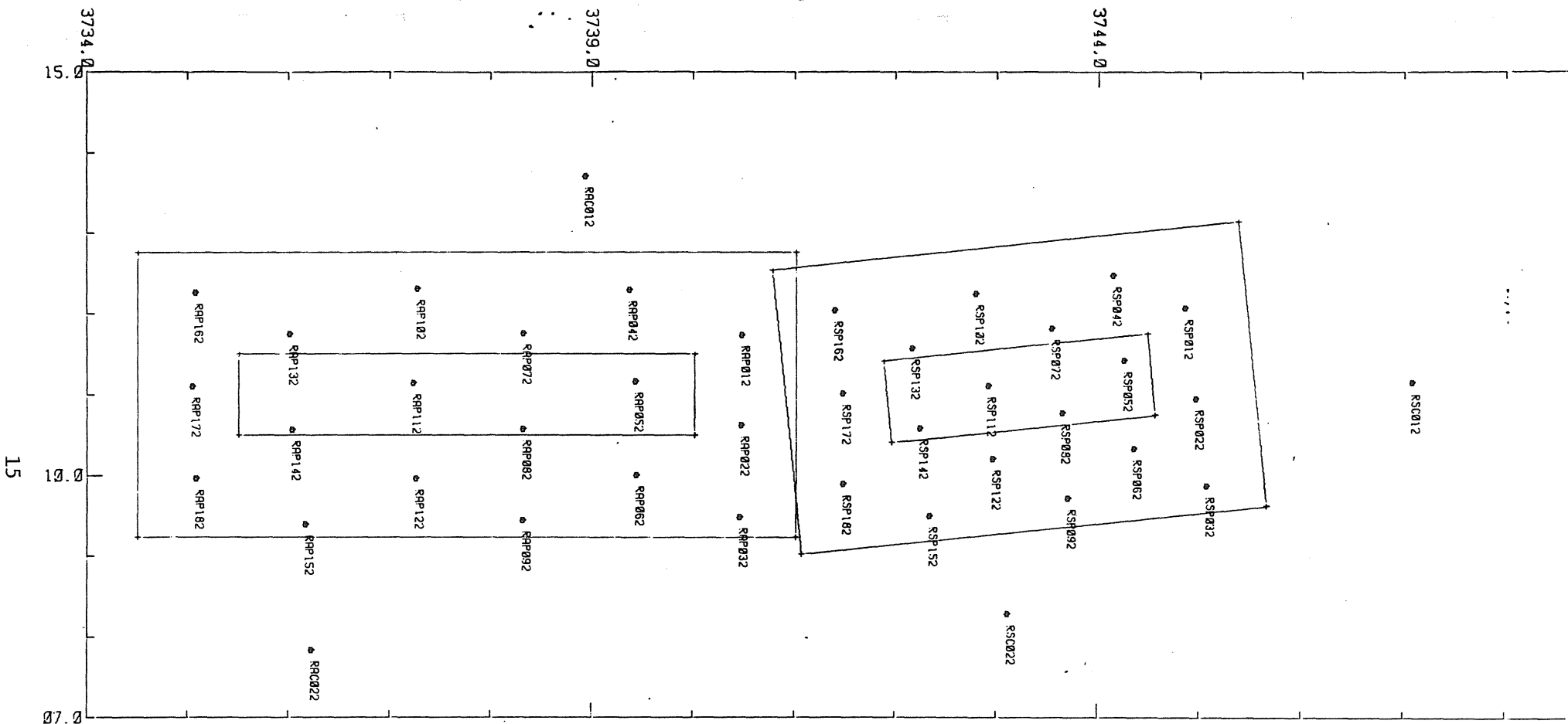

Figure II-3. Station locations sampled during Fall, 1983 cruise, No. 1; Wolf Trap Primary Disposal Area (upper), and Wolf Trap Alternate Disposal Area (lower). Scale 1:80,000.



40
 Figure II-4A. Cruise 2, Winter, 1984. Stations sampled in the Rappahannock Shoals Deep Disposal Area (Primary, upper), and Rappahannock Shoals Alternate Disposal Area (lower). Scale 1:80,000.

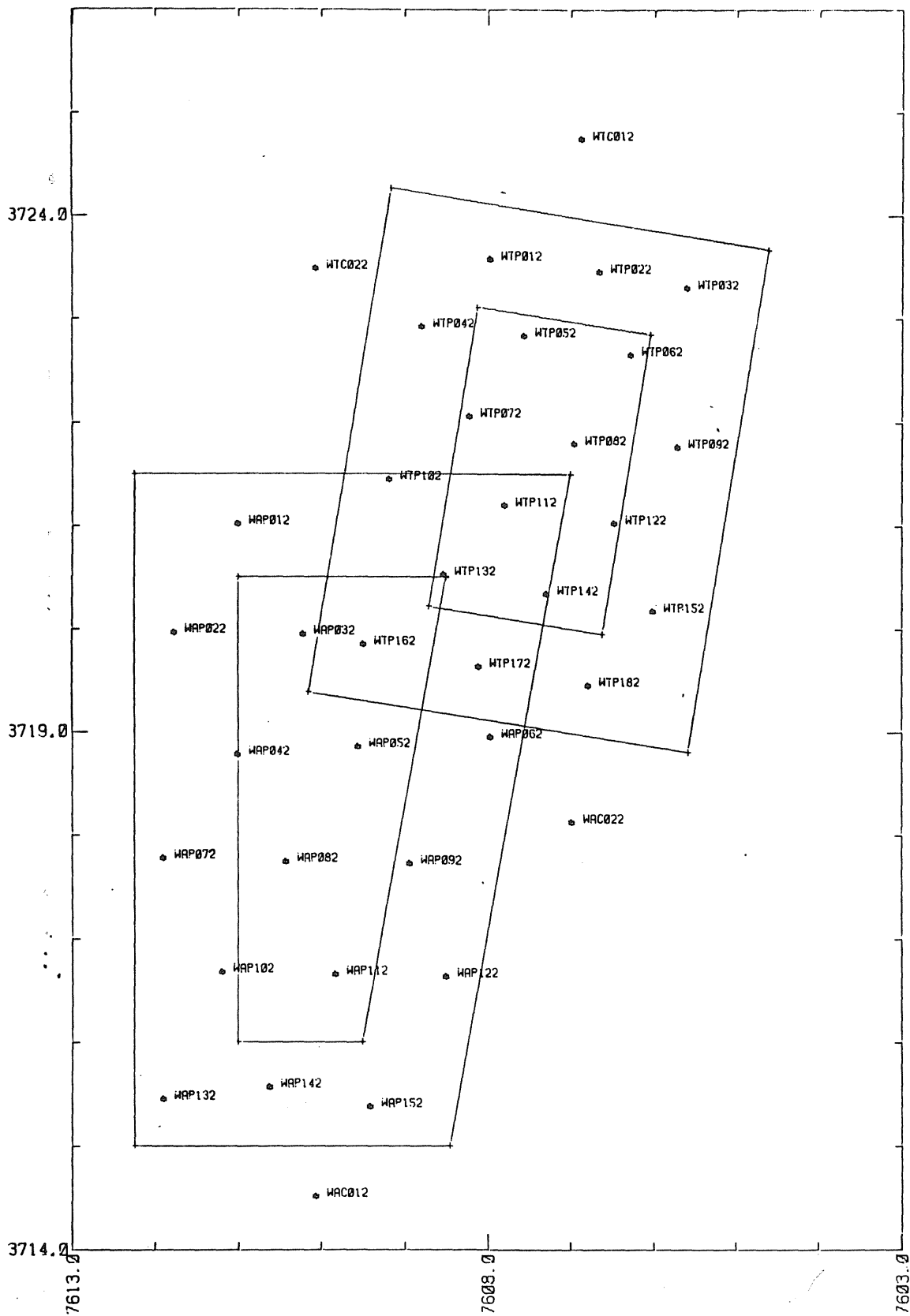

Figure II-4B. Cruise 2, Winter, 1984. Stations sampled in the Wolf Trap Primary Disposal Area (upper), and Wolf Trap Alternate Disposal Area (lower). Scale 1:80,000.

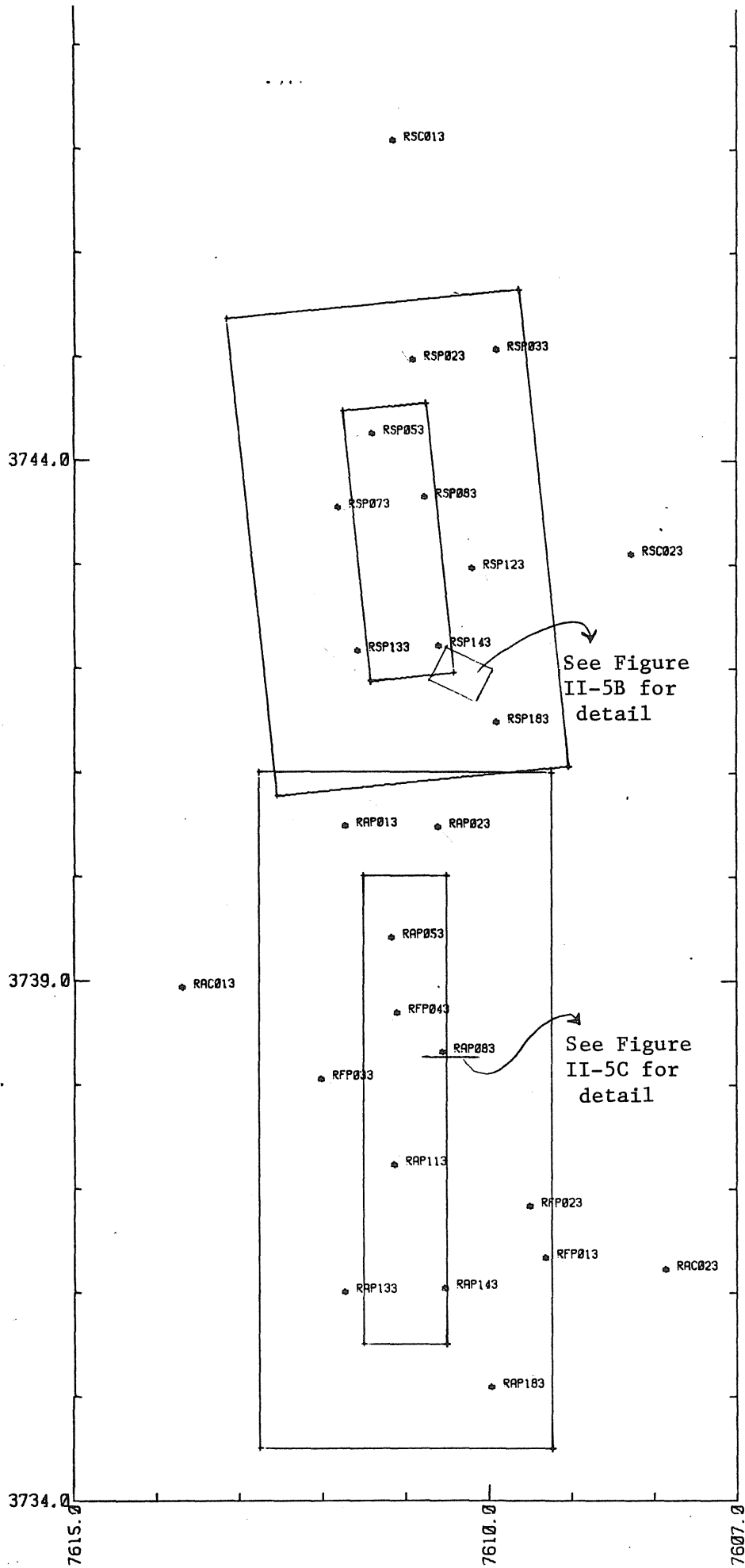

Figure II-5A. Cruise 3, Spring 1984. Stations sampled in the Rappahannock Disposal Areas (Primary, upper; and Alternate, lower).

25

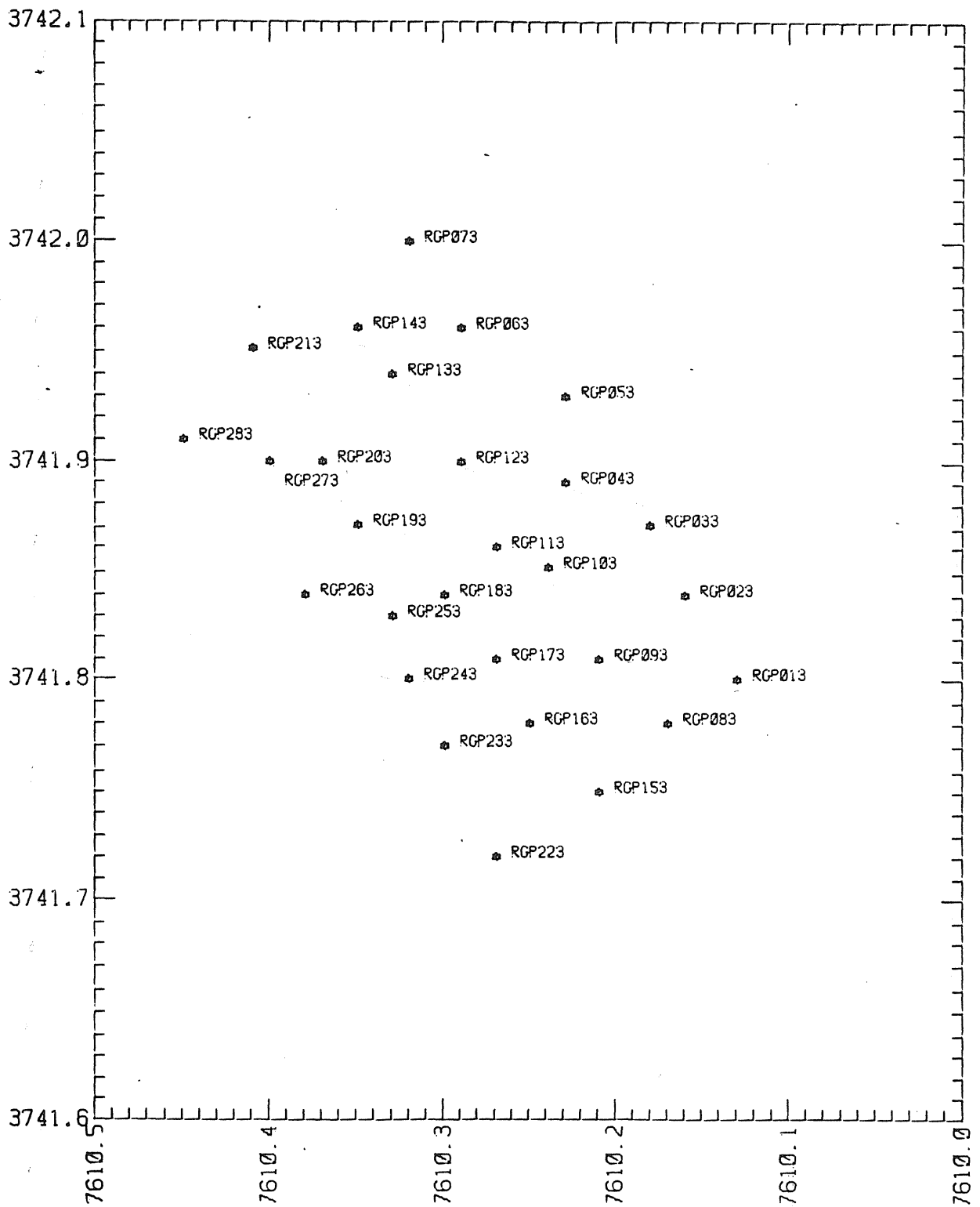

Figure II-5B. Cruise 3, Spring 1984. Grid sampling locations.
See Figure II-5A for location within disposal area.

28

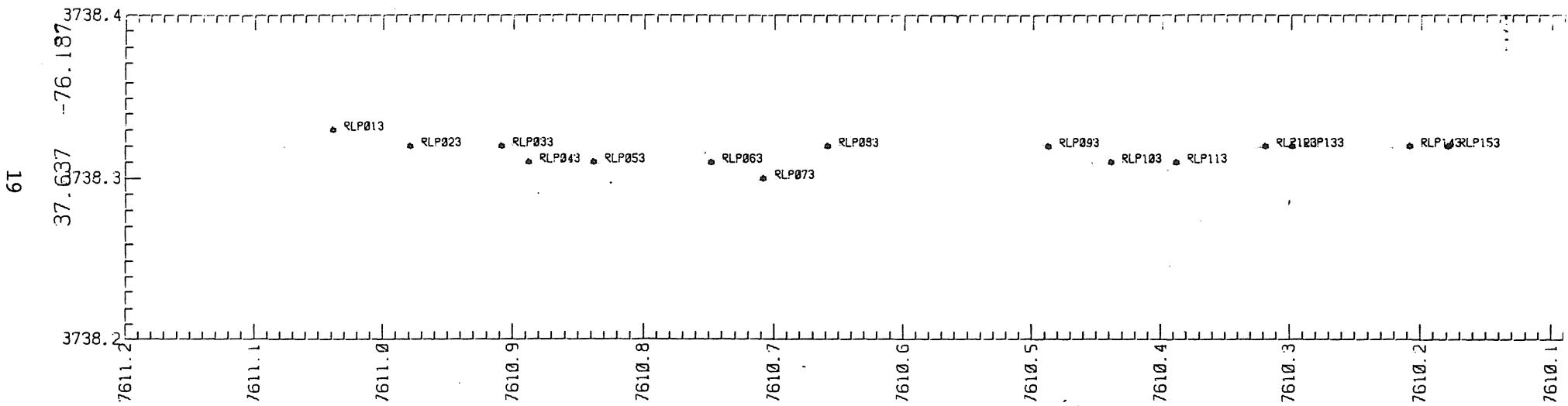

Figure II-5C. Cruise 3, Spring 1984. Line sampling locations. See Figure II-5A for location within disposal area.

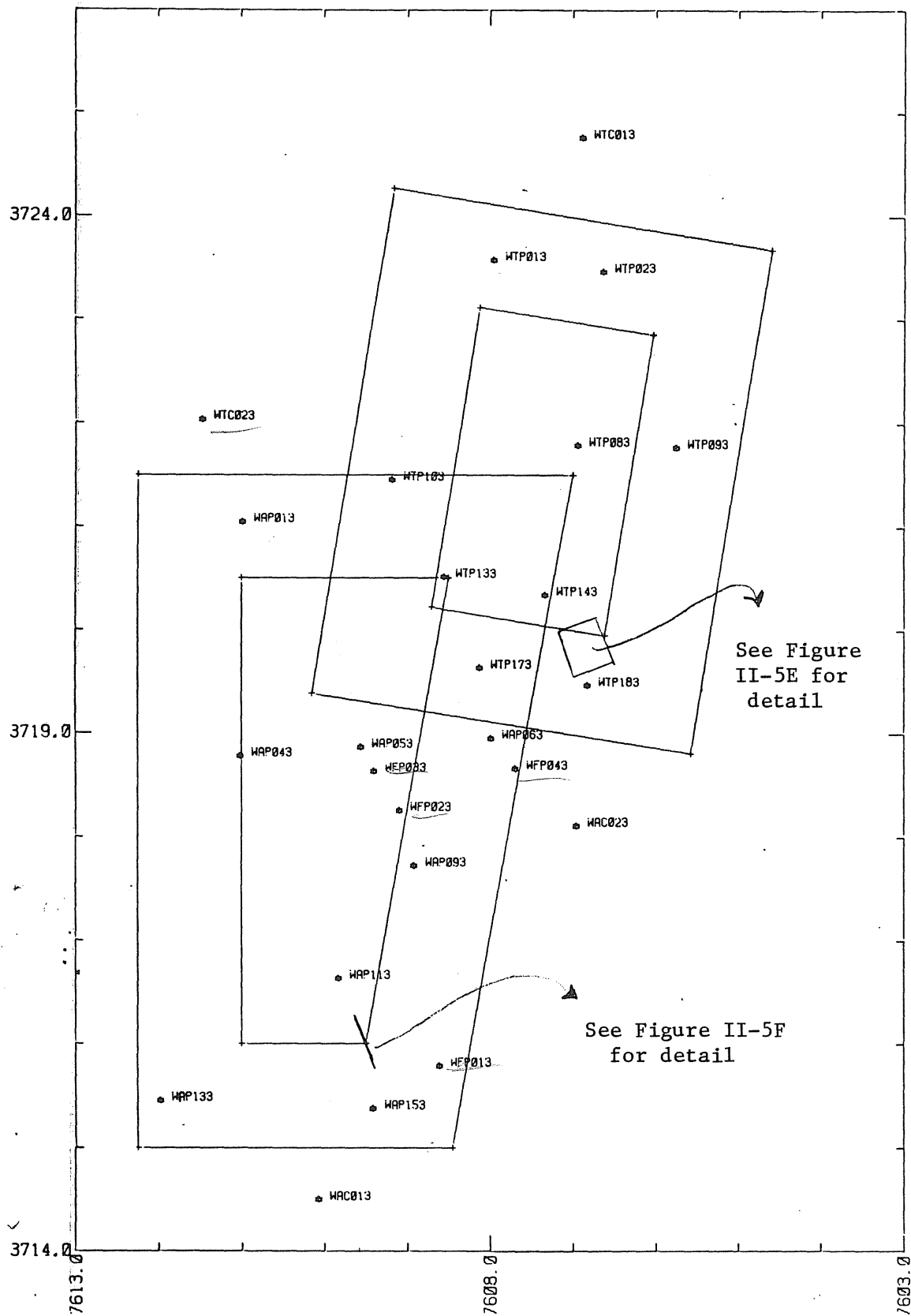

Figure II-5D. Cruise 3, Spring 1984. Stations sampled in the Wolf Trap Disposal Areas. Scale 1:80,000.

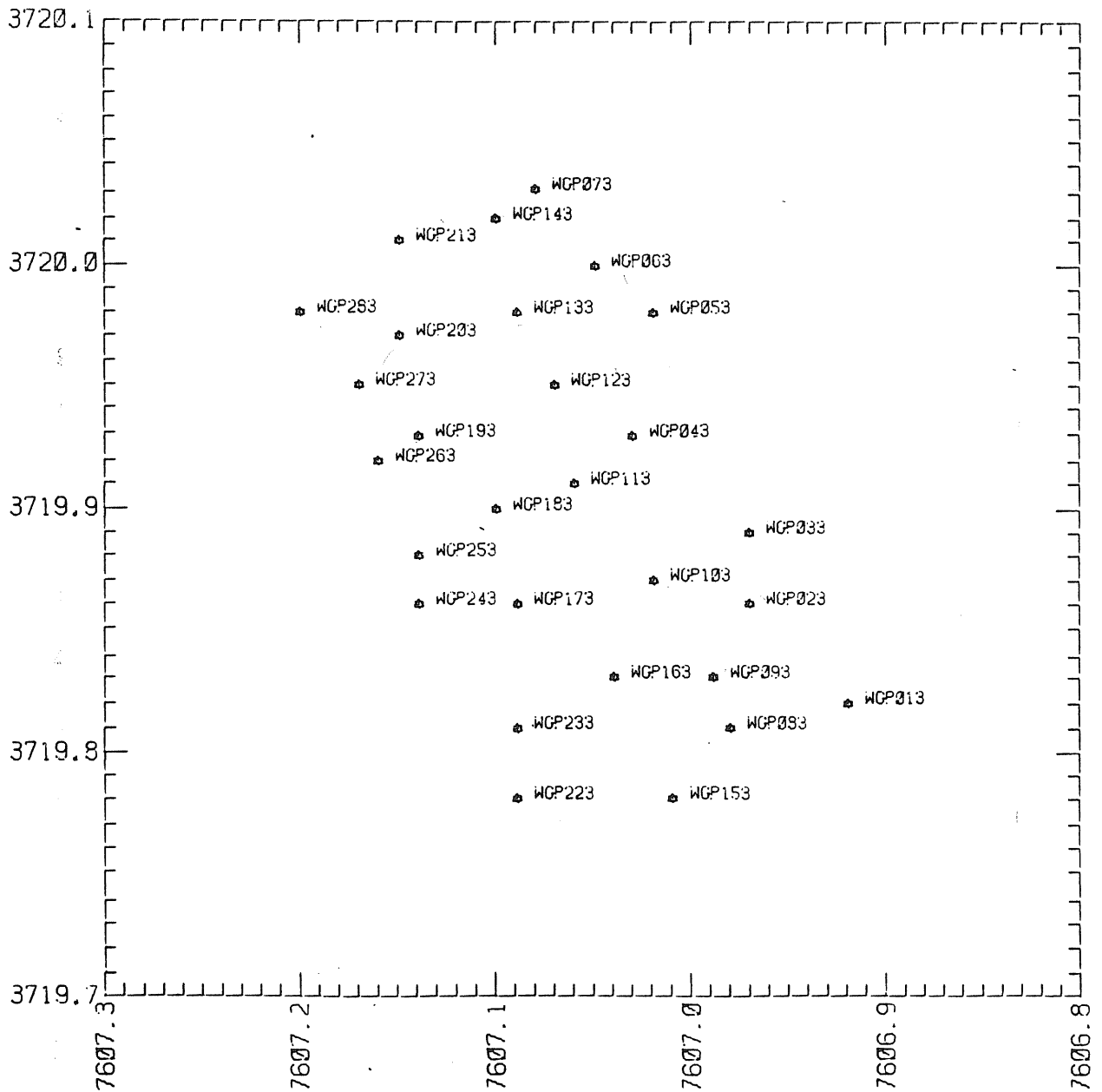

Figure II-5E. Cruise 3, Spring 1984. Grid sampling locations in Wolf Trap Disposal Area. See Figure II-5D for location within disposal area.

28

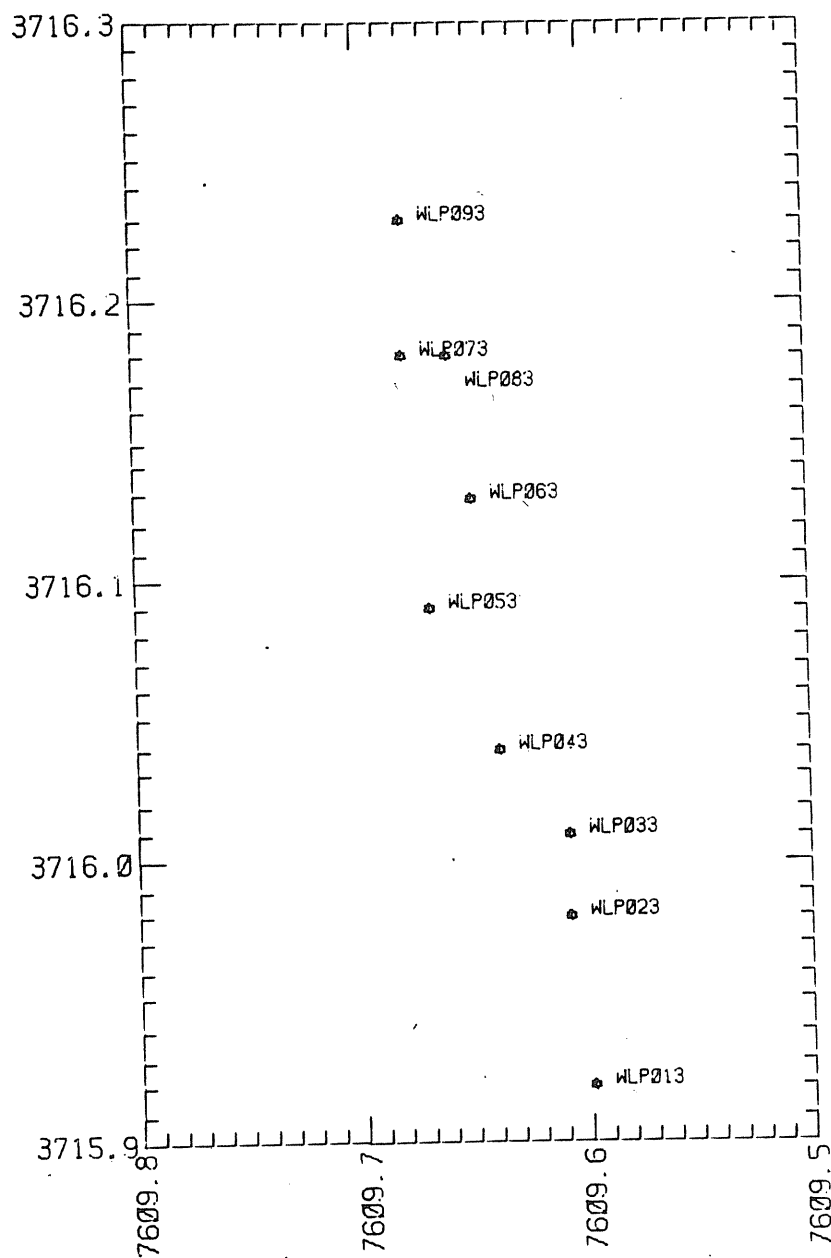

Figure II-5F. Cruise 3, Spring 1984. Line sampling stations in Wolf Trap Alternate Disposal Area. See Figure II-5D for location within disposal area.

9

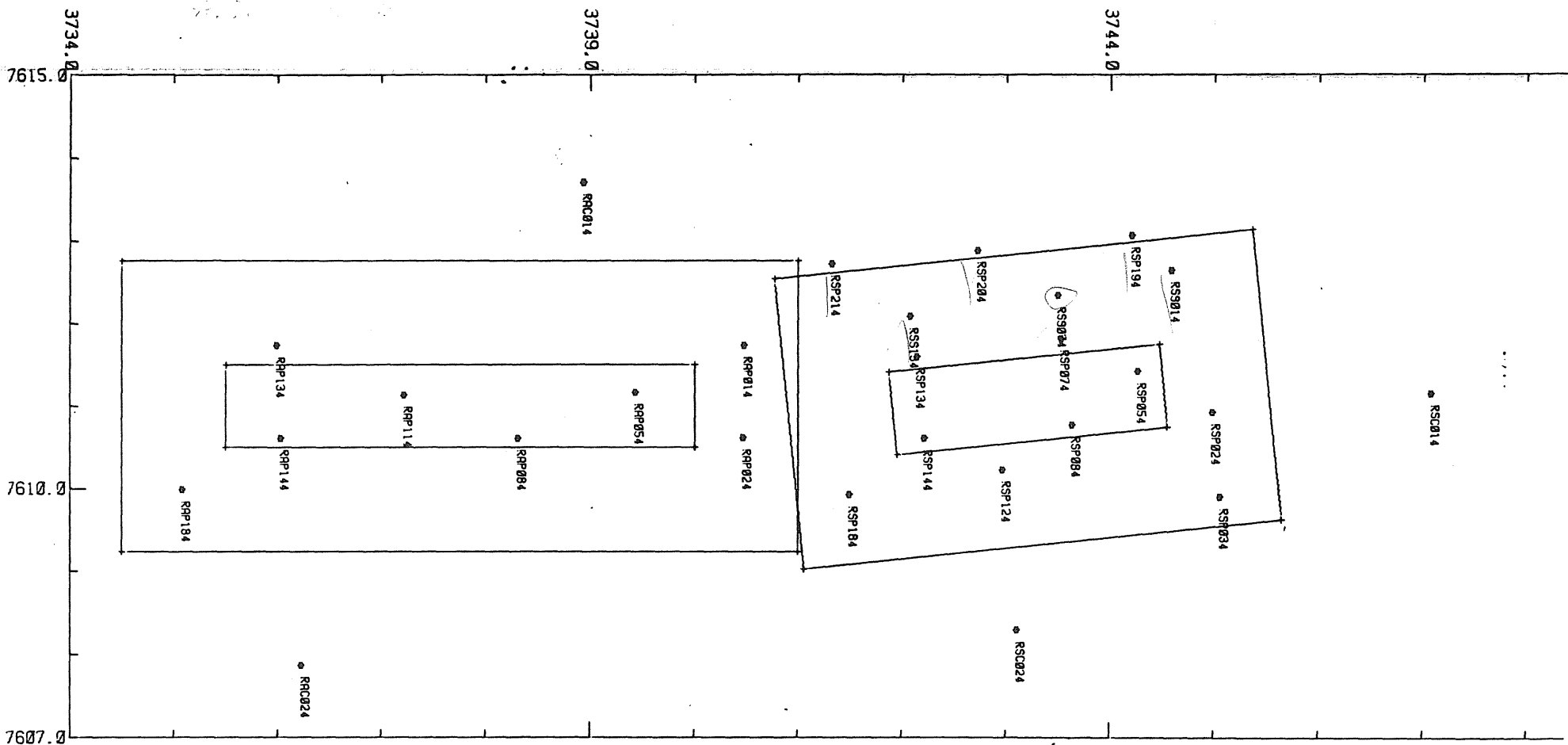

Figure II-6A. Cruise 4, Summer 1984. Stations sampled in the Rappahannock Disposal Areas. Note inclusion of stations on west fringe and external of Primary Area (upper); RSS 014, RSS 074, RSS 134 and RSP 194, RSP 204, and RSP 214.

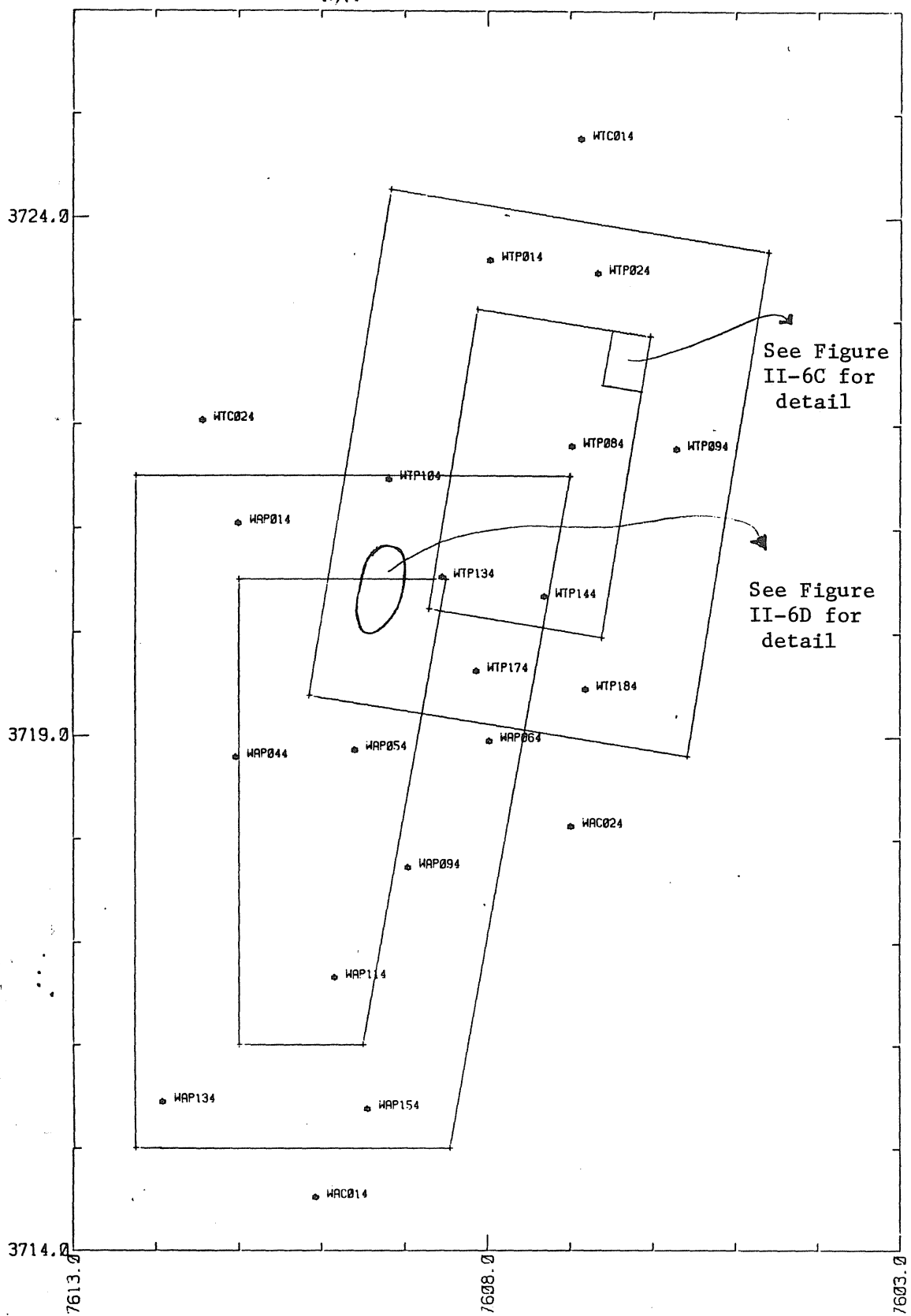

Figure II-6B. Cruise 4, Summer 1984. Stations sampled in the Wolf Trap Areas.

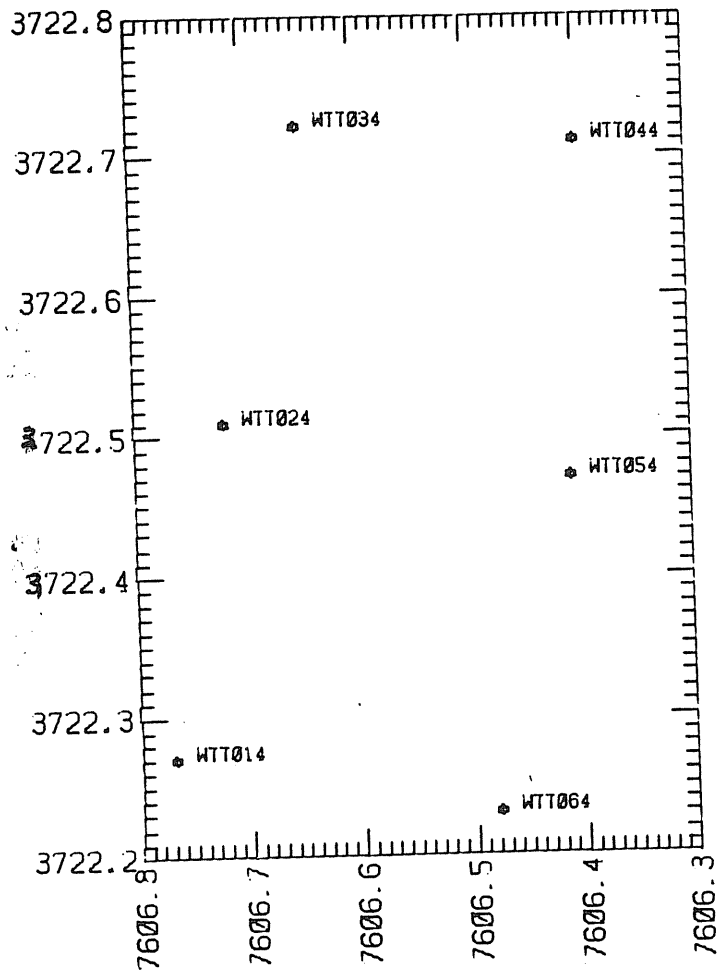

Figure II-6C. Cruise 4, Summer 1984. Stations sampled in the Wolf Trap Disposal Test Site. See Figure II-6B for location in disposal area.

6

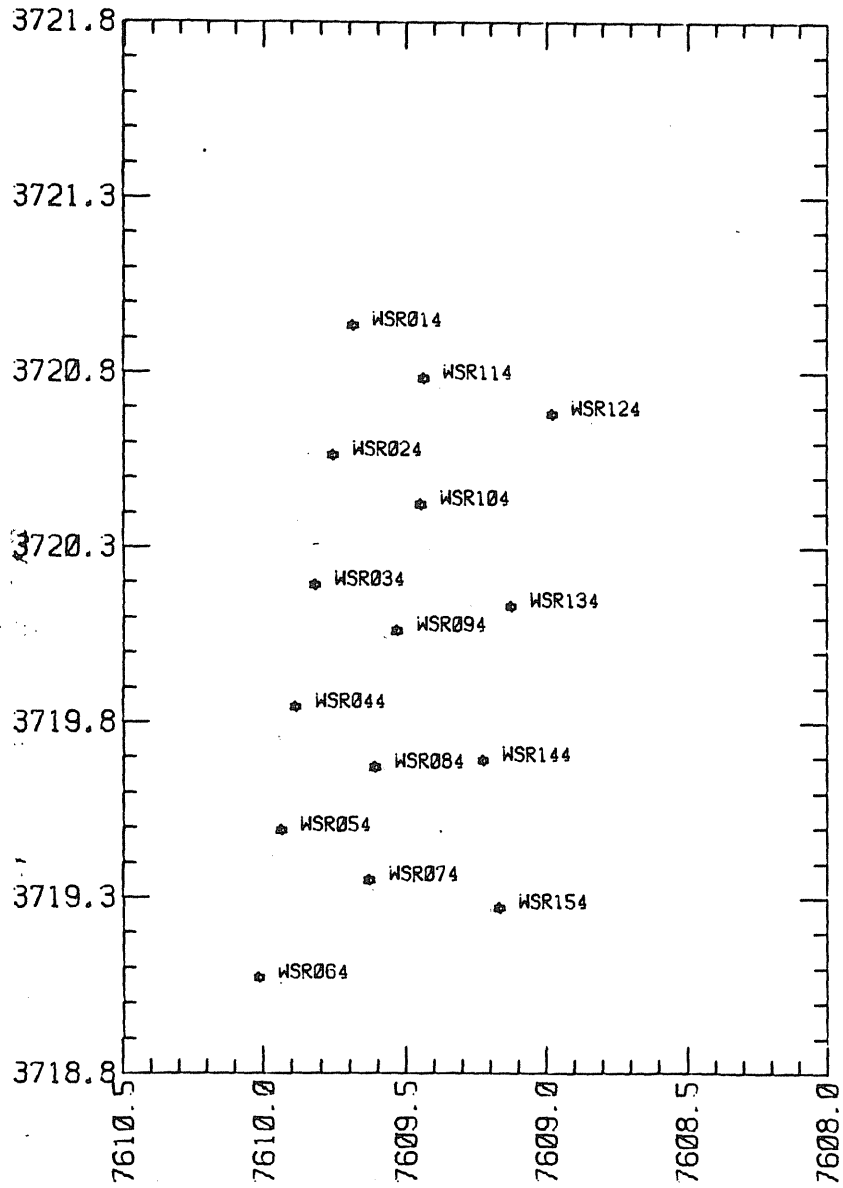

Figure II-6D. Cruise 4, Summer 1984. Stations sampled in the Wolf Trap Special Sand Search. See Figure II-6B for location within disposal area.

15

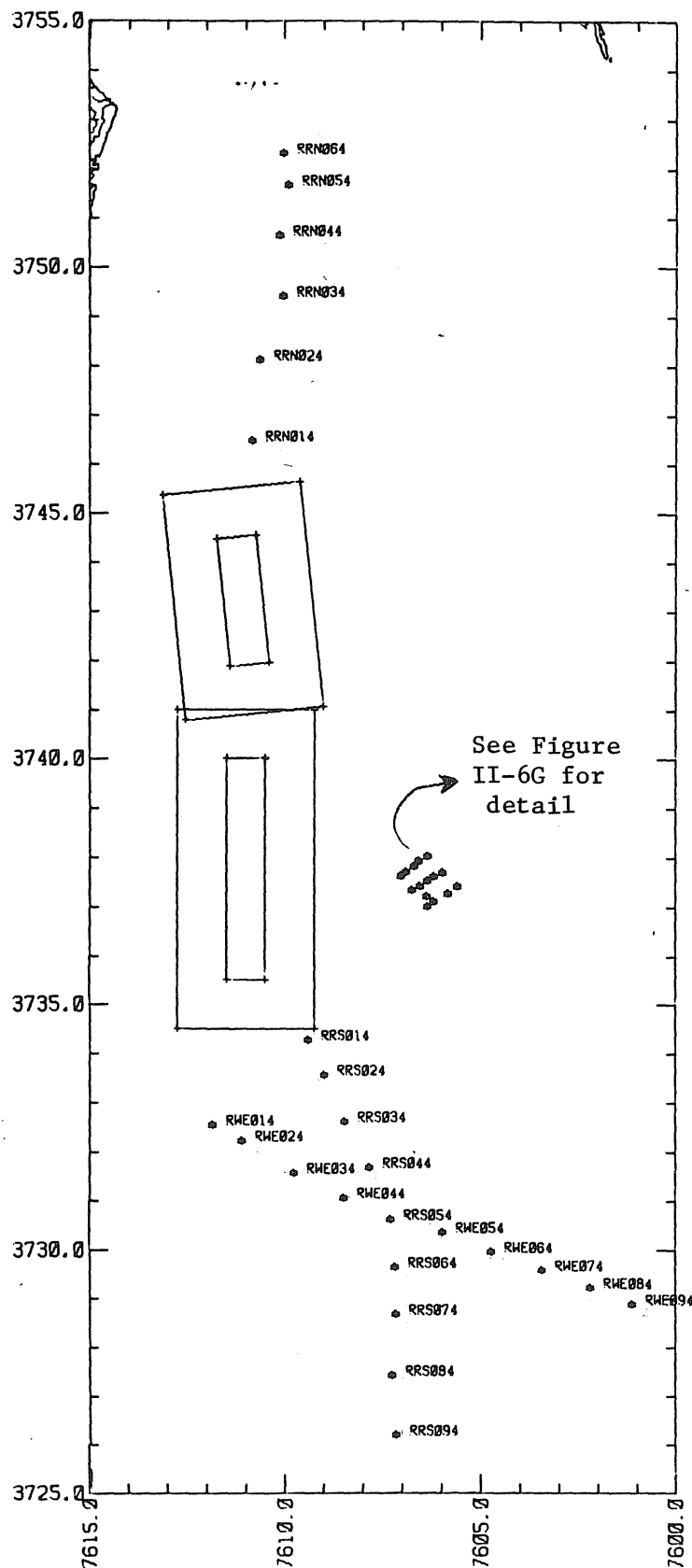

Figure II-6E. Cruise 4, Summer 1984. Stations sampled in Rappahannock Recon North (RRN), Rappahannock Recon South (RRS), and Rappahannock Recon West-East (RWE).

24

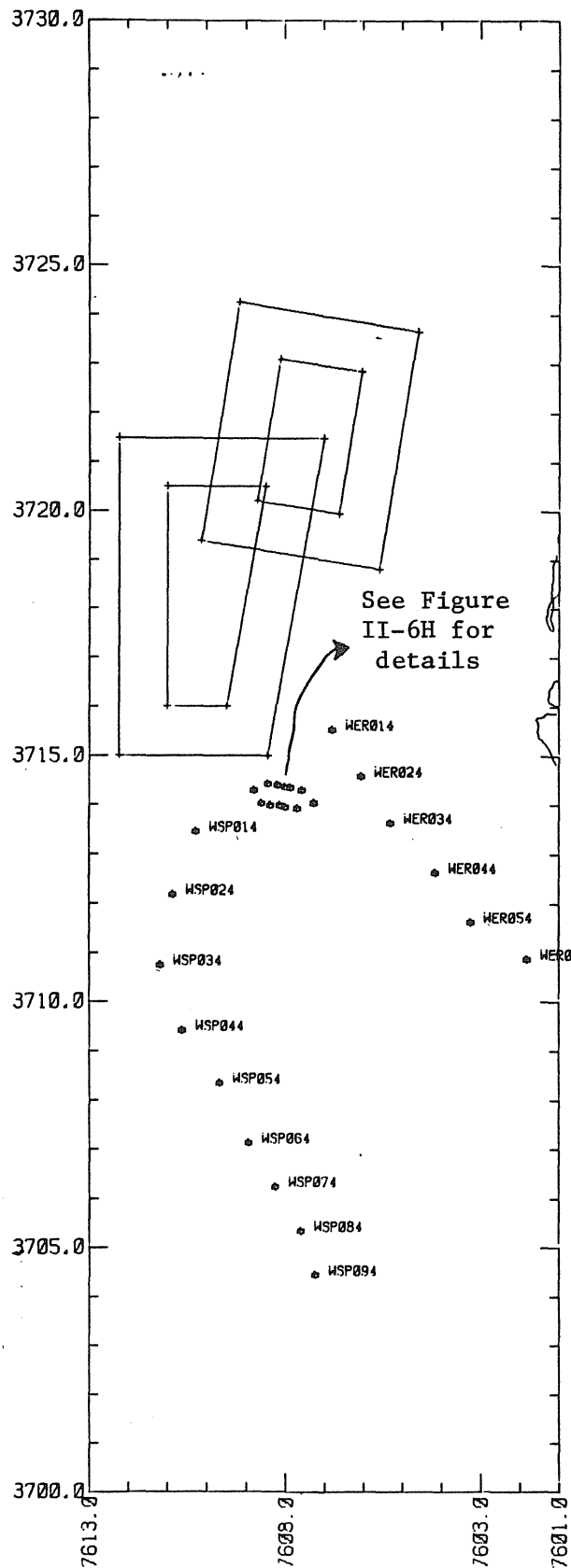

Figure II-6F. Cruise 4, Summer 1984. Stations sampled in Wolf Trap Recon South (WSP), and Wolf Trap East Recon (WER).

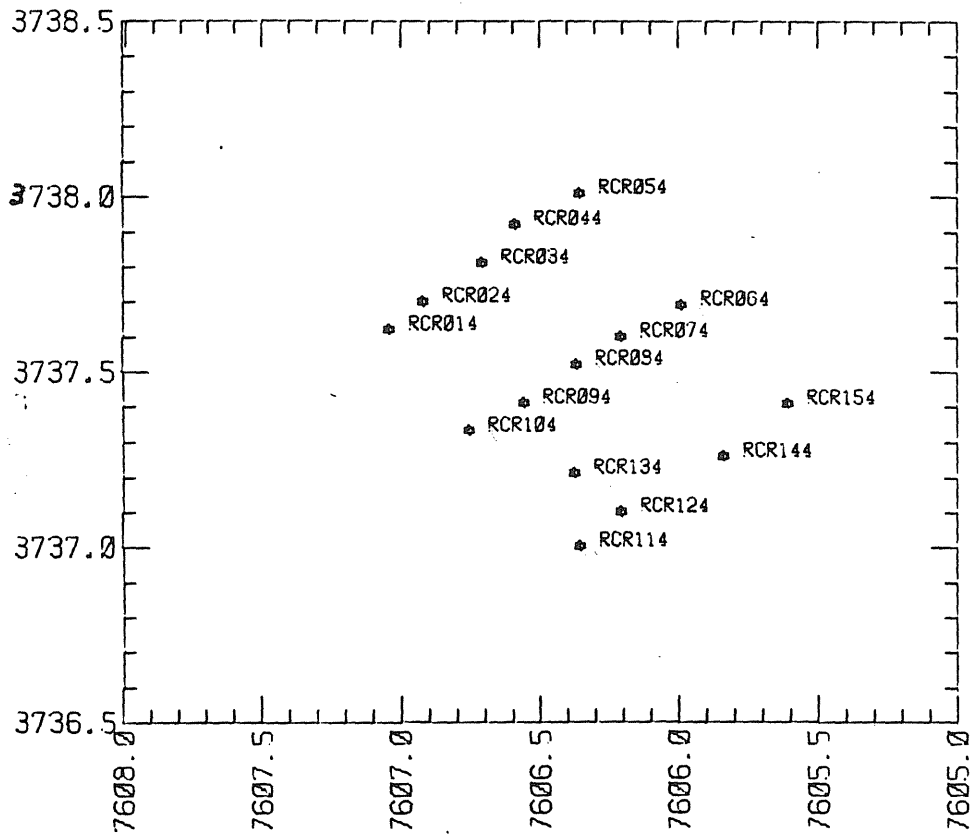

Figure II-6G. Cruise 4, Summer 1984. Stations sampled at Rappahannock Shoals Channels. See Figure II-6E for location.

15

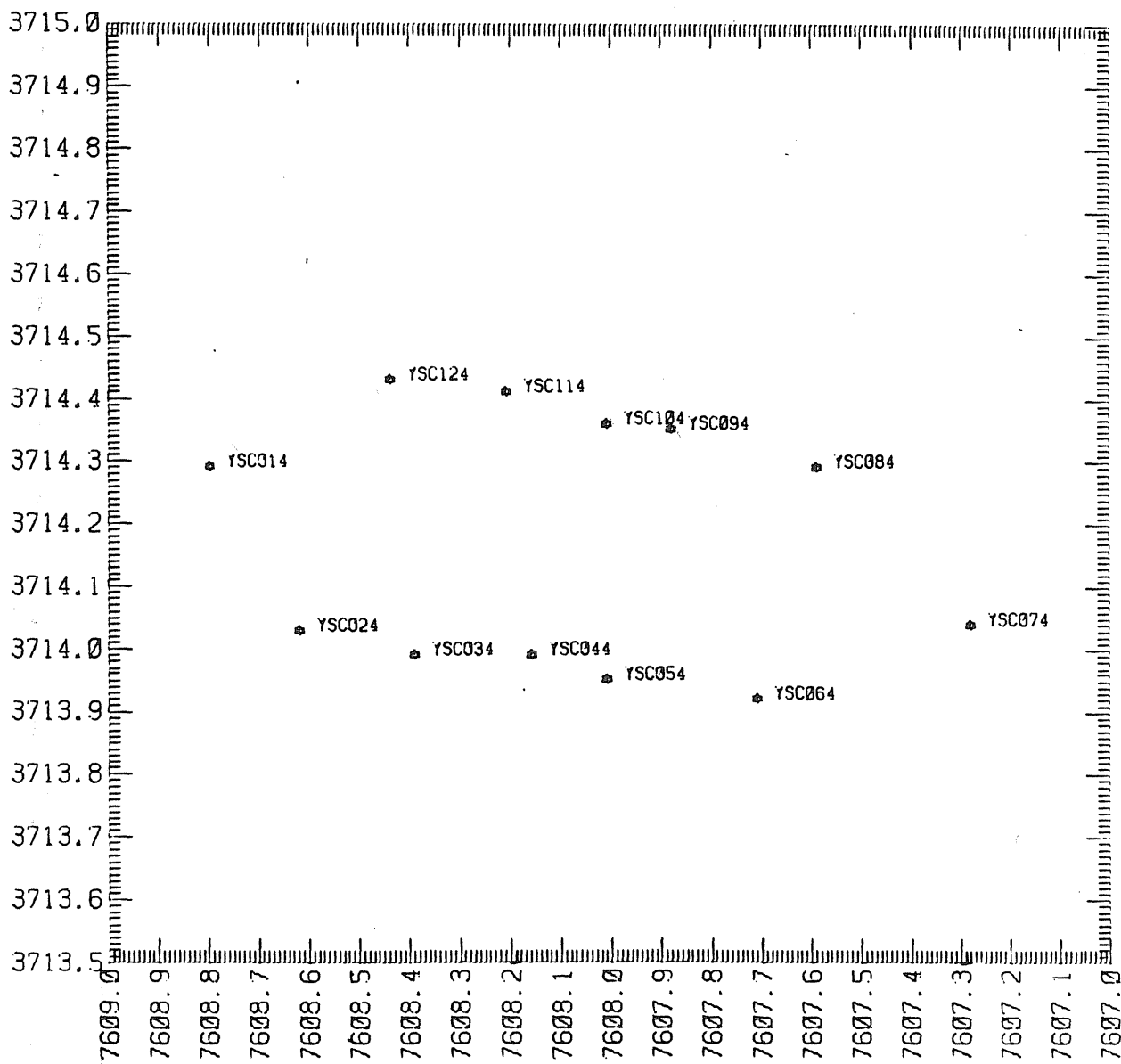

Figure II-6H. Cruise 4, Summer, 1984.. Stations sampled at York Spit Channel. See Figure II-6F for location grid.

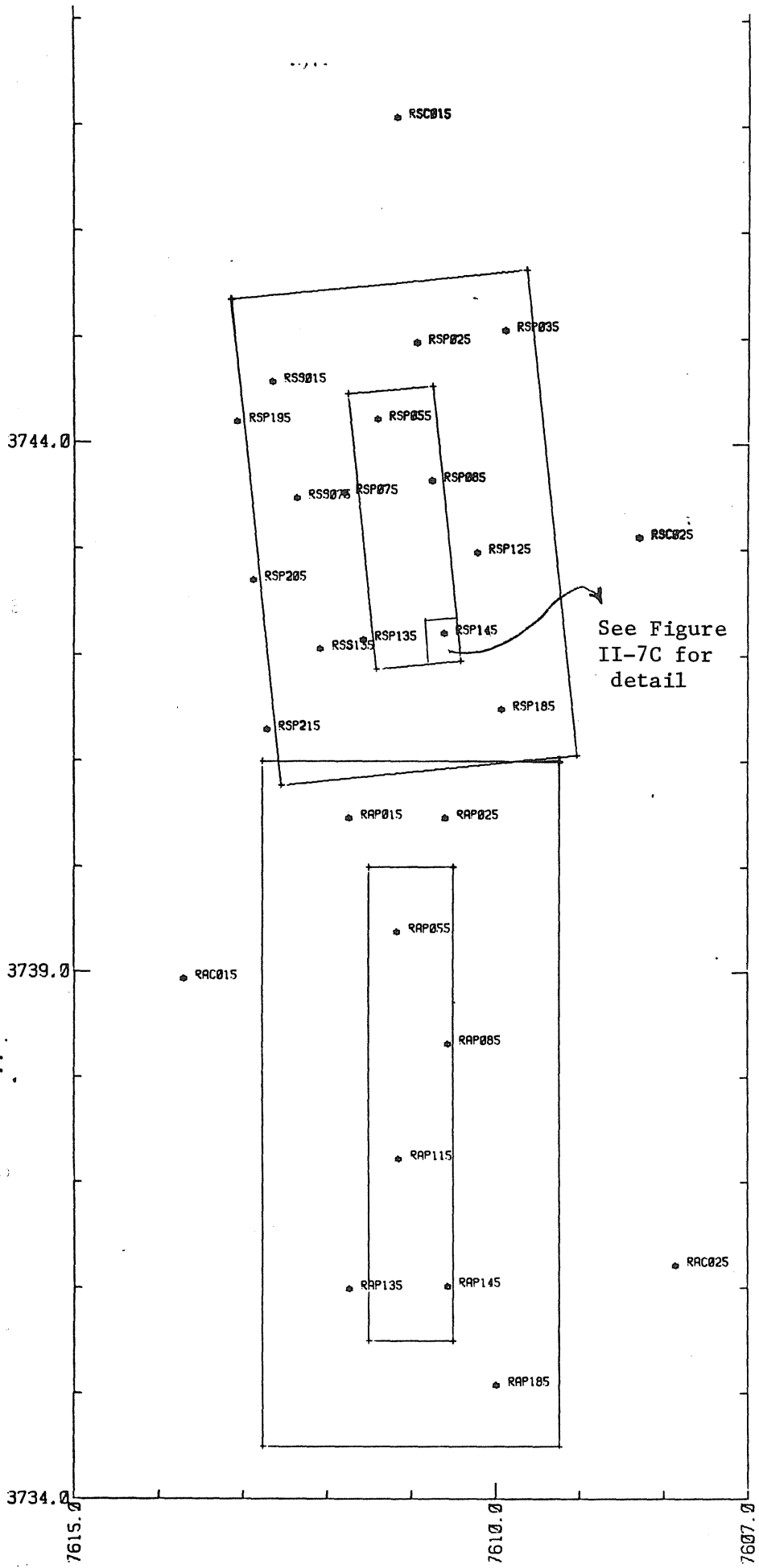

Figure II-7A. Cruise 5, Fall 1984. Stations sampled in the Rappahannock Disposal Areas.

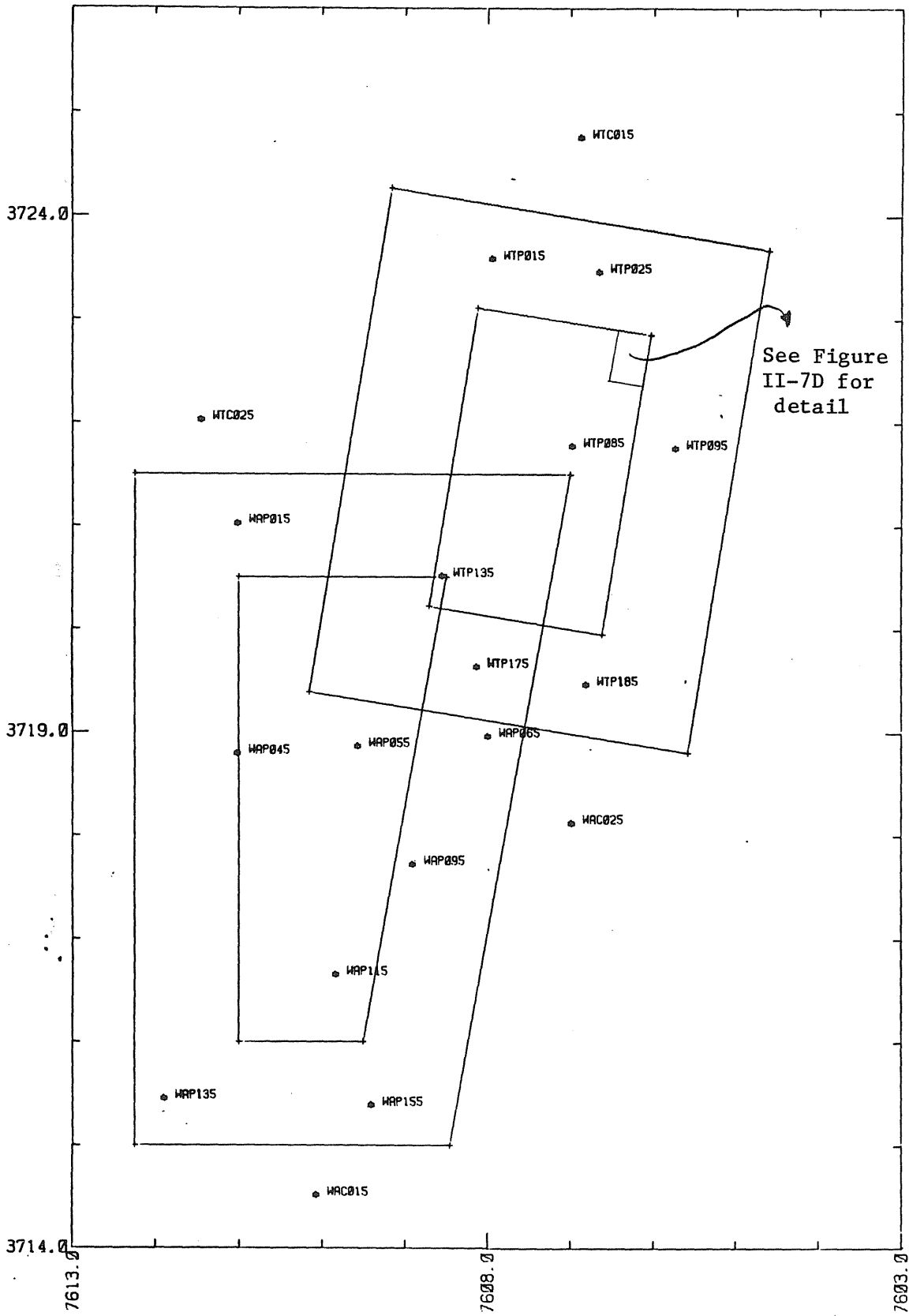

Figure II-7B. Cruise 5, Fall 1984. Stations sampled in the Wolf Trap Disposal Areas.

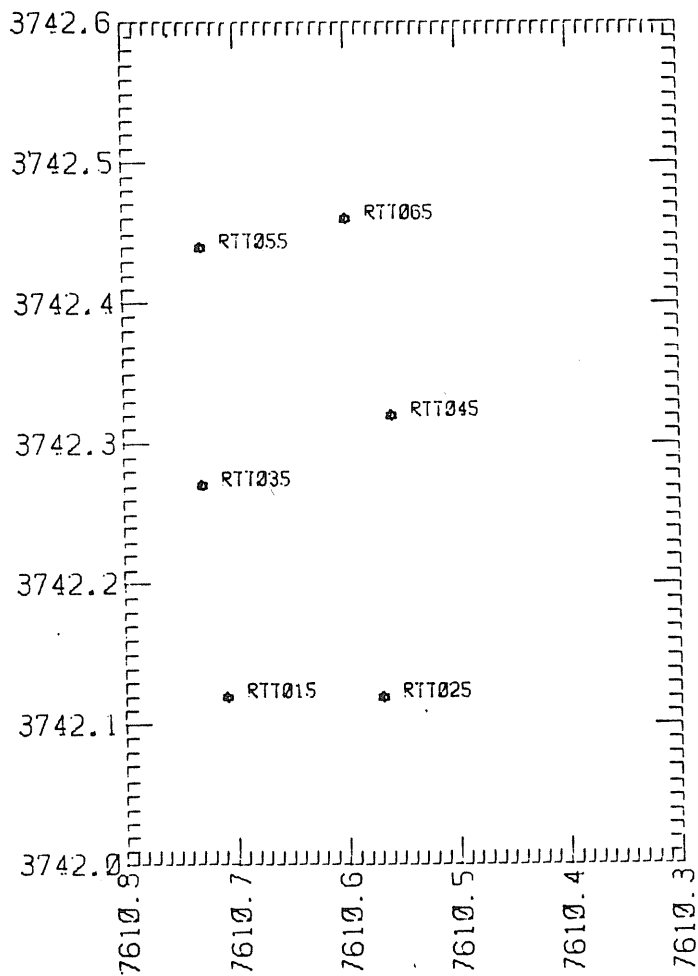

Figure II-7C. Cruise 5, Fall 1984. Stations sampled in the Rappahannock Disposal Test Site. See Figure II-7A for location within disposal area.

6

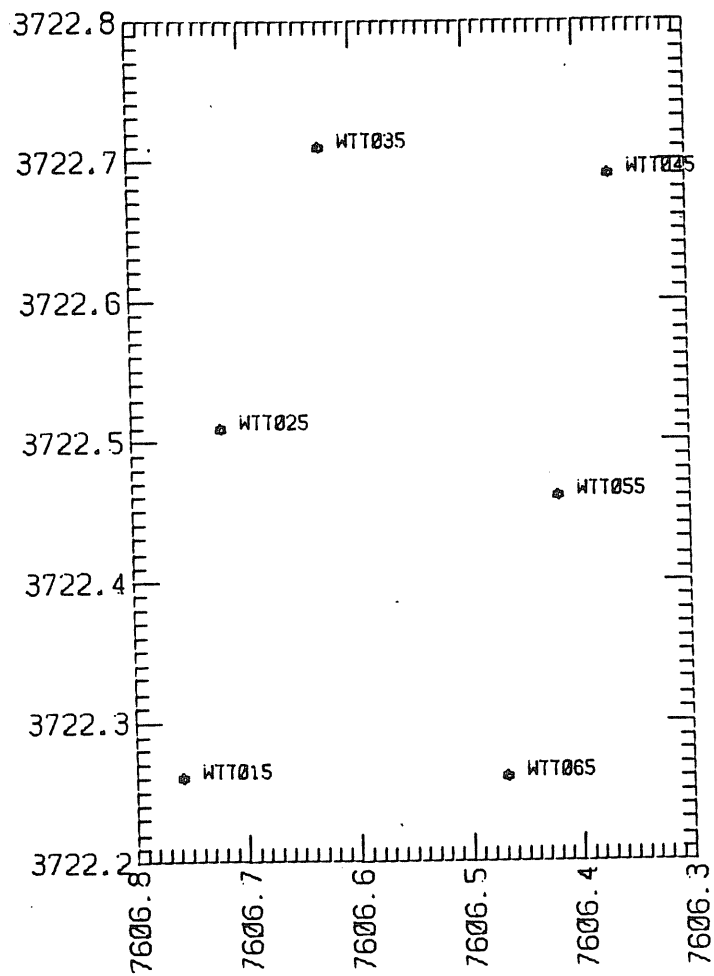
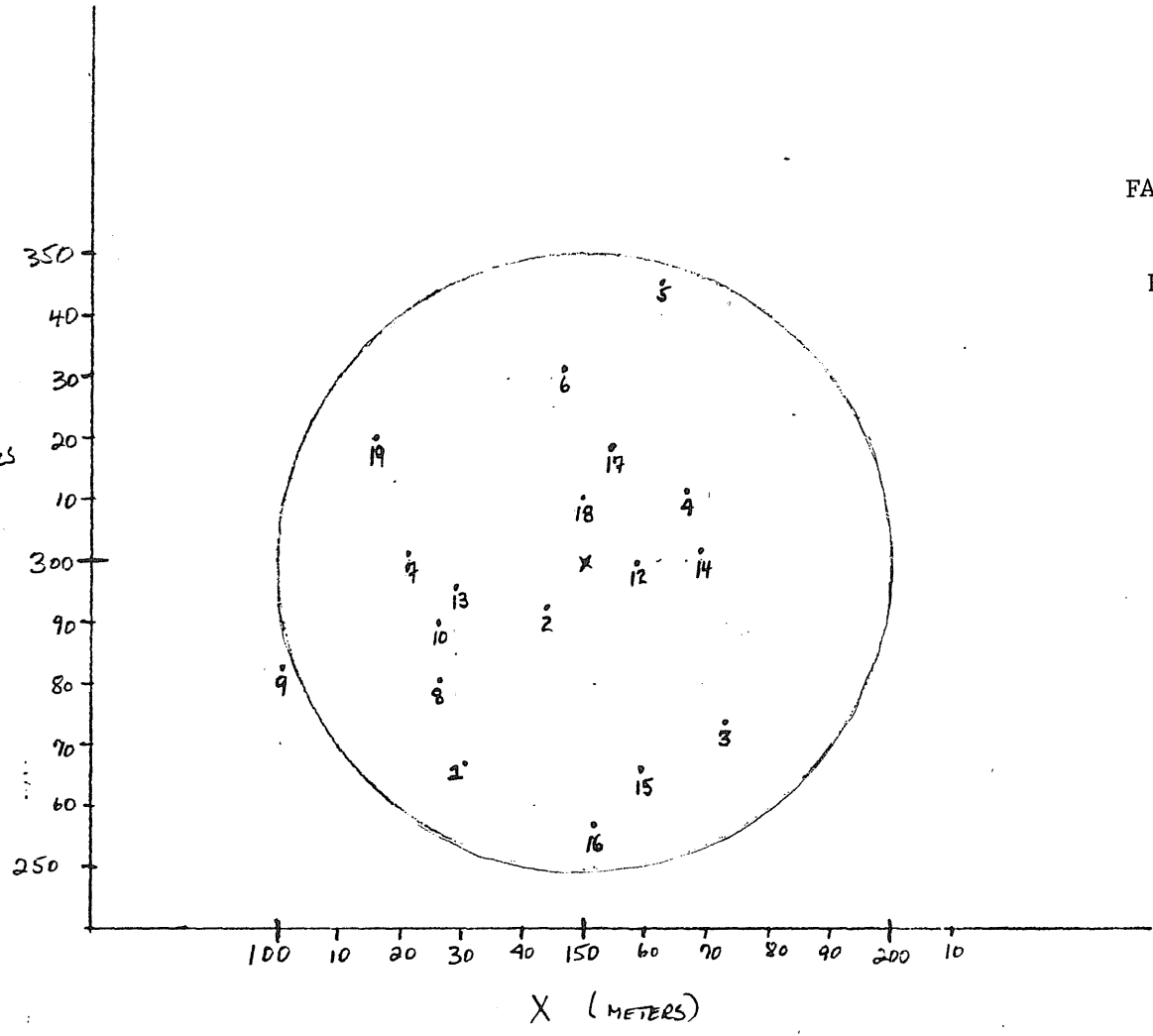

Figure II-7D. Cruise 5, Fall 1984. Stations sampled in the Wolf Trap Disposal Test Site. See Figure II-7B for location within disposal area.

6



FALL CRUISE 1984
 31 OCT. 1984
 WTP 10
 HIGH DENSITY
 CODE "SIS"

Figure II-7E. Cruise 5, Fall 1984. High density sample locations at WTP 10.

35

18

WTP 145
FALL CRUISE 1984
HIGH DENSITY RANDOM
CODE "TIP"

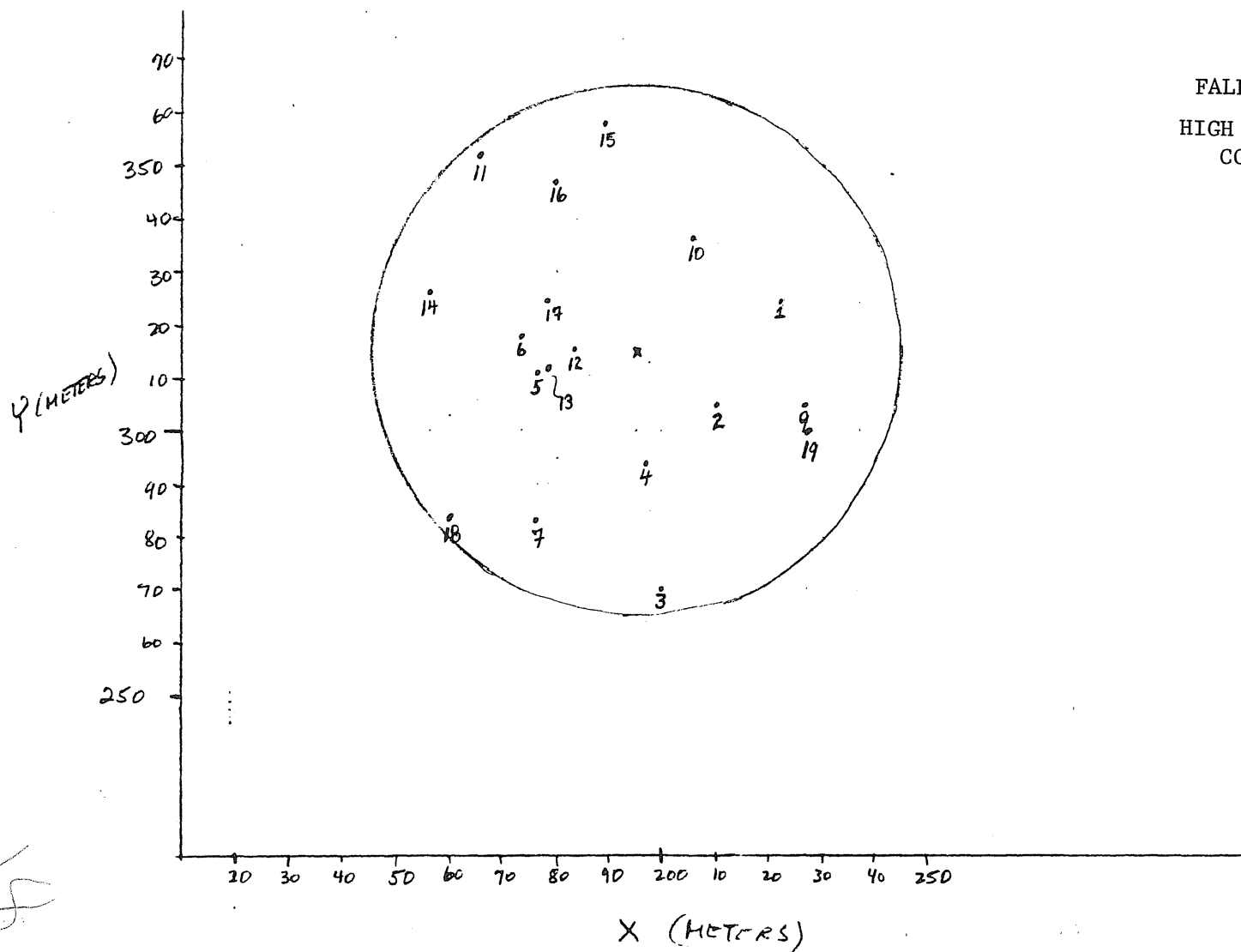

Figure II-7F. Cruise 5, Fall 1984. High density sample locations at WTP14.

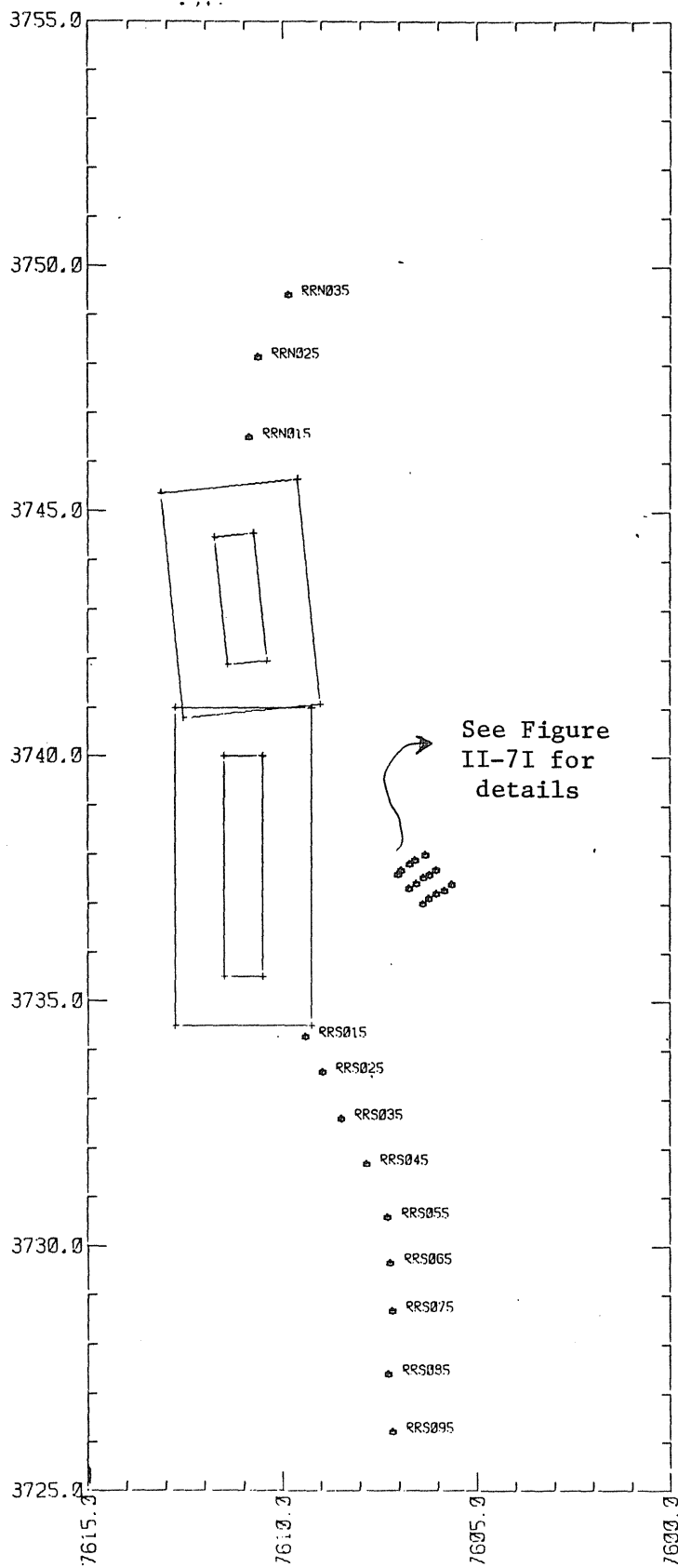

Figure II-7G. Cruise 5, Fall 1984. Stations sampled at Rappahannock Recon North (RRN) and Rappahannock Recon South (RRS).

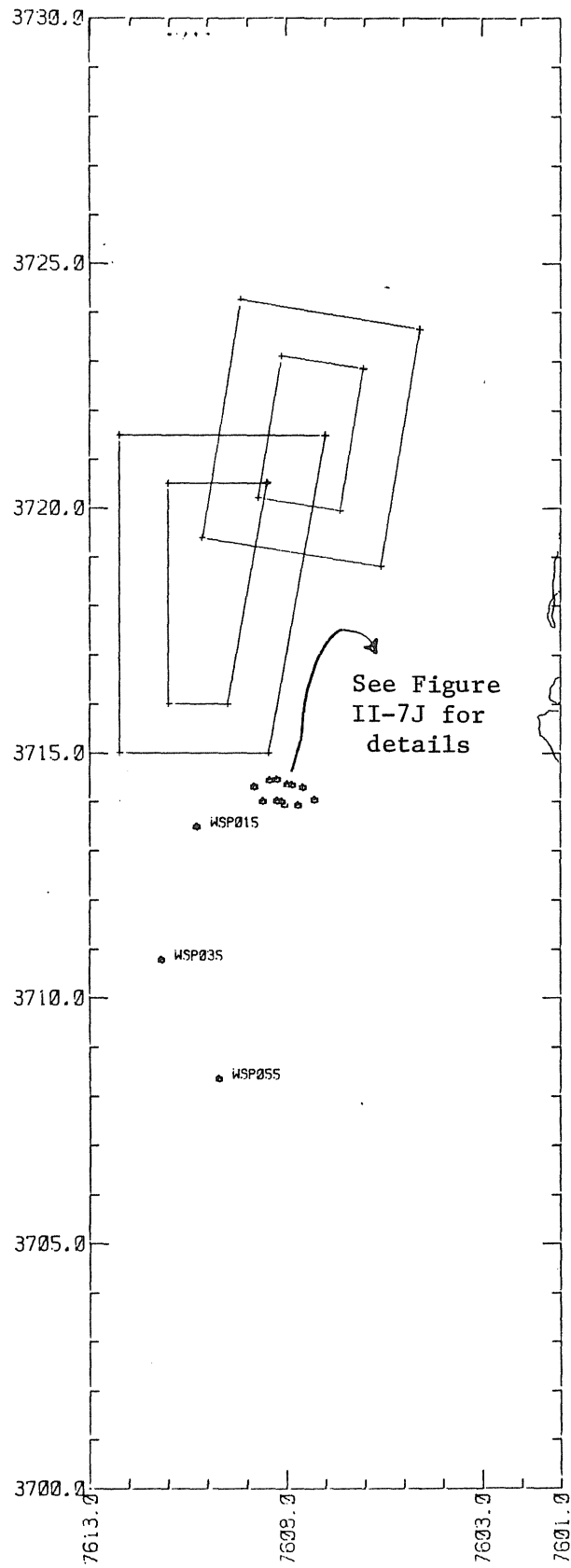

Figure II-7H. Cruise 5, Fall 1984. Stations sampled at Wolf Trap REcon South (WSP).

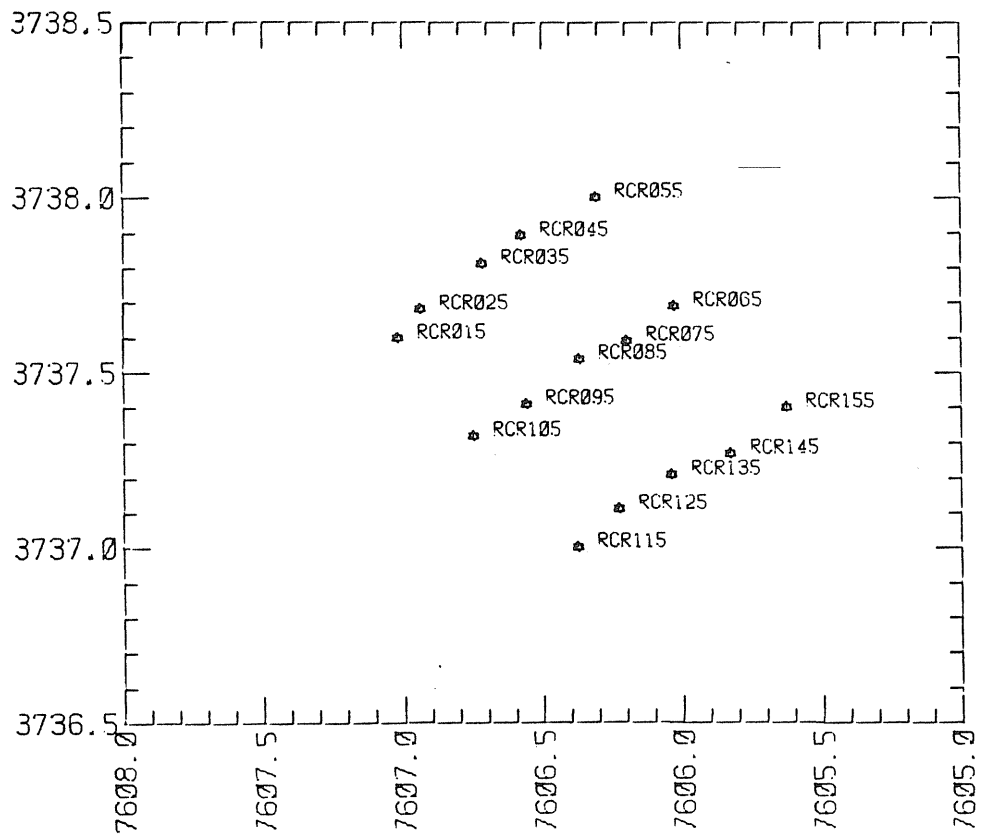

Figure II-7I. Cruise 5, Fall 1984. Stations sampled at Rappahannock Shoals Channels. See Figure II-7G for location.

15

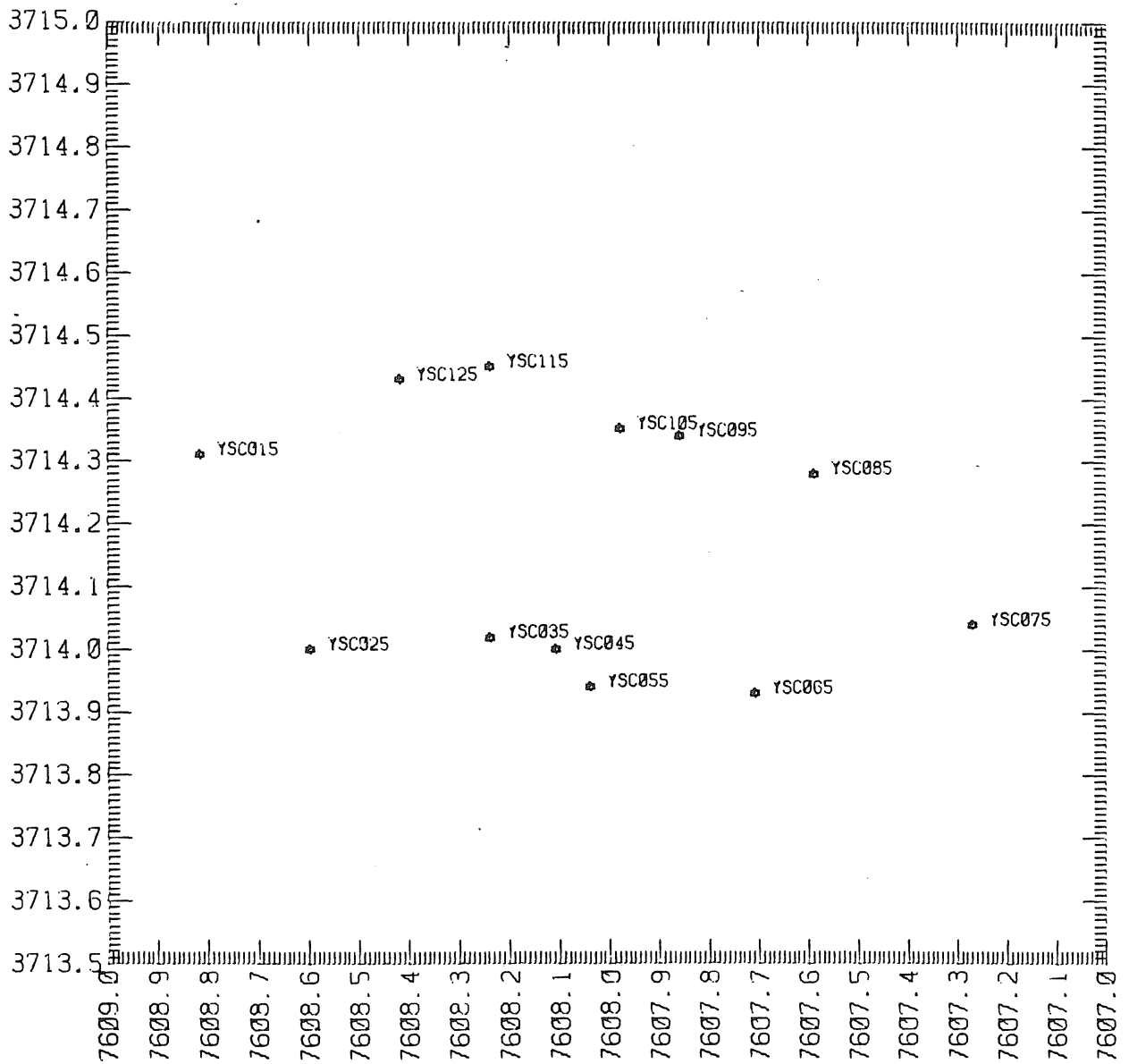

Figure II-7J. Cruise 5, Fall 1984. Stations sampled at York Spit Channel. See Figure II-7H for location.

PART III: METHODS

Positioning of Stations and Relocation

The LORAN C navigation system was used to initially position stations and for station relocation thereafter. Because LORAN C geodetic accuracy is somewhat restricted by altered boundary conditions (changes in ground-wave velocity near land masses) it is necessary to calibrate the system. To achieve calibration we enlisted the assistance of the Norfolk District, Corps of Engineers, who operated the Tellurometer MRD-1 Navigation System aboard the survey vessel ADAMS. The nominal accuracy of the Tellurometer System is ± 2 ft. With the VIMS Northstar 6500 LORAN C unit and Digitec Printer aboard the ADAMS the corners of the disposal sites and their respective "fringes" were occupied using the Tellurometer System. The Northstar 6500 then recorded the position TD's and geographic coordinates at each corner point. This allowed two comparisons. The observed TD's could be compared with TD's from the navigation charts, and the LORAN C converted latitude and longitude could be compared with the "true" geodetic position occupied using the Tellurometer System.

Initial station locations were identified with respect to chart value TD's (NOAA Charts 12221 and 12225) and these values then corrected based upon the calibration. The corrections ($n = 16$) were:

LANE	OBSERVED-CHART
9960-X	Mean = 0.3; RMS Deviation = 0.08
9960-Y	Mean = 1.6; RMS Deviation = 0.21

For example, if the chart TD values for a station was reckoned to be 27261.7 and 41583.0 the values for station positioning were 27262.0 and 41584.6.

The scope of work required that all box-cores at a given station be obtained within a 100 meter diameter circle. To assist achievement of this goal expanded (X25) LORAN coordinate sheets were constructed (a nominal chart scale of 1:3200). The desired station central position TD's were plotted and a 50 meter radius circle constructed. The vessel was then repositioned for each core and the LORAN C TD's printed (0.001 microsecs) when the corer hit bottom. If the position plotted outside of the target circle the core was rejected.

The LORAN C Digitec Printer also listed the latitude and longitude of each core location. The contract scope of work required that station latitude and longitude be reported. Accordingly Appendix A1 lists both the LORAN TD's and latitude/longitude for all of the station box-core replicates. Appendix A2 lists the centroid station location. The station location listings incorporate the bias correction observed between LORAN and TELLUROMETER:

COORDINATE	LORAN CONVERSION minus True (Tellurometer)
Latitude	Mean = 0.12 minutes; RMS Deviation = 0.014
Longitude	Mean = 0.13 minutes; RMS Deviation = 0.016

Special Case: The sampling design for Cruise 5 (Fall, 1984) included high density sampling (18 box-cores) within the 50 meter radius circle at stations WTP 10 and WTP 14. Since this design was intended to examine small scale spatial variations an alternate positioning system was used to gain the required accuracy (± 1 meter). The hardware used was the Datasonics

ARCS-1 Acoustic Range Control System. This system has two primary components; a shipboard ranging transceiver with transducer, and subsurface transponders. In our application three taut-wire buoys, each with a transponder of different frequency, were deployed in a triangular array with the sampling station (marked by a buoy) near the triangle centroid (schematically shown in Fig. III-1). The sides of the triangle ranged between 500 and 800 meters in length. The relative positions of the triangle vertices and the central sampling station were determined by successive occupation of these points with the transceiver/transducer and the distances ranged to the transponders. A rectangular coordinate system origin was then selected at one vertex. In operation the sampling vessel, with the transceiver/transducer, occupied a station within the 50 meter radius circle centered at WTP10 (or WTP14) and received range data from the three transponders. The position could then be determined, since the sides of the subtriangle formed by the transducer to two transponders were known (Fig. III-1). Three independent calculations were made for each fix by taking ranges to successive pairs of transponders, and the average was then taken to denote the sampling position. For speed of operation, software was developed and the Datasonics ARCS-1 System was interfaced with an Apple II Computer.

Field Methods

All samples were collected from the 93 ft. R/V TERN using a U.S. Naval Electronics Laboratory spade box-core which samples a surface area of 0.06 m^2 (Figure III-2). This device has a removable stainless steel core-box which facilitates processing and minimizes disturbance to the samples.

Following the retrieval of the core, sample boxes were sealed at the bottom, removed from the coring device and placed upright on small hand trucks. This allowed free movement of samples from the work deck to the processing area.

Up to four cores were collected at each station. Cores A, B, and C were processed similarly. Core C was not collected for all cruises. Following the removal of one side of the sample box, acrylic cutting plates were horizontally inserted into the sediments at depths of 5 and 15 cm. Two small core tubes (2.2 cm and 1.0 cm) were inserted down through the sediment for sediment and organic carbon samples, respectively. The sediment sample was capped and retained in the core tube. The organic carbon sample was extruded into a small whirl-pac. Sediments remaining in the 0-5 cm layer were transferred into a bucket. Similar procedures were used to obtain sediment and carbon samples from the 5-15 cm layer. Sediments remaining in this layer were combined with sediments from the 0-5 cm layer for sieving. Material from each core was gently washed through a 500 μ m sieve using running seawater. The organisms and residue retained on the sieve were transferred to a cloth bag with a label indicating site, station, cruise date and replicate letter. Bags were stored submerged in 10% buffered formalin with Rose Bengal as a vital stain.

The processing of core D differed from the procedure outlined above. Samples were divided into 4 rather than 2 layers, as follows: 0-2 cm, 2-5 cm, 5-10 cm and 10-15 cm. Sediment samples were collected from each layer and retained in labelled core tubes. Organic carbon samples collected from the 0-2 cm and 2-5 cm layers were combined with the 0-5 cm layer samples from replicates A and B (and C when collected). Similarly, carbon samples from the 5-10 cm and 10-15 cm layer were combined with 5-15 cm carbon

samples from replicates A and B. Remaining sediments from the 0-2 cm layer were sieved on a 250 μm mesh screen, while all remaining layers were individually sieved on a 500 μm mesh screen. The organisms and residue from each layer were individually bagged and preserved. The samples resulting from the processing of replicates A, B, and D are depicted in Figure III-3.

The field and laboratory methods for acquisition of bottom water salinity, temperature, and dissolved oxygen are presented in Appendix C, as are the results and discussion.

Laboratory and Quality Assurance Procedures

Sediment Analysis: Sediments from each station arrived for laboratory analysis in the form of a marked, logged packet containing subpackets with cores from each of the two sediment horizons, 0-5 cm and 5-15 cm. Each subpacket had cores for each replicate box-core which numbered from 1 to 4 depending upon the cruise and station. The processing procedure is outlined in Figure III-4. The sediment cores for each vertical sediment horizon were pooled and mixed well. A subsample of approximately 30 grams (wet weight) was extracted and placed in a beaker with 50 ml of a 10% Calgon solution. The remainder of the subsample was stored as a VIMS archive. Ten samples from each cruise were subsampled again and analyzed as a blind duplicate for the Q/A procedure.

De-ionized water was added to the sample with Calgon. The sample was then placed in an ultrasonic bath for approximately 5 to 10 minutes to disaggregate the silt and clay particles. The sample was then wet sieved through a 63 μm sieve. The sand and gravel portion retained on the sieve was dried. The silt and clay portion passing through the sieve was placed in a cylinder and filled to 1000 ml with de-ionized water for pipette

analysis. The dried sand and gravel fraction is then passed through a 2.00mm sieve. The portion retained on the sieve is gravel. The portion passing through is sand. Both fractions are weighed.

Pipette analysis was done on the silt and clay fraction. A Coulter Counter sample was taken before pipette analysis. The sample was approximately 20 ml and was refrigerated until Coulter analysis was done. 4 ϕ and 8 ϕ withdrawals were taken for each sample during pipette analysis. These were dried and weighed.

Weight percents for each sample were calculated using the gravel, sand, silt, and clay. Samples having a sand fraction $\geq 5\%$ were then analyzed using the Rapid Sediment Analyzer (RSA). The data is in the form of a strip chart depicting proportion of sediment fallen versus time elapsed since introduction of sample. The strip chart was then processed on an electronic digitizer into the computer. Fall velocity was then converted to sedimentation diameter and reported in cumulative % in 1/4 ϕ intervals (Byrne, et al, 1982).

If the silt plus clay fraction was $\geq 5\%$ Coulter Counter analysis is performed. Coulter analysis covers the size range of 4 ϕ to 10 ϕ . The Coulter Counter (Model TAI) is capable of determining the numbers and sizes of particles suspended in a conductive liquid by forcing the suspension to flow through a small aperture and monitoring an electrical current which also passes through the aperture. As particles pass through the aperture there is a change in the resistance between internal and external electrodes. This produces a current pulse of short duration having a magnitude proportional to the particle volume. These pulses are electronically classified by size and counted.

The Coulter Counter analyses used two apertures, 140 μm and 30 μm . The lowest nominal particle diameter sensed is 0.6 μm (10.6 ϕ). If there is a significant component of sediment finer than 0.6 μm the percent weight cumulative curve will be distorted when normalized by the total weight of silt and clay determined by the pipette analysis. In other words the weight of the sediment smaller than 0.6 μm is distributed and added to the coarser clay and silt fractions. This "omission factor" effect would be most pronounced when the sand fraction is small. The problem can be avoided by an additional pipette analysis withdrawal at 10 ϕ which would quantitatively determine the percent weight of sediment smaller than 10 ϕ in addition to that in the 4 ϕ to 8 ϕ , and 8 ϕ to 10 ϕ ranges. In this study the potential significance of the problem was not realized until after samples from two cruises had been processed. Therefore, it was necessary to develop a transformation which would rectify the sediment distributions.

Pipette analyses, including a 10 ϕ withdrawal, were performed on 29 samples selected from the four disposal areas (Cruise 5) and both sediment horizons, 0-5 cm, and 5-15 cm. These analyses indicated that there is a well defined relationship between the percent weight in the 4 ϕ to 8 ϕ size range and the percent weight finer than 10 ϕ . These results are shown in Figure III-5 with the derived least squares regression:

$$Y = 60.62 - 0.59X$$

In order to test the suitability of the transformation 235 samples from Cruise 4 (Summer 1984) were analyzed with a 10 ϕ pipette withdrawal. This allowed the comparison of predicted values of sediment finer than 10 ϕ versus observed values. Figure III-6 depicts the results with the comparison of the predicted and observed percent weight finer than 10 ϕ

relative to total sample weight (gravel, sand, silt, and clay). The correspondence between observed and predicted values is very strong:

$$Y = -0.1140X^{0.9871}$$

with a coefficient of correlation, $r = 0.9926$. Thus the transformation can be used as a reliable predictor of the percent weight of sediment finer than 10 ϕ . Accordingly, the transformation was applied to all of the samples taken during the five cruises. No distribution information for the finer than 10 ϕ fraction. The material in the 10 ϕ to 14 ϕ size range is assumed to be uniformly distributed (Folk, 1980).

Sediment Statistics: The standard graphic measures of Folk or Folk and Ward (Folk, 1980) and the first four moments plus moment skewness and moment kurtosis were computer calculated for each sample.

Graphic Measures

$$\text{Median} = \phi_{50}$$

Graphic Mean

$$M_Z = \frac{\phi_{16} + \phi_{50} + \phi_{84}}{3}$$

Graphic Standard Deviation

$$\sigma_G = \frac{\phi_{84} - \phi_{16}}{2}$$

Graphic Skewness

$$S_{K_G} = \frac{\phi_{16} + \phi_{84} - 2(\phi_{50})}{(\phi_{84} - \phi_{16})}$$

Inclusive Graphic Standard Deviation

$$\sigma_I = \frac{\phi_{84} - \phi_{16}}{4} + \frac{\phi_{95} - \phi_5}{6.6}$$

Inclusive Graphic Skewness

$$S_{K_I} = \frac{\phi_{16} + \phi_{84} - 2\phi_{50}}{2(\phi_{84} - \phi_{16})} + \frac{\phi_5 + \phi_{95} - 2\phi_{50}}{2(\phi_{95} - \phi_5)}$$

Graphic Kurtosis

$$K_G = \frac{\phi_{95} - \phi_5}{2.44(\phi_{75} - \phi_{25})}$$

Moment Measures

$$\text{1st Moment} = \frac{f m_{\phi}}{100}$$

where f is frequency percent of each ϕ class, m_{ϕ} is the endpoint of each whole ϕ class. By definition the first moment equals the mean, \bar{X} , of the distribution.

$$\text{2nd Moment} = \frac{f(m_{\phi} - \bar{X})^2}{100}$$

The 2nd Moment is the square of the standard deviation.

$$\text{3rd Moment (mean cubed deviation)} = \frac{f(m_{\phi} - \bar{X})^3}{100}$$

$$\text{4th Moment} = \frac{f(m_{\phi} - \bar{X})^4}{100}$$

$$\text{Moment Skewness} = \frac{\text{3rd Moment}}{\text{standard deviation cubed}}$$

$$\text{Moment Kurtosis} = \frac{\text{4th Moment}}{\text{standard deviation to the 4th power}}$$

Quality Assurance, Sediments: The primary element in the quality assurance protocol was performance of analyses on blind duplicates. The precision of the analysis may be examined by comparison of gravel, sand, silt, and clay percent weights, and the mean grain size. The differences between the percent size fractions indicate the precision in the procedures for sample

splitting, wet sieving, level of disaggregation by Calgon treatment, and in the pipette procedure for determination of relative weights in the silt and clay range. The precision in these values is particularly important as the relative proportions between sand, silt, and clay may be a control on the character of the benthic community. From a sedimentological analysis viewpoint the partitioning is fundamental to determination of the total size frequency distribution as the weight percent frequencies within the sand versus silt and clay fractions are weighted by the gross relative proportions. The comparison of the mean grain size, on the other hand, examines the reproducibility of analytical methods within the sand and mud fractions.

The industrial statistic, I, is used as a measure of precision (EPA, 1979). For duplicate determinations A and B;

$$I = \frac{R}{(A+B)}$$

$$\text{Range, } R = |A-B|$$

The industrial statistic I is equivalent to the coefficient of variation ($\frac{1}{\sqrt{2}} \cdot \frac{S}{\bar{X}} = I$). The values of I and R for individual sample comparisons of percent weight sand, percent weight clay, and the graphic mean are shown in Table III-1. Table III-2 is a summary of the statistics for various ranges of A + B.

The precision of the analyses are found to be very high and relatively stable within various ranges of concentration. The mean difference in graphic mean was found to be 0.16 ϕ .

Total Organic Carbon Analysis: The sediment samples obtained for organic carbon were maintained frozen for subsequent laboratory analysis. The laboratory procedure was as follows:

- 1.) Frozen samples were thawed and oven dried at 50°C, powdered with mortar and pestle and microsplit into aliquots.
- 2.) Aliquots to be analyzed were treated with 10% HCL until evidence of continuing reaction ceased and then washed with distilled, de-ionized water, and oven dried and weighed.
- 3.) Analyses are done, on duplicate samples, with a LECO Gasometric Carbon Analyzer Model 572-100 in conjunction with a LECO S23-300 Induction Furnace. The averages of the duplicate analyses are the reported value. On cruises 3, 4, and 5 only one analysis was performed on each sample in accord with discussions between the principal investigator and the technical contract monitor.

Samples for twenty stations (Cruise 2) at the Wolf Trap disposal areas were not processed due to an electrical failure which caused a prolonged thaw of samples in a freezer.

Quality Assurance, Total Carbon: Quality control of organic carbon analysis hinges upon the confidence one has in the burn mechanism. This is established by the burning of a standard carbonate sample and determining the percent recovery of carbon. The higher the percent recovery, the better the confidence in the analysis. Based on this concept, the following program was designed for quality control:

- 1.) Before each run of samples at least two standard samples were burned. No samples were run if the standard sample (BaCO_3) resulted in less than 96% recovery.

- 2.) A series of 10-12 samples was run whereupon completion of a standard was again burned to determine the percent recovery. If the recoveries were consistently high, that is, the machine was performing well, the series of sample burns was extended by two to four more burns.
- 3.) After every standard burn, a blank was burned to determine the amount of residual carbon in the system. This amount was then subtracted from every sample.
- 4.) After completion of the final sample burn for the day, a standard was again burned and the percent recovery estimated in order to check on the validity of the previous sample set.

Biological Samples: In the laboratory, sample bags were first removed from formalin and rinsed in fresh water. Material preserved in the bags containing A or B replicate samples was emptied into a 500 μm sieve and rinsed with fresh water. Any material clinging to the sample bag was rinsed into the sieve as well. Samples were then transferred to jars and filled with 10% buffered formalin for storage before being picked and identified. Each layer from the D replicate was similarly processed with the exception of material retained from the 0-2 cm layer. This material was placed on a stacked set of 500 μm and 250 μm screens and resieved into 2 fractions. Each fraction was then placed into an individual jar and handled as described above.

Material retained on the 500 μm sieve for replicate or fraction of a replicate was sorted to major taxa with the aid of a binocular dissecting microscope. The sorted material was retained in formalin or refrigerated in water for not more than 5 days prior to biomassing.

Wet weight biomass was determined to the nearest 0.01 g on a top-loading electric balance for each major taxon in replicates A and B following the removal of external fluids by blotting. Weights include skeletal material such as shells and, in some cases, tubes or protective encrustations not easily removable.

Wet weight biomass was determined for each major taxon in each 500 μ m fraction of replicate D following wet sieving into discrete size classes (Carr and Adams 1973, Sheridan 1979). Samples were processed as follows: Individually, each taxonomic group was transferred from its vial into the top of a nested sieve series (6.35 mm, 3.35 mm, 2.0 mm, 1.0 mm, and 0.5 mm). The sample was washed through the sieve series using gently running water. Material retained on each sieve was successively transferred to paper towels for blotting and then weighed to the nearest 0.01 g. After weighing the material retained on each sieve, the sample was returned to its vial with label and stored in 70% ethanol.

Biomass values for each taxon in the 250 μ m fractions of replicate D were determined using the procedure outlined below. Each organism or segment of an organism of each taxon was enumerated. The total counts were multiplied by the average weight of organisms or pieces comprising that taxon (as previously determined in the laboratory). Weights were recorded to the nearest 0.01 mg.

Following biomassing, organisms in replicate samples A and B were identified and counted. Identifications were made to the species level whenever possible. Organisms from the 500 μ m fractions of each layer of replicate D were identified to the family level and enumerated.

REMOTS

At each of the primary stations at which quantitative box-cores were collected three REMOTS images were taken. In addition all secondary stations were sampled with REMOTS each collection period. For the Fall 1983 (November 1983), Winter (February 1984) and Spring (May 1984) cruises the original REMOTS camera built by Rhodes and Candy was used. A second generation REMOTS camera built by Benthos (West Falmouth, MA) was used for the Summer (August 1984) and Fall 1984 (October 1984) cruises.

Measurements of boundary roughness, camera prism penetration depth, and the area of the positive redox in the sediment as seen in profile were taken from the 120 format (original REMOTS) or 35 mm format (new REMOTS) black and white negatives. These measurements were accomplished with the Measurionics LMStm Image Analysis System. Negatives were used instead of positive prints in order to avoid changes in image density that can accompany printing a positive image. The image analysis system is capable of detecting 256 grey scale values while density slicing and image. Data on grain-size estimates, evidence of surface erosion, and faunal information were determined from 8 X 10 inch positive prints.

Grain-Size Estimates: The major modal grain-size and subordinate modes are estimated from the photographs by overlaying a grain-size comparator which is at the same scale. This comparator was prepared by photographing a series of Udden-Wentworth size classes through the profile camera (equal to or less than coarse silt up to granule and larger sizes). Seven grain-size classes are on this comparator. The lower limit of optical resolution of the photographic system is about 62 microns, allowing recognition of grain sizes equal to, or greater than, coarse silt. The accuracy of this method

has been documented by comparing our REMOTS estimates with grain-size statistics determined from laboratory sieve analysis.

Boundary Roughness: The width of the optical window in the profile camera is 12.75 cm. The boundary roughness values represent the maximum topographic relief measured over this width.

Redox Areas and Depths: If there is oxygen in the overlying water column, the near surface sediment will have a high reflectance value relative to anoxic sediment underlying it. This is because the oxidized surface sediment contains ferric hydroxide (an olive color when associated with organic particles), while the hydrogen sulphide sediments below this oxygenated layer are grey to black. Although the high reflectance value of the surface layer is talked about in this report as the "oxidized layer", we acknowledge that sulphate reduction can take place in microanaerobic environments (interiors of fecal pellets or diatom frustules) within this ferric hydroxide zone. The boundary between the light colored ferric hydroxide surface sediment and underlying grey to black sediment is called the redox potential discontinuity and is abbreviated as the RPD.

The area of the positive (aerobic) RPD is determined with the Measuronic LMStm System by density slicing its unique reflectance value. This oxidized area can then be digitized and measured at scale. These cm² values are then divided by the prism window width to obtain a mean depth for the RPD. Our experience in central Long Island Sound has shown that in the absence of bioturbating organisms, the RPD depth is less than 0.5 cm thick in organic-rich muds. Pioneering stages have RPD depths generally less than ca. 3 cm deep, while mature infaunal successional stages have RPD depths

greater than 3 cm. The RPD depth is given special attention in our analysis as it is a sensitive indicator of infaunal succession, within station patchiness, and bioturbation activity.

Successional Stage: A detailed discussion of how the stage of succession can be deduced from REMOTS images is given in Rhoads and Germano (1982) and Rhoads and Boyer (1982). However, these two papers deal with primary succession, i.e., faunal colonization of a new or recently disturbed sedimentary surface. It is also possible to detect a condition of secondary colonization, i.e., the appearance of pioneering polychaete species on bottoms that are already populated by mature successional stage. This condition is transient and has been observed before. Pioneering species make appearances at the surface of mature systems in late summer and fall months. In our data coding we describe these associations as III-I, i.e., a Stage III mature assemblage invaded by a Stage I polychaete assemblage.

Habitat Index: A multi-parameter habitat index has been constructed to characterize habitat quality. Habitat quality is defined relative to two end-member standards. The lowest value is given to those bottoms which have low, or no dissolved oxygen in the overlying bottom water, no apparent macrofaunal life, and methane gas is present within the sediment (see Rhoads and Germano, 1982 for REMOTS criteria for these conditions). The habitat index for such a condition is minus 10. At the other end of the scale, an aerobic bottom with a deeply depressed RPD, evidence of a mature macrofaunal assemblage, and no apparent methane gas bubbles at depth will have a habitat index of plus 11.

The habitat index is arrived at by summing the subset indices below:

<u>Mean RPD Depth</u>	<u>Index Value</u>
0 - 0.75 cm	1
0.76 - 1.50 cm	2
1.51 - 2.25 cm	3
2.26 - 3.00 cm	4
3.01 - 3.75 cm	5
> 3.75 cm	6

<u>Chemical Parameters</u>	<u>Index Value</u>
Methane present	-2
No/low dissolved O ₂	-4

<u>Successional Stage</u> (primary succession)	<u>Index Value</u>
Azoic	-4
Stage 1	1
Stage 1-2	2
Stage 2	3
Stage 2-3	4
Stage 3	5

<u>Successional Stage</u> (secondary succession)	<u>Index Value</u>
Stage 1 on a Stage 3	5.00 ^I
Stage 2 on a Stage 3	5.00 ^{II}
HABITAT INDEX =	----- Total of all subset indices

RANGE : -10 TO +11

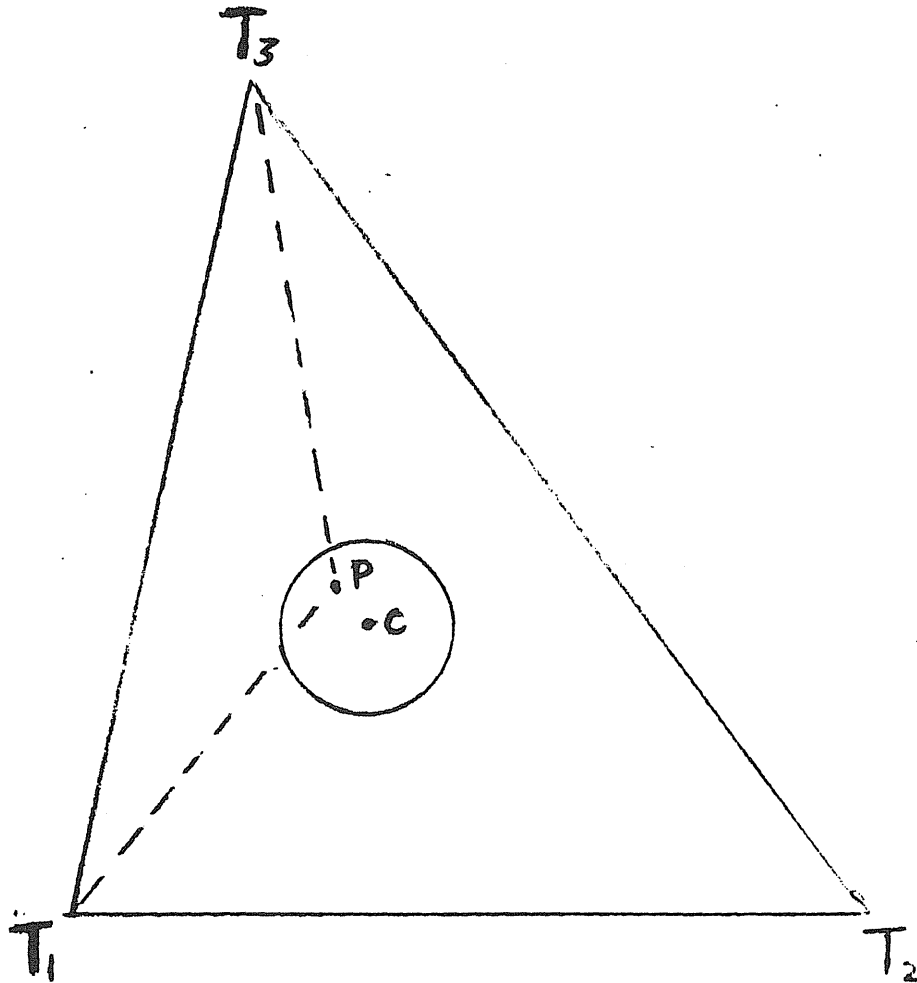

T_i; TRANSPONDERS
P; SAMPLE POINT
C; STATION CENTER

Figure III-1. Schematic of transponder installation for high density sampling at WTP10 (SIS) and WTP14 (TIP).

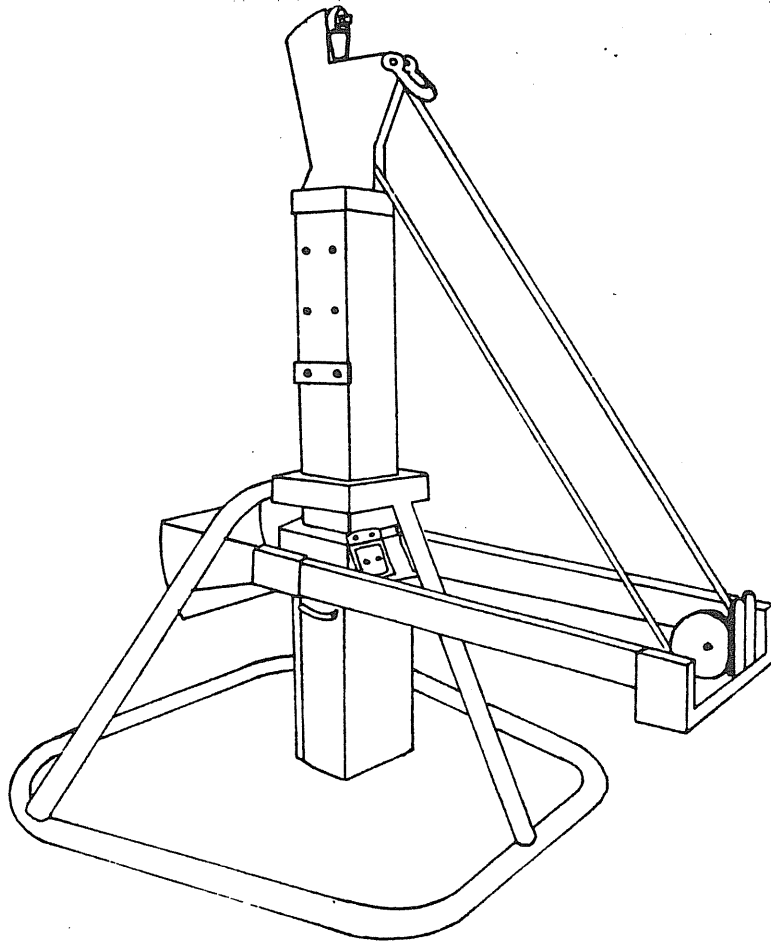

III-2. United States Naval Electronics Laboratory spade box core. This core samples a surface area of 0.06 m^2 to a maximum depth of 60cm.

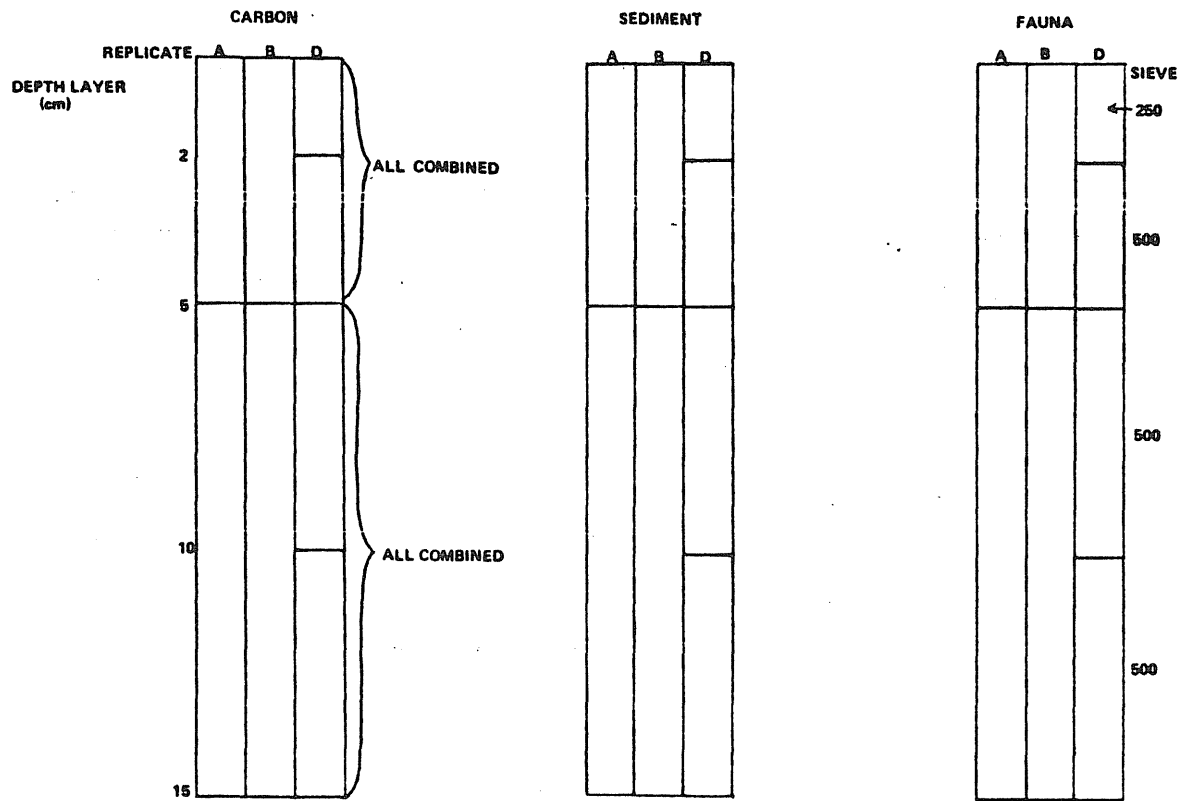

III-3. Samples resulting from the field processing of box core replicates A,B and D.

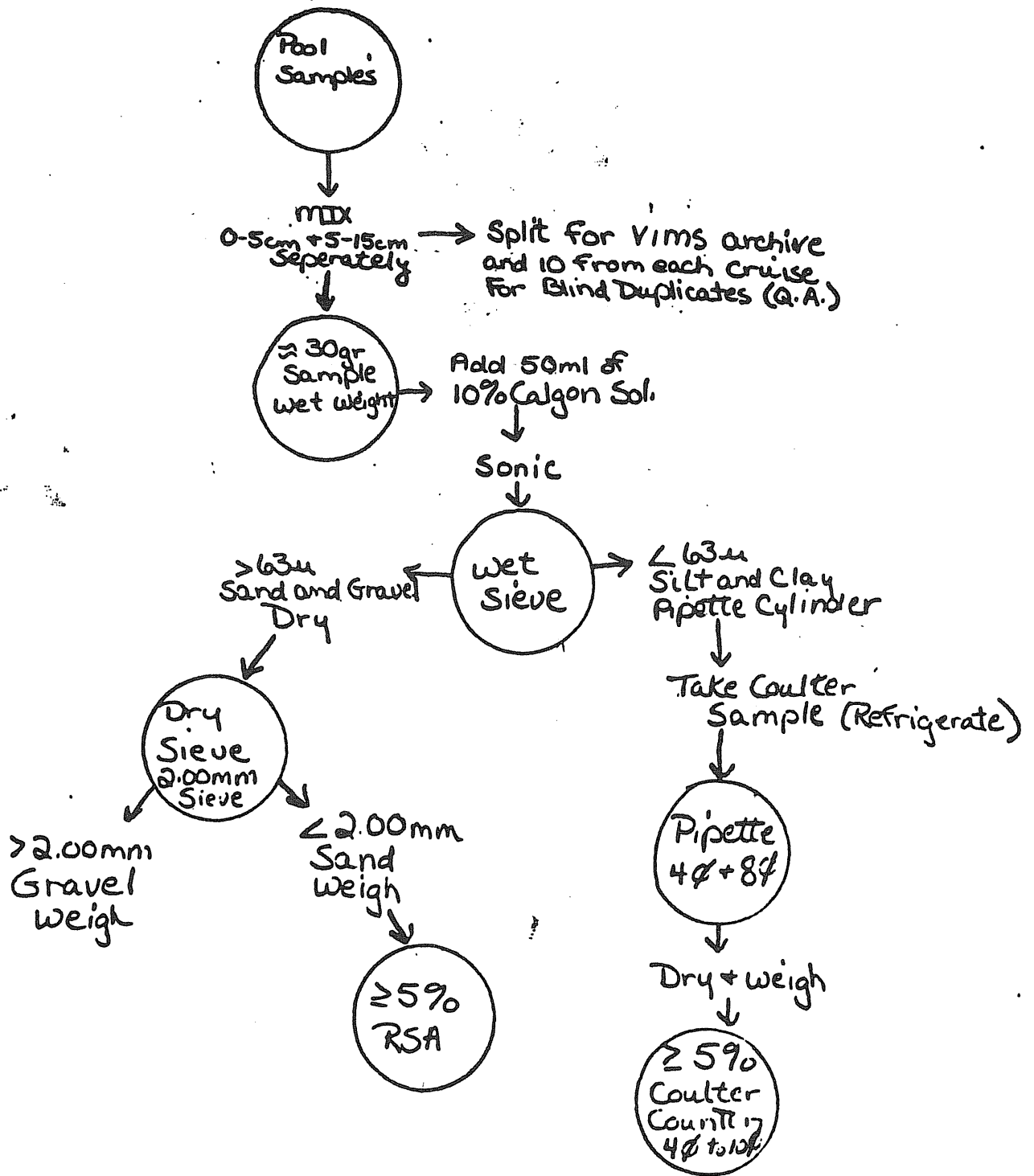

Figure III-4. Flowchart for sediment analyses.

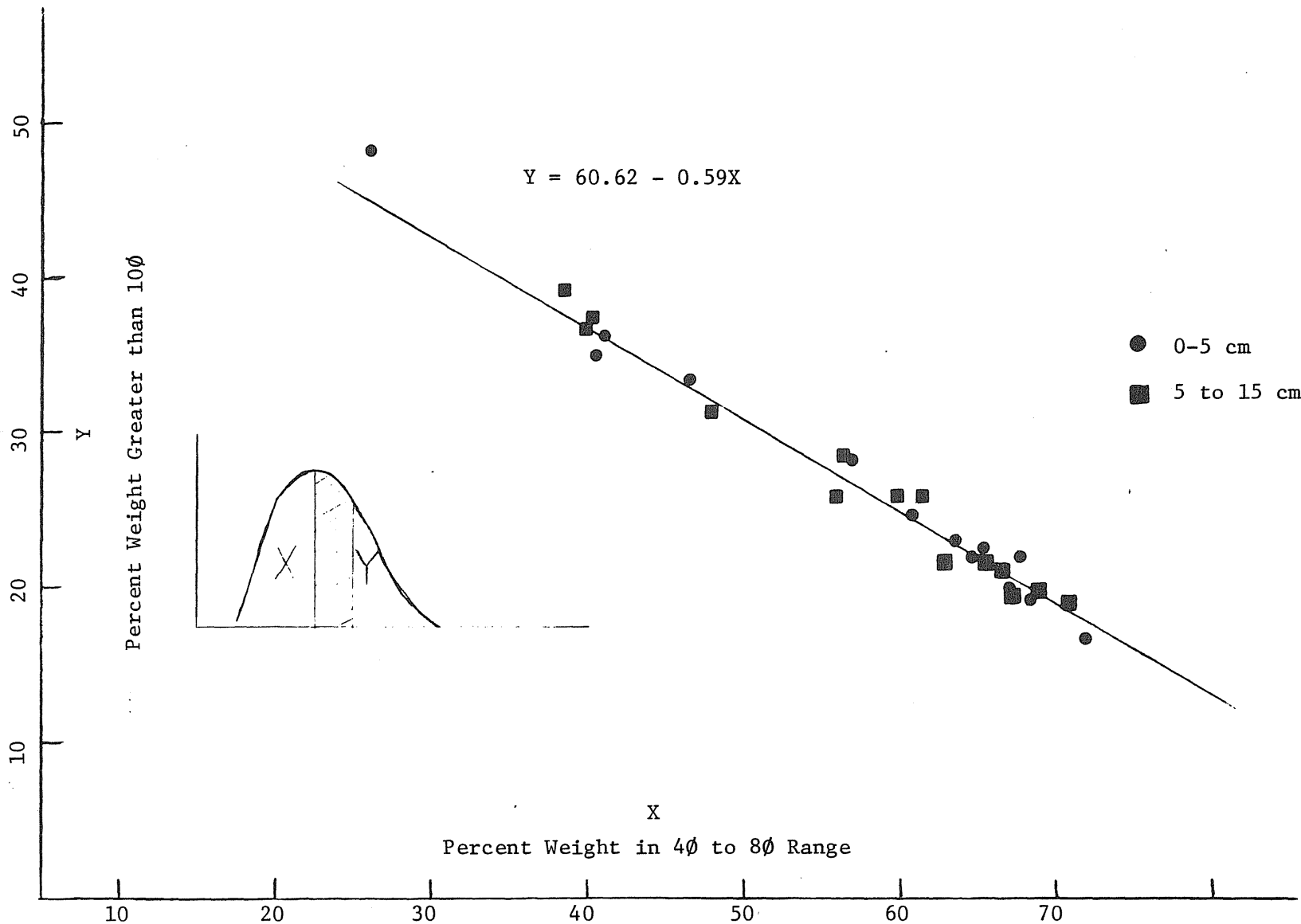

Figure III-5. Regression of percent weight in 4φ to 8φ size range versus percent weight finer than 10φ.

Table III-1. Values of R and I for Sand, Clay, and Graphic Mean.

SAMPLE NAMES (A)	(B)	% SAND			STATISTICS			% CLAY			STATISTICS			MEAN		STATISTICS		
		(A)	(B)	R	SUM	I	(A)	(B)	R	SUM	I	(A)	(B)	R	SUM	I		
Q.A.1	WAP102_5-15	62.1	62.0	0.1	124.1	0.0008	12.1	12.8	0.7	24.9	0.0281	4.1	4.1	0.0	8.3	0.0036		
Q.A.2	RAP162_5-15	91.1	92.4	1.3	183.5	0.0071	0.4	0.2	0.2	0.6	0.3333	1.6	1.5	0.1	3.0	0.0329		
Q.A.3	WTP102_5-15	35.6	42.8	7.2	78.4	0.0918	21.3	19.9	1.4	41.2	0.0340	5.9	5.6	0.2	11.5	0.0182		
Q.A.4	RSP052_5-15	2.6	3.0	0.4	5.6	0.0714	47.4	42.7	4.7	90.1	0.0522	8.3	8.2	0.0	16.5	0.0012		
Q.A.5	WAP052_5-15	59.6	57.8	1.8	117.4	0.0153	10.7	11.0	0.3	21.7	0.0138	4.4	4.6	0.2	9.0	0.0244		
Q.A.6	WAP022_5-15	40.1	39.9	0.2	80.0	0.0025	18.4	18.7	0.3	37.1	0.0081	5.5	5.4	0.0	10.9	0.0027		
Q.A.7	RSP032_5-15	90.6	90.7	0.1	181.3	0.0006	5.5	5.4	0.1	10.9	0.0092	2.3	2.2	0.1	4.5	0.0245		
Q.A.8	WAP132_5-15	56.8	56.5	0.3	113.3	0.0026	15.8	15.8	0.0	31.6	0.0000	4.3	4.5	0.2	8.7	0.0229		
Q.A.9	WTP162_5-15	97.5	97.4	0.1	194.9	0.0005	1.4	1.4	0.0	2.8	0.0000	2.2	2.2	0.0	4.5	0.0045		
Q.A.10	RSP142_5-15	86.9	87.0	0.1	173.9	0.0006	6.6	6.4	0.2	13.0	0.0154	2.1	2.2	0.0	4.3	0.0116		
Q.A.11	RAP102_5-15	1.2	1.1	0.1	2.3	0.0435	38.3	38.6	0.3	76.9	0.0039	8.0	7.8	0.2	15.8	0.0139		
Q.A.12	RSP112_5-15	59.6	56.0	3.6	115.6	0.0311	16.3	17.2	0.9	33.5	0.0269	4.0	4.4	0.4	8.4	0.0440		
Q.A.13	RSP162_5-15	0.5	0.9	0.4	1.4	0.2857	44.9	42.5	2.4	87.4	0.0275	8.3	8.3	0.0	16.6	0.0024		
Q.A.14	RSP022_5-15	1.5	1.7	0.2	3.2	0.0625	50.6	54.6	4.0	105.2	0.0380	8.6	8.9	0.3	17.5	0.0183		
Q.A.15	RSP092_5-15	87.6	88.3	0.7	175.9	0.0040	6.4	6.1	0.3	12.5	0.0240	2.2	2.1	0.0	4.3	0.0093		
Q.A.16	WTP142_5-15	58.7	66.1	7.4	124.8	0.0593	12.8	12.2	0.6	25.0	0.0240	4.7	4.6	0.0	9.3	0.0043		
Q.A.17	WTP072_5-15	57.4	60.1	2.7	117.5	0.0230	14.0	13.9	0.1	27.9	0.0036	4.3	4.4	0.0	8.7	0.0034		
Q.A.18	WTP012_5-15	49.5	51.1	1.6	100.6	0.0159	15.6	17.2	1.6	32.8	0.0489	5.1	5.2	0.1	10.4	0.0077		
Q.A.19	WSP052_5-15	60.0	64.4	4.4	124.4	0.0354	11.3	13.8	2.5	25.1	0.0996	4.3	4.4	0.1	8.7	0.0058		
Q.A.20	RSP182_5-15	84.9	88.3	3.4	173.2	0.0196	5.1	5.2	0.1	10.3	0.0097	2.4	2.3	0.1	4.7	0.0192		
Q.A.21	RSP023_5-15	1.4	1.2	0.2	2.6	0.0769	53.2	46.2	7.0	99.4	0.0704	8.9	8.6	0.3	17.5	0.0143		
Q.A.22	RGP123D_5-15	89.8	89.0	0.8	178.8	0.0045	5.2	6.3	1.1	11.5	0.0957	1.9	2.1	0.2	4.0	0.0524		
Q.A.23	RGP07A_5-15	82.9	82.3	0.6	165.2	0.0036	8.8	9.0	0.2	17.8	0.0112	2.7	2.8	0.1	5.5	0.0253		
Q.A.24	RSC013_5-15	2.3	4.2	1.9	5.5	0.2923	53.9	50.9	3.0	104.8	0.0286	8.9	8.6	0.3	17.5	0.0172		
Q.A.25	WTP083_5-15	62.0	64.7	2.7	126.7	0.0213	12.7	11.8	0.9	24.5	0.0367	4.6	4.4	0.2	9.0	0.0222		
Q.A.26	WLP043A_5-15	53.2	55.0	1.8	108.2	0.0166	15.4	15.5	0.1	30.9	0.0032	5.2	5.2	0.1	10.4	0.0058		
Q.A.27	WGP08E_5-15	57.0	59.3	2.3	116.3	0.0198	11.2	12.3	1.1	23.5	0.0468	4.7	4.5	0.1	9.2	0.0141		
Q.A.28	WGP23B_5-15	52.3	57.7	5.4	110.0	0.0491	15.0	15.4	0.4	30.4	0.0132	4.9	4.8	0.1	9.8	0.0092		
Q.A.29	RGP223A_5-15	93.5	91.3	2.2	184.8	0.0119	4.6	7.9	3.3	12.5	0.2640	1.9	2.1	0.2	4.0	0.0503		
Q.A.30	RLP153D_5-15	7.4	9.4	2.0	15.8	0.1190	26.8	31.1	4.3	57.9	0.0743	6.9	7.0	0.1	13.8	0.0072		
Q.A.31	RWE024B_5-15	9.6	7.6	2.0	17.2	0.1163	29.6	31.9	2.3	61.5	0.0374	7.0	7.1	0.1	14.0	0.0064		
Q.A.32	WSP02B4_5-15	79.7	75.0	4.7	154.7	0.0304	8.2	7.9	0.3	16.1	0.0186	3.5	3.8	0.3	7.3	0.0371		
Q.A.33	WSR08B4_5-15	95.9	97.8	1.9	193.7	0.0098	1.5	0.6	0.9	2.1	0.4286	1.9	2.1	0.2	3.9	0.0486		
Q.A.34	YSC09D4_5-15	81.3	81.7	0.4	163.0	0.0025	5.6	5.5	0.1	11.1	0.0090	3.6	3.6	0.0	7.2	0.0028		
Q.A.35	RWE094A_5-15	87.3	88.2	0.9	175.5	0.0051	7.0	6.9	0.1	13.9	0.0072	1.9	2.1	0.1	4.0	0.0300		
Q.A.36	WER03D4_5-15	65.6	66.4	0.8	132.0	0.0061	10.2	9.7	0.5	19.9	0.0251	4.2	4.2	0.0	8.4	0.0012		
Q.A.37	WSP09D4_5-15	82.8	83.6	0.8	165.4	0.0048	4.7	5.6	0.9	10.3	0.0874	1.9	2.3	0.3	4.2	0.0810		
Q.A.38	WER06D4_5-15	74.9	75.3	0.4	150.2	0.0027	7.3	6.9	0.4	14.2	0.0282	3.8	3.8	0.0	7.6	0.0013		
Q.A.39	WSP03D4_5-15	96.6	88.3	1.7	174.9	0.0097	3.0	3.6	0.6	6.6	0.0909	1.4	1.8	0.4	3.2	0.1125		
Q.A.40	WSR07A4_5-15	82.7	83.1	0.4	165.8	0.0024	6.1	5.9	0.2	12.0	0.0167	2.8	2.9	0.0	5.7	0.0035		
Q.A.41	RSP195_5-15	88.8	88.5	0.3	177.3	0.0017	6.9	6.6	0.3	13.5	0.0222	3.0	2.1	0.9	5.0	0.1809		
Q.A.42	YSC045A_5-15	82.5	81.5	1.0	164.0	0.0061	3.8	6.0	2.2	9.8	0.2245	3.6	3.6	0.1	7.2	0.0084		
Q.A.43	SIS055B_5-15	37.6	37.0	0.6	74.6	0.0090	20.2	22.8	2.6	43.0	0.0605	5.7	6.1	0.4	11.8	0.0332		
Q.A.44	WAC015_5-15	68.3	71.4	3.1	139.7	0.0222	7.9	10.4	2.5	18.3	0.1366	3.3	3.7	0.3	7.0	0.0442		
Q.A.45	RTT035D_5-15	84.0	84.3	0.3	168.3	0.0018	8.5	8.4	0.1	16.9	0.0059	2.2	2.2	0.0	4.4	0.0114		
Q.A.46	YSC035D_5-15	80.2	80.4	0.2	160.6	0.0012	4.6	7.7	3.1	12.3	0.2520	3.6	3.6	0.0	7.2	0.0042		
Q.A.47	WTT065D_5-15	55.5	56.2	0.7	111.7	0.0063	14.4	16.1	1.7	30.5	0.0557	4.7	4.9	0.2	9.6	0.0195		
Q.A.48	RCR125D_5-15	16.3	15.0	1.3	31.3	0.0415	28.6	32.4	3.8	61.0	0.0623	6.6	7.0	0.4	13.6	0.0308		
Q.A.49	WSP035B_5-15	85.5	85.6	0.1	171.1	0.0006	5.6	5.1	0.5	10.7	0.0467	1.5	1.4	0.1	2.9	0.0242		
Q.A.50	RTT015A_5-15	85.3	86.5	1.2	171.8	0.0070	7.4	6.3	1.1	13.7	0.0803	1.6	1.9	0.2	3.4	0.0493		
Q.A.51	RRS025B_5-15	23.9	27.5	3.6	51.4	0.0700	24.1	29.3	5.2	53.4	0.0974	6.3	6.5	0.2	12.8	0.0140		

Table III-2. Estimates of the Range and Industrial Statistic, I of % Sand, % Clay, and Graphic Mean.

Parameter	Range of A+E	No. of Sets of Duplicates	A+B*	R*	I*
Sand	160-200	21	174.5	0.88	0.0050
	100 to <160	17	122.8	2.58	0.0210
	40 to <100	4	71.1	2.90	0.0431
	0 to < 40	9	9.6	0.94	0.1232
Average				1.62	0.0342
Clay	160-200	0	-	-	-
	100 to <160	2	105.0	3.50	0.0333
	40 to <100	10	67.2	3.40	0.0520
	0 to < 40	39	17.8	0.78	0.0680
Average				1.40	0.0600
Mean	0 to < 4	6	3.4	0.18	0.0529
	4 to < 8	18	5.5	0.16	0.0306
	8 to < 16	22	10.6	0.15	0.0143
Average				0.16	0.0242

*Average values within range limits.

PART IV: WOLF TRAP STUDY RESULTS AND DISCUSSION

Faunal Composition

A total of 192 taxa were collected from the Wolf Trap Study Region. Of these 140 were identified to species level. The 50 taxa not identified to species represented, for the most part, juveniles or complex taxonomic groups such as oligochaetes.

Polychaete annelids numerically dominated the collections at all stations, comprising about 77% of all individuals. At least 68 taxa comprising 26 families of polychaetes were collected from all five cruises (Table IV-1). The second most abundant group were the molluscs representing about 10% of all individuals with 49 taxa. There were 25 gastropod and 24 bivalve taxa collected from all five cruises. Crustaceans were the third most abundant group with about 9% of the individuals and 57 taxa. Most of the crustaceans were amphipods, with 23 taxa, and decapods, with 16 taxa.

The remaining 10 major taxonomic groups (phyla) were only 4% of all the individuals and 18 taxa. The nemertean worms were the only abundant taxa in this grouping and represented about 2% of all individuals with 5 of the taxa. The remaining nine major taxa in decreasing order of abundance were: Turbellaria, Cnidaria, Echinodermata, Phoronida, Hemichordata, Urochordata, Ectoprocta, Echiurida, and Porifera.

The faunal composition between the Wolf Trap Primary and Alternate sites was virtually identical with approximately the same proportions of individuals of each major taxa group occurring at each of the sites. Of the 192 taxa that occurred at both sites 19 taxa did not occur at WTP and 22 taxa did not occur at WAP (Table IV-1).

Of the twenty most widely distributed taxa in the Wolf Trap region 13 were polychaetes, 2 were amphipods, and one each was a polyclad, nemertean, echinoderm, gastropod, and bivalve. The frequency of occurrence of these and the other taxa is contained in Table IV-1.

Abundance

A total of 64,760 individuals were collected from the Wolf Trap Study Region. The range in total taxa abundance was from 63 to 1,356 individuals/0.12 m². On average there were 494 individuals/0.12 m². The WTP site had slightly higher abundances, 550/0.12 m², than the WAP site, 439/0.12 m². Densities tended to be lower along the western side of the region. Overall lowest densities occurred in the summer (Table IV-2).

There were 78 taxa that occurred at 15% of the station x cruise combinations. The average abundance of these taxa grouping the stations by disposal area, fringe area, and control stations is presented in Table IV-3. There were few large differences between the disposal and fringe areas for both WTP and WAP. This indicated that there were no sharp differences in the data set. This was further confirmed by the classification analysis. The control stations for WTP seemed to be most different with respect to the other WTP stations. Many species had lowest averaged abundances at the WTP control stations. The WAP controls were closer to the general average abundances found in the WAP disposal and fringe stations.

If the entire data set (WTP and WAP) is averaged by season it can be seen that none of the 78 dominant taxa had large recruitments during any of the collection periods (Table IV-2). The largest recruitment was for Paraprionospio pinnata from the summer to fall cruises. It increased by 82

individuals/0.12 m². Overall the abundance of the less abundant taxa (less than 4 ind/0.12 m²) did not change very much. For the more abundant species there was a general decline in abundance through time.

Diversity

The number of species at each station in the Wolf Trap Study region ranged from 19 to 69 per 0.12 m² during the five cruises. On average there were 40.9 species collected at each station each cruise. If all the species collected during the five cruises are summed by station the range was 52 to 93 species occurring at a station. Through time there was a decline in overall species occurrence throughout the Wolf Trap Study Region. There was no pattern in total species occurrences between fringe and disposal areas (Table IV-4).

Diversity, as measured by H', ranged from 1.93 to 4.89 during the five cruises. On average H' was about 3.93 for the entire Wolf Trap Study region. Lowest diversity values occurred along the western boundary of the area. Through time diversity tended to decline slightly. The largest differences in seasonal diversity occurred between the Fall collections, with the Fall of 1984 being higher than 1985 (Table IV-4). There were no patterns in diversity that related to fringe or disposal areas. However, diversity values on the western side of the region tended to be lower than the eastern side.

Evenness ranged from 0.56 to 0.87 and was 0.74 on average in the Wolf Trap study region. Evenness on average change very little from season to season. The biggest changes occurred between the two fall seasons, with the fall of 1985 being lower (Table IV-4).

Community Patterns

Patterns in station resemblance on species distribution were identified using numerical classification. The Bray-Curtis similarity measure and flexible sorting on square-root transformed data was used to classify the data set. When each station and each-cruise were kept separate a break occurred in the data separating the majority of the Summer and Fall 1985 stations, and the muddier stations from all seasons from the Fall 1984, Winter, and Spring stations, and the sandier stations from the Summer and Fall 1985 stations. This pattern was due to the gradual changing abundance of species through the study period. Overall there was a decline in the abundance of many of the dominant species.

There were four station groups within each of the two major clusters (Figure IV-1). Group A1 was the Fall 1984 stations. Group A2 was the Winter stations. Group A3 was a mixture of stations from all cruises but contained most of the Spring stations. The Summer and Fall 1985 stations in Group A3 were the ones where declines in dominant species was not great. Group A4 was mostly fall 1984 and 1985 stations. Within Groups A3 and A4 there were several stations which included three or four of the five seasonal collections. Group B1 was the summer stations. Group B2 was the muddier stations from the western side of WTP and WAP. It also included the absent sand station WTP16. Group B3 was also muddy stations. Group B4 was Fall 1985 stations. Groups B2 and B3 also contained several stations which included three or four of the five seasonal collections.

There was no separation of fringe or disposal area stations within this classification analysis. Each of the cluster groups contained stations from both sites (WTP and WAP). Overall the biological homogeneity of the Wolf Trap Study Region is reflected in the high similarity among stations.

Detailed ordination analysis of the Wolf Trap data from the winter cruise confirmed the gradual gradient nature of change at the Wolf Trap region (Schaffner et al., 1985). Through time, from Fall 1984 to Fall 1985, this similarity declined somewhat.

To see the overall patterns in station resemblance all data from each cruise for a station were combined and classification analysis done. The stations were classified into five groups as indicated in Figure IV-2. Group A stations were located along the eastern side of the study region. Group B stations were located through the central area of WAP and most of the WTP site. Group C stations was primarily along the muddier western side of both sites. Group D stations were outliers being very muddy. The Group E station was also an outlier, being the only station within the Wolf Trap Study Region to be medium sand.

Inverse classification of the top 78 species (dropping species that did not occur in 19 of the 13 station x cruise combinations) from all five cruises in the Wolf Trap Study Region produced six major groupings of species (Figure IV-3). Group 1 species were low in abundance throughout the study area, both spatially and temporally. Group 1 also contained some of the larger species found, such as the burrowing anemone Ceriantheopsis americanus, the hemichordate Saccoglossus kowalewskii, and the nemertean Micrura rubra and Cerebratulus lacteus. Group 2 was a small group of epifaunal species that occurred mainly on hydroids (primarily Sertularia argentea) or other hard substrates. Species in Group 3 overall were low in abundance but during at least one season some of them peaked from recruitment. For example Polydora ligni recruitment in Spring and Mulinia lateralis in Summer. Group 4 species were consistently abundant and widely distributed throughout WTP and WAP. Group 5 species were lower in abundance

and not quite as widely distributed as Group 4 species. Group 6 species were the top dominants both spatially and temporally.

Species Patterns

Of the total 192 taxa collected from the Wolf Trap Study region 24 accounted for almost 90% of all individuals. The patterns in the distributions of these taxa are presented in Figures IV-4 to IV-29. Of these 24 taxa 15 were polychaetes, three were amphipods, three were bivalves, and one each was a gastropod, Nemertean, and polyclad. Ecological information on these species is summarized in Table IV-5.

More than half of the dominant species are sessile or discretely motile, many building tubes. The other dominant faunal type was carnivory, with at least six species. The high density of predators is probably related to the presence of an abundant and diverse food source. There are also several commensalistic and epifaunal species that are dominant. These are associated with the tubes of larger organisms, such as the polychaete Chaetopterus variopedatus.

Overall the general pattern for about half of these 24 taxa was to decline in abundance from the fall of 1984 to the fall of 1985. The decline for the most part was gradual with neither the Wolf Trap Primary or the Wolf Trap Alternate site showing a different rate of decline. There was also no differential rate in decline between the disposal and fringe areas. Two of the major tube builders declined precipitously, Chaetopterus variopedatus and Clymenella zonalis (Figures IV-4 and IV-5). The change in these species may have led to declines in other species, such as Listriella barnardi (Figure IV-6), which is commensal with these tube builders. Burrowing

polychaetes also declined, such as Notomastus latericeus, Glycera americana, and Gyptis brevivalpa (Figures IV-7 to IV-9).

For other species the decline was more erratic, with there being more variability between seasons and sites. These were Ampelisca abdita, Tubulanus pellucidus and Bhwania goodei (Figures IV-10 to IV-12). Macoma tenta and Macoma spp., likely all juvenile M. tenta, were variable but when both taxa were combined the pattern of overall decline was apparent (Figures IV-13 to IV-15). The same was true for Nephtys picta and nephtyids, juvenile Nephtys picta or bucera. By itself N. picta increased in the summer and fall 1985 cruises, but overall the Nephtyids declined throughout the study (Figures IV-16 to IV-18).

Five taxa exhibited a pattern of seasonality with recruitment occurring in the Fall. For Loimia medusa, Paraprionospio pinnata, and Glycinde solitaria this pattern was most obvious (Figures IV-19 to IV-21). For Sigambra tentaculata and Cirratulids this pattern was muted with smaller increase in the Fall of 1985 (Figures IV-22 and IV-23).

Three species, Mulinia lateralis, Polydora ligni, and Pseudeurythoe paucibranchiata, had strong spring or summer recruitments (Figures IV-24 to IV-26). Only P. ligni set uniformly over all areas. The other two species were much more variable as to the spatial distribution of recruitment.

Polyclads and Acteocina canaliculata had very variable patterns with no clear trends (Figures IV-27 and IV-28). Listriella clymenellae was the only species did not seem to decline at the Wolf Trap Primary site but did at the Wolf Trap Alternate site (Figure IV-29).

REMOTS

Boundary roughness frequency distributions for each season at the Wolf Trap Primary Site are shown in Figure IV-30, and summary statistics are given in Table IV-6. Small-scale topographic relief was relatively low in both winter and spring. In summer, there was a significant increase in boundary roughness, attributed to biogenic relief produced by the fecal cones of maldanid polychaetes. Enhanced boundary roughness promotes turbulence and fluid shearing of the sediment-water interface. Perhaps due to this factor, as well as the seasonal increase in hydrologic action, boundary roughness values return to the Spring levels by Fall 1985.

Areas of eroding or unstable bottom were detected in all seasons surveyed. Evidence of an unstable surface can be detected in REMOTS images by the presence of surface mud clasts, shell lag deposits, bedforms, and certain biogenic structures, such as maldanid tubes projecting above the interface. One or more of the above features was observed at 56% of the Wolf Trap Primary stations in the Winter, 48% in Spring, 22% in Summer, and 62% in Fall. This seasonality in surface erosion was probably related to seasonal patterns in both biological sediment reworking activity and current action.

In Spring, evidence of sediment deposition was detected in REMOTS images from both the WTP and WAP sites. These deposits were termed Recently Deposited Sedimentary Intervals (RDSI's) and were recognized in images as sedimentary intervals overlaying a buried (relict?) positive redox or as a layer of floccular material overlaying a mat of polychaete tubes.

Frequency distributions of the mean apparent RPD depth from each survey are shown in Figure IV-31, and summary statistics are given in Table IV-6. RPD depth increases gradually from February to May (major mode increased

from 6 to 8 cm). Between May and August, RPD's deepen dramatically (major mode of 19 cm), apparently due to increased bioturbational activity. In October, RPD depths decrease (major mode of 4 cm) to the lowest values observed in any of the baseline surveys. The reason for this dramatic decrease is unclear, but it was probably related to one or more of the following factors: Seasonal reduction in bioturbational pumping or decreased concentration of dissolved oxygen in bottom waters.

Contour maps of Wolf Trap Site RPD depths, averaged by station, from each survey are given in Figure IV-32. The progressive summer deepening and the Fall rebound are apparent in these maps. However, no obvious within-grid (disposal or fringe areas) spatial patterns emerge between surveys. The area of seafloor contained between each 1 cm RPD contour interval is given in Figure IV-33.

All Wolf Trap Primary Site stations were occupied by a mature infaunal assemblage (Stage III or III-I) throughout the baseline year. The animal-sediment interactions at this site are complex and well-developed, producing intensively bioturbated sediments. Because active feeding voids are as abundant in October as in the preceding surveys, the shallowing of the apparent RPD's at that time was probably not related to retrograde succession, but rather to the factors listed.

Frequency-distributions of benthic index values for each survey are shown in Figure IV-34, and summary statistics are given in Table IV-6. Benthic indices were high (dominated by +11 values) in all surveys, reflecting the presence of mature infaunal assemblages throughout the site. There was no difference in the index values between February and May, nor between May and August. In October however, there was significantly lower indices (more values from +6 through +10) than in August.

At the Wolf Trap Alternate site, the boundary roughness frequency distributions for each season are shown in Figure IV-35, and summary statistics are given in Table IV-7. The seasonal pattern of change in small-scale topographic relief was similar to that observed at the Wolf Trap Primary site. Boundary roughness was uniform and slight from winter to spring. In summer, small-scale roughness increased significantly, reflecting enhanced biogenic relief. In the fall, boundary roughness at Wolf Trap Alternate remained at the summer levels. This was in contrast to the decrease in roughness at the Wolf Trap Primary Site.

Evidence of eroded or unstable bottom was detected at 60% of the Wolf Trap Alternate stations in February, 63% in May, 17% in August, and 48% in October. This seasonality in surface erosion was comparable to that observed at the Wolf Trap Site; it probably was related to seasonal patterns in biological sediment reworking and in hydrologic forces. Even stations consisting of fine-grained sediments ($\geq 4 \phi$, e.g. WAS01, WAP01, and WAS03) show evidence of surface erosion in all surveys, except August. At both Wolf Trap sites, there were no obvious spatial patterns in the distribution of erosional criteria, i.e. unstable bottom was observed in all portions of the grids. Both sites appear to be fairly uniform, dynamic benthic environments.

Frequency distributions for the apparent RPD depths from each survey are given in Figure IV-36, and summary statistics are shown in Table IV-7. The seasonal pattern of change in RPD depths at WAP was identical to the pattern observed at the Wolf Trap site, showing a progressive deepening from February through August followed by a sharp rebound in October (major modes equaled 6 cm in February, 8 cm in May, 19 cm in August, and 4 cm in October.) The October RPD values at both Wolf Trap and Wolf Trap Alternate

approach the values of the previous February. Moreover, in the November, 1983 shakedown cruise, the major modal RPD depth of the 15 Wolf Alternate stations surveyed was 4 cm; this suggests that the observed pattern represents an annual cycle.

Contour maps of RPD depths for each season are given in Figure IV-37. In addition to the progressive summer deepening and the Fall rebound, some within-grid patterns emerged. RPD depths appear to be consistently shallower toward the northwest corner of the grid (the area of especially fine-grained sediments). Relatively deep RPD's were evident in an area between the center and the southwest corner of WAP. Frequency distributions of the percentage areal coverage of each 1 cm contour interval are shown in Figure IV-38.

The Wolf Trap Alternate site, with the exception of several stations in the northwest corner of the grid (WAS01, WAP01, WAS03, and WAP01), is dominated by Stage III (or III-I) assemblages throughout the study. In the northwest corner, Stage I infauna are most abundant. As observed at the Wolf Trap site, the Stage III infauna at Wolf Trap Alternate consist of deep-dwelling, bioturbating deposit feeders, predominantly maldanid polychaetes. Complex burrow structures and/or feedings voids were evident in most of the REMOTS images from WAP.

Frequency distributions of benthic indices from each survey are shown in Figure IV-39, and summary statistics are given in Table IV-7. Comparable to the Wolf Trap site, the Wolf Trap Alternate region was dominated by high benthic indices (+11) throughout the year. A significant temporal change occurred between August and October when there was a general decrease in values. The October index values are not significantly different from the February values, again suggesting an annual cycle. The benthic indices in

the northwest corner of the Wolf Trap Alternate grid were consistently lower than those in the remainder of the site, reflecting shallow RPD's and low-order successional stages.

Sediments

The results of the sediment analyses are presented in full in Appendix B. Appendix B1 contains tabular listings for all samples with values of percent weight gravel, sand, silt, and clay, and the graphic statistical measures. Appendix B2 contains the cumulative size frequency curves and a complete listing of the graphic and moment measures. A summary of percent weight gravel, sand, silt, and clay for all of the stations within the two Wolf Trap disposal areas (sites plus fringes) is given in Table IV-8.

Spatial Variations: The results of Cruises 1 and 2 (Fall, 1983, and Winter, 1984) exhibit a pronounced east-west gradient in sediment size in both of the Wolf Trap disposal areas. The gradient is reflected in the sand fraction percentage as shown in Figure IV-40. The disposal areas are part of a larger scale cross-Bay gradient (Byrne, et al, 1982) with the eastern side of the Bay having very high sand content, Figure IV-41. The disposal areas are located in a mid-Bay plain which reflects the transition to higher mud content. Aside from an oceanic source the principal potential sources of mud are the western shore tributaries and sediments derived from the upper Bay.

Within the two Wolf Trap disposal areas the average sand content is similar if station WTP16 is excluded. That station exhibits a very high sand content relative to the surrounding stations. One of the box-cores recovered (Cruise 2), when sliced horizontally, showed a large (~10 cm)

oxidized fine-grained sediment pocket. This is suggestive of dredged material placement. In order to better define the extent of the sand anomaly a higher density sampling was conducted during Cruise 4. Figure IV-42 indicates the results portrayed as weight percent sand. The high sand content (<70% sand) zone is about one nautical mile in length, elongated in the north-south direction, and it coincides with the minor topographic elevation shown on NOAA Chart 12221. Cross-Bay seismic survey lines taken within one-half nautical mile north and south of the zone give no suggestion of a stratigraphic feature. The sand anomaly thus does not appear to represent an exposure of relict topography. The evidence to date suggests that the sand zone is due to placement of dredged material. The closest channel maintenance project is the entrance to Winter Harbor. High resolution, shallow seismic surveys, and/or vibracores would be necessary to resolve the question.

Additional high density sampling was conducted in other areas to discern spatial changes at scales within one kilometer. During Cruise 3 (Spring, 1984), a 7 x 4 grid was sampled between WTP14 and WTP18 (see Figures II-5D and II-5E), as was a 1 x 9 line array between WAP11 and WAP15 (see Figures II-5D and I-5F). Within the grid the percent weight of sand (0-5 cm) varied between 52 and 67 percent, and clay content between 12 and 16 percent. No gradients are apparent. At the line array the sand fraction varied between 46 and 58 percent weight, and clay varied from 12 to 15 percent with no gradient apparent. Thus, in both cases the variation in sand/silt/clay within a scale of 0.3 mile is as large or larger than that found over two or three miles of the eastern portion of the two Wolf Trap disposal areas.

The smallest scale of spatial variation examined was that within a 100 meter diameter circle. This was examined in fall, 1984 (Cruise 5) at stations WTP10 and WTP14. At each station 18 box-cores were obtained. The core locations are shown in Figure II-7E and 7F. Station WTP10 reflects mixed sediments while station WTP14 is located in an area of muddy sands. In neither case did the high density sampling reveal gradients in sediment texture within the station target circle. The relevant summary statistics for percent sand, percent clay, and mean grain size for the 0 to 5 cm horizon are summarized below.

	WTP10 "SIS" -----	WTP14 "TIP" -----
Average % wt. Sand	34.8%	57.3%
Standard Deviation	4.35%	5.28%
Range	29 to 45%	46 to 67%

Average % wt. Clay	20.8%	14.5%
Standard Deviation	1.96%	1.52%
Range	18 to 24%	12 to 18%

Average of Mean Grain Size (ϕ)	5.83 ϕ	4.80 ϕ
Standard Deviation	0.28 ϕ	0.30 ϕ
Range of Mean	5.36 to 6.41 ϕ	4.11 to 5.16 ϕ

The levels of variation between the two stations are very similar. The results at WTP14 indicate that as much variability exists at the finest scale as was found within the grid array adjacent to WTP14.

Variations With Depth: The sediments were sampled and analyzed over two depth horizons, 0-5 cm and 5 to 15 cm. This allows examination of the question as to whether there exists differences between two horizons. Some vertical grading of the bed sediments might be expected given the concentration of subsurface deposit feeders. In this case the upper horizon (0-5 cm) may have relatively higher silt and clay content. The data of Table IV-8 for the fixed primary station are used to examine the percent weight of the sand fraction in the two horizons. The results are shown in Figures IV-43 and IV-44. Both disposal areas exhibit enhanced relative sand content in the 5-15 cm horizon.

Temporal Variations: The REMOTS imagery, discussed previously, provided evidence of an unstable sediment interface as reflected by surface mud clasts, shell log deposits, bedforms, and exposure of worm tubes. Sediment deposition was reflected in buried (relict ?) positive redox or as a layer of floccular material overlying a mat of polychaete tubes. The sediment analyses summarized in Table IV-8 do not provide unequivocal evidence of temporal variation in sediment texture. While at-a-station ratios of surface (0-5 cm) sand/silt/clay may show small seasonal variation these changes cannot be differentiated from the spatial, with-a-station, variability as reflected by the high density sampling at WTP10 and WTP14.

Total Organic Carbon: Table IV-9 lists the results in percent weight total organic carbon for the Wolf Trap disposal areas. Only few stations have values as high as 1% by weight. These findings are consistent with earlier (1978-1979) measurements for this area (Byrne, et. l., 1982).

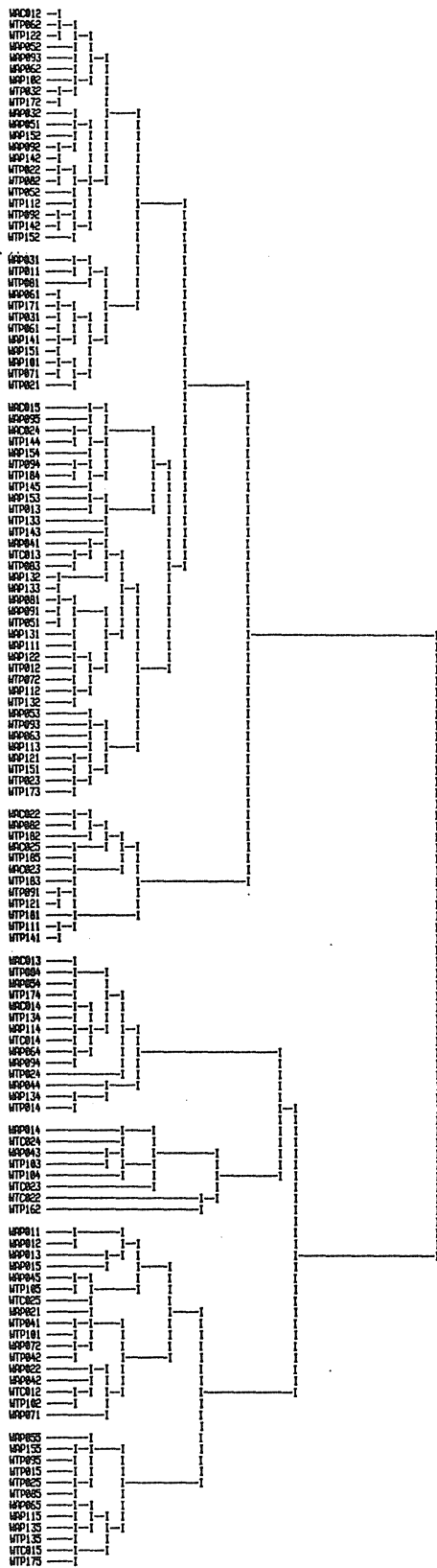

Figure IV-1. Station cluster groups formed by classification of all stations for each cruise at the Wolf Trap Study Region.

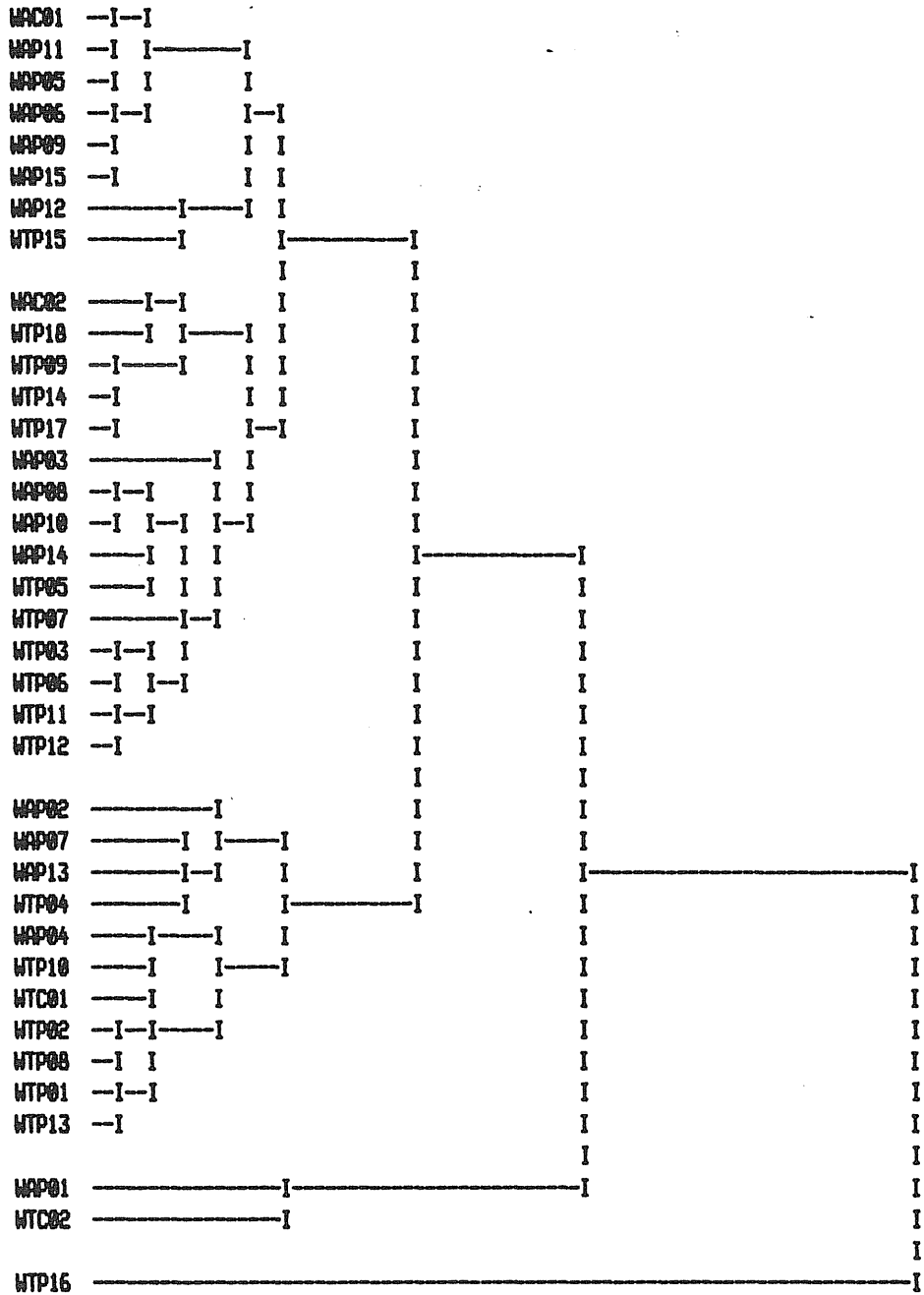
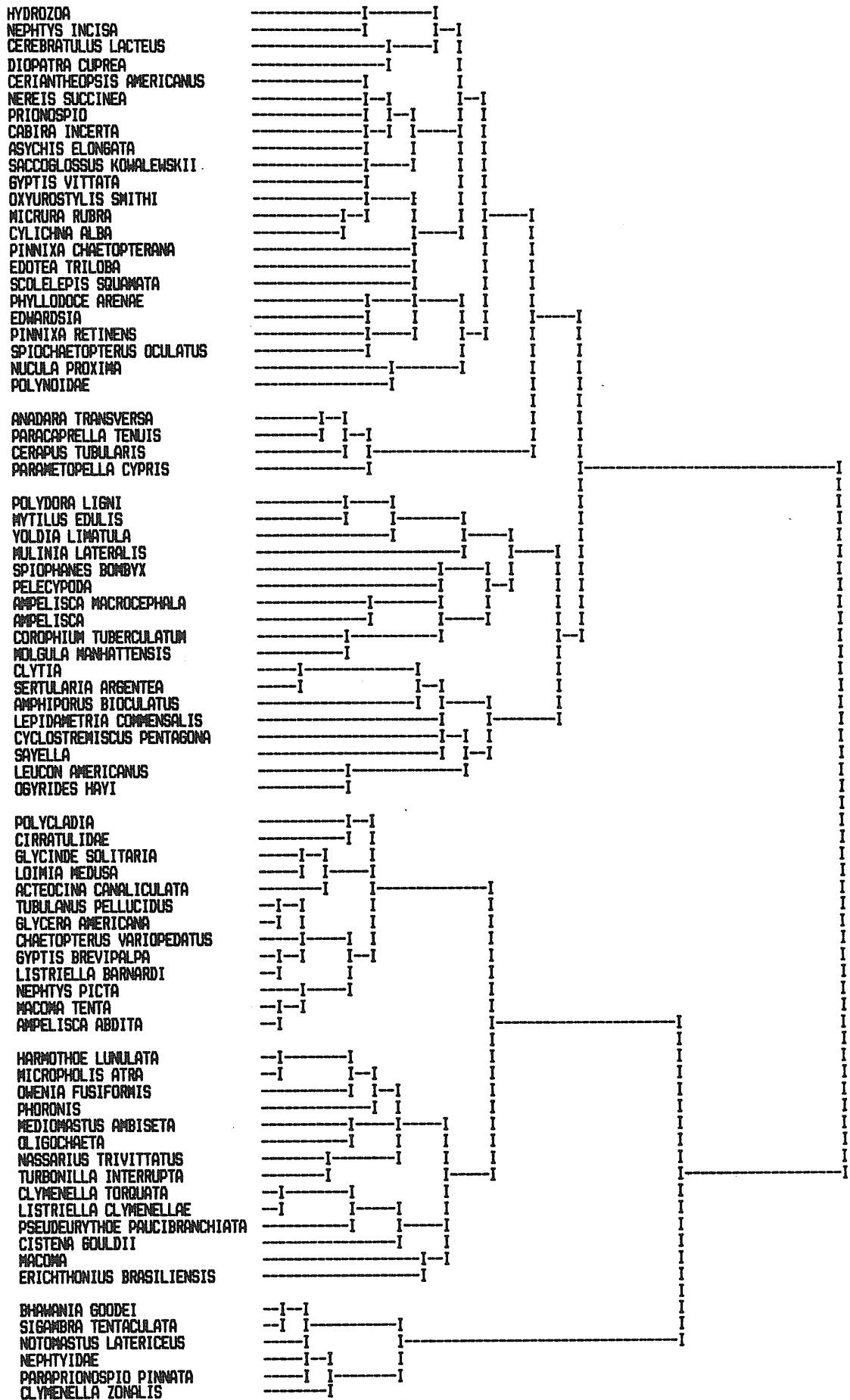

Figure IV-2. Station cluster groups formed by classification of all cruises combined by station at the Wolf Trap Study Region.

Figure IV-3. Species cluster groups formed by classification of all stations for each cruise at the Wolf Trap Study Region.



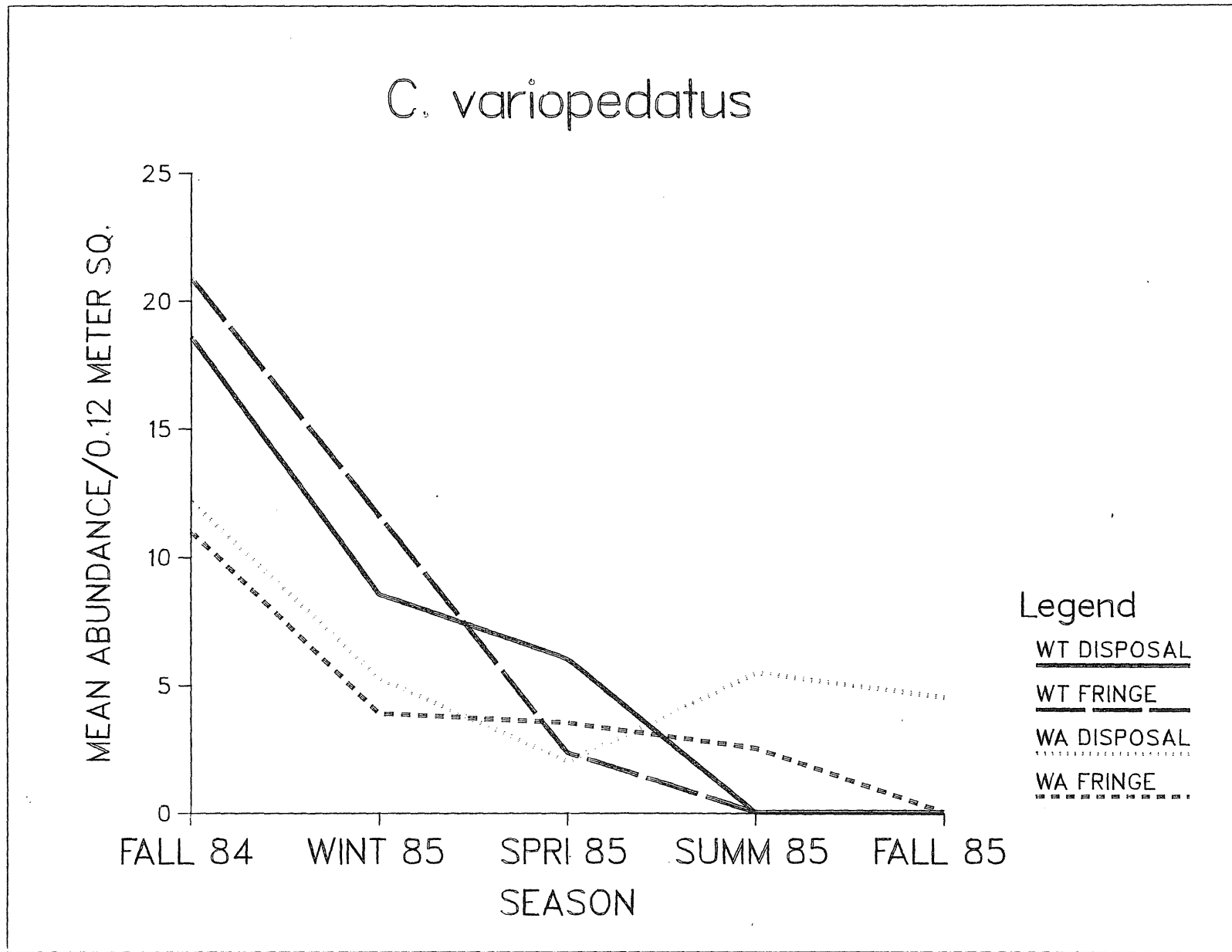

Figure IV-4. Seasonal abundance of *Chaetopterus variopedatus* averaged by site, and disposal or fringe areas for Wolf Trap Study Region.

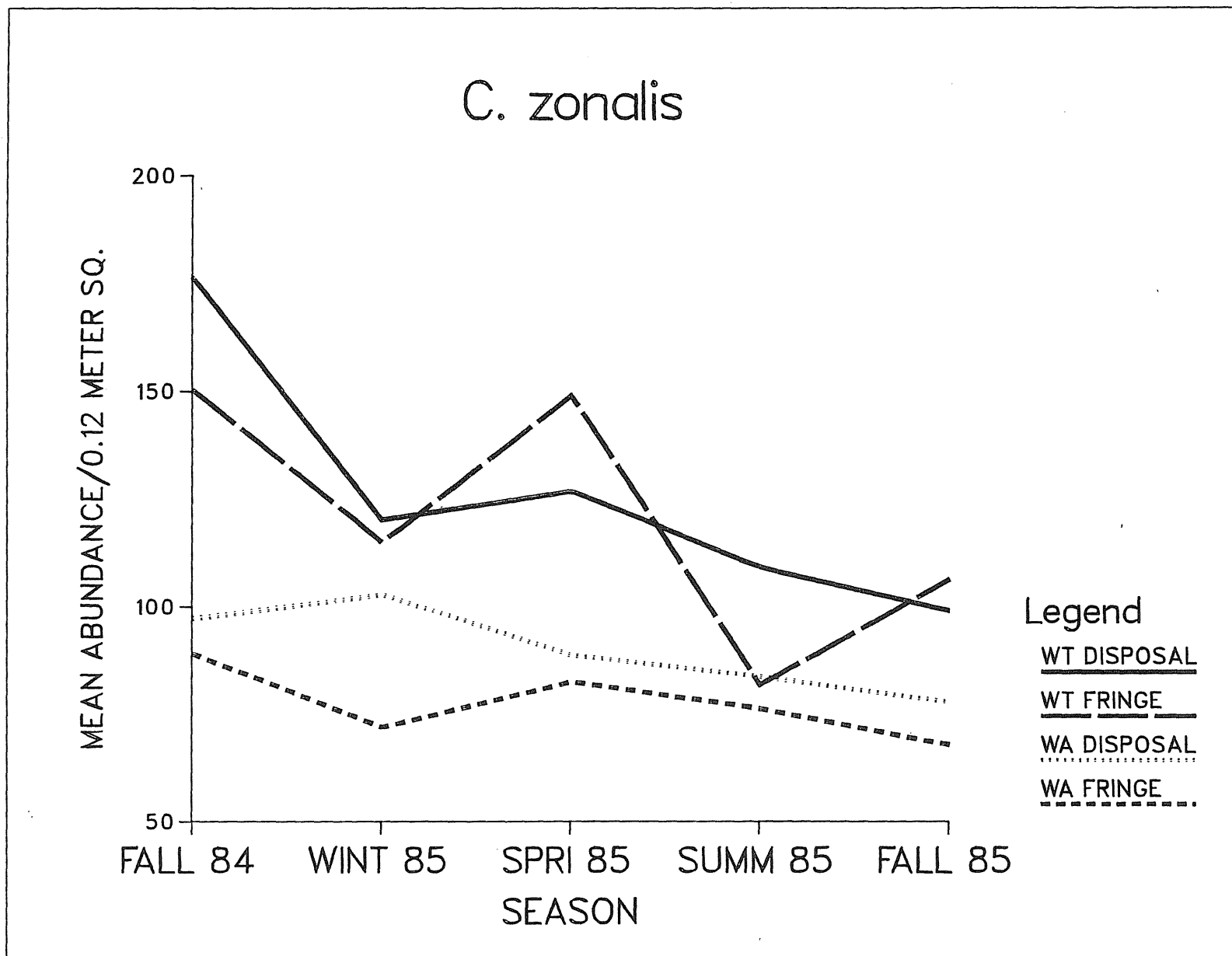

Figure IV-5. Seasonal abundance of *Clymenella zonalis* averaged by site, and disposal or fringe areas for Wolf Trap Study Region.

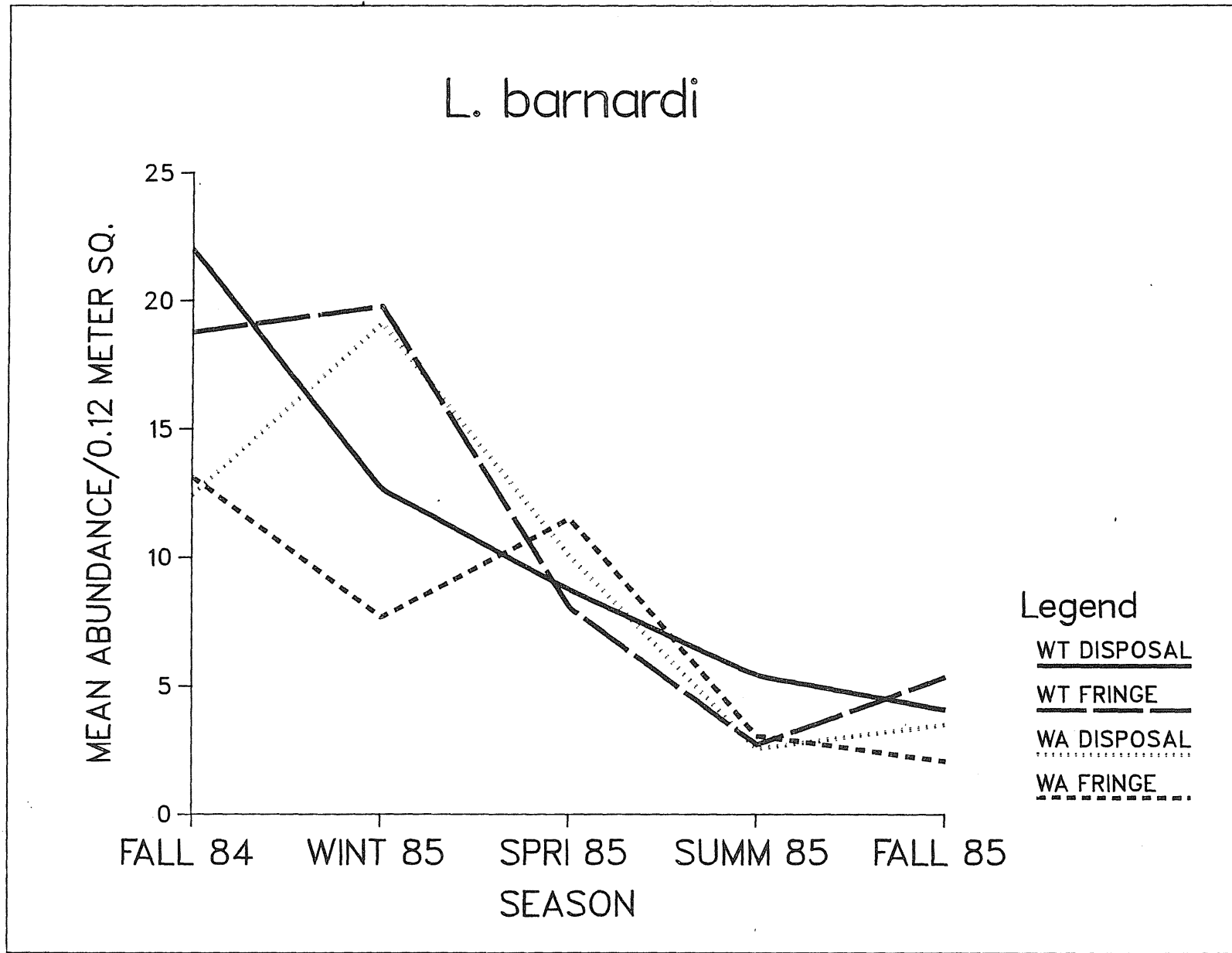

Figure IV-6. Seasonal abundance of *Listriella barnardi* averaged by site, and disposal or fringe areas for Wolf Trap Study Region.

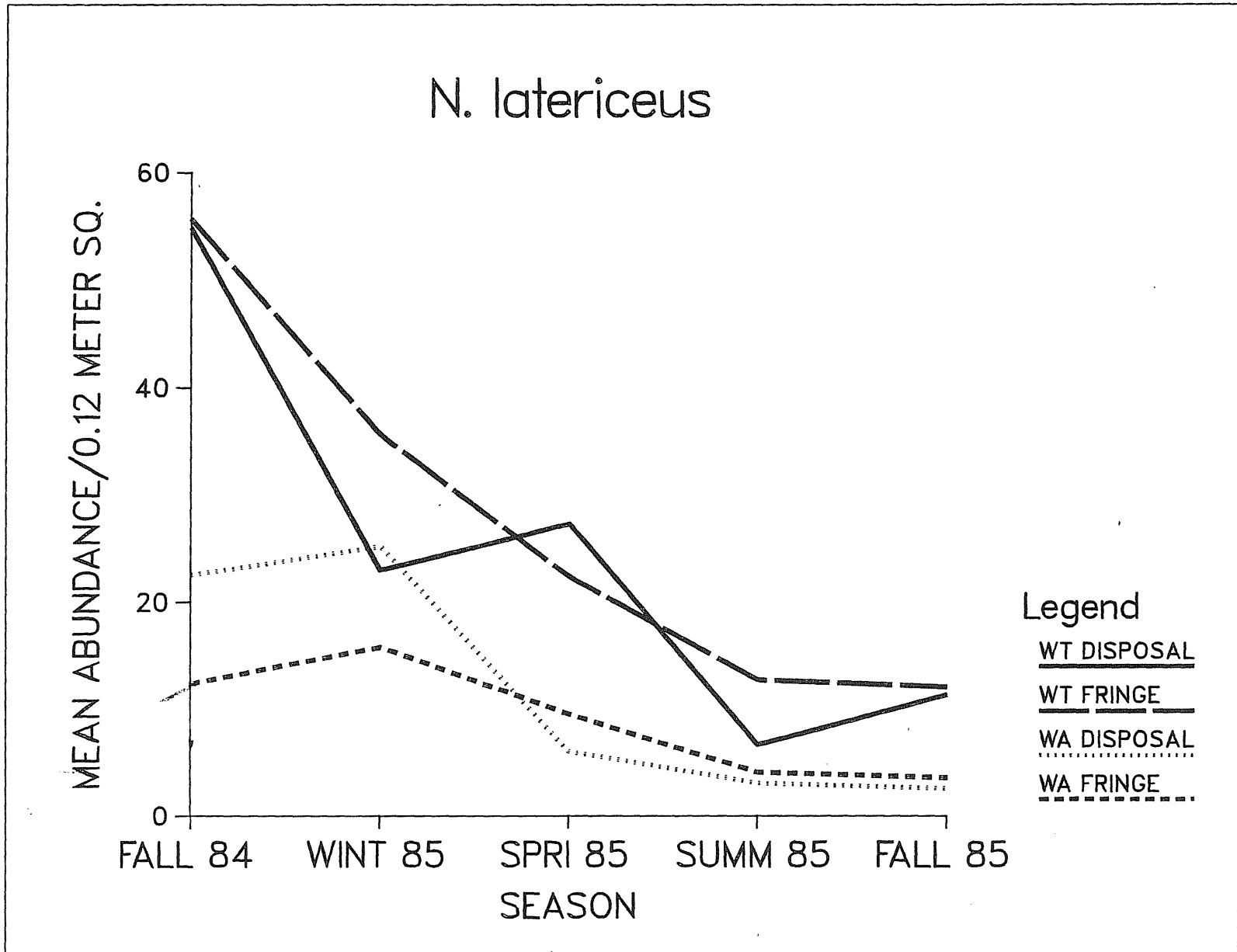

Figure IV-7. Seasonal abundance of *Notomastus latericeus* averaged by site, and disposal or fringe areas for Wolf Trap Study Region.

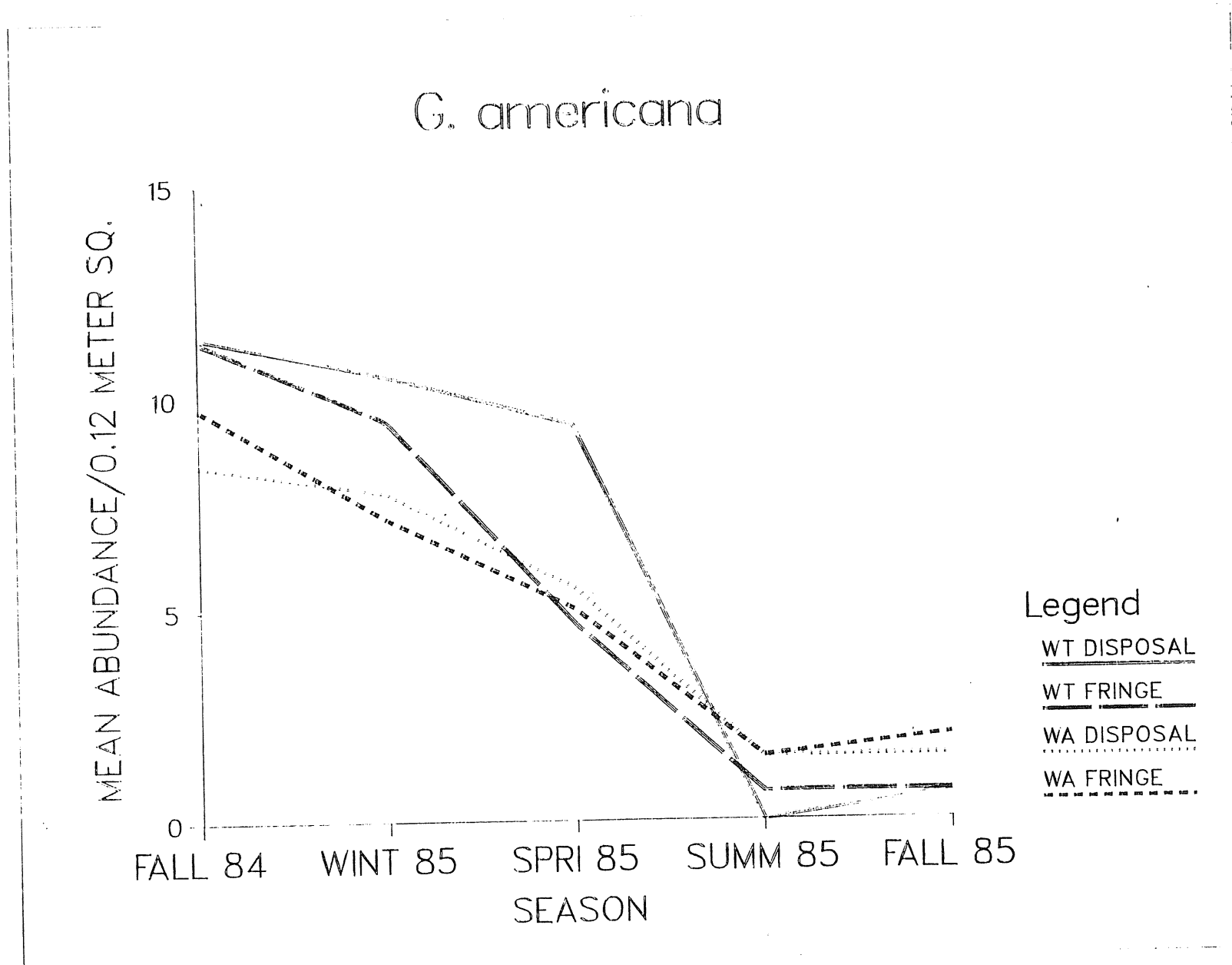

Figure IV-8. Seasonal abundance of *Glycera americana* averaged by site, and disposal or fringe areas for Wolf Trap Study Region.

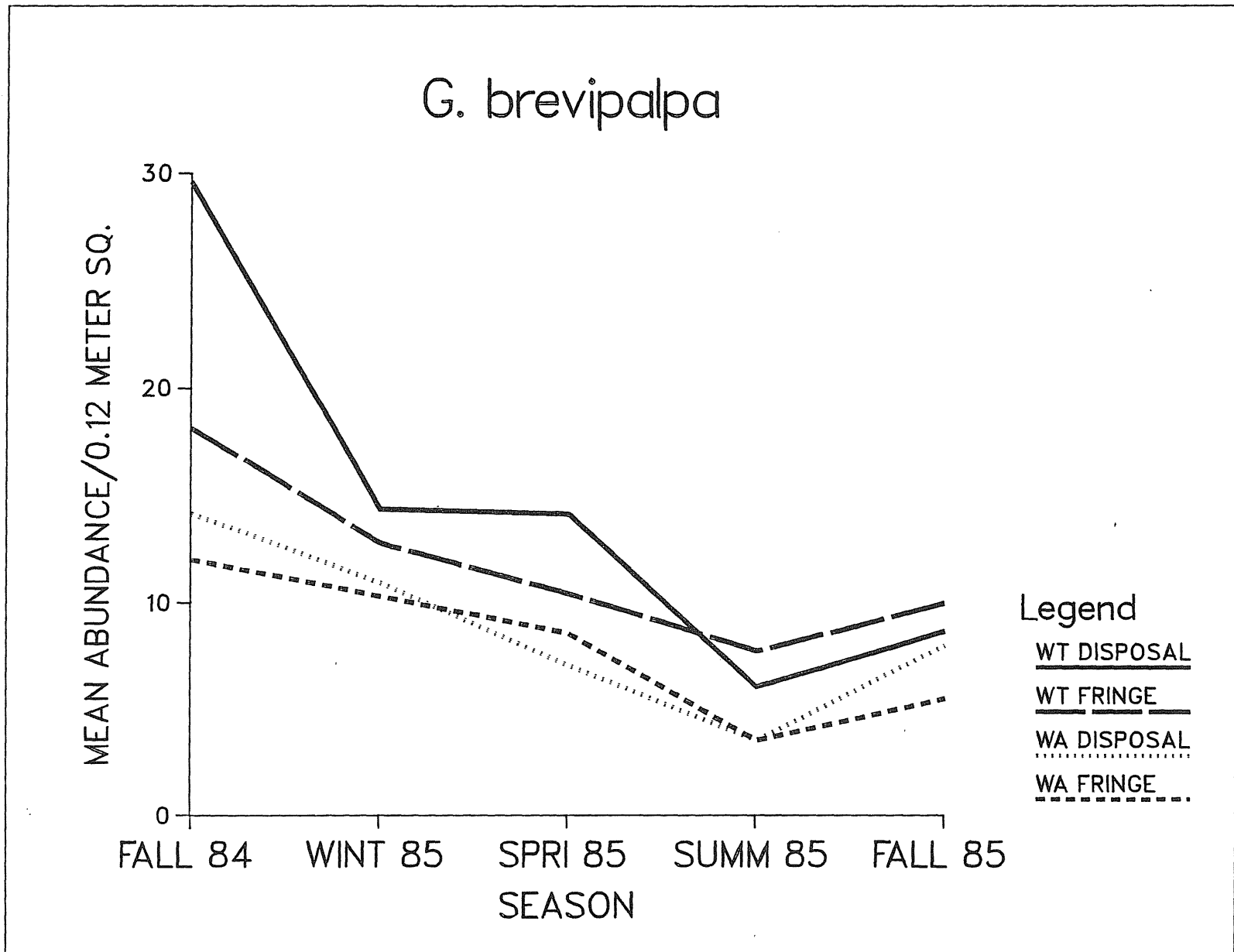

Figure IV-9. Seasonal abundance of *Gyptis brevipalpa* averaged by site, and disposal or fringe areas for Wolf Trap Study Region.

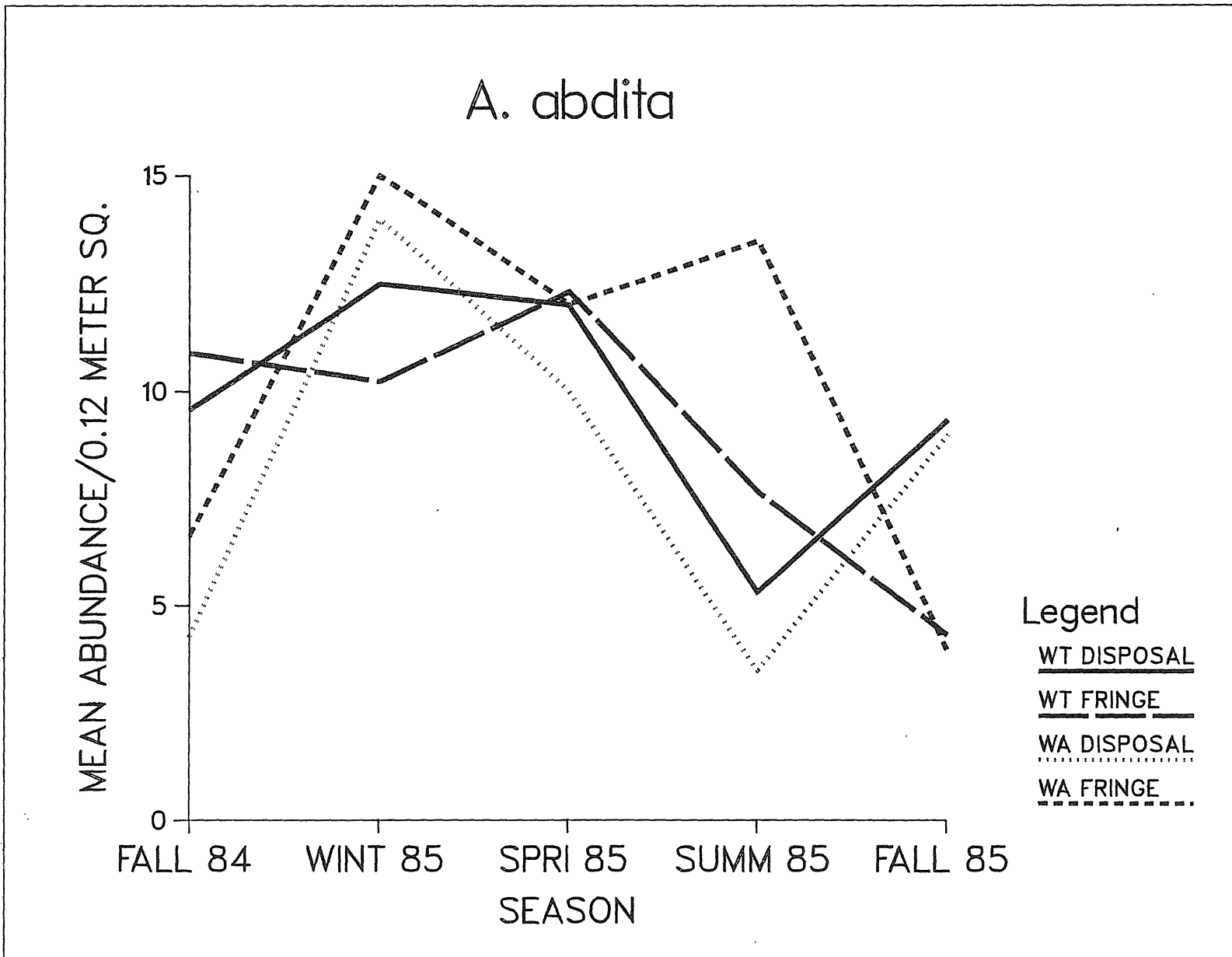

Figure IV-10. Seasonal abundance of *Ampelisca abdita* averaged by site, and disposal or fringe areas for Wolf Trap Study Region.

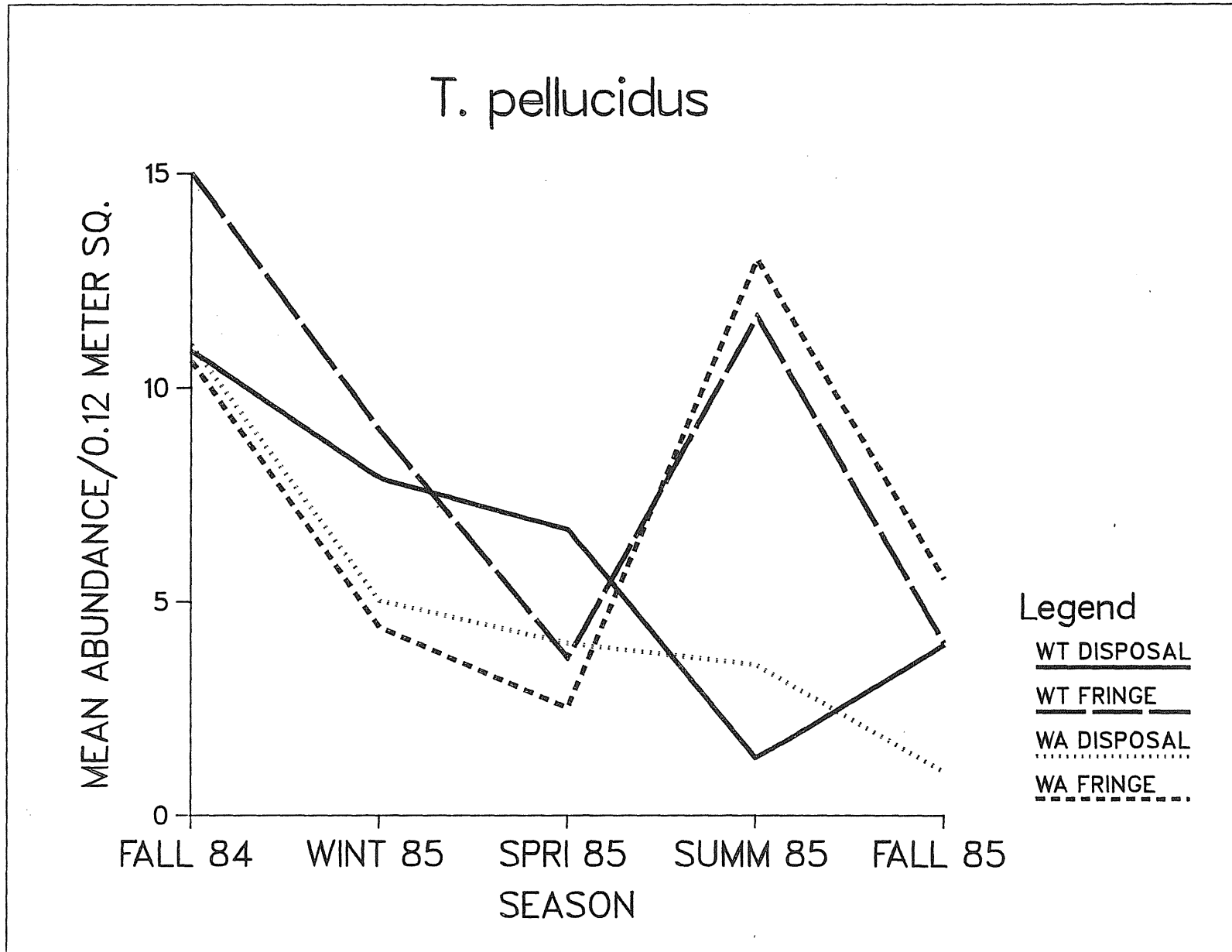

Figure IV-11. Seasonal abundance of *Tubulanus pellucidus* averaged by site, and disposal or fringe areas for Wolf Trap Study Region.

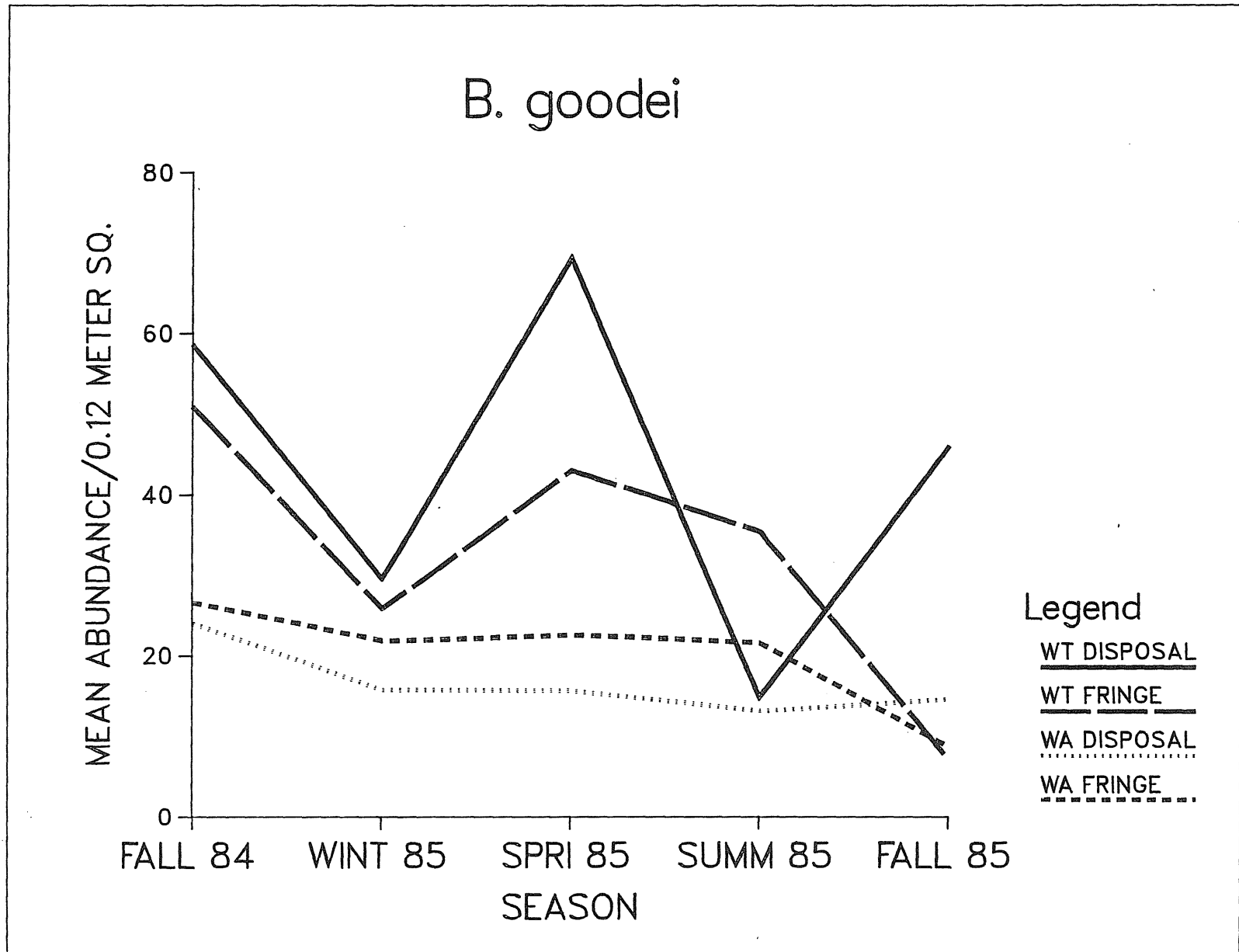

Figure IV-12. Seasonal abundance of *Bhwanina goodei* averaged by site, and disposal or fringe areas for Wolf Trap Study Region.

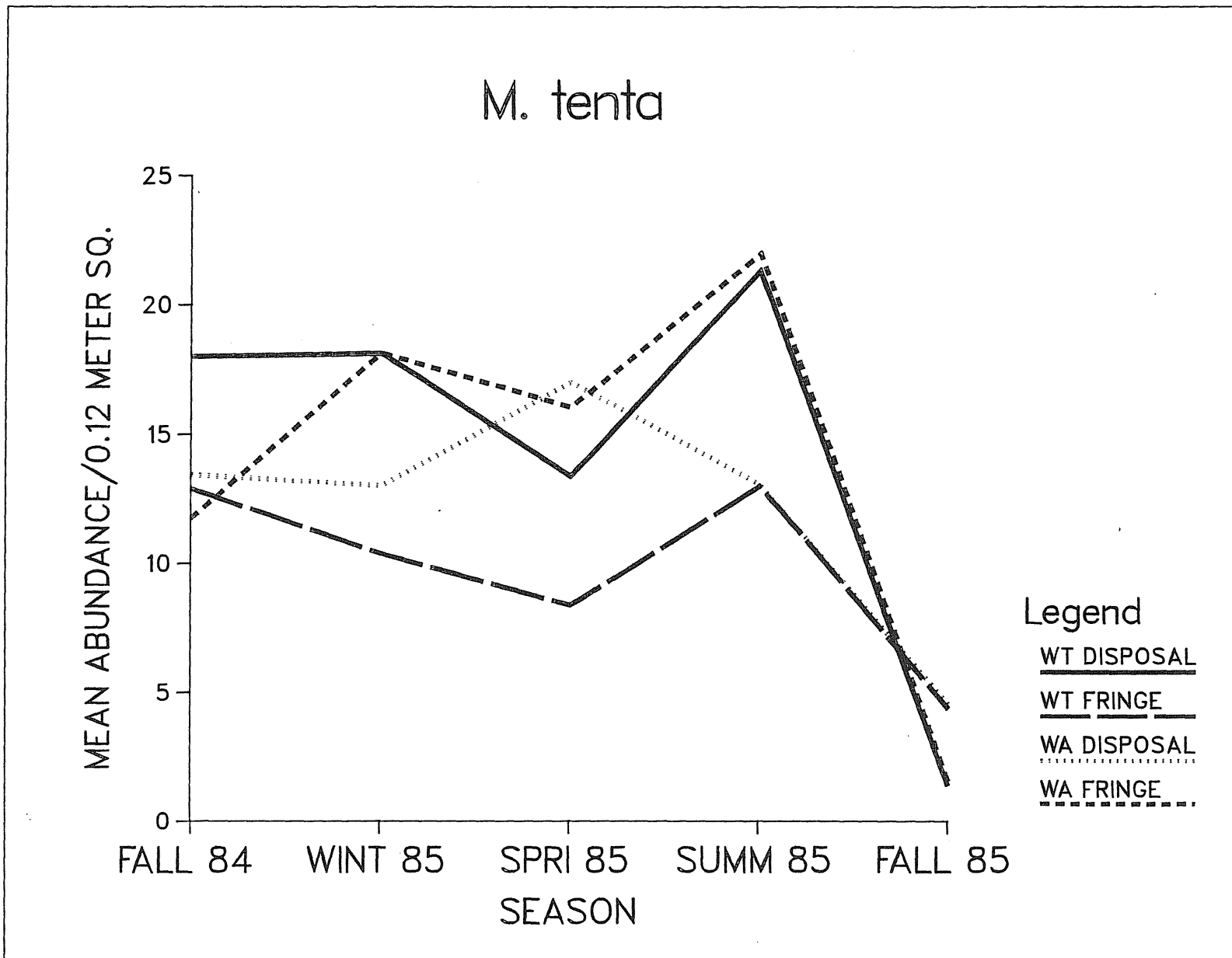

Figure IV-13. Seasonal abundance of Macoma tenta averaged by site, and disposal or fringe areas for Wolf Trap Study Region.

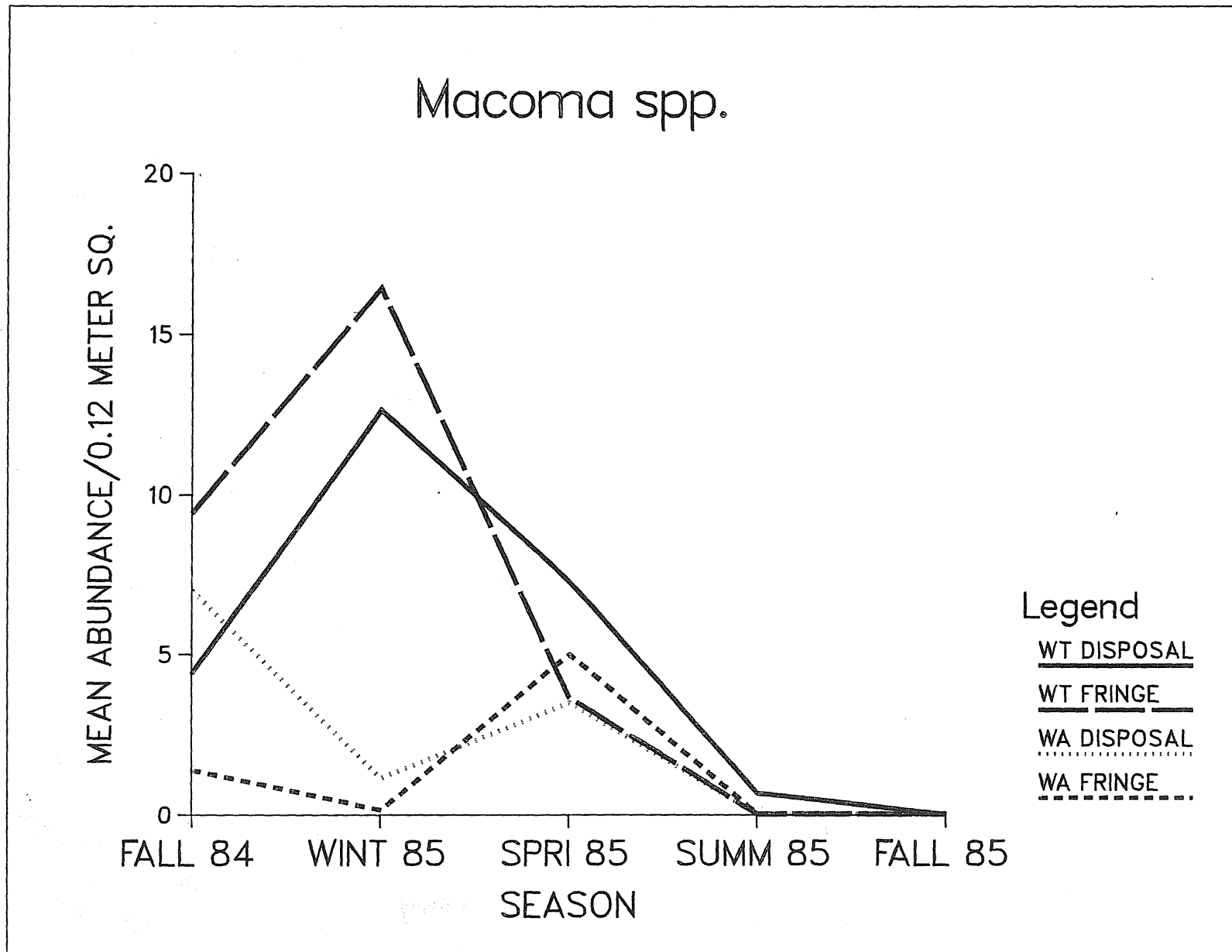

Figure IV-14. Seasonal abundance of Macoma spp. averaged by site, and disposal or fringe areas for Wolf Trap Study Region.

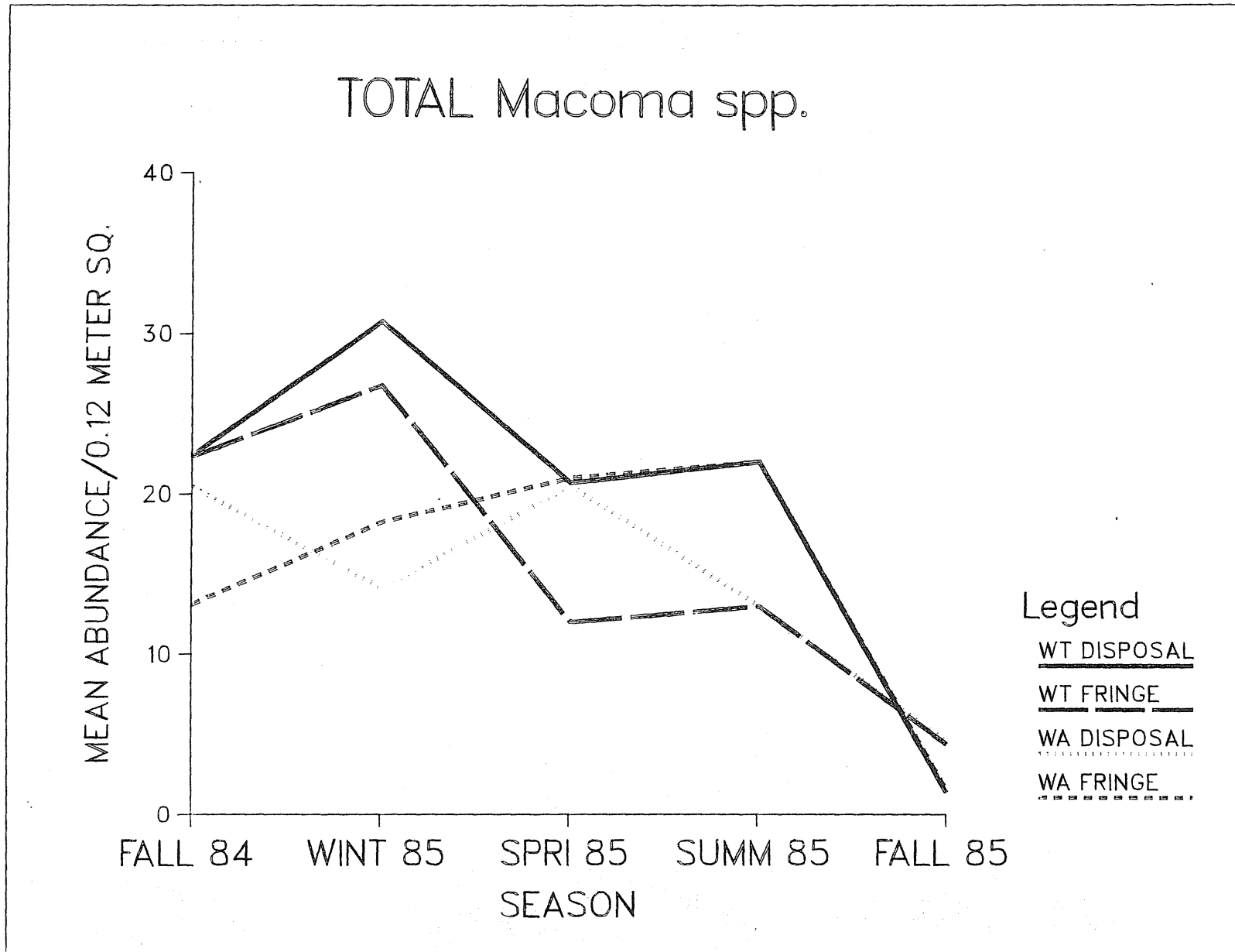

Figure IV-15. Seasonal abundance of Total *Macoma* spp. averaged by site, and disposal or fringe areas for Wolf Trap Study Region.

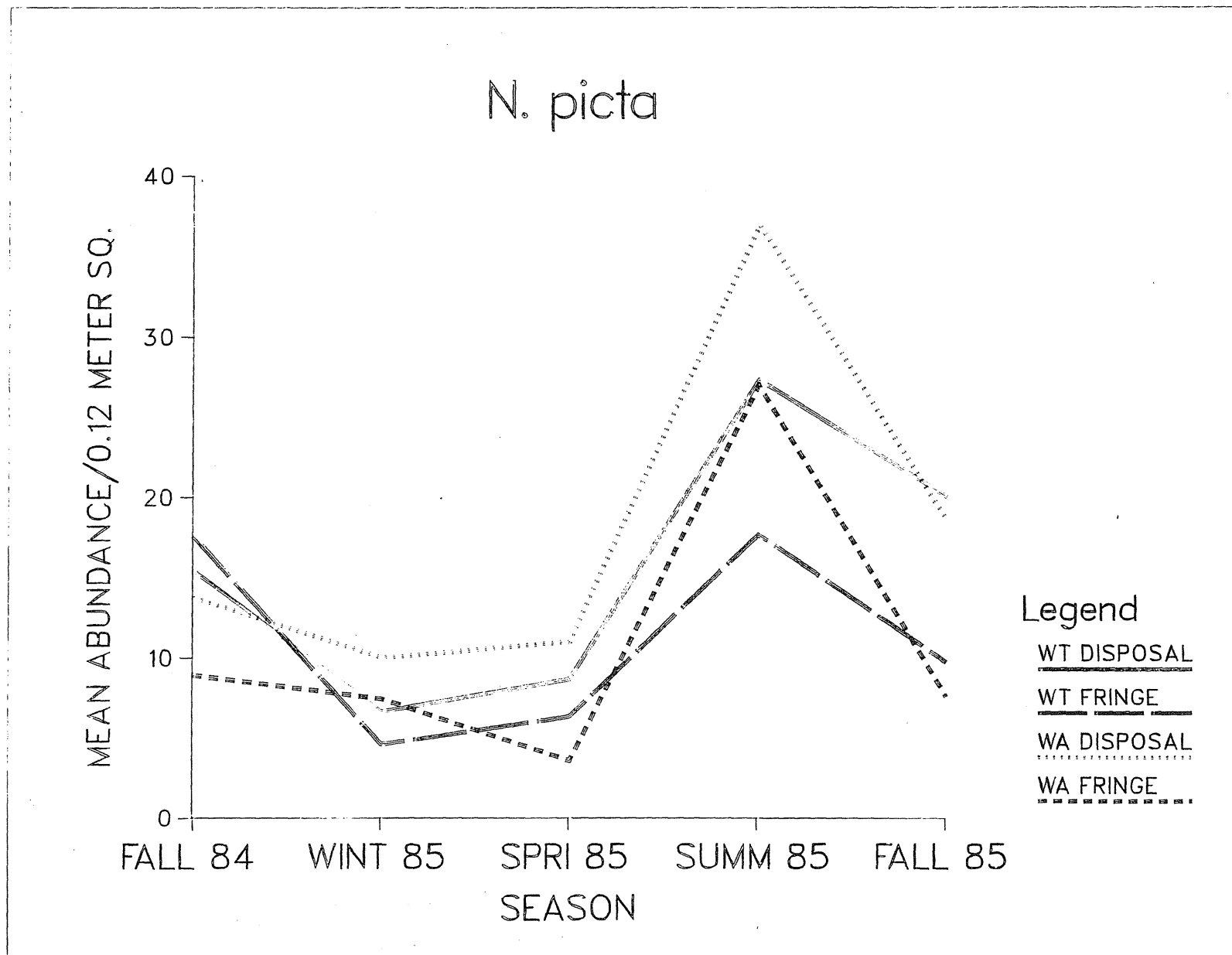

Figure IV-16. Seasonal abundance of *Nephthys picta* averaged by site, and disposal or fringe areas for Wolf Trap Study Region.

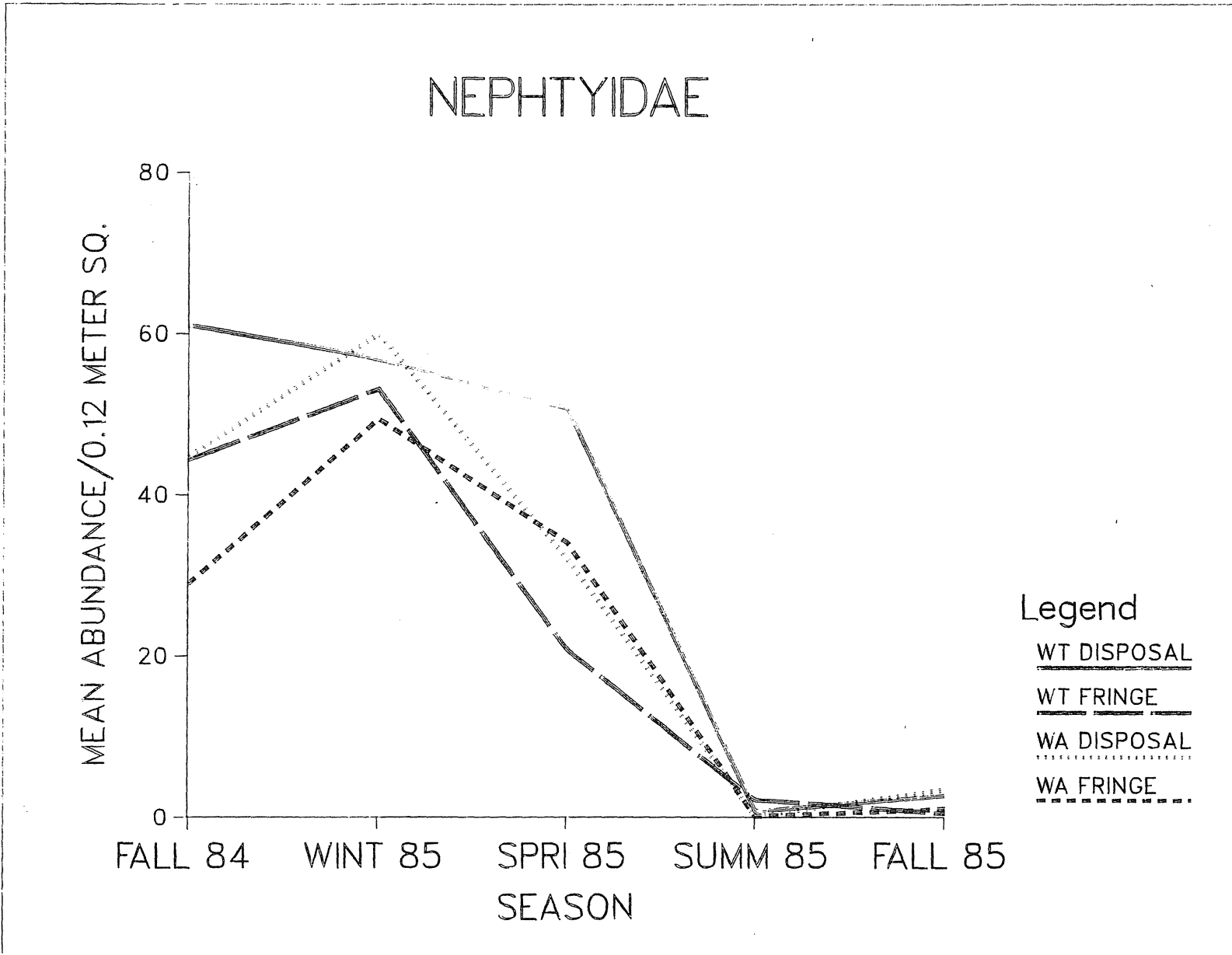

Figure IV-17. Seasonal abundance of Nephtyidae averaged by site, and disposal or fringe areas for Wolf Trap Study Region.

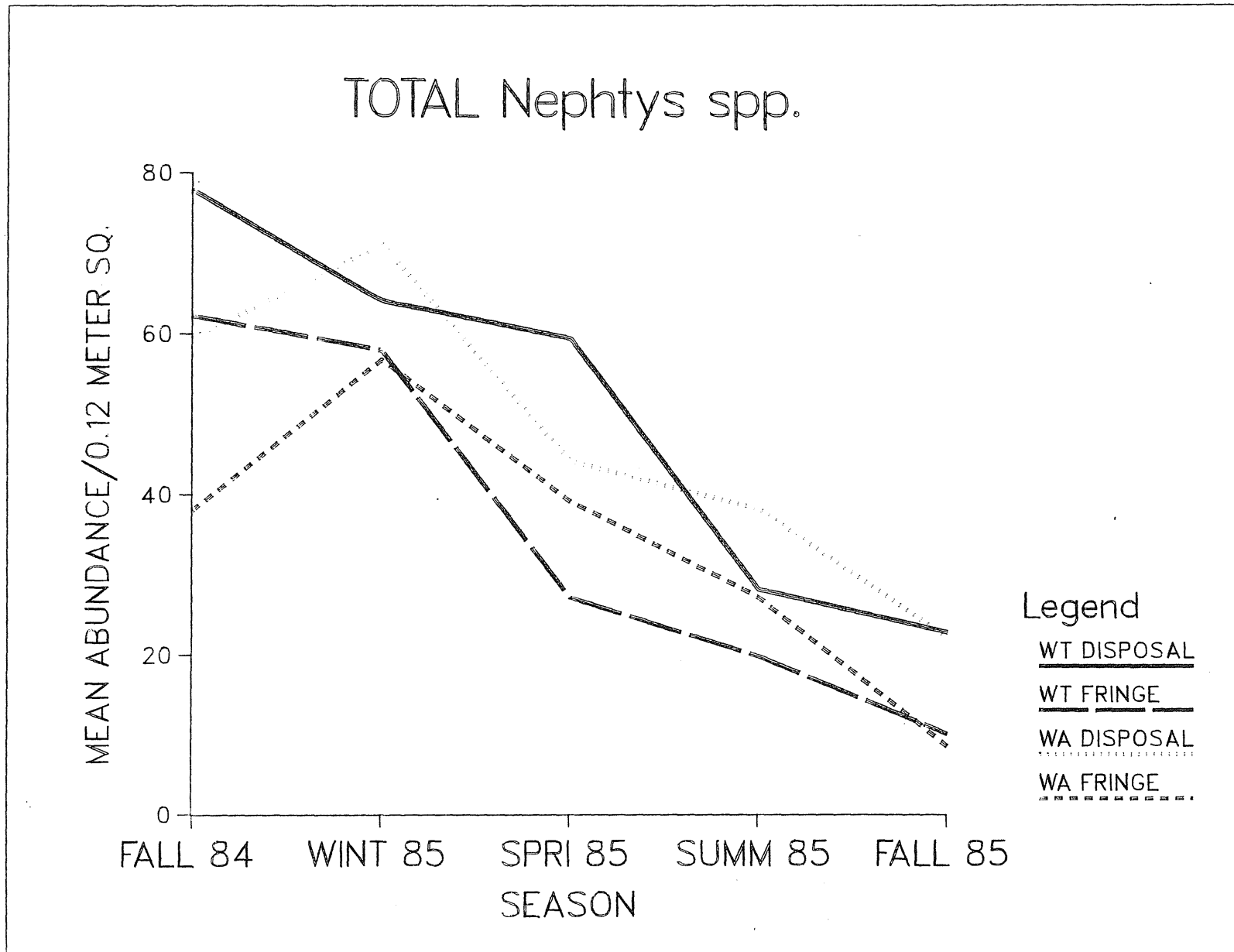

Figure IV-18. Seasonal abundance of Total *Nephtys* spp. averaged by site, and disposal or fringe areas for Wolf Trap Study Region.

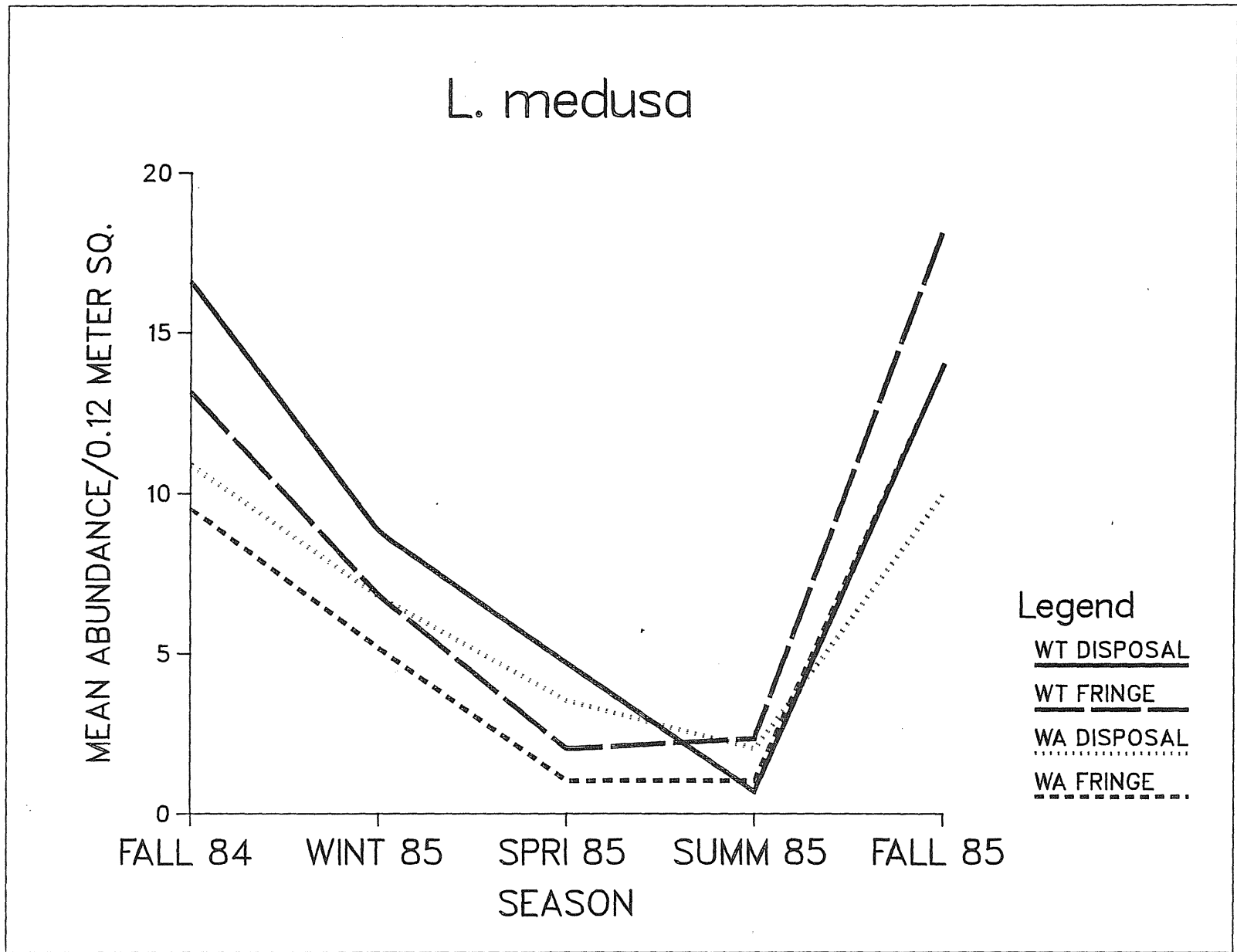

Figure IV-19. Seasonal abundance of *Loimia medusa* averaged by site, and disposal or fringe areas for Wolf Trap Study Region.

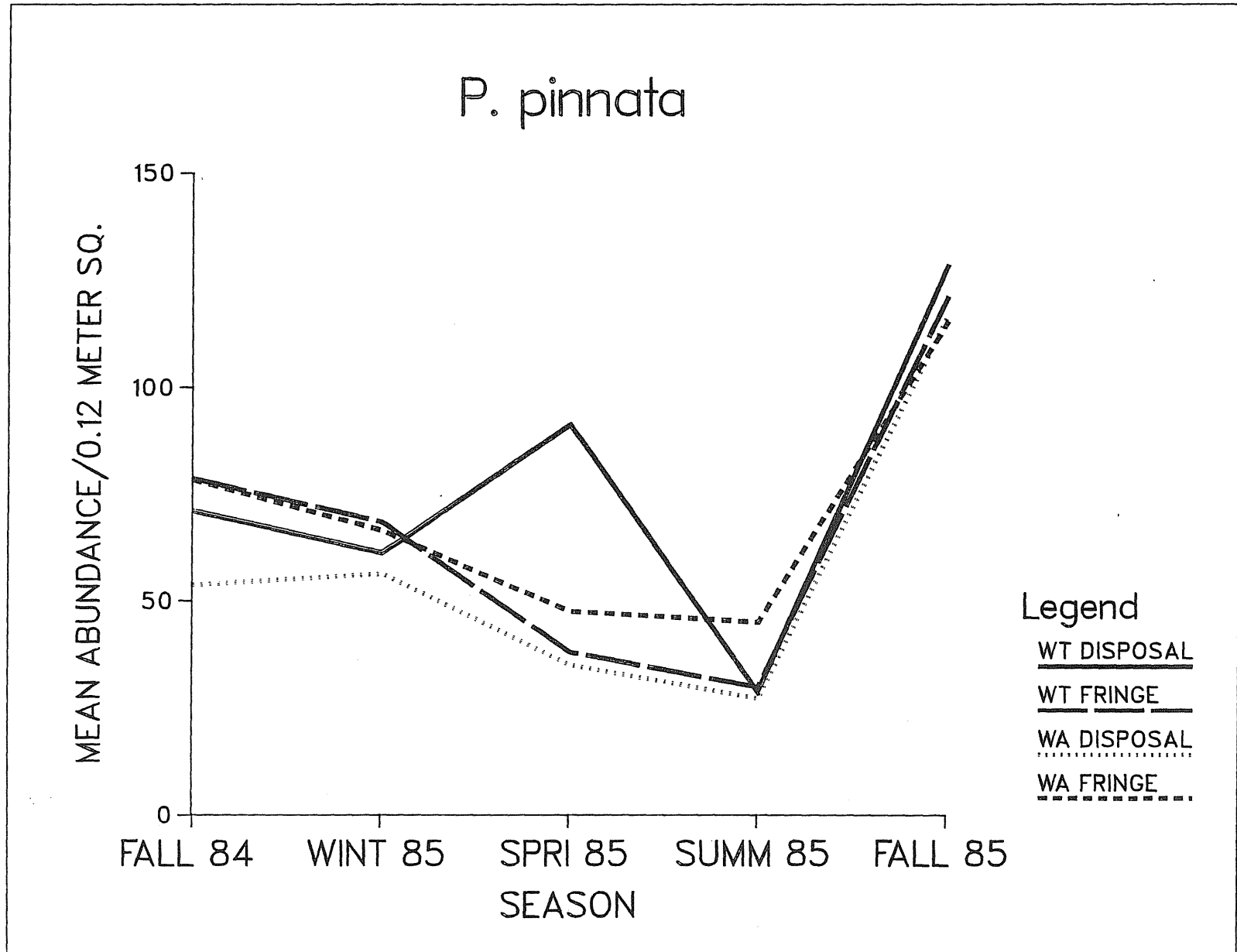

Figure IV-20. Seasonal abundance of *Paraprionospio pinnata* averaged by site, and disposal or fringe areas for Wolf Trap Study Region.

G. solitaria

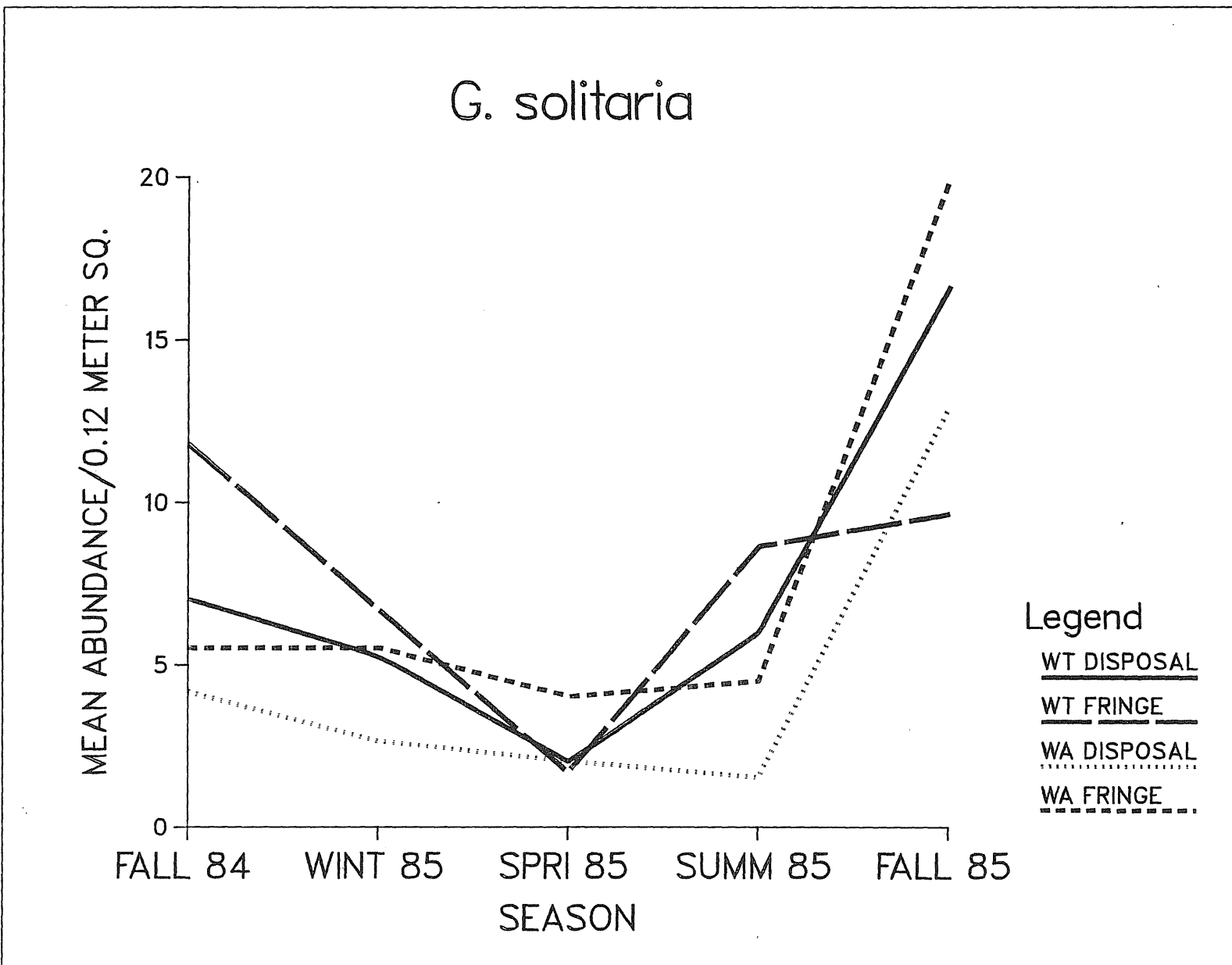

Figure IV-21. Seasonal abundance of *Glycinde solitaria* averaged by site, and disposal or fringe areas for Wolf Trap Study Region.

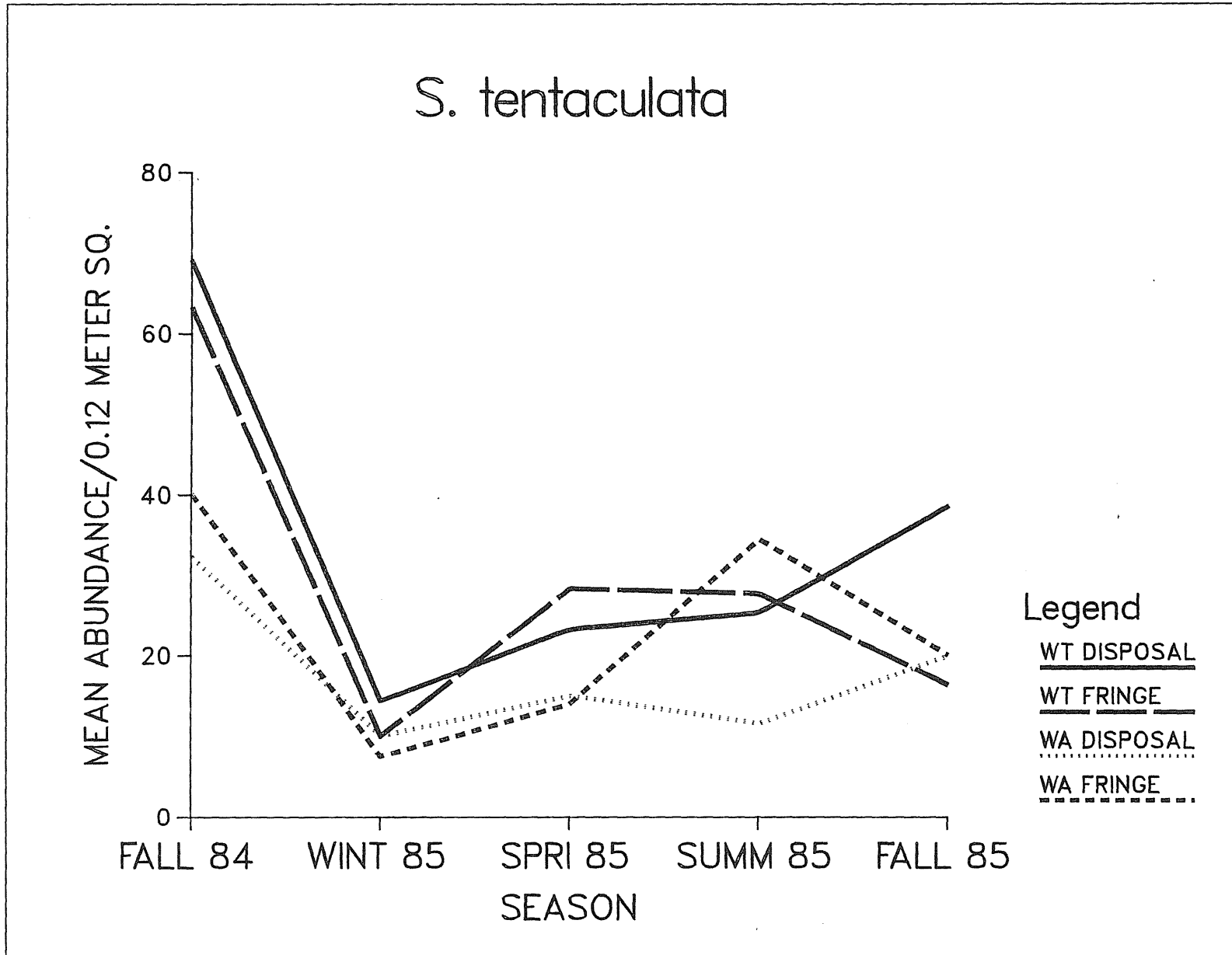

Figure IV-22. Seasonal abundance of *Sigambra tentaculata* averaged by site, and disposal or fringe areas for Wolf Trap Study Region.

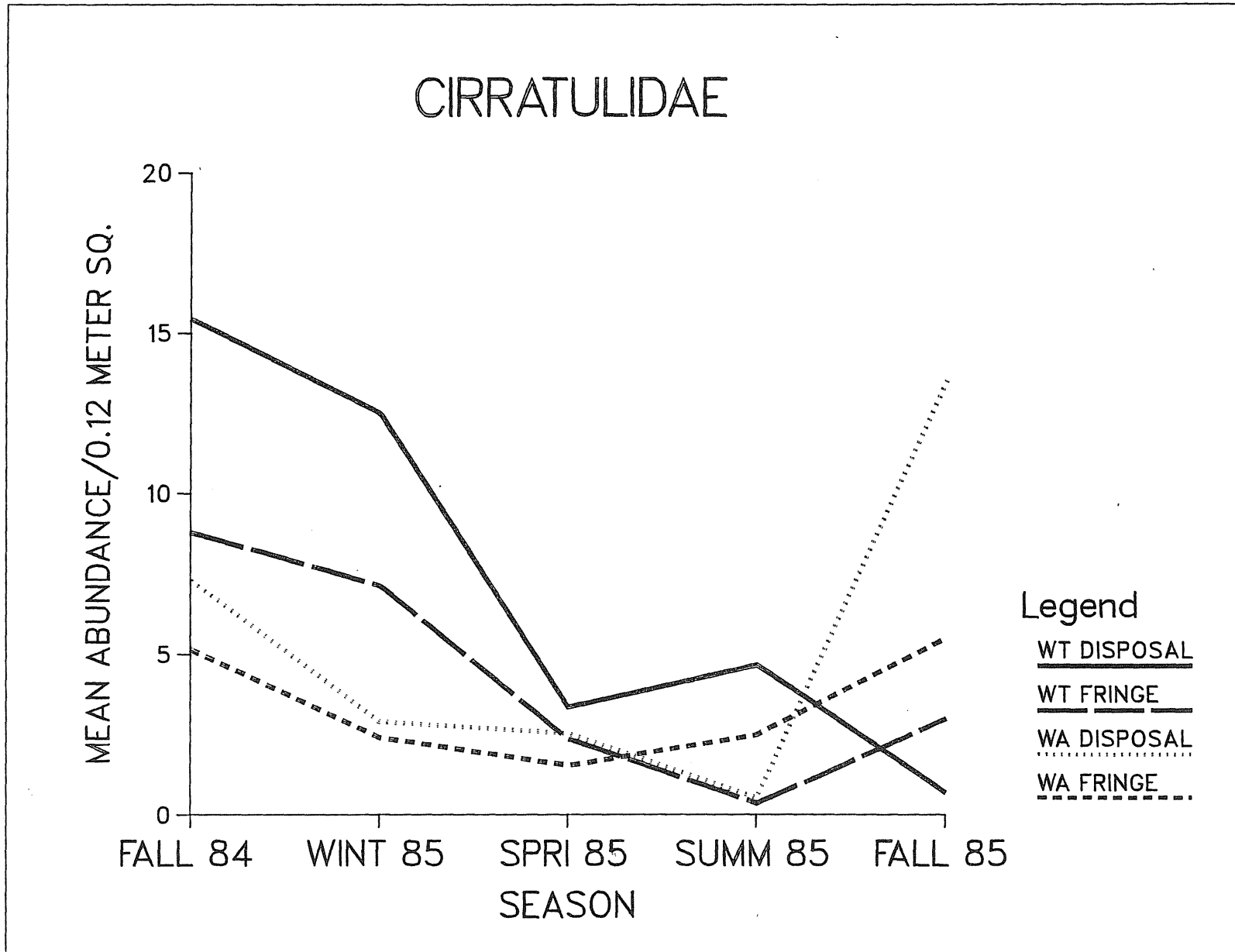

Figure IV-23. Seasonal abundance of Cirratulids averaged by site, and disposal or fringe areas for Wolf Trap Study Region.

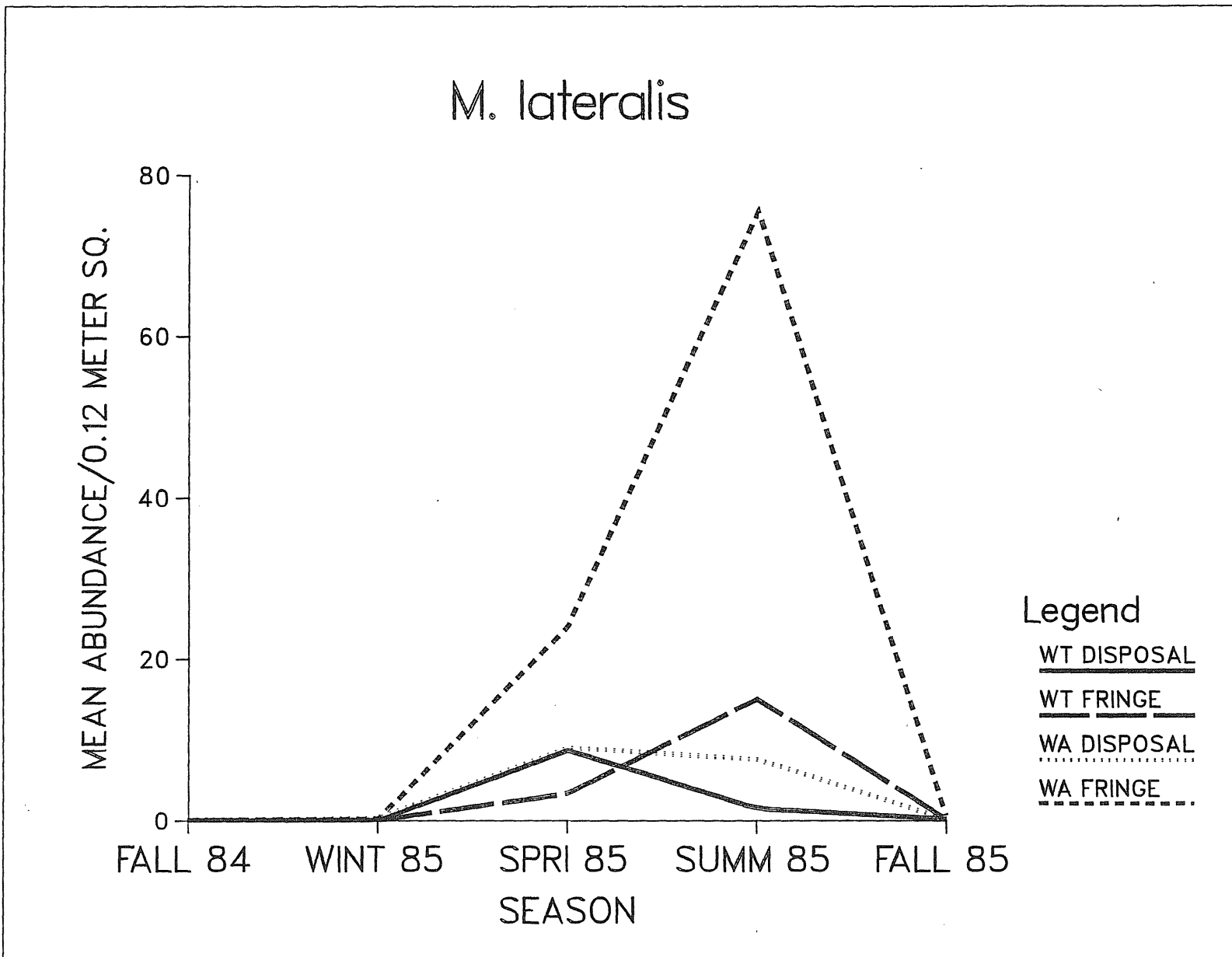

Figure IV-24. Seasonal abundance of *Mulinia lateralis* averaged by site, and disposal or fringe areas for Wolf Trap Study Region.

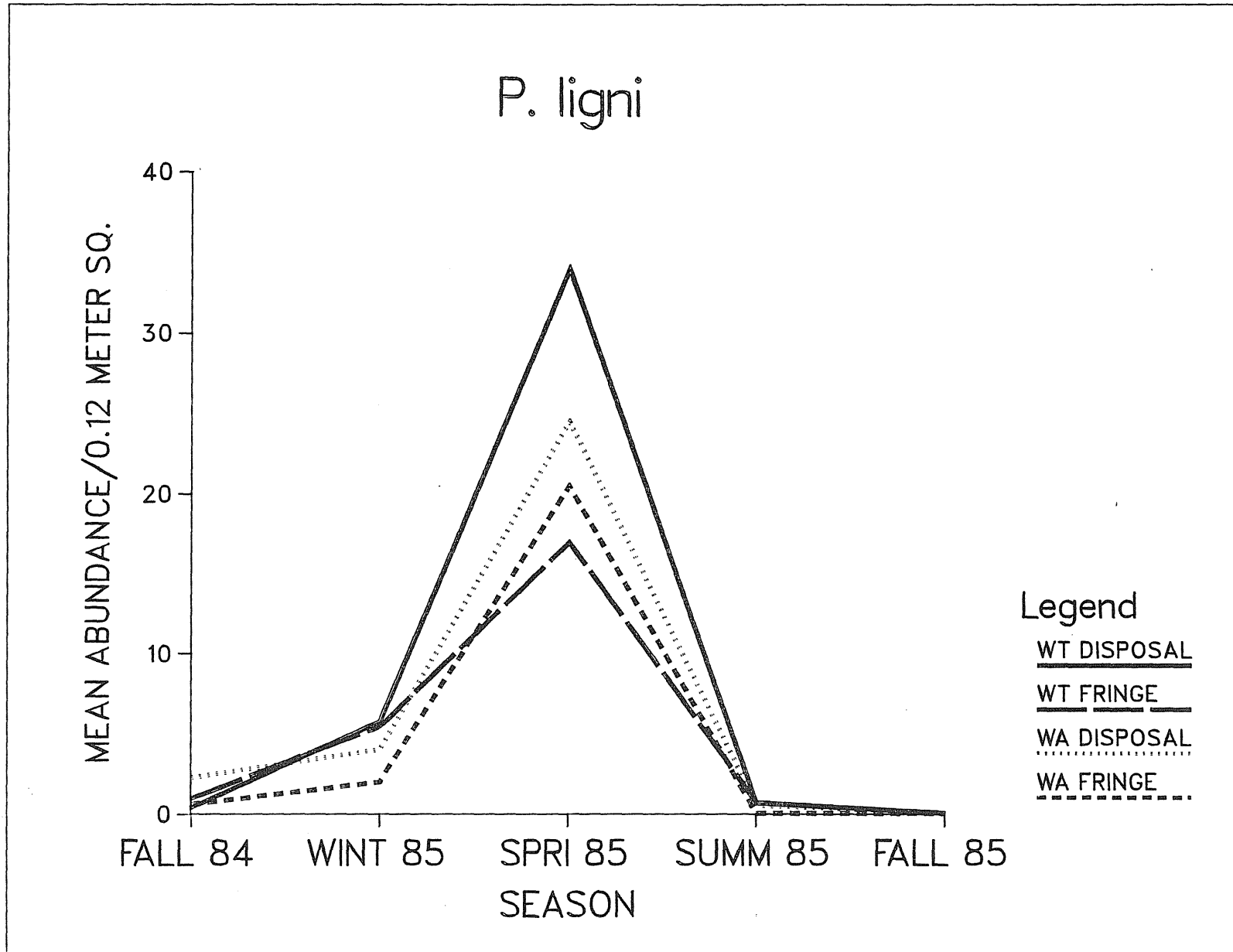

Figure IV-25. Seasonal abundance of *Polydora ligni* averaged by site, and disposal or fringe areas for Wolf Trap Study Region.

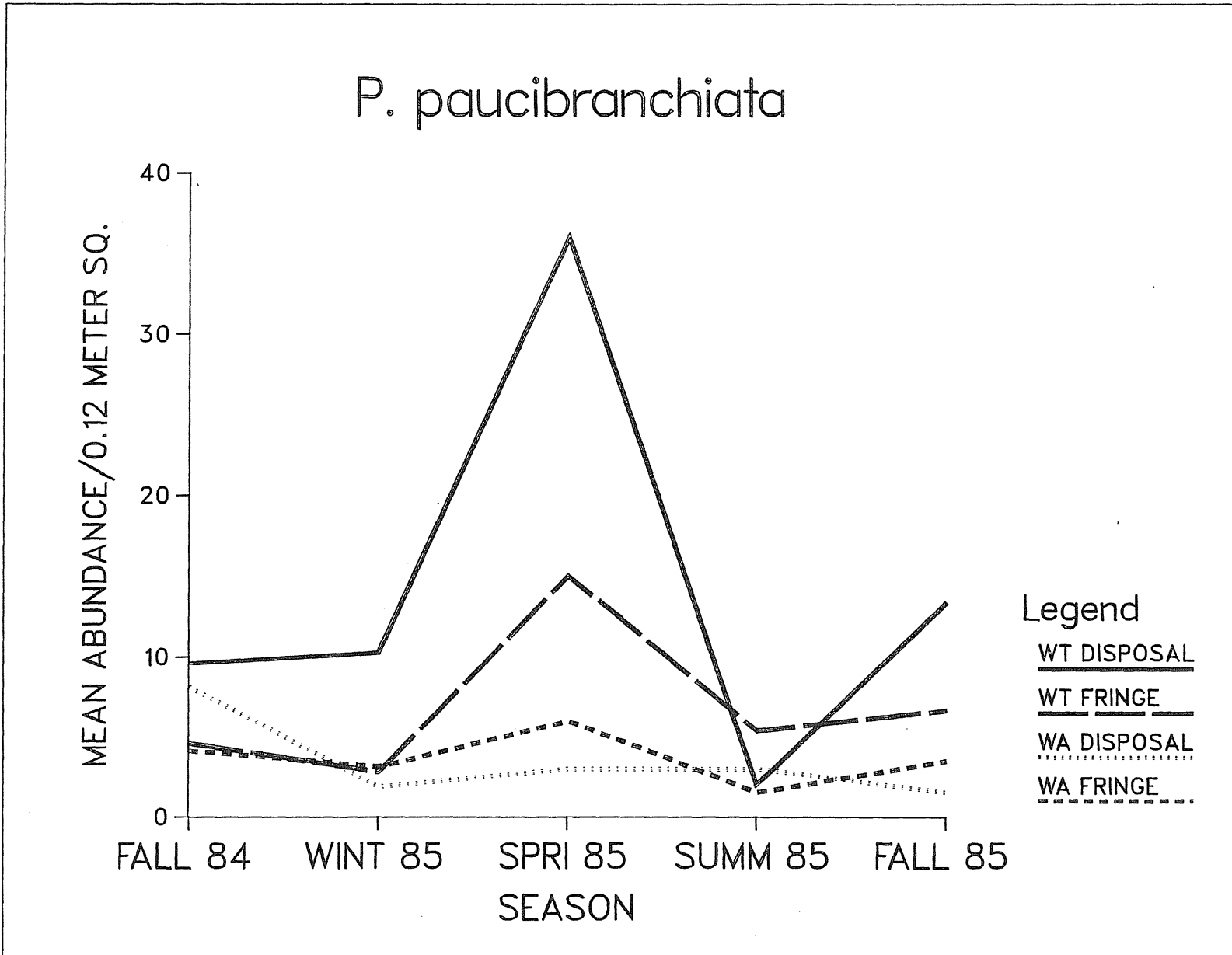

Figure IV-26. Seasonal abundance of *Pseudeurythoe paucibranchiata* averaged by site, and disposal or fringe areas for Wolf Trap Study Region.

POLYCLADIA

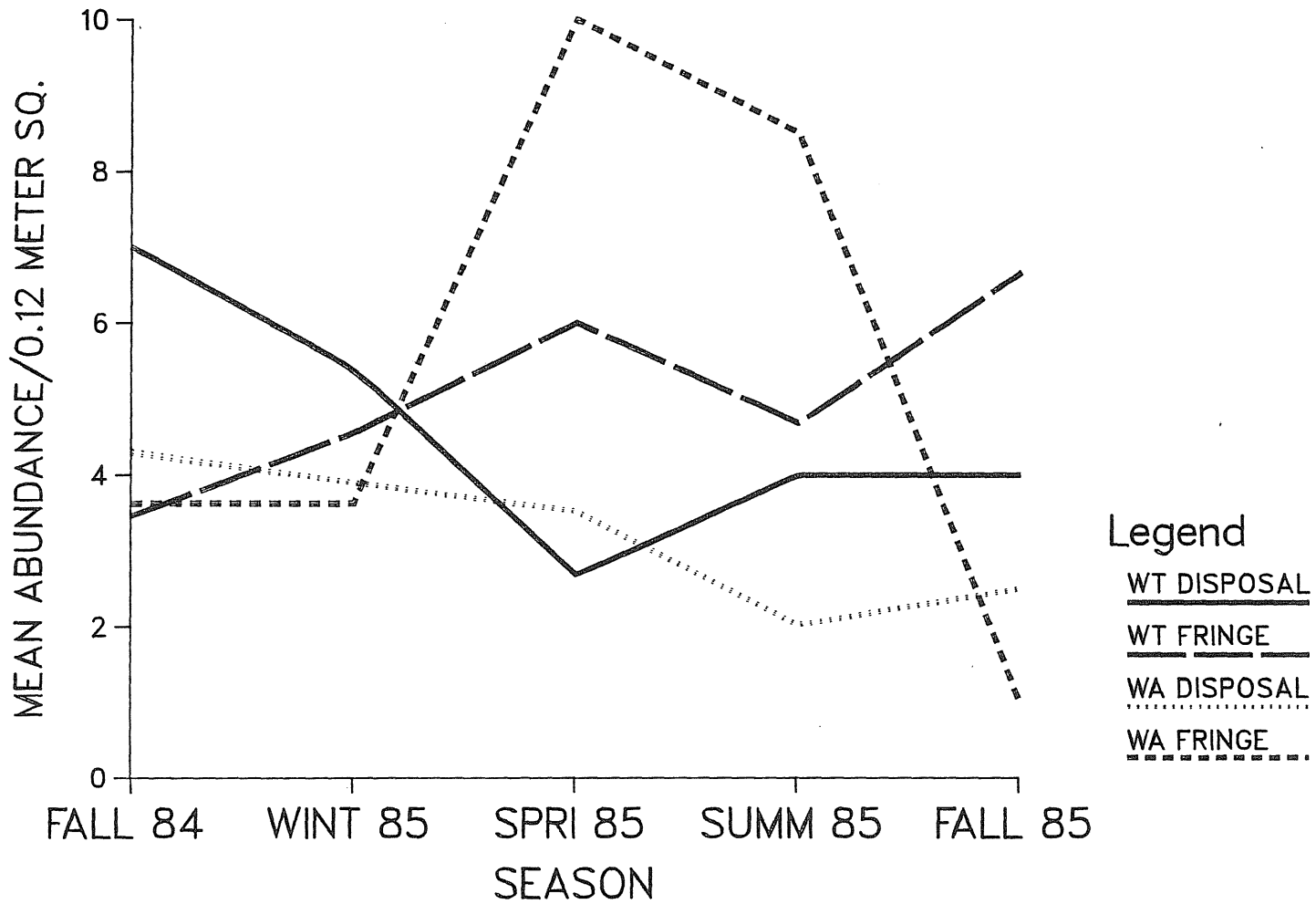

Figure IV-27. Seasonal abundance of Polycladia averaged by site, and disposal or fringe areas for Wolf Trap Study Region.

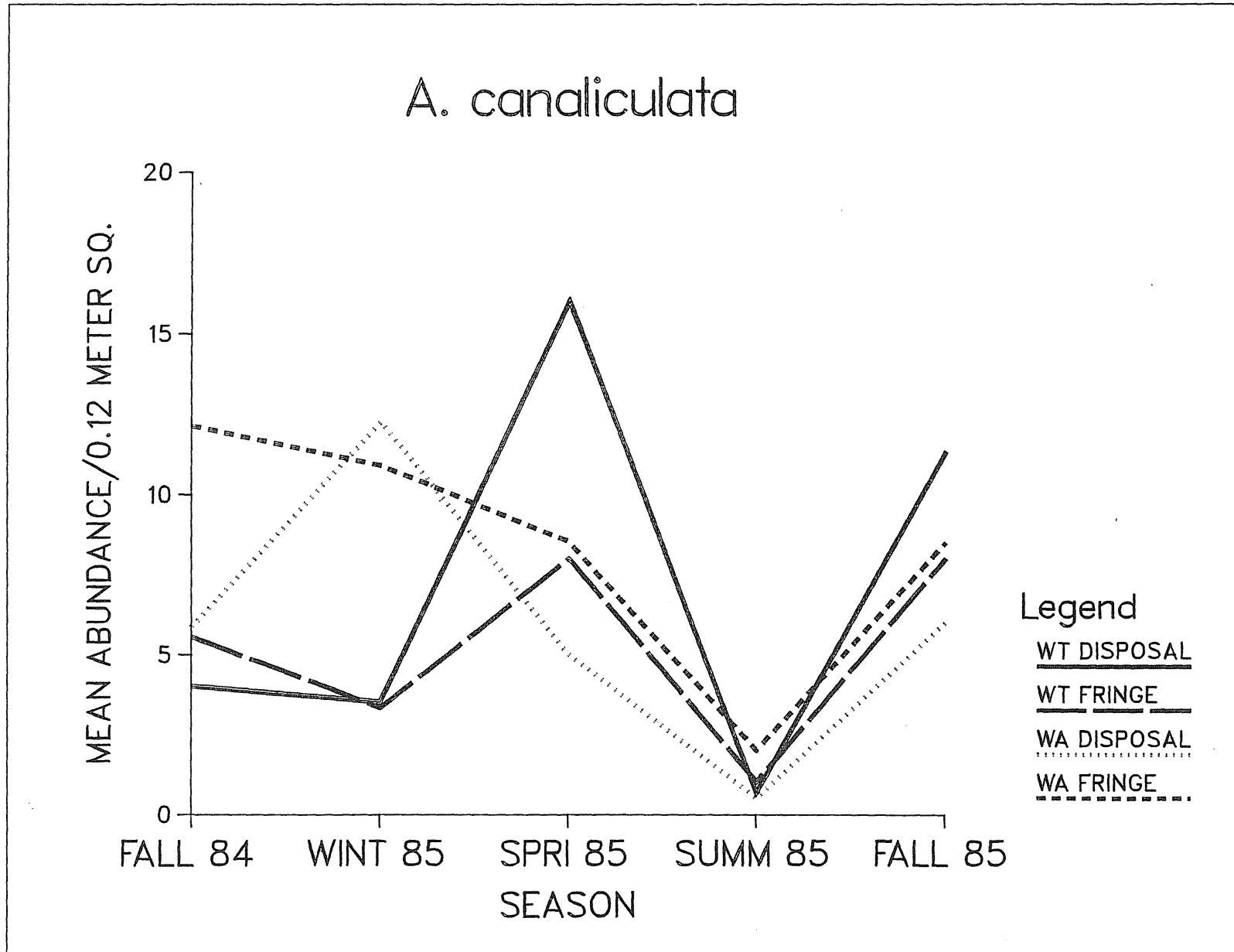

Figure IV-28. Seasonal abundance of *Acteocina canaliculata* averaged by site, and disposal or fringe areas for Wolf Trap Study Region.

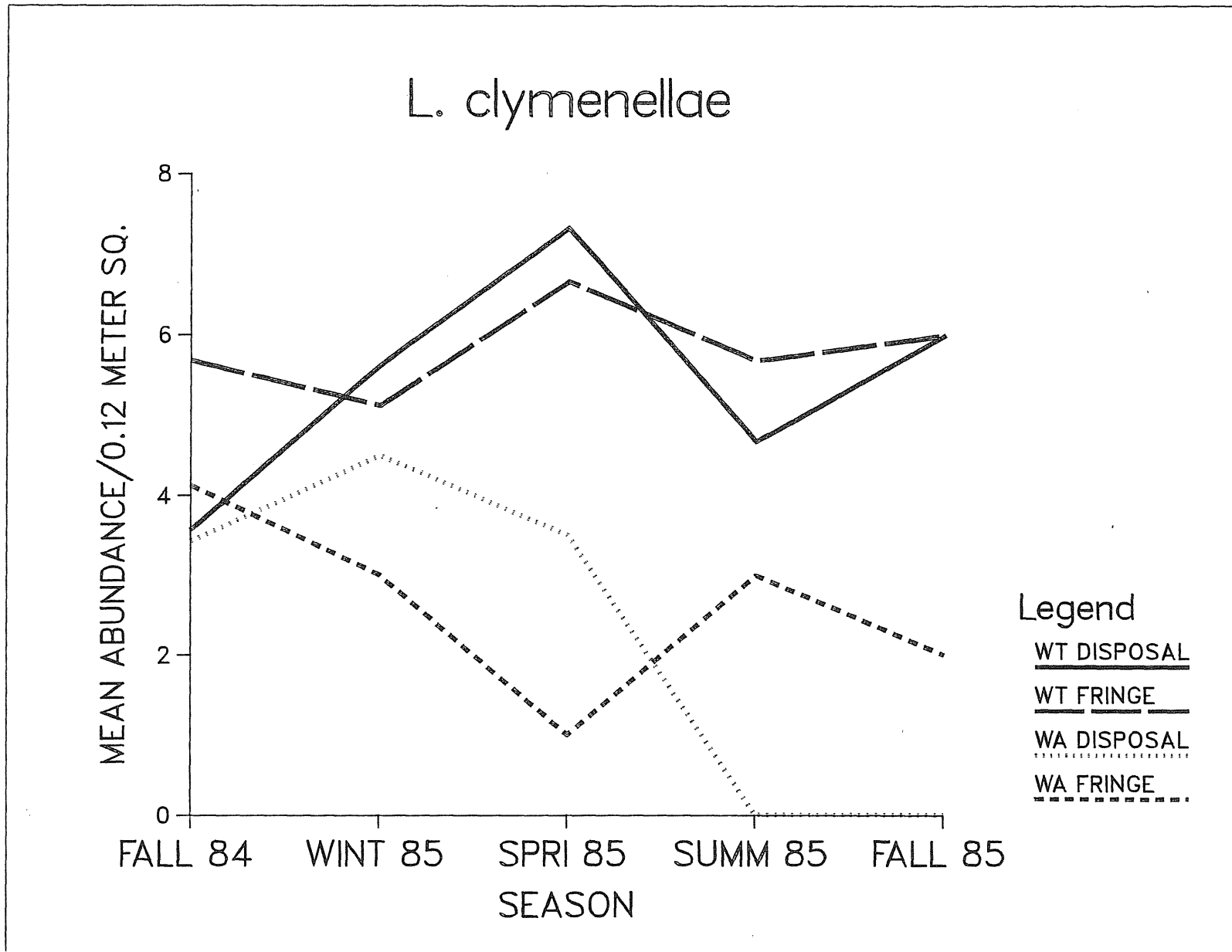

Figure IV-29. Seasonal abundance of *Listriella clymenellae* averaged by site, and disposal or fringe areas for Wolf Trap Study Region.

Figure IV-30. Frequency distributions of boundary roughness values at the Wolf Trap Site from all four surveys. Note scale differences on the X axis between sampling times.

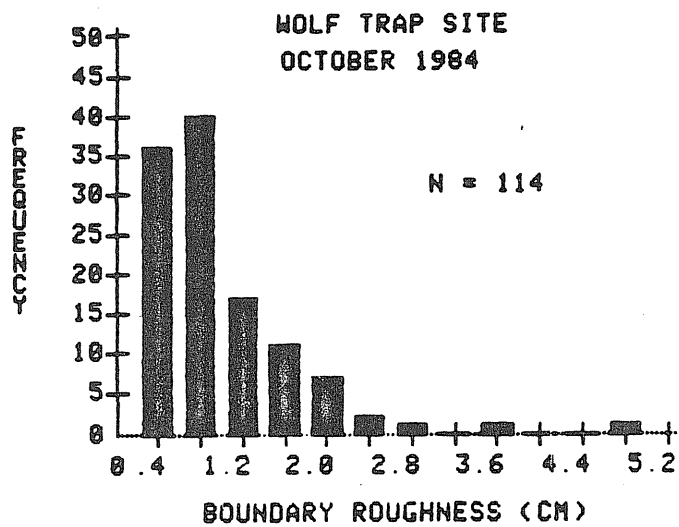
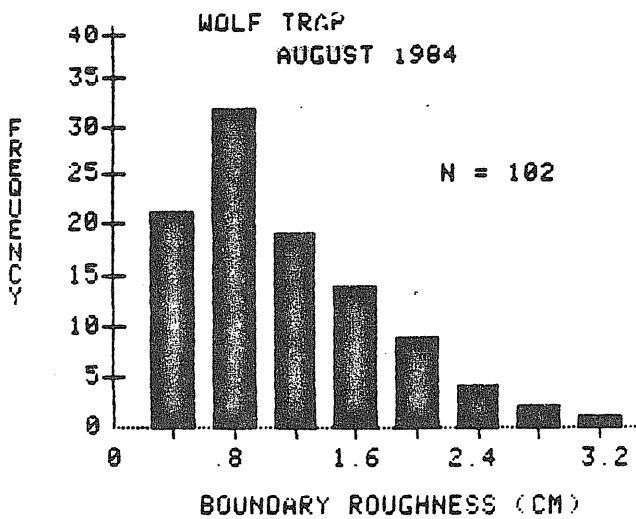
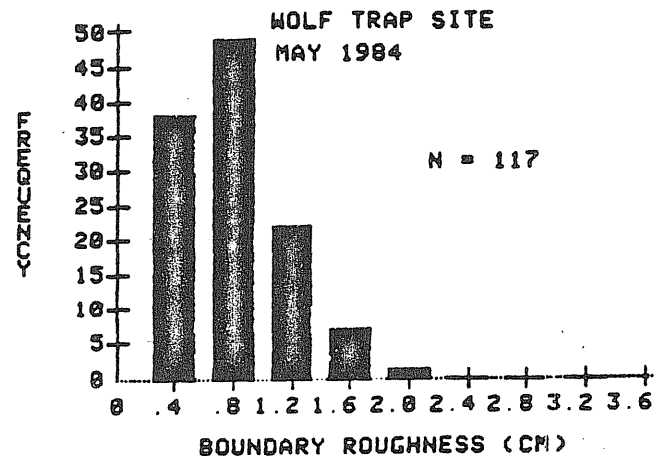
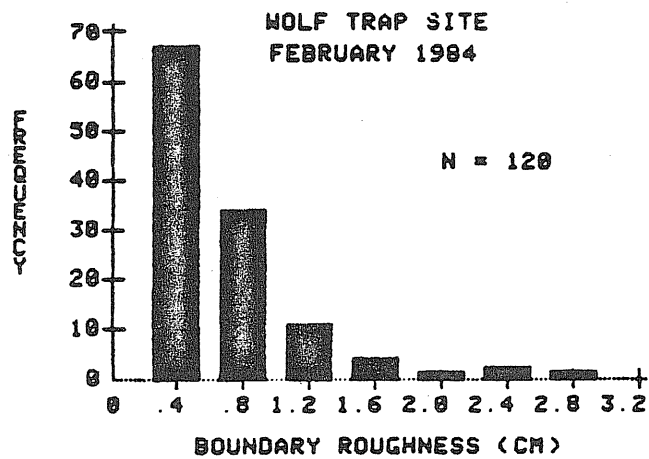

Figure IV-31. Frequency distributions of the mean RPD depths (cm) at the Wolf Trap Site for all surveys. Note the scale differences on the X and Y axes.

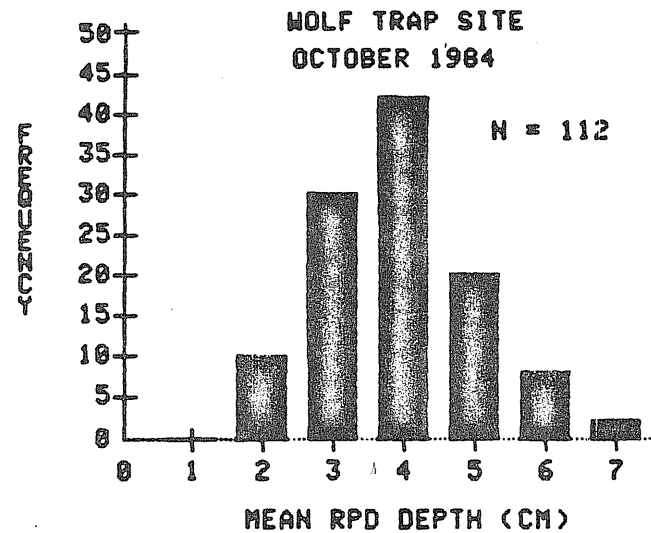
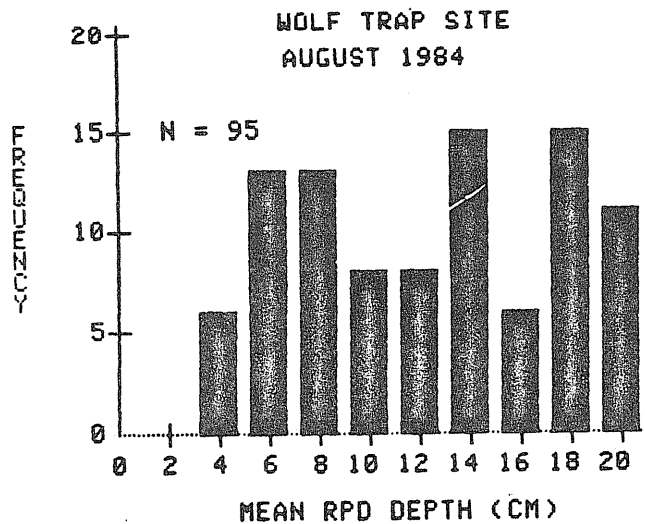
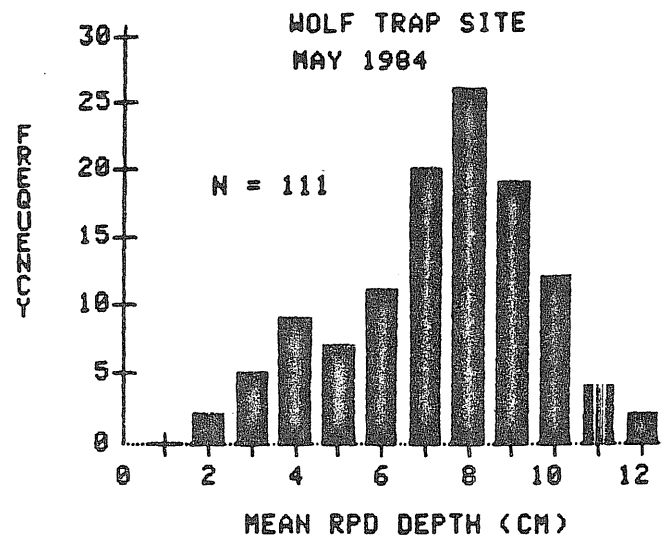
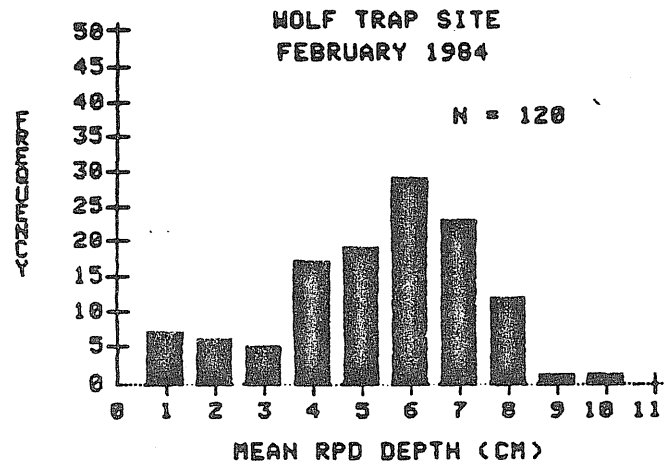
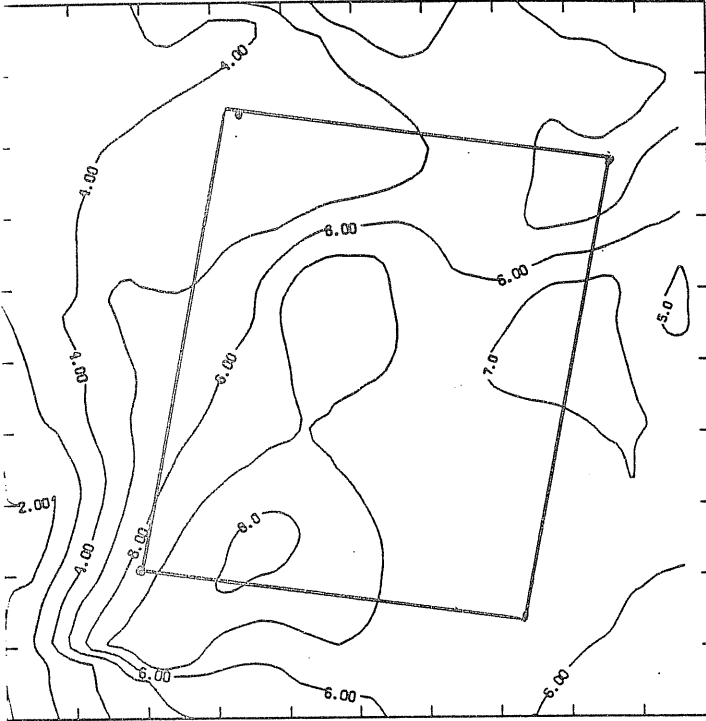

Figure IV-32. Contour maps of RPD depths (1 cm intervals), averaged by station, at the Wolf Trap Site for each survey. The maps are arranged in the following order:

February	May
August	October

Location of disposal area within the Wolf Trap site is shown approximately.

WOLF TRAP SITE RPD



CENTOUR FROM 0.00000E+00 TO 9.00000
 X INTERVAL= 0.44931E-04 Y INTERVAL= 0.62317E-04
 CENTOUR INTERVAL OF 1.00000

WOLF TRAP SITE RPD

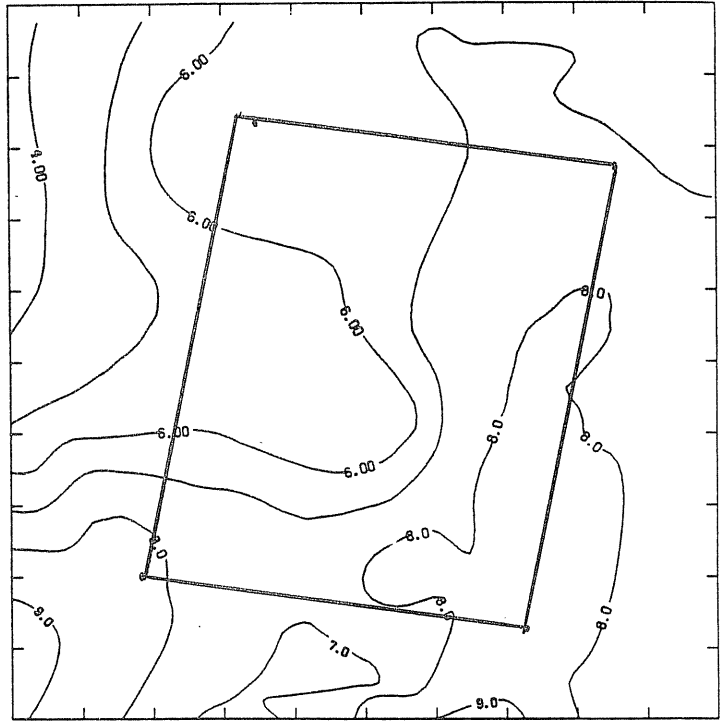

CENTOUR FROM 0.00000E+00 TO 9.00000
 X INTERVAL= 0.41892E-04 Y INTERVAL= 0.62460E-04
 CENTOUR INTERVAL OF 1.00000

WOLF TRAP SITE RPD

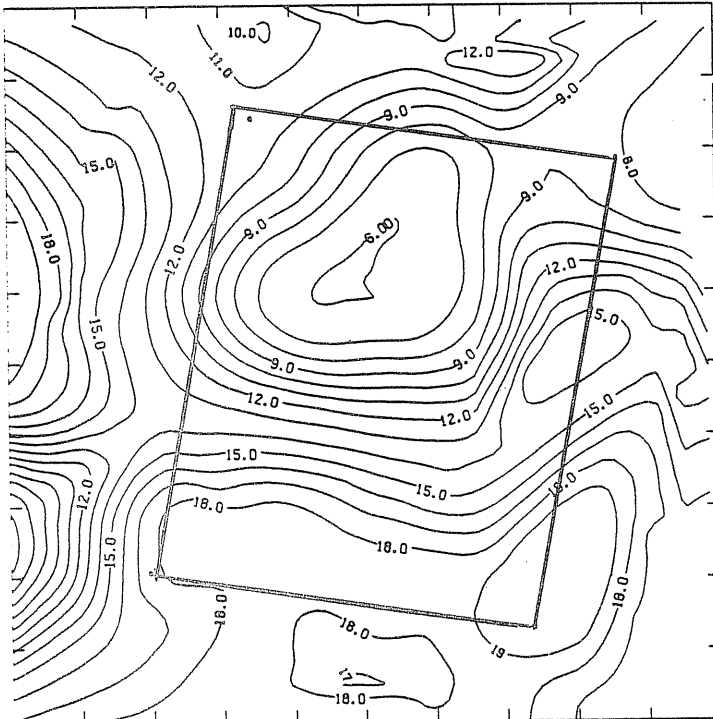

CENTOUR FROM 0.00000E+00 TO 19.00000
 X INTERVAL= 0.43772E-04 Y INTERVAL= 0.62460E-04
 CENTOUR INTERVAL OF 1.00000

WOLF TRAP SITE RPD

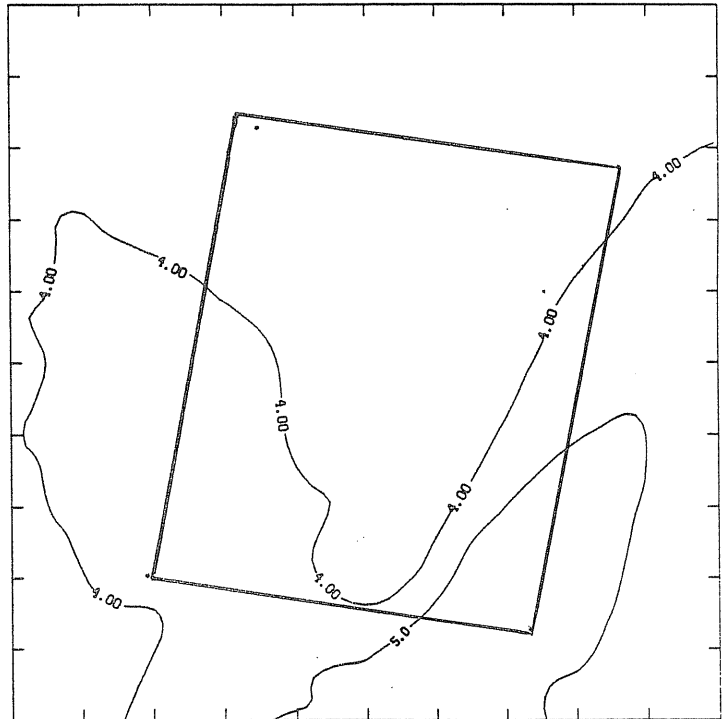

CENTOUR FROM 0.00000E+00 TO 9.00000
 X INTERVAL= 0.41892E-04 Y INTERVAL= 0.62460E-04
 CENTOUR INTERVAL OF 1.00000

Figure IV-33. Frequency distributions of the percentage areal cover of each 1 cm RPD contour interval at the Wolf Trap Site from February to October.

FEBRUARY

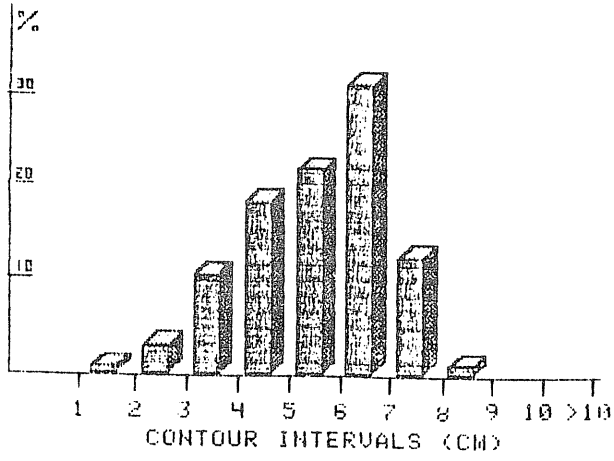

MAY

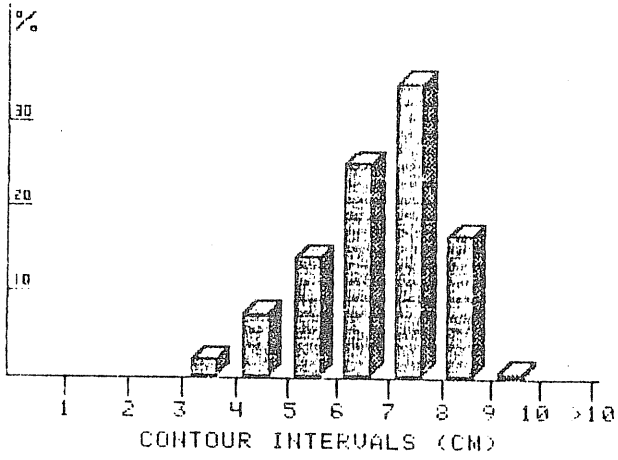

AUGUST

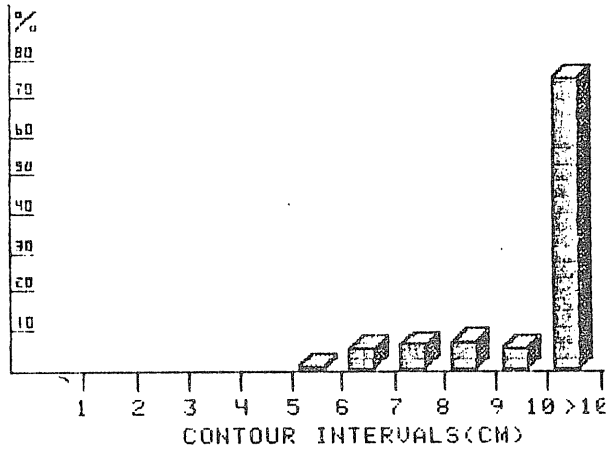

OCTOBER

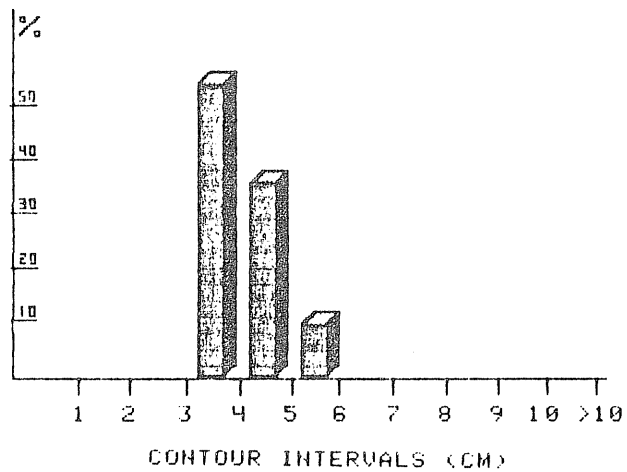

Figure IV-34. Frequency distributions of benthic index values at the Wolf Trap Site from February to October. Note scale differences on the Y axis between graphs.

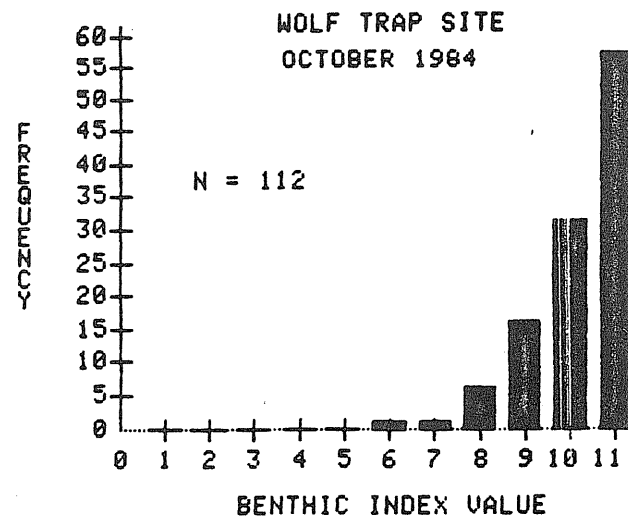
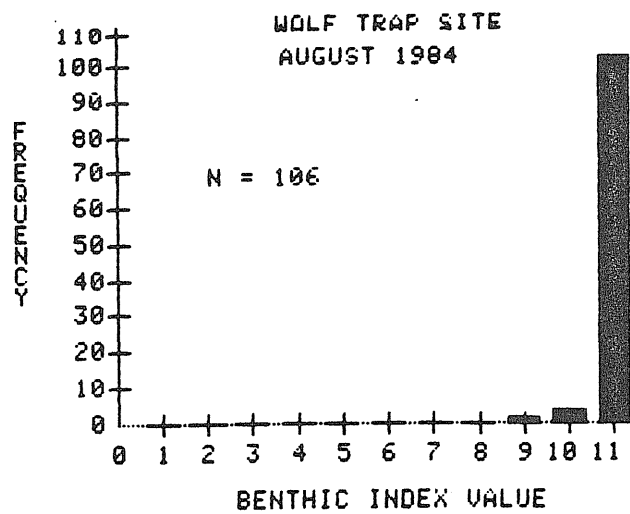
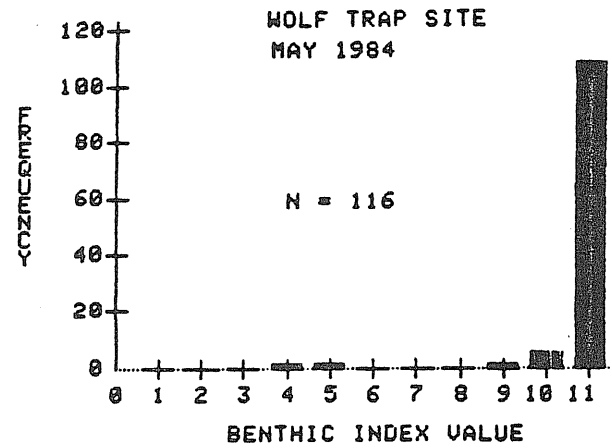
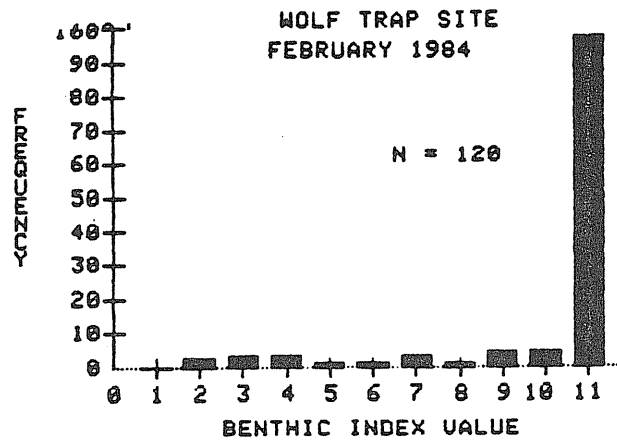
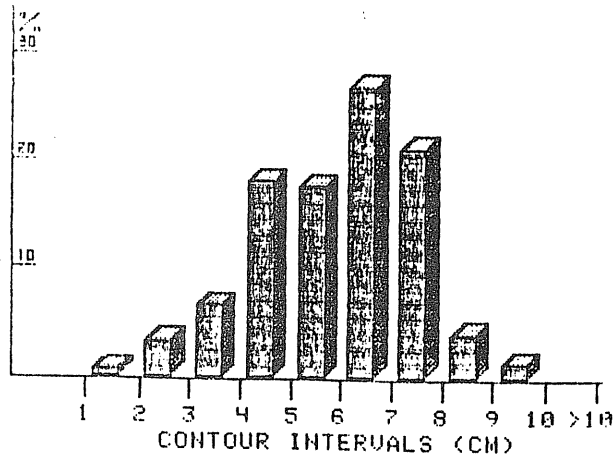
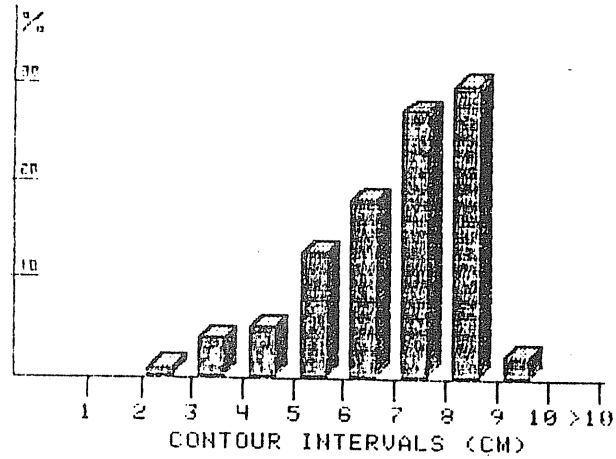

Figure IV-35. Frequency distributions of boundary roughness values at the Wolf Trap Alternate Site. Note scale differences on the Y axis between sampling times.

FEBRUARY



MAY



AUGUST

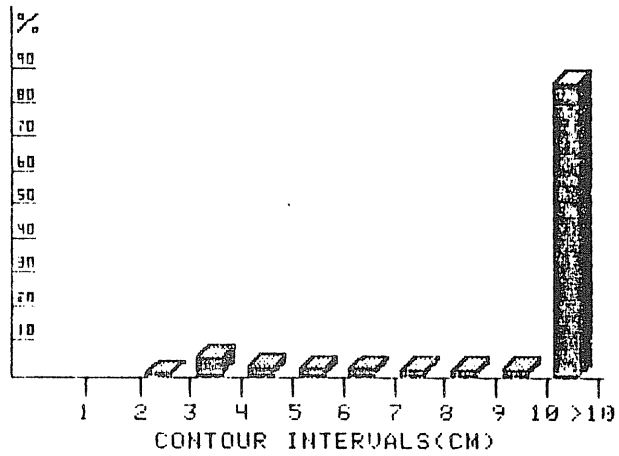

OCTOBER

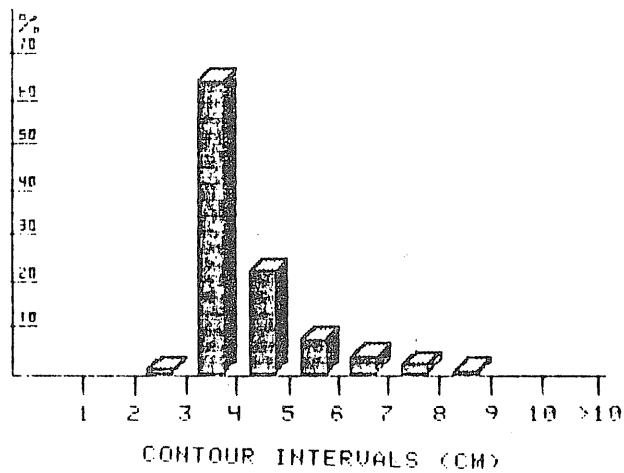

Figure IV-36. Frequency distributions of the mean RPD depths (cm) at the Wolf Trap Alternate Site. Note the scale differences on the X and Y axes.

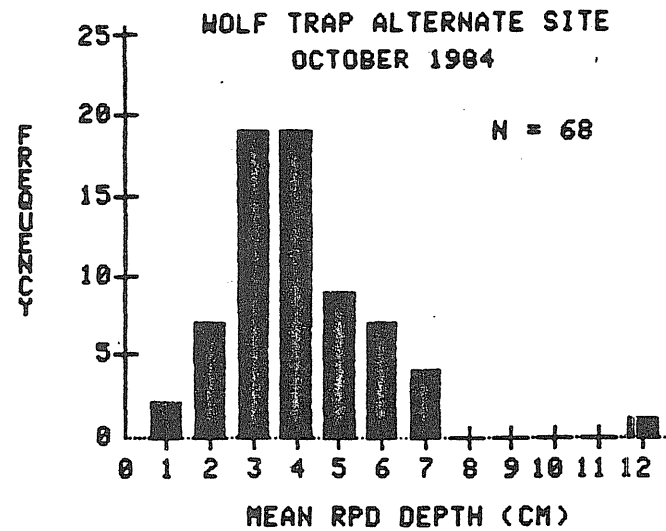
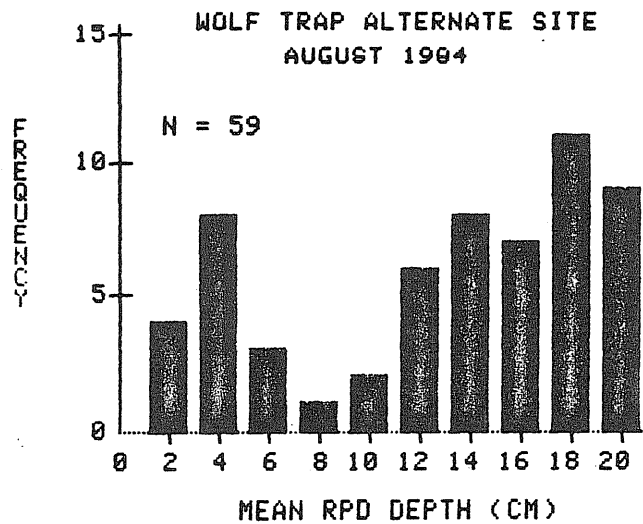
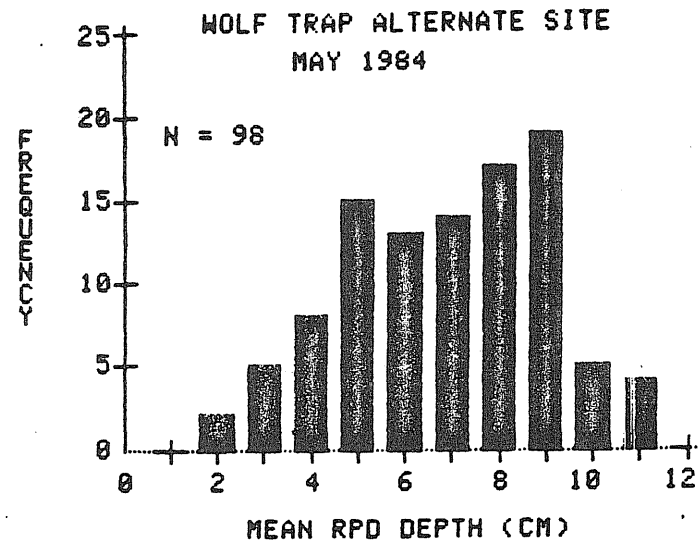
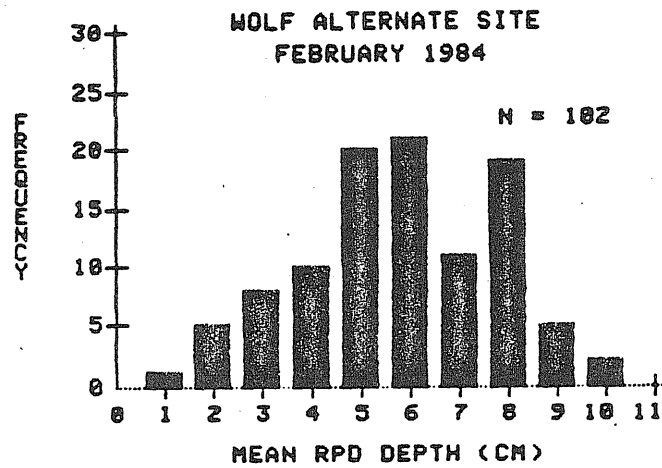

Figure IV-37. Contour maps of RPD depths (1 cm intervals), averaged by station, at the Wolf Trap Alternate Site for each survey. The maps are arranged in the following order:

February

May

August

October

Location of the disposal site within the Wolf Trap Alternate site is shown approximately.

WOLF ALTERNATE SITE RPD

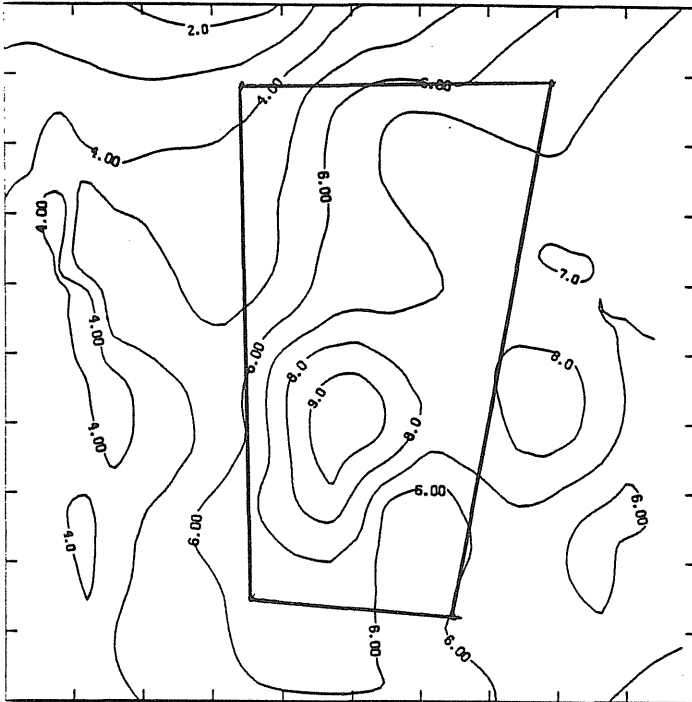

CENTUR FROM 0.00000E+00 TO 9.00000 CENTUR INTERVAL OF 1.00000
 X INTERVAL= 0.53762E-04 Y INTERVAL= 0.82088E-04

WOLF ALTERNATE SITE RPD

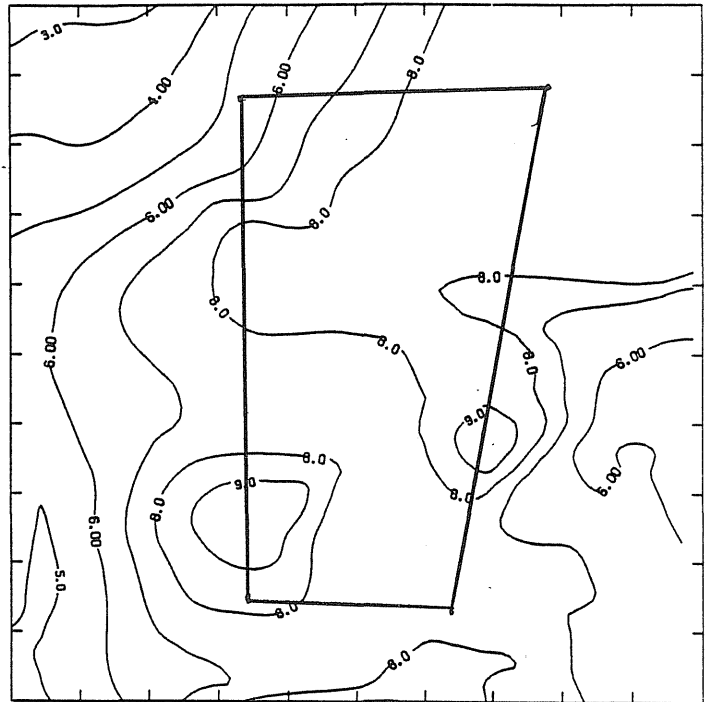

CENTUR FROM 0.00000E+00 TO 9.00000 CENTUR INTERVAL OF 1.00000
 X INTERVAL= 0.49020E-04 Y INTERVAL= 0.81909E-04

WOLF ALTERNATE SITE RPD

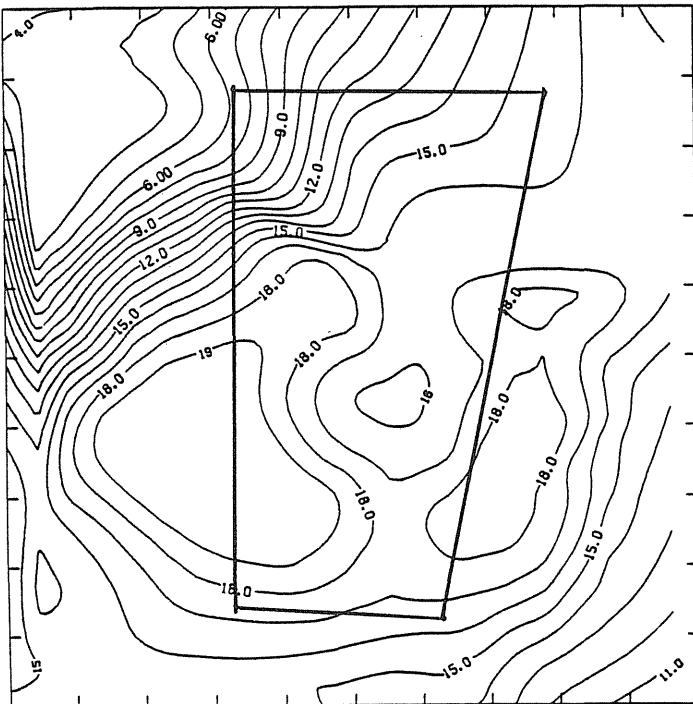

CENTUR FROM 0.00000E+00 TO 19.00000 CENTUR INTERVAL OF 1.00000
 X INTERVAL= 0.45812E-04 Y INTERVAL= 0.81909E-04

WOLF ALTERNATE SITE RPD

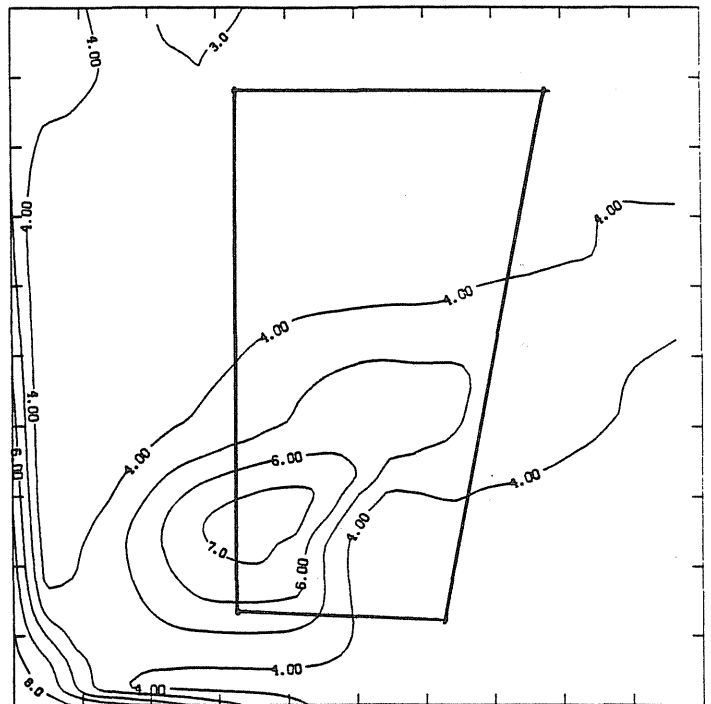

CENTUR FROM 0.00000E+00 TO 9.00000 CENTUR INTERVAL OF 1.00000
 X INTERVAL= 0.45812E-04 Y INTERVAL= 0.81909E-04

Figure IV-38. Frequency distributions of the percentage areal cover of each 1 cm RPD contour interval at the Wolf Trap Alternate Site from February to October.

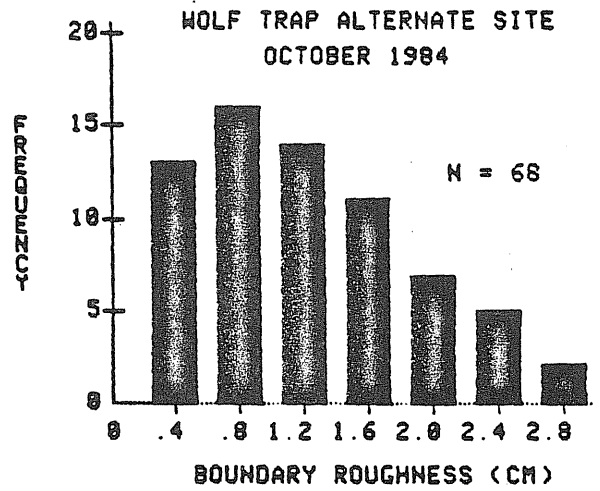
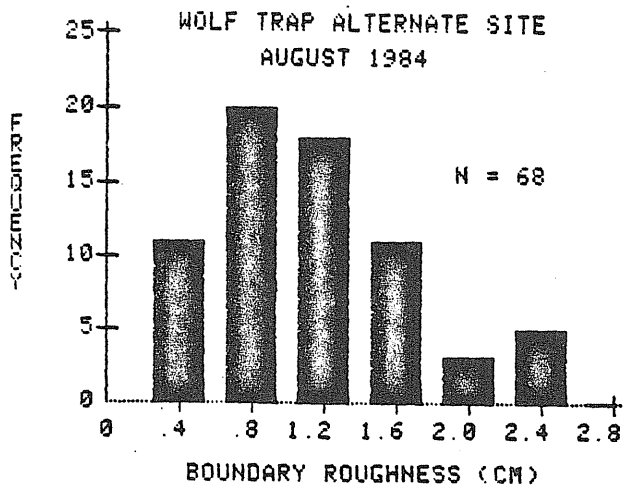
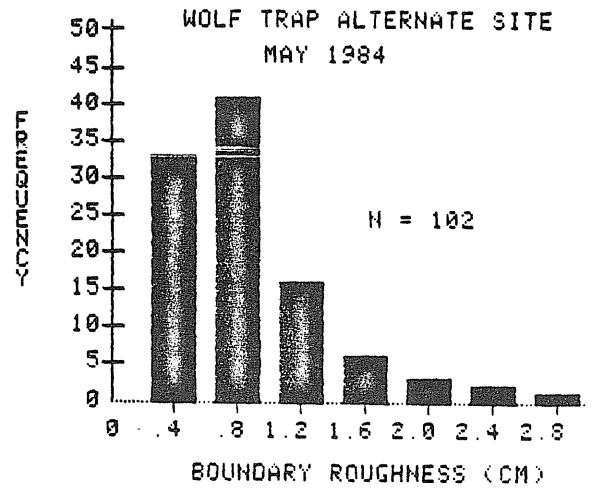
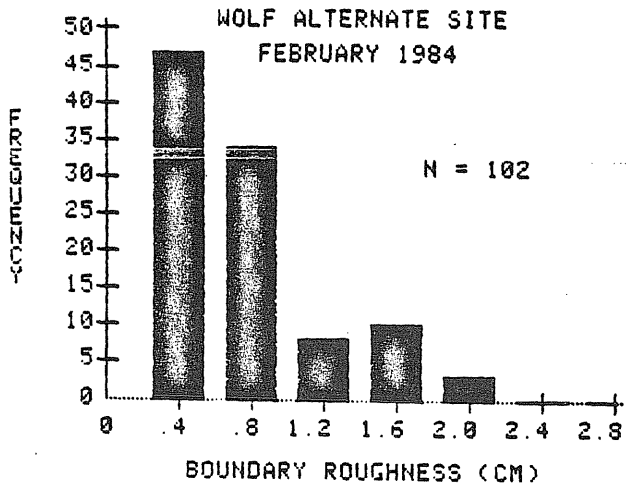
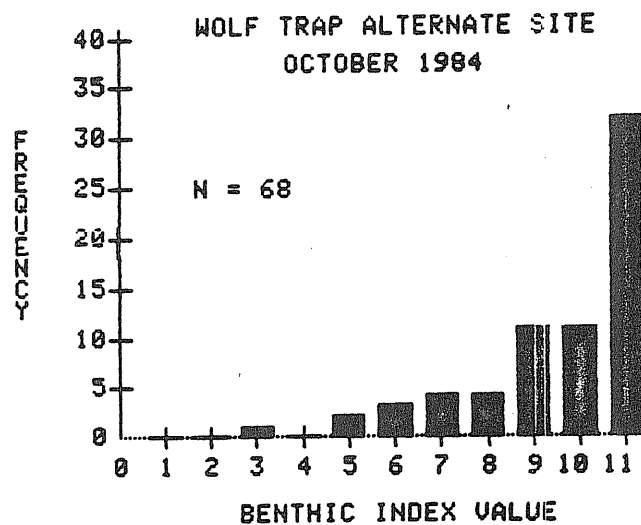
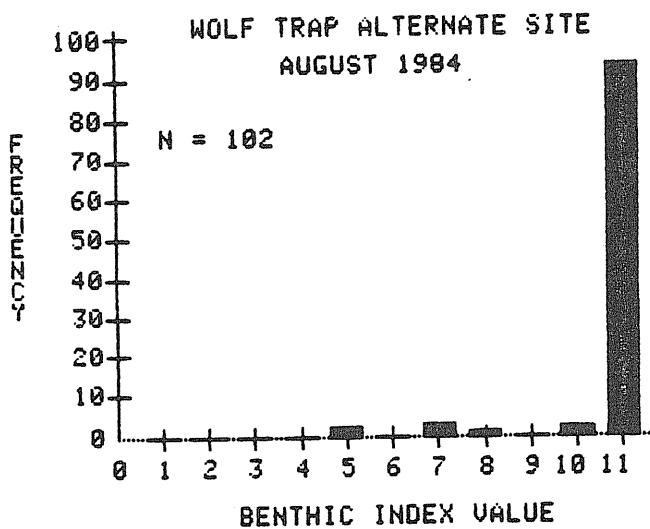
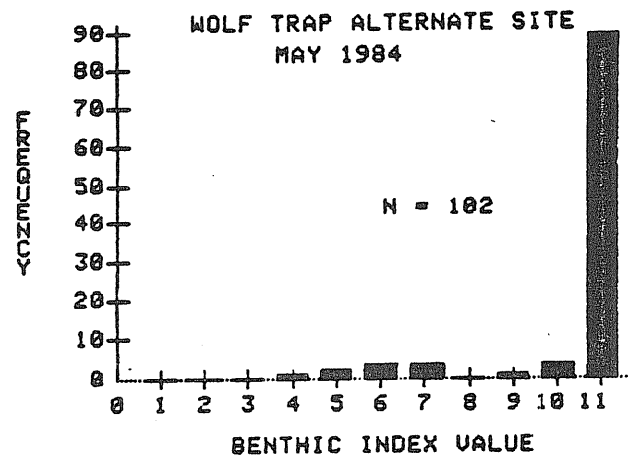
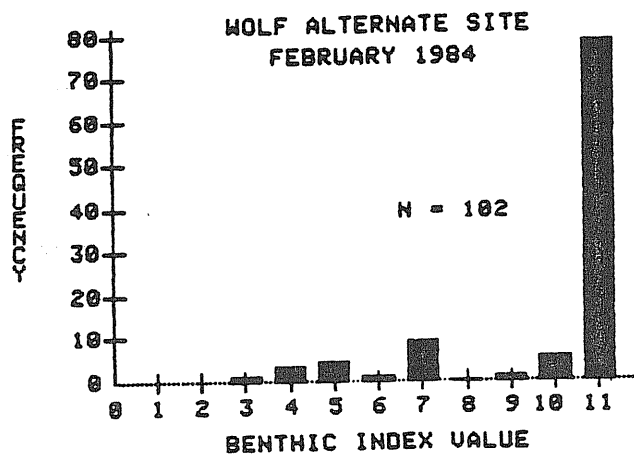

Figure IV-39. Frequency distributions of benthic index values at the Wolf Trap Alternate Site from February to October. Note scale differences on the Y axis between graphs.



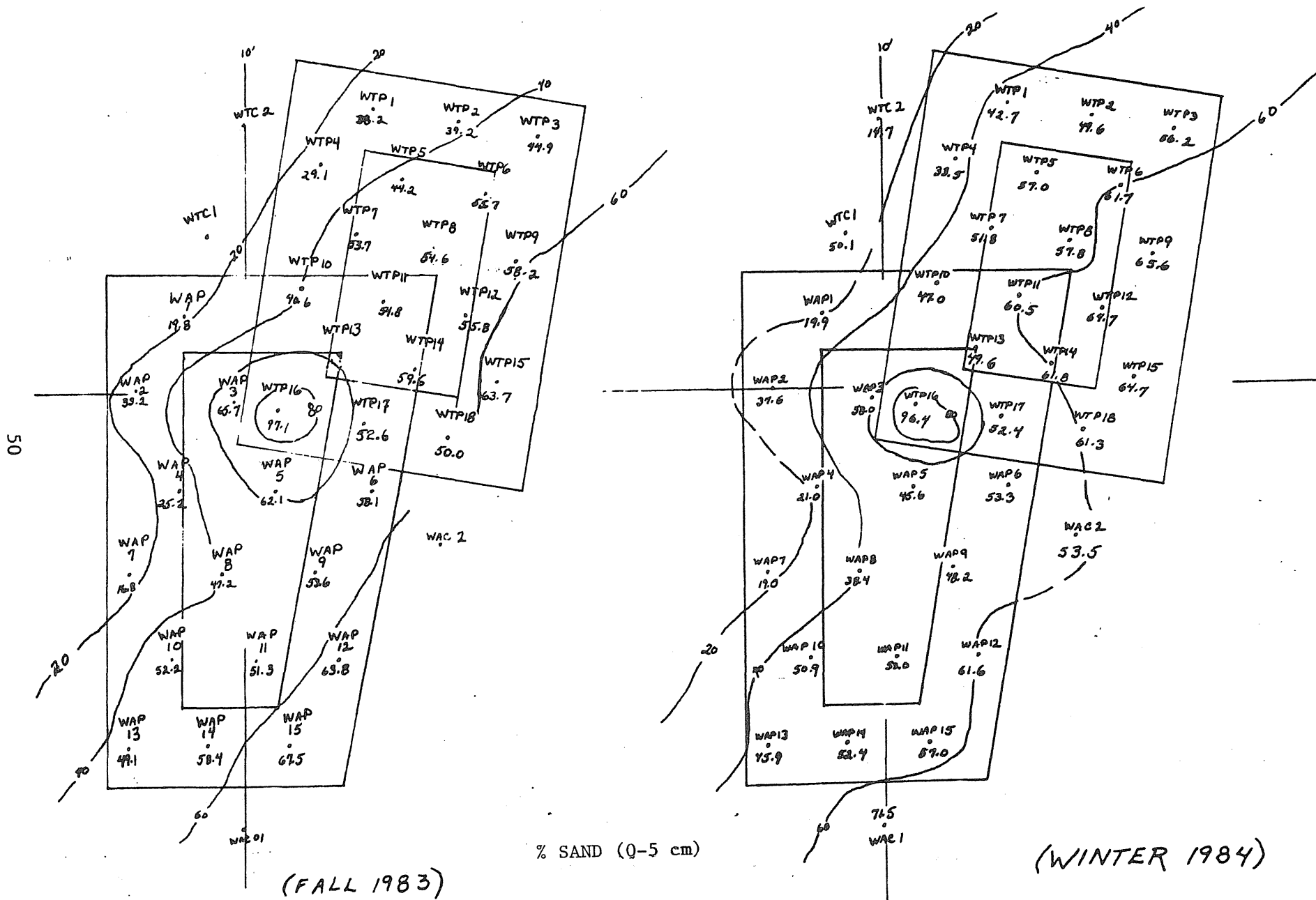

Figure IV-40. The distribution of sand in surface sediments in the Wolf Trap study region during November 1983 and February 1984.

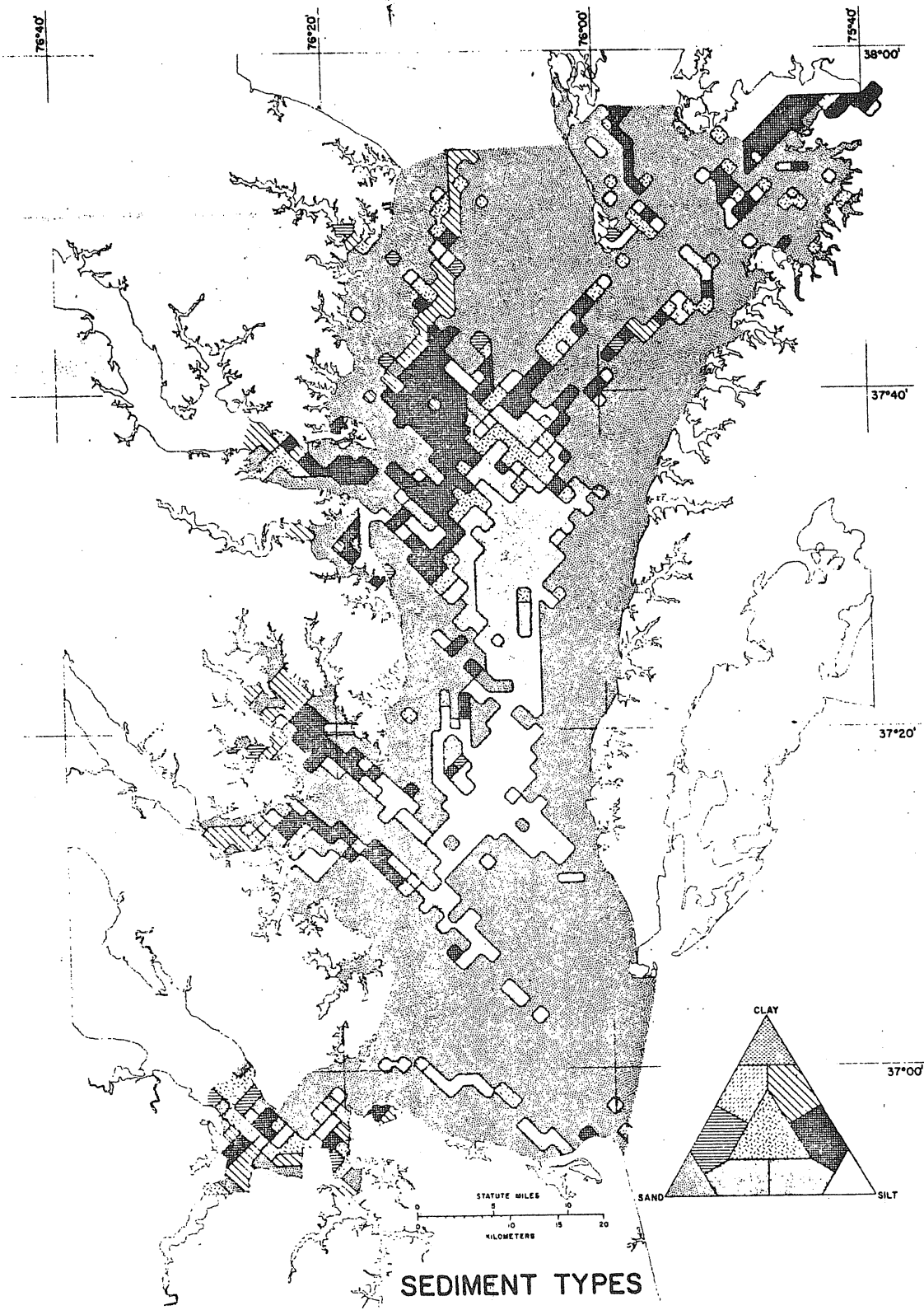

Figure IV-41. Map of the distribution of sediment types, lower Chesapeake Bay (from Byrne, et. al., 1982).

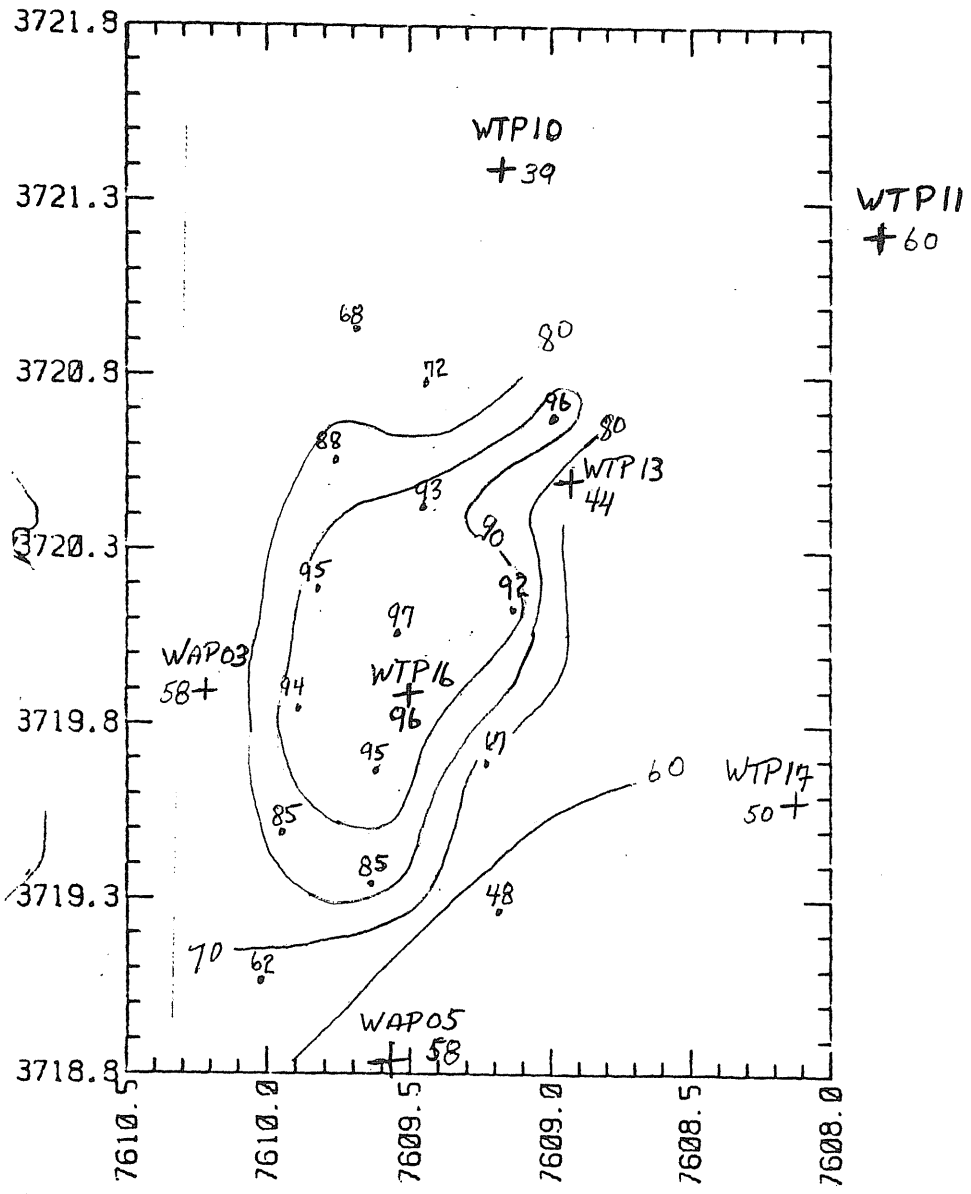

Figure IV-42. Distribution of sand content (0-5 cm horizon) in vicinity of WTP16.

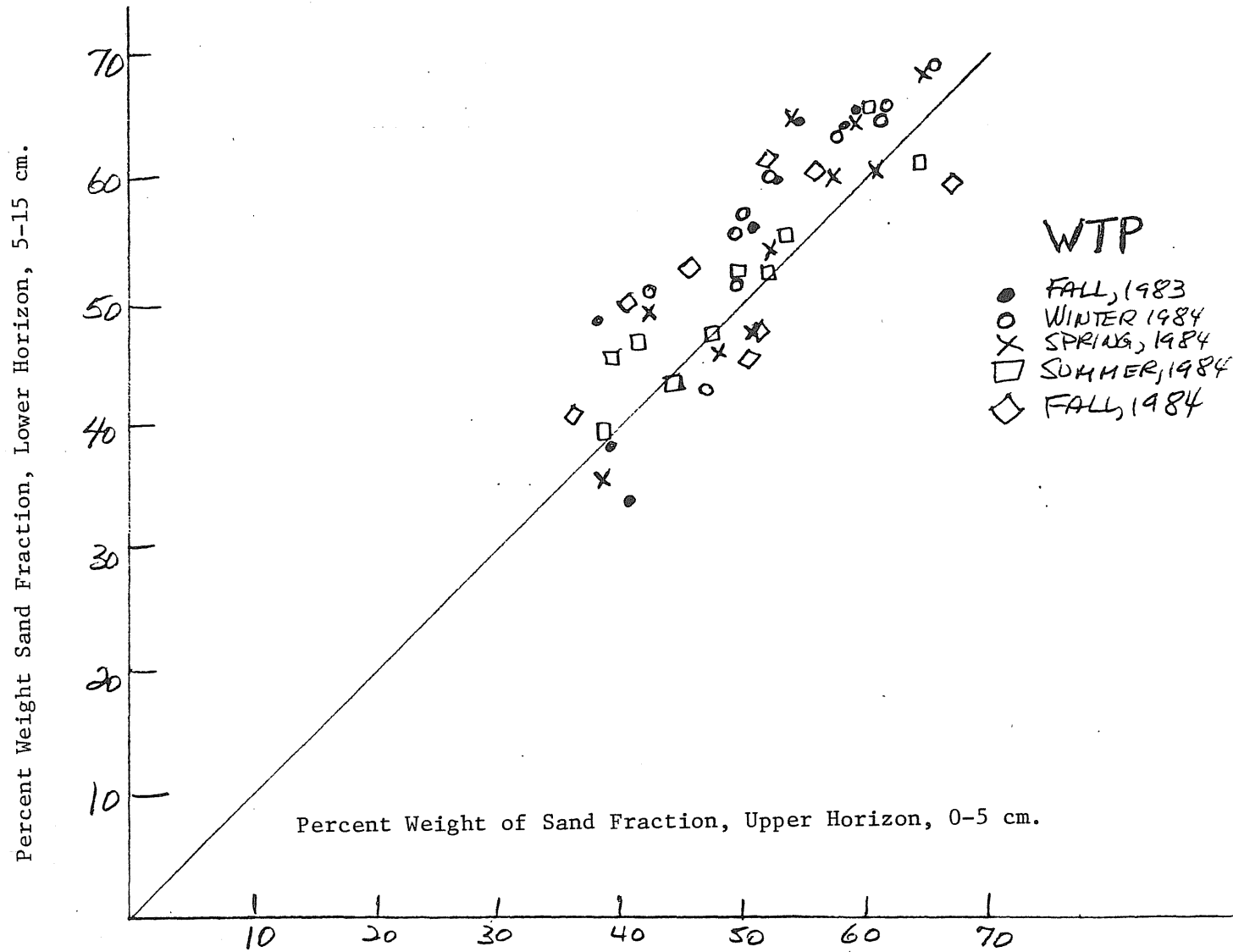

Figure IV-43. Wolf Trap Primary Disposal Area. Plot of percent weight sand in upper and lower horizons.

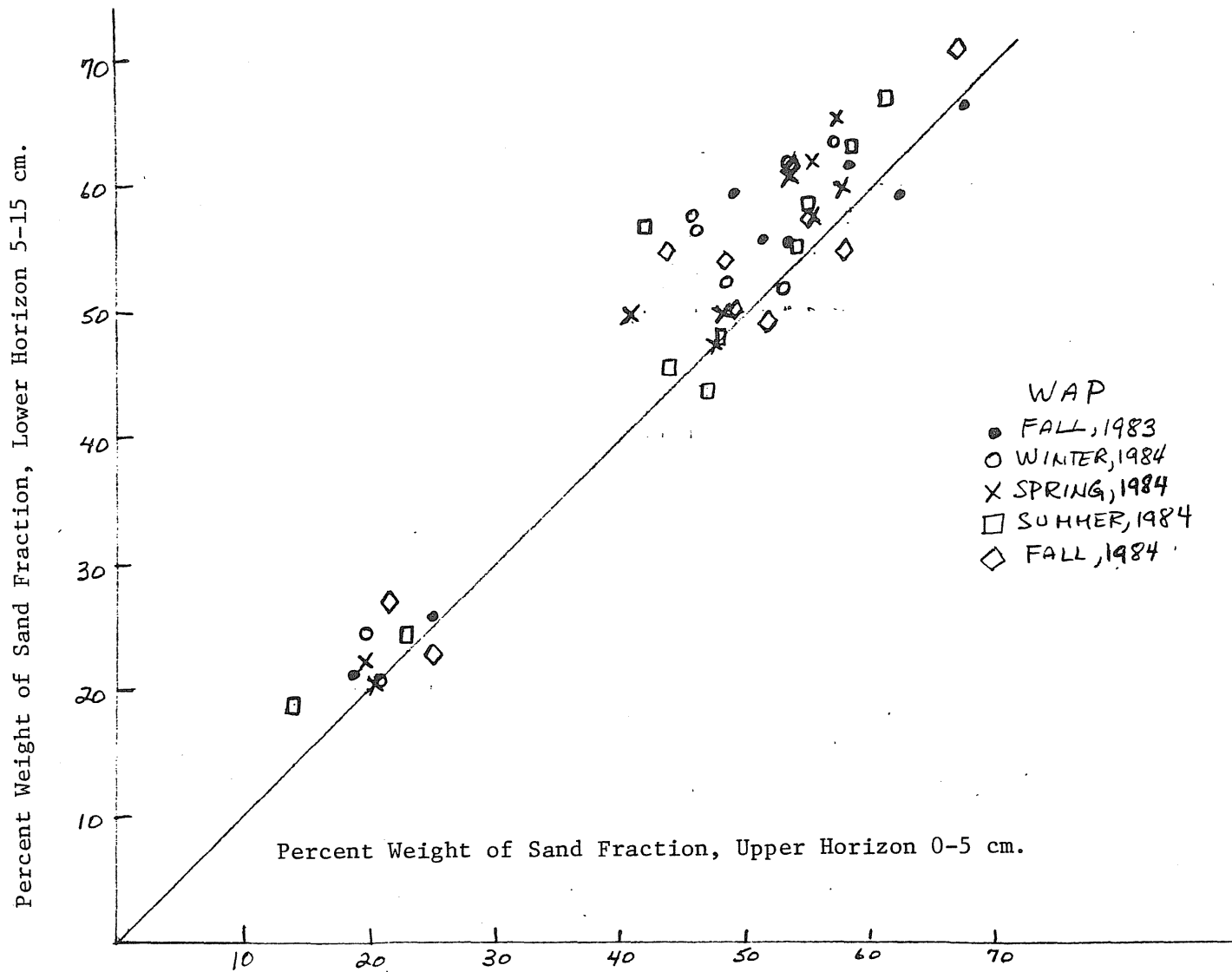

Figure IV-44. Wolf Trap Alternate Disposal Area. Plot of percent weight sand in upper and lower horizons.

Table IV-1. Total taxonomic listing for both the Wolf Trap and Rappahannock Shoals Study Regions. Number are the total occurrences of the taxa at each site.

SPECIES / SITE	WT	WA	RS	RA
TOTAL NUMBER OF STATIONS	69	62	53	50

PHYLUM PORIFERA				
PORIFERA	1	0	0	0
PHYLUM CNIDARIA				
HYDROZOA	15	32	7	0
ECTOPLEURA DUMORTIERI	0	1	0	0
TUBULARIA CROCEA	0	2	0	0
CLYTIA	15	14	1	8
SERTULARIA ARGENTEA	25	22	27	13
ANTHOZOA	10	8	2	0
EDWARDSIA	17	16	13	13
DIADUMENE	2	2	6	0
CERIANTHEOPSIS AMERICANUS	31	22	4	2
PHYLUM TURBELLARIA				
POLYCLADIA	82	70	31	17
PHYLUM NEMERTEA				
RHYNCHOCOELA	8	10	3	0
TUBULANUS PELLUCIDUS	59	51	20	18
CEREBRATULUS LACTEUS	20	13	5	5
MICRURA RUBRA	27	17	0	3
AMPHIPORUS BIOCULATUS	14	11	4	8
PHYLUM ANNELIDA				
ANNELIDA -(POLYCHAETA)	2	4	0	0
POLYNOIDAE	14	7	3	0
HARMOTHOE	2	0	0	0
HARMOTHOE EXTENUATA	2	1	0	0
HARMOTHOE LUNULATA	37	34	2	3
LEPIDAMETRIA COMMENSALIS	14	8	4	3
LEPIDONOTUS SUBLEVIS	5	1	2	0
BHAWANIA GOODEI	64	56	14	8
PHYLLODOCIDAE	0	2	0	1
ETEONE HETEROPODA	2	2	19	18
EUMIDA SANGUINEA	2	0	8	5
PHYLLODOCE	5	3	0	0
PHYLLODOCE ARENAE	12	8	7	4
HESIONIDAE	2	1	1	0
GYPTIS VITTATA	20	14	1	1
GYPTIS BREVIPALPA	66	57	23	11
PODARKE OBSCURA	1	0	0	0

Table IV-1 (continued).

SPECIES / SITE	WT	WA	RS	RA
TOTAL NUMBER OF STATIONS	69	62	53	50
PILARGIDAE	1	1	2	0
ANCISTROSYLLIS JONESI	1	1	3	0
CABIRA INCERTA	23	19	6	5
SIGAMBRA	0	0	2	0
SIGAMBRA TENTACULATA	65	62	37	41
SYLLIDAE	2	1	0	0
NEREIDAE	1	3	2	0
NEREIS GRAYI	4	0	0	0
NEREIS SUCCINEA	34	33	31	28
NEPHTYIDAE	54	46	26	17
NEPHTYS BUCERA	1	0	0	0
NEPHTYS INCISA	10	20	1	0
NEPHTYS PICTA	66	58	31	24
GLYCERIDAE	0	0	2	0
GLYCERA	2	1	0	0
GLYCERA AMERICANA	51	53	26	28
GLYCERA DIBRANCHIATA	13	1	26	0
GLYCIDAE SOLITARIA	63	54	39	41
OPHELIA BICORNIS	0	0	0	1
CAPITELLIDAE	3	1	0	0
CAPITELLA CAPITATA	1	0	0	0
HETEROMASTUS FILIFORMIS	10	4	3	0
NOTOMASTUS LATERICEUS	61	53	4	8
MEDIOMASTUS AMBISETA	43	43	26	32
MALDANIDAE	1	2	2	0
CLYMENELLA TORQUATA	59	41	27	6
CLYMENELLA ZONALIS	68	58	11	7
ASYCHIS ELONGATA	40	28	16	9
SPIONIDAE	8	9	4	0
POLYDORA LIGNI	36	33	26	11
PRIONOSPION	32	20	0	0
PARAPRIONOSPION PINNATA	64	61	49	48
SCOLECOLEPIDES VIRIDIS	2	3	6	0
SCOLELEPIS SQUAMATA	15	10	3	1
SPION SETOSA	0	0	1	0
SPIOPHANES BOMBYX	5	17	12	1
STREBLOSPION BENEDICTI	2	0	17	5
CHAETOPTERUS VARIOPEDATUS	36	40	1	1
SPIOCHAETOPTERUS OCULATUS	10	14	6	2
SABELLARIA VULGARIS	0	1	5	0
DIDPATRA CUPREA	13	9	1	0
ARABELLIDAE	0	0	2	0
PSEUDEURYTHOE PAUCIBRANCHIATA	59	46	37	24

Table IV-1 (continued).

SPECIES / SITE	WT	WA	RS	RA
TOTAL NUMBER OF STATIONS	69	62	53	50
MAGELONA	0	0	4	0
ORBINIA ORNATA	0	0	7	0
SCOLOPLOS FRAGILIS	4	3	24	35
SCOLOPLOS ROBUSTUS	0	1	0	1
SCOLOPLOS RUBRA	1	0	2	0
CIRRATULIDAE	47	41	23	4
OWENIA FUSIFORMIS	40	32	10	2
CISTENA GOULDII	35	44	35	34
AMPHARETIDAE	1	1	8	0
ASABELLIDES OCVLATA	5	4	7	3
MELINNA MACULATA	1	2	23	9
TEREBELLIDAE	1	1	6	0
LOIMIA MEDUSA	57	48	23	22
SABELLA MICROPHTHALMA	1	0	0	0
OLIGOCHAETA	33	31	15	8
PHYLUM MOLLUSCA				
GASTROPODA	1	5	2	1
SAYELLA	19	14	29	38
CYCLOSTREMISCUS PENTAGONA	14	13	1	2
TEINOSTOMA CRYPTOSPIRA	1	1	0	0
EPITONIUM RUPICOLUM	4	4	5	2
POLINICES DUPLICATUS	4	0	0	1
EUPLEURA CAUDATA	0	1	2	0
ASTYRIS LUNATA	3	1	1	2
BUSYCON CARICA	1	0	0	0
NASSARIUS VIBEX	1	3	1	1
NASSARIUS TRIVITTATUS	43	34	1	2
KURTZIELLA	0	1	0	0
ACTEON PUNCTOSTRIATUS	2	1	12	14
CYLICHNA ALBA	33	22	1	3
ACTEOCINA CANALICULATA	56	54	36	40
PYRAMIDELLIDAE	0	0	1	1
ODOSTOMIA	4	5	4	1
ODOSTOMIA IMPRESSA	0	0	1	0
ODOSTOMIA DUX	0	0	1	0
PYRAMIDELLA CANDIDA	1	0	0	0
TURBONILLA	1	3	1	0
TURBONILLA INTERRUPTA	37	38	7	12
TURBONILLA STRICTA	0	0	1	1
DORIDELLA OBSCURA	1	0	1	0
CRATENA KAORUAE	3	4	0	0
PELECYPODA	6	21	16	4
NUCULA PROXIMA	17	9	2	0
YOLDIA LIMATULA	36	33	2	1

Table IV-1 (continued).

SPECIES / SITE	WT	WA	RS	RA
TOTAL NUMBER OF STATIONS	69	62	53	50
ANADARA	2	0	0	0
ANADARA TRANSVERSA	15	17	15	4
ANADARA OVALIS	1	1	0	0
NOETIA PONDEROSA	1	0	0	0
MYTILUS EDULIS	13	9	2	1
LUCINA MULTILINEATA	10	4	19	4
ALIGENA ELEVATA	0	3	11	0
CYCLINELLA TENUIS	0	0	0	1
MERCENARIA MERCENARIA	0	0	12	2
GEMMA GEMMA	1	1	1	2
TELLINA AGILIS	8	2	2	0
MACOMA	33	17	13	9
MACOMA BALTHICA	6	2	2	0
MACOMA MITCHELLI	3	0	11	1
MACOMA TENTA	58	51	25	21
TAGELUS PLEBEIUS	1	0	0	0
ENSIS DIRECTUS	4	9	4	1
MULINIA LATERALIS	13	13	30	30
MYA ARENARIA	0	1	0	0
LYONSIA HYALINA	12	6	19	8
PANDORA TRILINEATA	0	1	3	0
PHYLUM ARTHROPODA				
LIMULUS POLYPHEMUS	0	1	0	0
CRUSTACEA	0	0	1	0
OSTRACODA	0	0	2	2
SARSIELLIDAE	2	5	0	0
SARSIELLA TEXANA	3	9	4	3
SARSIELLA ZOSTERICOLA	1	3	1	1
BALANUS IMPROVISUS	1	0	0	0
SQUILLA EMPUSA	1	4	0	0
MYSIDAE	5	3	2	1
NEOMYSIS AMERICANA	9	5	3	1
CUMACEA	1	0	0	0
LEUCON AMERICANUS	22	16	5	19
OXYUROSTYLIS SMITHI	27	21	16	7
EDOTEA TRILOBA	19	9	3	0
CYATHURA POLITA	4	1	2	1
PTILANTHURA	2	0	0	0
PSEUDIONE UPOGEBIAE	0	1	0	0
PERACARIDA AMPHIPODA	0	2	2	0
AMPELISCA	8	13	6	6
AMPELISCA ABDITA	64	55	32	34
AMPELISCA VERRILLI	1	9	8	1
AMPELISCA MACROCEPHALA	3	22	10	1
BATEA CATHARINENSIS	1	3	0	0

Table IV-1 (continued)

SPECIES / SITE	WT	WA	RS	RA
TOTAL NUMBER OF STATIONS	69	62	53	50
COROPHIIDAE	0	3	5	1
CERAPUS TUBULARIS	22	25	2	1
COROPHIUM	13	2	4	1
COROPHIUM ACHERUSICUM	3	1	0	0
COROPHIUM TUBERCULATUM	16	27	1	5
ERICHTHONIUS BRASILIENSIS	27	31	4	1
UNCIOLA	0	0	1	0
UNCIOLA SERRATA	0	2	4	1
PHOTIS DENTATA	2	7	0	0
LISTRIELLA	3	5	3	0
LISTRIELLA BARNARDI	60	53	12	12
LISTRIELLA CLYMENELLAE	54	36	5	1
PARAMETOPELLA CYPRIS	20	7	7	1
CAPRELLIDAE	0	0	1	0
CAPRELLA PENANTIS	1	2	0	0
CAPRELLA EQUILIBRA	1	0	0	0
PARACAPRELLA TENUIS	11	21	10	5
EUCARIDA DECAPODA	3	0	1	1
OGYRIDES HAYI	19	19	1	13
CALLIANASSA ATLANTICA	2	1	2	0
UPOGEBIA AFFINIS	0	2	0	0
POLYONYX GIBBESI	7	7	1	0
CALLINECTES SAPIDUS	0	1	1	0
XANTHIDAE	0	3	0	0
NEOPANOPE TEXANA SAYI	5	5	0	0
PANOPEUS HERBSTII	1	2	0	0
PINNOTHERIDAE	0	3	2	0
PINNIXA	9	1	2	0
PINNIXA CHAETOPTERANA	19	14	5	2
PINNIXA CYLINDRICA	4	0	0	0
PINNIXA RETINENS	16	16	6	5
PINNIXA SAYANA	0	3	0	0
THALLASEMA HARTMANI	2	3	0	0
PHYLUM PHORONIDA				
PHORONIS	48	45	29	28
PHYLUM ECTOPROCTA				
ECTOPROCTA	1	0	0	0
CTENOSTOMATA	0	0	1	0
ALCYONIDIUM VERRILLI	4	3	1	0
ANGUINELLA PALMATA	0	0	4	0
BOWERBANKIA	0	0	2	0
BOWERBANKIA GRACILIS	3	1	1	0
MEMBRANIPORA	1	0	0	0
ELECTRA	2	0	0	0
ELECTRA CRUSTULENTA	2	1	4	1

Table IV-1 (continued)

SPECIES / SITE	WT	WA	RS	RA
TOTAL NUMBER OF STATIONS	69	62	53	50
PHYLUM ECHINODERMATA				
MICROPHOLIS ATRA	54	55	6	9
SCLERODACTYLIDAE	2	2	0	0
SCLERODACTYLA BRIAREUS	9	5	3	3
LEPTOSYNAPTA TENUIS	1	0	0	0
PHYLUM HEMICHORDATA				
SACCOGLOSSUS KOWALEWSKII	36	26	2	2
PHYLUM UROCHORDATA				
MOLGULA MANHATTENSIS	7	14	5	0

Table IV-2 . Mean abundance of dominants from the Wolf Trap Study region by season per 0.12 m².

Species	Fall '84	Winter '85	Spring '85	Summer '85	Fall '85
Number of Stations	0.7	0.8	0.5	0.1	0.2
<u>Ceriantheopsis americanus</u>	1.0	1.3	0.5	0.8	1.1
<u>Polycladia</u>	4.5	4.2	5.7	5.5	4.3
<u>Tubulanus pellucidus</u>	12.0	6.7	3.3	8.0	3.7
<u>Harmothoe lunulata</u>	1.9	1.4	3.0	2.7	2.3
<u>Bhawania goodei</u>	40.3	22.7	31.8	20.4	16.9
<u>Gyptis brevipalpa</u>	18.2	11.9	9.1	6.0	9.2
<u>Cabira incerta</u>	1.5	0.5	0.6	0.7	1.0
<u>Sigambra tentaculata</u>	51.6	10.5	22.5	23.3	21.6
<u>Nereis succinea</u>	2.0	1.2	1.4	2.1	3.0
<u>Nephtyidae</u>	44.2	53.0	29.1	0.7	1.4
<u>Nephtys incisa</u>	0.6	0.4	0.6	0.2	0.0
<u>Nephtys picta</u>	14.0	7.0	8.5	25.8	12.8
<u>Glycera americana</u>	10.3	8.8	5.6	0.8	1.1
<u>Glycinde solitaria</u>	7.4	5.5	2.4	5.9	15.0
<u>Notomastus latericeus</u>	36.8	24.7	14.2	7.3	6.8
<u>Mediomastus ambiseta</u>	3.3	1.5	3.7	2.2	10.6
<u>Clymenella torquata</u>	3.2	3.7	4.8	5.0	3.0
<u>Clymenella zonalis</u>	128.4	103.5	116.3	85.8	97.3
<u>Asychis elongata</u>	1.7	0.6	1.1	1.0	1.0
<u>Polydora ligni</u>	1.1	4.4	23.6	1.8	0.0
<u>Paraprionospio pinnata</u>	71.2	63.4	44.3	31.5	113.5
<u>Scoelelepis squamata</u>	0.8	0.4	0.2	0.0	0.1
<u>Spiophanes bombyx</u>	0.3	2.3	0.7	0.2	0.4
<u>Chaetopterus variopedatus</u>	15.8	7.4	2.8	1.6	1.2
<u>Pseudeurythoe paucibranchiata</u>	6.4	4.0	14.4	4.2	8.3
<u>Cirratulidae</u>	9.0	6.0	2.6	1.4	4.8
<u>Owenia fusiformis</u>	2.3	1.8	1.3	1.0	1.8
<u>Cistena gouldii</u>	5.1	2.1	2.8	4.0	1.0
<u>Loimia medusa</u>	12.4	7.0	3.5	1.8	15.1
<u>Oligochaeta</u>	2.1	2.1	3.5	2.7	1.4
<u>Nassarius trivittatus</u>	5.3	3.8	3.9	0.2	2.6
<u>Acteocina canaliculata</u>	7.0	6.8	7.7	1.5	7.0
<u>Turbonilla interrupta</u>	3.2	2.4	5.2	1.2	1.0
<u>Pelecypoda</u>	0.0	3.4	1.2	0.1	0.5
<u>Nucula proxima</u>	0.5	0.3	0.8	0.4	0.2
<u>Yoldia limatula</u>	1.0	0.6	10.0	5.4	0.7
<u>Anadara transversa</u>	0.8	0.7	1.5	0.0	0.2
<u>Macoma</u>	5.7	7.5	4.6	0.1	0.0
<u>Macoma tenta</u>	13.9	15.0	13.0	15.5	3.1
<u>Oxyurostylis smithi</u>	1.0	1.7	0.8	0.0	0.1
<u>Ampelisca abdita</u>	8.0	12.9	11.1	7.6	5.4
<u>Ampelisca macrocephala</u>	0.9	0.5	0.1	2.0	0.0
<u>Corophium tuberculatum</u>	0.3	1.2	1.0	3.9	0.4
<u>Erichthonius brasiliensis</u>	3.2	5.3	3.6	1.0	4.7

Table IV-2 (continued)

Species	Fall '84	Winter '85	Spring '85	Summer '85	Fall '85
Number of Stations	0.7	0.8	0.5	0.1	0.2
<u>Listriella barnardi</u>	16.6	15.7	9.0	3.3	3.8
<u>Paracaprella tenuis</u>	1.3	0.6	3.3	0.0	0.0
<u>Micropholis atra</u>	4.2	2.4	2.0	1.9	1.4
<u>Saccoglossus kowalewskii</u>	1.7	1.4	1.7	0.3	1.0
<u>Mulinia lateralis</u>	0.0	0.1	10.3	28.3	0.1
<u>Edotea triloba</u>	0.4	0.6	1.0	1.7	0.0
<u>Clytia</u>	0.2	0.1	0.4	1.2	0.2
<u>Sertularia argentea</u>	0.1	0.4	0.8	1.2	0.8
<u>Mytilus edulis</u>	0.0	0.0	16.8	3.9	0.0
<u>Ampelisca</u>	0.9	0.2	0.1	0.5	0.0
<u>Phoronis</u>	1.2	2.7	3.1	3.2	3.4
<u>Molgula manhattensis</u>	0.2	0.2	0.0	5.0	0.5
<u>Cerebratulus lacteus</u>	0.4	0.5	0.7	0.7	0.2
<u>Polynoidae</u>	0.6	0.1	0.5	0.1	0.3
<u>Phyllodoce arenae</u>	0.5	0.1	0.2	0.0	0.6
<u>Prionospio</u>	2.4	0.4	0.6	1.9	2.8
<u>Pinnixa chaetoptera</u>	1.0	0.8	0.2	0.0	1.0
<u>Pinnixa retinens</u>	0.7	0.5	0.4	0.1	1.1
<u>Edwardsia</u>	0.4	0.7	0.3	0.0	0.3
<u>Micrura rubra</u>	0.5	1.3	1.3	0.2	0.2
<u>Amphiporus bioculatus</u>	0.1	0.2	1.0	0.6	0.7
<u>Gyptis vittata</u>	1.9	0.3	0.4	0.7	0.7
<u>Cyclostremiscus pentagona</u>	1.3	0.6	0.2	0.4	0.1
<u>Cylichna alba</u>	1.7	1.4	0.7	0.0	0.5
<u>Leucon americanus</u>	1.5	1.8	2.1	0.2	0.4
<u>Cerapus tubularis</u>	3.8	1.1	1.7	0.3	0.3
<u>Listriella clymenellae</u>	4.3	4.5	5.8	5.3	5.8
<u>Spiochaetopterus oculatus</u>	0.6	0.2	0.1	0.1	0.2
<u>Lepidametria commensalis</u>	0.2	0.2	0.1	0.4	1.6
<u>Sayella</u>	0.8	0.1	1.2	1.0	3.8
<u>Ogyrides hayi</u>	1.4	1.4	0.5	0.3	0.2
<u>Diopatra cuprea</u>	0.3	0.2	0.5	0.2	0.3
<u>Parametopella cypris</u>	1.2	0.9	1.4	0.0	0.0

Table IV-3. Average abundance of dominant species from the Wolf Trap Study region for all cruises.

Species	WT			WA			Grand Mean
	Disposal	Fringe	Control	Disposal	Fringe	Control	
Number of Stations	24	36	8	27	28	8	131
<u>Ceriantheopsis americanus</u>	1.0	1.3	0.2	1.1	0.2	2.6	1.0
<u>Polycladia</u>	5.2	4.9	4.9	3.4	4.9	6.5	4.7
<u>Tubulanus pellucidus</u>	7.3	9.2	3.2	5.6	7.3	6.1	7.2
<u>Harmothoe lunulata</u>	2.9	1.6	2.0	2.1	1.9	2.5	2.1
<u>Bhawania goodei</u>	43.2	33.4	13.1	17.2	21.3	16.9	27.0
<u>Gyptis brevipalpa</u>	16.9	12.4	6.9	9.6	8.8	12.6	11.6
<u>Cabira incerta</u>	2.1	0.8	0.0	0.5	0.6	0.5	0.8
<u>Sigambra tentaculata</u>	35.9	30.4	11.1	18.2	23.4	27.9	26.0
<u>Nereis succinea</u>	1.8	1.3	3.2	2.1	1.3	4.5	1.9
<u>Nephtyidae</u>	43.5	38.2	14.0	34.6	27.4	14.6	30.4
<u>Nephtys incisa</u>	0.6	0.1	0.0	0.9	0.2	0.4	0.4
<u>Nephtys picta</u>	13.7	11.1	11.2	16.4	10.1	16.9	12.8
<u>Glycera americana</u>	8.1	6.2	1.4	5.7	6.0	6.5	6.1
<u>Glycinde solitaria</u>	6.9	7.9	8.5	4.3	7.2	10.2	7.0
<u>Notomastus latericeus</u>	29.3	30.6	5.9	15.0	10.5	12.0	20.2
<u>Mediomastus ambiseta</u>	3.2	3.2	1.5	5.2	4.1	6.2	3.9
<u>Clymenella torquata</u>	3.6	4.1	15.2	2.8	1.8	3.6	3.9
<u>Clymenella zonalis</u>	133.2	122.4	42.6	92.6	78.2	183.0	107.6
<u>Asychis elongata</u>	1.1	1.4	1.1	0.9	1.0	0.6	1.1
<u>Polydora ligni</u>	6.4	4.6	15.8	5.5	3.7	4.8	5.6
<u>Paraprionospio pinnata</u>	72.2	68.2	57.8	57.2	71.1	42.9	65.1
<u>Scolecopsis squamata</u>	0.4	0.4	0.1	0.6	0.1	0.1	0.4
<u>Spiophanes bombyx</u>	0.1	0.1	0.0	3.1	0.9	0.6	0.9
<u>Chaetopterus variopedatus</u>	9.0	8.5	2.4	6.5	5.1	3.1	6.7
<u>Pseudeurythoe paucibranchiata</u>	12.6	6.3	19.4	3.8	3.6	2.8	7.0
<u>Cirratulidae</u>	9.8	4.9	2.4	5.2	3.5	2.4	5.2
<u>Owenia fusiformis</u>	1.6	1.7	1.0	2.5	1.3	1.9	1.7
<u>Cistena gouldii</u>	5.4	1.4	5.4	2.8	3.5	0.6	3.0
<u>Loimia medusa</u>	10.2	8.8	11.5	7.1	6.5	6.4	8.2
<u>Oligochaeta</u>	2.3	2.0	2.0	1.9	2.1	6.1	2.3
<u>Nassarius trivittatus</u>	6.4	3.6	1.0	2.7	2.3	2.0	3.4
<u>Acteocina canaliculata</u>	5.8	5.0	2.2	6.8	9.3	3.2	6.2

Table IV-3 (continued)

Species Number of Stations	WT			WA			Grand Mean 131
	Disposal 24	Fringe 36	Control 8	Disposal 27	Fringe 38	Control 8	
<u>Turbonilla interrupta</u>	3.4	1.7	4.0	3.6	1.3	4.2	2.6
<u>Pelecypoda</u>	0.2	0.3	0.0	2.8	2.2	1.1	1.2
<u>Nucula proxima</u>	0.7	0.4	0.0	0.1	0.4	0.9	0.4
<u>Yoldia limatula</u>	3.3	3.7	0.6	2.1	2.8	5.0	3.0
<u>Anadara transversa</u>	0.7	0.3	2.8	1.2	0.2	0.1	0.7
<u>Macoma</u>	6.5	7.1	2.5	2.7	1.1	2.1	4.2
<u>Macoma tenta</u>	15.8	10.1	5.8	12.4	14.2	15.9	12.6
<u>Oxyurostylis smithi</u>	0.6	1.2	0.5	0.8	0.8	0.5	0.8
<u>Ampelisca abdita</u>	10.3	9.3	8.5	8.6	10.4	7.6	9.4
<u>Ampelisca macrocephala</u>	0.1	0.1	0.0	1.8	1.1	0.9	0.7
<u>Corophium tuberculatum</u>	0.7	1.2	0.2	2.4	1.1	1.1	1.3
<u>Erichthonius brasiliensis</u>	2.3	2.0	4.1	9.3	2.1	2.9	3.8
<u>Listriella barnardi</u>	12.9	12.3	8.8	11.2	8.3	9.8	11.0
<u>Paracaprella tenuis</u>	0.4	0.2	7.2	0.9	1.2	0.1	1.0
<u>Micropholis atra</u>	3.6	2.4	2.2	2.8	2.1	1.2	2.5
<u>Saccoglossus kowalewskii</u>	1.8	1.8	1.5	0.8	0.9	0.5	1.3
<u>Mulinia lateralis</u>	1.2	3.0	25.0	2.5	14.3	0.8	6.2
<u>Edotea triloba</u>	0.7	0.7	5.4	0.1	0.3	0.4	0.7
<u>Clytia</u>	0.3	0.4	0.5	0.4	0.2	0.5	0.4
<u>Sertularia argentea</u>	0.4	0.7	1.0	0.6	0.6	0.8	0.6
<u>Mytilus edulis</u>	5.8	4.2	8.2	0.3	1.6	3.2	3.3
<u>Ampelisca</u>	0.1	0.3	0.0	0.4	0.8	0.2	0.4
<u>Phoronis</u>	1.8	2.2	3.9	4.2	2.4	1.0	2.6
<u>Molgula manhattensis</u>	0.4	0.8	4.2	1.2	0.4	1.0	0.9
<u>Cerebratulus lacteus</u>	0.7	0.5	0.5	0.5	0.1	0.8	0.5
Polynoidae	0.8	0.2	0.0	0.1	0.4	0.2	0.3
<u>Phyllodoce arenae</u>	0.3	0.3	0.0	0.2	0.2	0.5	0.2
<u>Prionospio</u>	1.6	2.2	0.8	1.1	1.0	2.0	1.5
<u>Pinnixa chaetopterana</u>	0.6	0.8	1.5	0.5	0.2	1.0	0.6
<u>Pinnixa retinens</u>	0.6	0.3	0.4	0.9	0.8	0.2	0.6
<u>Edwardsia</u>	0.5	0.3	0.0	0.5	0.4	0.1	0.4

Table IV-3 (continued)

Species Number of Stations	WT			WA			Grand Mean
	Disposal 24	Fringe 36	Control 8	Disposal 27	Fringe 28	Control 8	
<u>Micrura rubra</u>	1.1	0.9	0.2	0.6	0.5	0.8	0.7
<u>Amphiporus bioculatus</u>	0.5	0.6	0.5	0.2	0.4	0.2	0.4
<u>Gyptis vittata</u>	0.8	1.5	0.2	0.5	0.2	1.6	0.8
<u>Cyclostremiscus pentagona</u>	0.3	1.0	0.0	0.4	0.6	0.6	0.6
<u>Cylichna alba</u>	1.0	1.6	0.2	0.5	1.0	0.4	1.0
<u>Leucon americanus</u>	0.2	0.7	1.1	0.3	4.1	0.4	1.3
<u>Cerapus tubularis</u>	0.8	1.4	4.2	1.0	2.8	0.4	1.6
<u>Listriella clymenellae</u>	5.2	5.8	16.2	2.7	2.9	5.0	5.0
<u>Spiochaetopterus oculatus</u>	0.2	0.2	0.0	0.3	0.4	0.2	0.2
<u>Lepidametria commensalis</u>	0.2	0.6	1.5	0.4	0.2	0.2	0.4
<u>Sayella</u>	1.3	1.4	1.2	0.7	1.3	0.0	1.4
<u>Ogyrides hayi</u>	0.3	0.7	0.6	0.8	1.9	0.0	0.9
<u>Diopatra cuprea</u>	0.4	0.2	0.5	0.4	0.4	0.0	0.3
<u>Parametopella cypris</u>	2.0	0.4	3.2	0.2	0.2	0.0	0.8

Table IV-4. Community structure parameters for the Wolf Trap Study Region.

STATION	NUMBER OF INDIV	SPEC	SHANNON FORMULA H-PRIME EVENNESS-JPR	
WAC012	575	50	4.0328	0.7146
WAC013	282	21	3.1121	0.7085
WAC014	332	39	4.0932	0.7744
WAC015	428	41	3.8872	0.7255
WAC022	713	51	3.9276	0.6924
WAC023	546	26	2.7165	0.5779
WAC024	470	37	3.9920	0.7663
WAC025	608	35	3.1845	0.6209
WAP011	406	38	3.9052	0.7441
WAP012	298	41	3.6940	0.6895
WAP013	384	30	3.6531	0.7445
WAP014	444	21	1.9339	0.4403
WAP015	206	23	3.0209	0.6678
WAP021	418	44	4.0160	0.7356
WAP022	376	38	4.4492	0.8478
WAP031	799	68	4.8289	0.7933
WAP032	599	59	4.5563	0.7745
WAP041	308	46	4.5524	0.8242
WAP042	512	50	4.4495	0.7884
WAP043	340	48	4.8873	0.8751
WAP044	206	22	3.4179	0.7664
WAP045	250	23	2.5683	0.5678
WAP051	564	61	4.5815	0.7725
WAP052	491	46	3.9382	0.7130
WAP053	360	44	4.3490	0.7966
WAP054	318	36	3.7802	0.7312
WAP055	504	31	3.5415	0.7149
WAP061	710	52	4.3200	0.7578
WAP062	620	37	3.8727	0.7434
WAP063	512	41	4.4023	0.8217
WAP064	382	32	4.0023	0.8005
WAP065	354	29	3.6365	0.7486
WAP071	285	39	4.0721	0.7704
WAP072	294	43	4.1291	0.7609
WAP081	480	48	4.3331	0.7758
WAP082	700	57	3.8964	0.6680
WAP091	499	54	4.3843	0.7618
WAP092	422	39	3.9776	0.7526
WAP093	588	43	4.3689	0.8051
WAP094	386	32	3.9434	0.7887
WAP095	564	46	4.2748	0.7739
WAP101	487	54	4.3889	0.7626

Table IV-4 (continued)

STATION	NUMBER OF		SHANNON FORMULA	
	INDIV	SPEC	H-PRIME	EVENNESS-JPR
WAP102	650	52	4.3878	0.7697
WAP111	366	50	4.0104	0.7106
WAP112	388	45	4.0416	0.7359
WAP113	320	31	3.8047	0.7680
WAP114	238	30	3.6987	0.7538
WAP115	390	31	3.7328	0.7535
WAP121	345	40	3.6167	0.6796
WAP122	414	38	3.7646	0.7173
WAP131	429	43	4.0148	0.7399
WAP132	267	33	3.7187	0.7372
WAP133	286	31	3.9718	0.8017
WAP134	238	27	3.5557	0.7478
WAP135	322	26	3.4682	0.7378
WAP141	638	58	4.2789	0.7304
WAP142	370	45	3.7189	0.6772
WAP151	635	58	4.4787	0.7645
WAP152	527	46	4.0116	0.7263
WAP153	680	50	4.5378	0.8040
WAP154	610	44	3.9712	0.7274
WAP155	536	31	3.3616	0.6785
WTC012	471	45	4.3677	0.7953
WTC013	382	36	4.3437	0.8402
WTC014	274	28	3.6144	0.7519
WTC015	390	31	3.6048	0.7276
WTC022	63	21	3.1405	0.7150
WTC023	890	54	4.7321	0.8223
WTC024	666	49	4.4824	0.7983
WTC025	412	31	3.7813	0.7633
WTP011	642	55	4.4285	0.7660
WTP012	440	44	3.8871	0.7120
WTP013	628	52	4.6265	0.8116
WTP014	286	31	3.8667	0.7805
WTP015	336	30	2.9109	0.5932
WTP021	564	52	4.4634	0.7830
WTP022	492	53	4.3453	0.7586
WTP023	420	31	3.5857	0.7238
WTP024	410	39	4.4445	0.8409
WTP025	480	33	3.3339	0.6609
WTP031	685	51	4.0155	0.7079
WTP032	673	57	4.2932	0.7360
WTP041	469	47	4.0720	0.7331
WTP042	267	32	3.3144	0.6629
WTP051	554	48	4.2646	0.7636
WTP052	587	51	4.3240	0.7623
WTP061	629	45	4.2202	0.7684

Table IV-4 (continued)

STATION	NUMBER OF		SHANNON FORMULA	
	INDIV	SPEC	H-PRIME	EVENNESS-JPR
WTP062	527	57	4.3477	0.7454
WTP071	529	42	3.8469	0.7134
WTP072	550	45	4.0707	0.7412
WTP081	709	42	3.9819	0.7384
WTP082	536	52	4.2847	0.7517
WTP083	390	39	4.1852	0.7918
WTP084	314	25	3.3856	0.7291
WTP085	490	31	3.6984	0.7465
WTP091	1035	56	4.1467	0.7140
WTP092	495	46	4.1491	0.7512
WTP093	368	32	3.9152	0.7830
WTP094	464	27	3.6604	0.7698
WTP095	428	30	3.3166	0.6759
WTP101	429	48	4.2727	0.7650
WTP102	345	47	4.3626	0.7854
WTP103	418	36	4.1701	0.8066
WTP104	262	22	3.4482	0.7732
WTP105	286	19	3.0936	0.7283
WTP111	979	57	4.4133	0.7566
WTP112	519	53	4.4360	0.7745
WTP121	1087	54	3.8959	0.6770
WTP122	617	52	4.2504	0.7456
WTP132	387	42	3.9868	0.7393
WTP133	864	44	4.3238	0.7920
WTP134	290	33	3.8893	0.7710
WTP135	428	27	3.5281	0.7420
WTP141	957	57	4.1982	0.7197
WTP142	516	52	4.1377	0.7259
WTP143	1014	49	4.3503	0.7748
WTP144	402	34	3.7462	0.7364
WTP145	594	33	3.5775	0.7092
WTP151	481	45	3.9153	0.7129
WTP152	458	46	4.1947	0.7594
WTP162	215	24	3.1355	0.6839
WTP171	803	57	4.3820	0.7513
WTP172	770	53	4.2319	0.7388
WTP173	568	42	4.0226	0.7460
WTP174	272	19	3.1468	0.7408
WTP175	392	27	3.6672	0.7713
WTP181	1356	49	3.9803	0.7089
WTP182	695	44	3.5983	0.6591
WTP183	748	38	3.2728	0.6236
WTP184	454	24	3.3087	0.7216
WTP185	540	35	3.5346	0.6891

Table IV-5. Ecological characteristics of dominant fauna collected from both the Wolf Trap and Rappahannock Study regions. Guild designations as in Fauchald and Jumars (1979). First letter - major feeding mode, second letter - motility mode.

Position 1: B - subsurface deposit feeder, C - carnivore, F - filter feeder, S - surface deposit feeder, O - omnivore

2: D - discretely motile, M - motile, S - sessile

Dominant Region	Species	Guild	Notes
W*	<u>Clymenella zonalis</u>	BS	a 'conveyor-belt' species, builds a sand grain tube, defecates fecal coils at the surface. Major deposit feeder that creates feeding voids in sediment column down to 15 cm
WR	<u>Paraprionospio pinnata</u>	SD,FD	lives in an unlined burrow, may feed in water column when current is present
WR	Nephtyiidae juv. (probably <u>N. picta</u>)	BM,CM	feeding mode uncertain, probably carnivorous, moves through sediment
W	<u>Notomastus latericeus</u>	BM	occupies a well-defined spiral burrow
W	<u>Bhawania goodei</u>	CM	ecology poorly known, has been observed <u>in situ</u> at the tops of <u>C. variopedatus</u> tubes, but not at densities great enough to account for observed abundances (personal observation)
W	<u>Listriella clymenellae</u>	OM	commensalistic with large tube-builders
WR	<u>Macoma tenta</u>	SD	burrowing, feeds at sediment-water interface via siphons
WR	<u>Ampelisca abdita</u>	FS,SS	tubicolous, surface-deposit feeder, whirls antennae to carry sediment to mouth parts for sorting

Table IV-5 (continued)

Dominant Region	Species	Guild	Notes
W	<u>Gyptis brevipalpa</u>	CM	ecology poorly known, however there is a high incidence of commensalism reported for the polychaete family Hesionidae of which this species is a member
WR	<u>Sigambra tentaculata</u>	CM	ecology poorly known, some members of this family Pilargidae are commensalistic
W	<u>Glycera americana</u>	CD	builds a well oxygenated-gallery of burrows
WR	<u>Macoma</u> spp. juv.		see <u>Macoma tenta</u>
W	<u>Chaetopterus variopedatus</u>	FS	builds a leathery U-shaped tube, filter feeds using a mucous net, tube is inhabited by many commensals
WR	<u>Nephtys picta</u>		see Nephtyiidae spp. juv.
W	<u>Loimia medusa</u>	SS	builds a mud-lined U-shaped tube, a tentaculate, surface deposit feeder
WR	<u>Acteocina canaliculata</u>	CM	a motile, surface living, carnivore
W	<u>Tubulanus pellucidus</u>	CM	a motile, sub-surface predator?
W	Cirratulidae (primarily <u>Tharyx</u> sp.)	SD,SS	spreads long tentacles out over sediment surface
WR	<u>Glycinde solitaria</u>	CD	presumably carnivorous, it is now known whether or not this species lives in burrows or moves freely through sediment

Table IV-5 (continued)

Dominant Region	Species	Guild	Notes
WR	<u>Mulinia lateralis</u>	FD,SD	small bivalve with short siphons that feeds at sediment-water interface. Can be a very opportunistic species setting in large number
WR	<u>Polydora ligni</u>	FD,SD	small tube builder, feeds with two tentacles, generally is opportunistic setting in large numbers
WR	<u>Pseudeurythoe paucibranchiata</u>	BM	ecology poorly known, deep free burrowing species
WR	Polycladia	CM	a group of many species, most are small soft bodied predators, burrow throughout sediment column
R	<u>Cistena gouldii</u>	BS	builds cone shaped tube one sand grain thick, a 'convey-belt' species
R	<u>Mediomastus ambiseta</u>	BD	small species that may live in well defined burrow system
R	<u>Sayella</u> spp.	CM	small predacious gastropod that inhabits surface sediments
R	<u>Lyonsia hyalina</u>	FD	small bivalve whose ecology is poorly known
R	<u>Phoronis</u> spp.	FS	builds a sand-grain tube, is a combination of two species <u>P. psammophila</u> and <u>P. mulleri</u> .

* Region W - Wolf Trap
R - Rappahannock

Table IV-6. Summary statistics and ANOVA results for boundary roughness, mean RPD depth, and benthic index values at the Wolf Trap Primary Site for all surveys.

PARAMETER	MONTH	N	MEAN	S.D.	BOUNDARY ROUGHNESS ANOVA				
					SOURCE	SS	DF	MS	F
BOUNDARY ROUGHNESS	FEB	120	.68	.47	BR	13.14	3	4.38	17.25
	MAY	117	.79	.36	ERROR	113.98	449	.25	
	AUG	102	1.14	.62	-----				
	OCT	114	.91	.54	BR	P <.001			
					SCHEFFE TEST ON ANOVA RESULTS:				
						MAY	AUG	OCT	
					FEB	NS	**	**	
					MAY		**	NS	
					AUG			**	

PARAMETER	MONTH	N	MEAN	S.D.	RPD ANOVA				
					SOURCE	SS	DF	MS	F
MEAN RPD DEPTH	FEB	114	5.63	1.78	RPD	4716.06	3	1572.02	191.86
	MAY	117	7.42	2.19	ERROR	3597.07	439	8.19	
	AUG	100	12.66	5.07	-----				
	OCT	112	3.94	1.14	RPD	P <.001			
					SCHEFFE TEST ON ANOVA RESULTS:				
						MAY	AUG	OCT	
					FEB	**	**	**	
					MAY		**	**	
					AUG			**	

PARAMETER	MONTH	N	MEAN	S.D.	BENTHIC INDEX ANOVA				
					SOURCE	SS	DF	MS	F
BENTHIC INDEX	FEB	114	10.44	1.79	BI	41.23	3	13.72	10.29
	MAY	116	10.83	.89	ERROR	574.26	430	1.34	
	AUG	92	10.98	.15	-----				
	OCT	112	10.20	1.03	BI	P < .001			
					SCHEFFE TEST ON ANOVA RESULTS:				
						MAY	AUG	OCT	
					FEB	NS	**	NS	
					MAY		NS	88	
					AUG			**	

Table IV-7. Summary statistics and ANOVA results for boundary roughness, mean RPD depth, and benthic index values at the Wolf Trap Alternate Site for all surveys.

PARAMETER	MONTH	N	MEAN	S.D.	BOUNDARY ROUGHNESS ANOVA				
					SOURCE	SS	DF	MS	F
BOUNDARY ROUGHNESS	FEB	102	.74	.48	BR	12.30	3	4.10	14.05
	MAY	102	.87	.48					
	AUG	68	1.12	.60	ERROR	98.00	336	.29	
	OCT	68	1.23	.64					
					BR	P <.001			
					SCHEFFE TEST ON ANOVA RESULTS:				
							MAY	AUG	OCT
						FEB	NS	**	**
						MAY		**	**
						AUG			NS

PARAMETER	MONTH	N	MEAN	S.D.	RPD ANOVA				
					SOURCE	SS	DF	MS	F
MEAN RPD DEPTH	FEB	101	5.89	1.96	RPD	4368.77	3	1456.26	154.07
	MAY	102	6.90	2.15					
	AUG	68	13.73	5.63	ERROR	3166.49	335	9.45	
	OCT	68	4.04	1.69					
					RPD	P < .001			
					SCHEFFE TEST ON ANOVA RESULTS:				
							MAY	AUG	OCT
						FEB	NS	**	**
						MAY		**	**
						AUG			**

PARAMETER	MONTH	N	MEAN	S.D.	BENTHIC INDEX ANOVA				
					SOURCE	SS	DF	MS	F
BENTHIC INDEX	FEB	101	9.93	2.12	BI	67.00	3	22.34	7.65
	MAY	102	10.50	1.49					
	AUG	68	10.74	1.05	ERROR	977.72	335	2.92	
	OCT	68	9.59	1.85					
					BI	P <.001			
					SCHEFFE TEST ON ANOVA RESULTS:				
							MAY	AUG	OCT
						FEB	NS	**	NS
						MAY		NS	**
						AUG			**

Table IV-8. Weight percent of gravel, sand, silt and clay; by station

WOLF TRAP

	(1) Fall 1983	(2) Winter 1984	(3) Spring 1984	(4) Summer 1984	(5) Fall 1984
WTC 01 (0/5)					
Gravel (G) %	--	0.0	0.0	0.0	0.0
Sand (S) %	--	50.1	50.5	39.3	36.4
Silt (S1) %	--	31.4	31.0	25.0	41.2
Clay (C) %	--	18.5	18.5	35.7	22.4
WTC 01 (5/15)					
G	--	0.0	0.0	0.0	0.0
S	--	57.0	47.4	45.7	40.7
S1	--	27.2	34.3	36.3	39.5
C	--	15.8	18.4	18.0	19.8
WTC 02 (0/5)					
			*		
G	--	0.0	0.1	0.1	0.3
S	--	14.7	74.1	76.1	74.9
S1	--	55.9	14.2	13.0	14.2
C	--	29.3	11.6	10.8	10.6
WTC 02 (5/15)					
G	--	0.2	0.6	0.2	1.3
S	--	14.5	72.7	74.1	74.6
S1	--	55.5	14.7	12.2	12.7
C	--	29.9	12.0	13.4	11.4
WTP 01 (0/5)					
G	0.0	0.0	0.0	0.1	0.1
S	38.2	42.7	42.4	47.7	40.6
S1	30.0	38.3	37.5	34.3	39.7
C	31.8	19.0	20.1	17.8	19.5

* Station position changed after Cruise 2 to position more representative of Wolf Trap Primary Area.

	(1) Fall 1983	(2) Winter 1984	(3) Spring 1984	(4) Summer 1984	(5) Fall 1984
WTP 01 (5/15)					
G	0.3	0.0	0.3	0.1	0.0
S	48.7	51.1	49.6	47.1	50.2
S1	24.9	31.6	32.2	34.9	32.7
C	26.1	17.2	17.9	18.0	17.2

WTP 02 (0/5)					
Gravel (G) %	0.0	0.0	0.0	0.0	0.1
Sand (S) %	39.2	49.6	52.4	41.6	51.3
Silt (S1) %	32.5	33.7	33.8	43.6	34.4
Clay (C) %	28.4	16.6	13.7	14.7	14.2

WTP 02 (5/15)					
G	0.0	0.0	8.1	0.0	0.0
S	38.9	55.4	54.6	46.8	47.9
S1	32.6	29.6	31.1	38.5	33.8
C	28.4	15.0	14.1	14.7	18.3

WTP 03 (0/5)					
G	0.0	0.0			
S	44.9	56.2			
S1	29.5	28.8			
C	25.7	15.0			

WTP 03 (5/15)					
G	0.0	0.0			
S	48.2	59.6			
S1	37.9	26.2			
C	23.8	14.2			

WTP 04 (0/5)					
G	0.2	0.0			
S	29.1	33.5			
S1	38.4	44.4			
C	32.3	22.2			

	(1) Fall 1983	(2) Winter 1984	(3) Spring 1984	(4) Summer 1984	(5) Fall 1984
WTP 04 (5/15)					
G	0.0	0.0			
S	24.1	31.4			
S1	40.8	47.9			
C	34.5	20.7			

WTP 05 (0/5)					
Gravel (G) %	0.0	0.1			
Sand (S) %	44.2	57.0			
Silt (S1) %	28.6	28.1			
Clay (C) %	27.2	14.8			

WTP 05 (5/15)					
G	0.1	0.4			
S	52.3	64.4			
S1	22.7	21.5			
C	24.5	13.8			

WTP 06 (0/5)					
G	0.0	0.0			
S	55.7	61.7			
S1	32.0	27.0			
C	12.3	11.3			

WTP 06 (5/15)					
G	0.0	0.0			
S	56.8	61.4			
S1	29.9	25.6			
C	13.3	13.0			

WTP 07 (0/5)					
G	0.0	0.0			
S	53.7	51.8			
S1	31.2	32.6			
C	15.1	15.7			

	(1) Fall 1983	(2) Winter 1984	(3) Spring 1984	(4) Summer 1984	(5) Fall 1984
WTP 07 (5/15)					
G	0.1	0.6			
S	54.5	60.1			
S1	29.7	25.3			
C	15.7	13.9			

WTP 08 (0/5)					
Gravel (G) %	0.0	0.0	0.0	0.0	0.0
Sand (S) %	54.6	57.8	59.1	60.2	55.7
Silt (S1) %	33.0	28.2	28.2	27.4	30.3
Clay (C) %	12.4	14.0	12.7	12.4	14.0

WTP 08 (5/15)					
G	0.2	0.0	0.2	0.0	0.0
S	64.7	63.5	64.7	65.6	60.7
S1	25.0	24.3	23.3	22.2	24.7
C	10.1	12.2	11.8	12.2	14.6

WTP 09 (0/5)					
G	0.0	0.0	0.0	0.0	0.0
S	58.2	65.6	64.8	64.5	66.9
S1	29.0	21.6	22.0	26.0	21.3
C	12.8	12.8	13.2	9.5	11.8

WTP 09 (5/15)					
G	0.0	0.0	0.0	0.0	0.0
S	64.1	69.1	68.5	61.2	59.7
S1	24.5	19.5	19.9	26.5	25.6
C	11.4	11.4	11.5	12.3	14.7

WTP 10 (0/5)					
G	0.1	0.2	0.0	0.0	"SIS" AVERAGE 0.0
S	40.6	47.0	38.7	38.7	34.8
S1	41.7	34.8	40.2	39.4	44.4
C	17.5	18.0	21.1	21.9	20.8

	(1) Fall 1983	(2) Winter 1984	(3) Spring 1984	(4) Summer 1984	(5) Fall 1984
WTP 10 (5/15)					
G	0.0	0.1	0.0	0.0	
S	33.6	42.8	35.7	39.5	
S1	45.0	37.2	41.8	39.1	
C	21.4	19.9	22.5	21.4	

WTP 11 (0/5)

Gravel (G) %	0.0	0.0
Sand (S) %	54.8	60.5
Silt (S1) %	29.6	25.4
Clay (C) %	15.5	14.1

WTP 11 (5/15)

G	0.1	0.1
S	63.9	67.2
S1	24.2	20.8
C	11.8	11.9

WTP 12 (0/5)

G	0.0	0.0
S	55.8	64.7
S1	28.3	22.3
C	15.9	13.0

WTP 12 (5/15)

G	0.0	0.0
S	64.2	67.3
S1	24.0	21.1
C	11.8	11.6

WTP 13 (0/5)

G	--	0.0	0.0	0.0	0.0
S	--	49.6	48.1	44.1	50.4
S1	--	33.8	34.8	40.7	33.8
C	--	16.6	17.1	15.2	15.8

	(1) Fall 1983	(2) Winter 1984	(3) Spring 1984	(4) Summer 1984	(5) Fall 1984
WTP 13 (5/15)					
G	--	0.0	0.0	0.0	0.0
S	--	51.6	45.9	43.3	45.3
S1	--	32.6	35.2	40.5	37.1
C	--	15.8	18.8	16.2	17.5

					"TIP" AVERAGE
WTP 14 (0/5)					
Gravel (G) %	0.0	0.0	0.0	0.0	0.0
Sand (S) %	59.6	61.8	54.0	53.3	57.3
Silt (S1) %	28.2	24.1	28.8	31.7	28.2
Clay (C) %	12.2	14.1	17.2	15.0	14/5

WTP 14 (5/15)					
G	0.0	0.0	0.0	0.0	
S	65.8	66.1	65.1	55.6	
S1	23.3	21.8	23.4	29.1	
C	10.9	12.2	11.5	15.3	

WTP 15 (0/5)					
G	0.0	0.0			
S	63.7	64.7			
S1	23.5	21.1			
C	12.8	14.2			

WTP 15 (5/15)					
G	0.0	0.0			
S	68.2	69.9			
S1	21.4	18.9			
C	10.4	11.2			

WTP 16 (0/5)					
G	0.1	0.0			
S	97.1	96.4			
S1	1.4	1.8			
C	1.4	1.7			

	(1) Fall 1983	(2) Winter 1984	(3) Spring 1984	(4) Summer 1984	(5) Fall 1984
WTP 16 (5/15)					
G	--	0.0			
S	--	97.4			
S1	--	1.3			
C	--	1.4			
WTP 17 (0/5)					
Gravel (G) %	0.0	0.0	0.0	0.0	0.0
Sand (S) %	52.6	52.4	57.4	49.6	51.8
Silt (S1) %	31.5	31.3	27.3	33.7	31.8
Clay (C) %	15.9	16.3	15.3	16.6	16.4
WTP 17 (5/15)					
G	0.0	0.0	0.0	0.0	0.0
S	60.0	60.3	60.3	52.2	61.8
S1	27.1	27.1	25.9	32.2	25.1
C	12.9	12.7	13.8	15.6	13.2
WTP 18 (0/5)					
G	0.0	0.0	0.0	0.0	0.0
S	50.9	61.3	60.9	52.8	45.6
S1	33.4	25.3	25.3	33.1	35.6
C	15.7	13.5	13.7	14.1	18.8
WTP 18 (5/15)					
G	0.05	0.0	0.0	0.0	0.0
S	56.10	64.8	60.7	52.0	52.9
S1	32.200	22.7	25.1	31.8	32.4
C	11.600	12.5	14.2	16.3	14.7

WOLF TRAP (ALTERNATE)

	(1) Fall 1983	(2) Winter 1984	(3) Spring 1984	(4) Summer 1984	(5) Fall 1984
WAC 01 (0/5)					
G	--	0.05	0.0	0.0	0.1
S	--	71.5	57.2	60.8	66.7
S1	--	19.0	30.7	30.4	22.8
C	--	9.5	12.1	8.9	10.4
WAC 01 (5/15)					
G	--	0.3	0.7	0.4	0.2
S	--	79.0	65.5	67.2	71.4
S1	--	13.3	22.6	24.5	18.0
C	--	7.4	11.2	7.9	10.4
WAC 02 (0/5)					
G	--	0.0	0.0	0.0	0.0
S	--	53.5	47.3	46.9	49.0
S1	--	29.9	36.7	41.0	36.4
C	--	16.6	16.0	12.1	14.6
WAC 02 (5/15)					
G	--	0.0	0.0	0.0	0.0
S	--	61.7	47.5	43.6	50.2
S1	--	25.6	37.6	42.1	34.2
C	--	12.7	14.9	14.2	15.6
WAP 01 (0/5)					
G	0.3	0.3	0.9	0.7	1.8
S	19.8	19.9	19.8	23.0	21.4
S1	57.2	59.8	54.9	52.5	50.7
C	22.7	20.0	24.3	23.8	26.1
WAP 01 (5/15)					
G	1.2	1.8	1.1	3.5	1.5
S	21.1	24.4	22.2	24.2	27.0
S1	55.2	51.4	53.1	47.6	47.0
C	22.5	22.4	23.6	24.6	24.4

	(1) Fall 1983	(2) Winter 1984	(3) Spring 1984	(4) Summer 1984	(5) Fall 1984
WAP 02 (0/5)					
G	1.1	1.0			
S	33.2	37.6			
S1	46.6	42.9			
C	19.0	18.5			
WAP 02 (5/15)					
G	0.0	0.0			
S	31.7	39.9			
S1	46.8	41.4			
C	21.4	18.7			
WAP 03 (0/5)					
G	0.0	0.0			
S	65.7	58.0			
S1	24.2	29.2			
C	10.2	12.9			
WAP 03 (5/15)					
G	0.5	0.1			
S	64.6	61.8			
S1	22.1	24.9			
C	12.7	13.2			
WAP 04 (0/5)					
G	0.0	0.0	0.0	0.0	0.0
S	25.2	21.0	20.7	19.1	25.0
S1	50.9	53.4	54.3	58.1	51.8
C	23.9	25.5	25.0	22.7	23.3
WAP 04 (5/15)					
G	0.0	0.0	0.2	0.1	0.0
S	25.7	20.8	20.8	18.9	22.7
S1	50.1	54.5	53.6	50.4	49.6
C	24.2	24.7	25.4	24.6	27.7

	(1) Fall 1983	(2) Winter 1984	(3) Spring 1984	(4) Summer 1984	(5) Fall 1984
WAP 05 (0/5)					
G	0.1	0.0	0.0	0.0	0.0
S	62.1	45.6	55.5	58.3	54.9
S1	27.0	38.5	30.6	28.5	32.5
C	10.8	15.9	13.9	13.2	12.6

WAP 05 (5/15)					
G	0.0	0.5	1.1	0.0	0.0
S	59.3	57.8	57.8	63.1	57.6
S1	29.2	30.7	28.5	24.8	28.5
C	11.4	11.0	12.6	12.1	13.8

WAP 06 (0/5)					
G	0.0	0.0	0.0	0.0	0.0
S	58.1	53.3	55.5	55.0	53.1
S1	29.0	31.1	29.0	32.6	29.6
C	12.9	15.6	15.5	12.3	17.3

WAP 06 (5/15)					
G	0.0	0.0	0.0	0.0	0.0
S	61.8	61.8	62.0	58.5	61.6
S1	27.1	26.4	25.7	29.3	25.2
C	11.1	11.7	12.3	12.1	13.2

WAP 07 (0/5)					
G	0.6	0.0			
S	16.8	19.0			
S1	54.4	54.3			
C	28.2	26.7			

WAP 07 (5/15)					
G	0.5	0.0			
S	19.5	18.0			
S1	51.7	56.3			
C	28.3	25.7			

	(1) Fall 1983	(2) Winter 1984	(3) Spring 1984	(4) Summer 1984	(5) Fall 1984
WAP 08 (0/5)					
G	0.0	0.0			
S	47.2	38.4			
S1	38.0	42.2			
C	14.8	19.4			

WAP 08 (5/15)

G	0.0	0.0			
S	49.3	49.3			
S1	37.2	36.5			
C	13.5	14.3			

WAP 09 (0/5)

G	0.0	0.0	0.0	0.0	0.0
S	53.6	48.2	41.1	44.0	48.4
S1	32.6	35.9	42.1	42.2	34.7
C	13.7	15.9	16.8	13.7	16.9

WAP 09 (5/15)

G	0.0	0.3	0.0	0.0	0.0
S	55.4	52.2	49.8	45.6	54.1
S1	30.7	34.7	35.8	40.1	31.7
C	13.9	12.8	14.4	14.3	14.2

WAP 10 (0/5)

G	0.0	0.0	0.1		
S	52.2	50.9	74.1		
S1	32.7	33.4	14.2		
C	15.1	15.8	11.6		

WAP 10 (5/15)

G	0.0	0.3	0.6		
S	66.3	62.0	72.7		
S1	22.0	24.8	14.7		
C	11.7	12.8	12.0		

	(1) Fall 1983	(2) Winter 1984	(3) Spring 1984	(4) Summer 1984	(5) Fall 1984
WAP 11 (0/5)					
G	0.0	0.0	0.0	0.0	0.0
S	51.3	53.0	48.2	48.2	51.8
S1	34.2	18.2	36.5	39.6	33.6
C	14.5	28.8	15.3	12.2	14.6

WAP 11 (5/15)					
G	0.3	0.6	2.5	0.0	0.0
S	55.8	51.9	49.9	48.5	49.6
S1	30.6	33.6	33.9	38.5	35.1
C	13.3	13.8	13.8	13.0	15.3

WAP 12 (0/5)					
G	0.0	0.05			
S	63.8	61.6			
S1	26.5	26.9			
C	9.7	11.4			

WAP 12 (5/15)					
G	0.01	0.0			
S	60.1	65.8			
S1	28.3	23.8			
C	11.6	10.4			

WAP 13 (0/5)					
G	0.1	0.0	0.2	0.7	0.0
S	49.1	45.9	53.5	42.1	43.3
S1	33.1	35.4	28.6	36.6	36.7
C	17.8	18.7	17.7	20.6	20.0

WAP 13 (5/15)					
G	1.0	1.9	1.3	0.6	0.5
S	59.6	56.5	61.2	56.8	54.8
S1	24.4	25.7	22.7	25.5	25.0
C	15.0	15.8	14.7	17.2	19.7

	(1) Fall 1983	(2) Winter 1984	(3) Spring 1984	(4) Summer 1984	(5) Fall 1984
WAP 14 (0/5)					
G	0.0	0.0			
S	58.4	52.4			
S1	25.5	33.2			
C	16.2	14.4			

WAP 14 (5/15)

G	0.3	0.0			
S	60.1	59.8			
S1	25.8	28.3			
C	13.8	11.9			

WAP 15 (0/5)

G	0.04	0.1	0.0	0.0	0.1
S	67.5	57.0	57.8	54.3	57.6
S1	21.6	29.2	30.4	33.0	28.7
C	10.9	13.8	11.8	12.7	13.7

WAP 15 (5/15)

G	0.0	0.1	0.2	0.1	0.0
S	66.3	63.5	59.8	55.2	55.4
S1	22.7	26.3	27.6	31.3	31.6
C	11.0	10.2	12.3	13.4	13.0

Table IV-9. Total organic carbon, Wolf Trap Disposal Areas;
 Cruise 1 = Fall, 1983; Cruise 2 = Winter, 1984;
 Cruise 3 = Spring, 1984; Cruise 4 = Fall, 1984
 (Stations without analyses coded 99999)

ID:	DEPTH: (CM)	CRUISE NUMBER:				
		1	2	3	4	5
WTP01	0-5	0.632	99999	0.618	0.997	0.593
WTP01	5-15	0.607	99999	0.615	0.763	0.563
WTP02	0-5	0.673	99999	0.652	0.633	0.584
WTP02	5-15	0.643	99999	0.634	0.720	0.641
WTP03	0-5	0.585	99999	99999	99999	99999
WTP03	5-15	0.710	99999	99999	99999	99999
WTP04	0-5	0.802	99999	99999	99999	99999
WTP04	5-15	0.745	99999	99999	99999	99999
WTP05	0-5	0.576	99999	99999	99999	99999
WTP05	5-15	0.540	99999	99999	99999	99999
WTP06	0-5	0.494	99999	99999	99999	99999
WTP06	5-15	0.463	99999	99999	99999	99999
WTP07	0-5	0.573	99999	99999	99999	99999
WTP07	5-15	0.534	99999	99999	99999	99999
WTP08	0-5	0.428	99999	0.508	0.453	0.471
WTP08	5-15	0.378	99999	0.659	0.371	0.500
WTP09	0-5	0.591	99999	0.678	0.325	0.376
WTP09	5-15	0.452	99999	0.719	0.451	0.373
WTP10	0-5	0.754	0.686	1.094	0.729	99999
WTP10	5-15	0.847	0.630	0.942	0.712	99999
WTP13	0-5	0.634	99999	0.822	0.512	0.676
WTP13	5-15	0.385	0.533	0.931	0.583	0.679
WTP14	0-5	0.500	0.538	0.495	0.499	99999
WTP14	5-15	0.370	0.377	0.431	0.562	99999
WTP15	0-5	0.506	0.442	99999	99999	99999
WTP15	5-15	0.416	0.421	99999	99999	99999
WTP16	0-5	99999	99999	99999	99999	99999
WTP16	5-15	99999	99999	0.019	99999	99999
WTP17	0-5	99999	99999	0.440	0.586	0.655
WTP17	5-15	99999	99999	0.500	0.537	0.475
WTP18	0-5	0.549	99999	0.477	0.669	0.547
WTP18	5-15	0.442	99999	0.576	0.536	0.434
WAP01	0-5	0.887	99999	1.085	0.946	1.072
WAP01	5-15	0.941	99999	1.042	0.921	0.840
WAP02	0-5	0.670	99999	99999	99999	99999

WAP02	5-15	0.734	99999	99999	99999	99999
WAP03	0-5	0.333	99999	99999	99999	99999
WAP03	5-15	0.378	99999	99999	99999	99999
WAP04	0-5	0.884	99999	0.857	0.897	0.710
WAP04	5-15	0.819	99999	0.865	0.734	0.547
WAP05	0-5	0.292	99999	0.550	0.414	0.053
WAP05	5-15	0.480	99999	0.623	0.289	0.314
WAP06	0-5	0.505	99999	0.362	0.719	0.649
WAP06	5-15	0.354	99999	0.521	0.309	0.392
WAP07	0-5	0.913	99999	99999	99999	99999
WAP07	5-15	1.005	99999	99999	99999	99999
WAP08	0-5	0.456	99999	99999	99999	99999
WAP08	5-15	0.440	99999	99999	99999	99999
WAP09	0-5	0.542	99999	0.292	0.531	0.453
WAP09	5-15	0.445	99999	0.295	0.335	0.493
WAP10	0-5	0.646	99999	99999	99999	99999
WAP10	5-15	0.437	99999	99999	99999	99999
WAP11	0-5	0.454	99999	0.650	0.323	0.421
WAP11	5-15	0.480	99999	0.340	0.391	0.509
WAP12	0-5	0.344	99999	99999	99999	99999
WAP12	5-15	0.365	99999	99999	99999	99999
WAP13	0-5	0.634	99999	0.617	99999	0.466
WAP13	5-15	0.510	99999	0.685	99999	0.506
WAP14	0-5	0.469	99999	99999	99999	99999
WAP14	5-15	0.453	99999	99999	99999	99999
WAP15	0-5	0.352	99999	0.444	0.518	0.316
WAP15	5-15	0.887	99999	0.440	0.453	0.435
WAC01	0-5	99999	99999	0.427	0.381	0.286
WAC01	5-15	99999	99999	0.372	0.422	0.302
WAC02	0-5	99999	99999	0.411	0.594	0.335
WAC02	5-15	99999	99999	0.738	0.585	0.436
WTC01	0-5	99999	99999	0.587	0.736	0.559
WTC01	5-15	99999	99999	0.696	0.665	0.511
WTC02	0-5	99999	99999	0.335	0.739	0.082
WTC02	5-15	99999	99999	0.208	0.824	0.273

PART V: RAPPAHANNOCK STUDY RESULTS AND DISCUSSION

Faunal Composition

A total of 162 taxa were collected from the Rappahannock Study Region. Of these 118 were identified to species level. The 44 taxa not identified to species represented, for the most part, juveniles or complex taxonomic groups such as oligochaetes and phoronids.

Polychaete annelids numerically dominated the collections at all stations, comprising about 61% of all individuals. At least 61 taxa comprising 25 families of polychaetes were collected from all four cruises (Table IV-1). The second most abundant group was the molluscs representing about 27% of all the individuals with 39 taxa. There were 20 gastropods and 19 bivalve taxa collected from all four cruises. Crustaceans were third most abundant group with about 6% of all the individuals and 27 taxa. Most of the crustaceans were amphipods, with 19 taxa, and decapods, with 9 taxa. The fourth most abundant major taxa was the Phoronida representing 5% of all the individuals and 1 taxa.

The remaining seven major taxonomic groups (phyla) were only 1% of all the individuals and 34 taxa. They were, in order of decreasing abundance; Cnidaria, Nemertea, Turbellaria, Echinodermata, Ectoprocta, Urochordata, and Hemichordata.

The faunal composition between the Rappahannock Shoals and Alternate sites was not identical. Of the 162 taxa that occurred at both sites there were 53 taxa that occurred at the RSP site that did not occur at the RAP site (Table IV-1). Conversely only 7 taxa did not occur at the RSP site. Not only did the RSP site have the high number of taxa it also had higher abundances for all of the major taxonomic groups. There were about a third

more annelids, twice as many molluscs and crustaceans, and three times as many phoronids at the RSP site.

Of the twenty most widely distributed taxa in the Rappahannock Region 13 were polychaetes, 2 each were bivalves and gastropods, and 1 each was a phoronid, amphipod, and polyclad. The frequency of occurrence of these and the other taxa is contained in Table IV-1.

Abundance

A total of 31,917 individuals were collected from the Rappahannock Study Region. The range in total taxa abundance was from 2 to 2,184 individuals/0.12 m². On average there were 310 individuals/0.12 m². The RSP site had higher abundances, 425/0.12 m² on average, than the RAP site, which had 215/0.12 m². There was also a west to east increase in individuals at both sites. Overall lowest abundances occurred in the summer (Table V-1).

There were 44 taxa that occurred at 15% of the station x cruise combinations. The average abundance of these taxa grouping the stations by disposal area, fringe area, and control stations is presented in Table V-2. About a fifth of the taxa had over twice their abundances in the disposal or fringe areas of RSP. At the RAP site about a tenth of the taxa were over twice as abundant in the disposal or fringe areas. The control stations for RAP were overall similar to the disposal and fringe areas, with only three taxa being over twice as low and four being twice as high in the controls.

If the entire data set (RSP and RAP) is averaged by season it can be seen that several taxa have strong recruitment in the spring followed by

declines in the summer and fall (Table V-1). Overall there was a tendency for there to be fewer individuals in the summer and fall.

Diversity

The number of species at each station in the Rappahannock Study Region ranged from 2 to 58 per 0.12 m^2 during the four cruises. On average there were 23.1 species collected at each station each cruise. If all the species collected during the four cruises are summed by station the range was 19 to 84 species occurring at a station. Through time there was an overall decline in the number of species collected. Biggest differences in total species occurred between the Rappahannock Shoals area and the Rappahannock Alternate area. The RSP site had an average of 27.8 species per station while the RAP had 19.8. There were also differences between the fringe and disposal areas in the RSP site. On average the fringe had higher numbers of species. There was less of a difference at the RAP site (Table V-3).

Diversity, as measured by H' , ranged from 1.00 to 4.88 during the four cruises. On average H' was 2.89 for the entire Rappahannock Study Region. Diversity was slightly higher at the RSP site, averaging 3.03, than the RAP site which averaged 2.82. Through time diversity tended to decline throughout the region. There was also a trend for H' to be lower on the western side of the region relative to the eastern side. If only sandy stations are considered then there was a general trend for H' to increase going from south to north. The opposite trend was seen at the muddy stations, where diversity tended to increase from north to south (Table V-3).

Evenness ranged from 0.31 to 1.00 and was 0.69 on average throughout the Rappahannock Study Region. Evenness was reasonably variable within the RSP and RAP sites, but on average was the same between the two sites at

0.69. Evenness tended to increase through time from winter to summer, but declined in the fall of 1985 (Table V-3).

Community Patterns

Patterns in station resemblance on species distribution were identified using numerical classification. The Bray-Curtis similarity measure and flexible sorting on square-root transformed data was used to classify the data set. When each station and each cruise were kept separate the data set was broken into three major groups of stations (Figure V-1). The first major group was composed mainly of RAP stations with a few RSP stations from the western side of the site. The second major group was mainly RSP stations with a few RAP stations from the southern end of the site. The third major group was a mixture of RAP and RSP stations from the Summer and Fall 1985 cruises.

To see the overall patterns in station resemblance all data from each of the cruises were combined for each station and a classification analysis done. The stations were classified into five groups as indicated in Figure V-2. The separation of stations was primarily due to sediment type. Group A basically consisted of RSP muddy stations along the western side of the site plus three of the western muddy stations from RAP. Group B was only the muddy stations from RAP. Group C stations were basically the sandier stations from the eastern side of RAP and a few RSP stations. Group D was the sandy stations from RSP. Group E was only one station, RAP16, which was a shallow medium sand shoal in the southwest corner of the RAP site.

Inverse classification of the top 44 species (dropping species that did not occur in 15 of the 103 station x cruise combinations) from all four cruises in the Rappahannock Study Region produced four major groupings of

species (Figure V-3). Group 1 species were the dominants in the sandy areas of both RSP and RAP. Group 2 species were the dominants in the muddy areas of both sites. These dominants, in both Group 1 and 2, were widely distributed over the entire Rappahannock region. Group 3 was the lesser abundant muddy species and Group 4 the lesser abundant sandy species from both sites.

Species Patterns

Of the total 162 taxa collected from the Rappahannock Shoals Study Region 17 accounted for almost 90% of all individuals. The patterns in distribution of these taxa are presented in figures V-4 to V-22. Of these taxa nine were polychaetes, four were bivalves, two were gastropods, and one each was an amphipod and phoronid. Ecological information on these species is summarized in Table IV-5.

Seven of these dominants were discretely motile burrowers. There were also six taxa that were motile burrowers. Tube builders were in the minority with there being only four species. The high proportion of burrowing species, in these dominants, is due to the muddy nature of much of the Rappahannock Shoals region.

Two temporal patterns were common among these 17 taxa. One was for a decline in abundance from winter to summer. This decline was almost complete for three taxa. They were Acteocina canaliculata, Ampelisca abdita, and Cistena gouldii. By fall 1985 there was some evidence of recruitment for A. canaliculata and C. gouldii (Figures V-4 to V-6). Two other taxa also declined but their decline was from winter to fall. They were total Nephtyids (Nephtys picta plus Nephtyidae) and total Macoma spp. (Macoma tenta plus Pelecypoda, which were all likely juvenile Macoma)

(Figures V-7 to V-12). The second temporal pattern was for a spring recruitment. Five species exhibited a large recruitment peak in at least one of the sites. They were Mediomastus ambiseta, Polydora ligni, Sayella spp., Mulinia lateralis, and Lyonsia hyalina (Figures V-13 to V-17).

Three species, Glycinde solitaria, Sigambra tentaculata, and Paraprionospio pinnata, declined in the spring or summer but recruited again in the fall (Figures V-18 to V-20). There were two other taxa that overall tended to increase in abundance from winter to fall 1985. They were Pseudeurythoe paucibranchiata and Phoronis spp. (Figure V-21 and V-22). Their increase was only at the Rappahannock Shoals site, except for Phoronis spp. in the spring which increased at RAP and declined at RSP.

Spatially only three of these 17 species had about the same abundance in both the RAP and RSP sites. They were Acteocina canaliculata, Cistena gouldii and Paraprionospio pinnata (Figures V-4, V-6 and V-20). Glycinde solitaria was the only species to consistently have higher abundance at the RAP site (Figure V-18). Sigambra tentaculata in the winter and fall had higher abundances in the RAP site (Figure V-19). All the other 12 taxa were higher in abundance at the RSP site. Among these 17 taxa there was no overall spatial or temporal pattern that indicated the disposal or fringe areas were consistently higher or lower in abundance.

REMOTS

For the Rappahannock Shoals Primary site the frequency distributions of boundary roughness values for each survey are given in Figure V-23, and statistics are summarized in Table V-4. Significantly greater relief was observed at the Rappahannock Shoals site in August and October, relative to February and May; this appeared to be due to increased biogenic activity,

i.e. fecal mounds and macrofaunal burrow excavations. In all surveys, small-scale topographic relief was generally low (major mode equaled 0.4 cm throughout).

Throughout the study, the eastern flank of the Rappahannock Shoals Site showed widespread evidence of eroded or unstable surface sediments. Features such as mudclasts, sand over mud, bedforms, and hydroids were detected at 61% of the Rappahannock stations in February, 67% in May, 57% in August, and 80% in October. The great majority of these stations were located on the eastern half of the site. Conversely, the western, and especially northwestern, portion of the grid appears to be an area of deposition. Sapropel (organic rich) layers are evident at 11 stations in May, 9 in August, and 13 in October. Nearly all these stations are in the northwestern portion of the site. In August, 4 stations in this northwest quadrant were inferred to be hypoxic, as some REMOTS images lacked an apparent RPD. Methane was also observed at 4 northwest quadrant stations. By October, all stations were aerobic; however, methane was still evident at 7 stations. The persistence of methanogenesis in this area infers a high organic content in the deposited sapropel.

Frequency distributions of the mean apparent RPD depth for each survey is shown in Figure V-24, and the associated statistics are given in Table V-4. The seasonal pattern of change in RPD depths at the Rappahannock Site was markedly different than the pattern at the Wolf Trap sites. RPD depths shallowed significantly between February and May (major mode decreases from 3 cm to 1 cm). In August, the distribution was bimodal at 0 and 3 cm, reflecting the contrast between the severely stressed northwestern portion of the grid and the rest of the area. By October, the major mode returns to

the February level of 3 cm. Overall, the RPD depths at the Rappahannock Shoals Site were relatively shallow throughout the study.

Contour maps of mean RPD depths are shown in Figure V-25. The shallow RPD's in the northwest quadrant are evident. Frequency distributions of the percentage areal coverage of each contour interval are given in Figure V-26. The distributions generally widen with time reflecting the heterogeneity of the site in the summer and fall.

In February, the Rappahannock Shoals Site was dominated by Stage I assemblages, with only 6 stations showing evidence of Stage III fauna. By May, however, head-down deposit feeders were apparent at all but 5 stations (3 of these stations were in the northwest corner of the site). In August, Stage III fauna remain well established throughout most of the site, except for the northwest quadrant. In this region, 4 stations exhibited azoic replicate images and the remainder showed only Stage I fauna. This retrograde succession may have been due to the deposition of sapropellic sediments in this area, and the subsequent hypoxia. In October, no zoic images were obtained. Overall, the site consists of Stage I seres across the northern half with Stage III seres to the south.

Benthic index frequency distributions are shown in Figure V-27, and associated statistics are given in Table V-4. The relatively wide and multimodal index distributions (after February) reflect the heterogeneity of RPD depths and successional stages at this site. The extremely low values (less than 0) in May and August represent the severely stressed condition in the northwest area of the site. A persistent region of high index values existed in the central and western portion of the site.

For the Rappahannock Alternate Site, boundary roughness frequency distributions for each season at the Rappahannock Alternate Site are shown

in Figure V-28, and summary statistics are given in Table V-5. Similar to the other three sites, small-scale topographic relief at Rappahannock Alternate is relatively slight in February and May (major mode of 0.4 cm). In August, and persisting into October, surface relief increases dramatically (major mode of 2.0 cm), due to both enhanced biogenic relief and possibly to the appearance of bedforms.

Evidence of eroded or unstable bottom is present at 47% of the Rappahannock Alternate stations in February, at 48% in May, 50% in August, and 77% in October. This pattern is comparable to that observed at the Rappahannock Shoals Site. Also, except in October, when unstable bottom was evident throughout the site, the areas of extensive erosion were restricted to the eastern flank and the relatively shallow southwest corner. Sapropel was apparent at 12 Rappahannock Alternate stations in May and in 6 stations in October.

Frequency distributions of the mean apparent RPD depths at Rappahannock Alternate for each survey are shown in Figure V-29, and associated statistics are given in Table V-5. RPD depths did not change significantly from February to May (major mode equaled 3 cm). In August, and persisting into October, RPD depths increase. This pattern of change in RPD values differs somewhat from that observed at the Wolf Trap sites, in that the progressive summer deepening in RPD's was not followed by an fall rebound. RPD's at the Rappahannock Alternate Site, while deeper than those at the Rappahannock Shoals site, were generally much shallower than those at the Wolf Trap sites. Contour maps of RPD depths from each survey are given in Figure V-30. The gradual increase in RPD depth from February through October is apparent in these maps. The southwest corner of Rappahannock Alternate Site (a shallower, and probably more physically disturbed region)

exhibits shallower apparent RPD depths than the rest of the site. The frequency distributions of the percentage areal coverage of each contour interval illustrate the pattern discussed above (Figure V-31).

A general increase in the abundance of Stage III communities from north to south was observed in February at the Rappahannock Alternate Site. In subsequent surveys, the site exhibited a mosaic of Stage I and Stage III assemblages. This apparent patchiness of assemblages may be attributed to a low density of maldanids, and therefore of the subsurface feeding voids which they produce. Such voids are a major criterion in identifying a Stage III sere.

Benthic index frequency distributions for Rappahannock Alternate are shown in Figure V-32, and summary statistics are given in Table V-5. The distributions were largely bimodal, reflecting the patchiness in successional stages at this site. The major modal index value increases from +5 in February to +7 in all subsequent surveys. In August and October there were significantly fewer low index values (less than +7) than in February. There was an increase in index values with time, but no obvious within-grid spatial patterns emerged.

Sediments

The results of the sediment analyses are presented in full in Appendix B. Appendix B1 contains tabular listings for all samples with values of percent weight gravel, sand, silt, and clay, and the graphic statistical measures. Appendix B2 contains the cumulative size frequency curves and a complete listing of the graphic and moment measures. A summary of percent weight gravel, sand, silt, and clay for all stations within the two Rappahannock disposal areas is given in Table V-6.

Spatial Variations: The results of Cruise 2 (Winter, 1984) serve to define the gradients in sediment texture at the Rappahannock Disposal Areas (Figure V-33). Both of the disposal areas exhibit east-west gradients in sand content. The Rappahannock Shoal Deep Disposal Area reflects, as well, the topographic gradient from a mid-Bay sand shield on which resides the island chain extending northward from Tangier Island. The strong sand gradient virtually bisects the disposal area with only traces of sand found in the sediments in the western portion of the disposal area.

The Rappahannock Alternate Disposal Area also exhibits an east-west gradient, however it is considerably weaker. The eastern fringe contains sand in excess of 10 percent. The extreme southwest corner reflects the high sand content of Rappahannock Spit.

As in the Wolf Trap disposal areas higher density sampling was conducted in sub-areas to discern spatial changes at scales within one kilometer. During Cruise 3 (Spring, 1984), a 7 x 4 grid was sampled between RSP14 and RSP18 (see Figure II-5A and 5B). This sub-area is within the sand shield in the eastern sector of the disposal area. As well, an east-west 1 x 9 line array was sampled with the array centered on RAP08 (see Figure II-5C). No gradients in percent weight sand or percent clay were detected in the grid array. The sand content (0-5 cm horizon) varied between 88 to 95 percent weight, and the clay content varied between 3 and 7 percent.

The line array centered on RAP08 is located on the fringe of the sand shield extending from the Tangier-Bloodsworth Island complex. While the sand content varied only between 2 and 12 percent, a clear gradient existed with increasing values toward the east. The clay content, varying between 27 to 38 percent, also indicates a weaker gradient with a trend inverse to that of the sand content.

Variations With Depth: At the Wolf Trap disposal area a comparison of the relative sand fraction content between the upper sediment horizon (0-5 cm) with that of the 5-15 cm horizon disclosed vertical grading of the bed sediments. In those cases the lower sand horizon generally had higher sand content. Similar comparisons for the Rappahannock Disposal Areas are shown in Figures V-34, V-35, and V-36. In the Rappahannock Primary Area (Fig. V-34) the vertical grading noted in the Wolf Trap areas is not present. Rather, in those areas with very high sand content, the upper horizon tend to have higher sand content. In those areas with very small sand content no differentiation can be made. In the Rappahannock Alternate Disposal Area the sand content is generally less than 10 percent. Figure V-35 reflects no clear indication of relative sand enrichment. Given the generally low sand content this comparison may not be sensitive enough to reflect biological sediment grading. Figure V-36 indicates a similar comparison for percent weight silt. No relative difference between horizons is discernable. The contrast in findings between the Rappahannock and Wolf Trap disposal areas is consistent with difference in the abundance of deep-dwelling, biotrubating deposit feeders, predominantly maldanid polychaetes.

Temporal Variations: Examination of cruise to cruise variations in the 0-5 cm sediment sand, silt, clay percentages (Table V-6) discloses no perceptible seasonal variation. This finding does not rule out modulation of the sediment surface elevation due to erosion and/or deposition. However, it does imply that similar sediments are involved in the advective processes resulting in deposition. The results are useful in serving as a cross-check on the interpretation of REMOTS imagery for the sediments in the sand shield area which penetrates much of the Rappahannock Primary Area.

Stations RSP03, 08, 12, 14, 18 were all interpreted as having sand over mud (S/M) in two or more of the cruises. Camera penetration was always less than 5 cm. Quantitative assessment of the sediments indicated that sediment composition was always 80 percent or greater in sand content. Moreover, the 5-15 cm sediment horizon was always greater than 75 percent sand. On board processing did not indicate interfingering of sand and mud layers which is consistent with the quantitative results which indicate less than 15 percent mud fraction. The conclusion is that the "sand over mud" interpretation is erroneous. The error may arise due to the presence of an active mobile sand layer of loose packing overlying an undisturbed layer. This would be consistent with observation of hydraulic bedforms and shell horizons wherein the percentage of silt/clay is winnowed. This is further reinforced by the fact that the percent weight sand in the upper five centimeters is larger by a few percent than that in the lower horizon (5-15 cm).

Total Organic Carbon: Table V-7 lists the results in percent weight total organic carbon for the Rappahannock Shoals disposal areas. Consistent with earlier findings (Byrne, et al, 1982) the values are higher than those found in the Wolf Trap disposal areas. Values range downward from 2.3 percent.

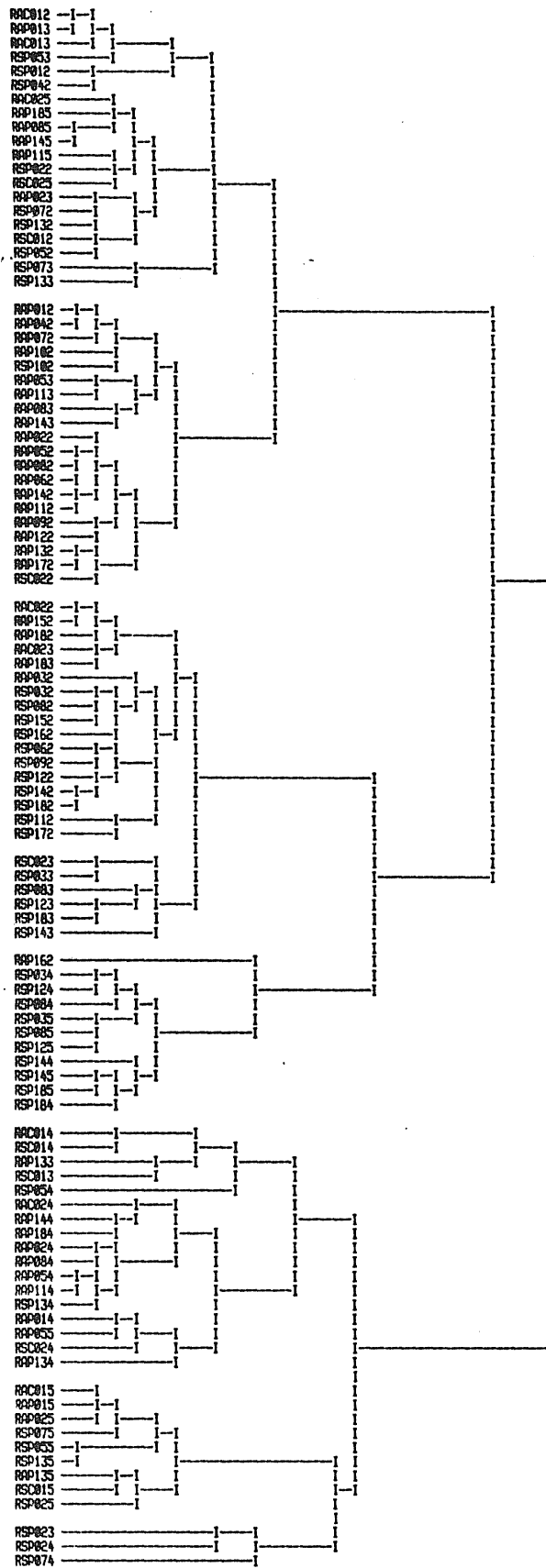

Figure V-1. Station cluster groups formed by classification of all stations for each cruise at the Rappahannock Shoals Study Region.

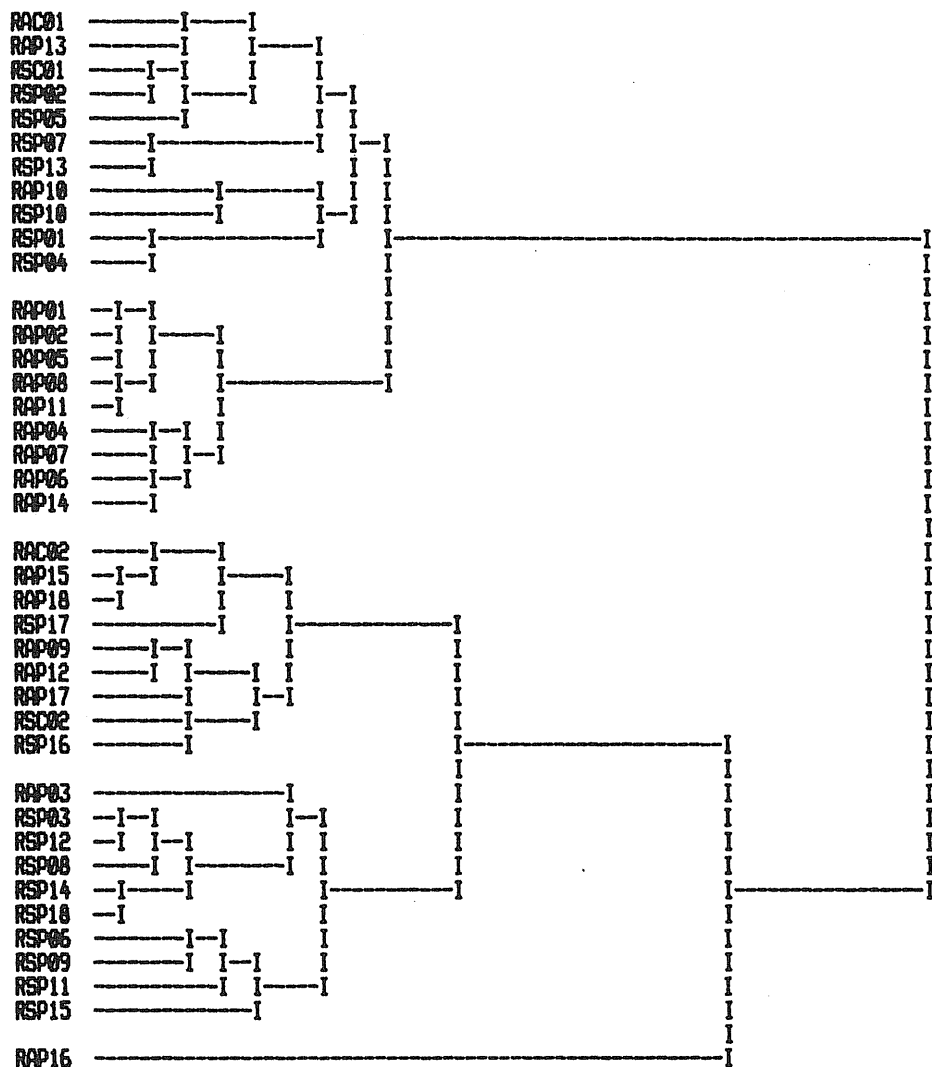

Figure V-2. Station cluster groups formed by classification of all cruises combined by station at the Rappahannock Study Region.

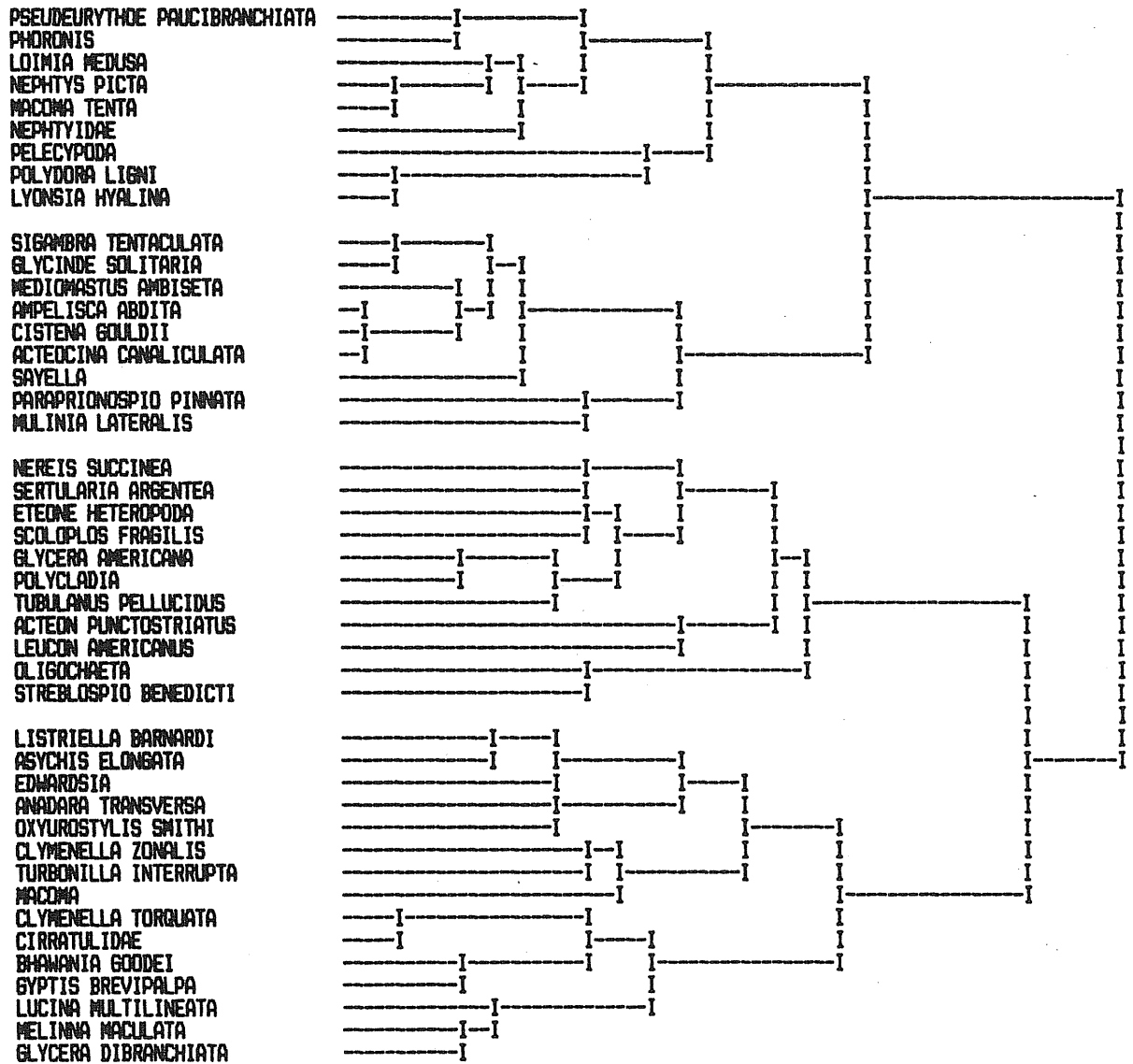

Figure V-3. Species cluster groups formed by classification of all stations for each cruise at the Rappahannock Study Region.

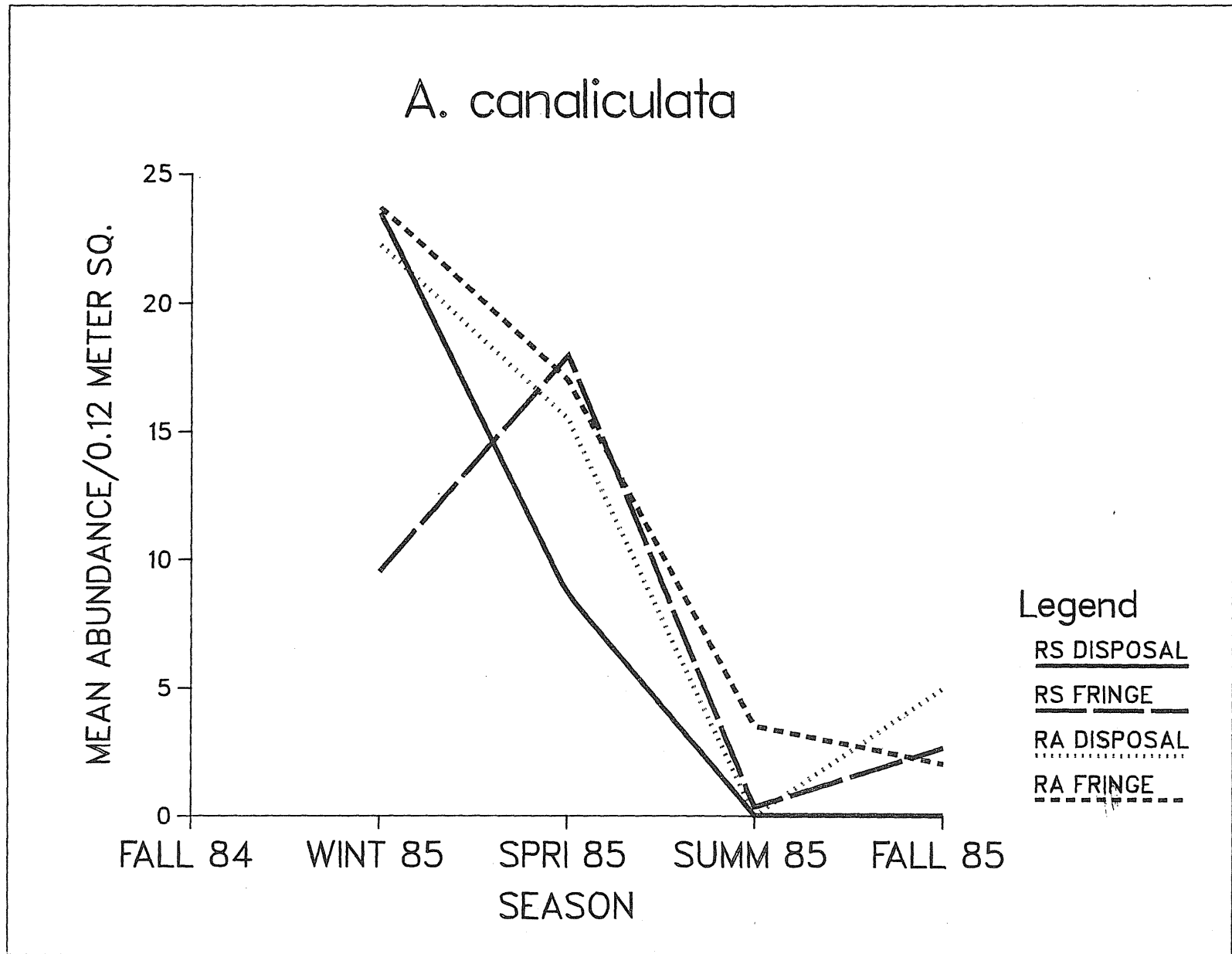

Figure V-4. Seasonal abundance of *Acteocina canaliculata* averaged by site, and disposal or fringe areas for the Rappahannock Shoals Study Region.

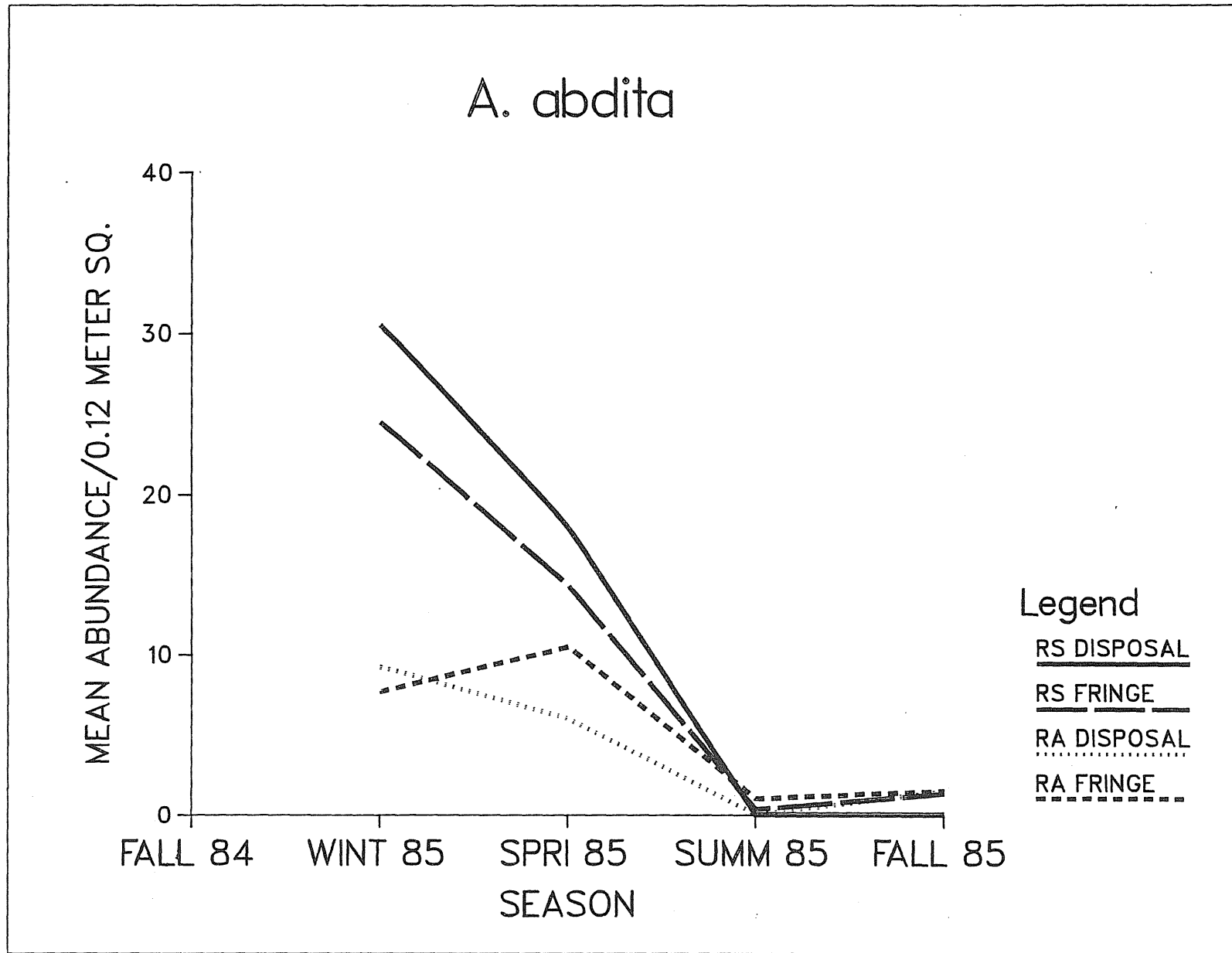

Figure V-5. Seasonal abundance of *Ampelisca abdita* averaged by site, and disposal or fringe areas for the Rappahannock Shoals Study Region.

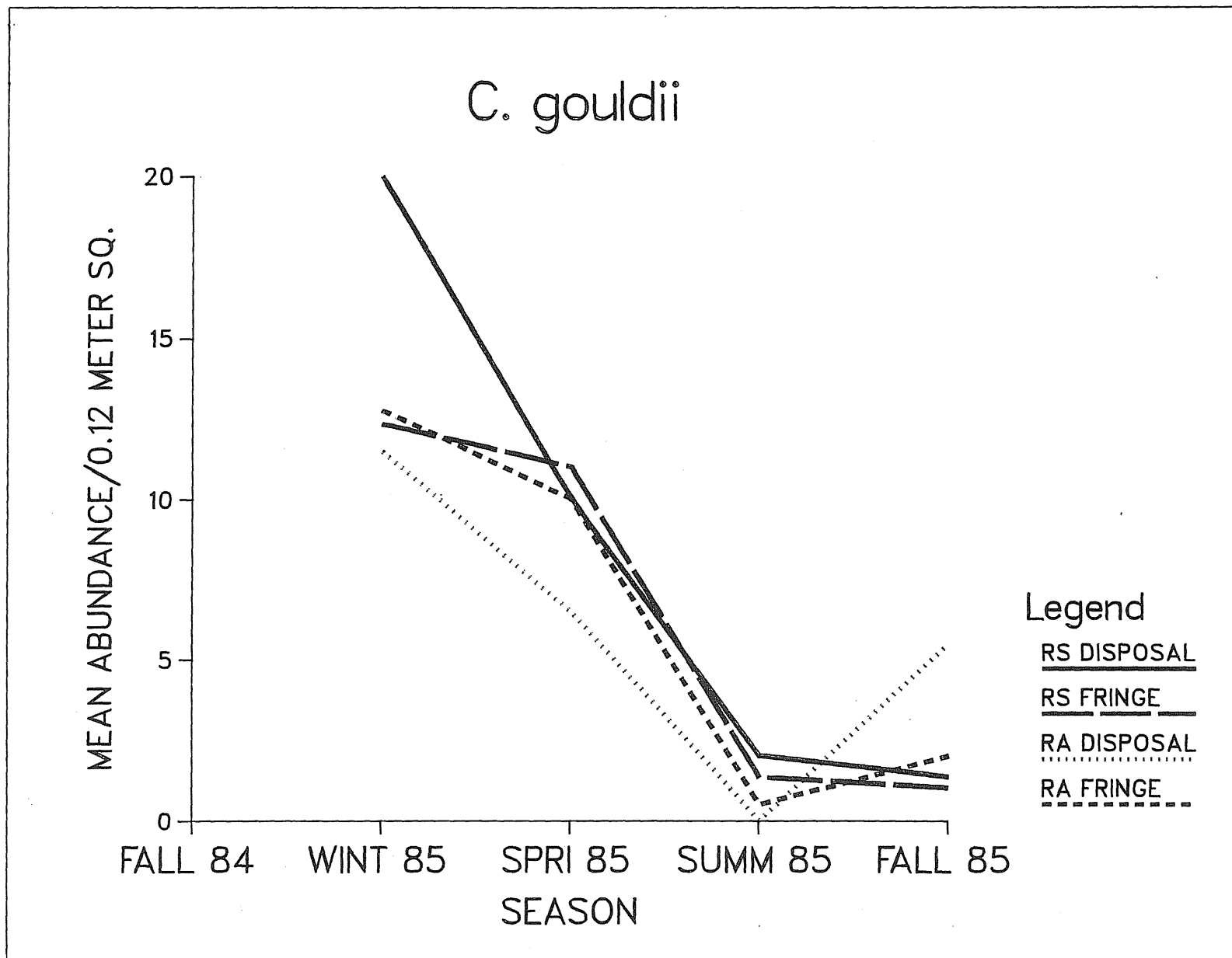

Figure V-6. Seasonal abundance of *Cistena gouldii* averaged by site, and disposal or fringe areas for the Rappahannock Shoals Study Region.

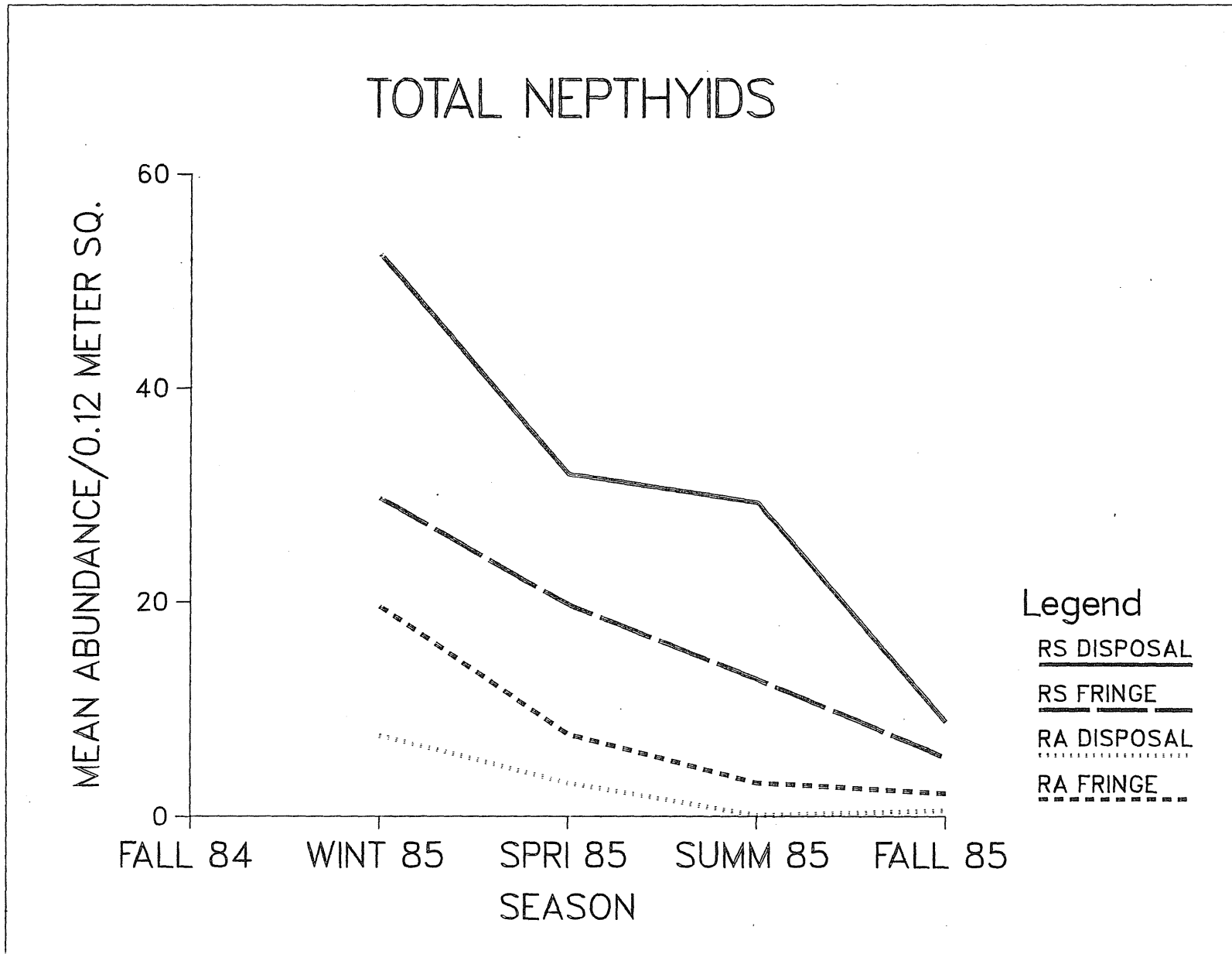

Figure V-7. Seasonal abundance of Total Nephthyids averaged by site, and disposal or fringe areas for the Rappahannock Shoals Study Region.

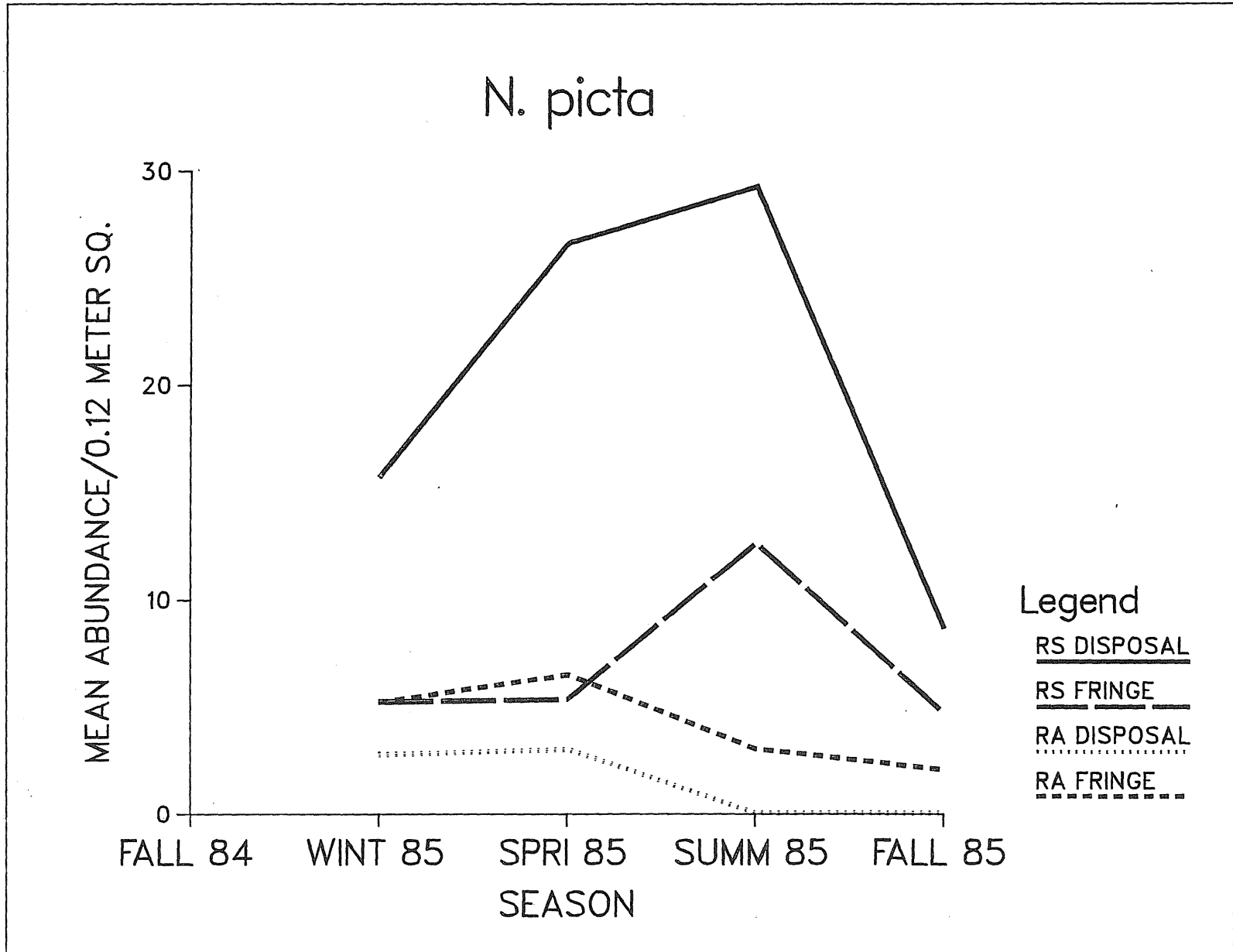

Figure V-8. Seasonal abundance of *Nephys picta* averaged by site, and disposal or fringe areas for the Rappahannock Shoals Study Region.

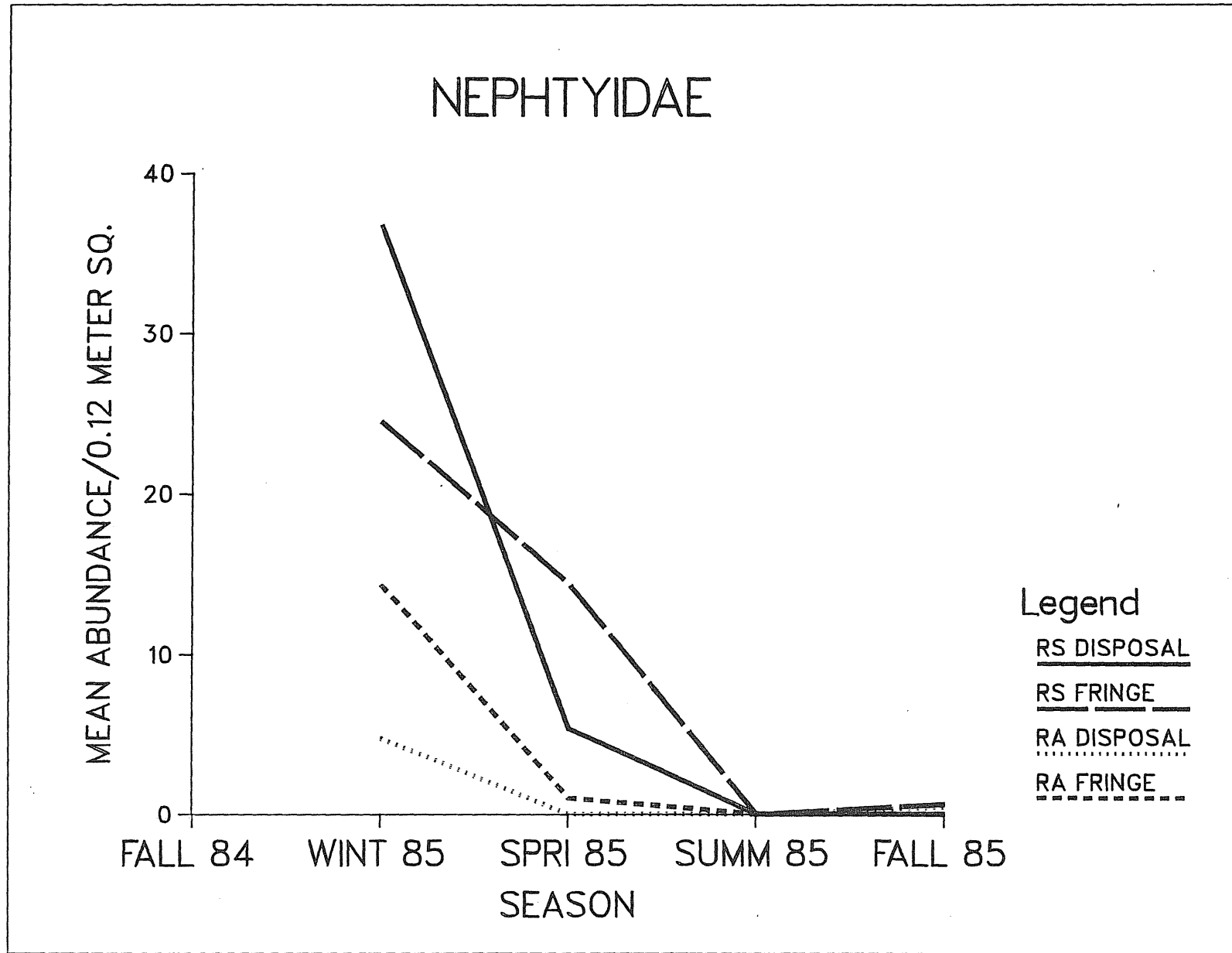

Figure V-9. Seasonal abundance of Nephtyidae averaged by site, and disposal or fringe areas for the Rappahannock Shoals Study Region.

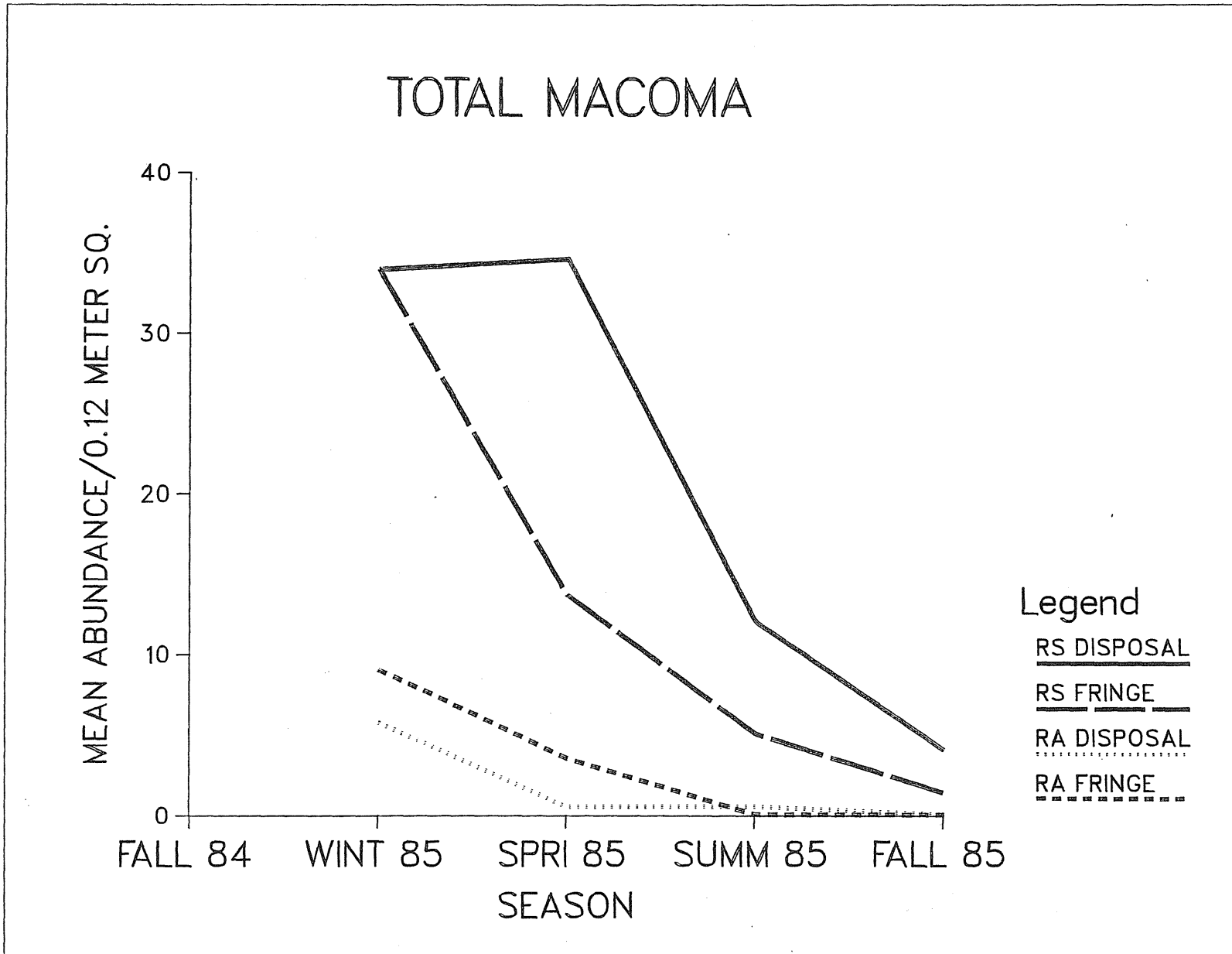

Figure V-10. Seasonal abundance of Total Macoma Spp. averaged by site, and disposal or fringe areas for the Rappahannock Shoals Study Region.

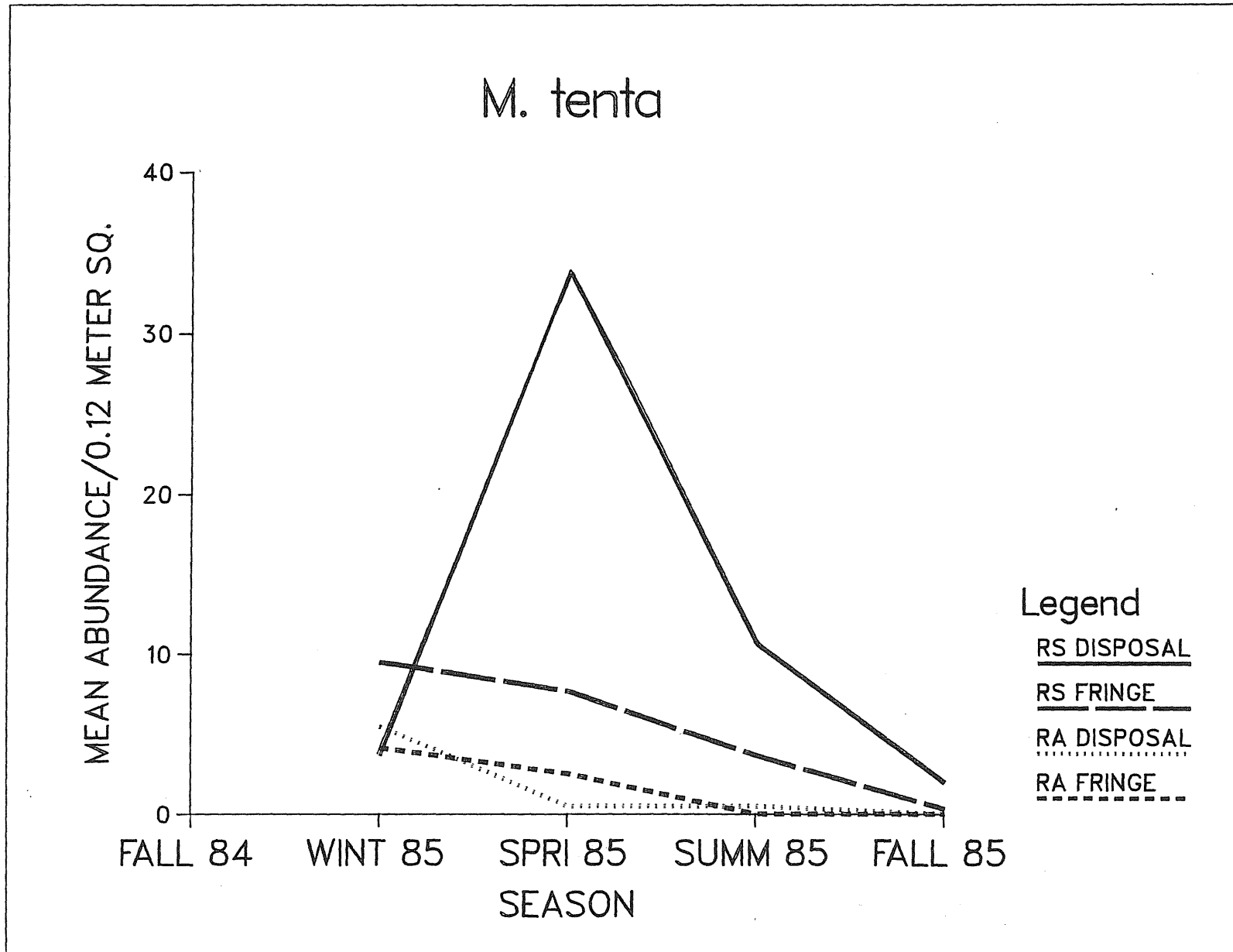

Figure V-11. Seasonal abundance of *Macoma tenta* averaged by site, and disposal or fringe areas for the Rappahannock Shoals Study Region

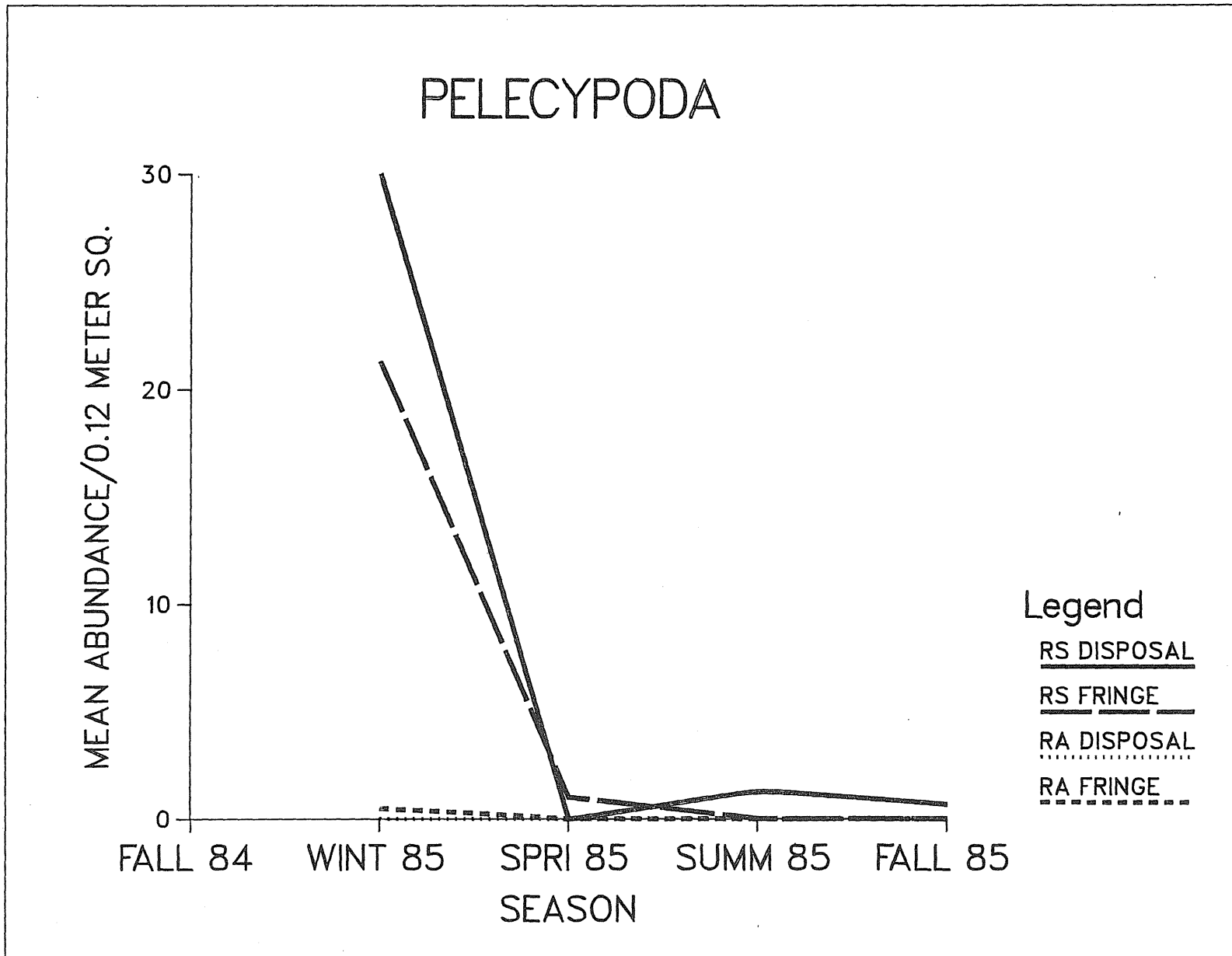

Figure V-12. Seasonal abundance of Juvenile Pelecypoda averaged by site, and disposal or fringe areas for the Rappahannock Shoals Study Region.

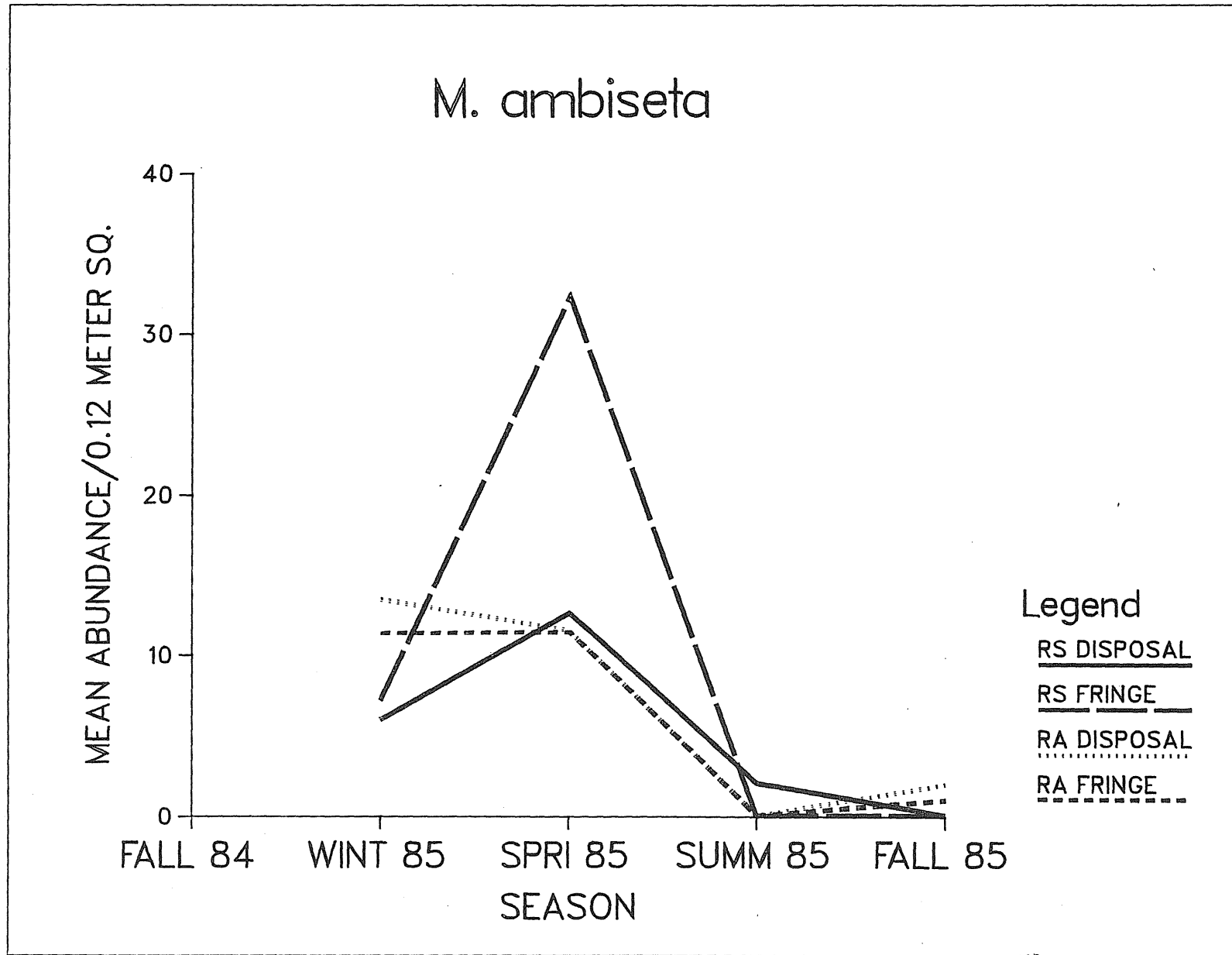

Figure V-13. Seasonal abundance of *Mediomastus ambiseta* averaged by site, and disposal or fringe areas for the Rappahannock Shoals Study Region.

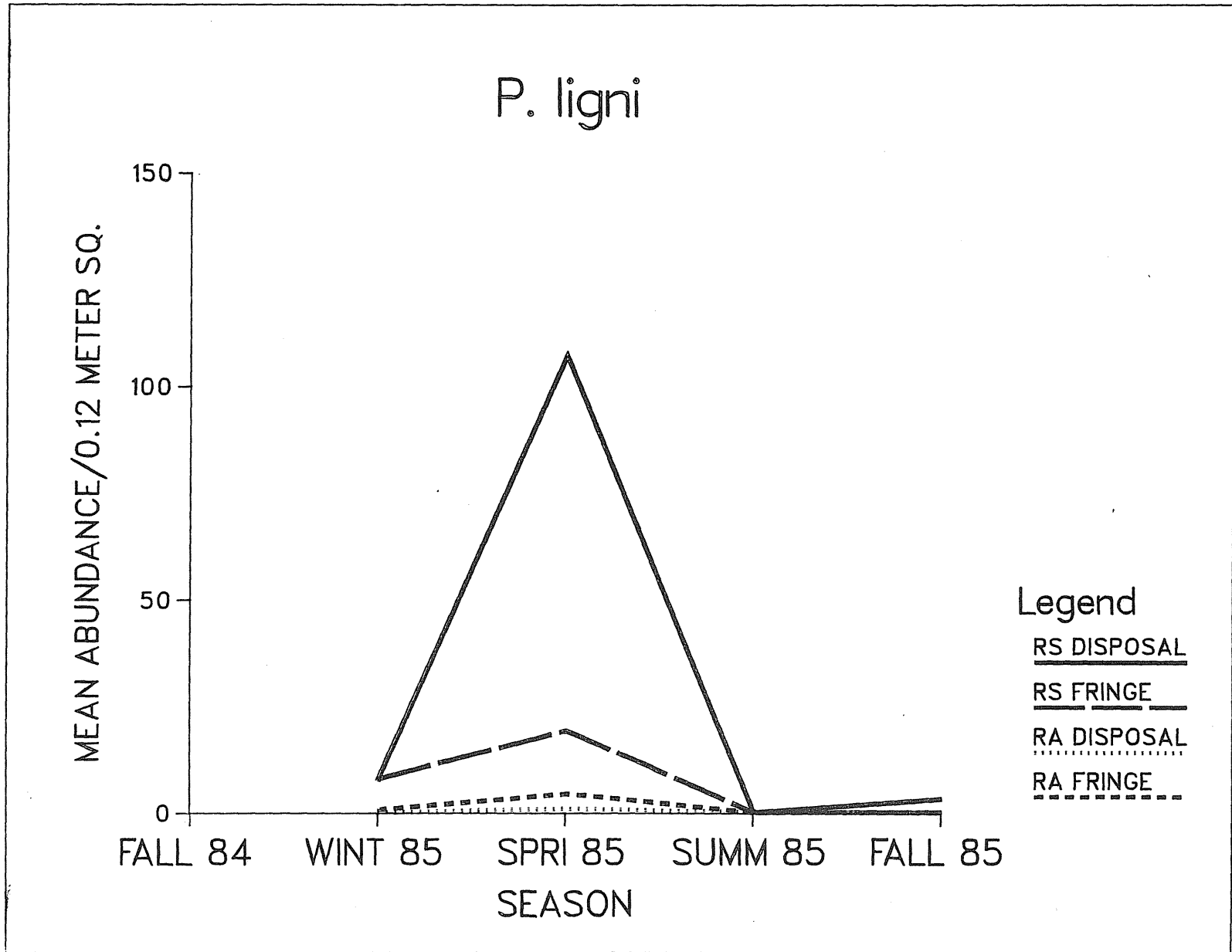

Figure V-14. Seasonal abundance of *Polydora ligni* averaged by site, and disposal or fringe areas for the Rappahannock Shoals Study Region.

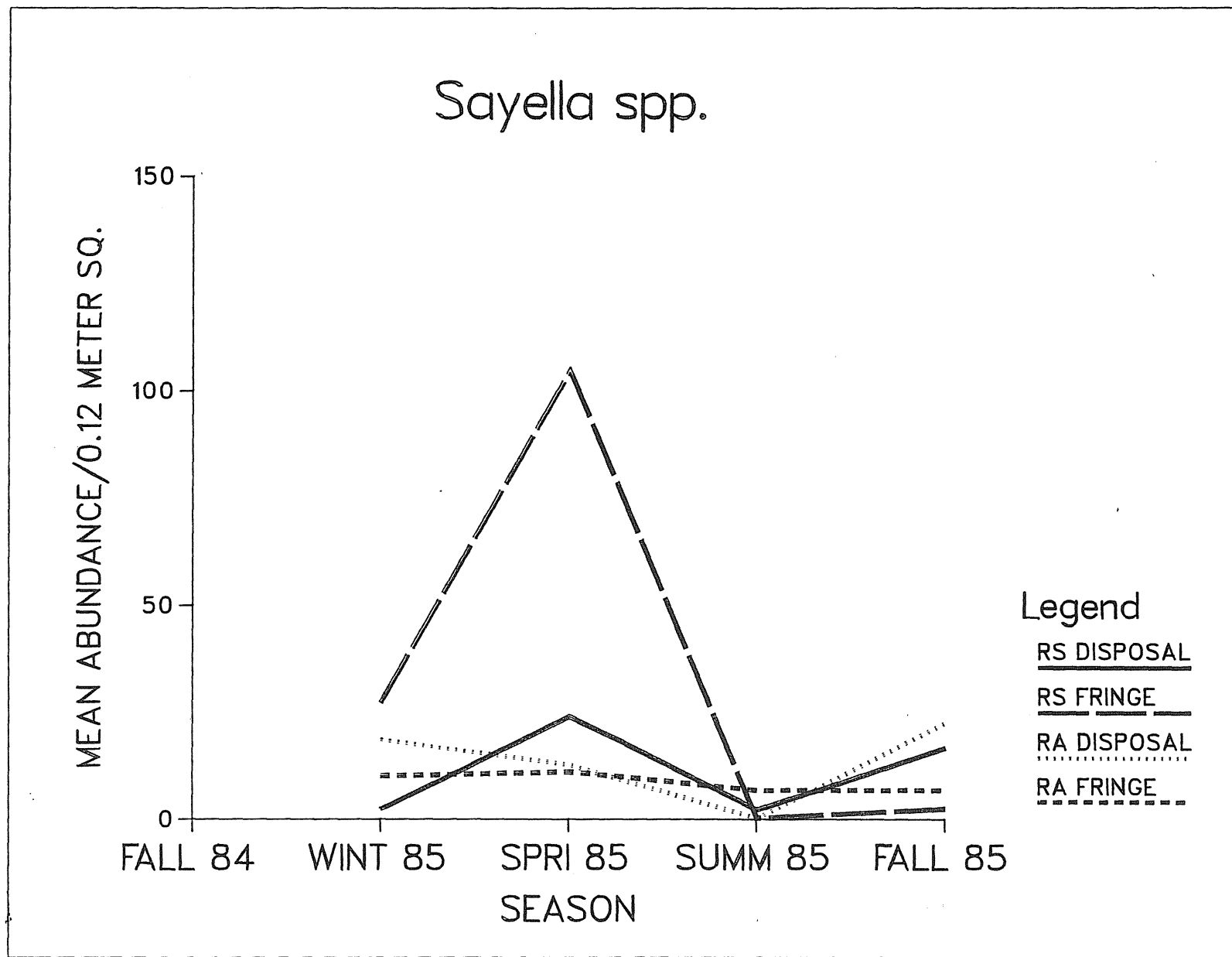

Figure V-15. Seasonal abundance of *Sayella* spp. averaged by site, and disposal or fringe areas for the Rappahannock Shoals Study Region.

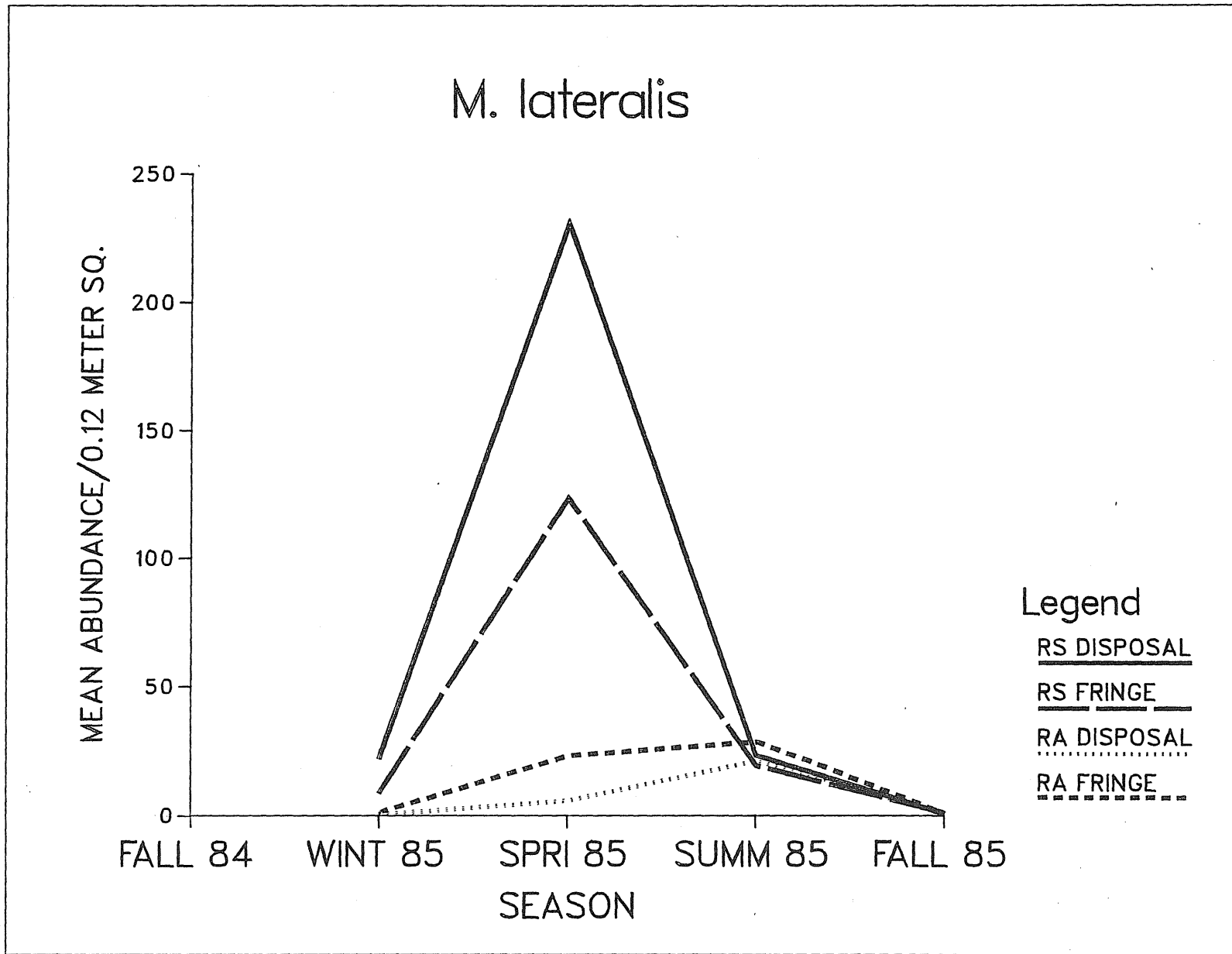

Figure V-16. Seasonal abundance of *Mulinia lateralis* averaged by site, and disposal or fringe areas for the Rappahannock Shoals Study Region.

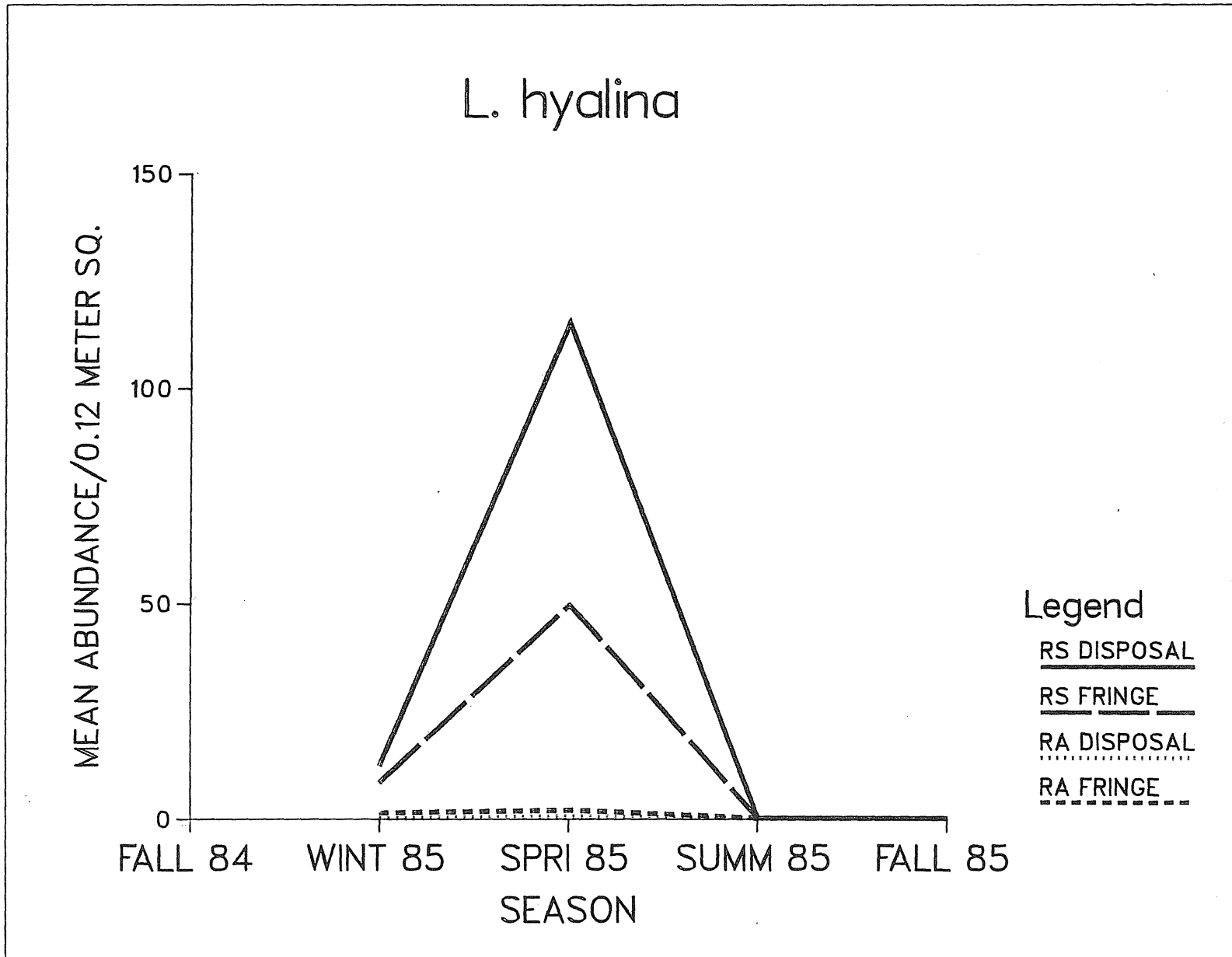

Figure V-17. Seasonal abundance of *Lyonsia hyalina* averaged by site, and disposal or fringe areas for the Rappahannock Shoals Study Region.

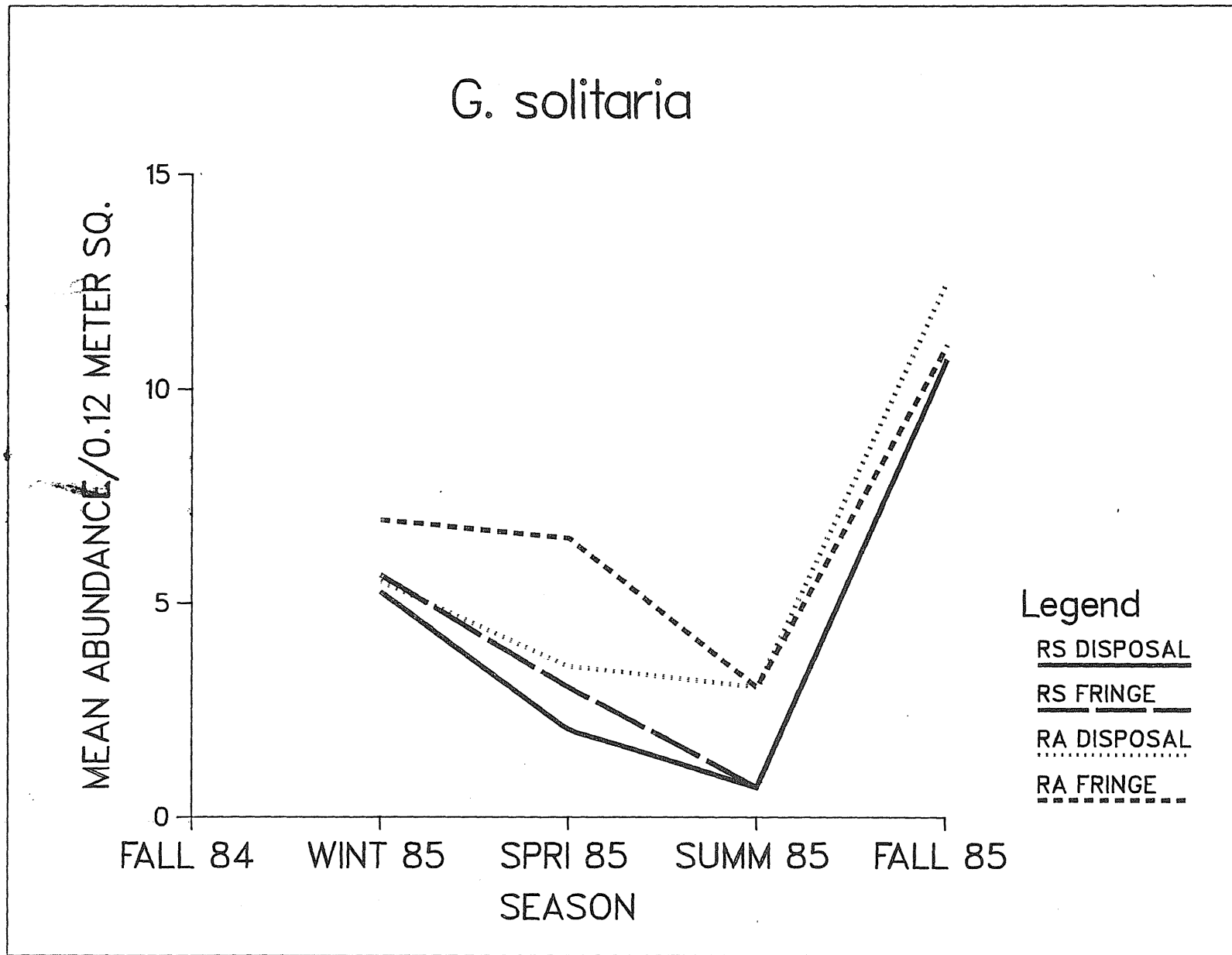

Figure V-18. Seasonal abundance of *Glycinde solitaria* averaged by site, and disposal or fringe areas for the Rappahannock Shoals Study Region.

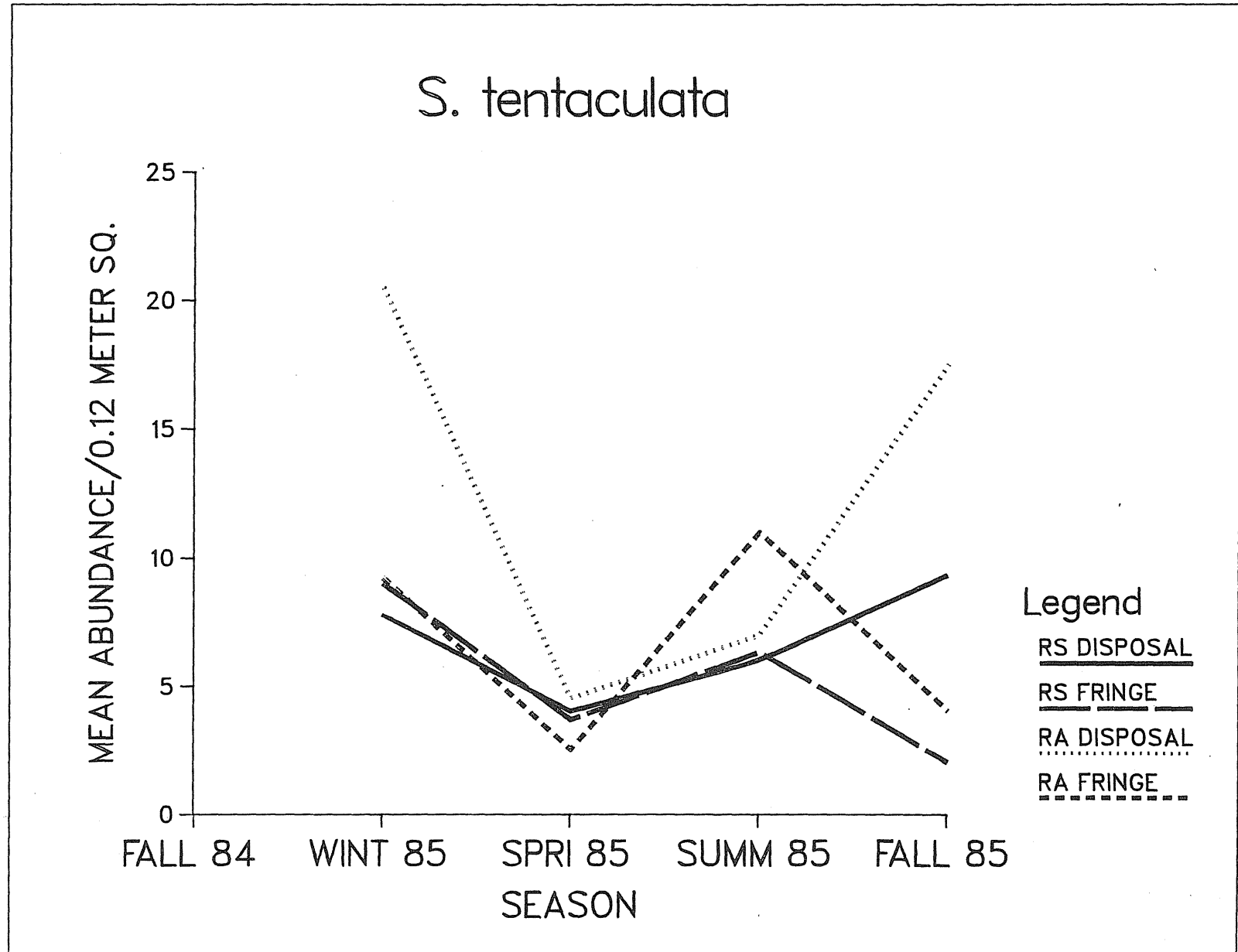

Figure V-19. Seasonal abundance of *Sigambra tentaculata* averaged by site, and disposal or fringe areas for the Rappahannock Shoals Study Region.

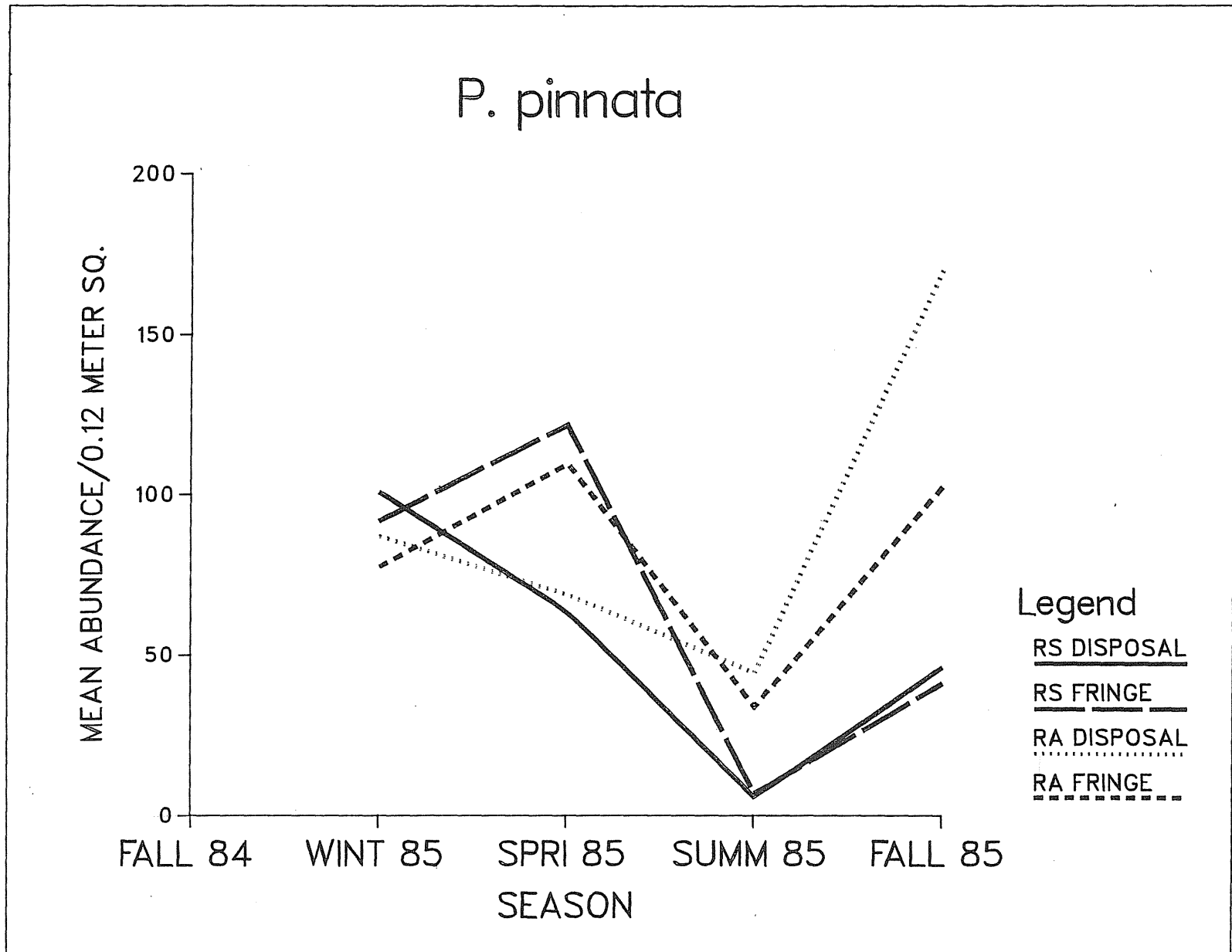

Figure V-20. Seasonal abundance of *Paraprionospio pinnata* averaged by site, and disposal or fringe areas for the Rappahannock Shoals Study Region.

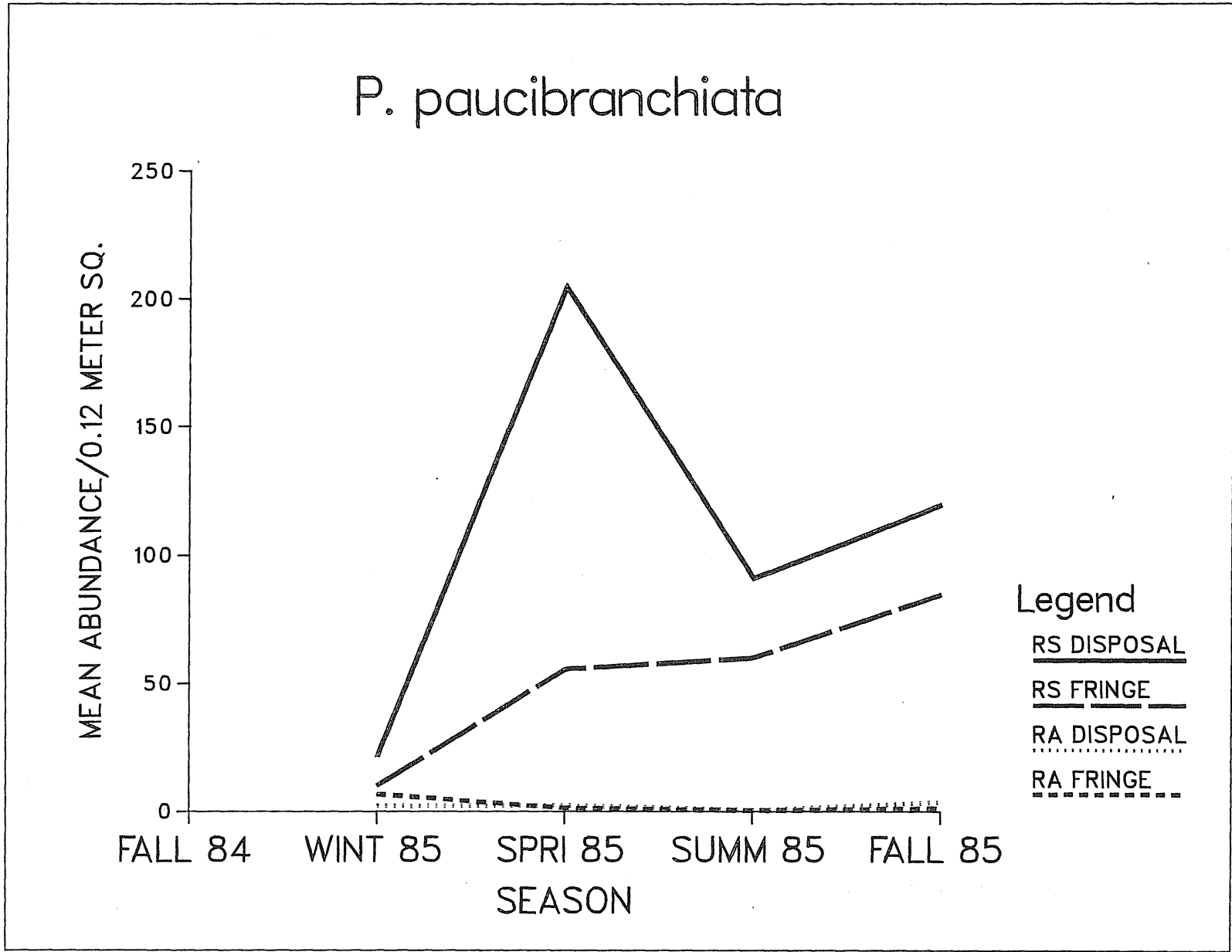

Figure V-21. Seasonal abundance of *Pseudeurythoe paucibranchiata* averaged by site, and disposal or fringe areas for the Rappahannock Shoals Study Region.

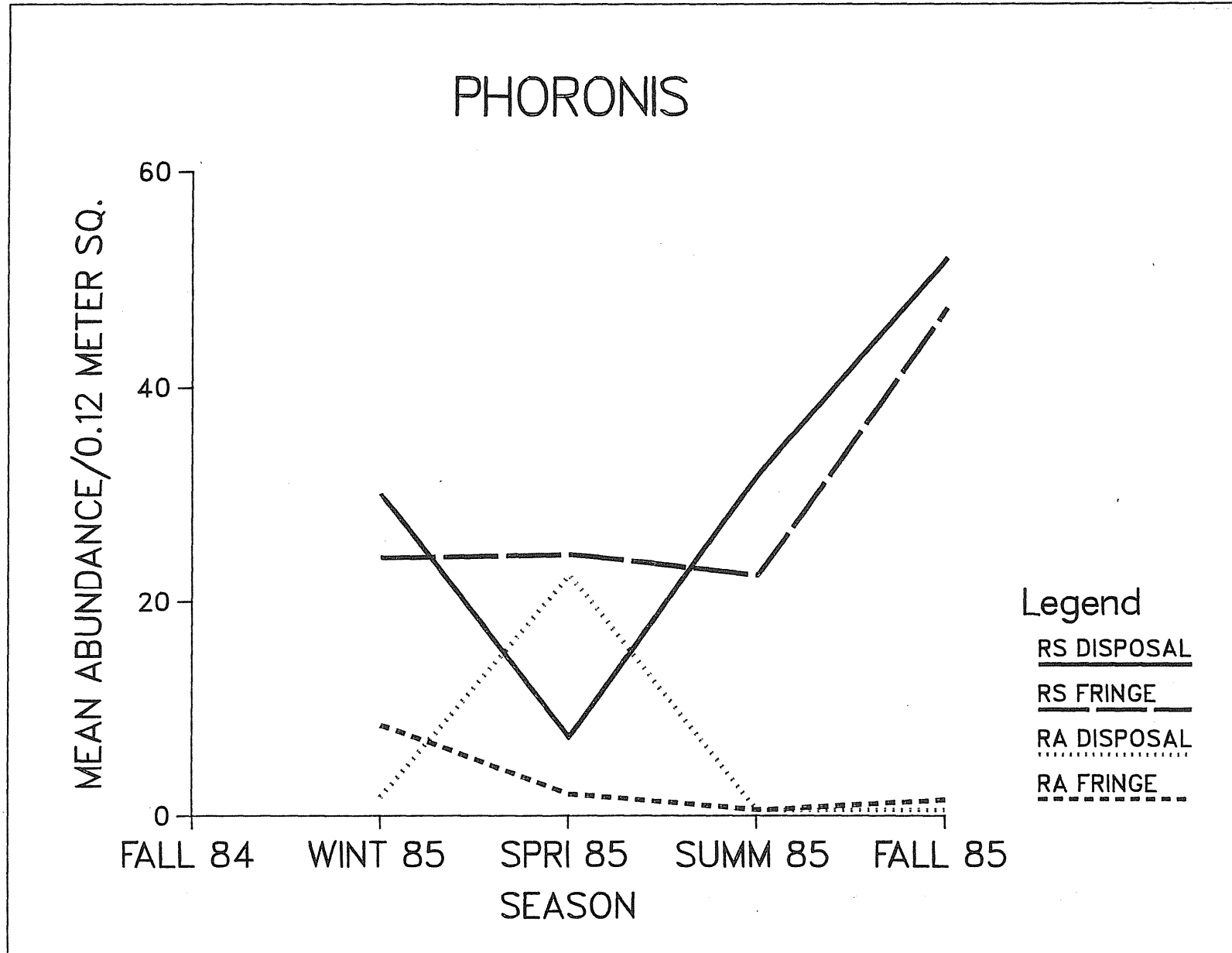

Figure V-22. Seasonal abundance of *Phoronis* spp. averaged by site, and disposal or fringe areas for the Rappahannock Shoals Study Region.

Figure V-23. Frequency distributions of boundary roughness values at the Rappahannock Shoals Site. Note scale differences on X and Y axes between sampling times.

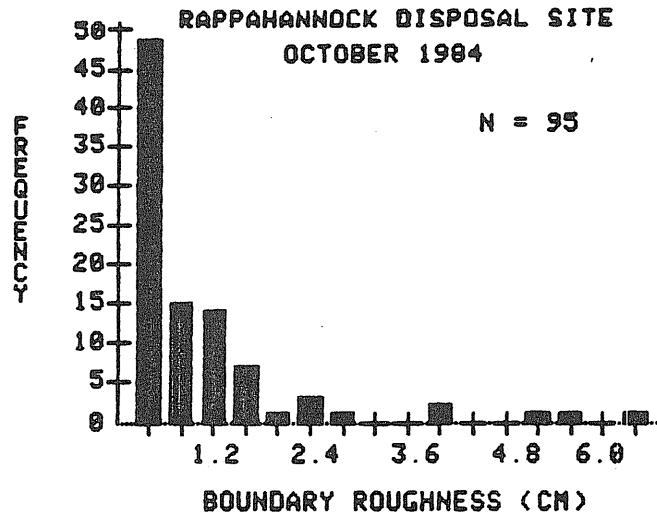
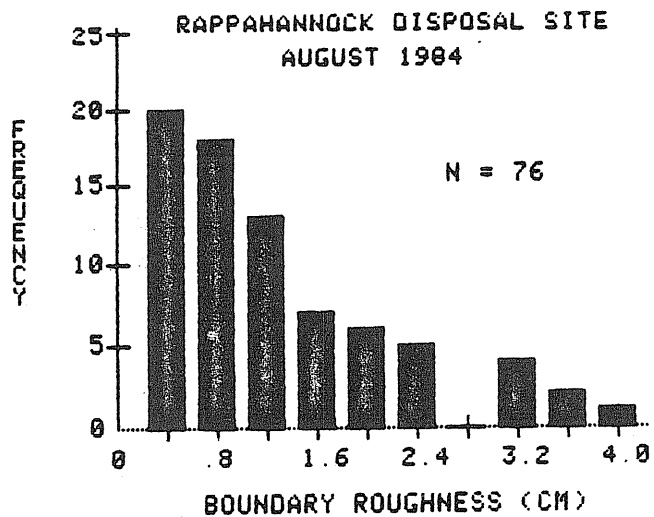
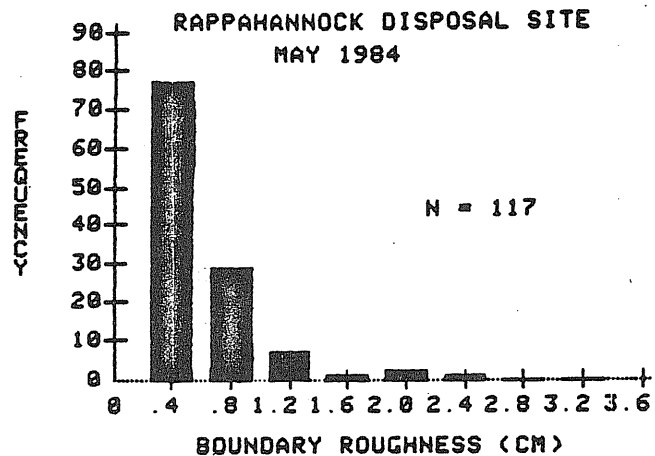
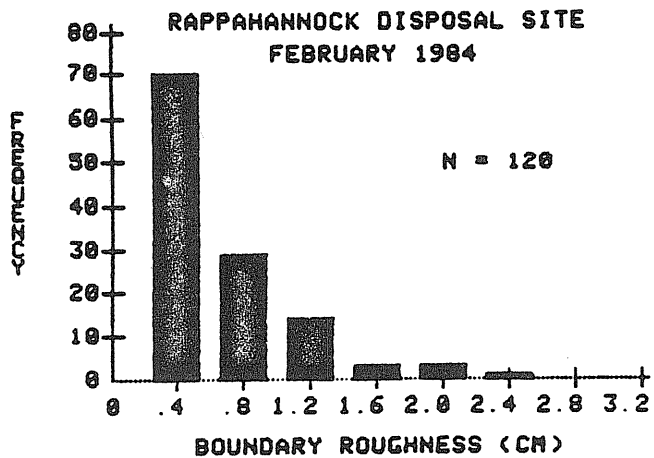

Figure V-24. Frequency distributions of the mean RPD depths (cm) at the Rappahannock Shoals Site. Note the scale differences on the X and Y axes.

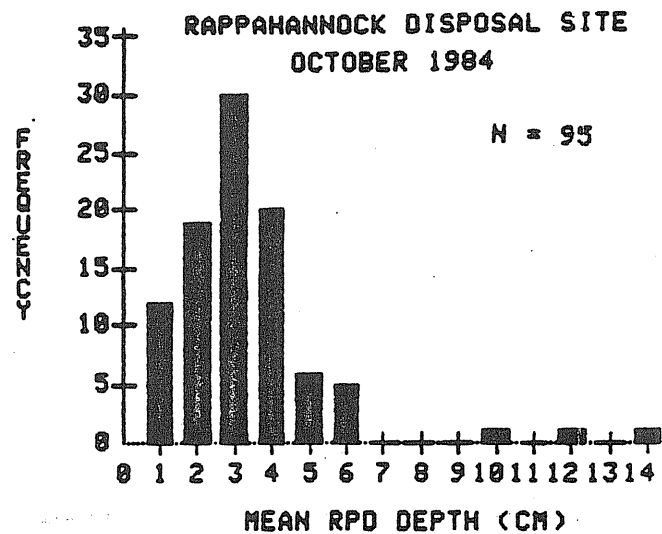
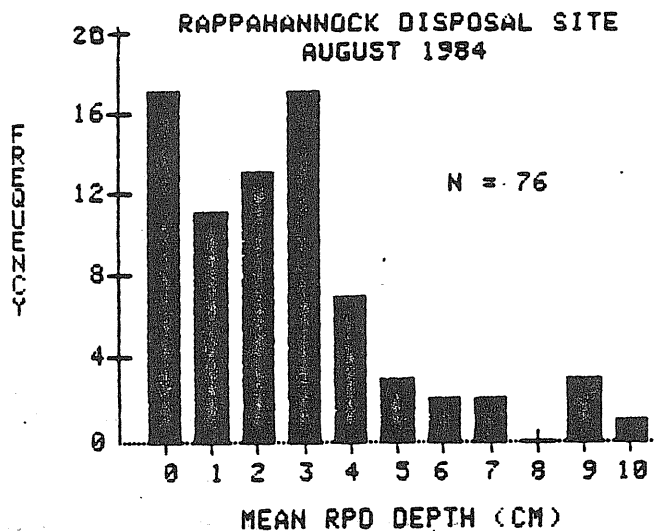
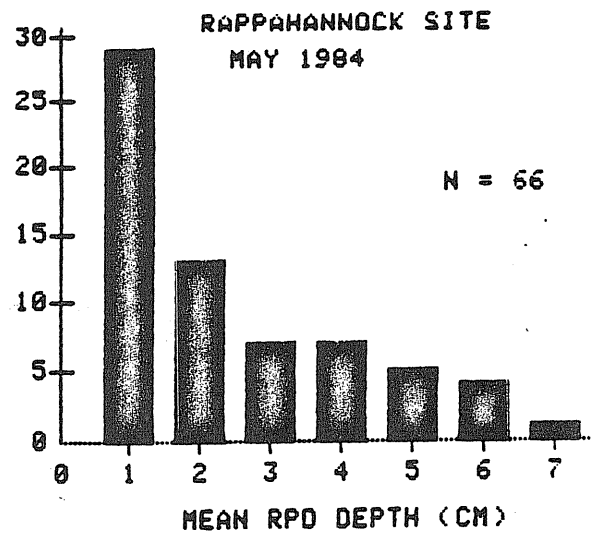
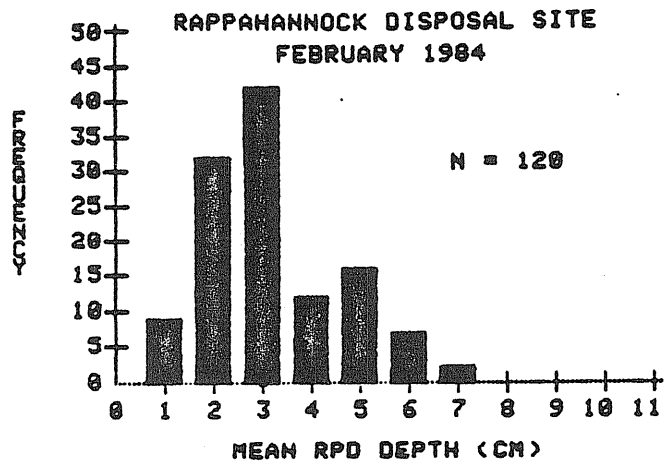
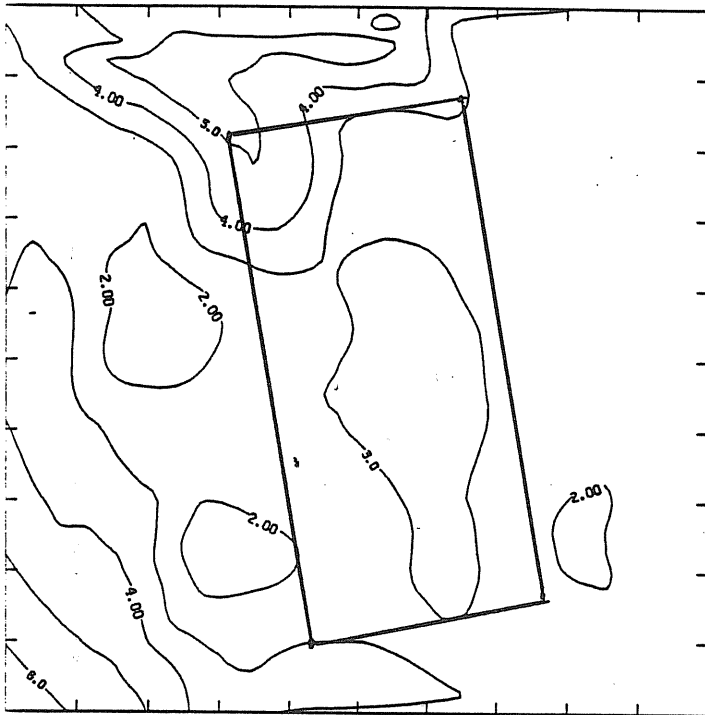

Figure V-25. Contour maps of RPD depths (1 cm intervals), averaged by station, at the Rappahannock Site for each survey. The maps are arranged in the following order:

February	May
August	October

Location of the disposal area within the Rappahannock Shoals Site is approximate.

RAPPAHANNOCK SITE RPD



CENTUR FROM 0.00000E+00 TO 9.00000 CENTUR INTERVAL OF 1.0000
 X INTERVAL= 0.35155E-04 Y INTERVAL= 0.53251E-04

RAPPAHANNOCK SITE RPD

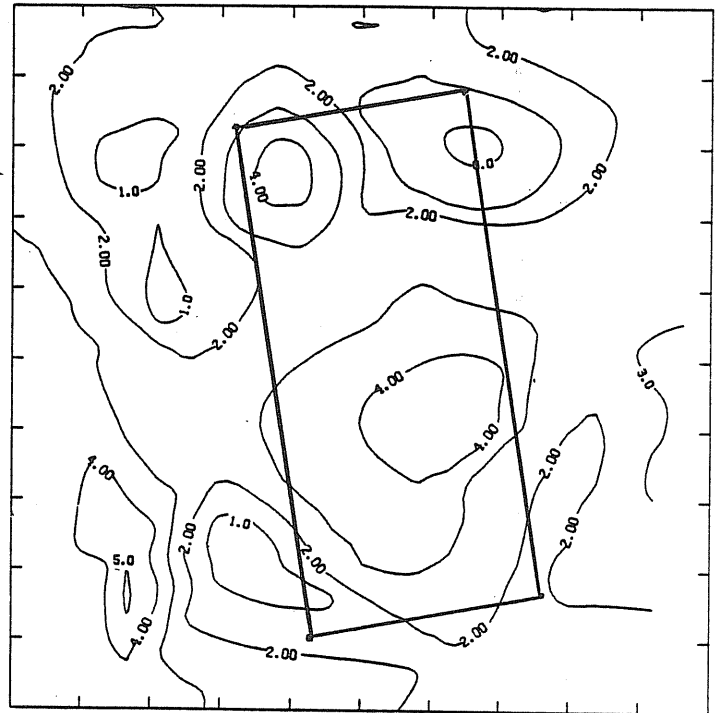

CENTUR FROM 0.00000E+00 TO 9.00000 CENTUR INTERVAL OF 1.0000
 X INTERVAL= 0.32911E-04 Y INTERVAL= 0.53662E-04

RAPPAHANNOCK SITE RPD

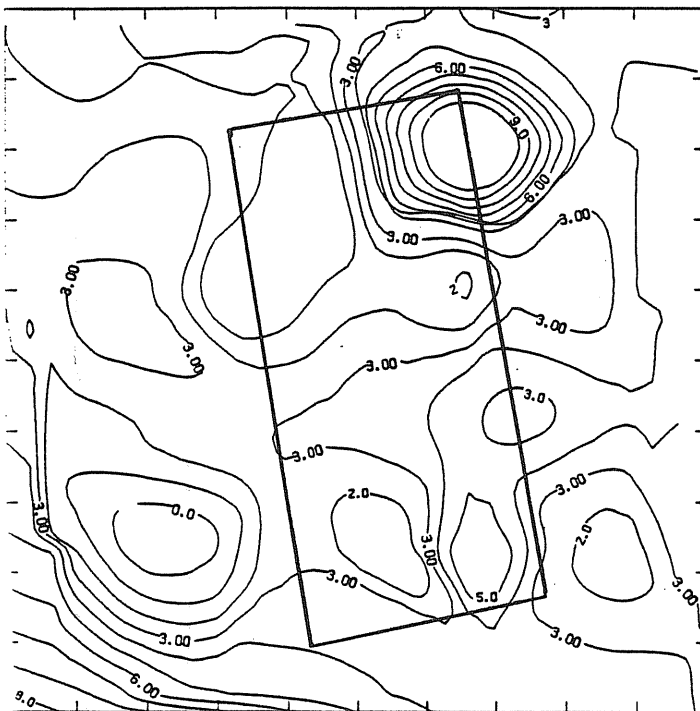

CENTUR FROM 0.00000E+00 TO 19.00000 CENTUR INTERVAL OF 1.0000
 X INTERVAL= 0.42398E-04 Y INTERVAL= 0.54520E-04

RAPPAHANNOCK SITE RPD

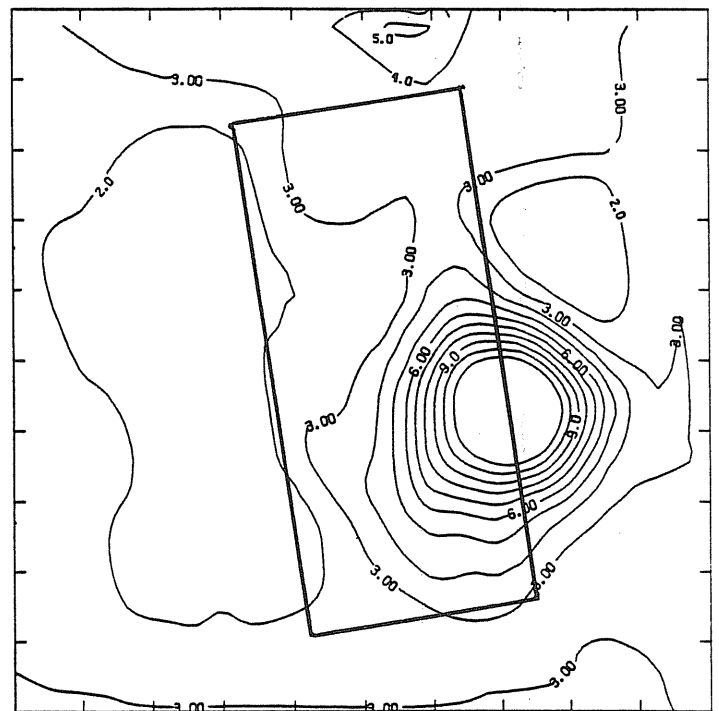

CENTUR FROM 1.00000 TO 11.00000 CENTUR INTERVAL OF 1.0000
 X INTERVAL= 0.42398E-04 Y INTERVAL= 0.54520E-04

Figure V-26. Frequency distributions of the percentage areal cover of each 1 cm RPD contour interval at the Rappahannock Site from February to October.

FEBRUARY

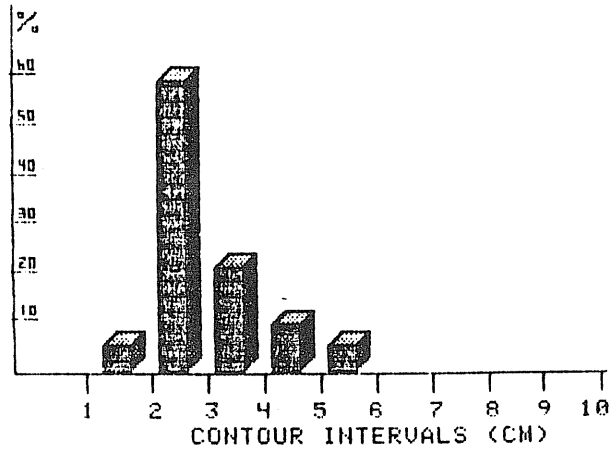

MAY

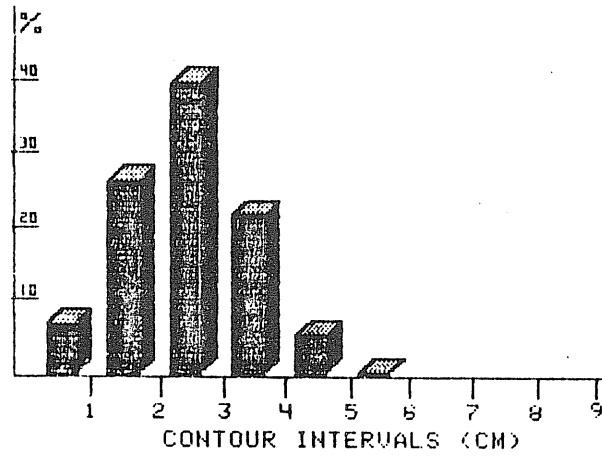

AUGUST

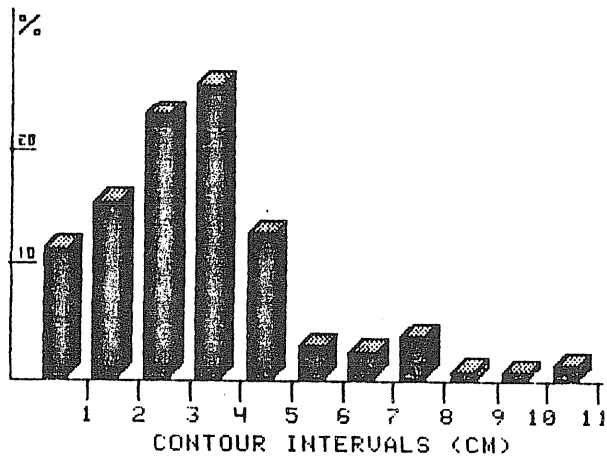

OCTOBER

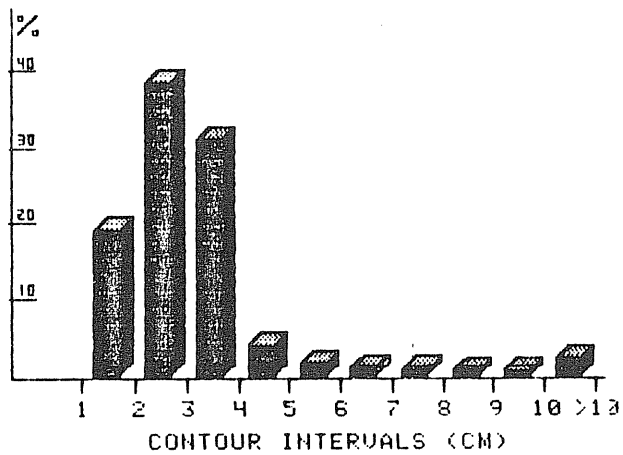

Figure V-27. Frequency distributions of benthic index values at the Rappahannock Site from February to October. Note scale differences in the X and Y axes between graphs.

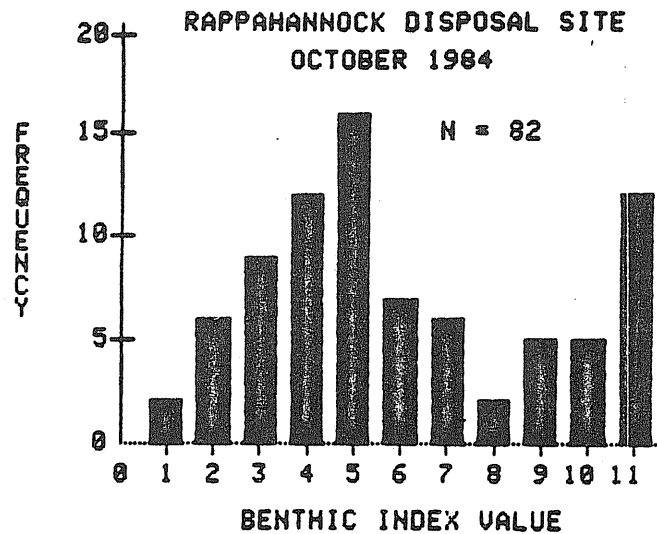
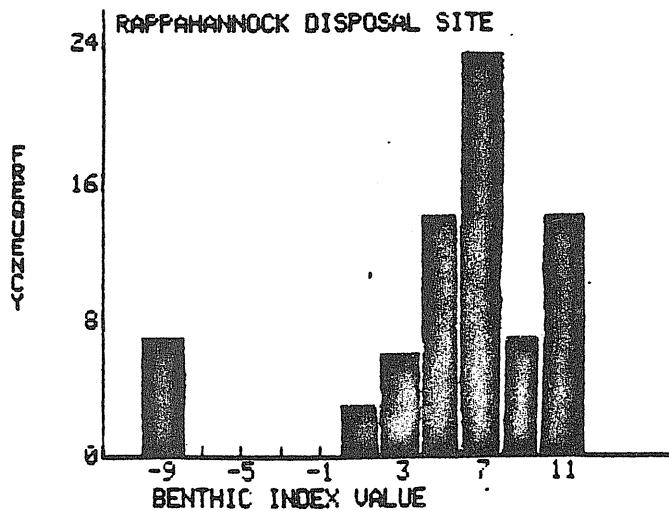
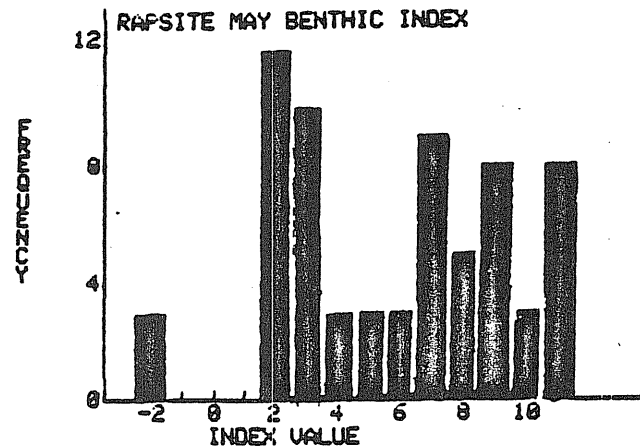
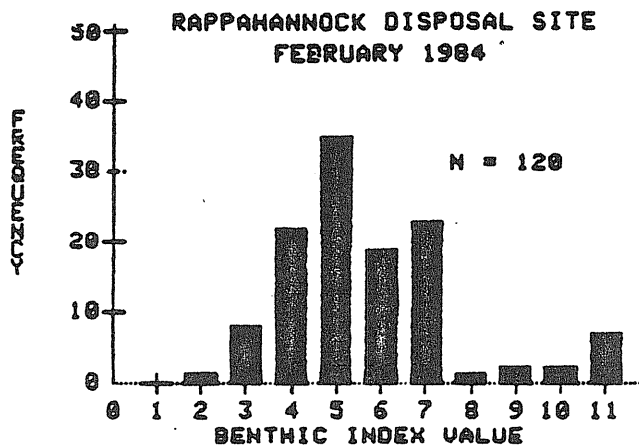

Figure V-28. Frequency distributions of boundary roughness values at the Rappahannock Alternate Site. Note scale differences on X and Y axes between sampling times.

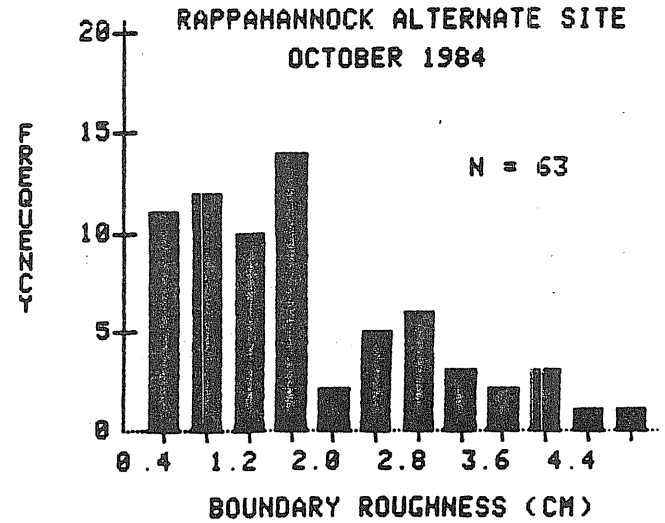
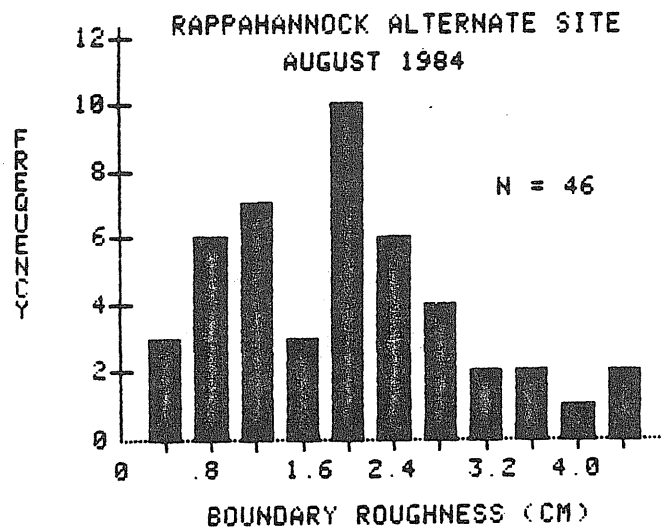
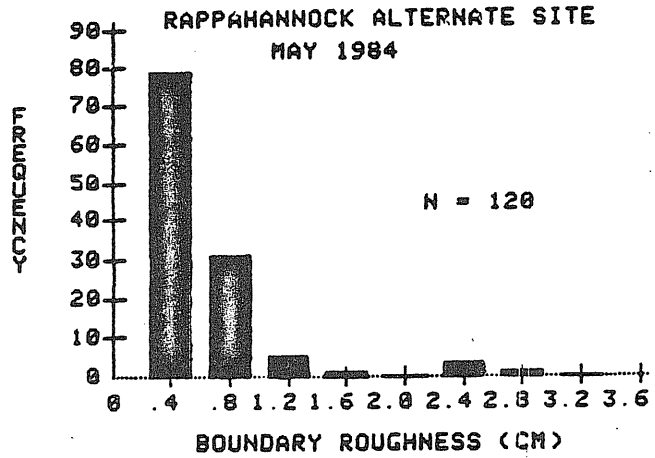
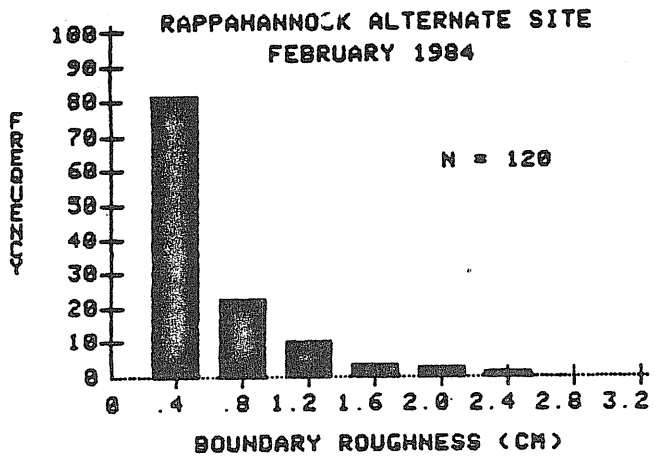

Figure V-29. Frequency distributions of the mean RPD depths (cm)
at the Rappahannock Alternate Site for all surveys.
Note the scale differences on the X and Y axes.

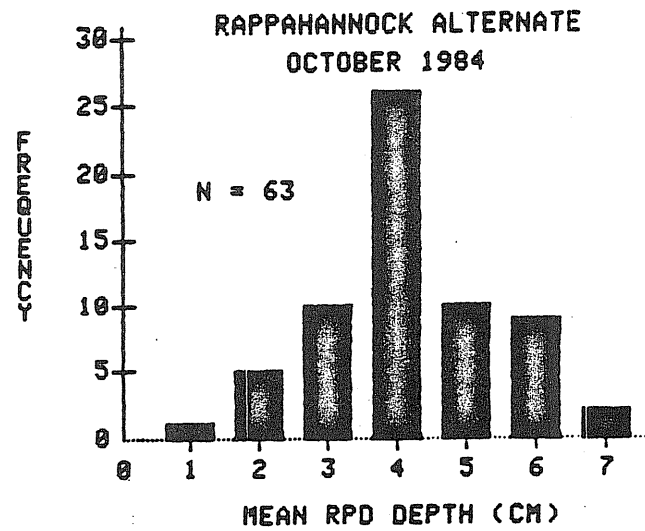
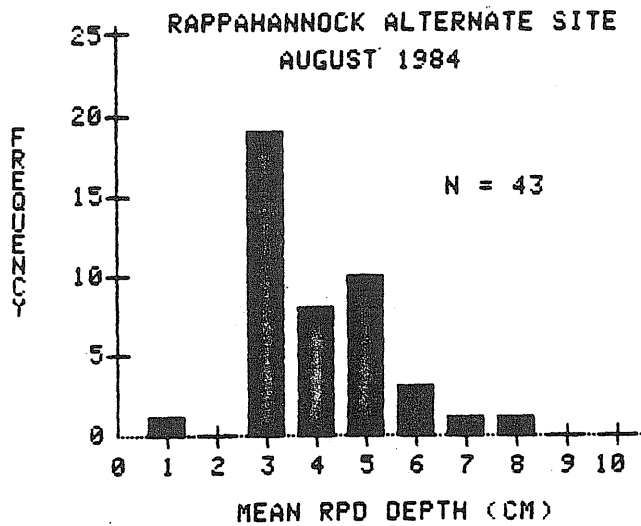
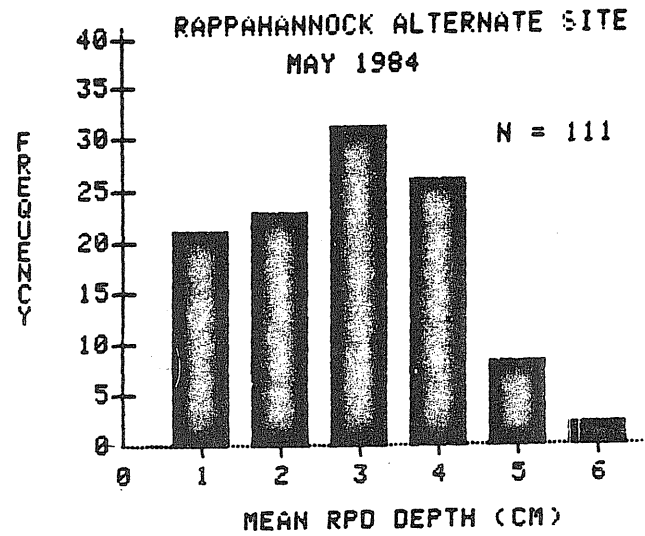
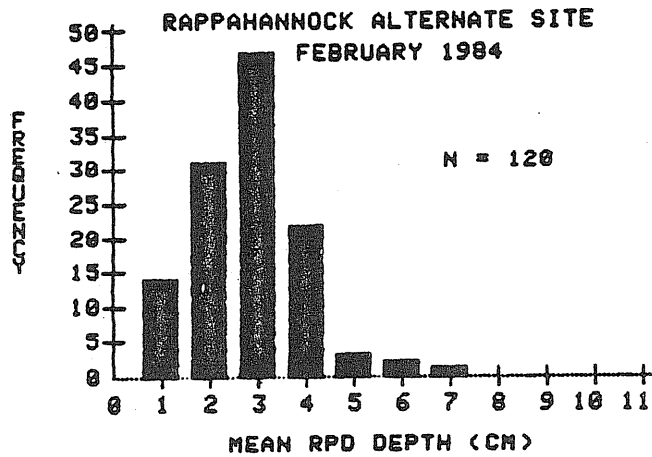

Figure V-30. Contour maps of RPD depths (1 cm intervals), averaged by station, at the Rappahannock Alternate Site for each survey. The maps are arranged in the following order:

February

May

August

October

Location of the disposal area within the Rappahannock Alternate site is approximate.

RAPPAHANNOCK ALTERNATE RPD

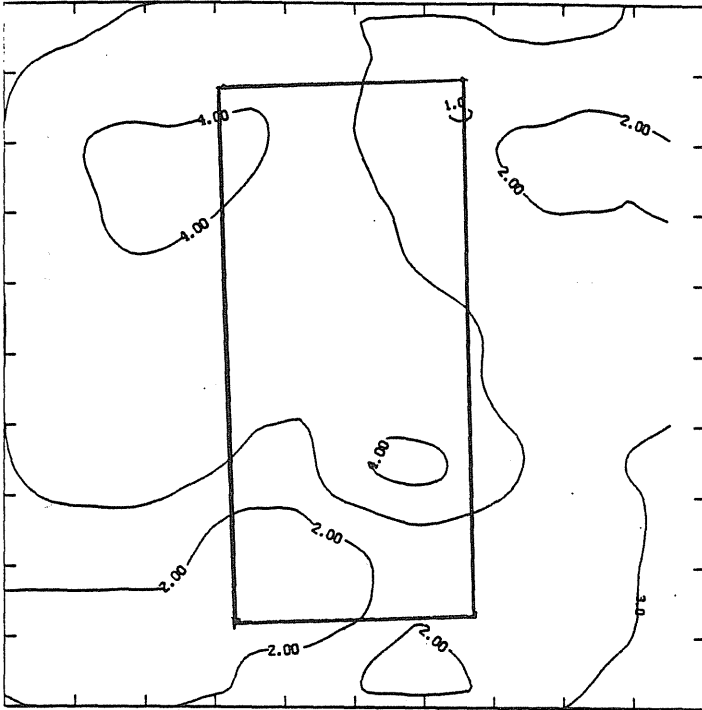

CNTR FRM 0.0000E+00 TO 9.0000 CNTR INTVL OF 1.0000
 X INTVL= 0.34012E-04 Y INTVL= 0.78833E-04

RAPPAHANNOCK ALTERNATE RPD

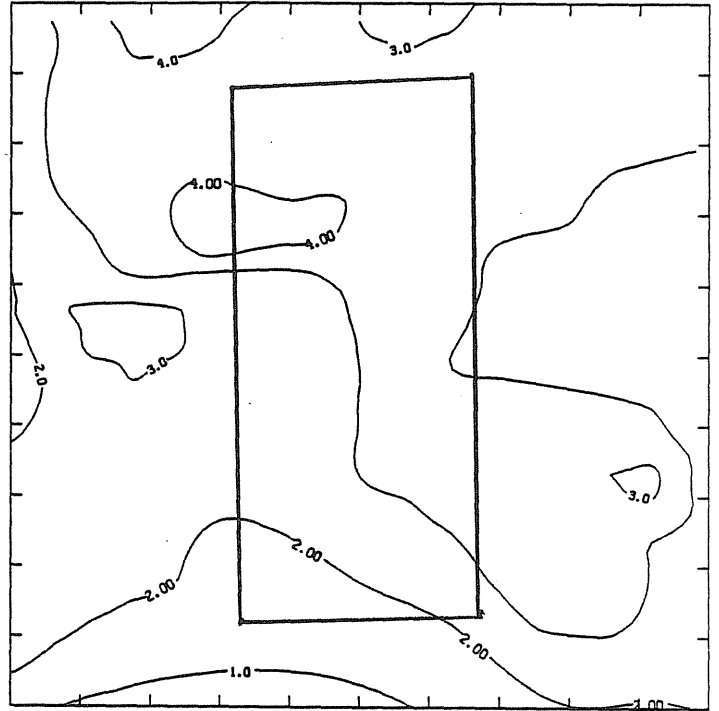

CNTR FRM 0.0000E+00 TO 9.0000 CNTR INTVL OF 1.0000
 X INTVL= 0.34811E-04 Y INTVL= 0.78273E-04

RAPPAHANNOCK ALTERNATE RPD

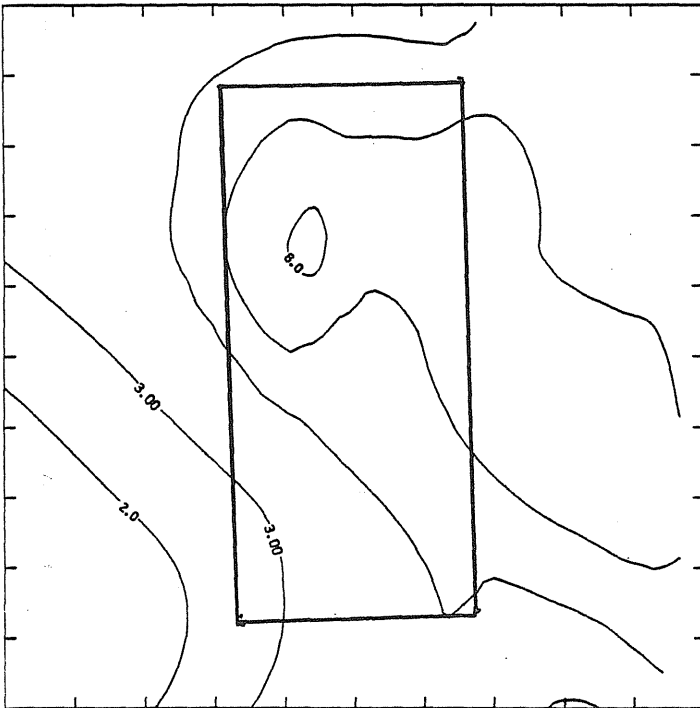

CNTR FRM 0.0000E+00 TO 19.0000 CNTR INTVL OF 1.0000
 X INTVL= 0.33391E-04 Y INTVL= 0.48332E-04

RAPPAHANNOCK ALTERNATE RPD

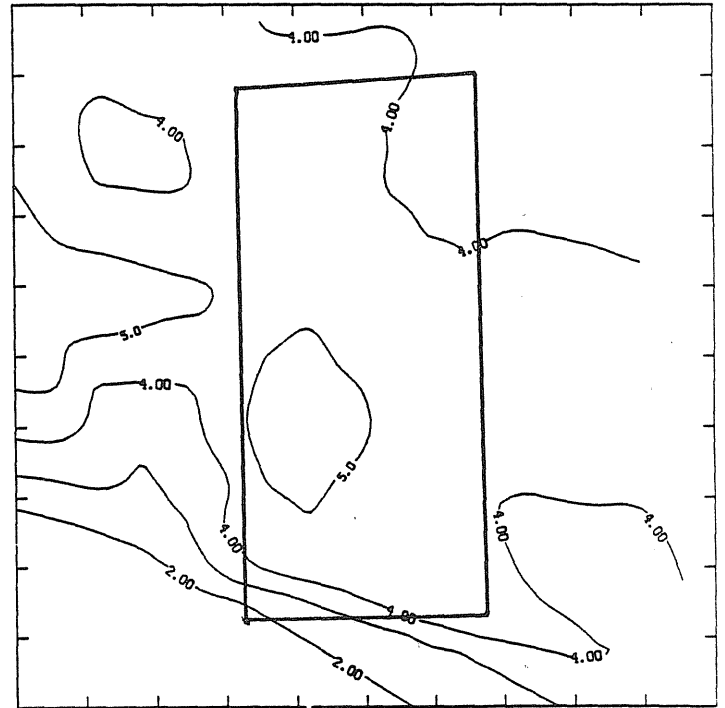

CNTR FRM 0.0000E+00 TO 9.0000 CNTR INTVL OF 1.0000
 X INTVL= 0.33488E-04 Y INTVL= 0.77844E-04

Figure V-31. Frequency distributions of the percentage areal cover of each 1 cm RPD contour interval at the Rappahannock Alternate Site.

FEBRUARY

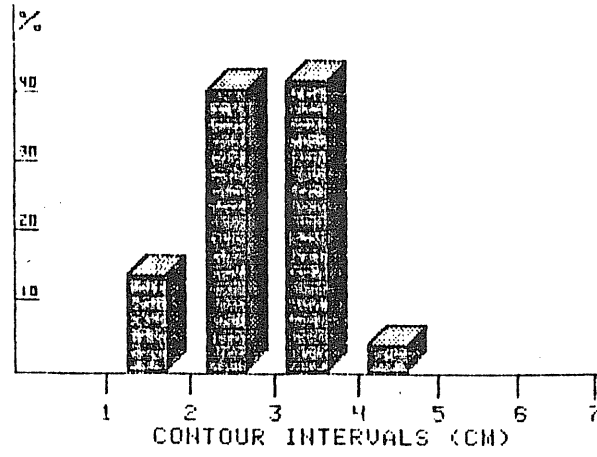

MAY

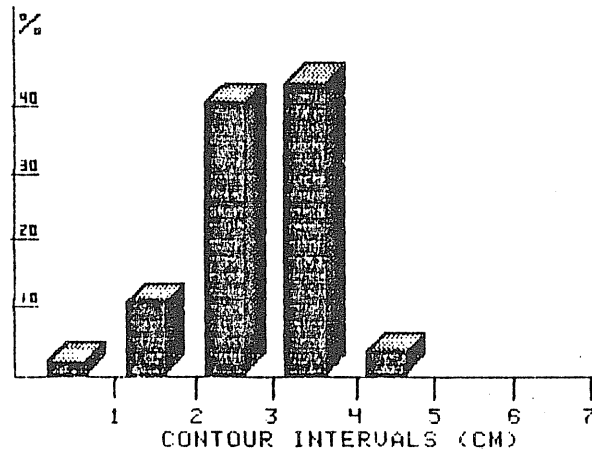

AUGUST

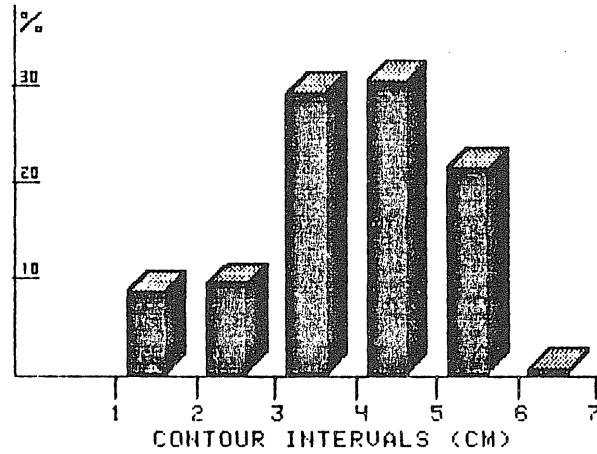

OCTOBER

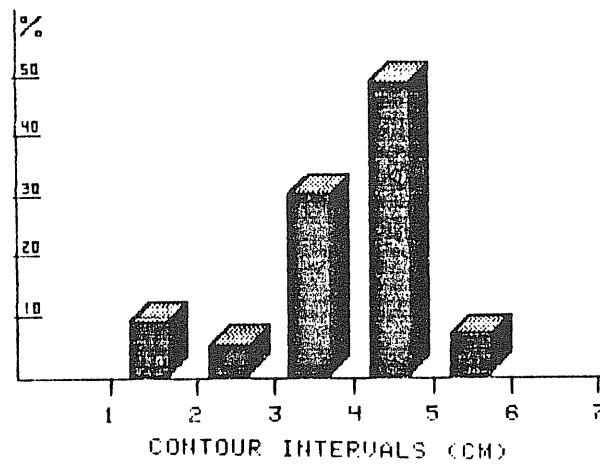
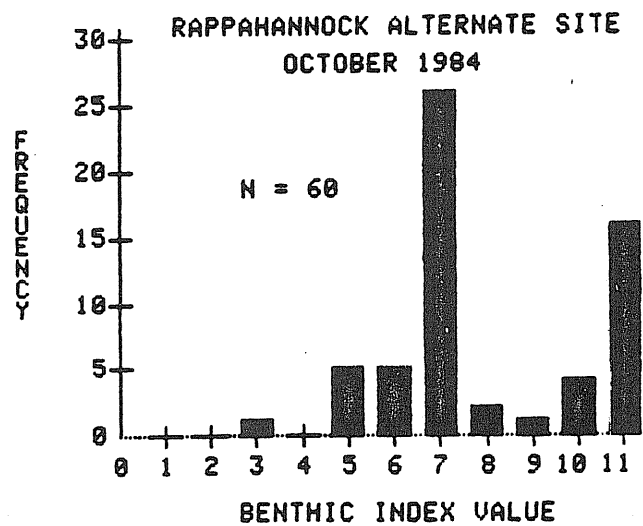
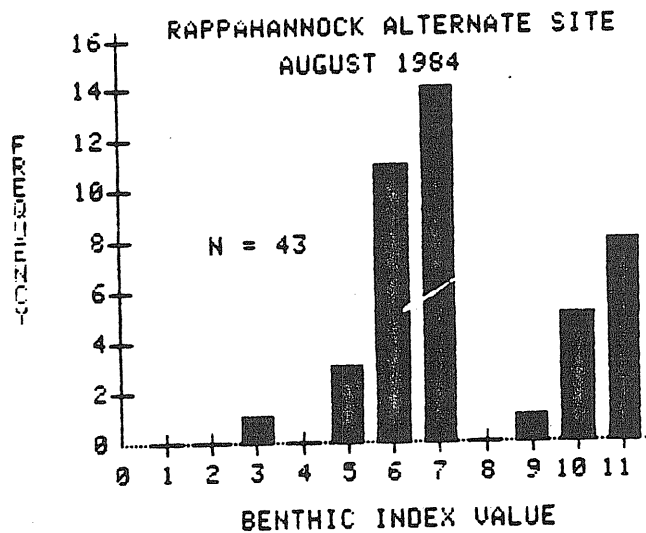
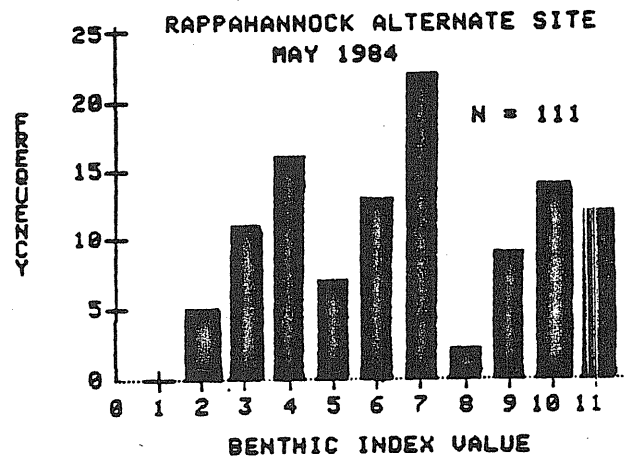
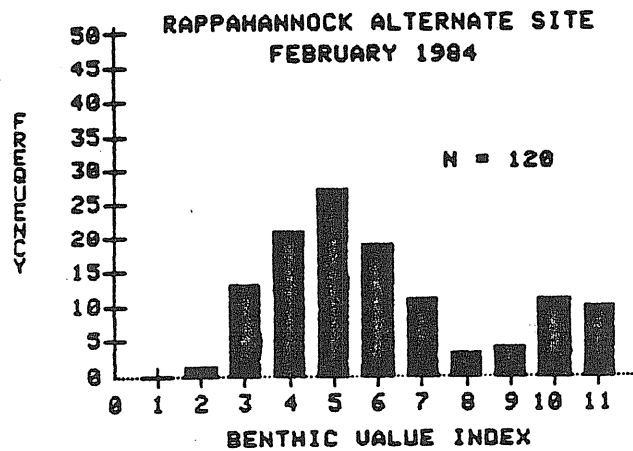

Figure V-32. Frequency distributions of benthic index values at the Rappahannock Alternate Site. Note scale differences on the Y axis between graphs.



NOTE: Contour Interval in % Sand Fraction
0-5 cm horizon.

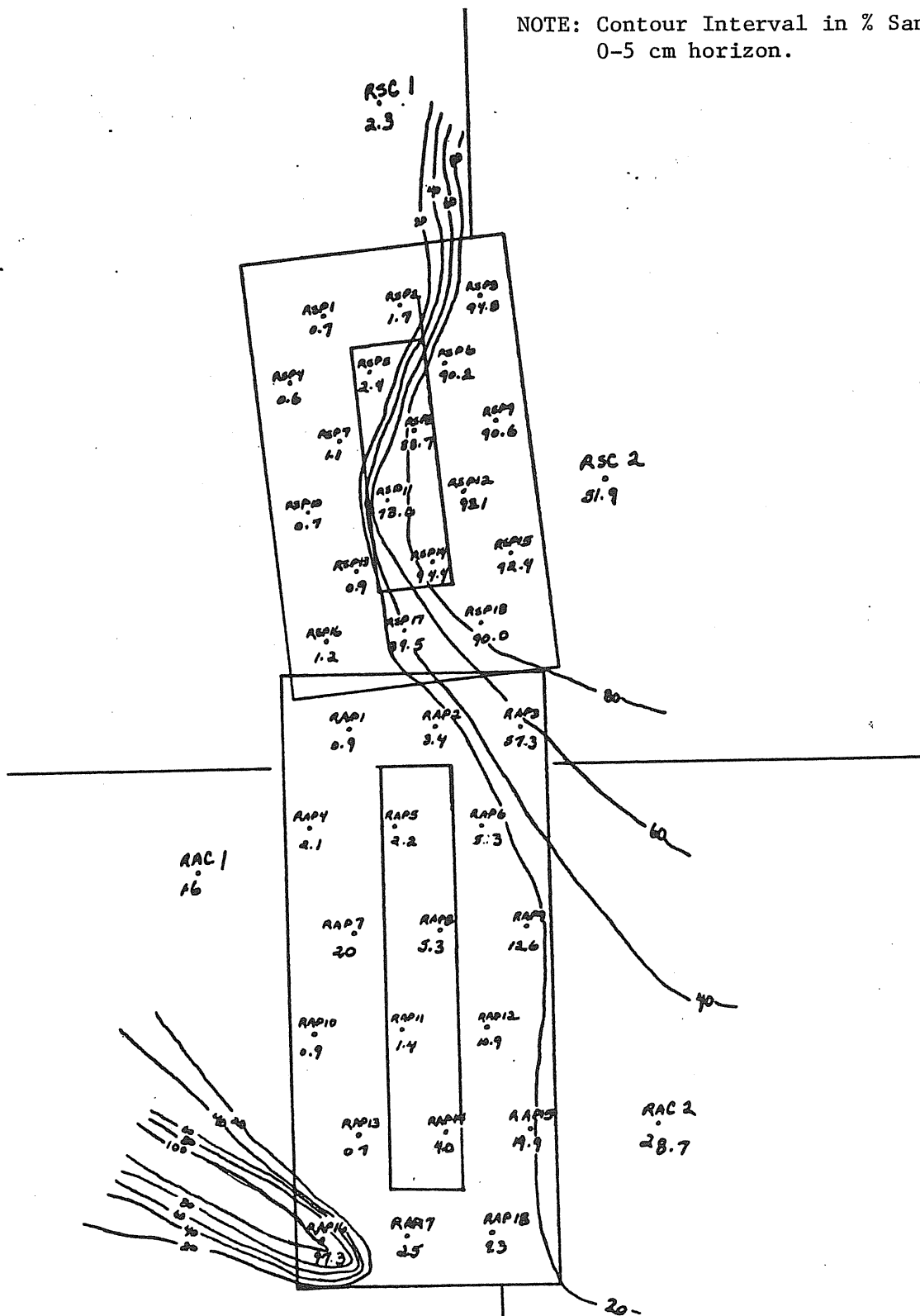

Figure V-33. The distribution of sand in surface sediments in the Rappahannock Shoals study region during February 1984.

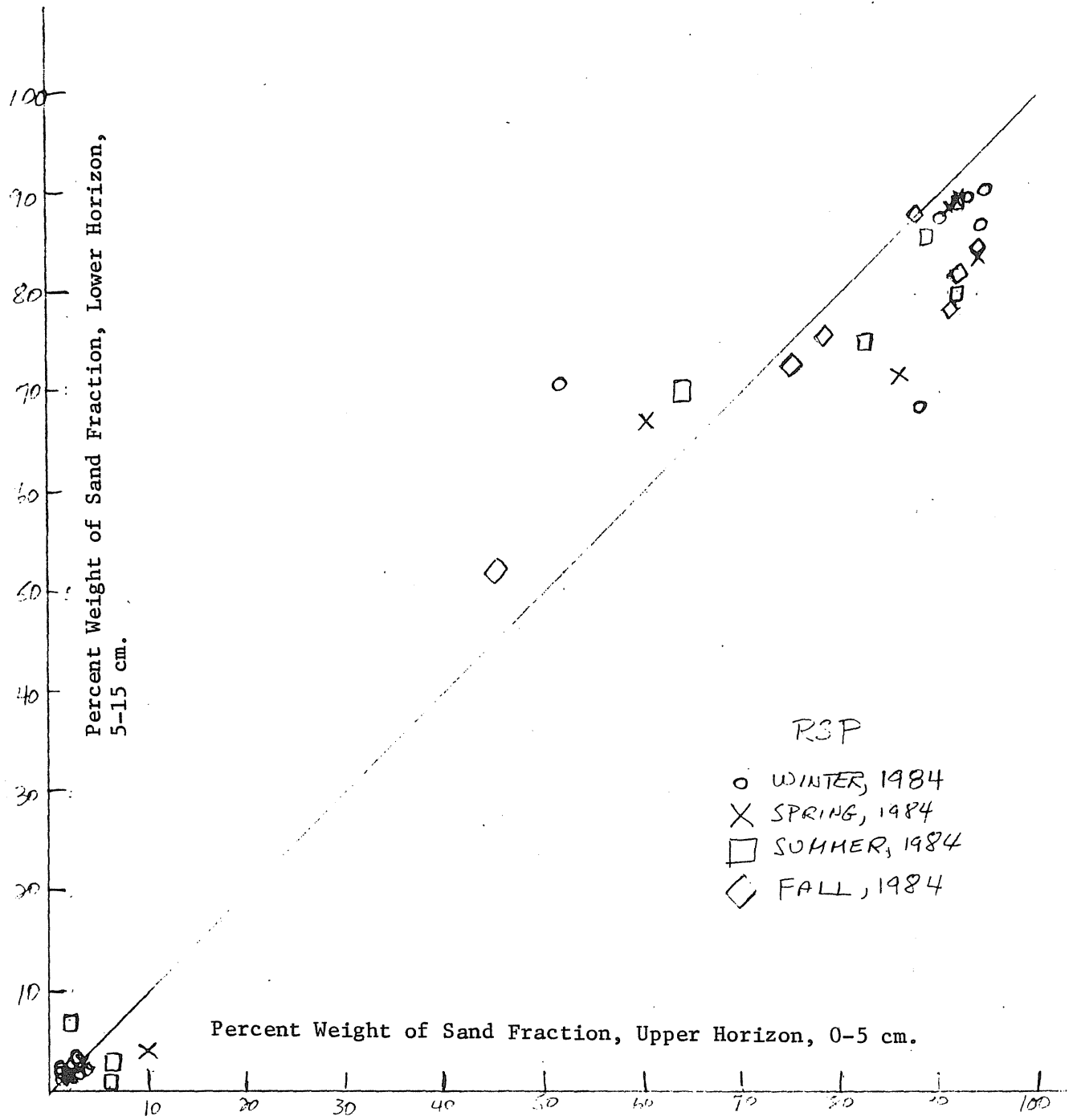

Figure V-34. Rappahannock Primary Disposal Area. Plot of percent weight sand in upper and lower horizons.

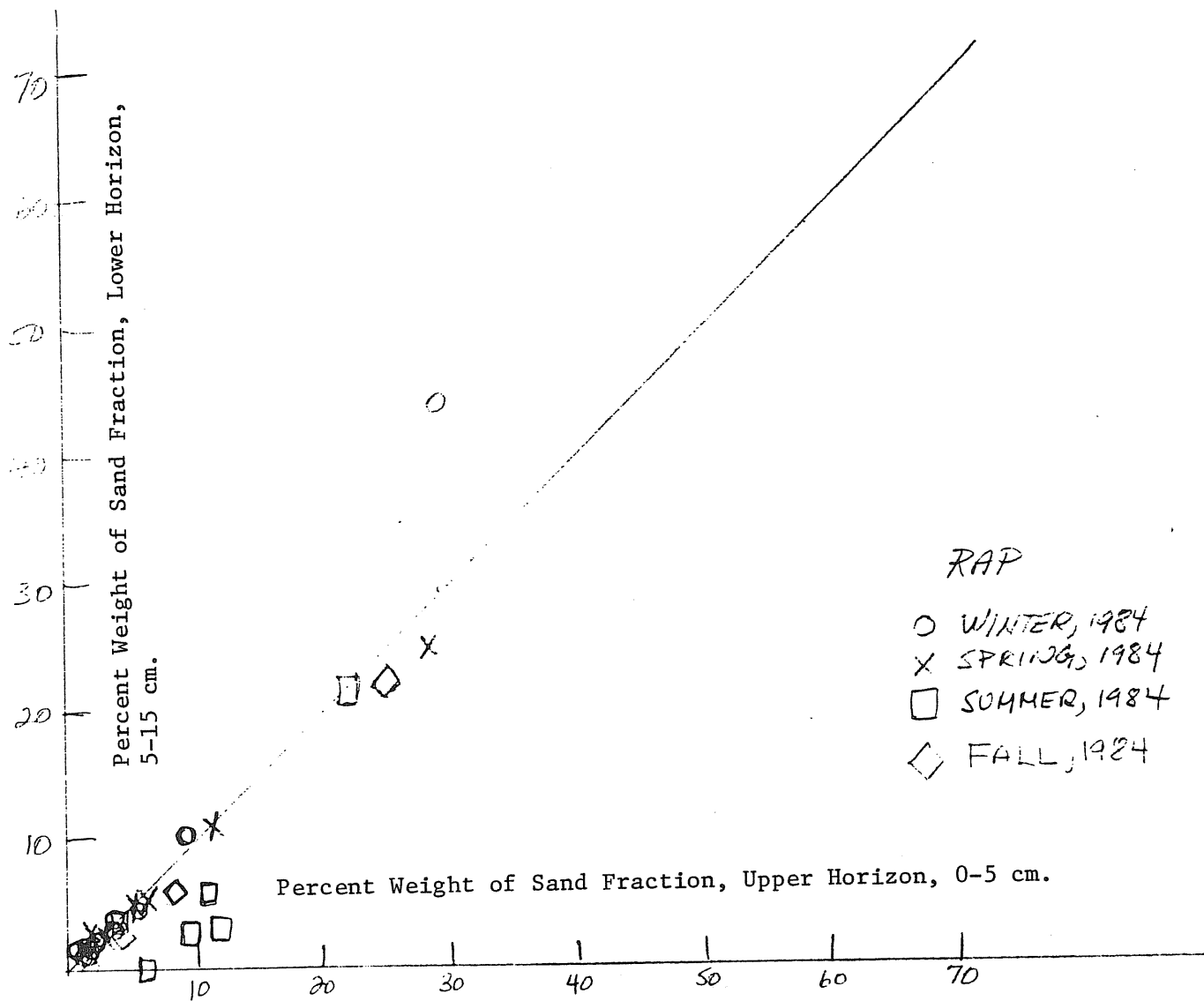

Figure V-35. Rappahannock Alternate Disposal Area. Plot of percent weight sand in upper and lower horizons.

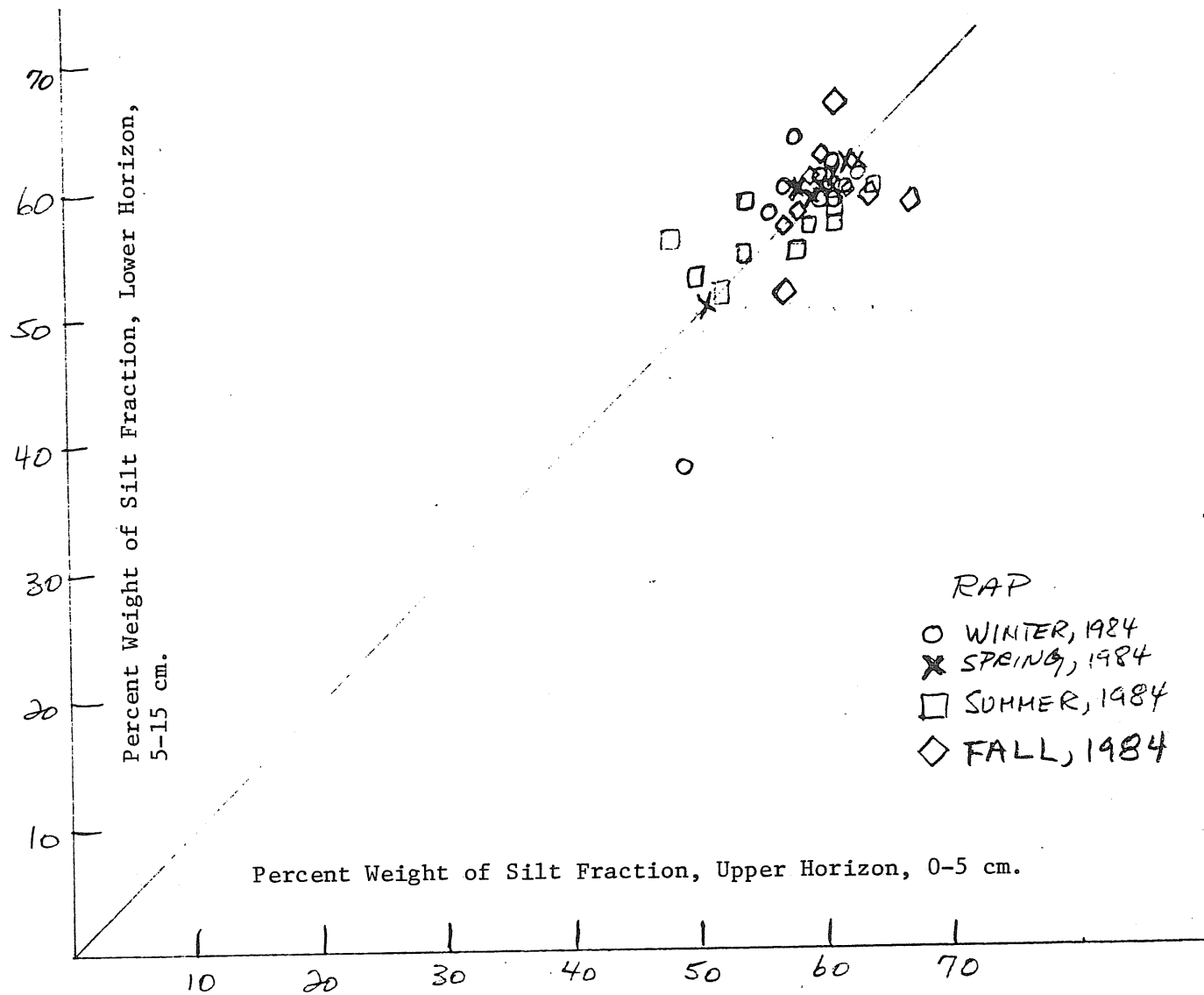

Figure V-36. Rappahannock Alternate Disposal Area. Plot of percent weight silt in upper and lower horizons.

Table V-1. Mean abundance of dominants from the Rappahannock Study region by season per 0.12 m².

Species	Winter '85	Spring '85	Summer '85	Fall '85
Number of Stations	40	21	21	21
<u>Pseudeurythoe paucibranchiata</u>	8.5	48.1	31.5	44.5
<u>Sigambra tentaculata</u>	9.8	3.8	7.6	8.0
<u>Paraprionospio pinnata</u>	91.8	87.7	23.1	93.0
<u>Glycinde solitaria</u>	5.8	3.4	1.8	11.2
<u>Nereis succinea</u>	2.8	1.2	0.7	8.8
<u>Mediomastus ambiseta</u>	9.2	15.7	0.3	0.6
<u>Eteone heteropoda</u>	1.1	4.7	0.2	0.0
<u>Scoloplos fragilis</u>	1.5	3.3	7.1	1.9
<u>Ampelisca abdita</u>	16.0	12.6	0.4	2.8
<u>Listriella barnardi</u>	1.5	0.8	0.0	0.0
<u>Mulinia lateralis</u>	7.1	84.2	20.8	0.1
<u>Acteocina canaliculata</u>	17.3	15.1	1.1	2.7
<u>Sayella</u>	16.0	39.0	2.0	13.4
<u>Phoronis</u>	14.8	13.1	11.3	22.0
<u>Pelecypoda</u>	10.7	0.6	0.2	0.1
<u>Oligochaeta</u>	1.0	2.4	0.3	0.0
<u>Sertularia argentea</u>	0.4	0.8	0.7	1.0
<u>Acteon punctostriatus</u>	1.0	0.0	0.3	2.1
<u>Clymenella zonalis</u>	4.2	0.5	0.7	0.3
<u>Clymenella torquata</u>	1.6	1.7	3.2	3.5
<u>Glycera americana</u>	2.9	2.0	0.7	0.1
<u>Loimia medusa</u>	2.9	2.5	0.5	1.1
<u>Nephtys picta</u>	6.1	9.6	9.6	3.3
<u>Cistena gouldii</u>	12.8	10.8	0.8	2.4
<u>Bhawania goodei</u>	0.7	0.3	1.5	1.1
<u>Nephtyidae</u>	18.7	5.0	0.0	0.5
<u>Asychis elongata</u>	0.8	0.4	0.1	0.6
<u>Polydora ligni</u>	4.1	24.5	0.1	0.5
<u>Leucon americanus</u>	1.1	1.6	0.1	0.2
<u>Macoma tenta</u>	6.4	9.7	3.3	0.4
<u>Macoma</u>	2.9	1.7	0.4	0.5
<u>Anadara transversa</u>	2.4	0.1	0.0	0.0
<u>Lucina multilineata</u>	1.1	1.1	0.5	0.7
<u>Lyonsia hyalina</u>	4.9	37.2	0.0	0.0
<u>Turbonilla interrupta</u>	0.6	1.1	0.1	1.7
<u>Polycladia</u>	1.4	0.8	0.2	1.2
<u>Edwardsia</u>	1.5	1.6	0.0	0.0
<u>Tubulanus pellucidus</u>	1.6	0.5	0.6	0.8
<u>Gyptis brevipalpa</u>	1.4	0.8	0.5	1.7
<u>Melinna maculata</u>	1.2	0.5	1.0	0.5
<u>Oxyurostylis smithi</u>	1.2	0.1	0.0	0.0
<u>Cirratulidae</u>	1.7	1.0	6.3	2.7
<u>Streblospio benedicti</u>	0.6	2.2	0.7	1.7
<u>Glycera dibranchiata</u>	1.1	1.4	0.7	0.8

Table V-2. Average abundance of dominant species from the Rappahannock Study region for all cruises.

Species Number of Stations	RS			RA			Grand Mean 103
	Disposal 13	Fringe 32	Control 8	Disposal 16	Fringe 26	Control 8	
<u>Pseudeurythoe paucibranchiata</u>	102.2	41.9	14.9	1.8	3.9	3.4	28.6
<u>Sigambra tentaculata</u>	6.8	6.2	8.6	12.4	7.6	5.6	7.7
<u>Paraprionospio pinnata</u>	57.4	71.8	85.2	92.6	79.4	85.2	77.2
<u>Glycinde solitaria</u>	4.7	5.2	5.9	6.1	6.9	3.9	5.6
<u>Nereis succinea</u>	4.2	3.3	4.5	2.1	2.6	7.1	3.4
<u>Mediomastus ambiseta</u>	5.2	9.2	2.5	6.8	8.1	1.6	6.9
<u>Eteone heteropoda</u>	1.2	2.0	1.2	1.8	0.7	1.1	1.4
<u>Scoloplos fragilis</u>	1.2	2.0	4.1	7.4	3.0	1.2	3.1
<u>Ampelisca abdita</u>	13.5	13.7	7.0	4.2	6.2	9.0	9.4
<u>Listriella barnardi</u>	0.7	0.4	0.1	0.4	1.2	2.0	0.7
<u>Mulinia lateralis</u>	65.2	30.5	8.0	6.6	8.4	35.0	24.2
<u>Acteocina canaliculata</u>	9.2	8.1	6.5	10.7	16.2	8.1	10.6
<u>Sayella</u>	10.5	32.1	7.9	13.4	9.1	13.6	17.3
<u>Phoronis</u>	30.3	28.1	0.6	6.3	5.2	4.4	15.2
<u>Pelecypoda</u>	9.7	9.5	0.8	0.0	0.3	0.2	4.3
<u>Oligochaeta</u>	2.9	1.2	0.9	0.1	0.3	0.2	0.9
<u>Sertularia argentea</u>	0.8	1.0	0.8	0.1	0.6	0.5	0.7
<u>Acteon punctostriatus</u>	1.1	0.7	0.5	1.1	1.1	0.2	0.9
<u>Clymenella zonalis</u>	0.5	0.5	0.0	0.0	5.6	3.9	1.9
<u>Clymenella torquata</u>	6.9	3.8	1.9	0.0	0.5	0.4	2.3
<u>Glycera americana</u>	1.2	1.6	1.6	1.6	2.3	0.6	1.7
<u>Loimia medusa</u>	1.0	1.9	1.6	0.8	2.5	4.6	2.0
<u>Nephtys picta</u>	19.8	6.5	3.2	1.4	4.6	10.4	7.0
<u>Cistena gouldii</u>	9.2	7.9	10.4	5.9	8.8	3.8	7.8
<u>Bhawania goodei</u>	1.8	0.8	0.4	0.0	1.3	0.4	0.9
<u>Nephtyidae</u>	12.5	13.5	2.5	1.3	7.9	2.6	8.4
<u>Asychis elongata</u>	1.1	0.6	0.2	0.2	0.6	0.1	0.5
<u>Polydora ligni</u>	27.9	7.2	2.8	0.2	1.1	5.5	6.7
<u>Leucon americanus</u>	0.2	0.1	0.8	0.9	2.2	0.5	0.8
<u>Macoma tenta</u>	11.9	6.3	1.1	1.6	2.6	9.6	5.2
<u>Macoma</u>	0.5	2.8	0.0	0.1	2.5	0.8	1.6

Table V-2 (continued)

Species Number of Stations	RS			RA			Grand Mean 103
	Disposal 13	Fringe 32	Control 8	Disposal 16	Fringe 26	Control 8	
<u>Anadara transversa</u>	6.0	0.9	0.1	0.0	0.1	0.4	1.1
<u>Lucina multilineata</u>	1.5	1.9	0.0	0.1	0.4	0.2	0.9
<u>Lyonsia hyalina</u>	30.5	13.1	8.4	0.1	1.0	8.2	9.5
<u>Turbonilla interrupta</u>	1.5	3.0	0.0	0.2	0.8	1.8	0.8
<u>Polycladia</u>	1.4	1.4	2.0	0.2	0.6	0.5	1.0
<u>Edwardsia</u>	1.5	1.3	0.0	0.8	0.6	0.6	0.9
<u>Tubulanus pellucidus</u>	1.2	0.9	0.9	1.2	0.9	0.8	1.0
<u>Gyptis brevipalpa</u>	2.7	1.4	1.2	0.2	1.0	0.2	1.2
<u>Melinna maculata</u>	1.0	1.9	0.0	0.2	0.4	0.0	0.8
<u>Oxyurostylis smithi</u>	0.6	1.0	0.1	0.0	0.3	0.0	0.5
<u>Cirratulidae</u>	12.3	3.3	0.2	0.0	0.3	0.0	2.7
<u>Streblospio benedicti</u>	2.5	1.6	2.8	0.1	0.5	0.0	1.2
<u>Glycera dibranchiata</u>	1.2	2.4	0.1	0.0	0.0	0.0	1.0

Table V-3. Community structure parameters for the Rappahannock Shoals Study Region.

STATION	NUMBER OF		SHANNON FORMULA	
	INDIV	SPEC	H-PRIME	EVENNESS-JPR
RAC012	169	15	2.7813	0.7119
RAC013	138	9	2.2946	0.7239
RAC014	34	6	1.8981	0.7343
RAC015	82	7	1.9106	0.6806
RAC022	332	38	3.8136	0.7267
RAC023	620	29	3.7865	0.7794
RAC024	174	19	3.4528	0.8128
RAC025	416	16	2.1864	0.5466
RAP012	234	22	2.8773	0.6452
RAP013	182	16	2.9092	0.7273
RAP014	90	8	2.5797	0.8599
RAP015	130	12	2.2398	0.6248
RAP022	193	22	3.4225	0.7675
RAP023	334	20	2.2989	0.5319
RAP024	126	10	2.3941	0.7207
RAP025	140	8	1.3531	0.4510
RAP032	626	47	4.0969	0.7376
RAP042	246	25	3.0319	0.6529
RAP052	261	27	2.9259	0.6153
RAP053	168	16	2.7256	0.6814
RAP054	80	6	2.0629	0.7980
RAP055	102	8	1.8934	0.6311
RAP062	204	29	3.6874	0.7590
RAP072	183	20	2.4160	0.5590
RAP082	219	28	3.3174	0.6901
RAP083	184	21	3.1216	0.7107
RAP084	128	6	1.9602	0.7583
RAP085	304	17	2.1114	0.5165
RAP092	221	38	4.1882	0.7981
RAP102	185	18	2.6479	0.6350
RAP112	195	26	3.4445	0.7328
RAP113	148	17	3.3155	0.8111
RAP114	68	6	2.0843	0.8063
RAP115	240	14	2.2541	0.5920
RAP122	172	29	3.8358	0.7896
RAP132	171	24	3.1635	0.6900
RAP133	118	8	2.4779	0.8260
RAP134	66	8	2.2382	0.7461
RAP135	54	9	2.9221	0.9218
RAP142	253	30	3.7396	0.7621
RAP143	266	18	3.1504	0.7555
RAP144	100	6	1.7148	0.6634
RAP145	426	15	1.9370	0.4958

Table V-3 (continued)

STATION	NUMBER OF		SHANNON FORMULA	
	INDIV	SPEC	H-PRIME	EVENNESS-JPR
RAP152	376	40	3.6030	0.6770
RAP162	304	20	2.4764	0.5730
RAP172	230	33	3.6975	0.7330
RAP182	443	45	3.8824	0.7069
RAP183	392	31	3.7617	0.7593
RAP184	184	11	2.5764	0.7448
RAP185	300	20	1.9258	0.4456
RSC012	381	21	1.4231	0.3240
RSC013	42	5	1.5324	0.6600
RSC014	20	3	0.9219	0.5817
RSC015	90	8	2.5745	0.8582
RSC022	241	41	4.0959	0.7645
RSC023	370	28	3.9149	0.8144
RSC024	178	21	3.4336	0.7817
RSC025	466	26	3.2192	0.6849
RSP012	195	19	2.4281	0.5716
RSP022	296	22	2.3222	0.5207
RSP023	26	8	2.7774	0.9258
RSP024	4	2	1.0000	1.0000
RSP025	86	14	2.9901	0.7853
RSP032	463	56	4.8876	0.8416
RSP033	600	35	3.9301	0.7662
RSP034	288	18	2.3308	0.5590
RSP035	428	30	2.9431	0.5998
RSP042	213	20	2.6770	0.6194
RSP052	376	27	1.4980	0.3151
RSP053	310	14	2.1714	0.5703
RSP054	12	4	1.9183	0.9591
RSP055	194	11	2.1505	0.6216
RSP062	475	49	4.2516	0.7572
RSP072	715	29	2.2300	0.4590
RSP073	1214	26	2.3825	0.5069
RSP074	6	3	1.5850	1.0000
RSP075	50	4	1.3542	0.6771
RSP082	436	58	4.7792	0.8159
RSP083	2184	47	3.1521	0.5675
RSP084	526	23	2.9963	0.6624
RSP085	442	33	2.7212	0.5395
RSP092	470	40	3.9227	0.7371
RSP102	127	21	3.0198	0.6875
RSP112	724	44	4.2315	0.7751
RSP122	573	53	4.4205	0.7718
RSP123	650	39	3.8878	0.7356
RSP124	324	29	3.3082	0.6810
RSP125	410	33	2.9909	0.5929
RSP132	397	26	2.5701	0.5468

Table V-3 (continued)

STATION	NUMBER OF		SHANNON FORMULA	
	INDIV	SPEC	H-PRIME	EVENNESS-JPR
RSP133	1154	26	3.0146	0.6414
RSP134	70	4	1.3917	0.6958
RSP135	162	7	1.5321	0.5457
RSP142	431	47	4.1129	0.7405
RSP143	392	34	3.9348	0.7734
RSP144	278	16	2.9816	0.7454
RSP145	452	31	3.6652	0.7398
RSP152	394	58	4.6067	0.7864
RSP162	304	35	3.5671	0.6954
RSP172	441	27	3.3930	0.7136
RSP182	342	42	3.8834	0.7202
RSP183	724	37	4.1488	0.7964
RSP184	334	25	3.4143	0.7352
RSP185	426	26	3.1808	0.6767

Table V-4. Summary statistics and ANOVA results for boundary roughness, mean RPD depth, and benthic index values at the Rappahannock Shoals Site for all surveys.

PARAMETER	MONTH	N	MEAN	S.D.	BOUNDARY ROUGHNESS ANOVA				
					SOURCE	SS	DF	MS	F
BOUNDARY ROUGHNESS	FEB	120	.65	.42	BR	30.06	3	10.02	18.40
	MAY	117	.59	.39	ERROR	220.00	404	.54	
	AUG	76	1.28	.92	-----				
	OCT	95	.99	1.12	BR	P < .001			
					SCHEFFE TEST ON ANOVA RESULTS:				
						MAY	AUG	OCT	
					FEB	NS	**	**	**
					MAY		**	**	**
					AUG				NS

PARAMETER	MONTH	N	MEAN	S.D.	RPD ANOVA				
					SOURCE	SS	DF	MS	F
MEAN RPD DEPTH	FEB	88	3.31	1.56	RPD	57.19	3	19.06	4.84
	MAY	68	2.28	1.86	ERROR	1275.19	323	3.95	
	AUG	76	2.98	2.40	-----				
	OCT	95	3.32	2.06	RPD	P = .003			
					SCHEFFE TEST ON ANOVA RESULTS:				
						MAY	AUG	OCT	
					FEB	**	NS	NS	NS
					MAY		NS	**	**
					AUG				NS

PARAMETER	MONTH	N	MEAN	S.D.	BENTHIC INDEX ANOVA				
					SOURCE	SS	DF	MS	F
BENTHIC INDEX	FEB	88	5.66	1.77	BI	38.27	31	12.76	.95
	MAY	67	5.76	3.56	ERROR	4135.28	308	13.43	
	AUG	75	5.08	5.57	-----				
	OCT	82	6.05	3.00	BI	P = .6407			

Table V-5. Summary statistics and ANOVA results for boundary roughness, mean RPD depth, and benthic index values at the Rappahannock Alternate Site for all surveys.

PARAMETER	MONTH	N	MEAN	S.D.	BOUNDARY ROUGHNESS ANOVA				
					SOURCE	SS	DF	MS	F
BOUNDARY ROUGHNESS	FEB	120	.58	.42	BR	123.27	3	41.09	78.03
	MAY	120	.57	.45	ERROR	185.36	352	.53	
	AUG	46	1.96	1.90	-----				
	OCT	70	1.70	1.12	BR	P < .001			
					SCHEFFE TEST ON ANOVA RESULTS:				
						MAY	AUG	OCT	
					FEB	NS	**	**	
					MAY		**	**	
					AUG			NS	

PARAMETER	MONTH	N	MEAN	S.D.	RPD ANOVA				
					SOURCE	SS	DF	MS	F
MEAN RPD DEPTH	FEB	105	2.93	1.06	RPD	57.19	3	19.06	4.84
	MAY	111	2.84	1.27	ERROR	1275.19	323	3.95	
	AUG	43	4.10	1.26	-----				
	OCT	63	4.19	1.19	RPD	P < .001			
					SCHEFFE TEST ON ANOVA RESULTS:				
						MAY	AUG	OCT	
					FEB	NS	**	**	
					MAY		**	**	
					AUG			NS	

PARAMETER	MONTH	N	MEAN	S.D.	BENTHIC INDEX ANOVA				
					SOURCE	SS	DF	MS	F
BENTHIC INDEX	FEB	105	6.30	2.39	BI	132.77	3	44.26	7.33
	MAY	111	6.69	2.75	ERROR	1902.18	315	6.04	
	AUG	43	7.65	2.17	-----				
	OCT	60	8.02	2.17	BI	P < .001			
					SCHEFFE TEST ON ANOVA RESULTS:				
						MAY	AUG	OCT	
					FEB	NS	**	**	
					MAY		NS	**	
					AUG			NS	

Table V-6. Weight percent of gravel, sand, silt, and clay; by station

RAPPAHANNOCK SHOALS

	Winter 1984	Spring 1984	Summer 1984	Fall 1984
RSC 01 (0/5)				
G	0.0	0.0	0.0	0.0
S	2.3	10.0	1.6	1.3
S1	49.5	38.3	42.4	40.1
C	48.2	51.6	56.0	58.6
RSC 01 (5/15)				
G	1.6	0.0	0.0	0.0
S	1.9	4.2	0.8	1.2
S1	45.4	44.8	38.4	39.8
C	51.0	50.9	60.8	58.9
RSC 02 (0/5)				
G	0.0	0.0	0.1	0.0
S	51.9	60.5	63.6	75.2
S1	26.7	19.4	20.5	16.6
C	21.4	20.1	15.8	8.2
RSC 02 (5/15)				
G	0.05	0.0	0.0	0.0
S	71.4	67.5	70.3	73.2
S1	15.9	15.6	16.3	13.5
C	12.7	16.8	13.3	13.3
RSP 01 (0/5)				
G	0.0			
S	0.7			
S1	46.2			
C	53.2			
RSP 01 (5/15)				
G	0.0			
S	0.8			
S1	48.1			
C	51.1			

	Winter 1984	Spring 1984	Summer 1984	Fall 1984
RSP 02 (0/5)				
G	0.0	0.0	0.0	0.0
S	1.7	2.0	1.9	0.5
S1	43.5	43.2	52.8	40.9
C	54.8	54.7	45.3	58.6

RSP 02 (5/15)				
G	0.0	0.0	0.3	0.0
S	1.7	1.2	6.5	0.5
S1	43.7	52.5	53.3	38.2
C	54.6	46.2	39.9	61.3

RSP 03 (0/5)				
G	0.2	0.4	0.4	0.1
S	94.8	91.1	92.5	87.6
S1	0.9	3.4	2.3	4.9
C	4.0	5.0	4.8	7.3

RSP 03 (5/15)				
G	0.2	0.0	0.3	0.0
S	90.7	88.5	89.3	88.2
S1	3.7	4.3	3.9	5.0
C	5.4	7.2	6.5	6.7

RSP 04 (0/5)				
G	0.0			
S	0.6			
S1	49.6			
C	49.7			

RSP 04 (5/15)				
G	0.0			
S	0.7			
S1	46.6			
C	52.7			

	Winter 1984	Spring 1984	Summer 1984	Fall 1984
RSP 05 (0/5)				
G	0.0	0.0	0.0	0.0
S	2.4	3.0	6.2	3.0
S1	52.0	51.4	62.5	45.2
C	45.6	45.6	31.3	51.8
RSP 05 (5/15)				
G	0.0	0.2	0.0	0.0
S	3.0	2.7	2.8	3.6
S1	54.4	51.1	42.2	52.5
C	42.7	46.0	55.0	43.9
RSP 06 (0/5)				
G	0.3			
S	90.3			
S1	4.7			
C	4.8			
RSP 06 (5/15)				
G	0.2			
S	86.4			
S1	6.1			
C	7.2			
RSP 07 (0/5)				
G	0.0	0.0	0.0	0.0
S	1.1	1.6	6.0	0.6
S1	50.1	53.4	61.8	46.1
C	48.8	45.0	32.2	53.3
RSP 07 (5/15)				
G	0.0	0.3	0.0	0.0
S	1.8	1.3	0.9	1.5
S1	52.0	52.0	38.3	47.2
C	46.2	46.3	60.8	51.3

	Winter 1984	Spring 1984	Summer 1984	Fall 1984
RSP 08 (0/5)				
G	1.0	1.7	2.6	6.5
S	88.7	86.6	82.8	78.4
S1	3.8	6.0	7.6	6.5
C	6.5	5.7	7.1	8.6

RSP 08 (5/15)				
G	1.9	1.1	1.6	1.2
S	68.7	72.1	75.2	75.9
S1	17.1	13.0	11.7	12.6
C	12.3	13.8	11.5	10.4

RSP 09 (0/5)	
G	0.0
S	90.6
S1	4.5
C	4.9

RSP 09 (5/15)	
G	0.0
S	88.3
S1	5.6
C	6.1

RSP 10 (0/5)	
G	0.0
S	0.7
S1	50.6
C	48.8

RSP 10 (5/15)	
G	0.0
S	0.6
S1	52.2
C	47.2

	Winter 1984	Spring 1984	Summer 1984	Fall 1984
RSP 11 (0/5)				
G	0.6			
S	73.0			
S1	14.5			
C	12.0			
RSP 11 (5/15)				
G	0.0			
S	56.0			
S1	26.8			
C	17.2			
RSP 12 (0/5)				
G	0.2	0.4	0.4	0.2
S	93.1	92.4	89.2	92.9
S1	3.0	3.3	4.9	3.3
C	3.6	3.9	5.5	3.6
RSP 12 (5/15)				
G	0.2	0.1	0.1	0.2
S	90.2	90.8	86.8	82.6
S1	4.3	3.6	5.7	6.9
C	5.3	5.5	7.3	10.2
RSP 13 (0/5)				
G	0.0	0.0	0.2	0.2
S	0.9	1.8	1.3	3.2
S1	53.8	50.8	53.1	53.7
C	45.3	47.4	45.4	43.0
RSP 13 (5/15)				
G	0.0	0.0	0.0	0.0
S	1.7	1.7	1.3	2.1
S1	58.1	57.7	60.3	57.4
C	40.2	40.6	38.4	40.4

	Winter 1984	Spring 1984	Summer 1984	Fall 1984
RSP 14 (0/5)				
G	0.0	0.0	0.0	0.1
S	94.4	94.2	88.9	90.9
S1	2.5	2.0	5.0	3.6
C	3.1	3.8	6.1	5.4

RSP 14 (5/15)				
G	0.0	0.0	0.1	0.0
S	87.0	84.4	86.0	78.9
S1	6.6	7.3	6.4	11.0
C	6.4	8.3	7.4	10.1

RSP 15 (0/5)	
G	0.0
S	92.4
S1	3.8
C	3.7

RSP 15 (5/15)	
G	0.1
S	91.3
S1	3.8
C	4.7

RSP 16 (0/5)		
G	0.0	0.0
S	1.2	1.6
S1	55.8	61.2
C	43.1	37.2

RSP 16 (5/15)		
G	0.0	0.0
S	0.9	1.6
S1	56.6	58.6
C	42.5	39.8

	Winter 1984	Spring 1984	Summer 1984	Fall 1984
RSP 17 (0/5)				
G	0.0			
S	39.5			
S1	35.8			
C	24.7			
RSP 17 (5/15)				
G	0.1			
S	56.9			
S1	25.6			
C	17.4			
RSP 18 (0/5)				
G	0.1	0.0	0.2	0.1
S	90.0	84.8	92.1	93.7
S1	5.5	8.1	2.0	1.4
C	4.4	7.2	5.7	4.8
RSP 18 (5/15)				
G	0.0	0.1	0.0	0.0
S	88.3	91.1	80.2	85.3
S1	6.5	3.8	8.7	5.9
C	5.2	4.9	11.0	8.8

RAPPAHANNOCK SHOALS ALTERNATE

	WINTER 1984	Spring 1984	Summer 1984	Fall 1984
RAC 01 (0/5)				
G	0.0	0.0	0.0	0.0
S	1.6	1.7	0.2	2.6
S1	60.0	61.1	48.0	66.6
C	38.3	37.1	51.8	30.8
RAC 01 (5/15)				
G	0.0	0.0	0.6	0.0
S	1.6	1.4	1.6	1.3
S1	59.0	61.1	56.4	59.0
C	39.5	37.4	41.4	39.7
RAC 02 (0/5)				
G	0.0	0.0	0.2	0.1
S	28.7	28.3	22.6	24.9
S1	49.1	50.9	52.3	56.8
C	22.2	20.8	24.9	18.2
RAC 02 (5/15)				
G	0.0	0.1	0.0	0.0
S	44.2	25.1	22.0	22.6
S1	37.7	50.9	51.7	52.4
C	18.1	23.9	26.3	25.0
RAP 01 (0/5)				
G	0.0	0.0	0.2	0.0
S	0.9	1.2	12.0	0.9
S1	55.6	59.3	61.1	56.3
C	43.5	39.5	26.6	42.8
RAP 01 (5/15)				
G	0.0	0.0	0.0	0.0
S	1.0	0.9	3.4	0.7
S1	57.9	59.6	58.0	55.9
C	41.1	39.5	38.6	43.4

	Winter 1984	Spring 1984	Summer 1984	Fall 1984
RAP 02 (0/5)				
G	0.0	0.0	0.0	0.0
S	3.4	1.9	9.5	2.0
S1	58.1	57.9	60.6	58.9
C	38.5	40.2	29.8	39.1

RAP 02 (5/15)				
G	0.0	0.0	0.0	0.1
S	3.1	2.5	2.4	3.3
S1	63.6	59.7	57.3	61.1
C	33.4	37.7	40.3	35.5

RAP 03 (0/5)	
G	0.1
S	57.3
S1	27.4
C	15.2

RAP 03 (5/15)	
G	0.1
S	30.7
S1	39.4
C	29.8

RAP 04 (0/5)	
G	0.0
S	2.1
S1	63.3
C	34.6

RAP 04 (5/15)	
G	0.1
S	1.6
S1	61.9
C	36.4

	Winter 1984	Spring 1984	Summer 1984	Fall 1984
RAP 05 (0/5)				
G	0.0	0.0	0.0	0.0
S	2.2	2.8	2.0	1.7
S1	61.4	62.7	53.5	63.7
C	36.3	34.5	44.5	34.5

RAP 05 (5/15)				
G	0.0	0.1	0.0	0.0
S	2.2	2.4	1.8	1.5
S1	59.4	61.5	55.4	60.3
C	38.3	36.0	42.8	38.2

RAP 06 (0/5)	
G	0.0
S	5.3
S1	60.7
C	34.0

RAP 06 (5/15)	
G	0.0
S	5.6
S1	63.0
C	31.3

RAP 07 (0/5)	
G	0.0
S	2.0
S1	64.5
C	33.5

RAP 07 (5/15)	
G	0.0
S	1.8
S1	62.5
C	35.7

	Winter 1984	Spring 1984	Summer 1984	Fall 1984
RAP 08 (0/5)				
G	0.0	0.0	0.0	0.1
S	5.3	6.0	3.8	4.4
S1	60.0	61.0	57.8	58.2
C	34.7	32.9	38.4	37.3
RAP 08 (5/15)				
G	0.0	0.0	0.0	0.0
S	4.6	5.4	3.7	3.4
S1	61.4	60.2	55.0	57.8
C	33.9	34.5	41.3	38.6
RAP 09 (0/5)				
G	0.0			
S	12.6			
S1	57.5			
C	29.8			
RAP 09 (5/15)				
G	0.0			
S	14.2			
S1	57.8			
C	28.0			
RAP 10 (0/5)				
G	0.0			
S	0.9			
S1	58.7			
C	40.4			
RAP 10 (5/15)				
G	0.0			
S	1.1			
S1	60.3			
C	38.6			

	Winter 1984	Spring 1984	Summer 1984	Fall 1984
RAP 11 (0/5)				
G	0.04	0.0	0.0	0.0
S	1.4	2.2	6.0	1.7
S1	60.6	61.2	53.9	61.7
C	37.9	36.6	40.1	36.6
RAP 11 (5/15)				
G	0.0	0.0	0.0	0.0
S	1.8	2.3	0.4	1.9
S1	62.1	61.4	58.6	60.9
C	36.0	36.3	41.0	37.2
RAP 12 (0/5)				
G	0.0			
S	10.9			
S1	57.3			
C	31.8			
RAP 12 (5/15)				
G	0.0			
S	9.8			
S1	59.5			
C	30.7			
RAP 13 (0/5)				
G	0.0	0.0	0.0	0.0
S	0.7	0.7	1.0	0.7
S1	56.6	57.6	50.0	59.7
C	42.8	41.7	49.0	39.6
RAP 13 (5/15)				
G	0.0	0.0	0.2	0.0
S	1.3	1.1	1.1	1.1
S1	59.9	59.9	53.1	62.5
C	38.9	39.0	45.6	36.4

	Winter 1984	Spring 1984	Summer 1984	Fall 1984
RAP 14 (0/5)				
G	0.0	0.0	0.0	0.0
S	4.0	5.2	4.8	3.5
S1	63.3	62.5	58.9	61.5
C	32.7	32.3	36.3	35.0

RAP 14 (5/15)				
G	0.0	0.0	0.0	0.0
S	4.5	5.1	3.4	3.4
S1	60.9	63.2	57.2	59.5
C	34.9	31.7	39.4	37.1

RAP 15 (0/5)	
G	0.0
S	19.9
S1	55.5
C	24.6

RAP 15 (5/15)	
G	0.0
S	19.3
S1	56.3
C	24.4

RAP 16 (0/5)	
G	2.2
S	97.3
S1	0.3
C	0.2

RAP 16 (5/15)	
G	7.1
S	92.4
S1	0.3
C	0.2

	Winter 1984	Spring 1984	Summer 1984	Fall 1984
RAP 17 (0/5)				
G	0.0			
S	2.5			
S1	60.3			
C	37.2			
RAP 17 (5/15)				
G	0.2			
S	3.8			
S1	61.0			
C	35.0			
RAP 18 (0/5)				
G	0.0	0.0	0.3	0.0
S	9.3	11.0	11.2	8.1
S1	62.2	59.7	64.0	60.9
C	28.5	29.3	24.6	30.9
RAP 18 (5/15)				
G	0.0	0.0	0.0	0.0
S	10.4	11.6	6.3	6.3
S1	60.4	59.7	60.5	66.8
C	29.2	28.8	33.2	26.9

Table V-7. Total organic carbon, Rappahannock Shoals disposal areas;
 Cruise 2 = Winter, 1984; Cruise 3 = Spring, 1984;
 Cruise 4 = Summer, 1984; Cruise 5 = Fall, 1984.
 (Stations without analyses coded 9999).

RSP01	0-5	99999	2.387	99999	99999	99999
RSP01	5-15	99999	2.258	99999	99999	99999
RSP02	0-5	99999	2.090	0.381	99999	2.284
RSP02	5-15	99999	2.229	0.108	99999	2.395
RSP03	0-5	99999	0.109	2.362	0.101	0.107
RSP03	5-15	99999	0.543	0.736	0.136	0.245
RSP04	0-5	99999	2.164	99999	2.104	99999
RSP04	5-15	99999	2.162	99999	1.665	99999
RSP05	0-5	99999	2.004	1.772	99999	1.932
RSP05	5-15	99999	1.942	1.757	99999	1.800
RSP06	0-5	99999	0.122	99999	99999	99999
RSP06	5-15	99999	0.223	99999	99999	99999
RSP07	0-5	99999	2.216	1.799	2.104	2.074
RSP07	5-15	99999	1.758	2.073	1.665	2.056
RSP08	0-5	99999	0.413	0.328	0.271	0.354
RSP08	5-15	99999	0.057	0.413	0.077	0.374
RSP09	0-5	99999	0.192	99999	99999	99999
RSP09	5-15	99999	0.093	99999	99999	99999
RSP10	0-5	99999	2.196	99999	99999	99999
RSP10	5-15	99999	2.010	99999	99999	99999
RSP11	0-5	99999	0.456	99999	99999	99999
RSP11	5-15	99999	0.422	99999	99999	99999
RSP12	0-5	99999	0.290	0.031	0.175	0.374
RSP12	5-15	99999	0.164	0.075	0.101	0.334
RSP13	0-5	99999	1.933	1.943	1.621	1.906
RSP13	5-15	99999	1.570	1.747	1.540	1.799
RSP14	0-5	99999	0.087	0.130	0.111	0.305
RSP14	5-15	99999	0.164	0.253	0.107	0.254
RSP15	0-5	99999	0.154	99999	99999	99999
RSP15	5-15	99999	0.023	99999	99999	99999
RSP16	0-5	99999	1.988	1.899	99999	99999
RSP16	5-15	99999	1.770	1.715	99999	99999

RSP17	0-5	99999	0.855	99999	99999	99999
RSP17	5-15	99999	0.448	99999	99999	99999
RSP18	0-5	99999	0.099	0.291	0.156	0.138
RSP18	5-15	99999	0.018	0.218	0.474	0.139
RSP19	0-5	99999	99999	99999	0.197	0.178
RSP19	5-15	99999	99999	99999	0.226	0.108
RSP20	0-5	99999	99999	99999	2.180	2.303
RSP20	5-15	99999	99999	99999	1.930	2.101
RSP21	0-5	99999	99999	99999	2.136	2.034
RSP21	5-15	99999	99999	99999	1.869	1.708
RAP01	0-5	99999	1.953	1.957	2.123	1.665
RAP01	5-15	99999	1.729	1.672	1.680	1.354
RAP02	0-5	99999	1.785	1.662	1.667	1.532
RAP02	5-15	99999	1.673	1.556	1.557	1.433
RAP03	0-5	99999	0.575	99999	99999	99999
RAP03	5-15	99999	0.603	99999	99999	99999
RAP04	0-5	99999	1.729	99999	99999	99999
RAP04	5-15	99999	1.464	99999	99999	99999
RAP05	0-5	99999	1.810	1.712	1.743	1.572
RAP05	5-15	99999	1.518	1.804	1.357	1.410
RAP06	0-5	99999	1.392	99999	99999	99999
RAP06	5-15	99999	1.338	99999	99999	99999
RAP07	0-5	99999	1.855	99999	99999	99999
RAP07	5-15	99999	1.470	99999	99999	99999
RAP08	0-5	99999	1.490	1.161	1.489	1.291
RAP08	5-15	99999	1.486	1.446	1.507	1.215
RAP09	0-5	99999	1.326	99999	99999	99999
RAP09	5-15	99999	1.005	99999	99999	99999
RAP10	0-5	99999	1.973	99999	99999	99999
RAP10	5-15	99999	1.762	99999	99999	99999
RAP11	0-5	99999	1.876	1.633	1.632	1.381
RAP11	5-15	99999	1.578	1.392	1.441	1.309
RAP12	0-5	99999	1.335	99999	99999	99999
RAP12	5-15	99999	1.183	99999	99999	99999

RAP13	0-5	99999	2.160	2.041	1.855	2.268
RAP13	5-15	99999	2.352	1.910	1.845	2.062
RAP14	0-5	99999	1.778	1.172	1.402	1.142
RAP14	5-15	99999	1.417	1.026	2.875	1.288
RAP15	0-5	99999	1.078	99999	99999	99999
RAP15	5-15	99999	0.895	99999	99999	99999
RAP16	0-5	99999	0.018	99999	99999	99999
RAP16	5-15	99999	0.008	99999	99999	99999
RAP17	0-5	99999	1.705	99999	99999	99999
RAP17	5-15	99999	1.624	99999	99999	99999
RAP18	0-5	99999	1.123	1.038	1.367	1.367
RAP18	5-15	99999	1.000	1.055	0.993	1.175
RAC01	0-5	99999	2.152	2.089	2.191	1.194
RAC01	5-15	99999	1.692	1.757	1.004	1.603
RAC02	0-5	99999	0.902	0.838	0.967	0.723
RAC02	5-15	99999	0.826	0.702	0.931	0.750
RSC01	0-5	99999	2.094	2.023	2.272	1.698
RSC01	5-15	99999	2.037	2.047	2.132	1.776
RSC02	0-5	99999	0.884	1.076	0.869	0.427

PART VI CONCLUSIONS

Wolf Trap

The benthic communities at the Wolf Trap Study Region were found to be very diverse and abundant. Broad areas of both the Primary and Alternate sites were very similar in all community parameters measured. There were no sharp breaks in the communities, other than in the area of a sandy sediment anomaly around WTP16.

The faunal composition at the Wolf Trap Region was indicative of a mature or advanced successional stage community. The dominants were large and long-lived species characteristic of a equilibrium life history, as opposed to small short-lived species that have opportunistic life histories.

There were no wide fluctuations in abundance of any of the species at the Wolf Trap sites. However, there was a very strong trend of populations decline from a high in the Fall 1983 to a low in Fall 1984. For most of the species this decline was monotonic.

The strongest gradients in the fauna followed the east to west mudding of the sediments. The eastern side of Wolf Trap being about 55% fine sand and the western side about 25%. This sediment gradient accounted for most of the spatial variability in communities.

The biogenic structure of the Wolf Trap Region sediments was very well developed. REMOTS images indicated intensive reworking of sediments down to at least 12 cm, maximum REMOTS penetration. While the level of reworking varied seasonally the benthos was the major force affecting the physical structure of the surface sediments.

Rappahannock

The benthic communities at the Rappahannock Shoals Study Region were found to range widely in diversity and abundance. The Rappahannock Shoals Primary site was overall more diverse and had higher abundances relative to the Rappahannock Alternate Site. The Rappahannock Primary site also had the extremes of lowest and highest community structure parameters. There were very sharp breaks in the communities in the Rappahannock Region due to changes in sediment type.

The faunal composition at the Rappahannock Region was overall indicative of an early successional stage community. The dominants were a mixture of both small and large species with short life spans (about a year or less). The communities were made up most species with opportunistic life histories.

There was no overall trend in the populations of the dominant species at the Rappahannock Region. Some of them declined throughout the study while others fluctuated widely as a result of spring or fall recruitment. Populations at the Rappahannock Primary Site were almost always higher than the Rappahannock Alternate site.

The strongest gradients in the fauna followed the west to east mudding of the sediments. The western side of Rappahannock being about 1% sand and the eastern side about 90% in the North and 20% in the South. This gradient accounted for much of the spatial variability in the communities, but there was also a North to South gradient in sediments that influenced community structure.

The biogenic structure of the Rappahannock Region sediments was very variable ranging from complete lack of biogenic activity to well developed structure. The areas of most intense biogenic activity were mixed

sediments. Mud sediments were very low in biogenic activity, as were the higher energy sand areas. Seasonal changes in biogenic structures were most pronounced in the Rappahannock Shoals Primary site.

PART VII REFERENCES

- Bokuniewicz, H. J., R. B. Gordon, and D. C. Rhoads. 1975. Mechanical properties of the Sediment-water interface. *Marine Geology* 18: 263-278.
- Byrne, Robert J., Carl H. Hobbs, III, and Michael J. Carron. 1982. Baseline Sediment Studies to Determine Distribution, Physical Properties, Sedimentation Budgets, and Rates in the Virginia Portion of the Chesapeake Bay. Final Report to the U.S. EPA. 155 p.
- Folk, Robert L. 1980. *Petrology of Sedimentary Rocks*. 1980 Edition, Hemphill Publishing Co., Austin, Texas.
- Kendall, D. R., J. D. Lutz, and V. A. Sotler. 1984. An analysis of winter 1984 fish feeding habitat values at four dredged material disposal sites in the Chesapeake Bay: Baltimore Harbor 50 ft. Project: Predredging study (Phase I). Quarterly Report, Baltimore District Corps of Engineers, Baltimore, MD. 52 p.
- Kendall, D. R., V. A. Sotler, and S. M. Schellhaass. 1985. An analysis of spring and summer 1984 fish feeding habitat values at dredged material disposal sites in the Chesapeake Bay: Baltimore Harbor 50 ft. Project: Predredging study (Phase I). Quarterly Report, Baltimore, District Corps of Engineers, Baltimore, MD. 230 p.

- Lunz, J. D. and D. R. Kendall. 1982. Benthic resources assessment technique, a method for quantifying the effects of benthic community changes on fish resources. Oceans '82, Marine Pollution Sessions, Washington, D.C. pp. 1021-1027.
- Rhoads, D. C. and L. F. Boyer. 1982. The effects of marine benthos on physical properties of sediments: a successional perspective, pp. 3-52. In: McCall, P. L. and M. J. S. Tevesez (eds.). Animal-Sediment Relations. Plenum Geobiology Series.
- Rhoads, D. C. and J. D. Germano. 1982. Characterization of organism-sediment relations using sediment profile imaging: an efficient method of remote ecological monitoring of the seafloor (REMOTStm system). Mar. Ecol. Prog. Ser. 8: 115-128.
- Schaffner, L. C., R. J. Diaz, R. J. Byrne, and R. A. Gammisch. 1985. Quarterly Report for Winter Cruise, February 1984, Baltimore Harbor and Channels Aquatic Benthos Investigations. Baltimore District Corps of Engineers, Baltimore, MD. 127 p.
- Yingst, J. Y. and D. C. Rhoads. 1980. The role of bioturbation in the enhancement of bacterial growth rates in marine sediments, pp. 407-421. IN: Tenore, K. R. and B. C. Coull (eds.). Marine Benthic Dynamics. University of S. Carolina Press, Columbia, S.C.

APPENDIX A1

Listing of Loran TD's, and latitude and longitude of all stations and replicates.

STATION	CORE ID	TD 27	TD 41	LAT	LONG
WAP011	A	27269.000	41549.405	37 21.02	76 10.99
WAP011	B	27269.016	41549.430	37 21.02	76 10.99
WAP011	C	27268.992	41549.125	37 21.00	76 11.00
WAP011	D	27269.004	41549.289	37 21.01	76 10.99
WAP021	A	27270.105	41535.313	37 19.93	76 11.80
WAP021	B	27269.977	41535.438	37 19.94	76 11.77
WAP021	C	27269.965	41535.445	37 19.94	76 11.76
WAP021	D	27269.988	41535.445	37 19.94	76 11.77
WAP031	A	27263.484	41537.617	37 19.92	76 10.21
WAP031	B	27263.477	41537.586	37 19.92	76 10.21
WAP031	C	27263.527	41537.641	37 19.93	76 10.23
WAP031	D	27263.480	41537.602	37 19.92	76 10.22
WAP041	A	27264.313	41522.734	37 18.77	76 11.01
WAP041	B	27264.258	41522.500	37 18.75	76 11.00
WAP041	C	27264.289	41522.633	37 18.76	76 11.00
WAP041	D	27264.285	41522.555	37 18.75	76 11.00
WAP051	A	27258.504	41525.906	37 18.84	76 9.56
WAP051	B	27258.559	41525.938	37 18.85	76 9.57
WAP051	C	27258.555	41525.969	37 18.85	76 9.57
WAP051	D	27258.539	41525.922	37 18.84	76 9.56
WAP061	A	27252.145	41528.852	37 18.89	76 8.02
WAP061	B	27252.129	41529.352	37 18.93	76 8.00
WAP061	C	27252.102	41530.227	37 18.99	76 7.96
WAP061	D	27252.094	41529.836	37 18.96	76 7.96
WAP071	A	27265.852	41509.305	37 17.74	76 11.88
WAP071	B	27265.879	41509.344	37 17.75	76 11.89
WAP071	C	27265.895	41509.375	37 17.75	76 11.89
WAP071	D	27265.824	41509.453	37 17.76	76 11.87
WAP081	A	27259.746	41511.656	37 17.75	76 10.42
WAP081	B	27259.793	41511.602	37 17.75	76 10.43
WAP081	C	27259.848	41511.578	37 17.75	76 10.44
WAP081	D	27259.836	41511.602	37 17.75	76 10.44
WAP091	A	27253.527	41513.852	37 17.73	76 8.91
WAP091	B	27253.617	41513.797	37 17.73	76 8.93
WAP091	C	27253.523	41513.789	37 17.73	76 8.92
WAP091	D	27253.570	41513.773	37 17.73	76 8.94
WAP101	A	27260.645	41497.656	37 16.66	76 11.17
WAP101	B	27260.715	41497.594	37 16.66	76 11.19
WAP101	C	27260.730	41497.719	99 99999	99 99999
WAP111	A	27255.188	41499.516	37 16.64	76 9.86
WAP111	B	27255.082	41499.805	37 16.66	76 9.83
WAP121	A	27249.668	41501.508	37 16.63	76 8.54
WAP121	B	27249.676	41501.633	37 16.64	76 8.54
WAP121	C	27249.574	41501.914	37 16.66	76 8.50
WAP121	D	27249.711	41501.492	37 16.63	76 8.54
WAP131	A	27261.121	41482.250	37 15.45	76 11.89
WAP131	B	27261.223	41482.391	37 15.47	76 11.92
WAP131	C	27261.156	41482.297	37 15.46	76 11.91
WAP131	D	27261.090	41482.188	37 15.45	76 11.89
WAP141	A	27256.316	41485.633	37 15.57	76 10.67
WAP141	B	27256.137	41485.742	37 15.58	76 10.62
WAP141	C	27256.438	41486.039	37 15.61	76 10.68
WAP141	D	27256.344	41485.773	37 15.59	76 10.68
WAP151	A	27250.262	41485.922	37 15.41	76 9.28
WAP151	B	27250.375	41485.688	37 15.40	76 9.33
WAP151	C	27250.453	41485.789	37 15.41	76 9.34
WAP151	D	27250.457	41485.727	37 15.40	76 9.33
WAP151	D	27250.496	41485.789	37 15.41	76 9.33

STATION	CORE ID	TD 27	TD 41	LAT	LONG	Page	2
WTP011	A	27261.738	41583.984	37 23.56	76 7.97		
WTP011	B	27261.730	41583.992	37 23.56	76 7.97		
WTP011	C	27261.777	41583.906	37 23.55	76 7.98		
WTP011	D	27261.707	41583.945	37 23.55	76 7.96		
WTP021	A	27255.891	41584.602	37 23.44	76 6.63		
WTP021	B	27255.848	41584.602	37 23.44	76 6.63		
WTP021	C	27255.859	41584.633	37 23.44	76 6.64		
WTP021	D	27255.848	41584.633	37 23.44	76 6.64		
WTP031	A	27251.063	41584.563	37 23.30	76 5.57		
WTP031	B	27251.055	41584.539	37 23.30	76 5.57		
WTP031	C	27251.125	41584.578	37 23.30	76 5.58		
WTP031	D	27251.098	41584.594	37 23.30	76 5.57		
WTP041	A	27263.844	41574.969	37 22.90	76 8.81		
WTP041	B	27263.871	41575.125	37 22.91	76 8.79		
WTP041	C	27263.840	41574.984	37 22.90	76 8.80		
WTP041	D	27263.855	41575.094	37 22.91	76 8.79		
WTP051	A	27258.332	41576.633	37 22.79	76 7.54		
WTP051	B	27258.320	41575.719	37 22.80	76 7.53		
WTP051	C	27258.359	41575.734	37 22.81	76 7.54		
WTP061	A	27252.563	41575.758	37 22.64	76 6.25		
WTP061	B	27252.684	41575.852	37 22.65	76 6.26		
WTP061	C	27252.660	41575.805	37 22.65	76 6.27		
WTP061	D	27252.641	41575.797	37 22.64	76 6.26		
WTP071	A	27257.680	41565.555	37 22.04	76 8.25		
WTP071	B	27259.527	41565.727	37 22.04	76 8.20		
WTP071	C	27259.633	41565.555	37 22.03	76 8.24		
WTP071	D	27259.551	41565.664	37 22.04	76 8.21		
WTP081	A	27253.574	41564.344	37 21.75	76 6.93		
WTP081	B	27252.570	41564.758	37 21.79	76 6.91		
WTP081	C	27253.629	41564.453	37 21.76	76 6.93		
WTP081	D	27253.594	41564.555	37 21.78	76 6.93		
WTP091	A	27248.445	41566.109	37 21.75	76 5.71		
WTP091	B	27248.492	41566.219	37 21.76	76 5.72		
WTP091	C	27248.504	41566.164	37 21.75	76 5.72		
WTP091	D	27248.352	41566.141	37 21.75	76 5.69		
WTP101	A	27262.332	41557.156	37 21.44	76 9.18		
WTP101	B	27262.207	41556.945	37 21.42	76 9.15		
WTP101	C	27262.195	41556.977	37 21.42	76 9.15		
WTP101	D	27262.188	41556.977	37 21.42	76 9.15		
WTP111	A	27256.051	41556.398	37 21.20	76 7.80		
WTP111	B	27255.934	41556.219	37 21.18	76 7.78		
WTP111	C	27256.012	41556.141	37 21.17	76 7.80		
WTP111	D	27256.039	41556.070	37 21.17	76 7.80		
WTP121	A	27250.184	41556.219	37 21.01	76 6.50		
WTP121	B	27250.191	41556.211	37 21.01	76 6.50		
WTP121	C	27250.125	41556.109	37 21.00	76 6.48		
WTP121	D	27250.156	41556.133	37 21.00	76 6.49		
WTP131	X	27257.668	41547.164	37 20.52	76 8.54		
WTP141	A	27252.160	41546.906	37 20.33	76 7.31		
WTP141	B	27252.234	41546.820	37 20.32	76 7.32		
WTP141	C	27252.273	41546.852	37 20.32	76 7.33		
WTP151	A	27246.480	41546.906	37 20.16	76 6.04		
WTP151	B	27246.527	41547.000	37 20.16	76 6.04		
WTP161	A	27260.156	41537.445	37 19.81	76 9.48		
WTP171	A	27254.055	41537.359	37 19.62	76 8.11		
WTP171	B	27254.086	41537.367	37 19.62	76 8.11		
WTP171	C	27254.063	41537.320	37 19.62	76 8.11		
WTP171	D	27254.027	41537.328	37 19.62	76 8.11		
WTP181	A	27248.336	41537.445	37 19.46	76 6.82		
WTP181	B	27248.313	41537.430	37 19.45	76 6.81		

STATION	CORE ID	TD 27	TD 41	LAT	LONG	Page	3
WTP181	D	27248.309	41537.563	37 19.46	76 6.81		
RAC012	A	27319.898	41757.898	99 99999	99 99999		
RAC012	B	27319.898	41757.898	99 99999	99 99999		
RAC012	C	27320.066	41757.867	37 38.93	76 13.71		
RAC012	D	27320.063	41757.945	37 38.93	76 13.71		
RAC022	A	27288.730	41733.688	37 36.21	76 7.85		
RAC022	B	27288.762	41733.906	37 36.23	76 7.84		
RAC022	C	27288.723	41733.781	37 36.23	76 7.85		
RAC022	D	27288.723	41733.781	37 36.22	76 7.84		
RAP012	A	27315.031	41778.891	37 40.47	76 11.72		
RAP012	B	27315.164	41778.891	37 40.47	76 11.75		
RAP012	C	27315.152	41778.867	37 40.47	76 11.75		
RAP012	D	27315.211	41778.875	37 40.48	76 11.76		
RAP022	A	27310.180	41780.266	37 40.46	76 10.59		
RAP022	B	27310.492	41780.367	37 40.48	76 10.64		
RAP022	C	27310.355	41780.320	37 40.46	76 10.64		
RAP022	D	27310.387	41780.266	37 40.46	76 10.64		
RAP032	A	27305.461	41781.820	37 40.47	76 9.49		
RAP032	B	27305.402	41781.414	37 40.43	76 9.49		
RAP032	C	27305.387	41781.695	37 40.46	76 9.50		
RAP032	D	27305.395	41781.883	37 40.46	76 9.48		
RAP042	A	27315.012	41764.906	37 39.36	76 12.30		
RAP042	B	27315.020	41764.905	37 39.35	76 12.31		
RAP042	C	27314.934	41764.938	37 39.37	76 12.29		
RAP042	D	27315.059	41765.023	37 39.37	76 12.31		
RAP052	A	27310.148	41767.015	37 39.41	76 11.16		
RAP052	B	27310.414	41767.405	37 39.44	76 11.17		
RAP052	C	27310.414	41767.141	37 39.42	76 11.20		
RAP052	D	27310.234	41767.117	37 39.42	76 11.17		
RAP062	A	27305.238	41768.852	37 39.43	76 10.01		
RAP062	B	27305.234	41768.805	37 39.43	76 10.01		
RAP062	C	27305.230	41768.867	37 39.43	76 9.99		
RAP062	D	27305.387	41768.992	37 39.44	76 10.02		
RAP072	A	27310.262	41753.344	37 38.28	76 11.76		
RAP072	B	27310.336	41753.398	37 38.33	76 11.76		
RAP072	C	27310.328	41753.352	37 38.33	76 11.77		
RAP072	D	27310.262	41753.211	37 38.32	76 11.76		
RAP082	A	27305.188	41754.773	37 38.31	76 10.58		
RAP082	B	27305.242	41754.688	37 38.31	76 10.60		
RAP082	C	27305.211	41755.085	37 38.34	76 10.57		
RAP082	D	27305.223	41754.750	37 38.30	76 10.58		
RAP092	A	27300.227	41756.313	37 38.31	76 9.43		
RAP092	B	27300.340	41756.195	37 38.30	76 9.45		
RAP092	C	27300.359	41756.305	37 38.31	76 9.45		
RAP092	D	27300.410	41756.297	37 38.31	76 9.47		
RAP102	A	27310.230	41740.031	37 37.27	76 12.31		
RAP102	B	27310.297	41740.063	37 37.27	76 12.31		
RAP102	C	27310.227	41739.969	37 37.26	76 12.31		
RAP102	D	27310.203	41739.938	37 37.26	76 12.31		
RAP112	A	27305.176	41741.195	37 37.23	76 11.16		
RAP112	B	27305.121	41741.063	37 37.22	76 11.15		
RAP112	C	27305.117	41741.086	37 37.22	76 11.13		
RAP112	D	27305.191	41740.969	37 37.21	76 11.16		
RAP122	A	27300.113	41742.969	37 37.24	76 9.95		
RAP122	B	27300.199	41742.797	99 99999	99 99999		
RAP122	C	27300.301	41742.898	99 99999	99 99999		
RAP122	D	27300.289	41743.180	37 37.26	76 9.99		
RAP132	A	27304.926	41725.633	37 36.00	76 11.75		
RAP132	B	27304.863	41725.750	37 36.00	76 11.74		
RAP132	C	27304.945	41725.703	37 36.00	76 11.76		

STATION	CORE ID	TD 27	TD 41	LAT	LONG	Page	4
RAP132	D	27305.051	41725.773	37 36.01	76 11.76		
RAP142	A	27299.938	41727.633	37 36.02	76 10.56		
RAP142	B	27299.859	41727.859	37 36.04	76 10.56		
RAP142	C	27300.031	41727.773	37 36.04	76 10.59		
RAP142	D	27300.004	41727.555	37 36.01	76 10.57		
RAP152	A	27295.410	41730.789	37 36.16	76 9.43		
RAP152	B	27295.102	41730.781	37 36.15	76 9.36		
RAP152	C	27295.199	41730.930	37 36.16	76 9.39		
RAP152	D	27295.320	41730.898	37 36.16	76 9.41		
RAP162	A	27305.109	41714.102	37 35.08	76 12.27		
RAP162	B	27304.996	41713.891	37 35.07	76 12.26		
RAP162	C	27304.973	41713.867	37 35.06	76 12.25		
RAP162	D	27304.949	41713.852	37 35.06	76 12.25		
RAP172	A	27300.090	41715.484	37 35.06	76 11.09		
RAP172	B	27300.055	41715.211	37 35.04	76 11.11		
RAP172	C	27300.043	41715.211	37 35.04	76 11.10		
RAP172	D	27300.188	41715.125	37 35.04	76 11.14		
RAP182	A	27295.324	41717.328	37 35.08	76 9.97		
RAP182	B	27295.438	41717.320	37 35.08	76 10.00		
RAP182	C	27295.363	41717.336	37 35.08	76 9.98		
RAP182	D	27295.211	41717.336	37 35.08	76 9.95		
RSC012	A	27327.914	41858.258	37 47.07	76 11.12		
RSC012	B	27328.242	41858.242	37 47.07	76 11.18		
RSC012	C	27328.191	41858.414	37 47.09	76 11.17		
RSC012	D	27328.234	41858.219	37 47.07	76 11.18		
RSC022	A	27306.355	41814.883	37 43.11	76 8.29		
RSC022	B	27306.297	41814.773	37 43.10	76 8.29		
RSC022	C	27306.352	41814.859	37 43.11	76 8.30		
RSC022	D	27306.313	41814.727	37 43.10	76 8.29		
RSP012	A	27326.613	41830.484	37 44.84	76 12.04		
RSP012	B	27326.629	41830.531	37 44.84	76 12.04		
RSP012	C	27326.711	41830.461	37 44.84	76 12.06		
RSP012	D	27326.582	41830.445	37 44.83	76 12.13		
RSP022	A	27322.191	41833.281	37 44.95	76 10.95		
RSP022	B	27322.398	41833.117	37 44.95	76 11.01		
RSP022	C	27322.211	41833.516	37 44.97	76 10.94		
RSP022	D	27322.184	41833.242	37 44.95	76 10.96		
RSP032	A	27317.777	41836.055	37 45.07	76 9.88		
RSP032	B	27317.777	41835.781	37 45.05	76 9.89		
RSP032	C	27317.801	41836.094	37 45.07	76 9.88		
RSP032	D	27317.852	41835.914	37 45.05	76 9.89		
RSP042	A	27326.820	41821.492	37 44.13	76 12.47		
RSP042	B	27326.813	41821.570	37 44.14	76 12.50		
RSP042	C	27326.813	41821.430	37 44.12	76 12.47		
RSP042	D	27326.871	41821.438	37 44.13	76 12.49		
RSP052	A	27322.637	41824.180	37 44.25	76 11.45		
RSP052	B	27322.559	41824.078	37 44.23	76 11.43		
RSP052	C	27322.594	41824.234	37 44.25	76 11.43		
RSP052	D	27322.520	41824.078	37 44.23	76 11.42		
RSP062	A	27318.090	41826.781	37 44.34	76 10.34		
RSP062	B	27318.125	41826.820	37 44.34	76 10.34		
RSP062	C	27318.129	41826.711	37 44.33	76 10.34		
RSP062	D	27318.148	41826.664	37 44.34	76 10.36		
RSP072	A	27322.543	41815.156	37 43.53	76 11.81		
RSP072	B	27322.625	41815.398	37 43.55	76 11.82		
RSP072	C	27322.660	41815.102	37 43.52	76 11.82		
RSP072	D	27322.754	41815.102	37 43.53	76 11.84		
RSP082	A	27318.305	41818.125	37 43.66	76 10.75		
RSP082	B	27318.215	41817.727	37 43.63	76 10.76		
RSP082	C	27318.340	41817.641	37 43.62	76 10.79		

STATION	CORE ID	TD 27	TD 41	LAT	LONG
RSP082	D	27318.445	41817.734	37 43.63	76 10.81
RSP092	A	27313.828	41819.875	37 43.69	76 9.71
RSP092	B	27313.797	41819.939	37 43.69	76 9.70
RSP092	C	27314.012	41819.906	37 43.69	76 9.74
RSP092	D	27314.039	41829.906	37 43.70	76 9.77
RSP102	A	27322.730	41805.555	37 42.77	76 12.24
RSP102	B	27322.723	41805.922	37 42.80	76 12.24
RSP102	C	27322.738	41805.578	37 42.77	76 12.26
RSP102	D	27322.742	41805.539	37 42.77	76 12.27
RSP112	A	27317.988	41808.344	37 42.88	76 11.11
RSP112	B	27318.117	41808.820	37 42.92	76 11.12
RSP112	C	27318.188	41808.492	37 42.90	76 11.14
RSP112	D	27318.156	41808.617	37 42.90	76 11.13
RSP122	A	27314.125	41810.602	37 42.97	76 10.21
RSP122	B	27314.258	41810.258	37 42.94	76 10.21
RSP122	C	27314.305	41810.313	37 42.94	76 10.22
RSP122	D	27314.344	41810.688	37 42.97	76 10.22
RSP132	A	27318.363	41798.992	37 42.14	76 11.59
RSP132	B	27318.387	41799.102	37 42.15	76 11.58
RSP132	C	27318.453	41799.188	37 42.15	76 11.58
RSP132	D	27318.426	41799.305	37 42.16	76 11.59
RSP142	A	27314.219	41800.953	37 42.20	76 10.60
RSP142	B	27314.297	41801.313	37 42.23	76 10.59
RSP142	C	27314.289	41801.047	37 42.21	76 10.61
RSP142	D	27314.273	41802.055	37 42.29	76 10.55
RSP152	A	27309.848	41804.047	37 42.33	76 9.51
RSP152	B	27309.887	41803.992	37 42.34	76 9.53
RSP152	C	27309.789	41803.938	37 42.33	76 9.53
RSP152	D	27309.746	41803.953	37 42.33	76 9.49
RSP162	A	27318.711	41789.344	37 41.39	76 12.07
RSP162	B	27318.328	41789.406	37 41.39	76 12.00
RSP162	C	27318.590	41789.148	37 41.37	76 12.05
RSP162	D	27318.523	41789.109	37 41.37	76 12.05
RSP172	A	27314.391	41791.836	37 41.48	76 11.02
RSP172	B	27314.313	41791.523	37 41.46	76 11.03
RSP172	C	27314.207	41791.242	37 41.43	76 11.01
RSP172	D	27314.246	41791.570	37 41.46	76 11.01
RSP182	A	27309.477	41793.203	37 41.47	76 9.89
RSP182	B	27309.488	41793.453	37 41.49	76 9.89
RSP182	C	27309.527	41793.047	37 41.46	76 9.91
RSP182	D	27399.559	41792.938	37 41.46	76 9.91
WAC012	A	27251.270	41474.383	37 14.52	76 10.06
WAC012	B	27251.699	41474.445	37 14.53	76 10.07
WAC012	C	27251.684	41474.133	37 14.50	76 10.07
WAC012	D	27251.688	41474.258	37 14.51	76 10.07
WAC022	A	27246.125	41521.281	37 18.11	76 6.99
WAC022	B	27246.266	41521.664	37 18.14	76 6.98
WAC022	C	27246.227	41521.539	37 18.13	76 6.98
WAC022	D	27246.285	41521.430	37 18.11	76 7.00
WAP012	A	27268.965	41549.063	37 21.00	76 11.00
WAP012	B	27269.012	41549.289	37 21.02	76 11.00
WAP012	C	27269.027	41549.141	37 21.02	76 11.03
WAP012	D	27268.945	41549.086	37 21.01	76 11.00
WAP022	A	27270.063	41535.672	37 19.97	76 11.79
WAP022	B	27269.965	41535.648	37 19.97	76 11.77
WAP022	C	27270.012	41535.609	37 19.97	76 11.78
WAP022	D	27270.059	41535.445	37 19.95	76 11.79
WAP032	A	27263.508	41537.844	37 19.94	76 10.21
WAP032	B	27263.516	41537.891	37 19.96	76 10.23
WAP032	C	27263.445	41537.563	37 19.93	76 10.22

STATION	CORE ID	TD 27	TD 41	LAT	LONG
WAP032	D	27263.445	41537.797	37 19.95	76 10.21
WAP042	A	27264.309	41522.742	37 18.78	76 11.02
WAP042	B	27264.270	41522.438	37 18.76	76 11.02
WAP042	C	27264.230	41522.438	37 18.75	76 11.00
WAP042	D	27264.215	41522.680	37 18.78	76 11.00
WAP052	A	27258.559	41526.211	37 18.87	76 9.57
WAP052	B	27258.395	41525.813	37 18.83	76 9.55
WAP052	C	27258.438	41526.836	37 18.86	76 9.55
WAP052	D	27258.508	41525.773	37 18.83	76 9.58
WAP062	A	27252.027	41529.586	37 18.94	76 7.97
WAP062	B	27252.215	41529.664	37 18.95	76 7.98
WAP062	C	27252.035	41529.602	37 18.94	76 7.97
WAP062	D	27251.992	41529.367	37 18.92	76 7.97
WAP072	A	27265.285	41509.281	37 17.77	76 11.89
WAP072	B	27265.914	41509.438	37 17.78	76 11.92
WAP072	C	27265.984	41509.539	37 17.78	76 11.91
WAP072	D	27265.820	41509.266	37 17.77	76 11.91
WAP082	A	27259.813	41511.602	37 17.74	76 10.45
WAP082	B	27259.652	41511.320	37 17.72	76 10.42
WAP082	C	27259.813	41511.461	37 17.74	76 10.44
WAP082	D	27259.645	41511.602	37 17.75	76 10.40
WAP092	A	27253.422	41513.758	37 17.74	76 8.92
WAP092	B	27253.523	41513.820	37 17.73	76 8.93
WAP092	C	27253.590	41513.578	37 17.72	76 8.96
WAP092	D	27253.578	41513.523	37 17.71	76 8.94
WAP102	A	27260.762	41497.852	37 16.67	76 11.21
WAP102	B	27260.734	41497.852	37 16.69	76 11.20
WAP102	C	27260.684	41497.672	37 16.67	76 11.18
WAP102	D	27260.746	41497.703	37 16.67	76 11.20
WAP112	A	27255.023	41499.703	37 16.65	76 9.82
WAP112	B	27255.129	41499.797	37 16.65	76 9.84
WAP112	C	27254.992	41499.820	37 16.66	76 9.82
WAP112	D	27255.043	41499.492	37 16.63	76 9.84
WAP122	A	27249.547	41501.516	37 16.62	76 8.51
WAP122	B	27249.941	41501.633	37 16.63	76 8.50
WAP122	C	27249.516	41501.602	37 16.62	76 8.50
WAP122	D	27249.527	41501.820	37 16.65	76 8.50
WAP132	A	27261.109	41482.297	37 15.46	76 11.90
WAP132	B	27261.121	41482.344	37 15.46	76 11.90
WAP132	C	27261.152	41482.148	37 15.45	76 11.91
WAP132	D	27261.180	41482.227	37 15.45	76 11.92
WAP142	A	27256.094	41485.695	37 15.56	76 10.62
WAP142	B	27256.184	41485.727	37 15.58	76 10.64
WAP142	C	27256.090	41485.711	37 15.57	76 10.62
WAP142	D	27256.191	41485.914	37 15.58	76 10.63
WAP152	A	27250.793	41485.625	37 15.39	76 9.42
WAP152	B	27250.727	41485.273	37 15.37	76 9.42
WAP152	C	27250.813	41485.594	37 15.39	76 9.43
WAP152	D	27250.680	41485.320	37 15.37	76 9.42
WTC012	A	27259.559	41599.547	37 24.75	76 6.87
WTC012	B	27259.531	41599.328	37 24.73	76 6.88
WTC012	C	27259.648	41599.500	37 24.75	76 6.88
WTC012	D	27259.715	41599.547	37 24.75	76 6.87
WTC022	A	27270.297	41579.703	37 23.47	76 10.07
WTC022	B	27270.359	41579.835	37 23.48	76 10.07
WTC022	C	27270.379	41579.766	37 23.48	76 10.07
WTC022	D	27270.371	41579.805	37 23.48	76 10.07
WTP012	A	27261.703	41584.102	37 23.58	76 7.97
WTP012	B	27261.805	41584.156	37 23.58	76 7.99
WTP012	C	27261.715	41583.867	37 23.56	76 7.97

STATION	CORE ID	TD 27	TD 41	LAT	LONG	Page
WTP012	D	27261.777	41584.133	37 23.58	76 7.98	
WTP022	A	27255.833	41584.602	37 23.45	76 6.64	
WTP022	B	27255.977	41584.555	37 23.45	76 6.67	
WTP022	C	27255.906	41584.531	37 23.45	76 6.66	
WTP022	D	27255.988	41584.609	37 23.46	76 6.68	
WTP032	A	27251.133	41584.406	37 23.30	76 5.60	
WTP032	B	27251.180	41584.405	37 23.30	76 5.61	
WTP032	C	27251.148	41584.344	37 23.30	76 5.60	
WTP032	D	27251.125	41584.391	37 23.30	76 5.60	
WTP042	A	27263.816	41575.109	37 22.92	76 8.79	
WTP042	B	27263.871	41575.148	37 22.93	76 8.81	
WTP042	C	27363.824	41575.023	37 22.91	76 8.80	
WTP042	D	27263.773	41575.109	37 22.92	76 8.79	
WTP052	A	27258.516	41575.734	37 22.82	76 7.57	
WTP052	B	27258.461	41575.906	37 22.84	76 7.57	
WTP052	C	27258.473	41575.617	37 22.82	76 7.59	
WTP052	D	27258.328	41575.914	37 22.83	76 7.55	
WTP062	A	27252.805	41575.781	37 22.66	76 6.31	
WTP062	B	27252.543	41575.914	37 22.66	76 6.25	
WTP062	C	27252.758	41575.883	37 22.66	76 6.30	
WTP062	D	27252.414	41575.609	37 22.63	76 6.25	
WTP072	A	27259.488	41565.367	37 22.03	76 8.22	
WTP072	B	27259.652	41565.773	37 22.07	76 8.24	
WTP072	C	27259.531	41565.515	37 22.04	76 8.23	
WTP072	D	27259.539	41565.523	37 22.05	76 8.23	
WTP082	A	27253.617	41564.648	37 21.80	76 6.94	
WTP082	B	27253.801	41564.695	37 21.80	76 6.97	
WTP082	C	27253.703	41564.742	37 21.80	76 6.97	
WTP082	D	27253.734	41564.438	37 21.78	76 6.98	
WTP092	A	27248.270	41565.930	37 21.74	76 5.70	
WTP092	B	27248.441	41566.172	37 21.76	76 5.72	
WTP092	C	999999999	999999999	99 99999	99 99999	
WTP092	D	27248.551	41566.313	37 21.77	76 5.73	
WTP102	A	27262.434	41556.969	37 21.44	76 9.21	
WTP102	B	27262.363	41557.211	37 21.45	76 9.18	
WTP102	C	27262.363	41557.094	37 21.44	76 9.19	
WTP102	D	27262.270	41557.008	37 21.45	76 9.19	
WTP112	A	27255.926	41556.242	37 21.20	76 7.79	
WTP112	B	27255.980	41555.891	37 21.17	76 7.81	
WTP112	C	27255.902	41556.023	37 21.18	76 7.79	
WTP112	D	27255.957	41556.383	37 21.21	76 7.80	
WTP122	A	27250.270	41556.281	37 21.03	76 6.49	
WTP122	B	27250.082	41556.141	37 21.01	76 6.49	
WTP122	C	27250.195	41556.484	37 21.03	76 6.49	
WTP122	D	27250.027	41556.336	37 21.02	76 6.47	
WTP132	A	27257.621	41547.094	37 20.52	76 8.55	
WTP132	B	27257.730	41547.203	37 20.53	76 8.54	
WTP132	C	27257.727	41547.195	37 20.53	76 8.55	
WTP132	D	27257.602	41547.148	37 20.52	76 8.53	
WTP142	A	27252.344	41546.828	37 20.32	76 7.31	
WTP142	B	27252.160	41547.070	37 20.35	76 7.31	
WTP142	C	27252.121	41547.000	37 20.34	76 7.30	
WTP142	D	27252.113	41546.969	37 20.33	76 7.30	
WTP152	A	27246.402	41546.938	37 20.16	76 6.03	
WTP152	B	27246.383	41547.188	37 20.18	76 6.00	
WTP152	C	27246.340	41547.078	37 20.16	76 6.00	
WTP152	D	27246.469	41547.258	37 20.18	76 6.02	
WTP162	A	27260.113	41537.695	37 19.85	76 9.48	
WTP162	B	27260.055	41537.891	37 19.86	76 9.45	
WTP162	C	27260.145	41637.648	37 19.85	76 9.49	

STATION	CORE ID	TD 27	TD 41	LAT	LONG	Page
WTP162	D	27260.125	41537.734	37 19.85	76 9.48	
WTP162	G	27260.691	41537.133	37 19.82	76 9.62	
WTP172	A	27254.172	41537.609	37 19.65	76 8.13	
WTP172	B	27254.066	41537.406	37 19.63	76 8.12	
WTP172	C	27254.047	41537.383	37 19.63	76 8.11	
WTP172	D	27254.012	41537.359	37 19.63	76 8.12	
WTP182	A	27248.172	41537.305	37 19.44	76 6.79	
WTP182	B	27248.273	41537.352	37 19.45	76 6.81	
WTP182	C	27248.266	41537.383	37 19.45	76 6.82	
WTP182	D	27248.184	41537.367	37 19.45	76 6.80	
RAC013	A	27320.023	41758.172	37 38.95	76 13.68	
RAC013	B	27320.000	41758.023	37 38.94	76 13.69	
RAC013	D	27319.922	41757.859	37 38.93	76 13.69	
RAC023	A	27288.738	41733.922	37 36.24	76 7.84	
RAC023	B	27288.844	41733.828	37 36.22	76 7.86	
RAC023	D	27288.883	41733.906	37 36.23	76 7.87	
RAP013	A	27315.125	41778.953	37 40.48	76 11.73	
RAP013	B	27315.121	41778.961	37 40.48	76 11.73	
RAP013	D	27315.164	41778.859	37 40.47	76 11.74	
RAP023	A	27310.266	41780.297	37 40.46	76 10.61	
RAP023	B	27310.234	41780.148	37 40.46	76 10.61	
RAP023	D	27310.254	41780.484	37 40.48	76 10.61	
RAP053	A	27310.320	41767.039	37 39.41	76 11.19	
RAP053	B	27310.203	41766.953	37 39.40	76 11.16	
RAP053	D	27310.203	41767.258	37 39.43	76 11.15	
RAP083	A	27305.121	41754.773	37 38.31	76 10.56	
RAP083	B	27305.145	41754.836	37 38.31	76 10.56	
RAP083	D	27305.121	41754.828	37 38.31	76 10.56	
RAP113	A	27305.211	41741.219	37 37.23	76 11.15	
RAP113	B	27305.129	41741.125	37 37.23	76 11.14	
RAP113	D	27305.137	41741.125	37 37.23	76 11.14	
RAP133	A	27304.883	41725.680	37 36.00	76 11.74	
RAP133	B	27304.965	41725.641	37 36.00	76 11.76	
RAP133	D	27304.844	41725.656	37 35.99	76 11.73	
RAP143	A	27299.836	41727.867	37 36.04	76 10.53	
RAP143	B	27299.813	41727.914	37 36.04	76 10.52	
RAP143	D	27299.941	41727.797	37 36.03	76 10.55	
RAP183	A	27295.445	41717.289	37 35.08	76 10.00	
RAP183	B	27295.301	41717.398	37 35.09	76 9.96	
RAP183	D	27295.328	41717.516	37 35.10	76 9.96	
RFP013	A	27295.340	41733.265	37 36.35	76 9.31	
RFP013	B	27295.344	41733.008	37 36.33	76 9.33	
RFP013	D	27295.234	41733.102	37 36.33	76 9.31	
RFP023	A	27297.430	41738.914	37 36.85	76 9.53	
RFP023	B	27297.191	41738.633	37 36.83	76 9.50	
RFP023	D	27297.191	41738.633	37 36.82	76 9.51	
RFP033	A	27310.777	41749.703	37 38.06	76 12.03	
RFP033	B	27310.863	41749.570	37 38.04	76 12.04	
RFP033	D	27310.684	41749.766	37 38.06	76 11.99	
RFP043	A	27308.305	41758.609	37 38.69	76 11.10	
RFP043	B	27308.383	41758.695	37 38.70	76 11.11	
RFP043	D	27308.262	41758.508	37 38.69	76 11.09	
RGP013	A	27311.309	41796.859	37 41.80	76 10.13	
RGP013	R	27311.348	41796.867	37 41.80	76 10.14	
RGP023	B	27311.539	41797.266	37 41.84	76 10.16	
RGP033	D	27311.652	41797.563	37 41.87	76 10.18	
RGP043	A	27311.949	41797.859	37 41.89	76 10.23	
RGP053	B	27312.082	41798.289	37 41.93	76 10.23	
RGP063	D	27312.344	41798.594	37 41.96	76 10.29	
RGP073	A	27312.527	41799.023	37 42.00	76 10.32	

STATION	CORE ID	TD 27	TD 41	LAT	LONG	Page	9
RGP083	B	27311.438	41796.585	37 41.78	76 10.17		
RGP093	D	27311.633	41796.805	37 41.81	76 10.21		
RGP103	A	27311.852	41797.281	37 41.85	76 10.24		
RGP113	B	27312.020	41797.445	37 41.86	76 10.27		
RGP123	D	27312.207	41797.813	37 41.90	76 10.29		
RGP133	A	27312.484	41798.258	37 41.94	76 10.33		
RGP143	B	27312.574	41798.383	37 41.96	76 10.35		
RGP153	D	27311.555	41796.219	37 41.75	76 10.21		
RGP163	A	27311.738	41796.469	37 41.78	76 10.25		
RGP173	B	27311.879	41796.820	37 41.81	76 10.27		
RGP183	D	27312.078	41797.102	37 41.84	76 10.30		
RGP193	A	27312.398	41797.328	37 41.87	76 10.35		
RGP203	B	27312.563	41797.789	37 41.90	76 10.37		
RGP213	D	27312.793	41798.250	37 41.95	76 10.41		
RGP223	A	27311.664	41795.672	37 41.72	76 10.27		
RGP233	B	27311.941	41796.273	37 41.77	76 10.30		
RGP243	D	27312.090	41796.555	37 41.80	76 10.32		
RGP253	A	27312.188	41796.930	37 41.83	76 10.33		
RGP263	B	27312.512	41796.992	37 41.84	76 10.38		
RGP273	D	27312.707	41797.664	37 41.90	76 10.40		
RGP283	A	27312.914	41797.750	37 41.91	76 10.45		
RLP013	A	27307.156	41754.328	37 38.33	76 11.04		
RLP023	B	27306.977	41754.398	37 38.32	76 10.98		
RLP033	D	27306.641	41754.405	37 38.32	76 10.91		
RLP043	A	27306.488	41754.281	37 38.31	76 10.89		
RLP053	B	27306.324	41754.422	37 38.31	76 10.84		
RLP063	D	27305.926	41754.555	37 38.31	76 10.75		
RLP073	A	27305.715	41754.453	37 38.30	76 10.71		
RLP083	B	27305.578	41754.758	37 38.32	76 10.66		
RLP093	D	27304.813	41755.000	37 38.32	76 10.49		
RLP103	A	27304.570	41754.930	37 38.31	76 10.44		
RLP113	B	27304.379	41755.055	37 38.31	76 10.39		
RLP123	D	27304.051	41755.172	37 38.32	76 10.32		
RLP133	A	27304.027	41755.281	37 38.32	76 10.30		
RLP143	B	27303.652	41755.383	37 38.32	76 10.21		
RLP153	D	27303.457	41755.438	37 38.32	76 10.18		
RSC013	A	27327.969	41858.320	37 47.08	76 11.14		
RSC013	B	27328.117	41858.305	37 47.08	76 11.16		
RSC013	D	27328.051	41858.273	37 47.07	76 11.15		
RSC023	A	27306.277	41814.773	37 43.10	76 8.28		
RSC023	B	27306.266	41814.688	37 43.09	76 8.28		
RSC023	D	27306.262	41814.813	37 43.10	76 8.29		
RSP023	A	27322.016	41833.305	37 44.96	76 10.92		
RSP023	B	27322.047	41833.594	37 44.98	76 10.91		
RSP023	D	27322.184	41833.422	37 44.96	76 10.94		
RSP033	A	27317.910	41836.148	37 45.08	76 9.90		
RSP033	B	27317.953	41835.984	37 45.07	76 9.92		
RSP033	D	27318.020	41836.039	37 45.07	76 9.92		
RSP053	A	27322.711	41824.477	37 44.27	76 11.44		
RSP053	B	27322.473	41824.242	37 44.25	76 11.39		
RSP053	D	27322.563	41824.180	37 44.24	76 11.42		
RSP073	A	27322.660	41815.313	37 43.54	76 11.83		
RSP073	B	27322.625	41815.219	37 43.53	76 11.82		
RSP073	D	27322.547	41815.328	37 43.54	76 11.80		
RSP083	A	27318.320	41817.719	37 43.63	76 10.77		
RSP083	B	27318.262	41817.883	37 43.64	76 10.76		
RSP083	D	27318.379	41817.891	37 43.64	76 10.78		
RSP123	A	27314.297	41810.641	37 42.97	76 10.21		
RSP123	B	27314.277	41810.602	37 42.97	76 10.20		
RSP123	D	27314.309	41810.515	37 42.95	76 10.20		

STATION	CORE ID	TD 27	TD 41	LAT	LONG	Page	10
RSP133	A	27318.355	41799.070	37 42.15	76 11.58		
RSP133	B	27318.449	41799.070	37 42.17	76 11.59		
RSP133	D	27318.359	41799.273	37 42.17	76 11.57		
RSP143	A	27314.340	41801.141	37 42.21	76 10.61		
RSP143	B	27314.273	41801.063	37 42.21	76 10.61		
RSP143	D	27314.203	41801.156	37 42.21	76 10.58		
RSP183	A	27309.488	41793.250	37 41.47	76 9.89		
RSP183	B	27309.578	41793.148	37 41.47	76 9.91		
RSP183	D	27309.527	41793.563	37 41.49	76 9.89		
WAC013	A	27251.715	41474.086	37 14.50	76 10.07		
WAC013	B	27251.723	41474.078	37 14.50	76 10.09		
WAC013	D	27251.688	41474.031	37 14.50	76 10.09		
WAC023	A	27246.160	41521.367	37 18.10	76 6.96		
WAC023	B	27246.199	41521.367	37 18.10	76 6.96		
WAC023	D	27246.109	41521.405	37 18.11	76 6.96		
WAP013	A	27269.016	41549.555	37 21.04	76 10.99		
WAP013	B	27268.945	41549.500	37 21.04	76 10.98		
WAP013	D	27269.020	41549.484	37 21.04	76 10.99		
WAP043	A	27264.215	41522.531	37 18.77	76 11.02		
WAP043	A	27264.254	41522.523	37 18.77	76 11.01		
WAP043	B	27264.328	41522.648	37 18.78	76 11.03		
WAP043	D	27264.336	41522.602	37 18.77	76 11.03		
WAP053	A	27258.414	41525.969	37 18.86	76 9.55		
WAP053	B	27258.410	41525.961	37 18.85	76 9.56		
WAP053	D	27258.590	41526.031	37 18.87	76 9.56		
WAP063	A	27251.973	41529.438	37 18.93	76 7.97		
WAP063	B	27252.176	41529.867	37 18.97	76 7.99		
WAP063	D	27252.184	41529.602	37 18.95	76 8.00		
WAP093	A	27253.445	41513.766	37 17.72	76 8.91		
WAP093	B	27253.598	41513.734	37 17.73	76 8.94		
WAP093	D	27253.445	41513.703	37 17.72	76 8.91		
WAP113	A	27255.090	41499.508	37 16.63	76 9.84		
WAP113	B	27255.094	41499.688	37 16.64	76 9.84		
WAP113	D	27255.004	41499.250	37 16.62	76 9.85		
WAP133	A	27261.355	41482.156	37 15.45	76 11.96		
WAP133	B	27261.488	41482.266	37 15.46	76 11.98		
WAP133	D	27261.152	41482.203	37 15.46	76 11.99		
WAP153	A	27250.766	41485.484	37 15.39	76 9.43		
WAP153	B	27250.742	41485.422	37 15.38	76 9.42		
WAP153	D	27250.664	41485.414	37 15.38	76 9.41		
WFP013	A	27248.266	41491.563	37 15.79	76 8.61		
WFP013	B	27248.223	41491.586	37 15.79	76 8.61		
WFP013	D	27248.273	41491.625	37 15.79	76 8.61		
WFP023	A	27255.320	41519.633	37 18.25	76 9.10		
WFP023	B	27255.234	41519.734	37 18.26	76 9.10		
WFP023	D	27255.316	41519.352	37 18.23	76 9.11		
WFP033	A	27257.258	41523.492	37 18.62	76 9.40		
WFP033	B	27257.359	41523.484	37 18.63	76 9.42		
WFP033	D	27257.227	41523.641	37 18.63	76 9.38		
WFP043	A	27250.316	41526.516	37 18.65	76 7.70		
WFP043	B	27250.266	41526.484	37 18.65	76 7.69		
WFP043	D	27250.355	41526.633	37 18.66	76 7.70		
WGP013	A	27249.492	41541.547	37 19.82	76 6.92		
WGP023	B	27249.742	41541.875	37 19.86	76 6.97		
WGP033	D	27249.828	41542.273	37 19.89	76 6.97		
WGP043	A	27250.129	41542.734	37 19.93	76 7.03		
WGP053	B	27250.219	41543.203	37 19.98	76 7.02		
WGP063	D	27250.340	41543.406	37 20.00	76 7.05		
WGP073	A	27250.547	41543.750	37 20.03	76 7.08		
WGP083	B	27249.676	41541.281	37 19.81	76 6.98		

STATION	CORE ID	TD 27	TD 41	LAT	LONG	Page	11
WGP093	D	27249.754	41541.477	37 19.83	76 6.99		
WGP103	A	27250.012	41541.969	37 19.87	76 7.02		
WGP113	B	27250.215	41542.359	37 19.91	76 7.06		
WGP123	D	27250.387	41542.852	37 19.95	76 7.07		
WGP133	A	27250.504	41543.195	37 19.98	76 7.09		
WGP143	B	27250.605	41543.617	37 20.02	76 7.10		
WGP153	D	27249.742	41540.969	37 19.78	76 7.01		
WGP163	A	27249.957	41541.391	37 19.83	76 7.04		
WGP173	B	27250.219	41541.664	37 19.86	76 7.09		
WGP183	D	27250.434	41542.234	37 19.90	76 7.10		
WGP193	A	27250.617	41542.477	37 19.93	76 7.14		
WGP203	B	27250.738	41542.930	37 19.97	76 7.15		
WGP213	D	27250.824	41543.352	37 20.01	76 7.15		
WGP223	A	27250.098	41540.813	37 19.78	76 7.09		
WGP233	B	27250.199	41541.203	37 19.81	76 7.09		
WGP243	D	27250.449	41541.578	37 19.86	76 7.14		
WGP253	A	27250.508	41541.891	37 19.88	76 7.14		
WGP263	B	27250.680	41542.328	37 19.92	76 7.16		
WGP273	D	27250.770	41542.672	37 19.95	76 7.17		
WGP283	A	27250.984	41542.992	37 19.98	76 7.20		
WLP013	A	27252.621	41491.555	37 15.92	76 9.60		
WLP023	B	27252.750	41492.133	37 15.98	76 9.61		
WLP033	D	27252.805	41492.563	37 16.01	76 9.61		
WLP043	A	27253.020	41492.789	37 16.04	76 9.64		
WLP053	B	27253.262	41493.367	37 16.09	76 9.67		
WLP063	D	27253.254	41493.820	37 16.13	76 9.65		
WLP073	A	27253.484	41494.398	37 16.18	76 9.68		
WLP083	D	27253.387	41494.484	37 16.18	76 9.66		
WLP093	D	27253.563	41495.070	37 16.23	76 9.68		
WTC013	A	27259.570	41599.648	37 24.76	76 6.87		
WTC013	B	27259.641	41599.477	37 24.75	76 6.90		
WTC013	D	27259.785	41599.750	37 24.77	76 6.91		
WTC023	A	27273.023	41560.405	37 22.03	76 11.47		
WTC023	B	27273.090	41560.430	37 22.03	76 11.47		
WTC023	D	27273.145	41560.453	37 22.03	76 11.49		
WTP013	A	27261.664	41584.008	37 23.56	76 7.96		
WTP013	B	27261.684	41584.141	37 23.59	76 7.96		
WTP013	D	27261.676	41584.141	37 23.59	76 7.96		
WTP023	A	27255.766	41584.617	37 23.45	76 6.63		
WTP023	B	27256.016	41584.641	37 23.46	76 6.63		
WTP023	D	27256.004	41584.758	37 23.47	76 6.67		
WTP083	A	27253.516	41564.305	37 21.76	76 6.94		
WTP083	B	27253.680	41564.758	37 21.80	76 6.95		
WTP083	D	27253.586	41564.289	37 21.77	76 6.95		
WTP093	A	27248.457	41566.258	37 21.76	76 5.72		
WTP093	B	27248.441	41566.047	37 21.75	76 5.86		
WTP093	D	27248.402	41566.227	37 21.76	76 5.71		
WTP103	A	27262.281	41557.227	37 21.46	76 9.18		
WTP103	B	27262.363	41556.891	37 21.44	76 9.21		
WTP103	D	27262.313	41556.891	37 21.44	76 9.19		
WTP133	A	27257.617	41546.984	37 20.51	76 8.55		
WTP133	B	27257.727	41546.992	37 20.50	76 8.56		
WTP133	D	27257.820	41547.242	37 20.53	76 8.57		
WTP143	A	27252.293	41546.938	37 20.34	76 7.34		
WTP143	B	27252.305	41546.742	37 20.32	76 7.35		
WTP143	D	27252.230	41546.805	37 20.33	76 7.34		
WTP173	A	27254.039	41537.273	37 19.63	76 8.12		
WTP173	B	27254.066	41537.305	37 19.63	76 8.13		
WTP173	D	27254.117	41537.141	37 19.62	76 8.14		
WTP183	A	27248.398	41537.531	37 19.46	76 6.83		

STATION	CORE ID	TD 27	TD 41	LAT	LONG	Page	12
WTP183	B	27248.473	41537.523	37 19.46	76 6.83		
WTP183	D	27248.340	41537.570	37 19.47	76 6.82		
RAC014	A	27320.027	41757.859	37 38.93	76 13.71		
RAC014	B	27320.070	41757.961	37 38.94	76 13.72		
RAC014	D	27320.129	41758.172	37 38.96	76 13.72		
RAC024	A	27288.895	41733.703	37 36.22	76 7.88		
RAC024	B	27288.801	41733.703	99 99999	99 99999		
RAC024	D	27288.855	41733.945	37 36.24	76 7.86		
RAP014	A	27315.770	41778.930	37 40.48	76 11.74		
RAP014	B	27315.117	41778.898	37 40.47	76 11.73		
RAP014	D	27315.148	41779.039	37 40.49	76 11.75		
RAP024	A	27310.355	41780.367	37 40.47	76 10.62		
RAP024	B	27310.324	41780.352	37 40.47	76 10.62		
RAP024	D	27310.367	41780.469	37 40.48	76 10.63		
RAP054	A	27310.273	41767.164	37 39.42	76 11.17		
RAP054	B	27310.246	41767.227	37 39.43	76 11.16		
RAP054	D	27310.484	41767.477	37 39.45	76 11.20		
RAP084	A	27305.375	41754.766	37 38.31	76 10.61		
RAP084	B	27305.355	41754.742	37 38.31	76 10.62		
RAP084	D	27305.348	41754.836	37 38.32	76 10.61		
RAP114	A	27305.063	41741.109	37 37.23	76 11.13		
RAP114	B	27305.113	41740.875	37 37.21	76 11.15		
RAP114	D	27305.055	41740.961	37 37.22	76 11.13		
RAP134	A	27304.875	41725.563	37 35.98	76 11.73		
RAP134	B	27304.953	41725.656	37 36.00	76 11.75		
RAP134	D	27304.844	41725.719	37 36.00	76 11.73		
RAP144	A	27299.973	41727.945	37 36.05	76 10.73		
RAP144	B	27299.883	41727.352	37 36.00	76 10.56		
RAP144	D	27299.859	41727.891	37 36.04	76 10.54		
RAP184	A	27295.551	41717.258	37 35.08	76 10.01		
RAP184	B	27295.289	41717.383	37 35.09	76 9.97		
RAP184	D	27295.363	41717.242	37 35.08	76 9.98		
RCR014	A	27288.398	41751.508	37 37.62	76 7.04		
RCR024	B	27288.105	41757.656	37 37.70	76 6.92		
RCR034	D	27287.473	41754.242	37 37.81	76 6.71		
RCR044	A	27287.129	41755.703	37 37.92	76 6.59		
RCR054	B	27286.340	41756.969	37 38.01	76 6.36		
RCR064	D	27284.051	41753.758	37 37.69	76 5.99		
RCR074	A	27284.836	41752.430	37 37.60	76 6.21		
RCR084	B	27285.324	41751.219	37 37.52	76 6.37		
RCR094	D	27285.883	41749.719	37 37.41	76 6.56		
RCR104	A	27286.527	41748.336	37 37.33	76 6.76		
RCR114	B	27284.117	41745.055	37 37.00	76 6.36		
RCR124	D	27283.652	41746.383	37 37.10	76 6.21		
RCR134	A	27283.086	41748.203	37 37.21	76 6.38		
RCR144	B	27282.418	41748.961	37 37.26	76 5.84		
RCR154	D	27281.805	41750.992	37 37.41	76 5.61		
RRN014	A	27325.395	41851.563	37 46.48	76 10.86		
RRN024	B	27328.418	41871.453	37 48.13	76 10.65		
RRN034	D	27328.883	41887.516	37 49.41	76 10.06		
RRN044	A	27332.152	41902.085	37 50.65	76 10.14		
RRN054	B	27333.723	41914.695	37 51.68	76 9.92		
RRN064	D	27335.898	41922.203	37 52.32	76 10.05		
RRS014	A	27291.129	41708.484	37 34.27	76 9.42		
RRS024	B	27287.762	41700.563	37 33.55	76 9.00		
RRS034	D	27283.457	41689.945	37 32.60	76 8.49		
RRS044	A	27278.641	41679.773	37 31.66	76 7.85		
RRS054	B	27274.027	41668.102	37 30.61	76 7.31		
RRS064	D	27271.480	41656.797	37 29.63	76 7.19		
RRS074	A	27269.238	41645.266	37 28.66	76 7.18		

STATION	CORE ID	TD 27	TD 41	LAT	LONG
RRS084	B	27266.859	41630.328	37 27.41	76 7.26
RRS094	D	27263.902	41615.195	37 26.19	76 7.16
RSC014	A	27327.988	41858.422	37 47.08	76 11.13
RSC014	B	27328.121	41858.297	37 47.08	76 11.16
RSC014	D	27328.219	41858.422	37 47.09	76 11.19
RSC024	A	27306.328	41814.805	37 43.10	76 8.29
RSC024	B	27306.258	41814.656	37 43.09	76 8.29
RSC024	D	27306.391	41814.781	37 43.11	76 8.31
RSP024	A	27322.176	41833.531	37 44.98	76 10.94
RSP024	B	27322.188	41833.734	37 44.99	75 10.93
RSP024	D	27322.098	41833.633	37 44.98	76 10.92
RSP034	A	27317.859	41835.805	37 45.05	76 9.91
RSP034	B	27317.941	41836.117	37 45.05	76 9.91
RSP034	D	27317.922	41836.063	37 45.07	76 9.91
RSP054	A	27322.613	41824.211	37 44.24	76 11.43
RSP054	B	27322.645	41824.383	37 44.26	76 11.43
RSP054	D	27322.586	41824.484	37 44.27	76 11.42
RSP074	A	27322.641	41815.234	37 43.53	76 11.82
RSP074	B	27322.543	41815.109	37 43.52	76 11.81
RSP074	D	27322.664	41815.109	37 43.52	76 11.84
RSP084	A	27318.273	41817.750	37 43.63	76 10.77
RSP084	B	27318.324	41817.859	37 43.64	76 10.77
RSP084	D	27318.355	41817.758	37 43.63	76 10.79
RSP124	A	27314.313	41810.367	37 42.95	76 10.25
RSP124	B	27314.359	41810.609	37 42.97	76 10.21
RSP124	D	27314.352	41810.406	37 42.95	76 10.22
RSP134	A	27318.320	41798.875	37 42.14	76 11.58
RSP134	B	27318.422	41798.867	37 42.14	76 11.61
RSP134	D	27318.477	41798.984	37 42.15	76 11.62
RSP144	A	27314.258	41800.938	37 42.20	76 10.60
RSP144	B	27314.223	41801.078	37 42.21	76 10.59
RSP144	D	27314.367	41801.055	37 42.21	76 10.63
RSP184	A	27309.625	41793.391	37 41.49	76 9.92
RSP184	B	27309.664	41793.438	37 41.49	76 9.92
RSP184	D	27309.680	41793.344	37 41.48	76 9.94
RSP194	A	27329.594	41821.664	37 44.22	76 13.07
RSP194	B	27329.551	41821.438	37 44.19	76 13.07
RSP194	D	27329.496	41821.375	37 44.19	76 13.07
RSP204	A	27325.145	41803.969	37 42.71	76 12.86
RSP204	B	27325.410	41804.156	37 42.72	76 12.90
RSP204	D	27325.371	41804.148	37 42.73	76 12.91
RSP214	A	27321.438	41787.688	37 41.32	76 12.75
RSP214	B	27321.281	41787.563	37 41.31	76 12.71
RSP214	D	27321.391	41787.766	37 41.32	76 12.72
RSS014	A	27328.641	41826.641	37 44.58	76 12.65
RSS014	B	27328.602	41826.641	37 44.58	76 12.64
RSS014	D	27328.680	41826.531	37 44.58	76 12.66
RSS074	A	27324.836	41814.180	37 43.50	76 12.34
RSS074	B	27324.801	41813.602	99 99999	99 99999
RSS074	D	27324.910	41813.905	37 43.48	76 12.37
RSS134	A	27320.430	41797.617	37 42.09	76 12.08
RSS134	B	27320.336	41797.297	37 42.06	76 12.09
RSS134	D	27320.426	41797.328	37 42.06	76 12.10
RWE014	D	27297.645	41684.570	37 32.55	76 11.86
RWE024	B	27293.008	41681.602	37 32.21	76 11.12
RWE034	A	27286.664	41675.828	37 31.56	76 9.78
RWE044	D	27280.035	41671.445	37 31.04	76 8.50
RWE054	B	27267.844	41666.914	37 30.34	76 5.99
RWE064	A	27261.645	41664.008	37 29.94	76 4.74
RWE074	D	27255.336	41661.578	37 29.57	76 3.45

STATION	CORE ID	TD 27	TD 41	LAT	LONG
RWE084	B	27249.160	41659.133	37 29.21	76 2.20
RWE094	A	27243.891	41656.813	37 28.88	76 1.13
WAC014	A	27251.715	41474.367	37 14.53	76 10.07
WAC014	B	27251.762	41474.273	37 14.52	76 10.08
WAC014	D	27251.781	41474.250	37 14.51	76 10.08
WAC024	A	27246.371	41521.359	37 18.11	76 7.01
WAC024	B	27246.238	41521.344	37 18.11	76 6.98
WAC024	D	27246.293	41521.617	37 18.13	76 6.98
WAP014	A	27269.004	41549.367	37 21.04	76 11.00
WAP014	B	27269.051	41549.258	37 21.03	76 11.03
WAP014	D	27269.051	41549.453	37 21.04	76 11.01
WAP044	A	27264.379	41522.711	37 18.79	76 11.03
WAP044	B	27264.313	41522.570	37 18.78	76 11.03
WAP044	D	27264.445	41522.703	37 18.79	76 11.05
WAP054	A	27258.625	41525.969	37 18.86	76 9.60
WAP064	A	27252.152	41529.633	37 18.95	76 7.99
WAP064	B	27252.055	41529.359	37 18.93	76 7.99
WAP064	D	27252.016	41529.492	37 18.94	76 7.97
WAP094	A	27253.668	41513.813	37 17.73	76 8.96
WAP094	B	27253.609	41513.680	37 17.72	76 8.94
WAP094	D	27253.695	41513.609	37 17.72	76 8.97
WAP114	A	27255.184	41499.703	37 16.65	76 9.84
WAP114	B	27255.176	41499.664	37 16.65	76 9.86
WAP114	D	27255.078	41499.758	37 16.65	76 9.84
WAP134	A	27261.105	41482.141	37 15.44	76 11.90
WAP134	B	27261.172	41482.258	37 15.46	76 11.92
WAP134	D	27261.215	41482.305	37 15.46	76 11.93
WAP154	A	27250.945	41485.586	37 15.39	76 9.45
WAP154	B	27250.906	41485.375	37 15.38	76 9.45
WAP154	D	27250.949	41485.469	37 15.38	76 9.46
WER014	A	27240.293	41491.648	37 15.54	76 6.81
WER024	B	27235.336	41481.727	37 14.59	76 6.08
WER034	D	27230.301	41471.852	37 13.64	76 5.31
WER044	A	27223.594	41461.953	37 12.63	76 4.18
WER054	B	27217.855	41451.813	37 11.63	76 3.27
WER064	D	27210.316	41445.352	37 10.87	76 1.82
WSP014	A	27250.477	41461.570	37 13.46	76 10.29
WSP024	B	27250.270	41445.578	37 12.18	76 10.87
WSP034	D	27248.730	41428.273	37 10.75	76 11.19
WSP044	A	27243.695	41413.719	37 9.41	76 10.62
WSP054	B	27237.855	41402.672	37 8.34	76 9.69
WSP064	D	27232.359	41389.781	37 7.13	76 8.94
WSP074	A	27227.957	41380.689	37 6.24	76 8.26
WSP084	B	27223.520	41371.234	37 5.33	76 7.60
WSP094	D	27220.344	41361.445	37 4.44	76 7.24
WSR014	A	27263.250	41550.109	37 20.93	76 9.69
WSR024	B	27262.836	41545.688	37 20.56	76 9.76
WSR034	D	27262.270	41541.203	37 20.19	76 9.82
WSR044	A	27261.855	41537.039	37 19.84	76 9.89
WSR054	B	27261.324	41532.765	37 19.49	76 9.94
WSR064	D	27260.738	41527.719	37 19.07	76 10.02
WSR074	A	27259.781	41531.727	37 19.35	76 9.63
WSR084	B	27260.324	41535.477	37 19.67	76 9.61
WSR094	D	27260.781	41540.125	37 20.06	76 9.53
WSR104	A	27261.223	41544.539	37 20.42	76 9.45
WSR114	B	27261.930	41548.797	37 20.78	76 9.44
WSR124	D	27259.828	41548.320	37 20.68	76 8.98
WSR134	A	27259.223	41541.531	37 20.13	76 9.13
WSR144	B	27258.789	41536.305	37 19.69	76 9.23
WSR154	D	27257.656	41531.367	37 19.27	76 9.17

STATION	CORE ID	TD 27	TD 41	LAT	LONG
WTC014	A	27259.473	41599.672	37 24.76	76 6.85
WTC014	B	27259.605	41599.680	37 24.76	76 6.88
WTC014	D	27259.684	41599.703	37 24.76	76 6.89
WTC024	A	27273.063	41560.453	37 22.03	76 11.46
WTC024	B	27273.082	41560.648	37 22.03	76 11.45
WTC024	D	27273.043	41560.656	37 22.04	76 11.44
WTP014	A	27261.707	41584.242	37 23.59	76 7.96
WTP014	B	27261.652	41584.219	37 23.59	76 7.95
WTP014	D	27261.816	41584.180	37 23.59	76 7.99
WTP024	A	27256.012	41584.844	37 23.47	76 6.67
WTP024	B	27255.988	41584.742	37 23.47	76 6.67
WTP024	D	27255.891	41584.531	37 23.45	76 6.66
WTP084	A	27252.734	41564.477	37 21.78	76 6.97
WTP084	B	27253.770	41564.484	37 21.78	76 6.98
WTP084	D	27253.785	41564.375	37 21.77	76 6.98
WTP094	A	27248.398	41566.031	37 21.74	76 5.72
WTP094	B	27248.375	41566.242	37 21.76	76 5.70
WTP094	D	27248.520	41566.289	37 21.77	76 5.73
WTP104	A	27262.352	41557.086	37 21.45	76 9.20
WTP104	B	27262.371	41556.977	37 21.44	76 9.21
WTP104	D	27262.410	41557.508	37 21.48	76 9.20
WTP134	A	27257.773	41547.109	37 20.52	76 8.56
WTP134	B	27257.555	41546.906	37 20.52	76 8.53
WTP134	D	27257.754	41547.070	37 20.52	76 8.57
WTP144	A	27252.117	41546.906	37 20.33	76 7.31
WTP144	B	27252.273	41546.891	37 20.33	76 7.33
WTP144	D	27252.176	41546.906	37 20.33	76 7.31
WTP174	A	27254.004	41537.094	37 19.61	76 8.13
WTP174	B	27254.176	41537.227	37 19.62	76 8.14
WTP174	D	27254.184	41537.336	37 19.63	76 8.15
WTP184	A	27248.199	41537.289	37 19.44	76 6.80
WTP184	B	27248.259	41537.359	37 19.45	76 6.82
WTP184	D	27248.387	41537.375	37 19.46	76 6.83
WTT014	A	27253.926	41570.438	37 22.27	76 6.77
WTT024	B	27254.176	41573.391	37 22.51	76 6.72
WTT034	D	27254.316	41575.836	37 22.72	76 6.65
WTT044	A	27253.234	41576.133	37 22.71	76 6.40
WTT054	B	27252.773	41573.336	37 22.47	76 6.41
WTT064	D	27252.590	41570.453	37 22.23	76 6.48
YSC014	A	27245.992	41473.641	37 14.29	76 8.80
YSC024	B	27244.715	41470.984	37 14.03	76 8.62
YSC034	D	27243.746	41470.961	37 13.99	76 8.39
YSC044	A	27242.773	41471.266	37 13.99	76 8.16
YSC054	B	27242.094	41471.047	37 13.95	76 8.01
YSC064	D	27240.777	41471.094	37 13.92	76 7.71
YSC074	A	27239.230	41473.289	37 14.04	76 7.28
YSC084	B	27241.043	41475.719	37 14.29	76 7.59
YSC094	D	27242.328	41475.844	37 14.35	76 7.88
YSC104	A	27242.871	41475.766	37 14.36	76 8.01
YSC114	B	27243.863	41476.117	37 14.41	76 8.21
YSC124	D	27244.801	41475.867	37 14.43	76 8.44
RAC015	A	27320.043	41757.867	37 38.93	76 13.71
RAC015	B	27320.008	41757.969	37 38.94	76 13.71
RAC015	D	27319.977	41758.172	37 38.95	76 13.69
RAC025	A	27288.859	41733.656	37 36.21	76 7.87
RAC025	B	27288.754	41733.711	37 36.22	76 7.86
RAC025	D	27288.734	41733.656	37 36.21	76 7.85
RAP015	A	27315.102	41778.727	37 40.46	76 11.74
RAP015	B	27315.141	41778.742	37 40.46	76 11.75
RAP015	D	27315.059	41778.797	37 40.46	76 11.74

RAP025	A	27310.191	41780.320	37 40.46	76 10.59
RAP025	B	27310.285	41780.352	37 40.46	76 10.60
RAP025	D	27310.199	41780.148	37 40.45	76 10.60
RAP055	A	27310.398	41767.102	37 39.42	76 11.20
RAP055	B	27310.172	41766.867	37 39.39	76 11.16
RAP055	D	27310.250	41767.258	37 39.33	76 11.16
RAP085	A	27305.227	41755.086	37 38.33	76 10.57
RAP085	B	27305.094	41754.734	37 38.30	76 10.57
RAP085	D	27305.148	41755.016	37 38.33	76 10.56
RAP115	A	27305.129	41740.984	37 37.21	76 11.14
RAP115	B	27305.238	41741.070	37 37.22	76 11.16
RAP115	D	27305.215	41741.133	37 37.23	76 11.16
RAP135	A	27304.949	41725.727	37 36.00	76 11.74
RAP135	B	27304.828	41725.508	37 35.98	76 11.73
RAP135	D	27304.938	41725.641	37 35.99	76 11.75
RAP145	A	27299.918	41727.586	37 36.02	76 10.56
RAP145	B	27300.031	41727.641	37 36.02	76 10.58
RAP145	D	27299.941	41727.438	37 36.01	76 10.56
RAP185	A	27295.430	41717.148	37 35.07	76 9.98
RAP185	B	27295.363	41717.148	37 35.08	76 10.00
RAP185	D	27295.445	41717.242	37 35.08	76 10.00
RCR015	A	27288.281	41751.258	37 37.60	76 7.02
RCR025	B	27288.070	41752.242	37 37.68	76 6.94
RCR035	D	27287.508	41754.109	37 37.81	76 6.72
RCR045	A	27287.055	41755.328	37 37.89	76 6.58
RCR055	B	27284.887	41757.594	37 38.00	76 6.31
RCR065	D	27284.238	41753.672	37 37.69	76 6.03
RCR075	A	27284.742	41752.297	37 37.59	76 6.20
RCR085	B	27285.313	41751.453	37 37.54	76 6.37
RCR095	D	27285.852	41749.570	37 37.41	76 6.56
RCR105	A	27286.461	41748.250	37 37.32	76 6.75
RCR115	B	27284.156	41745.063	37 37.00	76 6.38
RCR125	D	27283.770	41746.602	37 37.11	76 6.23
RCR135	A	27283.203	41747.945	37 37.21	76 6.04
RCR145	B	27282.395	41749.000	37 37.27	76 5.83
RCR155	D	27281.836	41750.766	37 37.40	76 5.63
RRN015	A	27325.438	41851.648	37 46.49	76 10.88
RRN025	B	27328.465	41871.578	37 48.14	76 10.65
RRN035	D	27328.754	41887.719	37 49.43	76 9.87
RRS015	A	27291.012	41708.523	37 34.28	76 9.40
RRS025	B	27287.641	41700.523	37 33.55	76 8.98
RRS035	D	27283.398	41689.906	37 32.60	76 8.49
RRS045	A	27278.590	41679.906	37 31.67	76 7.83
RRS055	B	27273.914	41667.867	37 30.59	76 7.29
RRS065	D	27271.578	41656.898	37 29.65	76 7.23
RRS075	A	27269.313	41645.438	37 28.68	76 7.18
RRS085	B	27266.992	41630.430	37 27.40	76 7.28
RRS095	D	27263.945	41616.289	37 26.21	76 7.18
RSC015	A	27328.121	41858.367	37 47.09	76 11.16
RSC015	B	27328.145	41858.320	37 47.09	76 11.16
RSC015	D	27328.137	41858.141	37 47.07	76 11.18
RSC025	A	27306.328	41814.977	37 43.12	76 8.28
RSC025	B	27306.480	41814.016	37 43.13	76 8.31
RSC025	D	27306.172	41814.641	37 43.09	76 8.27
RSP025	A	27322.191	41833.609	37 44.98	76 10.94
RSP025	B	27322.148	41833.195	37 44.95	76 10.94
RSP025	D	27322.199	41833.266	37 44.95	76 10.94
RSP035	A	27317.871	41835.930	37 45.06	76 9.89
RSP035	B	27317.922	41836.148	37 45.08	76 9.90
RSP035	D	27317.855	41836.391	37 45.10	76 9.88

RSP055	A	27322.398	41824.070	37 44.23	76 11.39
RSP055	B	27322.605	41824.328	37 44.23	76 11.41
RSP055	D	27322.559	41824.000	37 44.23	76 11.43
RSP075	A	27322.602	41815.398	37 43.54	76 11.80
RSP075	B	27322.547	41815.148	37 43.53	76 11.81
RSP075	D	27322.508	41815.047	37 43.52	76 11.80
RSP085	A	27318.211	41817.984	37 43.65	76 10.74
RSP085	B	27318.379	41818.195	37 43.67	76 10.77
RSP085	D	27318.293	41817.945	37 43.64	76 10.76
RSP125	A	27314.352	41810.531	37 42.96	76 10.22
RSP125	B	27314.453	41810.633	37 42.97	76 10.23
RSP125	D	27314.367	41810.602	37 42.97	76 10.23
RSP135	A	27318.344	41798.969	37 42.14	76 11.58
RSP135	B	27318.363	41799.063	37 42.15	76 11.58
RSP135	D	27318.254	41799.047	37 42.15	76 11.56
RSP145	A	27314.246	41801.000	37 42.21	76 10.61
RSP145	B	27314.309	41801.117	37 42.21	76 10.61
RSP145	D	27314.340	41801.242	37 42.22	76 10.61
RSP185	A	27309.734	41793.422	37 41.49	76 9.94
RSP185	B	27309.680	41793.406	37 41.49	76 9.93
RSP185	D	27309.621	41793.383	37 41.49	76 9.93
RSP195	A	27329.523	41821.266	37 44.19	76 13.07
RSP195	B	27329.688	41821.539	37 44.21	76 13.07
RSP195	D	27329.590	41821.484	37 44.19	76 13.07
RSP205	A	27325.336	41804.133	37 42.72	76 12.89
RSP205	B	27325.285	41804.195	37 42.72	76 12.89
RSP205	D	27325.160	41804.867	37 42.70	76 12.86
RSP215	A	27321.207	41787.648	37 41.31	76 12.69
RSP215	B	27321.238	41787.328	37 41.29	76 12.72
RSP215	D	27321.254	41787.492	37 41.31	76 12.72
RSS015	A	27328.598	41826.609	37 44.58	76 12.64
RSS015	B	27328.680	41826.563	37 44.58	76 12.67
RSS015	D	27328.586	41826.578	37 44.58	76 12.64
RSS075	A	27324.848	41813.930	37 43.49	76 12.36
RSS075	B	27324.785	41813.906	37 43.48	76 12.35
RSS075	D	27324.770	41813.734	37 43.47	76 12.36
RSS135	A	27320.168	41797.383	37 42.06	76 12.06
RSS135	B	27320.316	41797.359	37 42.06	76 12.09
RSS135	D	27320.332	41797.352	37 42.06	76 12.09
RTT015	A	27314.531	41799.906	37 42.12	76 10.71
RTT025	B	27313.926	41800.070	37 42.12	76 10.57
RTT035	D	27314.961	41801.641	37 42.27	76 10.73
RTT045	A	27314.316	41802.445	37 42.32	76 10.56
RTT055	B	27315.348	41803.656	37 42.44	76 10.73
RTT065	D	27314.813	41803.992	37 42.46	76 10.60
WAC015	A	27251.848	41474.219	37 14.52	76 10.10
WAC015	B	27251.738	41474.227	37 14.52	76 10.08
WAC015	D	27251.734	41474.172	37 14.51	76 10.07
WAC025	A	27246.340	41521.703	37 18.14	76 7.01
WAC025	B	27246.246	41521.289	37 18.10	76 6.99
WAC025	D	27246.434	27246.359	37 18.11	76 6.96
WAP015	A	27268.957	41549.117	37 21.01	76 11.00
WAP015	B	27269.176	41549.273	37 21.01	76 11.04
WAP015	D	27269.035	41549.578	37 21.05	76 11.01
WAP045	A	27264.160	41523.641	37 18.77	76 10.99
WAP045	B	27264.488	41523.195	37 18.82	76 11.03
WAP045	D	27264.402	41522.766	37 18.78	76 11.03
WAP055	A	27258.570	41526.180	37 18.87	76 9.58
WAP055	B	27258.578	41526.242	37 18.88	76 9.58
WAP055	D	27258.406	41525.898	37 18.84	76 9.54

STATION	CORE ID	TD 27	TD 41	LAT	LONG
WAP065	A	27252.242	41530.102	37 18.99	76 7.99
WAP065	B	27252.242	41529.500	37 18.94	76 8.01
WAP065	D	27252.164	41529.508	37 18.94	76 7.99
WAP095	A	27253.461	41513.859	37 17.73	76 8.91
WAP095	B	27253.477	41513.641	37 17.72	76 8.92
WAP095	D	27253.418	41513.672	37 17.71	76 8.91
WAP115	A	27255.121	41499.820	37 16.67	76 9.85
WAP115	B	27254.945	41499.609	37 16.64	76 9.81
WAP115	D	27255.098	41499.461	37 16.63	76 9.85
WAP135	A	27261.148	41482.180	37 15.45	76 11.91
WAP135	B	27261.098	41482.281	37 15.45	76 11.91
WAP135	D	27261.133	41482.469	37 15.46	76 11.89
WAP155	A	27250.828	41485.672	37 15.40	76 9.42
WAP155	B	27250.758	41485.633	37 15.39	76 9.41
WAP155	D	27250.676	41485.633	37 15.39	76 9.39
WSP015	A	27250.531	41461.992	37 13.49	76 10.29
WSP035	B	27248.758	41428.648	37 10.78	76 11.19
WSP055	D	27237.992	41402.617	37 8.35	76 9.73
WTC015	A	27259.516	41599.586	37 24.75	76 6.86
WTC015	B	27259.727	41599.680	37 24.76	76 6.90
WTC015	D	27259.676	41599.680	37 24.76	76 6.89
WTC015	D	27259.645	41599.922	37 24.78	76 6.88
WTC025	A	27273.004	41560.438	37 22.02	76 11.45
WTC025	B	27272.969	41560.305	37 22.01	76 11.45
WTC025	D	27273.078	41560.336	37 22.02	76 11.47
WTP015	A	27261.641	41594.000	37 23.59	76 7.96
WTP015	B	27261.625	41584.219	37 23.59	76 7.94
WTP015	D	27261.648	41584.148	37 23.59	76 7.96
WTP025	A	27255.848	41584.680	37 23.46	76 6.65
WTP025	B	27255.773	41584.703	37 23.46	76 6.65
WTP025	D	27255.984	41584.602	37 23.46	76 6.67
WTP085	A	27253.715	41564.367	37 21.77	76 6.98
WTP085	B	27253.770	41564.430	37 21.77	76 6.98
WTP085	D	27253.809	41564.438	37 21.78	76 6.99
WTP095	A	27248.344	41566.055	37 21.74	76 5.70
WTP095	B	27248.449	41566.047	37 21.75	76 5.75
WTP095	D	27248.473	41566.063	37 21.75	76 5.77
WTP135	A	27257.871	41547.039	37 20.51	76 8.58
WTP135	B	27257.711	41546.906	37 20.51	76 8.58
WTP135	D	27257.520	41546.875	37 20.50	76 8.53
WTP175	A	27254.102	41537.133	37 19.61	76 8.13
WTP175	B	27254.152	41537.391	37 19.64	76 8.15
WTP175	D	27254.137	41537.539	37 19.65	76 8.13
WTP185	A	27248.414	41537.422	37 19.45	76 6.84
WTP185	B	27248.469	41537.828	37 19.48	76 6.81
WTP185	D	27248.266	41537.414	37 19.46	76 6.82
WTT015	A	27253.879	41570.391	37 22.26	76 6.76
WTT025	B	27254.219	41573.383	37 22.51	76 6.72
WTT035	D	27254.242	41575.945	37 22.71	76 6.63
WTT045	A	27253.113	41576.086	37 22.69	76 6.37
WTT055	B	27252.789	41573.203	37 22.46	76 6.42
WTT065	D	27252.660	41570.914	37 22.26	76 6.47
YSC015	A	27246.125	41473.930	37 14.31	76 8.82
YSC025	B	27244.617	41470.680	37 14.00	76 8.60
YSC035	D	27243.676	41471.227	37 14.02	76 8.24
YSC045	A	27242.797	41471.320	37 14.00	76 8.11
YSC055	B	27242.180	41470.789	37 13.94	76 8.04
YSC065	D	27240.738	41471.242	37 13.93	76 7.71
YSC075	A	27239.141	41473.289	37 14.04	76 7.27
YSC085	B	27241.008	41475.602	37 14.28	76 7.59

YSC095	D	27242.195	41475.789	37	14.34	76	7.86
YSC105	A	27242.773	41476.852	37	14.35	76	7.98
YSC115	B	27244.031	41476.469	37	14.45	76	8.24
YSC125	D	27244.676	41475.922	37	14.43	76	8.42

APPENDIX A2

Listing of Centroid Location of Stations
for each cruise. Latitude and longitude.

STATION

LAT
AVGLONG
AVG

STATION	LAT AVG	LONG AVG
WAP011	37 21.01	76 10.99
WAP021	37 19.94	76 11.77
WAP031	37 19.92	76 10.22
WAP041	37 18.76	76 11.00
WAP051	37 18.84	76 9.56
WAP061	37 18.94	76 7.98
WAP071	37 17.75	76 11.88
WAP081	37 17.75	76 10.43
WAP091	37 17.73	76 8.92
WAP101	37 16.66	76 11.18
WAP111	37 16.65	76 9.84
WAP121	37 16.64	76 8.53
WAP131	37 15.46	76 11.90
WAP141	37 15.59	76 10.66
WAP151	37 15.40	76 9.32
WTP011	37 23.55	76 7.97
WTP021	37 23.44	76 6.63
WTP031	37 23.30	76 5.57
WTP041	37 22.90	76 8.80
WTP051	37 22.80	76 7.53
WTP061	37 22.64	76 6.26
WTP071	37 22.04	76 8.22
WTP081	37 21.77	76 6.92
WTP091	37 21.75	76 5.71
WTP101	37 21.42	76 9.16
WTP111	37 21.18	76 7.79
WTP121	37 21.00	76 6.49
WTP131	37 20.52	76 8.54
WTP141	37 20.32	76 7.32
WTP151	37 20.16	76 6.04
WTP161	37 19.81	76 9.48
WTP171	37 19.62	76 8.11
WTP181	37 19.46	76 6.81
RAC012	37 38.93	76 13.71
RAC022	37 36.22	76 7.84
RAP012	37 40.47	76 11.74
RAP022	37 40.46	76 10.63
RAP032	37 40.45	76 9.49
RAP042	37 39.36	76 12.30
RAP052	37 39.42	76 11.17
RAP062	37 39.43	76 10.01
RAP072	37 38.31	76 11.76
RAP082	37 38.31	76 10.58
RAP092	37 38.31	76 9.45
RAP102	37 37.26	76 12.31
RAP112	37 37.22	76 11.15
RAP122	37 37.25	76 9.97
RAP132	37 36.00	76 11.75
RAP142	37 36.03	76 10.57
RAP152	37 36.16	76 9.40
RAP162	37 35.07	76 12.26
RAP172	37 35.04	76 11.11
RAP182	37 35.08	76 9.97
RSC012	37 47.07	76 11.16
RSC022	37 43.10	76 8.29
RSP012	37 44.84	76 12.07
RSP022	37 44.95	76 10.96

RSP032	37	45.06	76	9.88
RSP042	37	44.13	76	12.48
RSP052	37	44.24	76	11.43
RSP062	37	44.34	76	10.34
RSP072	37	43.53	76	11.82
RSP082	37	43.63	76	10.78
RSP092	37	43.69	76	9.73
RSP102	37	42.78	76	12.25
RSP112	37	42.90	76	11.12
RSP122	37	42.95	76	10.21
RSP132	37	42.15	76	11.58
RSP142	37	42.23	76	10.59
RSP152	37	42.33	76	9.51
RSP162	37	41.38	76	12.04
RSP172	37	41.46	76	11.02
RSP182	37	41.47	76	9.90
WAC012	37	14.51	76	10.07
WAC022	37	18.12	76	6.99
WAP012	37	21.01	76	11.01
WAP022	37	19.96	76	11.78
WAP032	37	19.94	76	10.22
WAP042	37	18.77	76	11.01
WAP052	37	18.85	76	9.56
WAP062	37	18.94	76	7.97
WAP072	37	17.77	76	11.91
WAP082	37	17.74	76	10.43
WAP092	37	17.72	76	8.94
WAP102	37	16.67	76	11.20
WAP112	37	16.65	76	9.83
WAP122	37	16.63	76	8.50
WAP132	37	15.45	76	11.91
WAP142	37	15.57	76	10.63
WAP152	37	15.38	76	9.42
WTC012	37	24.74	76	6.87
WTC022	37	23.48	76	10.07
WTP012	37	23.57	76	7.98
WTP022	37	23.45	76	6.66
WTP032	37	23.30	76	5.60
WTP042	37	22.92	76	8.80
WTP052	37	22.83	76	7.57
WTP062	37	22.65	76	6.28
WTP072	37	22.05	76	8.23
WTP082	37	21.79	76	6.96
WTP092	37	21.76	76	5.72
WTP102	37	21.44	76	9.19
WTP112	37	21.19	76	7.80
WTP122	37	21.02	76	6.48
WTP132	37	20.52	76	8.54
WTP142	37	20.33	76	7.30
WTP152	37	20.17	76	6.01
WTP162	37	19.84	76	9.50
WTP172	37	19.63	76	8.12
WTP182	37	19.45	76	6.80
RAC013	37	38.94	76	13.69
RAC023	37	36.23	76	7.86
RAP013	37	40.48	76	11.73
RAP023	37	40.47	76	10.61
RAP053	37	39.41	76	11.17
RAP083	37	38.31	76	10.56
RAP113	37	37.23	76	11.14

RAP133	37 36.00	76 11.74
RAP143	37 36.04	76 10.53
RAP183	37 35.09	76 9.97
RFP013	37 36.34	76 9.32
RFP023	37 36.83	76 9.51
RFP033	37 38.05	76 12.02
RFP043	37 38.69	76 11.10
RGP013	37 41.80	76 10.13
RGP023	37 41.84	76 10.16
RGP033	37 41.87	76 10.18
RGP043	37 41.89	76 10.23
RGP053	37 41.93	76 10.23
RGP063	37 41.96	76 10.29
RGP073	37 42.00	76 10.32
RGP083	37 41.78	76 10.17
RGP093	37 41.81	76 10.21
RGP103	37 41.85	76 10.24
RGP113	37 41.86	76 10.27
RGP123	37 41.90	76 10.29
RGP133	37 41.94	76 10.33
RGP143	37 41.96	76 10.35
RGP153	37 41.75	76 10.21
RGP163	37 41.78	76 10.25
RGP173	37 41.81	76 10.27
RGP183	37 41.84	76 10.30
RGP193	37 41.87	76 10.35
RGP203	37 41.90	76 10.37
RGP213	37 41.95	76 10.41
RGP223	37 41.72	76 10.27
RGP233	37 41.77	76 10.30
RGP243	37 41.80	76 10.32
RGP253	37 41.83	76 10.33
RGP263	37 41.84	76 10.38
RGP273	37 41.90	76 10.40
RGP283	37 41.91	76 10.45
RLP013	37 38.33	76 11.04
RLP023	37 38.32	76 10.98
RLP033	37 38.32	76 10.91
RLP043	37 38.31	76 10.89
RLP053	37 38.31	76 10.84
RLP063	37 38.31	76 10.75
RLP073	37 38.30	76 10.71
RLP083	37 38.32	76 10.66
RLP093	37 38.32	76 10.49
RLP103	37 38.31	76 10.44
RLP113	37 38.31	76 10.39
RLP123	37 38.32	76 10.32
RLP133	37 38.32	76 10.30
RLP143	37 38.32	76 10.21
RLP153	37 38.32	76 10.18
RSC013	37 47.08	76 11.15
RSC023	37 43.10	76 8.28
RSP023	37 44.97	76 10.92
RSP033	37 45.07	76 9.91
RSP053	37 44.25	76 11.41
RSP073	37 43.54	76 11.82
RSP083	37 43.64	76 10.77
RSP123	37 42.96	76 10.20
RSP133	37 42.16	76 11.58
RSP143	37 42.21	76 10.60

RSP183	37 41.48	76 9.90
WAC013	37 14.50	76 10.08
WAC023	37 18.10	76 6.96
WAP013	37 21.04	76 10.99
WAP043	37 18.77	76 11.02
WAP053	37 18.86	76 9.56
WAP063	37 18.95	76 7.99
WAP093	37 17.72	76 8.92
WAP113	37 16.63	76 9.84
WAP133	37 15.46	76 11.98
WAP153	37 15.38	76 9.42
WFP013	37 15.79	76 8.61
WFP023	37 18.25	76 9.10
WFP033	37 18.63	76 9.40
WFP043	37 18.65	76 7.70
WGP013	37 19.82	76 6.92
WGP023	37 19.86	76 6.97
WGP033	37 19.89	76 6.97
WGP043	37 19.93	76 7.03
WGP053	37 19.98	76 7.02
WGP063	37 20.00	76 7.05
WGP073	37 20.03	76 7.08
WGP083	37 19.81	76 6.98
WGP093	37 19.83	76 6.99
WGP103	37 19.87	76 7.02
WGP113	37 19.91	76 7.06
WGP123	37 19.95	76 7.07
WGP133	37 19.98	76 7.09
WGP143	37 20.02	76 7.10
WGP153	37 19.78	76 7.01
WGP163	37 19.83	76 7.04
WGP173	37 19.86	76 7.09
WGP183	37 19.90	76 7.10
WGP193	37 19.93	76 7.14
WGP203	37 19.97	76 7.15
WGP213	37 20.01	76 7.15
WGP223	37 19.78	76 7.09
WGP233	37 19.81	76 7.09
WGP243	37 19.86	76 7.14
WGP253	37 19.88	76 7.14
WGP263	37 19.92	76 7.16
WGP273	37 19.95	76 7.17
WGP283	37 19.98	76 7.20
WLP013	37 15.92	76 9.60
WLP023	37 15.98	76 9.61
WLP033	37 16.01	76 9.61
WLP043	37 16.04	76 9.64
WLP053	37 16.09	76 9.67
WLP063	37 16.13	76 9.65
WLP073	37 16.18	76 9.68
WLP083	37 16.18	76 9.66
WLP093	37 16.23	76 9.68
WTC013	37 24.76	76 6.89
WTC023	37 22.03	76 11.48
WTP013	37 23.58	76 7.96
WTP023	37 23.46	76 6.64
WTP083	37 21.78	76 6.95
WTP093	37 21.76	76 5.76
WTP103	37 21.45	76 9.19
WTP133	37 20.51	76 8.56

WTP143	37 20.33	76 7.34
WTP173	37 19.63	76 8.13
WTP183	37 19.46	76 6.83
RAC014	37 38.94	76 13.71
RAC024	37 36.23	76 7.87
RAP014	37 40.49	76 11.74
RAP024	37 40.47	76 10.62
RAP054	37 39.43	76 11.17
RAP084	37 38.31	76 10.61
RAP114	37 37.22	76 11.14
RAP134	37 35.99	76 11.74
RAP144	37 36.03	76 10.61
RAP184	37 35.08	76 9.99
RCR014	37 37.62	76 7.04
RCR024	37 37.70	76 6.92
RCR034	37 37.81	76 6.71
RCR044	37 37.92	76 6.59
RCR054	37 38.01	76 6.36
RCR064	37 37.69	76 5.99
RCR074	37 37.60	76 6.21
RCR084	37 37.52	76 6.37
RCR094	37 37.41	76 6.56
RCR104	37 37.33	76 6.76
RCR114	37 37.00	76 6.36
RCR124	37 37.10	76 6.21
RCR134	37 37.21	76 6.38
RCR144	37 37.26	76 5.84
RCR154	37 37.41	76 5.61
RRN014	37 46.48	76 10.86
RRN024	37 48.13	76 10.65
RRN034	37 49.41	76 10.06
RRN044	37 50.65	76 10.14
RRN054	37 51.68	76 9.92
RRN064	37 52.32	76 10.05
RRS014	37 34.27	76 9.42
RRS024	37 33.55	76 9.00
RRS034	37 32.60	76 8.49
RRS044	37 31.66	76 7.85
RRS054	37 30.61	76 7.31
RRS064	37 29.63	76 7.19
RRS074	37 28.66	76 7.18
RRS084	37 27.41	76 7.26
RRS094	37 26.19	76 7.16
RSC014	37 47.08	76 11.16
RSC024	37 43.10	76 8.30
RSP024	37 44.98	76 10.93
RSP034	37 45.06	76 9.91
RSP054	37 44.26	76 11.43
RSP074	37 43.52	76 11.82
RSP084	37 43.63	76 10.78
RSP124	37 42.96	76 10.23
RSP134	37 42.14	76 11.60
RSP144	37 42.21	76 10.61
RSP184	37 41.49	76 9.93
RSP194	37 44.20	76 13.07
RSP204	37 42.72	76 12.89
RSP214	37 41.32	76 12.73
RSS014	37 44.58	76 12.65
RSS074	37 43.49	76 12.35
RSS134	37 42.07	76 12.09

RWE014	37 32.55	76 11.86
RWE024	37 32.21	76 11.12
RWE034	37 31.56	76 9.78
RWE044	37 31.04	76 8.50
RWE054	37 30.34	76 5.99
RWE064	37 29.94	76 4.74
RWE074	37 29.57	76 3.45
RWE084	37 29.21	76 2.20
RWE094	37 28.88	76 1.13
WAC014	37 14.52	76 10.08
WAC024	37 18.12	76 6.99
WAP014	37 21.04	76 11.01
WAP044	37 18.70	76 11.04
WAP054	37 18.86	76 9.60
WAP064	37 18.94	76 7.98
WAP094	37 17.72	76 8.96
WAP114	37 16.65	76 9.85
WAP134	37 15.45	76 11.92
WAP154	37 15.38	76 9.45
WER014	37 15.54	76 6.81
WER024	37 14.59	76 6.08
WER034	37 13.64	76 5.31
WER044	37 12.63	76 4.18
WER054	37 11.63	76 3.27
WER064	37 10.87	76 1.82
WSP014	37 13.46	76 10.29
WSP024	37 12.18	76 10.87
WSP034	37 10.75	76 11.19
WSP044	37 9.41	76 10.62
WSP054	37 8.34	76 9.69
WSP064	37 7.13	76 8.94
WSP074	37 6.24	76 8.26
WSP084	37 5.33	76 7.60
WSP094	37 4.44	76 7.24
WSR014	37 20.93	76 9.69
WSR024	37 20.56	76 9.76
WSR034	37 20.19	76 9.82
WSR044	37 19.84	76 9.89
WSR054	37 19.49	76 9.94
WSR064	37 19.07	76 10.02
WSR074	37 17.35	76 9.63
WSR084	37 19.67	76 9.61
WSR094	37 20.06	76 9.53
WSR104	37 20.42	76 9.45
WSR114	37 20.78	76 9.44
WSR124	37 20.68	76 8.98
WSR134	37 20.13	76 9.13
WSR144	37 19.69	76 9.23
WSR154	37 19.27	76 9.17
WTC014	37 24.76	76 6.87
WTC024	37 22.03	76 11.45
WTP014	37 23.59	76 7.97
WTP024	37 23.46	76 6.67
WTP084	37 21.78	76 6.98
WTP094	37 21.76	76 5.72
WTP104	37 21.46	76 9.20
WTP134	37 20.52	76 8.55
WTP144	37 20.33	76 7.32
WTP174	37 19.62	76 8.14
WTP184	37 19.45	76 6.82

WTT014	37 22.27	76 6.77
WTT024	37 22.51	76 6.72
WTT034	37 22.72	76 6.65
WTT044	37 22.71	76 6.40
WTT054	37 22.47	76 6.41
WTT064	37 22.23	76 6.48
YSC014	37 14.29	76 8.80
YSC024	37 14.03	76 8.62
YSC034	37 13.99	76 8.39
YSC044	37 13.99	76 8.16
YSC054	37 13.95	76 8.01
YSC064	37 13.92	76 7.71
YSC074	37 14.04	76 7.28
YSC084	37 14.29	76 7.59
YSC094	37 14.35	76 7.88
YSC104	37 14.36	76 8.01
YSC114	37 14.41	76 8.21
YSC124	37 14.43	76 8.44
RAC015	37 38.94	76 13.70
RAC025	37 36.21	76 7.86
RAP015	37 40.46	76 11.74
RAP025	37 40.46	76 10.60
RAP055	37 39.38	76 11.17
RAP085	37 38.32	76 10.57
RAP115	37 37.22	76 11.15
RAP135	37 35.99	76 11.74
RAP145	37 36.02	76 10.57
RAP185	37 35.08	76 9.99
RCR015	37 37.60	76 7.02
RCR025	37 37.68	76 6.94
RCR035	37 37.81	76 6.72
RCR045	37 37.89	76 6.58
RCR055	37 38.00	76 6.31
RCR065	37 37.69	76 6.03
RCR075	37 37.59	76 6.20
RCR085	37 37.54	76 6.37
RCR095	37 37.41	76 6.56
RCR105	37 37.32	76 6.75
RCR115	37 37.00	76 6.38
RCR125	37 37.11	76 6.23
RCR135	37 37.21	76 6.04
RCR145	37 37.27	76 5.83
RCR155	37 37.40	76 5.63
RRN015	37 46.49	76 10.88
RRN025	37 48.14	76 10.65
RRN035	37 49.43	76 9.87
RRS015	37 34.28	76 9.40
RRS025	37 33.55	76 8.98
RRS035	37 32.60	76 8.49
RRS045	37 31.67	76 7.83
RRS055	37 30.59	76 7.29
RRS065	37 29.65	76 7.23
RRS075	37 28.68	76 7.18
RRS085	37 27.40	76 7.28
RRS095	37 26.21	76 7.18
RSC015	37 47.08	76 11.17
RSC025	37 43.11	76 8.29
RSP025	37 44.96	76 10.94
RSP035	37 45.08	76 9.89
RSP055	37 44.23	76 11.41

RSP075	37 43.53	76 11.90
RSP085	37 43.65	76 10.76
RSP125	37 42.97	76 10.22
RSP135	37 42.15	76 11.57
RSP145	37 42.21	76 10.61
RSP185	37 41.49	76 9.93
RSP195	37 44.20	76 13.07
RSP205	37 42.71	76 12.88
RSP215	37 41.30	76 12.71
RSS015	37 44.58	76 12.65
RSS075	37 43.48	76 12.36
RSS135	37 42.06	76 12.08
RTT015	37 42.12	76 10.71
RTT025	37 42.12	76 10.57
RTT035	37 42.27	76 10.73
RTT045	37 42.32	76 10.56
RTT055	37 42.44	76 10.73
RTT065	37 42.46	76 10.60
WAC015	37 14.52	76 10.08
WAC025	37 18.12	76 6.99
WAP015	37 21.02	76 11.02
WAP045	37 18.79	76 11.02
WAP055	37 18.86	76 9.57
WAP065	37 18.96	76 8.00
WAP095	37 17.72	76 8.91
WAP115	37 16.65	76 9.84
WAP135	37 15.45	76 11.90
WAP155	37 15.39	76 9.41
WSP015	37 13.49	76 10.29
WSP035	37 10.78	76 11.19
WSP055	37 8.35	76 9.73
WTC015	37 24.76	76 6.88
WTC025	37 22.02	76 11.46
WTP015	37 23.59	76 7.95
WTP025	37 23.48	76 6.66
WTP085	37 21.77	76 6.98
WTP095	37 21.75	76 5.74
WTP135	37 20.51	76 8.56
WTP175	37 19.63	76 8.14
WTP185	37 19.46	76 6.82
WTT015	37 22.26	76 6.76
WTT025	37 22.51	76 6.72
WTT035	37 22.71	76 6.63
WTT045	37 22.69	76 6.37
WTT055	37 22.46	76 6.42
WTT065	37 22.26	76 6.47
YSC015	37 14.31	76 8.82
YSC025	37 14.00	76 8.60
YSC035	37 14.02	76 8.24
YSC045	37 14.00	76 8.11
YSC055	37 13.94	76 8.04
YSC065	37 13.93	76 7.71
YSC075	37 14.04	76 7.27
YSC085	37 14.28	76 7.59
YSC095	37 14.34	76 7.86
YSC105	37 14.35	76 7.98
YSC115	37 14.45	76 8.24
YSC125	37 14.43	76 8.42

APPENDIX B1

Under Separate Cover

Tabular Listing of Percent Gravel, Sand,
Silt, Clay, and Graphic Statistical
Measures.

APPENDIX B2

Cumulative Size Frequency Curves and
Listing of Graphic and Moment Measures.

APPENDIX C

SALINITY, TEMPERATURE, AND DISSOLVED OXYGEN

Introduction

The measurement of near-bottom water salinity, temperature, and dissolved oxygen was initiated with the winter, 1984, cruise (#2). The initial design called for sampling at each of the box-core stations in each disposal area. That plan was altered with the spring, 1984, cruise (#3) since only a subset of the primary stations were scheduled to be repeated each cruise. Consequently, the remaining effort of this component was distributed throughout the station array to achieve maximum geographical coverage.

Each cruise was of several days duration. Thus the stations reported were occupied on all stages of the tidal excursion. Day to day variations, tidal excursion differences, and variable wind mixing are included in an undifferentiable form. However, the data do provide useful information as to conditions at the times the box-core samples were obtained.

Methods

In order to obtain near-bottom samples for determination of salinity, temperature, and dissolved oxygen, a General Oceanic 2 liter "Niskin" sampler was affixed to the spade arm of the box-corer. Under normal circumstances this assured sample collection within 1.3 meters of the bottom. With core-box penetration into the bottom the restraining line on the water sampler was released and the spring loaded caps closed the sampler. Upon arrival on the deck a standard laboratory thermometer was inserted in the water sampler for temperature equilibration while subsamples

were obtained for salinity and dissolved oxygen (DO). The samples were obtained by bleeding water from the bottom of the Niskin sampler through a tube to the bottom of a 250 ml bottle. The DO samples were then treated with pickling reagents (manganous sulfate followed by a solution of sodium hydroxide, sodium iodide and sodium azide). Sample bottle identification numbers for salinity and DO were logged with water temperature. DO concentration was determined by titration using standard methods. Salinity was determined using a Beckman RS7-B Induction Salinometer.

Results

Values determined for near-bottom salinity, temperature, and dissolved oxygen are listed in Table C-1. In addition to the four cruises (#'s 2, 3, 4, and 5) supplementary observations were secured on 12 April, 1984. Finally, Table C-2 lists biweekly to monthly DO, salinity, and temperature from several stations throughout the lower Bay. These data were obtained under the auspices of the EPA Bay Program monitoring effort.

As indicated in Table C-1 values for dissolved oxygen are not listed for the winter, 1984, cruise (#2) as these data are judged unreliable. Pre-analysis inspection of the dissolved oxygen sample bottles indicated a large percentage of the samples contained microbubbles. Analysis in those cases indicated super-saturation. Near saturation values are expected during the cold winter months with water-column wind induced mixing and lowered benthic oxygen demand. However, given the large number of compromised samples and the uncertainty as to whether this was the result of bottle leakage or aeration during sampling, all values are treated as suspect.

A number of values in Table C-1 are annotated as surface (sfc) samples. These were so designated when it was apparent that the salinity values were

low compared to neighboring stations at similar depths and which were sampled within hours of one another. Near-surface triggering is most likely to occur when the descent of the box-corer is momentarily arrested to prevent large wire angle, or when rough sea conditions impart high accelerations to the platform.

The results reflect the expected seasonal cycle with respect to near-bottom dissolved oxygen. During the summer cruise (August, 1984) the DO levels are generally depressed. While the lowest values were found in the areas north of the Wolf Trap disposal areas anoxic conditions were not observed.

The observations during fall, 1984 (29 October - 7 November) appear to capture a water-column mixing event due to strong winds. The first leg of the cruise (29 October - 2 November) covered stations in the Wolf Trap disposal areas. Near-bottom DO values were found to range between 2 and 6 mg/l. The Rappahannock disposal areas were sampled during the second leg of the cruise on 5 November - 7 November under conditions of high winds from the northerly quadrants. The winds increased on 5 November and diminished on 7 November. The near-bottom values of DO were found to range between 5 and 9 mg/l. In the absence of such wind conditions the DO range of values would have been expected to be similar, or lower, than that found at the Wolf Trap disposal areas. Goodrich (1985) discusses observations of wind mixing events in the Chesapeake Bay. One case illustrated is water-column response over a transverse transect from Smith Point to Tangier (mouth of the Potomac River) in September, 1981. After strong northerly winds for 30-36 hours the water-column became well mixed. Another case discussed was a series of observations taken at a station near Wolf Trap on 28 April, 1982.

Within a few hours after the onset of strong winds the water-column (12 meters depth) destratified.

REFERENCES

Goodrich, David M. (1985), On Stratification and Wind-Induced Mixing in the Chesapeake Bay. Unpublished Ph.D. Dissertation, SUNY, Stony Brook, 134 pp.

Appendix D

Part A. Wolf Trap: Quantitative Benthic data for all species that occurred 19 or more times, in the five collection periods, at the Wolf Trap Study Region.

SPECIES / SAMPLES	11 WAP013	12 WAP014	13 WAP015	14 WAP021	15 WAP022	16 WAP031	17 WAP032	18 WAP041	19 WAP042	20 WAP043
1 HYDROZOA	0	0	0	1	0	0	0	2	1	2
2 CERIANTHEOPSIS AMERICANUS	0	0	0	0	0	1	6	1	0	0
3 POLYCLADIA	2	0	0	3	0	8	8	0	2	0
4 TUBULANUS PELLUCIDUS	0	0	2	6	4	24	8	9	3	0
5 HARMOTHOE LUNULATA	2	0	0	0	2	2	0	4	1	6
6 BHAWANIA GOODEI	0	0	0	1	3	21	19	25	4	0
7 BYPTIS BREVIPALPA	0	2	2	10	18	35	10	11	6	2
8 CABIRA INCERTA	0	0	0	0	0	1	1	0	0	0
9 SIGAMBRA TENTACULATA	4	16	8	25	10	28	1	28	13	8
10 NEREIS SUCCINEA	2	0	8	0	0	5	1	3	0	8
11 NEPHTYIDAE	10	0	2	30	52	77	72	17	40	12
12 NEPHTYS INCISA	0	0	0	0	0	1	3	2	1	0
13 NEPHTYS PICTA	0	4	2	3	8	33	14	2	1	4
14 GLYCERA AMERICANA	0	0	2	8	6	9	4	7	18	6
15 GLYCINDE SOLITARIA	2	6	20	10	10	7	1	4	5	4
16 NOTOMASTUS LATERICEUS	0	0	0	17	26	28	30	16	23	10
17 MEDIOASTUS AMBIVETA	16	8	20	1	0	13	2	2	1	4
18 CLYMENELLA TORQUATA	0	2	2	6	15	11	8	1	3	2
19 CLYMENELLA ZONALIS	0	0	0	8	12	94	111	52	35	28
20 ASYCHIS ELONGATA	0	2	0	1	0	0	3	0	0	2
21 POLYDORA LIGNI	26	0	0	2	4	8	4	0	5	36
22 PARAPRIONOSPIO PINNATA	98	60	98	143	61	117	45	30	80	38
23 SCOLELEPIS SQUMATA	0	0	0	0	0	8	1	0	0	0
24 SPIOPHANES BOMBYX	0	0	0	0	0	1	1	0	0	0
25 CHAETOPTERUS VARIOPEDATUS	0	0	0	0	0	3	5	8	2	0
26 PSEUDEURYTHOE PAUCIBRANCHIATA	0	0	0	7	11	21	1	10	2	6
27 CIRRATULIDAE	0	0	0	0	0	27	2	1	1	2
28 OMENIA FUSIFORMIS	0	0	0	2	0	15	10	2	0	0
29 CISTENA GOULDII	4	2	4	19	8	4	4	4	4	2
30 LOIMIA MEDUSA	0	0	2	17	7	14	2	10	20	4
31 OLIGOCHAETA	24	2	8	1	0	12	5	0	0	2
32 NASSARIUS TRIVITTATUS	0	0	0	0	2	3	5	6	3	0
33 ACTEOCINA CANALICULATA	18	2	0	1	16	2	5	1	11	0
34 TURBONILLA INTERRUPTA	0	0	0	0	0	1	4	1	1	0
35 PELECYPODA	0	0	0	0	1	0	7	0	18	2
36 NUCULA PROXIMA	0	0	0	0	0	1	0	0	0	0
37 YOLDIA LIMATULA	2	0	0	1	0	0	0	0	0	4
38 ANADARA TRANSVERSA	2	0	0	0	0	7	8	0	2	2
39 MACOMA	0	0	0	0	0	25	9	2	0	0
40 MACOMA TENTA	0	2	0	2	8	20	43	0	13	16
41 OXYUROSTYLIS SMITHI	2	0	0	3	6	2	0	0	8	0
42 AMPELISCA ABDITA	0	16	4	17	21	16	45	2	19	14
43 AMPELISCA MACROCEPHALA	0	0	0	0	0	1	4	0	0	0
44 COROPHIUM TUBERCULATUM	0	0	0	0	4	1	5	0	4	6
45 ERICHTHONIUS BRASILIENSIS	0	0	0	0	4	10	30	7	35	14
46 LISTRIELLA BARNARDI	0	2	0	13	7	17	9	7	77	10
47 PARACAPRELLA TENUIS	6	0	0	2	3	7	7	2	1	2
48 MICROPHOLIS ATRA	2	0	0	1	2	4	3	3	5	2
49 SACCOGLOSSUS KONALEWSKII	0	0	0	0	0	1	0	5	3	0
50 MULLINIA LATERALIS	88	300	2	0	0	0	0	0	0	24
51 EDOTEA TRILOBA	0	2	0	0	1	0	0	0	0	0
52 CLYTIA	0	0	0	0	0	1	0	0	0	0
53 SERTULARIA ARGENTEA	2	2	2	0	0	0	0	0	0	2
54 MYTILUS EDULIS	8	0	0	0	0	0	0	0	0	2
55 AMPELISCA	0	0	0	0	0	0	0	0	0	0
56 PHORONIS	0	6	2	4	1	5	4	1	4	4
57 MUGULA MANHATTENSIS	0	0	0	0	0	2	1	1	0	0
58 CEREBRATULUS LACTEUS	0	0	0	1	1	0	3	0	0	2
59 POLYNOIDAE	0	0	0	0	0	0	0	0	0	0
60 PHYLLODOCE ARENAE	0	0	0	0	0	0	0	0	0	0
61 PRIONOSPIO	0	0	0	1	0	3	0	0	0	0
62 PINNIXA CHAETOPTERANA	0	0	0	0	0	0	0	0	0	0
63 PINNIXA RETINENS	0	0	0	3	0	2	0	0	0	0
64 EDWARDSIA	0	0	0	0	0	0	0	0	0	0
65 MICRURA RUBRA	2	0	0	0	0	1	0	0	0	2
66 AMPHIPORUS BIOCULATUS	0	0	0	0	0	1	0	0	0	0
67 BYPTIS VITTATA	0	0	0	0	0	2	0	2	2	0
68 CYCLOSTREMISCUS PENTAGONA	0	0	0	0	0	0	0	0	1	0
69 CYLICHNA ALBA	0	0	0	0	0	1	0	0	2	0
70 LEUCON AMERICANUS	22	0	0	11	13	0	1	0	0	4
71 CERAPUS TUBULARIS	6	0	2	11	3	7	1	2	6	2
72 LISTRIELLA CLYMENELLAE	0	4	0	11	17	9	8	5	10	10
73 SPIOCHAETOPTERUS OCULATUS	0	0	0	3	0	1	0	1	0	0
74 LEPIDAMETRIA COMMENSALIS	0	0	0	0	0	0	0	0	2	0
75 SAYELLA	0	0	0	1	0	0	0	0	0	4
76 OSYRIDES HAYI	4	0	0	6	5	0	0	4	8	4
77 DIOPATRA CUPREA	0	0	2	0	0	1	0	0	0	2
78 PARAMETOPELLA CYPRIIS	0	0	0	0	0	1	0	1	0	2

SPECIES / SAMPLES	21 WAP044	22 WAP045	23 WAP051	24 WAP052	25 WAP053	26 WAP054	27 WAP055	28 WAP061	29 WAP062	30 WAP063
1 HYDROZOA	0	0	4	1	2	0	0	3	1	2
2 CERANTHOPSIS AMERICANUS	2	0	2	5	0	0	0	0	0	0
3 POLYCLADIA	4	2	1	4	8	4	2	10	7	10
4 TUBULANUS PELLUCIDUS	2	0	7	5	8	2	0	19	6	10
5 HARMOTHOE LUNULATA	0	4	2	0	2	0	8	7	0	4
6 BHAWANIA GOODEI	4	4	12	11	12	4	4	60	91	46
7 GYPTIS BREVIPALPA	0	4	4	4	4	6	12	18	18	22
8 CABIRA INCERTA	0	0	1	0	0	0	0	4	0	0
9 SIGAMBRA TENTACULATA	4	6	20	10	26	14	4	80	7	10
10 NEREIS SUCCINEA	2	0	2	3	0	0	0	2	2	2
11 NEPHTYIDAE	0	0	84	81	8	0	4	57	99	56
12 NEPHTYS INCISA	2	0	1	1	2	0	0	1	0	2
13 NEPHTYS PICTA	6	2	31	17	12	50	42	22	13	6
14 GLYCERA AMERICANA	0	2	16	5	4	2	2	11	5	2
15 GLYCINDE SOLITARIA	0	8	6	4	0	0	0	4	6	4
16 NOTOMASTUS LATERICEUS	2	4	19	32	12	2	0	23	28	14
17 MEDIOMASTUS AMBISETA	0	0	6	0	0	0	42	6	1	4
18 CLYMENELLA TORQUATA	4	0	2	0	2	2	8	4	0	2
19 CLYMENELLA ZONALIS	66	24	100	137	106	106	82	146	114	90
20 ASYCHIS ELONGATA	0	2	1	0	2	0	0	0	2	0
21 POLYDORA LIGNI	0	0	4	3	10	2	0	0	1	32
22 PARAPRIONOSPIO PINNATA	24	150	48	52	20	18	164	58	63	18
23 SCOLELEPIS SQUAMATA	0	0	2	0	0	0	2	2	0	0
24 SPIOPHANES BOMBYX	0	0	1	0	2	0	6	0	0	0
25 CHAETOPTERUS VARIOPEDATUS	0	0	14	1	2	10	6	25	15	4
26 PSEUDEURYTHOE PAUCIBRANCHIATA	0	0	0	3	2	2	0	7	3	6
27 CIRRATULIDAE	0	0	7	0	2	2	38	21	0	2
28 OWENIA FUSIFORMIS	0	0	4	4	2	6	0	1	0	0
29 CISTENA GOULDII	22	2	1	2	2	2	2	1	0	4
30 LOINIA MEDUSA	0	8	16	10	0	6	10	15	5	0
31 OLIGOCHAETA	0	0	0	2	0	0	4	1	0	0
32 NASSARIUS TRIVITTATUS	0	0	7	2	4	0	0	4	5	4
33 ACTEOCINA CANALICULATA	0	4	8	13	2	0	2	10	4	4
34 TURBONILLA INTERRUPTA	0	4	7	4	4	0	2	4	4	8
35 PELECYPODA	0	0	0	13	0	0	0	0	24	0
36 NUCULA PROXIMA	0	0	0	0	2	0	0	0	0	0
37 YOLDIA LIMATULA	0	0	3	1	14	6	0	0	1	36
38 ANADARA TRANSVERSA	0	0	1	2	0	0	0	0	0	0
39 MACOMA	0	0	14	0	0	0	0	0	1	0
40 MACOMA TENTA	0	0	34	9	12	20	6	19	45	28
41 OXYUROSTYLIS SMITHI	0	0	0	0	2	0	0	0	1	0
42 AMPELISCA ABDITA	8	2	3	17	16	2	12	8	15	24
43 AMPELISCA MACROCEPHALA	0	0	9	4	0	8	0	1	4	0
44 COROPHIUM TUBERCULATUM	12	0	0	1	2	8	0	0	0	0
45 ERICHTHONIUS BRASILIENSIS	6	0	6	4	0	2	0	1	0	0
46 LISTRIELLA BARNARDI	0	0	14	2	4	0	2	20	14	18
47 PARACAPRELLA TENUIS	0	0	3	0	0	0	0	1	0	0
48 MICROPHOLIS ATRA	0	0	4	3	4	2	6	8	0	4
49 SACCOGLOSSUS KOMALEWSKII	0	0	0	0	0	0	0	3	0	0
50 MULLINIA LATERALIS	26	0	0	2	12	4	0	0	0	8
51 EDDTEA TRILOBA	0	0	0	0	0	0	0	0	0	0
52 CLYTIA	2	0	0	0	0	2	0	1	0	0
53 SERTULARIA ARGENTEA	2	2	0	1	0	2	0	0	0	0
54 MYTILUS EDULIS	0	0	0	0	0	2	0	0	0	0
55 AMPELISCA	0	0	4	0	0	0	0	0	0	0
56 PHORONIS	0	6	4	5	0	2	8	0	0	6
57 MORGULA MANHATTENSIS	0	0	1	0	0	8	0	0	0	0
58 CEREBRATULUS LACTEUS	0	0	0	0	0	2	0	0	0	0
59 POLYNOIDAE	0	0	0	0	0	0	0	0	0	0
60 PHYLLODOCE ARENAE	0	0	0	0	0	0	4	0	0	0
61 PRIONOSPIO	0	0	2	0	0	0	8	4	0	4
62 PINNIXA CHAETOPTERANA	0	0	0	1	0	0	0	0	2	0
63 PINNIXA RETINENS	0	0	0	0	0	0	8	0	0	0
64 EDWARDSIA	0	0	1	1	0	0	2	0	0	0
65 MICRURA RUBRA	0	0	0	1	0	0	0	1	0	2
66 AMPHIPORUS BIOCULATUS	0	0	0	0	0	0	0	1	0	0
67 GYPTIS VITTATA	0	0	0	0	0	0	0	0	3	0
68 CYCLOSTREMISCUS PENTAGONA	0	0	0	0	0	0	0	1	0	0
69 CYLICHNA ALBA	0	0	0	0	0	0	0	3	4	4
70 LEUCON AMERICANUS	0	2	1	0	0	0	0	1	0	0
71 CERAPUS TUBULARIS	0	0	1	1	0	0	0	1	0	0
72 LISTRIELLA CLYMENELLAE	0	0	1	5	4	0	0	4	4	2
73 SPIOCHAETOPTERUS OCLULATUS	0	0	1	0	0	0	2	0	0	0
74 LEPIDAMETRIA COMMENSALIS	0	2	0	0	0	2	0	0	0	0
75 SAYELLA	0	4	0	0	0	0	0	0	0	2
76 OSYRIDES HAYI	0	2	0	0	0	0	0	1	0	0
77 DIOPATRA CLIPREA	2	0	0	0	2	0	0	1	0	0
78 PARAMETOPELLA CYPRIS	0	0	1	0	0	0	0	0	0	0

SPECIES / SAMPLES	31 WAP064	32 WAP065	33 WAP071	34 WAP072	35 WAP081	36 WAP082	37 WAP091	38 WAP092	39 WAP093	40 WAP094
1 HYDROZOA	0	0	0	1	2	1	2	0	2	2
2 CERANTHEOPSIS AMERICANUS	2	0	0	0	1	2	1	0	0	0
3 POLYCLADIA	16	0	0	0	5	3	13	4	6	0
4 TUBULANUS PELLUCIDUS	8	2	1	9	15	7	9	4	4	4
5 HARMOTHOE LUNULATA	0	6	0	0	0	1	0	4	4	0
6 BHAWANIA GOODEI	16	20	4	2	29	19	34	21	26	26
7 GYPTIS BREVIPALPA	2	6	8	9	13	18	7	9	20	6
8 CABIRA INCERTA	0	2	0	0	1	0	4	0	0	0
9 SIGAMBRA TENTACULATA	22	10	38	5	44	23	40	10	16	26
10 NEREIS SUCCINEA	0	8	0	2	0	2	3	2	0	2
11 NEPHTYIDAE	0	0	3	28	34	93	31	65	80	0
12 NEPHTYS INCISA	0	0	0	0	1	0	0	2	0	2
13 NEPHTYS PICTA	50	12	1	4	7	13	7	15	16	66
14 GLYCERA AMERICANA	0	0	5	10	8	10	7	12	6	2
15 GLYCINDE SOLITARIA	4	10	0	4	3	5	1	3	4	0
16 NOTOMASTUS LATERICELUS	10	2	21	16	17	41	18	24	2	6
17 MEDIOASTUS AMBISETA	0	10	0	0	1	3	3	4	18	0
18 CLYMENELLA TORQUATA	0	0	2	2	4	6	1	3	6	0
19 CLYMENELLA ZONALIS	82	72	24	26	107	211	103	98	124	84
20 ASYCHIS ELONGATA	0	0	0	1	2	0	4	0	0	2
21 POLYDORA LIGNI	0	0	3	0	1	3	1	2	30	0
22 PARAPRIONOSPIO PINNATA	30	100	68	83	47	97	70	59	56	38
23 SCOLELEPIS SQUAMATA	0	0	0	1	0	0	0	0	0	0
24 SPIOPHANES BOMBYX	0	0	0	0	0	0	0	1	0	0
25 CHAETOPTERUS VARIOPEDATUS	10	0	2	2	18	10	15	10	6	12
26 PSEUDEURYTHOE PAUCIBRANCHIATA	2	0	2	1	14	1	1	3	4	8
27 CIRRATULIDAE	0	22	0	1	4	4	5	0	4	0
28 OMENIA FUSIFORMIS	2	2	2	3	5	1	2	0	0	0
29 CISTENA GOULDII	0	2	2	7	0	5	2	0	2	2
30 LOINIA MEDUSA	2	24	1	6	11	5	12	1	10	2
31 OLIGOCHAETA	2	0	0	1	2	5	0	6	4	0
32 NASSARIUS TRIVITTATUS	0	0	1	3	6	8	5	5	0	0
33 ACTEOCINA CANALICULATA	2	14	5	4	13	27	4	5	14	0
34 TURBONILLA INTERRUPTA	0	0	0	0	9	10	4	3	12	2
35 PELECYPODA	0	0	0	6	0	2	0	4	8	0
36 NUCULA PROXIMA	2	0	0	0	0	0	0	0	0	0
37 YOLDIA LIRATULA	6	0	0	0	1	0	1	1	4	8
38 ANADARA TRANSVERSA	0	0	0	0	0	1	0	0	0	0
39 MACOMA	0	0	5	0	5	0	1	0	12	0
40 MACOMA TENTA	50	2	0	8	6	6	24	16	12	24
41 OXYUROSTYLIS SMITHI	0	0	0	0	3	0	1	0	2	0
42 AMPELISCA ABDITA	10	0	7	19	0	2	5	5	10	4
43 AMPELISCA MACROCEPHALA	8	0	2	0	2	0	6	0	0	8
44 COROPHIUM TUBERCULATUM	4	0	2	0	0	2	0	1	0	10
45 ERICHTHONIUS BRASILIENSIS	6	4	22	0	0	5	0	0	0	0
46 LISTRIELLA BARNARDI	0	2	19	9	19	16	16	8	20	8
47 PARACAPRELLA TENJIS	0	0	3	0	0	1	0	0	0	0
48 MICROPOLIS ATRA	4	4	2	1	4	4	5	3	2	0
49 SACCOGLOSSUS KOWALEWSKII	0	0	2	2	0	0	3	0	2	0
50 MULLINIA LATERALIS	0	0	0	0	0	0	0	0	0	0
51 EDOTEA TRILOBA	0	0	0	0	0	0	0	0	0	0
52 CLYTIA	0	0	0	0	0	1	0	0	0	0
53 SERTULARIA ARGENTEA	0	2	0	0	0	1	0	0	2	0
54 MYTILUS EDULIS	0	0	0	0	0	0	0	0	0	4
55 AMPELISCA	8	0	1	0	0	1	3	0	0	0
56 PHORONIS	4	4	0	1	1	3	2	4	12	8
57 MORGULA MANHATTENSIS	8	0	0	0	0	0	0	0	0	4
58 CEREBRATULUS LACTEUS	0	0	0	0	0	1	1	1	0	2
59 POLYNOIDAE	2	0	0	0	1	0	1	0	0	0
60 PHYLLODOCE ARENAE	0	0	0	0	0	0	1	0	0	0
61 PRIONOSPIO	0	0	1	0	1	0	0	0	2	6
62 PINNIXA CHAETOPTERANA	0	0	0	0	0	1	2	0	0	0
63 PINNIXA RETINENS	0	0	0	0	0	2	0	0	0	0
64 EDWARDSIA	0	0	0	1	0	1	2	0	0	0
65 MICRURA RUBRA	0	0	0	0	1	0	0	0	8	0
66 AMPHIPORUS BIOCULATUS	0	4	0	0	0	0	0	0	2	0
67 GYPTIS VITTATA	0	0	0	0	1	0	3	0	0	0
68 CYCLOSTREHISCUS PENTAGONA	0	0	5	0	0	0	0	0	0	0
69 CYLICHNA ALBA	0	0	2	2	2	1	1	1	0	0
70 LEUCON AMERICANUS	0	0	0	0	0	0	0	0	0	0
71 CERAPUS TUBULARIS	0	0	8	0	0	0	0	0	2	0
72 LISTRIELLA CLYMENELLAE	0	0	4	1	1	3	0	1	0	0
73 SPIOCHAETOPTERUS OCVLATUS	0	0	0	1	0	1	0	0	0	0
74 LEPIDAMETRIA COMMENSALIS	0	2	0	0	0	0	0	0	0	0
75 SAYELLA	0	0	0	0	0	0	0	0	0	4
76 OSYRIDES HAYI	0	0	3	6	1	1	0	0	0	0
77 DIOPATRA CUPREA	0	0	0	0	0	0	3	0	0	0
78 PARAMETOPELLA CYPRI	0	0	1	0	0	0	0	0	0	0

SPECIES / SAMPLES	51 WAP131	52 WAP132	53 WAP133	54 WAP134	55 WAP135	56 WAP141	57 WAP142	58 WAP151	59 WAP152	60 WAP153
1 HYDROZOA	0	0	0	0	0	2	0	0	1	2
2 CERANTHOPSIS AMERICANUS	0	1	0	0	0	0	0	0	0	4
3 POLYCLADIA	0	4	6	10	4	5	3	11	8	22
4 TUBULANUS PELLUCIDUS	0	2	0	14	8	21	1	21	5	0
5 HARMOTHOE LUNULATA	0	0	0	0	0	0	1	0	2	12
6 BHAWANIA GOODEI	27	16	14	4	10	59	11	46	8	30
7 GYPTIS BREVIPALPA	22	15	4	0	0	16	5	13	5	8
8 CABIRA INCERTA	1	1	0	0	0	1	1	4	0	2
9 SIGAMBRA TENTACULATA	46	17	20	14	40	39	3	35	6	22
10 NEREIS SUCCINEA	0	0	0	0	0	3	2	0	0	4
11 NEPHTYIDAE	19	10	16	0	0	48	68	48	90	54
12 NEPHTYS INCISA	0	0	0	0	0	0	0	0	0	4
13 NEPHTYS PICTA	2	2	2	4	4	12	11	12	17	6
14 GLYCERA AMERICANA	13	10	6	6	4	21	4	9	7	12
15 GLYCINDE SOLITARIA	5	4	2	6	22	8	1	6	3	8
16 NOTOMASTUS LATERICEUS	0	18	18	4	8	23	4	7	15	6
17 MEDIOCASTUS AMBISETA	1	0	0	0	4	2	0	2	2	2
18 CLYMENELLA TORQUATA	1	0	0	0	2	4	1	3	0	0
19 CLYMENELLA ZONALIS	95	93	82	78	52	161	101	149	95	158
20 ASYCHIS ELONGATA	1	1	0	0	2	2	2	2	2	0
21 POLYDORA LIGNI	0	0	0	0	0	0	2	0	8	24
22 PARAPRIONOSPION PINNATA	70	23	24	46	104	69	59	68	92	50
23 SCOLELEPIS SQUAMATA	0	0	0	0	0	0	1	0	0	0
24 SPIOPHANES BOMBYX	0	0	0	0	0	0	7	3	0	10
25 CHAETOPTERUS VARIOPEDATUS	6	0	0	0	0	18	2	21	6	10
26 PSEUDEURYTHOE PAUCIBRANCHIATA	2	1	18	2	4	5	1	2	0	0
27 CIRRATULIDAE	3	1	0	0	0	4	7	11	6	4
28 OMENIA FUSIFORMIS	0	0	0	0	2	0	0	2	4	8
29 CISTENA GOULDII	3	3	4	8	4	7	0	0	1	2
30 LOIMIA MEDUSA	4	0	0	0	14	7	0	11	3	4
31 OLIGOCHAETA	0	0	0	0	0	0	3	0	1	0
32 NASSARIUS TRIVITTATUS	3	1	0	0	0	0	1	15	5	8
33 ACTEOCINA CANALICULATA	20	8	4	0	2	14	5	6	7	8
34 TURBONILLA INTERRUPTA	2	0	0	0	0	1	3	1	5	6
35 PELECYPODA	0	4	12	0	0	0	8	0	6	0
36 NUCULA PROXIMA	0	0	0	0	0	0	0	2	0	2
37 YOLDIA LIMATULA	0	0	0	2	0	0	2	5	2	12
38 ANADARA TRANSVERSA	0	0	0	0	0	1	0	1	0	0
39 MACOMA	3	0	12	0	0	3	0	0	0	8
40 MACOMA TENTA	0	3	0	6	0	6	20	26	45	36
41 OXYUROSTYLIS SMITHI	0	1	0	0	0	1	1	3	0	0
42 AMPELISCA ABDITA	4	9	6	0	8	7	12	6	28	18
43 AMPELISCA MACROCEPHALA	2	0	0	4	0	1	0	2	0	2
44 CORDOPHIUM TUBERCULATUM	0	0	0	0	0	0	1	1	5	12
45 ERICHTHONIUS BRASILIENSIS	1	0	0	0	0	1	1	11	0	4
46 LISTRIELLA BARNARDI	27	4	4	4	6	9	4	7	14	24
47 PARACAPRELLA TENUIS	1	0	2	0	0	4	0	4	0	2
48 MICROPHOLIS ATRA	1	0	0	2	0	2	1	6	2	0
49 SACCOGLOSSUS KOWALEWSKII	3	2	0	0	0	4	0	1	0	0
50 MULINIA LATERALIS	0	0	0	2	0	0	0	0	0	0
51 EDOTEA TRILOBA	1	0	0	0	0	0	0	0	1	0
52 CLYTIA	0	0	0	2	0	0	0	0	0	0
53 SERTULARIA ARGENTEA	0	1	0	0	2	0	0	0	0	2
54 MYTILUS EDULIS	0	0	2	0	0	0	0	0	0	32
55 AMPELISCA	6	0	0	0	0	1	0	3	0	2
56 PHORONIS	0	1	0	2	0	0	2	3	4	16
57 MORGULA MANHATTENSIS	0	0	0	0	0	0	0	0	0	0
58 CEREBRATULUS LACTEUS	0	0	0	0	0	0	1	0	0	0
59 POLYNOIDAE	0	0	0	0	2	0	0	8	0	0
60 PHYLLODOCE ARENAE	0	0	0	0	0	1	0	0	0	2
61 PRIONOSPION	2	0	0	0	0	3	0	3	0	0
62 PINNIXIA CHAETOPTERANA	0	0	0	0	0	1	1	2	1	0
63 PINNIXIA RETINENS	5	0	0	0	2	4	0	2	0	0
64 EDWARDSIA	0	0	0	0	0	1	1	0	3	2
65 MICRURA RUBRA	1	0	0	0	0	0	0	2	3	0
66 AMPHIPORUS BICUCULATUS	0	0	2	0	0	0	0	0	1	0
67 GYPTIS VITTATA	2	0	0	0	0	2	0	0	0	0
68 CYCLOSTREMISCUS PENTAGONA	3	3	2	0	0	1	0	0	0	0
69 CYLICHNA ALBA	0	0	0	0	0	1	1	5	3	0
70 LEUCON AMERICANUS	0	0	4	0	2	1	0	0	0	0
71 CERAPUS TUBULARIS	6	0	2	0	0	8	0	2	0	0
72 LISTRIELLA CLYMENELLAE	6	2	2	4	6	5	0	3	0	0
73 SPIOCHAETOPTERUS OCLATUS	1	0	0	0	0	2	0	1	0	0
74 LEPIDOMETRIA COMMENSALIS	0	0	0	0	0	0	0	0	0	0
75 SAYELLA	0	0	0	2	0	1	0	2	0	0
76 OGYRIDES HAYI	2	0	0	2	0	2	0	0	0	0
77 DIOPATRA CUPREA	0	0	0	0	0	0	0	0	1	0
78 PARAMETOPELLA CYPRIIS	0	0	0	0	0	3	0	0	0	2

SPECIES / SAMPLES	61 WAP154	62 WAP155	63 WTC012	64 WTC013	65 WTC014	66 WTC015	67 WTC022	68 WTC023	69 WTC024	70 WTC025
1 HYDROZOA	0	0	1	0	0	0	0	0	0	0
2 CERANTHEOPSIS AMERICANUS	0	0	0	2	0	0	0	0	0	0
3 POLYCLADIA	8	0	3	0	4	0	0	0	16	16
4 TUBULANUS PELLUCIDUS	30	10	6	2	8	0	0	0	6	4
5 HARMOTHOE LLAULATA	10	2	2	10	0	4	0	0	0	0
6 BHAWANIA GODDEI	66	4	13	16	16	52	0	2	0	6
7 GYPTIS BREVIPALPA	10	14	9	0	2	8	0	6	14	16
8 CABIRA INCERTA	0	0	0	0	0	0	0	0	0	0
9 SIGAMBRA TENTACULATA	86	22	17	22	26	14	0	0	0	10
10 NEREIS SUCCINEA	0	0	0	4	0	0	0	8	14	0
11 NEPHTYIDAE	0	2	38	28	0	0	2	44	0	0
12 NEPHTYS INCISA	0	0	0	0	0	0	0	0	0	0
13 NEPHTYS PICTA	50	12	13	6	24	8	1	12	18	8
14 GLYCERA AMERICANA	0	2	7	2	0	0	0	2	0	0
15 GLYCINDE SOLITARIA	2	28	7	0	8	4	1	6	8	34
16 NOTOMASTUS LATERICEUS	2	4	15	16	8	8	0	0	0	0
17 MEDIOMASTUS AMBISETA	2	26	0	0	4	0	0	2	0	6
18 CLYMENELLA TORQUATA	2	0	2	6	2	2	0	32	52	26
19 CLYMENELLA ZONALIS	144	146	59	84	90	94	0	4	6	4
20 ASYCHIS ELONGATA	2	0	1	6	0	0	0	0	0	2
21 POLYDORA LIGNI	0	0	2	22	2	0	0	76	24	0
22 PARAPRIONOSPIO PINNATA	44	160	84	38	34	78	30	38	28	132
23 SCOLELEPIS SQUAMATA	0	0	0	0	0	0	1	0	0	0
24 SPIOPHANES BOMBYX	2	2	0	0	0	0	0	0	0	0
25 CHAETOPTERUS VARIOPEDATUS	0	0	13	6	0	0	0	0	0	0
26 PSEUDEURYTHOE PAUCIBRANCHIATA	2	10	1	2	6	40	0	54	22	30
27 CIRRATULIDAE	10	0	8	6	0	0	1	4	0	0
28 OMENIA FUSIFORMIS	4	2	4	0	2	2	0	0	0	0
29 CISTENA GOULDII	0	0	0	0	0	0	3	16	22	2
30 LOIMIA MEDUSA	2	16	16	8	2	20	2	22	6	16
31 OLIGOCHAETA	6	0	1	0	2	0	1	0	12	0
32 NASSARIUS TRIVITTATUS	0	6	8	0	0	0	0	0	0	0
33 ACTEOCINA CANALICULATA	4	18	2	2	0	6	0	4	4	0
34 TURBONILLA INTERRUPTA	0	0	2	4	0	0	0	10	16	0
35 PELECYPODA	0	0	0	0	0	0	0	0	0	0
36 NUCULA PROXIMA	4	0	0	0	0	0	0	0	0	0
37 YOLDIA LIHATULA	4	4	1	0	4	0	0	0	0	0
38 ANADARA TRANSVERSA	0	0	0	0	0	0	0	22	0	0
39 MACOMA	0	0	18	0	0	0	0	2	0	0
40 MACOMA TENTA	30	4	17	14	0	2	1	10	2	0
41 OXYUROSTYLIS SMITHI	0	0	0	0	0	0	4	0	0	0
42 AMPELISCA ABDITA	28	4	28	14	2	2	2	12	6	2
43 AMPELISCA MACROCEPHALA	4	0	0	0	0	0	0	0	0	0
44 COROPHIUM TUBERCULATUM	0	0	0	0	0	0	0	2	0	0
45 ERICHTHONIUS BRASILIENSIS	0	0	2	8	0	0	1	20	2	0
46 LISTRIELLA BARNARDI	6	0	42	8	6	0	0	8	4	2
47 PARACAPRELLA TENJIS	0	0	0	0	0	0	0	58	0	0
48 MICROPHOLIS ATRA	6	2	6	4	2	6	0	0	0	0
49 SACCOGLOSSUS KOMALEWSKII	0	2	2	4	0	6	0	0	0	0
50 MULLINIA LATERALIS	0	0	0	0	0	0	0	32	168	0
51 EDDTEA TRILOBA	0	0	0	0	0	0	1	8	34	0
52 CLYTIA	2	0	0	0	0	0	0	2	2	2
53 SERTULARIA ARGENTEA	2	0	0	0	0	2	0	2	2	2
54 MYTILUS EDULIS	2	0	0	10	0	0	0	56	0	0
55 AMPELISCA	0	0	0	0	0	0	0	0	0	0
56 PHORONIS	0	2	1	0	4	0	0	12	0	14
57 MORGULA MANHATTENSIS	2	0	0	0	4	0	0	0	30	0
58 CEREBRATULLUS LACTEUS	0	0	0	0	0	2	0	2	0	0
59 POLYNOIDAE	0	0	0	0	0	0	0	0	0	0
60 PHYLLODOCE ARENAE	0	2	0	0	0	0	0	0	0	0
61 PRIONOSPIO	8	2	0	2	2	2	0	0	0	0
62 PINNIXA CHAETOPTERANA	0	0	0	0	0	0	0	0	0	12
63 PINNIXA RETINENS	2	0	0	0	0	2	1	0	0	0
64 EDWARDSIA	0	2	0	0	0	0	0	0	0	0
65 MICRURA RUBRA	2	0	0	0	0	2	0	0	0	0
66 AMPHIPORUS BIOCULATUS	2	0	0	0	2	2	0	0	0	0
67 GYPTIS VITTATA	0	0	0	0	0	2	0	0	0	0
68 CYCLOSTRENIUS PENTAGONA	0	0	0	0	0	0	0	0	0	0
69 CYLICHNA ALBA	0	0	2	0	0	0	0	0	0	0
70 LEUCON AMERICANUS	0	0	0	0	0	0	3	2	0	4
71 CERAPUS TUBULARIS	0	0	4	0	0	0	0	24	6	0
72 LISTRIELLA CLYMENELLAE	4	2	4	6	2	6	0	34	42	36
73 SPIOCHAETOPTERUS OCULATUS	0	0	0	0	0	0	0	0	0	0
74 LEPIDAMETRIA COMMENSALIS	0	0	0	0	0	2	0	2	0	8
75 SAYELLA	2	22	0	0	0	6	0	0	4	0
76 OGYRIDES HAYI	0	0	1	0	0	0	4	0	0	0
77 DIOPATRA CUPREA	0	0	0	2	0	0	0	0	2	0
78 PARAMETOPELLA CYPRI	0	0	4	2	0	0	0	20	0	0

SPECIES / SAMPLES	71 WTP011	72 WTP012	73 WTP013	74 WTP014	75 WTP015	76 WTP021	77 WTP022	78 WTP023	79 WTP024	80 WTP025
1 HYDROZOA	0	0	0	0	2	0	2	0	0	0
2 CERANTHOPSIS AMERICANUS	1	0	0	0	0	0	5	0	0	0
3 POLYCLADIA	7	2	2	8	2	3	4	0	2	12
4 TUBULANUS PELLUCIDUS	8	5	4	18	4	10	8	0	22	4
5 HARMOTHOE LUNULATA	2	0	0	0	2	3	0	4	8	10
6 BHAWANIA GOODEI	18	10	10	8	0	13	16	36	4	6
7 GYPTIS BREVIPALPA	17	15	12	2	6	18	13	0	4	8
8 CABIRA INCERTA	1	0	2	0	0	2	0	0	0	0
9 SIGAMBRA TENTACULATA	75	16	22	8	8	34	8	24	28	10
10 NEREIS SUCCINEA	4	1	0	0	0	0	2	0	14	0
11 NEPHTYIDAE	49	33	14	2	0	57	64	30	6	2
12 NEPHTYS INCISA	0	0	0	0	0	1	0	0	0	0
13 NEPHTYS PICTA	19	1	26	12	6	13	10	4	24	12
14 GLYCERA AMERICANA	13	6	4	0	0	11	5	6	2	2
15 GLYCINDE SOLITARIA	10	6	2	2	10	8	1	4	6	14
16 NOTOMASTUS LATERICELUS	22	12	10	6	0	38	13	4	6	0
17 MEDIOASTUS AMBISETA	0	0	6	2	6	3	0	2	2	12
18 CLYMENELLA TORQUATA	5	2	6	4	2	5	1	0	2	0
19 CLYMENELLA ZONALIS	95	121	126	70	64	134	106	162	68	92
20 ASYCHIS ELONGATA	0	3	0	2	2	4	1	2	2	2
21 POLYDORA LIGNI	3	0	30	0	0	0	10	12	4	0
22 PARAPRIONOSPIO PINNATA	115	92	54	46	166	13	63	22	34	194
23 SCOLELEPIS SQUAMATA	0	0	2	0	0	0	0	2	0	0
24 SPIOPHANES BOMBYX	0	0	0	0	0	0	0	0	0	0
25 CHAETOPTERUS VARIOPEDATUS	4	5	10	0	0	22	21	0	0	0
26 PSEUDEURYTHOE PAUCIBRANCHIATA	3	6	0	4	2	8	3	20	0	2
27 CIRRATULIDAE	5	0	6	0	0	15	4	0	2	12
28 OWENIA FUSIFORMIS	0	0	4	0	0	3	4	4	2	2
29 CISTENA GOULDII	2	5	0	2	0	1	2	0	2	0
30 LOITHIA MEDUSA	14	9	10	0	0	17	11	0	2	28
31 OLIGOCHAETA	0	0	2	2	2	0	0	6	0	0
32 NASSARIUS TRIVITTATUS	1	2	10	0	4	10	5	2	0	4
33 ACTEOCINA CANALICULATA	8	5	6	0	6	6	1	4	2	8
34 TURBONILLA INTERRUPTA	0	0	0	0	2	8	0	8	0	0
35 PELECYPODA	0	0	2	0	0	0	0	0	0	0
36 NUCULA PROXIMA	0	1	0	0	0	0	0	0	0	0
37 YOLDIA LIMATULA	0	0	8	2	0	2	1	2	6	0
38 ANADARA TRANSVERSA	2	0	2	0	0	1	0	0	0	0
39 MACOMA	20	2	6	0	0	24	18	2	0	0
40 MACOMA TENTA	15	7	0	12	2	13	24	18	18	4
41 OXYUROSTYLIS SMITHI	0	1	0	0	0	1	1	0	0	0
42 AMPELISCA ABDITA	13	8	6	2	6	12	11	10	4	6
43 AMPELISCA MACROCEPHALA	0	0	0	0	0	0	0	0	0	0
44 COROPHIUM TUBERCULATUM	0	0	0	0	0	0	1	0	26	0
45 ERICHTHONIUS BRASILIENSIS	14	9	16	0	0	3	7	0	2	0
46 LISTRIELLA BARNARDI	13	19	10	0	2	13	9	2	8	6
47 PARACAPRELLA TENUIS	5	0	0	0	0	0	0	0	0	0
48 MICROPHOLIS ATRA	7	1	4	0	2	5	0	4	4	6
49 SACCOGLOSSUS KOMALEWSKII	3	2	14	0	0	1	4	2	0	0
50 MULLINIA LATERALIS	0	0	6	36	0	0	0	4	2	0
51 EDDTEA TRILOBA	1	0	0	0	0	0	0	0	0	0
52 CLYTIA	2	0	2	2	0	0	0	0	2	0
53 SERTULARIA ARGENTEA	0	1	2	2	0	0	2	0	0	0
54 MYTILUS EDULIS	0	0	78	0	0	0	0	6	36	0
55 AMPELISCA	0	2	0	0	0	0	0	0	0	0
56 PHORONIS	0	0	4	8	2	2	4	0	0	4
57 MORGULA MANHATTENSIS	0	0	0	0	0	0	0	0	20	0
58 CEREBRATULLUS LACTEUS	1	1	0	0	0	0	3	0	0	0
59 POLYNOIDAE	1	1	0	0	0	1	0	0	0	0
60 PHYLLODOCE ARENAE	1	0	0	0	0	1	0	0	0	0
61 PRIONOSPIO	2	0	0	2	0	6	0	0	16	0
62 PINNIXA CHAETOPTERANA	0	0	0	0	0	0	1	0	0	0
63 PINNIXA RETINENS	0	0	0	0	0	0	1	0	0	0
64 EDWARDSIA	0	0	2	0	0	0	0	0	0	0
65 MICRURA RUBRA	0	1	0	0	0	0	2	0	0	0
66 AMPHIPORUS BIOCULATUS	0	0	4	0	0	0	0	0	0	2
67 GYPTIS VITTATA	6	0	2	0	0	1	0	0	0	2
68 CYCLOSTREMICUS PENTAGONA	1	1	0	0	0	0	0	0	2	0
69 CYLICHNA ALBA	3	2	2	0	0	1	0	0	0	0
70 LEUCON AMERICANUS	2	0	0	2	0	0	0	0	0	0
71 CERAPUS TUBULARIS	9	1	0	0	0	1	0	0	0	0
72 LISTRIELLA CLYMENELLAE	2	11	18	4	6	6	2	0	6	4
73 SPIOCHAETOPTERUS OCLULATUS	0	0	2	0	0	0	1	0	0	0
74 LEPIDAMETRIA COMMENSALIS	0	0	0	0	0	0	0	0	0	0
75 SAYELLA	0	0	4	4	10	0	0	2	0	2
76 OBYRIDES HAYI	5	1	0	2	0	0	1	0	0	0
77 DIOPATRA CUPREA	1	0	0	0	0	0	0	0	0	0
78 PARAMETOPELLA CYPRIS	1	4	0	0	0	2	2	0	0	0

SPECIES / SAMPLES	81 WTP031	82 WTP032	83 WTP041	84 WTP042	85 WTP051	86 WTP052	87 WTP061	88 WTP062	89 WTP071	90 WTP072
1 HYDROZOA	0	2	0	1	0	0	0	2	0	0
2 CERANTHOOPSIS AMERICANUS	1	6	0	0	1	2	0	3	1	0
3 POLYCLADIA	0	4	0	1	6	10	12	3	3	14
4 TUBULANUS PELLUCIDUS	12	11	5	7	9	6	3	5	14	6
5 HARMOTHE LUNULATA	4	0	0	0	5	0	2	1	0	0
6 BHAWANIA GOODEI	56	49	7	2	37	21	54	23	11	35
7 GYPTIS BREVIPALPA	10	19	13	3	18	18	7	13	21	20
8 CABIRA INCERTA	0	2	0	0	0	1	0	2	1	0
9 SIGAMBRA TENTACULATA	55	17	62	4	47	22	58	11	58	22
10 NEREIS SUCCINEA	2	1	0	0	1	0	5	4	4	2
11 NEPHTYIDAE	61	100	22	17	41	74	47	62	42	32
12 NEPHTYS INCISA	0	0	0	0	0	0	1	1	4	0
13 NEPHTYS PICTA	14	4	12	1	10	6	21	7	11	6
14 GLYCERA AMERICANA	17	10	7	6	7	13	10	7	8	2
15 GLYCIDAE SOLITARIA	12	5	11	7	7	2	7	7	2	5
16 NOTOMASTUS LATERICEUS	35	10	7	6	36	35	35	20	47	18
17 MEDIOMASTUS AMBISETA	17	5	1	0	1	3	2	3	0	2
18 CLYMENELLA TORQUATA	2	4	3	1	4	3	4	2	3	10
19 CLYMENELLA ZONALIS	178	143	39	28	105	106	127	131	144	138
20 ASYCHIS ELONGATA	1	0	1	1	2	0	2	2	2	0
21 POLYDORA LIGNI	0	28	0	0	1	3	0	18	0	0
22 PARAPRIONOSPIO PINNATA	82	75	137	122	81	73	77	51	67	70
23 SCOLELEPIS SQUAMATA	2	0	1	0	0	2	0	1	0	0
24 SPIOPHANES BOMBYX	0	0	0	0	0	0	0	1	0	0
25 CHAETOPTERUS VARIOPELATUS	22	15	1	0	13	10	26	9	8	4
26 PSEUDEURYTHOE PAUCIBRANCHIATA	4	5	2	2	7	4	5	1	4	58
27 CIRRATULIDAE	3	9	0	0	3	37	11	3	5	6
28 OWENIA FUSIFORMIS	4	1	1	2	0	0	5	4	0	0
29 CISTENA GOULDII	1	0	2	5	2	2	0	0	4	2
30 LOIMIA MEDUSA	16	9	6	5	18	21	10	2	12	6
31 OLIGOCHAETA	2	0	0	0	0	0	0	5	0	0
32 MASSARIUS TRIVITTATUS	5	5	9	0	6	2	13	10	0	2
33 ACTECCINA CANALICULATA	5	0	14	3	6	8	1	3	0	4
34 TURBONILLA INTERRUPTA	3	1	2	0	1	0	5	10	0	0
35 PELECYPODA	0	0	0	0	0	0	0	0	0	0
36 NUCULA PROXIMA	0	0	1	0	1	1	0	0	0	0
37 YOLDIA LIMATULA	2	2	0	0	0	0	3	1	1	0
38 ANADARA TRANSVERSA	0	0	0	0	0	2	3	0	0	1
39 MACOMA	1	22	14	9	5	2	0	0	0	0
40 MACOMA TENTA	15	19	9	5	15	27	20	35	9	11
41 OXYUROSTYLIS SMITHI	0	6	5	0	0	2	0	4	0	1
42 AMPELISCA ABDITA	2	12	10	11	3	12	5	15	5	12
43 AMPELISCA MACROCEPHALA	0	0	0	0	0	0	0	0	0	0
44 COROPHIUM TUBERCULATUM	0	3	0	0	0	0	0	2	0	0
45 ERICHTHONIUS BRASILIENSIS	1	4	2	0	0	0	0	2	0	18
46 LISTRIELLA BARNARDI	12	25	13	1	17	13	14	8	11	10
47 PARACAPRELLA TENJIS	1	1	0	0	0	1	0	1	1	0
48 MICROPHOLIS ATRA	2	2	1	0	11	1	6	3	1	2
49 SACCOGLOSSUS KOWALEWSKII	1	0	0	0	1	6	4	0	1	2
50 MULINIA LATERALIS	0	0	0	0	0	0	0	0	0	0
51 EDDTEA TRILOBA	2	4	0	0	0	0	0	4	1	0
52 CLYTIA	0	0	0	0	0	1	0	0	0	1
53 SERTULARIA ARGENTEA	0	2	0	1	0	0	0	0	0	1
54 MYTILUS EDULIS	0	0	0	0	0	0	0	0	0	0
55 AMPELISCA	0	3	0	1	0	0	0	1	1	0
56 PHORONIS	1	3	2	2	5	0	0	2	1	1
57 MORGULA MANHATTENSIS	0	0	0	0	0	0	0	0	0	0
58 CEREBRATULUS LACTEUS	1	1	1	0	0	0	1	1	0	0
59 POLYNODAE	0	0	0	0	0	0	0	0	1	0
60 PHYLLODOCE ARENAE	0	0	1	0	1	0	2	0	0	0
61 PRIONOSPIO	1	0	2	0	0	0	1	0	3	0
62 PINNIXA CHAETOPTERANA	0	2	0	0	2	0	1	1	0	1
63 PINNIXA RETINENS	0	0	0	0	1	2	1	1	0	1
64 EDWARDSIA	2	1	0	0	1	1	0	5	0	1
65 MICRURA RUBRA	2	1	0	0	0	2	0	1	0	2
66 AMPHIPORUS BIOCULATUS	0	0	0	0	0	0	0	0	0	0
67 GYPTIS VITTATA	0	0	1	0	3	1	0	0	1	1
68 CYCLOSTREMISCUS PENTAGONA	0	0	15	2	0	0	0	1	0	0
69 CYLICHNA ALBA	2	2	1	0	1	0	2	2	0	1
70 LEUCON AMERICANUS	0	1	2	3	0	1	0	0	0	0
71 CERAPUS TUBULARIS	0	4	1	0	1	0	6	0	0	2
72 LISTRIELLA CLYMENELLAE	1	2	3	5	5	8	0	0	8	8
73 SPIOCHAETOPTERUS OCULATUS	0	1	0	0	1	0	0	0	0	0
74 LEPIDAMETRIA COMMENSALIS	0	0	0	0	0	0	0	0	1	0
75 SAYELLA	0	0	13	0	1	0	0	0	0	0
76 OGYRIDES HAYI	1	1	2	2	2	3	0	0	0	0
77 DIOPATRA CUPREA	0	2	0	0	0	0	1	3	1	0
78 PARAMETOPELLA CYPRIS	5	0	1	0	0	9	5	4	0	3

SPECIES / SAMPLES	101 WTP101	102 WTP102	103 WTP103	104 WTP104	105 WTP105	106 WTP111	107 WTP112	108 WTP121	109 WTP122	110 WTP132
1 HYDROZOA	0	1	0	0	0	0	1	0	1	1
2 CERANTHOPSIS AMERICANUS	0	0	0	2	0	2	3	1	2	0
3 POLYCLADIA	3	2	4	6	2	6	5	0	3	5
4 TUBULANUS PELLUCIDUS	12	5	6	22	0	21	4	9	8	9
5 HARMOTHE LUNULATA	0	2	0	0	0	5	4	1	6	2
6 BHAMANIA GOODII	9	5	0	0	2	73	30	152	40	6
7 GYPTIS BREVIPALPA	9	12	6	0	10	50	16	48	16	9
8 CABIRA INCERTA	0	0	0	0	0	4	0	0	0	0
9 SIGAMBRA TENTACULATA	42	10	12	0	0	78	18	97	11	8
10 NEREIS SUCCINEA	1	3	0	0	0	7	0	0	2	1
11 NEPHTYIDAE	19	30	20	0	0	80	62	48	83	23
12 NEPHTYS INCISA	1	0	0	0	0	0	3	3	0	0
13 NEPHTYS PICTA	3	2	2	0	4	21	5	17	7	4
14 GLYCERA AMERICANA	6	5	4	0	0	19	16	16	20	7
15 GLYCINDE SOLITARIA	6	4	0	0	14	9	1	11	7	3
16 NOTOMASTUS LATERICEUS	13	13	6	0	4	67	29	116	25	21
17 MEDIOMASTUS AMBISETA	0	0	0	0	0	6	0	7	3	1
18 CLYMENELLA TORQUATA	4	13	10	0	12	1	4	5	2	10
19 CLYMENELLA ZONALIS	37	56	28	0	30	213	113	304	141	112
20 ASYCHIS ELONGATA	0	0	0	0	0	2	1	2	0	0
21 POLYDORA LIGNI	4	6	28	0	0	1	5	0	15	2
22 PARAPRIONOSPIO PINNATA	120	74	104	72	124	65	35	37	60	54
23 SCOLELEPTIS SQUAMATA	0	0	0	0	0	1	0	1	0	0
24 SPIOPHANES BOMBYX	0	0	0	0	0	0	0	0	0	0
25 CHAETOPTERUS VARIOPELATUS	4	1	0	0	0	15	14	29	8	6
26 PSEUDEURYTHOE PAUCIBRANCHIATA	12	5	6	6	18	17	11	17	2	2
27 CIRRATULIDAE	2	2	0	0	0	31	10	14	17	2
28 OMENIA FUSIFORMIS	0	1	0	0	0	4	1	2	1	0
29 CISTENA GOULDII	3	2	10	12	0	2	3	1	1	0
30 LOIMIA MEDUSA	6	6	0	12	4	18	8	17	11	1
31 OLIGOCHAETA	0	0	2	0	0	6	0	6	5	0
32 NASSARIUS TRIVITTATUS	6	4	2	0	0	4	2	3	14	0
33 ACTEODICINA CANALICULATA	3	5	24	0	8	2	1	4	2	4
34 TURBONILLA INTERRUPTA	1	2	6	0	2	4	1	1	2	2
35 PELECYPODA	0	0	0	0	0	0	0	0	0	0
36 NUCULA PROXIMA	0	0	2	0	0	2	0	1	0	0
37 YOLDIA LIMATULA	0	0	8	0	0	0	0	4	0	0
38 ANADARA TRANSVERSA	3	1	0	0	0	3	0	2	2	0
39 MACOMA	20	5	0	0	0	13	13	6	13	28
40 MACOMA TENTA	3	4	28	20	0	9	12	13	28	0
41 OXYUROSTYLIS SMITHI	1	0	2	0	0	0	0	0	1	4
42 AMPELISCA ABDITA	17	7	42	18	4	19	17	12	23	7
43 AMPELISCA MACROCEPHALA	0	0	0	0	0	0	1	0	0	0
44 COROPHIUM TUBERCULATUM	0	1	0	2	0	3	2	0	0	1
45 ERICHTHONIUS BRASILIENSIS	9	1	0	0	0	7	3	0	0	6
46 LISTRIELLA BARNARDI	8	11	6	2	0	28	24	27	3	14
47 PARACAPRELLA TENUIIS	0	2	0	0	0	5	1	1	0	0
48 MICROPOLIS ATRA	1	2	0	0	0	5	7	6	5	2
49 SACCOGLOSSUS KOWALEWSKII	3	0	0	0	0	2	4	2	4	2
50 MULLINIA LATERALIS	0	0	10	50	0	0	0	0	0	0
51 EDOTEA TRILOBA	0	0	2	0	0	0	0	0	0	0
52 CLYTIA	0	0	0	2	0	0	0	0	0	0
53 SERTULARIA ARGENTEA	0	1	2	2	0	0	1	0	1	0
54 MYTILUS EDULIS	0	0	0	0	0	0	0	0	0	0
55 AMPELISCA	0	0	0	0	0	0	0	0	0	0
56 PHORONIS	0	5	0	10	6	0	2	0	2	4
57 MORGULA MANHATTENSIS	0	0	0	0	0	0	0	0	0	0
58 CEREBRATULUS LACTEUS	0	0	0	0	0	1	0	2	0	0
59 POLYNOIDAE	0	0	0	0	0	0	0	1	0	0
60 PHYLLODOCE ARENAE	2	0	0	0	0	0	0	1	0	0
61 PRIONOSPIO	1	0	0	0	0	6	0	6	0	0
62 PINNIXA CHAETOPTERANA	0	0	0	0	0	2	1	0	1	0
63 PINNIXA RETINENS	0	0	0	0	0	1	0	0	1	0
64 EDWARDSIA	0	0	0	0	0	0	1	0	3	1
65 MICRURA RUBRA	0	0	0	0	0	0	0	1	1	1
66 AMPHIPORUS BIOCULATUS	0	0	2	0	0	0	0	0	0	1
67 GYPTIS VITTATA	2	0	0	0	0	0	0	11	0	0
68 CYCLOSTRENIUS PENTAGONA	0	9	0	0	0	0	0	1	1	0
69 CYLICHNA ALBA	3	4	0	0	0	2	0	3	0	0
70 LEUCON AMERICANUS	2	0	2	2	0	0	0	0	0	0
71 CERAPUS TUBULARIS	4	1	0	0	0	6	0	0	0	0
72 LISTRIELLA CLYMENELLAE	11	12	10	12	22	8	4	3	5	16
73 SPIOCHAETOPTERUS OCVLATUS	2	0	0	0	0	0	0	1	1	0
74 LEPIDAMETRIA COMMENSALIS	1	1	0	0	0	0	2	0	1	0
75 SAYELLA	0	0	2	2	10	0	0	0	1	0
76 OGYRIDES HAYI	2	3	2	2	0	0	1	0	1	1
77 DIOPATRA CUPREA	0	0	0	0	0	1	1	0	0	0
78 PARAMETOPELLA CYPRIIS	0	0	0	0	0	13	7	2	0	0

1	HYDROZOA	0
2	CERIANTHEOPSIS AMERICANUS	8
3	POLYCLADIA	10
4	TUBULANUS PELLUCIDUS	10
5	HARMOTHOE LUNULATA	0
6	BHAWANIA GOODEI	6
7	GYPTIS BREVIPALPA	8
8	CABIRA INCERTA	0
9	SIGAMBRA TENTACULATA	30
10	NEREIS SUCCINEA	4
11	NEPHTYIDAE	0
12	NEPHTYS INCISA	0
13	NEPHTYS PICTA	12
14	GLYCERA AMERICANA	0
15	GLYCIDAE SOLITARIA	10
16	NOTOMASTUS LATERICEUS	52
17	MEDIOMASTUS AMBISETA	6
18	CLYMENELLA TORQUATA	4
19	CLYMENELLA ZONALIS	220
20	ASYCHIS ELONGATA	4
21	POLYDORA LIGNI	0
22	PARAPRIONOSPID PINNATA	48
23	SCOLELEPTIS SQUAMATA	0
24	SPIOPHANES BOMBYX	0
25	CHAETOPTERUS VARIOPEDATUS	0
26	PSEUDEURYTHOE PAUCIBRANCHIATA	0
27	CIRRATULIDAE	4
28	OWENIA FUSIFORMIS	2
29	CISTENA GOULDII	0
30	LOIMIA MEDUSA	20
31	OLIGOCHAETA	2
32	NASSARIUS TRIVITTATUS	0
33	ACTECCINA CANALICULATA	0
34	TURBONILLA INTERRUPTA	0
35	PELECYPODA	0
36	NUCULA PROXIMA	0
37	YOLDIA LIMATULA	0
38	ANADARA TRANSVERSA	0
39	MACOMA	0
40	MACOMA TENTA	4
41	OXYUROSTYLIS SMITHI	0
42	AMPELISCA ABDITA	4
43	AMPELISCA MACROCEPHALA	0
44	COROPHIUM TUBERCULATUM	0
45	ERICHTHONIUS BRASILIENSIS	0
46	LISTRIELLA BARNARDI	18
47	PARACAPRELLA TENUIS	0
48	MICROPHOLIS ATRA	0
49	SACCOGLOSSUS KOWALEWSKII	4
50	MULINIA LATERALIS	0
51	EDOTEA TRILOBA	0
52	CLYTIA	0
53	SERTULARIA ARGENTEA	0
54	MYTILUS EDULIS	0
55	AMPELISCA	0
56	PHORONIS	0
57	MOLGULA MANHATTENSIS	0
58	CEREBRATULUS LACTEUS	0
59	POLYNOIDAE	0
60	PHYLLODICE ARENAE	0
61	PRIONOSPID	16
62	PINNIXA CHAETOPTERANA	4
63	PINNIXA RETINENS	0
64	EDWARDSIA	0
65	MICRURA RUBRA	0
66	AMPHIPORUS BIOCULATUS	2
67	GYPTIS VITTATA	2
68	CYCLOSTREMISCUS PENTAGONA	0
69	CYLICHA ALBA	0
70	LEUCON AMERICANUS	0
71	CERAPUS TUBULARIS	2
72	LISTRIELLA CLYMENELLAE	0
73	SPIOCHAETOPTERUS OCULATUS	0
74	LEPIDAMETRIA COMMENSALIS	4
75	SAYELLA	0
76	OSYRIDES HAYI	0
77	DIOPATRA CUPREA	2
78	PARAMETOPELLA CYPRIIS	0

Appendix D

Part B. Rappahannock Region Quantitative benthic data
for all species not occurred 15 or more times
for all collection periods at the Rappahannock
Shoals Study Region.

SPECIES / SAMPLES	51 RSC012	52 RSC013	53 RSC014	54 RSC015	55 RSC022	56 RSC023	57 RSC024	58 RSC025	59 RSP012	60 RSP022
1 PSEUDEURYTHOE PAUCIBRANCHIATA	9	0	0	0	0	36	24	50	0	5
2 SIGAMBRA TENTACULATA	8	0	0	0	5	14	24	18	1	22
3 PARAPRIONOSPID PINNATA	307	28	16	10	71	28	48	174	117	186
4 GLYCINDE SOLITARIA	2	0	0	6	11	4	2	22	11	5
5 NEREIS SUCCINEA	3	0	0	16	1	0	4	12	13	8
6 MEDIOMASTUS AMBISETA	4	0	0	0	16	0	0	0	5	0
7 ETEONE HETEROPODA	0	6	0	0	2	2	0	0	0	0
8 SCOLOPLOS FRAGILIS	3	2	0	0	6	4	18	0	0	8
9 AMPELISCA ABDITA	1	0	0	0	11	22	0	22	13	3
10 LISTRIELLA BARNARDI	0	0	0	0	1	0	0	0	0	0
11 MULINIA LATERALIS	0	0	0	0	0	46	18	0	0	3
12 ACTEOCINA CANALICULATA	3	0	0	6	9	30	2	2	1	2
13 SAYELLA	19	0	0	26	0	0	10	8	0	2
14 PHORONIS	0	0	0	0	1	2	0	2	0	0
15 PELECYPODA	0	0	0	0	2	4	0	0	0	0
16 OLIGOCHAETA	1	0	2	0	3	0	0	0	5	0
17 SERTULARIA ARGENTEA	0	0	0	2	0	0	2	2	0	1
18 ACTEON PUNCTOSTRIATUS	0	0	0	2	0	0	0	2	0	0
19 CLYMENELLA ZONALIS	0	0	0	0	0	0	0	0	0	0
20 CLYMENELLA TORQUATA	0	0	0	0	3	4	2	6	0	0
21 GLYCERA AMERICANA	2	2	0	0	1	6	2	0	4	3
22 LOIMIA MEDUSA	0	0	0	0	5	0	0	8	2	0
23 NEPHTYS PICTA	2	0	0	0	10	10	4	0	0	0
24 CISTENA GOULDII	0	4	0	0	27	42	2	8	1	5
25 BHAWANIA GOODEI	0	0	0	0	1	0	0	2	0	0
26 NEPHTYIDAE	7	0	0	0	11	0	0	2	6	24
27 ASYCHIS ELONGATA	0	0	0	0	0	0	0	2	0	0
28 POLYDORA LIGNI	2	0	0	0	6	14	0	0	0	1
29 LEUCON AMERICANUS	0	0	0	0	2	2	2	0	0	0
30 MACOMA TENTA	0	0	0	0	5	4	0	0	0	2
31 MACOMA	0	0	0	0	0	0	0	0	0	0
32 ANADARA TRANSVERSA	1	0	0	0	0	0	0	0	0	0
33 LUCINA MULTILINEATA	0	0	0	0	0	0	0	0	0	0
34 LYONSIA HYALINA	0	0	0	0	1	66	0	0	0	0
35 TURBONILLA INTERRUPTA	0	0	0	0	0	0	0	0	0	0
36 POLYCLADIA	1	0	0	0	5	2	0	8	5	2
37 EDWARDSIA	0	0	0	0	0	0	0	0	0	1
38 TUBULANUS PELLUCIDUS	3	0	0	0	4	0	0	0	1	5
39 GYPTIS BREVIPALPA	0	0	0	0	4	0	0	6	0	0
40 MELINNA MACULATA	0	0	0	0	0	0	0	0	1	0
41 OXYUROSTYLIS SMITHI	1	0	0	0	0	0	0	0	2	6
42 CIRRRATULIDAE	0	0	0	0	0	2	0	0	0	0
43 STREBLOSPIO BENEDICTI	0	0	0	22	0	0	0	0	3	1
44 GLYCERA DIBRANCHIATA	0	0	0	0	1	0	0	0	0	0

SPECIES / SAMPLES	61 RSP023	62 RSP024	63 RSP025	64 RSP032	65 RSP033	66 RSP034	67 RSP035	68 RSP042	69 RSP052	70 RSP053
1 PSEUDEURYTHOE PAUCIBRANCHIATA	0	0	0	3	162	174	210	2	0	0
2 SIGAMBRA TENTACULATA	0	0	0	2	4	4	2	5	1	0
3 PARAPRIONOSPID PINNATA	2	0	32	30	16	2	30	114	304	182
4 GLYCINDE SOLITARIA	0	0	16	8	8	0	24	6	10	4
5 NEREIS SUCCINEA	8	0	2	0	0	0	0	9	7	4
6 MEDIOMASTUS AMBISETA	0	0	0	15	12	0	0	12	2	6
7 ETEONE HETEROPODA	4	0	0	0	0	0	0	3	3	8
8 SCOLOPLOS FRAGILIS	0	0	0	0	0	0	2	1	3	0
9 AMPELISCA ABDITA	2	0	2	50	18	0	6	23	0	0
10 LISTRIELLA BARNARDI	0	0	0	2	0	0	0	0	1	0
11 MULINIA LATERALIS	0	0	2	1	64	24	0	0	0	52
12 ACTEOCINA CANALICULATA	2	0	4	17	34	0	10	2	1	4
13 SAYELLA	0	0	2	2	0	0	2	0	8	22
14 PHORONIS	0	0	0	11	6	4	60	0	1	0
15 PELECYPODA	0	0	0	1	0	0	0	2	0	0
16 OLIGOCHAETA	0	0	0	0	0	0	0	0	4	8
17 SERTULARIA ARGENTEA	2	2	0	2	2	2	0	0	0	0
18 ACTEON PUNCTOSTRIATUS	0	0	8	0	0	0	6	0	1	0
19 CLYMENELLA ZONALIS	0	0	0	5	0	0	0	0	0	0
20 CLYMENELLA TORQUATA	0	0	0	5	8	22	14	0	0	0
21 GLYCERA AMERICANA	0	0	0	6	4	4	0	3	4	0
22 LOINIA MEDUSA	0	0	0	10	4	0	0	0	0	0
23 NEPHTYS PICTA	0	0	0	3	20	16	4	0	0	0
24 CISTENA GOULDII	0	0	0	35	26	2	2	0	1	0
25 BAHAMIA GOODEI	0	0	0	0	0	0	0	0	0	0
26 NEPHTYIDAE	0	0	0	36	0	0	0	2	8	0
27 ASYCHIS ELONGATA	0	0	0	1	0	2	2	0	0	0
28 POLYDORA LIGNI	0	0	0	12	16	0	0	0	1	0
29 LEUCON AMERICANUS	0	0	2	0	0	0	0	0	0	0
30 MACOMA TENTA	0	0	0	1	0	4	0	0	0	0
31 MACOMA	0	0	2	13	0	0	0	0	1	2
32 ANADARA TRANSVERSA	2	0	0	4	4	0	0	0	1	0
33 LUCINA MULTILINEATA	0	0	0	2	2	0	0	0	0	0
34 LYONSIA HYALINA	0	0	0	7	84	0	0	0	0	0
35 TURBONILLA INTERRUPTA	0	0	0	1	2	0	2	0	0	0
36 POLYCLADIA	0	0	0	1	0	0	0	3	0	0
37 EDWARDSIA	0	0	0	3	0	0	0	0	0	0
38 TUBULANUS PELLUCIDUS	0	0	0	0	0	0	2	0	6	0
39 GYPTIS BREVIPALPA	0	0	0	2	2	0	6	0	0	0
40 MELINNA MACULATA	0	0	0	6	6	10	2	0	1	0
41 OXYUROSTYLIS SMITHI	0	0	0	5	0	0	0	1	1	0
42 CIRRATULIDAE	0	0	0	20	8	10	12	2	0	0
43 STREBLOSPID BENEDICTI	4	0	6	0	0	0	0	15	0	8
44 GLYCERA DIBRANCHIATA	0	0	2	3	6	2	8	0	0	0

SPECIES / SAMPLES	71 RSP054	72 RSP055	73 RSP062	74 RSP072	75 RSP073	76 RSP074	77 RSP075	78 RSP082	79 RSP083	80 RSP084
1 PSEUDEURYTHOE PAUCIBRANCHIATA	0	0	72	9	2	0	0	22	586	204
2 SIGAMBRA TENTACULATA	0	0	5	38	0	2	0	8	12	18
3 PARAPRIONOSPIO PINNATA	2	108	24	335	280	0	34	40	8	14
4 GLYCINDE SOLITARIA	0	20	7	9	0	2	6	6	2	2
5 NEREIS SUCCINEA	0	32	0	2	4	0	8	3	2	2
6 MEDIOASTUS AMBISETA	0	0	3	8	42	0	0	4	30	6
7 ETEONE HETEROPODA	0	0	1	8	18	0	0	0	4	0
8 SCOLOPLOS FRAGILIS	0	2	0	1	4	0	0	1	0	2
9 AMPELISCA ABDITA	0	0	26	5	2	0	0	55	48	0
10 LISTRIELLA BARNARDI	0	0	2	0	0	0	0	1	2	0
11 MULINIA LATERALIS	4	0	1	0	432	0	0	18	574	52
12 ACTEOCINA CANALICULATA	0	0	0	11	6	0	0	27	12	0
13 SAYELLA	0	8	0	245	352	0	0	0	4	2
14 PHORONIS	0	0	9	0	0	0	0	37	22	14
15 PELECYPODA	4	0	72	0	6	0	0	0	0	0
16 OLIGOCHAETA	0	0	0	1	10	0	0	3	10	0
17 SERTULARIA ARGENTEA	0	0	2	1	0	0	0	1	0	2
18 ACTEON PUNCTOSTRIATUS	0	4	0	0	0	0	0	0	0	6
19 CLYMENELLA ZONALIS	0	0	1	0	0	0	0	1	0	0
20 CLYMENELLA TORQUATA	0	0	2	0	0	0	0	28	8	12
21 GLYCERA AMERICANA	0	0	2	7	0	0	0	8	0	0
22 LOIMIA MEDUSA	0	0	4	0	0	0	0	2	2	4
23 NEPHTYS PICTA	0	0	10	1	0	0	0	4	76	50
24 CISTENA GOULDII	0	0	20	2	0	0	2	18	26	0
25 BHAWANIA GOODEI	0	0	0	0	0	0	0	7	4	4
26 NEPHTYIDAE	0	0	47	5	0	0	0	26	10	0
27 ASYCHIS ELONGATA	0	0	0	0	0	0	0	3	2	0
28 POLYDORA LIGNI	0	0	28	1	2	0	0	15	302	0
29 LEUCON AMERICANUS	0	2	0	0	0	0	0	0	0	0
30 MACOMA TENTA	0	0	46	7	0	0	0	6	36	12
31 MACOMA	0	0	4	0	0	0	0	0	0	0
32 ANADARA TRANSVERSA	0	0	1	0	2	0	0	6	6	0
33 LUCINA MULTILINEATA	0	0	4	1	4	0	0	1	0	0
34 LYONSIA HYALINA	0	0	25	0	4	0	0	5	292	0
35 TURBONILLA INTERRUPTA	0	0	0	0	0	0	0	0	0	0
36 POLYCLADIA	0	10	2	4	2	0	0	4	2	0
37 EDWARDSIA	0	0	11	1	0	0	0	6	8	0
38 TUBULANUS PELLUCIDUS	0	0	2	3	0	0	0	6	0	0
39 GYPTIS BREVIPALPA	0	0	1	0	0	0	0	13	6	2
40 MELINNA MACULATA	0	0	6	2	0	0	0	2	2	0
41 OXYUROSTYLIS SMITHI	0	0	2	0	0	0	0	1	0	0
42 CIRRATULIDAE	0	0	0	0	0	0	0	2	10	100
43 STREBLOSPIO BENEDICTI	0	2	0	0	8	2	0	1	16	6
44 GLYCERA DIBRANCHIATA	0	0	3	0	0	0	0	4	6	0

SPECIES / SAMPLES	81 RSP085	82 RSP092	83 RSP102	84 RSP112	85 RSP122	86 RSP123	87 RSP124	88 RSP125	89 RSP132	90 RSP133
1 PSEUDEURYTHOE PAUCIBRANCHIATA	262	5	1	20	7	86	144	204	1	64
2 SIGAMBRA TENTACULATA	16	2	6	22	1	6	22	4	12	6
3 PARAPRIONOSPIO PINNATA	20	7	57	53	5	6	6	18	174	418
4 GLYCINDE SOLITARIA	8	3	3	0	5	0	0	8	6	8
5 NEREIS SUCCINEA	2	1	2	2	4	2	2	2	0	0
6 MEDIOMASTUS AMBISETA	0	2	9	17	0	0	0	0	6	136
7 ETEONE HETEROPODA	0	0	2	0	2	6	0	0	0	14
8 SCOLOPLOS FRAGILIS	0	0	0	0	0	0	2	0	3	38
9 AMPELISCA ABDITA	0	35	9	48	39	36	2	0	15	2
10 LISTRIELLA BARNARDI	0	0	0	0	0	4	0	0	3	0
11 MULINIA LATERALIS	0	8	0	55	11	138	30	0	1	0
12 ACTEOCINA CANALICULATA	0	3	15	3	23	34	0	0	10	10
13 SAYELLA	2	0	7	0	0	8	0	0	121	218
14 PHORONIS	32	19	0	2	114	42	16	64	0	0
15 PELECYPODA	2	111	0	81	31	0	0	0	0	0
16 OLIGOCHAETA	0	1	0	12	0	0	0	0	0	18
17 SERTULARIA ARGENTEA	2	0	0	2	1	2	2	2	1	2
18 ACTEON PUNCTOSTRIATUS	0	0	1	0	0	0	0	0	4	0
19 CLYMENELLA ZONALIS	0	2	0	0	0	0	0	0	0	0
20 CLYMENELLA TORQUATA	12	0	0	3	3	2	6	16	0	0
21 GLYCERA AMERICANA	0	1	1	1	2	0	0	0	4	2
22 LOIMIA MEDUSA	0	0	1	1	3	2	0	2	1	0
23 NEPHTYS PICTA	10	14	0	49	12	6	20	18	0	0
24 CISTENA GOULDII	4	7	0	53	17	14	4	2	15	22
25 BHAWANIA GOODEI	0	0	0	3	1	0	6	4	0	0
26 NEPHTYIDAE	0	65	0	80	37	30	0	2	4	0
27 ASYCHIS ELONGATA	2	2	0	1	0	2	0	4	0	0
28 POLYDORA LIGNI	10	19	0	13	40	12	0	0	0	86
29 LEUCON AMERICANUS	0	0	0	0	0	0	0	0	0	0
30 MACOMA TENTA	6	16	0	0	0	0	8	0	2	8
31 MACOMA	0	12	2	0	11	0	0	0	3	0
32 ANADARA TRANSVERSA	0	1	0	61	1	0	0	0	0	0
33 LUCINA MULTILINEATA	0	1	0	2	6	14	8	2	0	0
34 LYONSIA HYALINA	0	56	1	17	23	112	0	0	0	2
35 TURBONILLA INTERRUPTA	0	0	0	0	0	0	0	0	0	0
36 POLYCLADIA	0	1	4	0	1	0	0	2	4	6
37 EDWARDSIA	0	6	0	3	4	10	0	0	0	0
38 TUBULANUS PELLUCIDUS	0	1	0	3	2	0	0	2	0	2
39 GYPTIS BREVIPALPA	4	0	0	1	5	0	4	4	0	2
40 MELINNA MACULATA	0	2	1	2	0	0	8	2	2	0
41 OXYUROSTYLIS SMITHI	0	4	0	4	4	0	0	0	1	0
42 CIRRATULIDAE	14	26	0	1	3	2	6	8	0	0
43 STREBLOSPIO BENEDICTI	0	1	1	0	0	0	0	0	0	2
44 GLYCERA DIBRANCHIATA	0	4	1	1	7	2	8	2	0	0

SPECIES / SAMPLES	91 RSP134	92 RSP135	93 RSP142	94 RSP143	95 RSP144	96 RSP145	97 RSP152	98 RSP162	99 RSP172	100 RSP182
1 PSEUDEURYTHOE PAUCIBRANCHIATA	0	0	43	28	68	96	8	5	2	19
2 SIGAMBRA TENTACULATA	4	0	0	0	0	12	0	15	16	1
3 PARAPRIONOSPIO PINNATA	26	106	5	0	0	10	4	109	114	9
4 GLYCINDE SOLITARIA	2	10	5	0	0	4	2	8	4	2
5 NEREIS SUCCINEA	0	34	1	0	0	0	4	0	1	0
6 MEDIOASTUS AMBISETA	0	0	1	2	0	0	3	27	10	1
7 ETEONE HETEROPODA	0	0	1	0	0	0	1	4	0	0
8 SCOLOPLOS FRAGILIS	0	0	2	0	6	0	2	1	0	1
9 AMPELISCA ABDITA	0	0	19	6	0	0	46	45	19	15
10 LISTRIELLA BARNARDI	0	0	1	4	0	0	1	0	0	2
11 MULINIA LATERALIS	38	0	15	66	12	0	2	1	83	11
12 ACTEOCINA CANALICULATA	0	0	63	10	0	0	20	6	4	20
13 SAYELLA	0	6	1	46	4	40	0	4	3	0
14 PHORONIS	0	0	80	0	82	124	78	4	5	96
15 PELECYPODA	0	0	39	0	0	0	3	2	62	14
16 OLIGOCHAETA	0	0	1	0	0	0	0	0	0	0
17 SERTULARIA ARGENTEA	0	2	2	0	0	2	1	0	0	0
18 ACTEON PUNCTOSTRIATUS	0	0	1	0	0	2	0	3	0	0
19 CLYMENELLA ZONALIS	0	0	1	2	0	2	2	0	2	2
20 CLYMENELLA TORQUATA	0	0	3	0	12	12	3	2	0	3
21 GLYCERA AMERICANA	0	0	2	0	0	0	5	1	0	2
22 LOIMIA MEDUSA	0	0	2	2	0	0	6	0	1	10
23 NEPHTYS PICTA	0	0	10	4	38	16	5	3	22	3
24 CISTENA GOULDII	0	0	8	4	6	0	20	14	31	6
25 BHAWANIA GOODEI	0	0	0	2	0	4	0	0	0	2
26 NEPHTYIDAE	0	2	33	6	0	0	22	14	27	54
27 ASYCHIS ELONGATA	0	0	0	4	0	2	3	1	0	2
28 POLYDORA LIGNI	0	0	2	20	0	0	8	4	0	0
29 LEUCON AMERICANUS	0	0	0	0	0	0	0	0	0	0
30 MACOMA TENTA	0	0	9	66	20	0	5	3	22	29
31 MACOMA	0	0	0	0	0	4	0	0	0	0
32 ANADARA TRANSVERSA	0	0	0	4	0	0	14	0	1	0
33 LUCINA MULTILINEATA	0	0	5	0	2	10	9	0	0	1
34 LYONSIA HYALINA	0	0	28	54	0	0	4	0	0	5
35 TURBONILLA INTERRUPTA	0	0	0	4	0	16	0	0	0	0
36 POLYCLADIA	0	2	0	0	0	2	2	1	1	0
37 EDWARDSIA	0	0	2	0	0	0	0	0	0	1
38 TUBULANUS PELLUCIDUS	0	0	1	0	0	0	1	0	2	1
39 GYPTIS BREVIPALPA	0	0	1	2	0	6	0	5	0	1
40 MELINNA MACULATA	0	0	2	0	2	2	5	6	0	1
41 OXYUROSTYLIS SMITHI	0	0	0	2	0	0	2	4	2	0
42 CIRRATULIDAE	0	0	3	0	16	14	2	1	0	0
43 STREBLOSPID BENEDICTI	0	0	0	0	0	0	0	0	0	0
44 GLYCERA DIBRANCHIATA	0	0	6	8	0	0	7	4	0	3

SPECIES / SAMPLES	101	102	103
	RSP183	RSP184	RSP185
1 PSEUDEURYTHOE PAUCIBRANCHIATA	20	42	94
2 SIGAMBRA TENTACULATA	6	6	6
3 PARAPRIONOSPID PINNATA	8	4	26
4 GLYCINDE SOLITARIA	2	0	0
5 NEREIS SUCCINEA	0	0	0
6 MEDIOMASTUS AMBIVETA	4	0	0
7 ETEONE HETEROPODA	2	0	0
8 SCOLOPLOS FRAGILIS	0	0	0
9 AMPELISCA ABDITA	26	0	0
10 LISTRIELLA BARNARDI	0	0	0
11 MULINIA LATERALIS	106	20	0
12 ACTEOCINA CANALICULATA	22	2	2
13 SAVELLA	50	0	4
14 PHORONIS	98	114	160
15 PELECYPODA	0	0	0
16 OLIGOCHAETA	4	0	0
17 SERTULARIA ARGENTEA	2	2	0
18 ACTEON PUNCTOSTRIATUS	0	0	0
19 CLYMENELLA ZONALIS	0	2	0
20 CLYMENELLA TORQUATA	8	14	12
21 GLYCERA AMERICANA	0	2	0
22 LOIPIA MEDUSA	10	2	2
23 NEPHTYS PICTA	6	40	6
24 CISTENA GOULDII	4	2	0
25 BHAWANIA GOODEI	0	6	6
26 NEPHTYIDAE	56	0	0
27 ASYCHIS ELONGATA	0	0	0
28 POLYDORA LIGNI	0	0	0
29 LEUCON AMERICANUS	0	0	0
30 MACOMA TENTA	38	10	2
31 MACOMA	30	8	4
32 ANADARA TRANSVERSA	0	0	0
33 LUCINA MULTILINEATA	4	0	2
34 LYONSIA HYALINA	96	0	0
35 TURBONILLA INTERRUPTA	14	0	10
36 POLYCLADIA	0	2	0
37 EDWARDSIA	6	0	0
38 TUBULANUS PELLUCIDUS	0	2	4
39 GYPTIS BREVIPALPA	6	4	2
40 MELINNA MACULATA	0	0	2
41 OXYUROSTYLIS SMITHI	0	0	0
42 CIRRATULIDAE	0	0	6
43 STREBLOSPID BENEDICTI	8	0	0
44 GLYCERA DIBRANCHIATA	8	4	4