

1990

## Atmospheric input of polycyclic aromatic hydrocarbons to the sea surface microlayer

Lino J. Gallo

*College of William and Mary - Virginia Institute of Marine Science*

Follow this and additional works at: <https://scholarworks.wm.edu/etd>



Part of the [Environmental Sciences Commons](#), [Oceanography Commons](#), and the [Organic Chemistry Commons](#)

---

### Recommended Citation

Gallo, Lino J., "Atmospheric input of polycyclic aromatic hydrocarbons to the sea surface microlayer" (1990). *Dissertations, Theses, and Masters Projects*. Paper 1539616655.

<https://dx.doi.org/doi:10.25773/v5-yqf8-et90>

This Dissertation is brought to you for free and open access by the Theses, Dissertations, & Master Projects at W&M ScholarWorks. It has been accepted for inclusion in Dissertations, Theses, and Masters Projects by an authorized administrator of W&M ScholarWorks. For more information, please contact [scholarworks@wm.edu](mailto:scholarworks@wm.edu).

## INFORMATION TO USERS

The most advanced technology has been used to photograph and reproduce this manuscript from the microfilm master. UMI films the text directly from the original or copy submitted. Thus, some thesis and dissertation copies are in typewriter face, while others may be from any type of computer printer.

**The quality of this reproduction is dependent upon the quality of the copy submitted.** Broken or indistinct print, colored or poor quality illustrations and photographs, print bleedthrough, substandard margins, and improper alignment can adversely affect reproduction.

In the unlikely event that the author did not send UMI a complete manuscript and there are missing pages, these will be noted. Also, if unauthorized copyright material had to be removed, a note will indicate the deletion.

Oversize materials (e.g., maps, drawings, charts) are reproduced by sectioning the original, beginning at the upper left-hand corner and continuing from left to right in equal sections with small overlaps. Each original is also photographed in one exposure and is included in reduced form at the back of the book.

Photographs included in the original manuscript have been reproduced xerographically in this copy. Higher quality 6" x 9" black and white photographic prints are available for any photographs or illustrations appearing in this copy for an additional charge. Contact UMI directly to order.

# U·M·I

University Microfilms International  
A Bell & Howell Information Company  
300 North Zeeb Road, Ann Arbor, MI 48106-1346 USA  
313/761-4700 800/521-0600



Order Number 9024574

**Atmospheric input of polycyclic aromatic hydrocarbons to the  
sea surface microlayer**

**Gallo, Lino Juan, Ph.D.**

**The College of William and Mary, 1990**

**U·M·I**  
300 N. Zeeb Rd.  
Ann Arbor, MI 48106



ATMOSPHERIC INPUT OF POLYCYCLIC AROMATIC HYDROCARBONS  
TO THE SEA SURFACE MICROLAYER

A Dissertation  
Presented to  
The Faculty of the School of Marine Science  
The College of William and Mary

In Partial Fulfillment  
Of the Requirements for the Degree of  
Doctor of Philosophy

by

Lino J. Gallo

1990

APPROVAL SHEET

This dissertation is submitted in partial fulfillment of  
the requirements for the degree of

Doctor of Philosophy

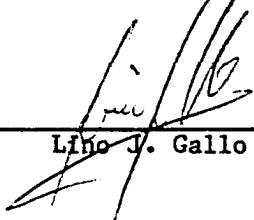
  
\_\_\_\_\_  
Lino J. Gallo

Approved, May 1990

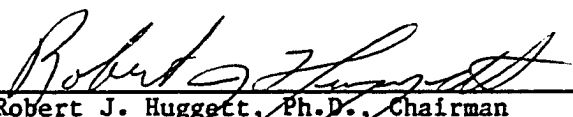
  
\_\_\_\_\_  
Robert J. Huggett, Ph.D., Chairman

  
\_\_\_\_\_  
William G. MacIntyre, Ph.D.

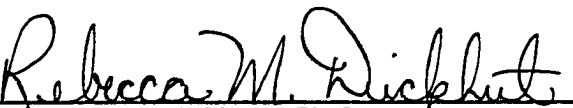
  
\_\_\_\_\_  
Rebecca M. Dickhut, Ph.D.

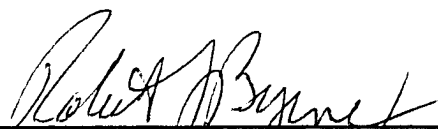
  
\_\_\_\_\_  
Robert J. Byrne, Ph.D.

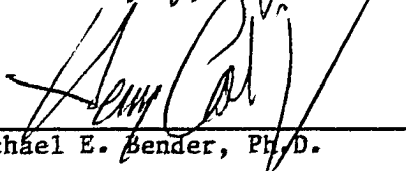
  
\_\_\_\_\_  
for Michael E. Bender, Ph.D.

  
\_\_\_\_\_  
Randolph A. Coleman, Ph.D.  
Department of Chemistry  
College of William and Mary

To my parents and to my uncle and aunt, Dr. and Mrs. Juan J. Touya



## **ACKNOWLEDGEMENTS**

I want to thank my research committee, specially Drs. Robert Huggett and William MacIntyre; the Department of Chemistry and Toxicology of V.I.M.S.; Dr. John Bensei, Department of Physics, The College of William and Mary; and to my friends that, in one way or another, supported me throughtout this research.

## ABSTRACT

Atmospheric input of polycyclic aromatic hydrocarbons (PAH) to water was studied and the effects of sea surface microlayer (SSM) determined. The York River system and the Perrin River areas were monitored with a drum skimmer and a high volume air samplers. Experiments were conducted in the laboratory under controlled conditions. The SSM extracted vapor phase PAH of low molecular weight from the air, and there, aromatic compounds went from dissolved into particulate phase very rapidly. Water covered with a natural SSM received much less atmospheric input of PAH than water without SSM in a given period of time. Henry's law constant did not apply when SSM was present. The high uptake capacity of this type of film makes it impossible to approach equilibrium conditions in the marine atmospheric environment.

## INDEX

	page
I Introduction	1
I-1 Objective	
I-2 Sea surface microlayer (SSM): importance and composition	
I-3 Polycyclic aromatic hydrocarbons (PAH) in the aquatic environment	
I-3.1 Sources of PAH in the aquatic environment	
I-3.2 Distribution of PAH in the aquatic environment	
I-3.3 Degradation of PAH in the aquatic environment	
I-4 Atmospheric transport of PAH and their input to SSM	
I-5 Previous studies in the Chesapeake Bay	
II Field studies: York River system and Perrin River	28
II-1 Sampling sites	
II-2 SSM collector and sampling operation	
II-3 Subsurface water samples collection	
II-4 Air collector	
II-5 Laboratory analyses	
II-5.1 SSM samples analysis (PAH)	
II-5.2 Tributyltin (TBT) analysis	
II-6 Results	
II-6.1 York River system study	
II-6.2 Perrin River study	

II-7 Discussion of field work	
III Transfer of vapor phase naphthalene from air to water under laboratory conditions	75
III-1 Materials and methods	
III-2 Experiments and results	
III-2.1 High purity water, part 1	
III-2.2 High purity water, part 2	
III-2.3 York River water	
III-2.4 SSM only	
III-2.5 High purity water and SSM	
III-2.6 Glass uptake	
III-3 Henry's law constant	
IV Summary of observations	106
IV-1 Field observations	
IV-2 Laboratory observations	
IV-3 General observation	
V Conclusions	110
VI Bibliography	111

Any subject as complicated and elusive as sea surface microlayer processes is bound to generate attempts to explain them, and some of these will seem exotic and controversial, if not downright bizarre, to some workers. Some explanations display no little ingenuity and imagination on part of their creators, and they are all entertaining, though provoking, and perhaps contain varying degrees of truth.

(Adapted from F. McIntyre, 1974)

## I INTRODUCTION

### I-1 Objective

The objective of this dissertation was to test the hypothesis that the sea surface microlayer plays an important role in the transport of polycyclic aromatic hydrocarbons from the atmosphere to subsurface water.

To accomplish this goal, five steps were followed:

- (1) Development of a reliable sea surface microlayer sampler, and an air sampler to collect organic chemicals in both vapor and particulate phases.
- (2) Determination of polycyclic aromatic hydrocarbons (PAH) and tributyltin (TBT) concentrations in the York River system's sea surface microlayer.
- (3) Determination of time variability on the sea surface microlayer's PAH composition at a specific location, i.e. Ferrin River.
- (4) Description of how PAH enter the sea surface microlayer (SSM) from the atmosphere, i.e., vapor/particulate phase (air) into dissolved/particulate (SSM).

- (5) Measurement of PAH uptake from the vapor phase by water and SSM under laboratory conditions.

#### I-2 Sea surface microlayer: importance and composition

Important biological and chemical processes occur at surfaces or interfaces between different environments. The sea surface microlayer (SSM) represents the interface between atmosphere and ocean. It covers 71% of the earth's surface and plays an important role in the transport of natural and man made substances between the atmosphere and the hydrosphere. "Surface water" means many things, but to a marine scientist it has customarily meant a sample collected in a bucket from shipboard. "Surface microlayer" is also a loosely defined term, whose use varies with the scientific discipline involved. Its thickness can be defined operationally by a particular sampling method. Roughly it extends from 30 nm (the diameter of a water molecule, and therefore as close as one can come to pinning down the surface), to about 3 mm, which is near the extreme limit of the nonturbulent ocean current boundary layer with no wind, and is also the penetration depth of jets from small bubbles (which are a major dynamic expression of microlayer forces) (F. MacIntyre, 1974).

There is a continuous microscopic exchange of matter between the molecular surface (i.e., the top layer of molecules) and the underlying liquid, driven by Brownian motion. Davies and Rideal (1961) compute the

surface lifetime ( $\tau$ ) of a molecule before exchange with subsurface molecules from the self diffusion coefficient ( $D_s$ ) of water through ( $\tau = \lambda^2/D_s$ ), with  $D_s = 2 \times 10^{-5}$  cm<sup>2</sup>/sec. and  $\lambda$ , the equilibrium distance between molecules, equal to  $3.5 \times 10^{-8}$  cm. This makes  $\tau$  about 60 psec., or perhaps 1000 molecular vibrations. This rapid exchange can be ignored in most chemical and all geochemical problems because it occurs obiquitously as a constant background activity of the sea surface microlayer, and there is no current way to observe the process in the field.

The physical form of the SSM results from a macroscopic kinetic steady-state process: a balance between the creating force of viscous damping and the destroying force of erosion by turbulence from below. In contrast, the Brownian exchange dilation produces bulk hydrodynamic flows between surface and subsurface and alters surface properties by changing the number of molecular sites available (F. McIntyre, 1974).

Processes of organic solute order formation occuring in the SSM are so significant that some authors guess that this interface organized organic molecules into the first semblances of life over three billion years ago (Fox, 1965; Ponnampereuma and Gabel, 1968).

The SSM serves as a point of concentration for many substances of anthropogenic origin such as petroleum hydrocarbons, trace metal compounds, plastic debris, pesticides and polychlorinated biphenyls. It also provides a habitat for a diverse and abundant flora and fauna (neuston) which is much more biologically active, on a volume basis, than is the water column below.



This intense activity may bring about chemical transformations of both natural and man-made materials in the marine environment. SSM material may be dispersed into the main body of the water by turbulence or by sinking of living or non-living particles which may or may not have adsorbed SSM component organic molecules on their surfaces. Another dispersion mechanism is the dissolution of water soluble SSM component molecules, a process which is greatly aided by compression of the water surface by winds, waves, current, etc. Processes operating on material within the SSM may involve biochemical, photochemical or inorganic (often oxidative) reactions. The products of these reactions may remain in the layer or be transported to the atmosphere or subsurface water (Liss, 1975).

In coastal and other areas of high inputs of organic matter, from more intense biological processes or from anthropogenic input of hydrocarbons, the SSM is thicker and more complex. Furthermore, in nearshore regions, winds are generally lighter than over the open oceans, so that wind stress on the surface water may be sufficient to displace less surface active molecules to the subsurface water, but insufficient for complete film destruction (Hunter and Liss, 1977).

A "water attracting" (hydrophilic) group is a necessary component of a surface active molecule at air-water interface. Surface active molecules are often called surfactants; they may also be termed amphiphiles. The hydrophobic portion of surfactant molecules are called lipophilic to emphasize their affinity for lipids and other non-polar organic solvents.

Surfactants molecules also contain a separate polar hydrophilic group which generally contains an unshared pair of electrons on either an oxygen or a nitrogen atom. The existence of this unshared pair provides a negative charge that is sufficiently exposed that hydrogen atoms in water molecules can engage in hydrogen bonding with it. The hydrophilic group thus associates with the aqueous phase at the interphase. Not all organic molecules with hydrophilic groups form films, since suitable length and character of the "water-repelling" (hydrophobic) groups are also requisites. The degree of surface activity of an alkyl surfactant generally increases with the length of the hydrocarbon chain. Molecules whose hydrophobic groups have less than four or five carbon atoms are generally water soluble; they may alter the surface properties of water but by themselves will not form films (Gill et al., 1983).

The simplest model of organic film structure is that assumed for a film formed by long-chain saturated fatty acids and alcohols. The OH or COOH group is attracted to and penetrates water, but is unable to pull the hydrocarbon chain completely into the water, leaving it above the water surface. The actual structure and thickness of the SSM and whether monomolecular films are actually present at the air-sea interface, sea state and wind permitting, are not known. There is considerable indirect experimental evidence for the occurrence of monolayers at the sea surface. For example, finely divided powders (talc, wax, flour) spread on the sea

surface from small boats will frequently move windward at velocities exceeding that of the surface currents or boat drift.

Peter Williams (1986), in a study off Baja California, describes a SSM made of protein, carbohydrates and lipids with a mean of 50% of the total particulate organic carbon and a mean of 28% of total dissolved organic carbon. Lipids, once described as the main component of the SSM, were in this instance only 18% of total identified organic compounds. There still is a "perplexing unidentified" 40% of the TPOC. Part of the lipid material observed by Garrett (1967) and other workers has arisen from decomposition of SSM plankton during chloroform extraction. One certain thing is that the SSM is a complex chemical mixture.

F. McIntyre (1974) states that the consequences of a major proteinaceous component in the surface monolayer are both chemical and mechanical. A protein of molecular weight 4000 may be a chain of some 2000 nm long when unwound. Such chains, if attached at relatively few points, might increase the influence of the surface on the viscosity of water by an order of magnitude beyond the influence of lipid polar head groups. Proteins may, for instance, help to account for the thickness of oceanic bubble film caps. Chemically, proteins provide abundant sites for ion complexing, and provide useful carriers for a wide variety of associated organic substances.

The SSM plays a major role in the reproductive process of many fish, shellfish and crustacea, whose eggs and early larval stages often concentrate in and depend on the SSM (Zaistev, 1971; Castagna, 1977).

However, it is not clear whether the observed high microorganism population in the SSM exists because of the abundant food provided by the non-living organic matter, or vice versa. Possibly both the organisms and this organic matter are enriched at the surface because both are concentrated there by similar mechanisms (Liss, 1975).

An operational defined depth for the microlayer, and an accepted average chemical composition of the SSM have not yet been achieved, as shown in Table I-1. It is probably that observed composition varies with the method of sampling.

**TABLE I-1: Type of samplers and approximate chemical composition of SSM reported in the literature. Samples depths estimates are given where available.**

<b>AUTHOR(S)</b>	<b>SAMPLER</b>	<b>SSM DEPTH AND LOCATION</b>	<b>SSM COMPOUNDS ANALYZED</b>
Garrett (67)	screen	100-450 um	fatty esters, free fatty acids, hydrocarbons
Ledet & Lester (74)	teflon disc		CH <sub>3</sub> branched alkanes (C <sub>15</sub> -C <sub>35</sub> ), cycloalkanes

Baier	ceramic drum and screen	lake	glycoproteins, et al. (74) proteoglycans, aliphatics, and esterified oils.
Larson et al. (74)	teflon plate		40-65%: triglycerids 15-30%: free fatty acids
Wade & Quinn (75)	screen	Sargasso Sea	79-97%: unresolved components
Dumas et al. (76)	screen PVC cylinder	440 um 50-80 um Mediterranean	glucids, lipids, hydrocarbons
Hunter & Liss (77)	wire screen	100-300 um North Sea	28% mono + hydroli- zable polysaccharids
Odham et al. (78)	teflon plate		5 molec.layers of fatty acids + glycerids
Oftad et al. (79)	teflon sheet	Swedish coast	"fatty layer"

Kjelleberg et al. (79)	hydrophobic + philic Nucleo- pore membranes		1000-3000 nm polysaccharids bacterioneuston to 1 um
Carlson & Mayer (80)	IR spectroscopic evidence	Maine coast	carbohydrate-protein complexes
Tsunagai & Tanaka (80)		12um (winter) 45um (summer) Japan coast	
Pattenden et al. (81)	bubble-burst sampler	-	trace metals
Carlson (82)	screen glass plate	277+/- 46 um 52+/- 1.8um Maine coast	higher enrichment of dissolved organic carbon in plate samples
Jullien et al. (82)	screen	0.44 mm Mediterranean	Proteins, hydrocarbons, complex organic material, rich in lipids
Hardy (82)			100-200 nm lipids

			1000-3000 nm polysaccharids, and proteins 1 um bacteria and yeasts
Kattner et al. (85)	skimmer	Mediterranean	Proteins, particulate organic carbon, particulate organic nitrogen, phytoplankton
Gucinski (86)	glass plate	Chesapeake Bay	Lipids, hydrocarbons, non- polar moieties of proteins
Williams et al. (86)	catamaran w/screens	220-300 um Baja California	Proteins, humic type material, lipids
Cross et al. (87)	teflon drum		trace metals, chlorinated hydrocarbons, PAH
von Western- hazen et al. (87)	glass plate	50 um Puget Sound	high fatty acids
Hardy et al. (87)	teflon drum	30-60 um Chesapeake Bay	trace metals, alkanes, aromatics

Many authors assume that the SSM covers the ocean surface completely, and regenerates rapidly if disrupted by wave action. Other authors, such as P. Liss (1975), disagree with this concept and contend that data on surface pressure and voltage from open ocean indicates clean water surfaces. Liss also states that slick formation is dependent on the availability of sufficient surface active material and on a water circulation which will compress the film sufficiently to damp out capillary waves without the water being so turbulent that the slick is broken up. Slicks are thus assumed unlikely in the open ocean both because of the paucity of surface active molecules and because sea states are generally too high.

Different definitions in SSM structure and composition are probably the result of both using different sampling techniques and sampling at different locations, i.e. slicked vs. non-slicked water surfaces, polluted vs. non-polluted areas.

In the long run, practical matters such as effects of agriculture, industrial air pollution, and consequent climate modification and ocean pollution are related directly to sea-air film transport chemistry through such questions as: (1) to what extent does the sea surface contribute the plant nutrients N, K and P to global rainfall? (2) To what extent are pollutants concentrated in the SSM, and where do they go from there? (3) Is it possible, by modifying the sea surface, to modify the rate of energy transfer through it? (4) Does the SSM alter the transport of carbon dioxide,



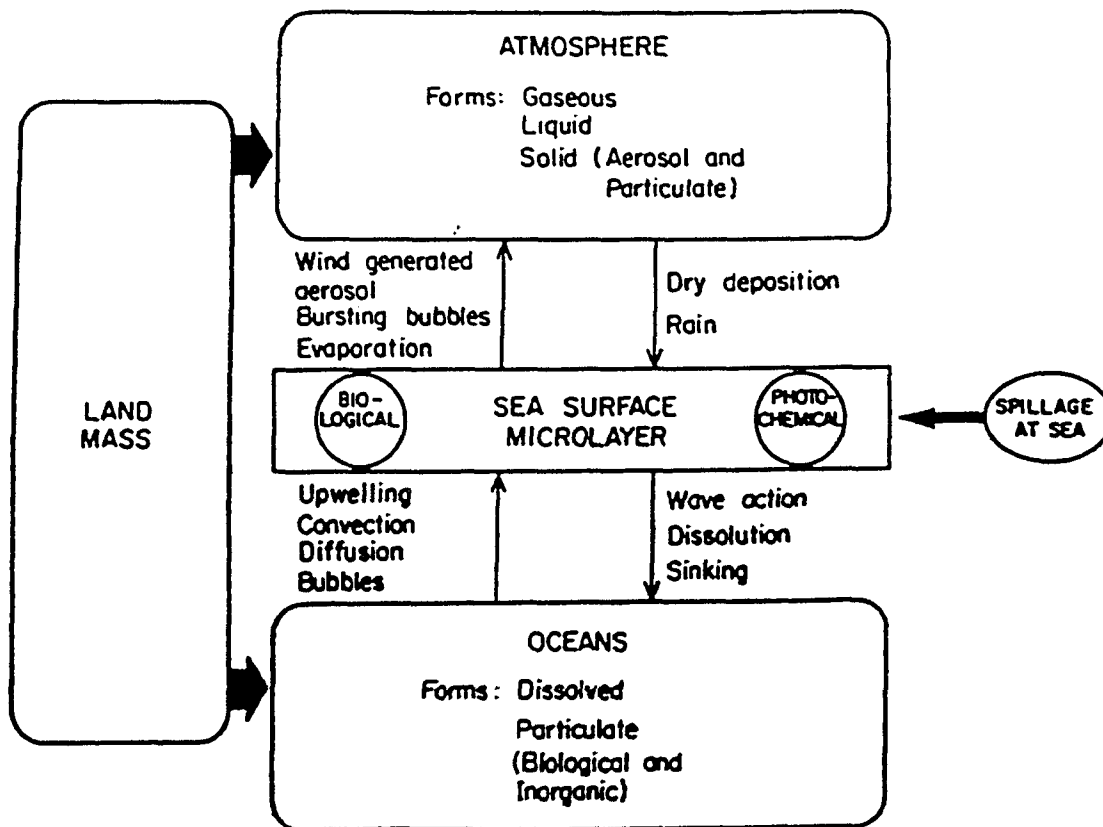

Figure I-1 . Sources and sinks of natural and man-made materials for the SSM, including internal processes within the layer (from Liss, 1975).

carbon monoxide, nitrogen oxide, chlorofluorocarbons, etc. from atmosphere to ocean, thereby affecting world climate?

### I-3 Polycyclic aromatic hydrocarbons (PAH) in the aquatic environment

PAH are of concern in marine systems because of their wide distribution and because some of them are toxic or carcinogenic to marine organisms or humans. These chemicals are present in the aquatic environment in various condensed ring systems, from naphthalene (C<sub>10</sub> H<sub>8</sub>), molecular weight 120.16 to coronene (C<sub>24</sub> H<sub>12</sub>), molecular weight 300.36. We can divide them into two molecular weight classes:

- 1) Lower molecular weight, having two and three aromatic rings, that is, naphthalenes, phenanthrenes, and anthracenes. This group has significant acute toxicity to aquatic organisms.
- 2) Higher molecular weight systems having four to seven aromatic rings, e.g., chrysene, coronene. The proven PAH carcinogens are in this group.

There is a conventional nomenclature to represent PAH structures. The maximum number of rings are in the upper right quadrant and the minimum in the lower left quadrant. The carbon atoms are numbered clockwise; carbon number one is the counterclockwise of the top on the right ring (fig.I-2);

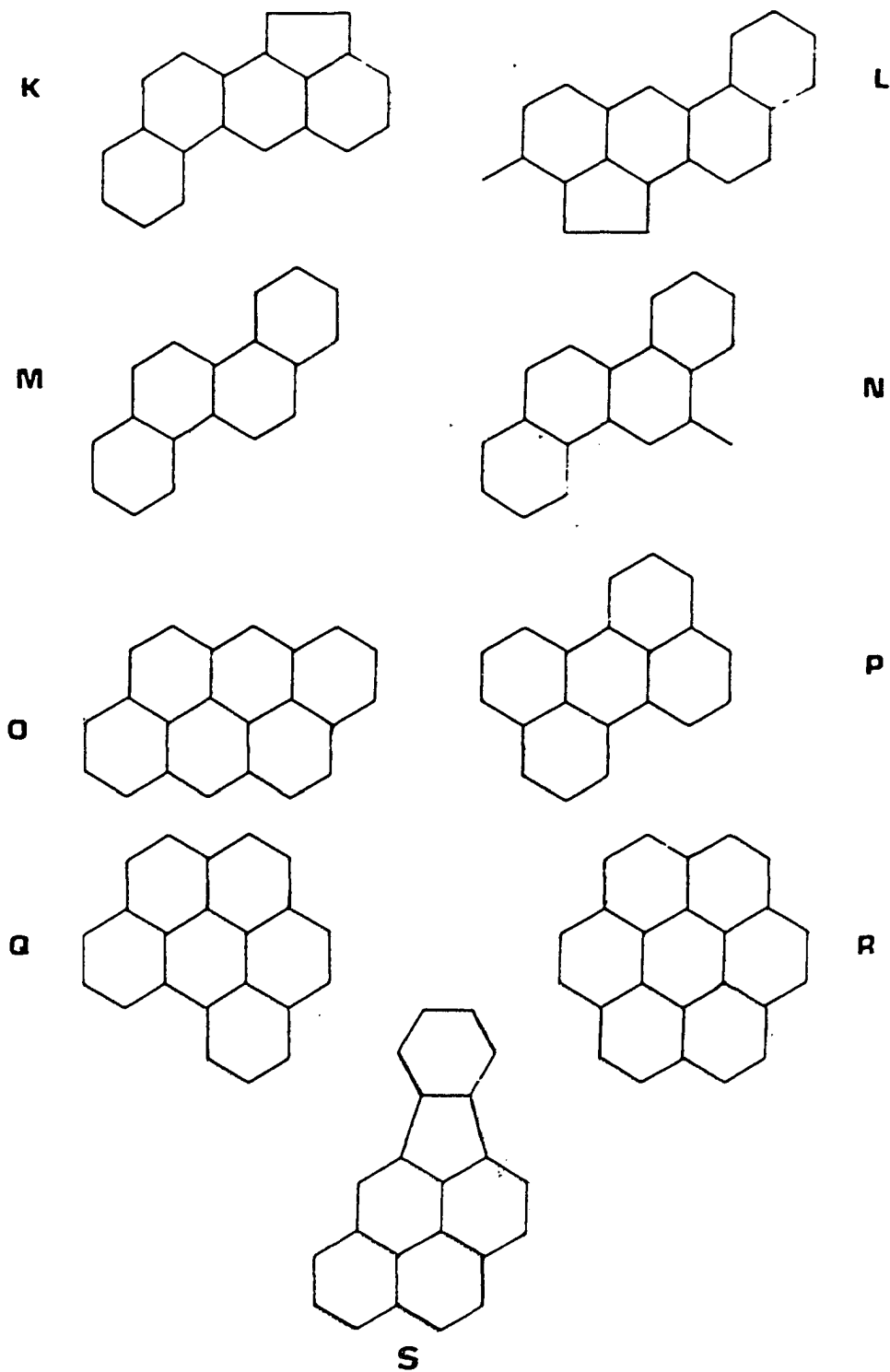

FIG. 12 *contd.* K, benz[*j*]aceanthrylene = cholanthrene; L, 3-methylcholanthrene; M, chrysene; N, 5-methylchrysene; O, dibenzo[*cd,jk*]pyrene = anthranthrene; P, perylene; Q, benzo[*ghi*]perylene; R, coronene; S, indeno[1,2,3-*cd*]pyrene. (Neff, 1979)

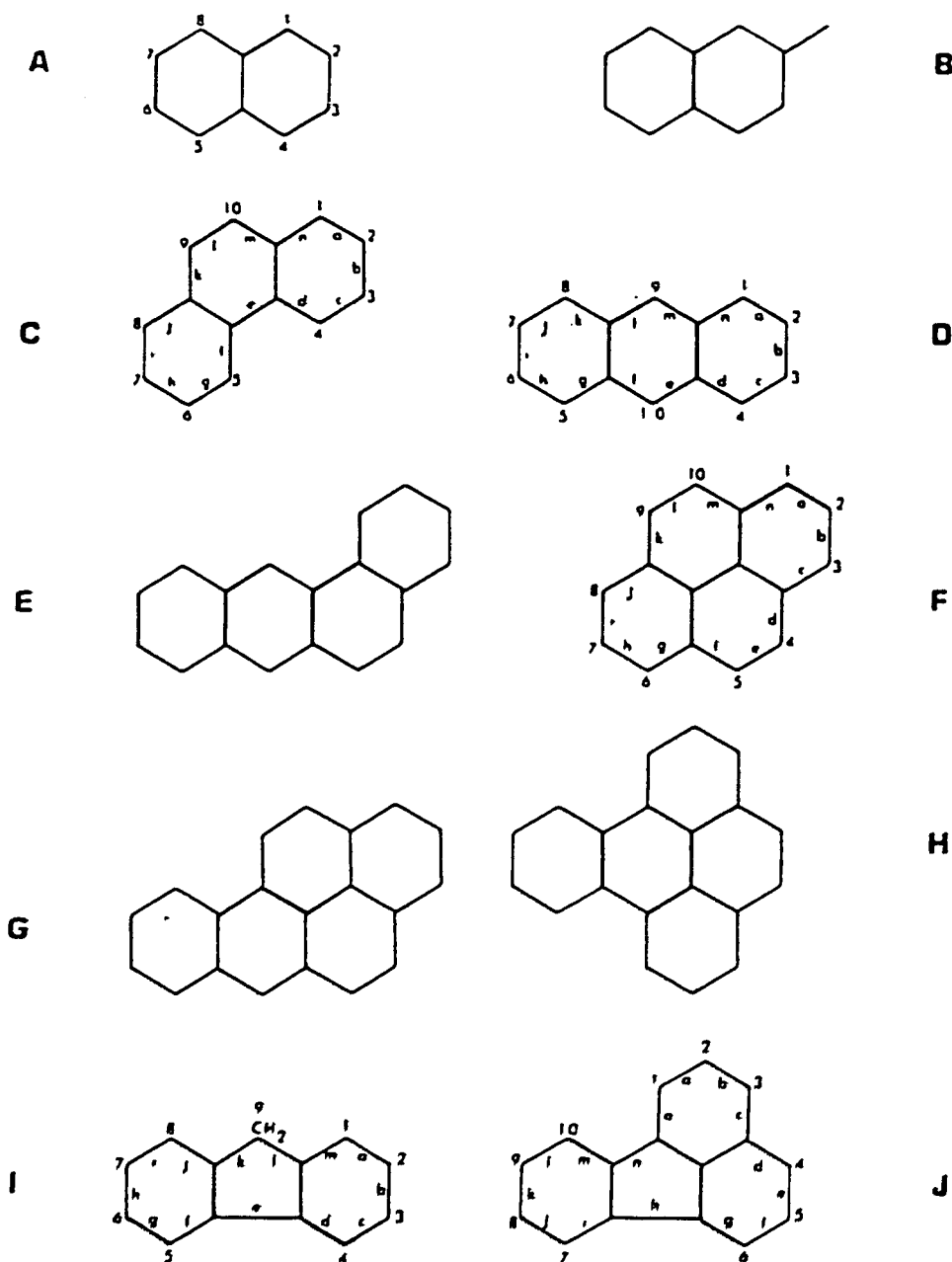

FIG. 1-2 Ring structures of representative polycyclic aromatic hydrocarbons. The numbering and lettering system for several PAH is also given. A, naphthalene; B, 2-methylnaphthalene; C, phenanthrene; D, anthracene; E, benz[*a*]anthracene; F, pyrene; G, benzo[*a*]pyrene; H, benzo[*e*]pyrene; I, fluorene; J, fluoranthene. (Neff, 1979)

carbons shared by two or more rings are not numbered. Ring faces, except the ones common to two rings, are lettered clockwise, i.e., a is between carbons one and two (fig. I-2).

### I-3.1 Sources of PAH in the aquatic environment

There are three main ways of PAH forming: high temperature pyrolysis of organic matter, low temperature diagenesis of sedimentary organic matter (fossil fuels) and direct biosynthesis by microbes and plants. There are various inputs of PAH from industrial activity in the environment, e.g., preparation of acetylene from natural gas, pyrolysis of kerosene into benzene and toluene, pyrolysis of wood (charcoal, wood tars), electrolytic aluminum with graphite electrodes, coke production, creosote from coal, synthetic alcohol production, oil refinery operations, incineration of industrial and domestic waste and operation of combustion engines. The majority of PAH in the environment come from incomplete combustion of organic matter at high temperatures. PAH reach the aquatic environment through sewage, runoff, airborne deposition and petroleum spillage.

Neff (1979) estimates the annual global PAH input to water as:  $2.7 \times 10^3$  tons from biosynthesis (subject to many errors);  $6.94 \times 10^6$  tons from fossil fuels (assuming that PAH are 2.8% of fuel oil);  $17 \times 10^4$  tons from petroleum spillage; 2,940 tons from land runoff. The other inputs, from

industrial and domestic sewage, plastics, smelting industries and atmospheric fallout, are unknown at the present.

### **I-3.2 Distribution of PAH in the aquatic environment**

Very high PAH concentrations are localized in coastal areas near terrestrial sources. They are more persistent in water than in air because water protects PAH from photooxidation. They are present in dilute solution in the water column, are accumulated by biota, and once trapped into or sorbed on sediments, may persist for long periods.

PAH are nonpolar and hydrophobic, and have very low solubility in water which decreases with increasing number of rings and molecular weight. An aromatic hydrocarbon may be solubilized by its incorporation into micelles, forming an aggregate of surface active molecules (surfactant), with an hydrophobic hydrocarbon chain and an ionizable hydrophilic group. A critical surfactant concentration sufficient to produce micelles must be reached before the PAH is appreciably solubilized. Another mechanism would be hydrotrophy, which is the association with another dissolved organic compound without colloid or micelle formation.

### **I-3.3 Degradation of PAH in the aquatic environment**

Most PAH transformations in water require oxygen, so they persist in oxygen-poor water and anoxic sediments. There are four principal mechanisms of PAH oxidation:

- 1) Photooxidation. The photon-induced oxidation of PAH by oxygen, ozone, .OH radicals and others. The most common reaction is the formation of endoperoxides, and then, by photolysis or pyrolysis, the formation of different products, as shown in figure I-3. In petroleum photooxidation, the resulting oxygenated products are generally more water soluble than the parent compound and quite toxic to marine organisms, some being mutagens and/or carcinogens (Neff, 1979).
- 2) Chemical oxidation. Water can be treated with ozone, chlorine or other oxidizing agents to diminish the PAH composition.
- 3) Metabolic degradation of PAH by aquatic bacteria and fungi. Some organisms can metabolize simple PAH to carbon dioxide and water and use this as energy source. Others perform cooxidation, that is, partially metabolize PAH into different oxygenated metabolites while utilizing oxidation of other organic compounds as main energy sources. Microbial oxidation requires oxygen, so will not happen in anoxic conditions.
- 4) Biotransformation of PAH by aquatic animals. This takes place through the hepatic microsomal MFO (mixed function oxygenase, cytochrome P-450).

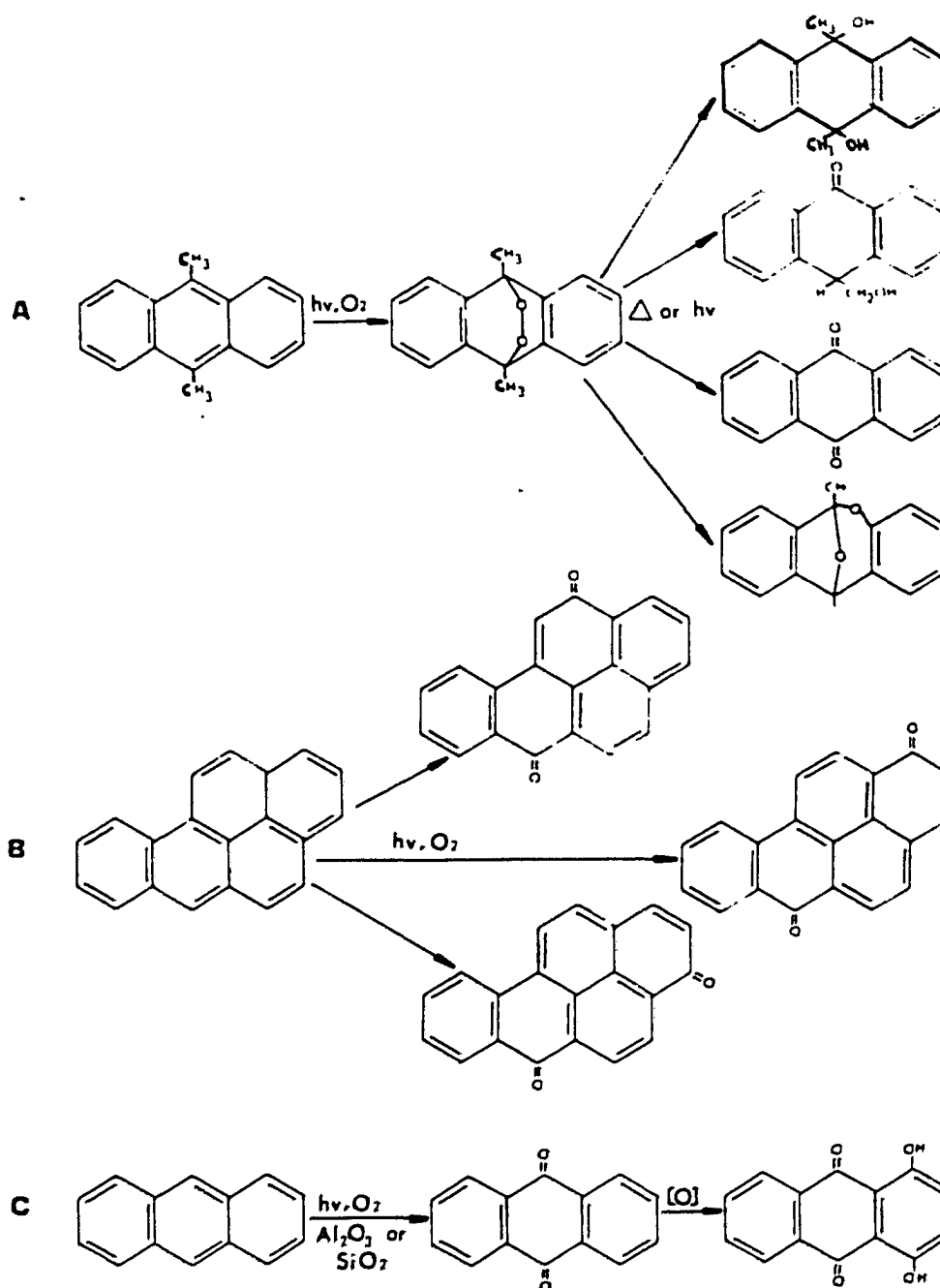

FIG. 1-3 Types of reactions proposed for the photooxidation of polycyclic aromatic hydrocarbons. A, Photooxidation of 9,10-dimethylanthracene through a 9,10-endoperoxide intermediate to yield several oxygenated products. B, Photooxidation of benzo[*a*]pyrene to the 6,12-, 1,6-, and 3,6-diones. C, Photooxidation of anthracene adsorbed to silica gel or alumina to 1,4-dihydroxy-9,10-anthraquinone (reproduced from *Particulate Polycyclic Organic Matter* (1972), pp. 67-9, with permission of the National Academy of Sciences, Washington, D.C.).



#### I-4 Atmospheric transport of PAH and their input to SSM

By 1881 the pollution of the Industrial Revolution had made obvious the anthropogenic effect on atmospheric chemistry (Mackay and Yuen, 1981). Since then, the amount of organics in the air has been increasing constantly on a logarithmic scale. Atmospheric transport is proposed to be a main route for PAH across the air-water interface in areas far from industrial and urbanized centers.

Semivolatile organic compounds (SOC), such as PAH with five rings or less, exist in the atmosphere both as gas and associated with airborne particulate matter. The vapor-to-particle concentration ratio for PAH has an important influence on their atmospheric removal by rain and dry deposition. Vapor scavenging for PAH in water is governed by Henry's law constant, the equilibrium ratio of vapor pressure to water solubility. Some lower molecular weight SOC, such as 2 to 4 ring PAH, are rained out as vapor dissolved in raindrops. Other SOC that have substantial fractions in the airborne particulate phase and Henry's law constants unfavorable for vapor scavenging are washed out of the atmosphere mainly on particles. PAH molecules with five or more rings are in this latter category (Bidleman et al., 1986).

It is likely that urban air contains some nonexchangeable PAH, bonded to highly active sites or trapped within the particles. This irreversible non-equilibrium adsorption may occur at low PAH concentrations, but once

sufficient PAH have become attached to the particles, additional PAH molecules may be adsorbed reversibly (Bidleman et al., 1986).

At low temperatures, slightly polar organic chemicals are more strongly sorbed to airborne particulate matter and are thus more susceptible to deposition as particles. There should be a dependence of the relative importance of particle born PAH deposition on latitude, climate and season (MacKay et al., 1986).

Airborne particles are highly enriched with anthropogenic matter such as PAH (Pitts et al., 1980). Chlorinated hydrocarbons and pesticides have been found in the atmosphere of remote oceanic areas (Risebrough, Huggett and Goldberg, 1978; Atlas and Giam, 1981). Hydrocarbons have been found in air samples over the Chesapeake Bay, and an annual flux of 275 tons to the Bay was estimated (Webber, 1983). Between 1-14% of these hydrocarbons were estimated to be PAH. This amount value depends on the degree of urbanization of the region considered. At some other urbanized areas, atmospheric deposition is estimated to contribute up to half of the total inputs of PAH into the SSM (Hardy, 1982).

Atmospheric inputs of PAH to surface waters must first enter the SSM. Organic vapors and airborne particles with their organic compounds concentrate in the surface film. Part of the PAH is solvent extracted by the organic SSM. For gas exchange between air and water, a two-layer model is often used. But, these layers' thicknesses vary both spatially and temporally, making such models unrealistic (Liss and Slater, 1974).

Transport in the vertical direction is governed by Fick's laws of molecular diffusion. Resistance to gas transfer depends on exchange constants in the gas or liquid phases and Henry's law constant for the gas concerned.

Evaporation and bubble ejection of PAH back into the atmosphere seem to be unimportant when compared to the input flux (Andren and Strand, 1981).

The transfer of PAH between air and water occurs through several processes: fallout of rain, snow, particulate matter; turbulent mass exchange in spray; molecular diffusion in the bulk phases. The flux carried by each path is characterized by the product of the rate of transfer of the PAH compound and its concentration in the transporting phase. Modifying effects of film material on transfer through the sea surface will vary depending on the mode of transfer, as well as the properties and amount of the interfacial material (Hunter and Liss, 1977). At equilibrium, the concentration of a compound in different phases depends on the Henry's law constant (H). If H value is larger than  $10^{-3}$ , PAH will go into the atmosphere, and volatilization is expected. If H value is less than  $10^{-5}$ , PAH will be expected to go into the water (Mackay and Yuen, 1981). The effects caused by the presence of SSM have not been studied. Air-sea transfer of low molecular weight organic gases is controlled by liquid phase resistance. Furthermore, it may be argued that, since the solubility of organic gases (both high and low molecular weight) should be considerably greater in sea surface organics than in clean seawater, the organic matter may tend to act as a new sink and so enhance the apparent air-sea transfer

of such gases as PAH measured by their disappearance from the vapor phase (Hunter and Liss, 1977). To assess the effect of sorption, gas stripping experiments should be done in the laboratory. Then, the ratio of mass-transfer rates measured in this way can be used to predict interfacial transfer rates in the environment (Atlas, Foster and Giam, 1982). The dominant transfer mechanism in the bulk phases for gases and small particles is turbulence, and the related measurable variables such as surface roughness, wind speed and atmospheric stability.

Bacteria, microalgae and invertebrates form communities that depend upon the organic composition and physical properties of the air/sea interface and, in turn, may affect the SSM chemistry by their metabolic activities. Research in transport by organisms is yet to be done, but neustonic communities have the potential to serve as important transfer sites, either increasing or decreasing the fluxes of elements or compounds between the atmosphere and the water column, depending on the mechanisms involved.

Atmospheric deposition can contribute a large proportion of the particulate matter to the SSM, especially if the particles contain sufficient organic matter for stabilization at the interface (Hardy, 1982). Solubilization of such particulates in the SSM organic "phase" will lead to rapid introduction of pollutants into the base of marine food chains through their bioaccumulation in microorganisms found in the SSM (Liss, 1975). The hydrophobic nature of slightly polar organics, such as PAH, leads to their

concentration in SSM by several orders of magnitude above that found in the water column or in the atmosphere (Table I-2). Although many of the enriched substances in the SSM are not surface-active, they may be associated with surfactants and thus reside in the SSM (Duce and Hoffman, 1976).

**TABLE I-2: Reported enrichment factors of slightly polar organic molecules  
in SSM at different locations**

Author(s)	Organics found in SSM and location
Seba & Corcoran (69)	DDT - 2,500 Florida
Duce et al. (72)	PCB and pesticides - 10(1)-10(3) Rhode Island
Marty & Saliot (76)	Hydrocarbons - 50 Mediterranean
Odham et al. (78)	organochlorines - 10(2)
Ofstad et al. (79)	PCB - 10(6)-10(7) Sweden
Strand & Andren (80)	PAH - 10(3) Lake Michigan
Riznyk et al. (87)	PAH - 10 Puget Sound
Hardy et al. (87)	values for Puget Sound's SSM: PAH = 132 ug/l; sat. hydrocarbons = 2,060 ug/l; pesticides = 0.46 ng/l; PCBs = 631 ng/l

## I-5 Previous studies relating to sea surface films in the Chesapeake Bay

The problem of sea surface pollution in the Chesapeake Bay has been summarized. Many organisms indigenous to the Chesapeake Bay utilize the SSM. Surface populations are often dominated by fish eggs and crab larvae. According to Grant (1979) "the surface layer is of critical importance to the shelf decapods and fishes during the principal reproductive season of late spring and early summer... Any widespread degradation of the surface layer during this annual peak in reproduction could have a serious effect on survival and recruitment of many commercially and trophically important species, including: Loligo and Illex, squids; Callinectes sapidus, bluecrab; Cancer spp., rock and Jonah crabs; Homarus americanus, american lobster; Geryon cuinquedens, deep sea red crab; Urophycis spp., hakes; Merluccius bilienaris, silver hake; Fomatomus saltatrix, bluefish; Coryphaena hippurus, dolphin; Mugil curema, mullet; Scomber scombrus, Atlantic mackarel; Sarda sarda, Atlantic bonito; Perprilus triacanthus, butterfish; Centropristis striata, black sea bass; Limanda ferruginea, yellowtail flounder, all of which, along with countless other species, utilize the surface layer of the middle Atlantic bight for development of the young."

Studies of SSM on the Chesapeake Bay region include:

- a) DDT, DDE, PCB, hydrocarbons and fatty acids were sampled and analyzed in the Chesapeake Bay in support of a research program to predict oil slick trajectories (MacIntyre et al. 1974).
- b) Gucinski (1986) studied TBT enrichment of the upper Bay's SSM.
- c) Hardy et al. (1987) sampled the upper Bay's SSM also and concluded that contamination is widespread and that it originates from a "variety of sources".

In summary, the SSM plays an important role in the distribution of natural and man-made chemical products. In the Chesapeake Bay, the SSM can be highly contaminated with different toxic chemicals. Hence, we should know pollutant levels in the SSM and their input routes to the food chain and ultimately to man.



## II- FIELD STUDIES: YORK RIVER SYSTEM AND PERRIN RIVER

### II-1 Sampling sites

During the first part of the field program (January to August, 1988) SSM was collected from locations on the York River, Sarah Creek, and Pumankey River shown in figures II-1 - II-3, respectively.

After a survey flight over the lower York River area was done in November 8, 1988, Perrin River was selected as an intensive air and SSM sampling location. The river, shown in figure II-4, is approximately 3/4 mile long and has four branches. At the entrance, there is a marina with approximately 120 recreational boats. Further in, there are eleven private piers for commercial fishing and recreational boats and twenty houses on the shoreline. The nearest point sources of atmospheric pollutants are the Virginia Power coal fired thermoelectric plant and the Amoco Oil Company oil refinery, located on the opposite side of the York River, near Wormley Creek. The land surrounding Perrin River is 25-30% agricultural and 50-60% forested.

The depth of the river was sufficient for use of the 26 foot surface film sampling vessel at all tide stages. Depth limitations excluded several other potential study sites (e.g. Wormley Creek) in the region.

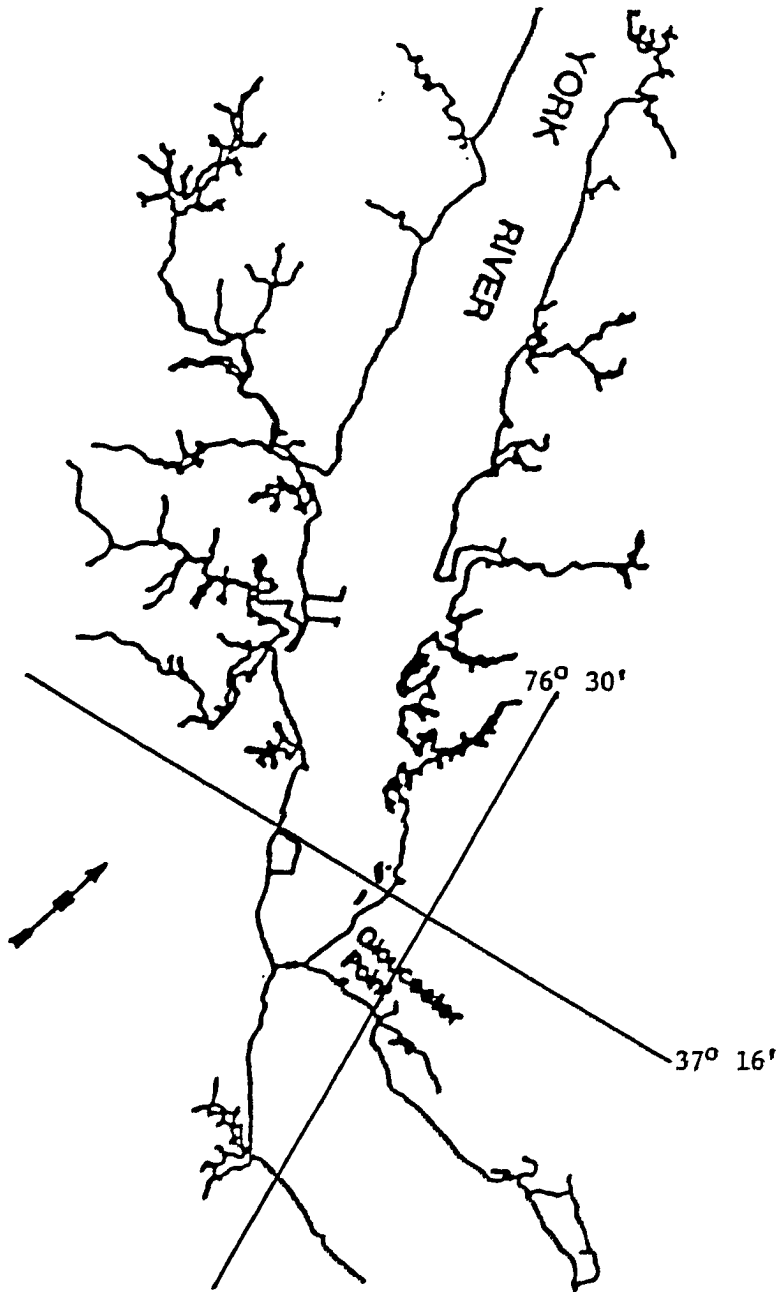

Figure II-1. Area of the York river where SSM sampling was performed.

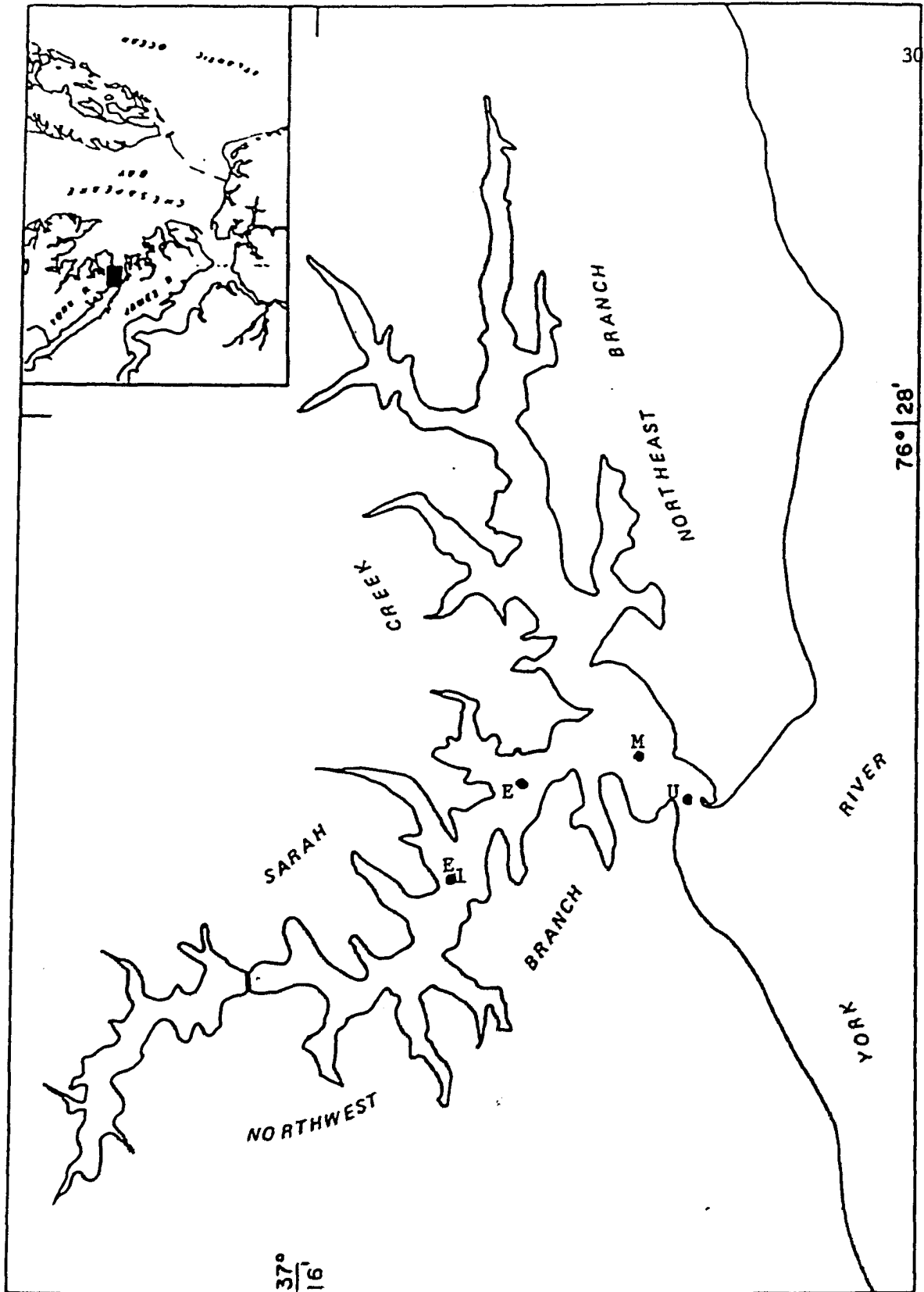

Figure II-2 Sampling stations, Sarah Creek

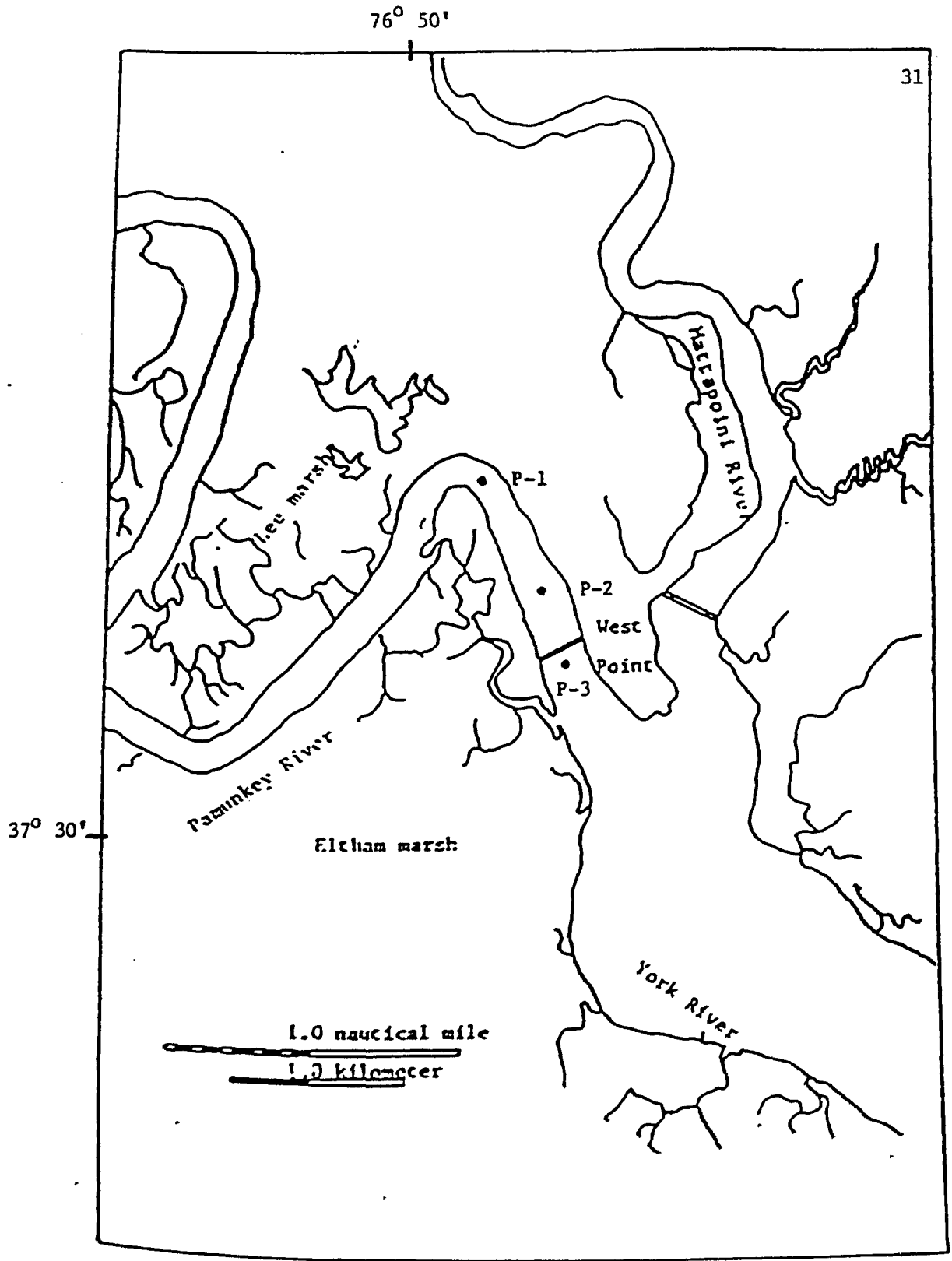

Figure II-3. Sampling sites on the Pamunkey River

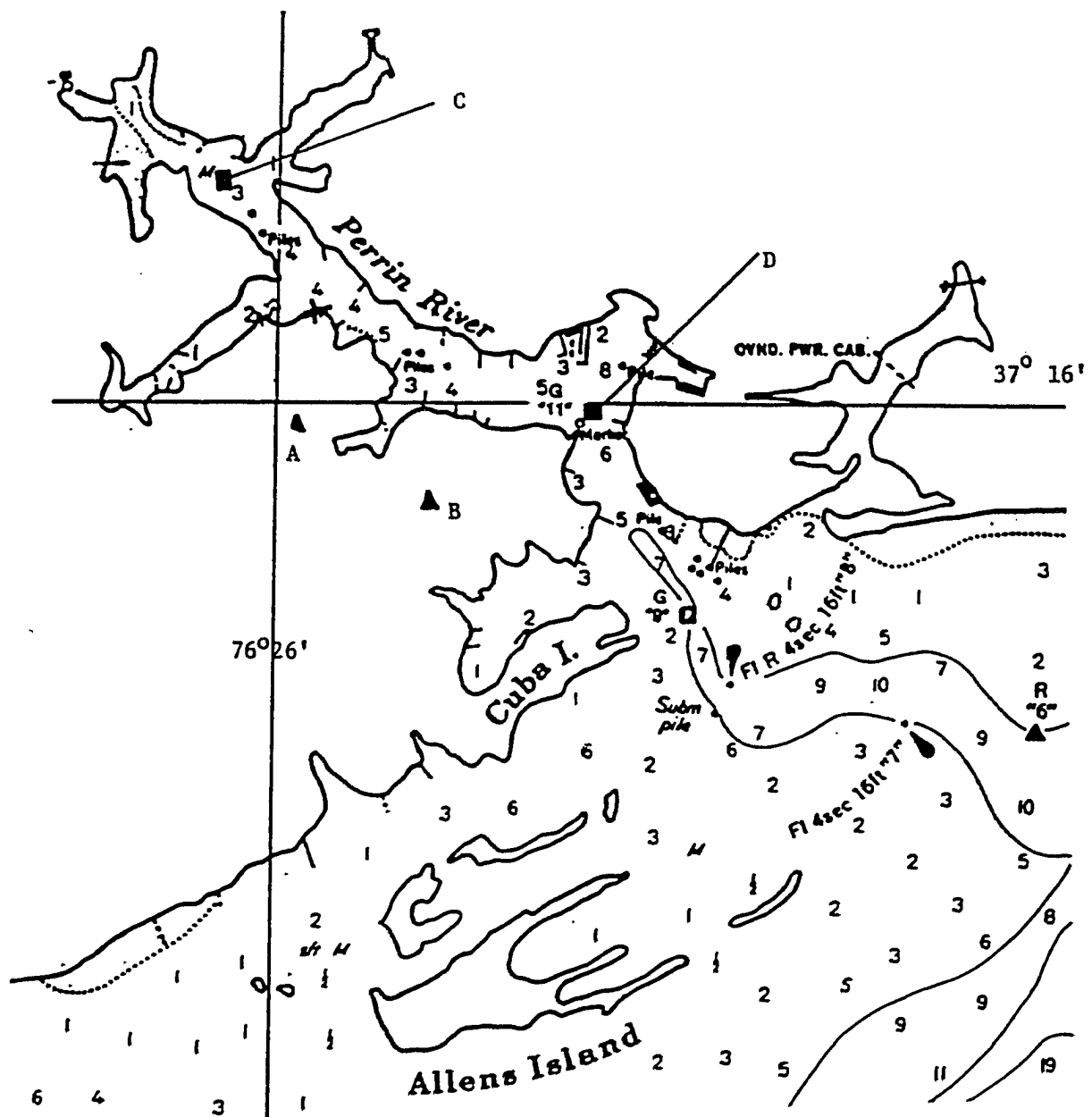

Figure II-4. Perrin river. Air samples were collected at stations between A and B. SSM samples, between C and D.

## II-2 SSM collector: design, construction and sampling operation

Since 1965, several different sampling devices have been used to collect SSM. Some are very simple, as Seba and Corcoran's (1969) bottle method (in Huhnerfuss, 1981); others are sophisticated and expensive, such as "Adam", the catamaran with screens used by Williams et al. (1986).

In selection of the sampling technique it is necessary to consider five characteristics pointed out by Garrett and Duce (1980): (1) it should be chemically inert to avoid sample contamination; (2) surface area and thickness sampled must be defined sufficiently to calculate the concentration and enrichment of film compounds; (3) the sampling efficiency must be known to obtain time concentration data; (4) the device should be simple to use, easy to clean, and portable in a relatively small boat; and (5) device operation should avoid contact with sub-surface water as much as possible, also the sampler material should not sorb the chemicals to be collected.

A screen was used in the first part of this program. Based on the works of Garrett (1965), Dumas et al. (1976), Van Vleet and Williams (1980) and Knap et al. (1986), a triangular aluminum frame of 85 cm each side, supporting a stainless steel screen of 16 mesh, 0.14 mm wire diameter with 60.2% open space was built. After three cruises, this method was

abandoned because of the large amount of subsurface water collected, along with the SSM.

A SSM skimmer was then developed by the author and built at the machine shop of the Physics Department, The College of William and Mary. The basic design is similar to the sampler used by Hardy (1984), with a different support frame, which allows floating devices movement used to adapt the sampler to different sea surface conditions. Furthermore, our sampler was used at least four feet ahead of the vessel's bow, never on the side. This design is optimal due to its collection efficiency of over 90% for organic chemicals in laboratory experiments.

The skimmer contains a 60.96 cm diameter and 45.72 cm long stainless steel drum coated with Teflon, suspended from a steel frame supported by four stainless steel floats. The skimmer is shown in figure II-5. The drum rests on the sea surface with a submergence depth of 5-8 cm and is rotated by an electric motor at a speed of 4.6 r.p.m.. Film sample collection from this skimmer is shown schematically in figure II-6.

Prior to each use, the SSM skimmer was washed with methylene chloride. Frame and drum were rinsed with deionized water. The drum surface was not touched with bare hands at any time during any cleaning, handling, or sampling operations. Care was taken to protect the teflon coating, so that it was not scratched and remained as smooth as possible.

Sampling was performed from the bow of a medium sized boat (26 ft) with the craft moving slowly with the tidal flow into the wind where possible. A

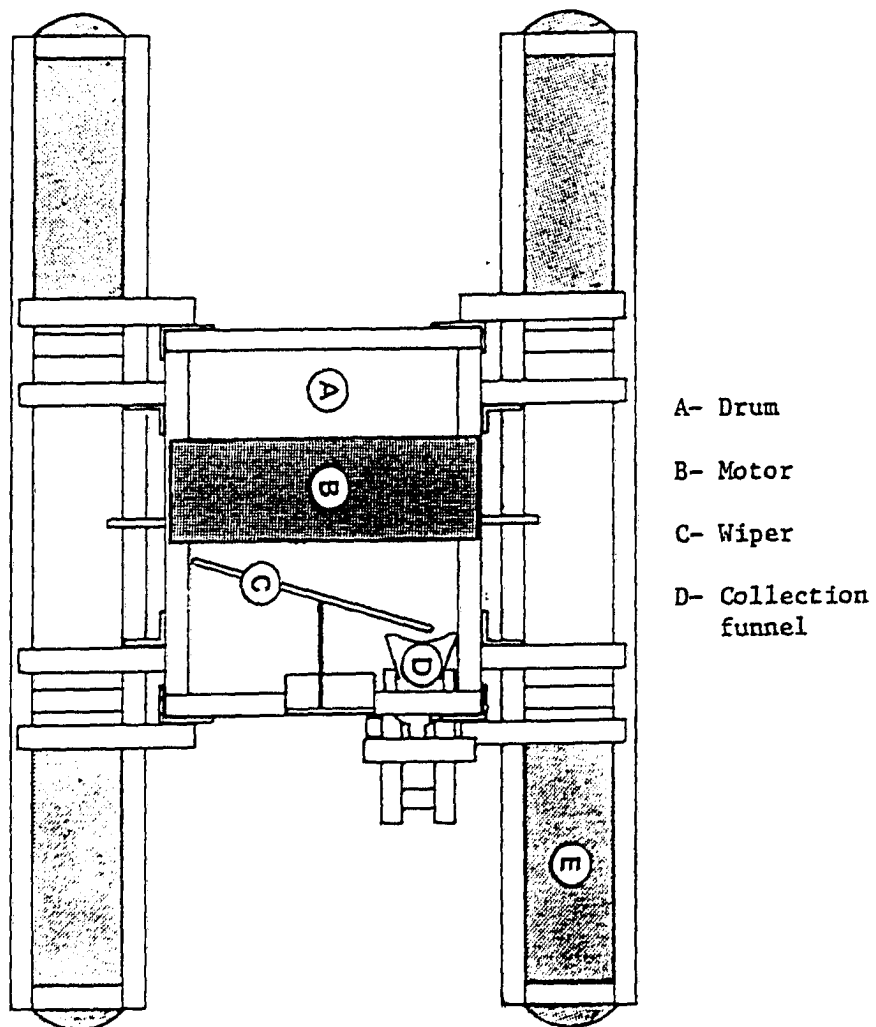

Figure II-5. Sea surface microlayer skimmer



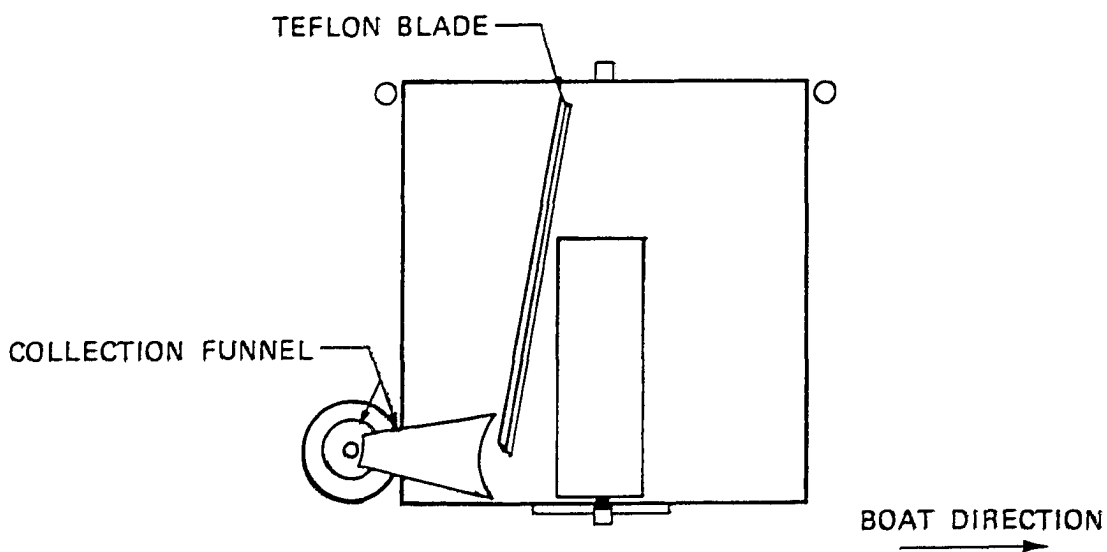
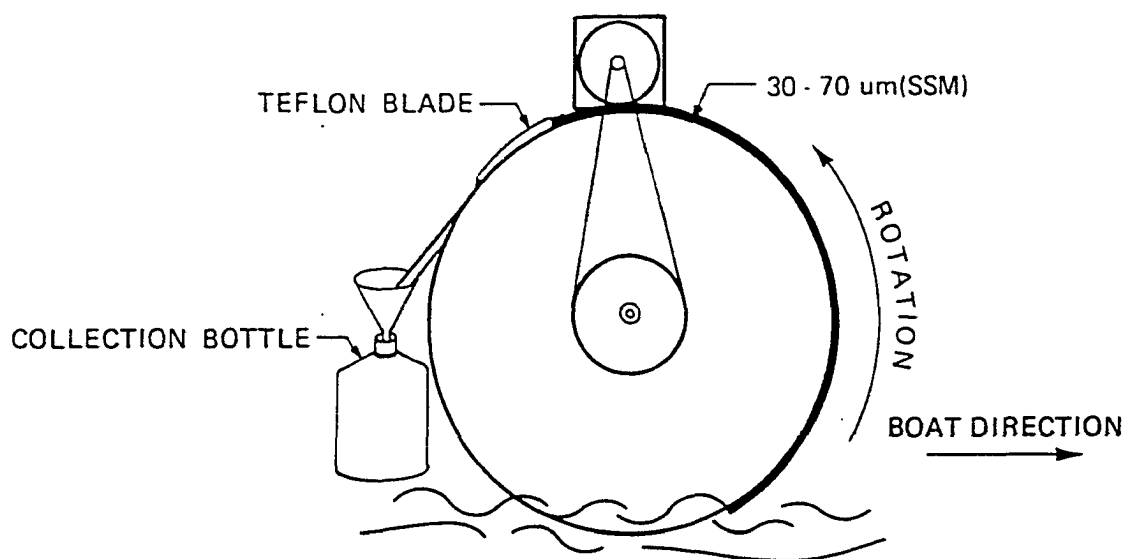

Figure II-6. Sea surface microlayer skimmer: lateral and top view.

sea anchor was used when necessary to adjust the boat velocity to the drum's optimal working conditions (fig. II-7). In this way, engines fueled with petroleum hydrocarbons did not contaminate the samples.

Before collection of a sample, the drum was allowed to skim the sea surface for several minutes to condition it to the chemicals in the water, effectively saturating surface sorption sites on the drum surface. This is an important step which improves the efficiency of the sampling process. A sample was then collected. The quantity of sample required and the size and composition of the collection container was determined by the pollutant being analyzed and the analytical methodologies employed. For example, a one liter sample was suitable for PAH studies.

For each SSM sample, the following data was recorded: date, time, location, tidal current, water salinity, water pH, wind speed and direction, air and water temperatures, sea surface conditions, sample time and sample volume.

The drum dimensions, rotational velocity, sampling time, and sample volume permit calculation of the apparent SSM thickness: 30-60  $\mu\text{m}$ , depending on the presence of slicked areas. Thickness of SSM collected by the rotating drum is given for a rotation speed of 4.61 r.p.m. by:

$$\text{Thickness (cm)} = \frac{V}{(\pi d l) \times (\text{rpm}) t} = \frac{\text{sample volume}}{\text{surface area}}$$

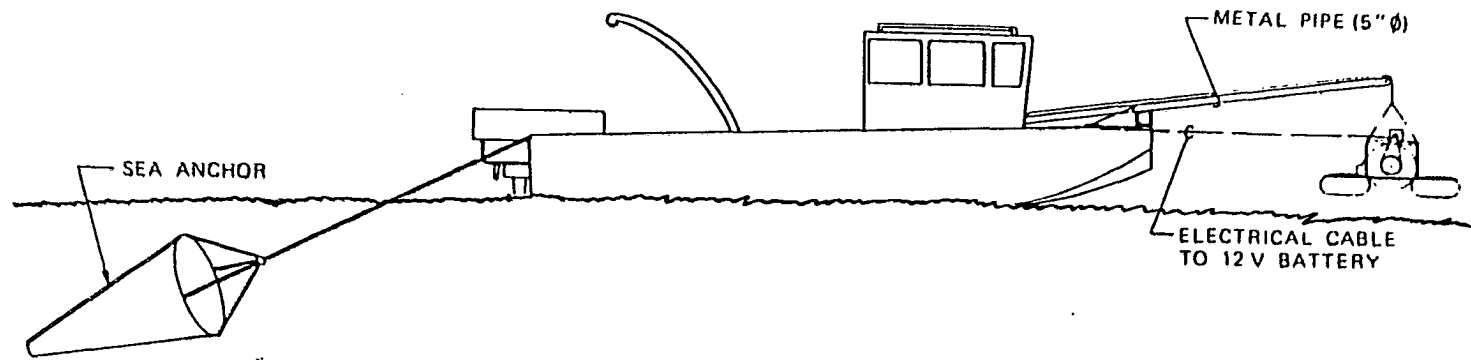

Figure II-7. Surface film sampling from the bow of a 26 ft. boat, using the drum skimmer.

where,  $V$  = volume collected in cubic cm

$d$  = drum diameter in cm = 60.96

$l$  = drum length in cm = 45.72

(rpm) = 4.61 revs. per minute

$t$  = sampling time in minutes

or, putting in these values,

$$\text{Thickness (cm)} = \frac{V}{4.04 \times 10^3 \times t}$$

Sampling was not conducted during or immediately after a rain because rainfall can remove organic surface films in minutes, or tenths of minutes, depending on raindrops size and the associated breaking of bubbles (Green and Houck, 1979; Wheeler, J.R., 1975).

Wind velocities were measured to determine if a correlation between wind and pollutant concentrations existed at low velocities. When winds are greater than 8 knots (4.1 m.sec<sup>-1</sup>), natural slicks are readily dispersed by air-sea dynamic forces. Under these conditions visible natural surface slicks will be rare, and visible films are usually due to pollution (UNESCO, 1985).

A thicker and more stable surface microlayer is probable during spring and summer, and a thinner and unstable one during fall and winter. The

reasons are: (1) the combination of strong winds, rain and low biological activity of the fall-winter period would make the microlayer unstable; (2) the higher biological activity during spring and summer produce more metabolic by-products to be incorporated into the microlayer. However, a thick natural slick would have a lower concentration of pollutants than a thinner one, assuming that the pollutant supply to the surface is constant throughout the year.

### II-3 Subsurface water samples collection

Samples of the water column were collected simultaneously with SSM sampling using the device shown in figure II-8.

An enrichment factor (EF) was calculated from :

$$EF = \text{conc. in the drum skimmer sample} / \text{conc. in sub-sfc. sample}$$

### II-4 Air collector

A high-volume air sampler after the design of T. Bidleman, Department of Chemistry, University of South Carolina, Columbia, South Carolina, (personnal communication) was used. An air pump was connected to the collector unit with approximately 3 m of flexible hose. The air collector is an aluminum cartridge with glass-fiber filters and two plugs of polyurethane foam, each 7.8 cm diameter and 7.5 cm thick. The inside diameter of the cartridge is slightly smaller than the plugs to give a snug fit and to avoid

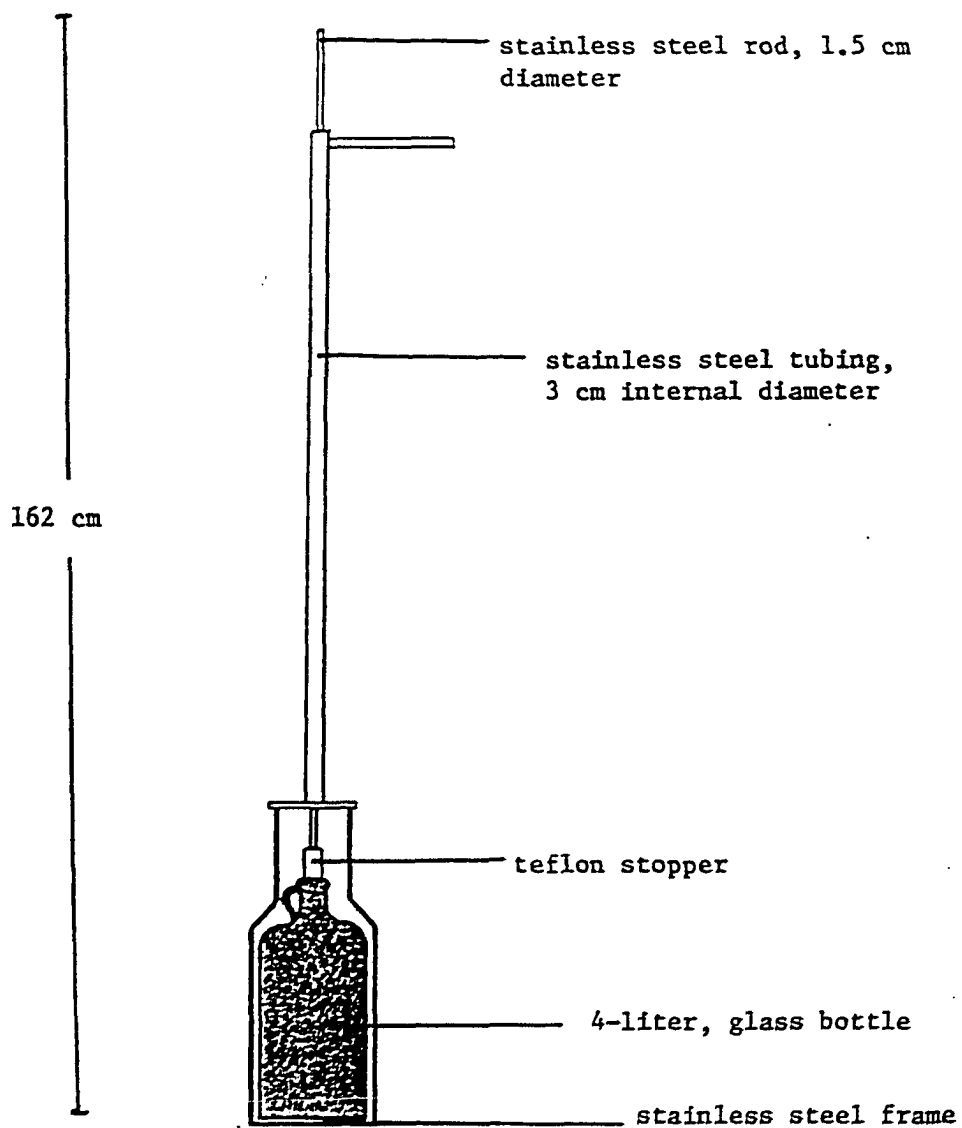

Figure II-8. Subsurface water collector device that is opened and closed below the surface film layer.

air "leaching" during sampling operations. The foam used is type 3014 (the last two numbers indicating a density of 1.4 pounds per cubic ft, equivalent to 0.022 g per cubic cm). The foam used for collection of "molecular" organic vapor, is sold for scientific purposes and does not contain any additives.

Double glass-fiber filters were used to collect particulate material. The filters were Gelman A/E 61635, 0.3  $\mu$ m pore size. The back filter was a blank to correct for adsorption to the filter matrix. Residues on backup filters average 10% or less of those on the particle-loaded filters (Foreman and Bidleman, 1987). Quantities on back filters were subtracted from those on front filters to provide the mass of particle associated organic compounds in each air sample.

The collection efficiency of the foam adsorbent bed depends on the volatility of the organic compound being sampled and the total volume of air pulled through the bed. Use of foam filters as an adsorbent has proven advantages due to ease of handling and ability of polyurethane foam to capture many different organic compounds. These properties have resulted in extensive use of this kind of collector for collecting airborne pollutants such as PCB, phthalate esters, polychlorinated naphthalenes and herbicides (Burdick and Bidleman, 1981).

The high-volume air sampling technique pulled air through a glass-fiber filter which retains particles followed by a foam adsorbent trap to collect vapors. The operational airborne contaminant volatile to particulate ratio

is the ratio of the foam-retained to filter-retained concentration, both expressed in ng per cubic meter.

From gas chromatographic theory, the retention volume of a solute at constant temperature is inversely proportional to its vapor pressure at that temperature. Air volumes were converted to 20°C volumes because a 5°C rise in temperature has nearly the same effect on sample penetration as doubling the air volume (Billings and Bidleman, 1983). Temperature is thus the most important factor to be considered in designing collection systems for organic vapors. Optimal sampling volumes ( $V_s$ ) were calculated for the compounds to be analyzed.

**Table II-1 Breakthrough volumes ( $V_b$ ) at 20°C for 4 PAH, and  $V_s$  corresponding to designated collection efficiencies. PUF of 7.6 cm diameter x 7.5 cm thick. (You and Bidleman, 1984, ES&T, 18:330-333)**

Compound	$V_b$ (cu.m)	$V_s$ at collection efficiency	
		90%	95%
Fluorene	120	100	77
Phenanthrene	200	660	500
Anthracene	1,100	920	690
Pyrene	10,000	8,200	6,200



From frontal chromatograms, You and Bidleman (1984) determined the number of theoretical plates (N) in the polyurethane adsorbent foam. For a 7.8 cm diameter and 7.5 cm thick PUF plug,  $N = 7.5$  and the breakthrough volume ( $V_b$ ) for this type of plug are given in table II-1. When  $V_b$  and N are known, the collection efficiency of the PUF bed at different air volumes can be predicted from fig. II-1. Also, this figure can be applied to predict the maximum air volume for a required collection efficiency. If we use in the field sampling two 7.8 x 7.5 cm plugs, the front plug has  $N = 7.5$ . From fig. II-10, when  $N = 7.5$  and the required collection efficiency is 95%,  $V_s/V_b$  0.62, or the maximum air volume should be no greater than 62% of  $V_b$  in order to guarantee that 95% of the vapor has been collected on the first plug of the sampling train (2 plugs). By use of the  $V_b$  values from table II-1, maximum safe  $V_s$  values were calculated for the 4 PAH at 90% ( $V_s/V_b = 0.82$ ) and 95% ( $V_s/V_b = 0.62$ ) collection efficiencies. From these data we conclude that phenanthrene, anthracene and pyrene will be quantitatively collected from approximately 700 cubic meters of air for temperatures not exceeding 20° C. For sampling PAH vapors at temperatures other than 20° C, air volumes can be calculated from published vapor pressure-temperature relationships.

Foam plugs were cleaned by soxhlet extraction with acetone and methylene chloride, and dried. Then, the plugs were stored in clean, teflon lined Mason jars.

The glass-fiber filters were baked at 400° C to remove contaminants and then stored in aluminum foil. Suspended particle concentration was obtained by weighing the dessicated filters before and after use.

Our hi-vol air sampler was assumed to pump 280 l/min, corresponding to the maximum pull on the air pump. Based on table II-1 and figure II-10, we could adjust the sampling time was adjusted to temperature conditions to obtain samples corresponding to 700 cubic meters (or 700,000 liters) at 20° C. At 20° C, the air sampling time was approximately 42 hours.

Field observations recorded for air sampling were: date; location; start time; stop time; temperature range; calculated air volume; before and after filter weights.

## II-5 Laboratory analysis

### II-5.1 SSM samples analysis (PAH)

The method for polycyclic aromatic hydrocarbons (PAH) analysis was based on Bieri et al. (1986). For dissolved PAH determinations, a 1 liter sample was transferred to a 2 liter separatory funnel. An internal standard of 1,1'-binaphthyl was added to the sample and the sample was extracted with 100 ml of methylene chloride by shaking vigorously for 3 minutes. The sample and solvent were allowed to separate and the solvent was drained and collected into a 500 ml flask. This procedure was repeated two times using

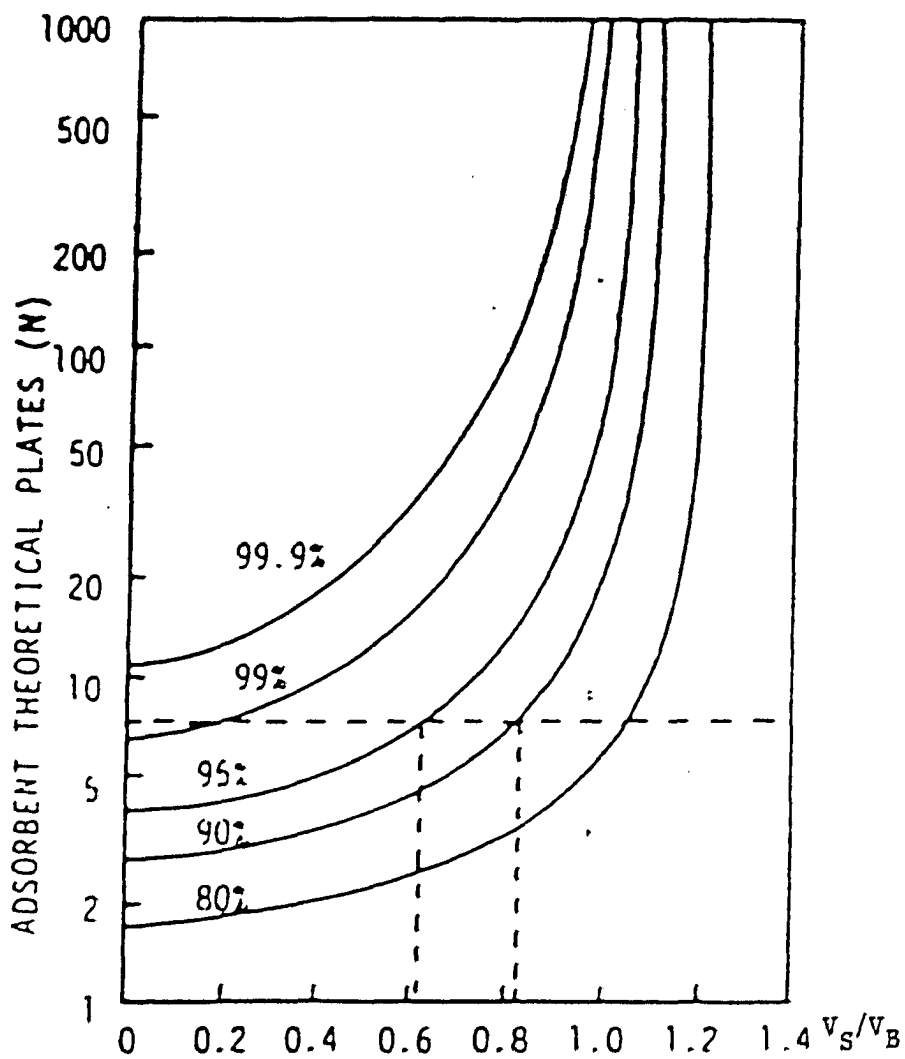

Figure II-10. Relationship between adsorbent  $N$ ,  $V_S/V_B$ , and collection efficiency. Dotted lines show maximum  $V_S/V_B$  values for 90% and 95% collection efficiencies using a PUF plug with  $N = 7.5$

(You and Bidleman, 1984, ES & T, 18:330-333)

50 ml of methylene chloride. The combined extracts were treated with anhydrous sodium sulfate to remove water from the methylene chloride and then reduced in volume by evaporation under a stream of ultrahigh purity nitrogen gas prior to analysis by gas chromatography.

Samples collected in slicks or foams were spiked with internal standards and extracted with methylene chloride. High concentrations of biogenic compounds occur in the foams, and necessitate a clean-up step to remove as many polar high molecular weight compounds as possible prior to gas chromatography analysis. Extracts of the foams and slicks were reduced in volume with a rotary evaporator and placed in a gel permeation chromatograph containing Biobeads S-X8 size exclusion resin. Methylene chloride was the elution solvent. Most biogenic molecules, which are generally larger than simple hydrocarbons, are unretained by the resin and elute before the molecules of interest (Bieri et al. 1986). Two fractions were collected. Aromatic hydrocarbons and many polar anthropogenic substances were eluted in the second fraction which was then separated into two subfractions of increasing polarity using columns packed with Biosil-A (200 mesh) topped with extracted sand. The first, non-polar, subfraction was eluted with hexane, after which methylene chloride was programmed into the solvent mixture. Twenty five percent methylene chloride in hexane was used to elute the aromatic fraction. Compound classes eluted in each fraction were:

Non-polar subfraction aliphatic (stored)

Slightly polar polynuclear aromatic hydrocarbons (PAH)

subfraction polychlorinated biphenyls (PCB)

DDT

DDD

DDE

mononitro-PNAs

The slightly polar subfraction was analyzed by capillary column gas chromatography with flame ionization detection. A Varian 3700 gas chromatograph was used with the following program: Initial temperature: 75 °C; linear program rate: 6 °C per minute; final temperature: 310 °C (for 3 minutes). Peak identification was done using the aromatic retention index system of Bieri et al. (1986). Selected marker peaks from each chromatogram were identified by visual comparison with standard runs the same day. Using these markers, computer programs written in the laboratory used the stored detector output data for the sample chromatogram to assign each peak an aromatic retention index (ARI). The ARI for peak x is calculated by the formula:

$$ARI(x) = \frac{T(x) - T(mp)}{T(mf) - T(mp)} \times 100 + ARI(mp)$$

$T(x)$  = retention time of peak  $x$

$T(mp)$  = retention time of the last marker preceeding peak  $x$

$T(mf)$  = retention time of the next marker following peak  $x$

ARI = ARI defined for the last marker preceeding  $x$  (ARI of the markers are defined as 000, 100, 200, 300, 400, 500, 600)

Using the calculated ARI, computer programs then identify peaks whose ARI's are known from previously injected standards and mass spectral identifications. Quantitation of these chromatograms were done using the internal standard added prior to extraction (1,1'-binaphthyl). This method corrects automatically for extraction efficiency variations and losses of material during the analytical procedure.

#### II-5.2 Tributyltin (TBT) analysis

Some samples of SSM and subsurface water were collected for tributyltin analysis. For this purpose the method of Unger, et al. (1986) was used. The analysis was performed with help from Ellen Travelstead, Department of Chemistry and Toxicology, Virginia Institute of Marine Science.

### II-5.3 Air samples analysis

Foam plugs were individually soxhlet extracted with methylene chloride for 24 hours. Glass-fiber filters were cut into strips and refluxed overnight in methylene chloride. The chlorinated solvent was then removed by refluxing with hexane. When analysis had to be delayed for 48 hours or less, the glass-fiber filters were wrapped in aluminum foil and stored at  $-10\text{° C}$ .

Extracts were cleaned, fractionated and analyzed by the same method used for the SSM methylene chloride extracts.

## II-6 Results

### II-6.1 York river system study

Table II-2 shows the sampling dates and locations sampled during the first part of the study and indicates whether or not the surface microlayer contained detectable levels of PAH. During the sixteen cruises conducted over 50% of the samples showed the microlayer to be enriched in PAH over the subsurface samples. In the York river concentrations of total PAH in the SSM did not exceeded 7 ug/l.

TABLE II-2

Occurrence of PAH in SSM samples from the York river system.

<u>Date (1988)</u>	<u>Location and No. of Stations</u>	<u>PAHs Detected in the Microlayer</u>
January 18	York River - 1 Station	No
January 18	Sarah Creek - 5 Stations	Yes
January 19	Pamunkey River - 6 Stations	Yes
February 15	Sarah Creek - 1 Station	Yes
February 25	York River - 3 Stations	Yes
March 4	York River - 2 Stations	No
March 20	York River - 1 Station	No
March 26	Sarah Creek - 1 Station	Yes
April 14	Sarah Creek - 1 Station	No
April 31	York River - 1 Station	Yes
May 6	York River - 1 Station	No
May 6	Sarah Creek - 1 Station	No
June 20	York River - 2 Stations	No
June 20	Sarah Creek - 1 Station	Yes
July 1	York River - 2 Stations	No
July 1	Sarah Creek - 2 Stations	Yes



Table II-3 shows the ranges of enrichment factors for total aromatics, i.e. the concentrations in the microlayer sample divided the concentration in the subsurface sample, observed during this part of the study.

The most abundant PAH detected in the January sampling of Sarah Creek are shown in Table II-4. Two samples were collected in slicks at station E and one in a slick at station M. There was no visible slick at station U. Concentrations of total aromatics in these samples ranged from 17 to 40 ug/l. Concentrations at station U, where no visible slick was apparent, exceeded those at station M. Methyl-phenylnaphthalene, C-2 phenanthrene, Benz(a,b)fluorene, retene, fluoranthene and methylphenanthrene were the most abundant compounds in the SSM.

Of the seven cruises conducted in Sarah Creek the July sampling showed the highest concentrations of PAH in the SSM (Table II-5). The concentration of total resolved aromatics in this sample was 135 ug/l. The most abundant compounds detected were C-2 phenanthrene, fluoranthene, 2-methylphenanthrene, methylphenanthrene, methylphenylnaphthalene and phenanthrene. Although concentrations were higher than in the January samples, the PAH composition of the SSM was similar.

Table II-6 presents the results of the January, 1988 SSM survey in the vicinity of the paper mill at West Point.

Station P-1S was located in a heavy slick about 0.5 miles above the paper mill, and taken on flood tide. Station P-1 was in the same location

TABLE II-3

PAH enrichment factors found in the York river system.

<u>Date (1988)</u>	<u>Location</u>	<u>Range of Enrichment Factor - Total Aromatics</u>
January 18	Sarah Creek	27 - 11
January 19	Pamunkey River	180 - 17
February 25	York River	<u>&lt;53</u> - <u>&lt;4</u>
March 26	Sarah Creek	<u>&lt;21</u>
April 31	York River	<u>&lt;43</u>
June 20	Sarah Creek	<u>&lt;200</u>
July 1	Sarah Creek	135

TABLE II-4

PAH found in Sarah creek's SSM in January. Concentrations are in ug/l.  
(dissolved and particulate)

PAH	Stations (see fig. II-2)			
	M	E	E <sub>1</sub>	U
Methyl-phenylnaphthalene	0.6	7.8	11.1	6.1
C2-Phenanthrene	2.8	4.2	3.6	2.7
Benzo(a)fluorene	3.3	5.6	3.4	0.7
Retene	1.5	7.3	2.8	1.2
Benzo(b)fluorene	2.1	5.0	3.7	1.4
Fluoranthene	2.3	4.0	5.0	1.8
Methylphenanthrene	0.6	1.4	4.1	3.8
Tetramethyloctahydrochrysene	—	1.2	4.7	1.7
Anthraquinone	0.6	1.0	1.1	0.8
Pyrene	2.4	—	—	—
Methyldibenzothiophene	—	0.5	1.9	0.1
Dibenzofuran	—	0.7	—	0.1
Benzo(a)pyrene	—	—	1.6	0.2
Total	16.6	39.6	39.9	22.2

— : not detected

TABLE II-5

PAH found at station U in Sarah creek's SSM in July. Concentrations are in ug/l. of total identified PAH (dissolved and particulate).

	Concentration
C2-Phenanthrene	18.1
Fluoranthene	17.9
2-Methylphenanthrene	15.9
Methylphenanthrene	11.0
Methylphenylnaphthalene	10.5
Phenanthrene	10.3
Methyldibenzothiophene	9.8
Benzo(a)fluorene	7.0
Methylfluorene	5.8
C-3 Naphthalene	5.3
Benzo(b)fluorene	3.7
Dibenzothiophene	4.6
Chrysene	3.1
Anthraquinone	2.7
Methyldibenzofuran	1.3
Fluorene	1.1
Total	134.6

TABLE II-6

PAH present in SSM samples collected at West Point in January.  
Concentrations are given in ug/l. (Particulate and dissolved phases)

	Station				
	P-1S	P-1	P-2S	P-2	P-3
Methylphenylnaphthalene	—	0.3	6.5	1.3	—
Fluoranthene	—	0.7	3.9	2.3	—
Benzo(a)fluorene	4.5	—	2.2	0.4	—
Retene	—	0.2	1.7	0.1	—
Benzo(b)fluorene	3.5	0.4	2.2	0.1	—
Benzo(a)fluoranthene	1.0	—	2.0	—	—
Benzo(ghi)fluoranthene	—	—	1.6	—	—
Phenanthrene	—	—	1.5	3.2	—
Dibenzofuran	0.5	—	1.4	0.1	—
Methylphenanthrene	2.0	—	1.4	0.7	—
Tetramethyloctahydrochrysene	4.1	—	1.2	0.7	—
Methyldibenzothiophene	2.1	—	1.2	0.3	—
Benzo(a)anthracene	1.6	—	1.2	—	—
3-Methylphenanthrene	1.5	—	1.0	—	—
C-2 Naphthalene	0.6	0.5	1.0	1.5	—
C-3 Naphthalene	17.0	—	0.5	1.5	18.9
Pyrene	—	—	—	—	—
Anthraquinone	—	2.2	—	—	—
C2-Phenanthrene	2.8	—	—	0.3	—
Perylene	.6	—	—	—	—
<b>Total</b>	<b>47.3</b>	<b>4.5</b>	<b>37.2</b>	<b>16.1</b>	<b>19.0</b>

-- : not detected

but outside the area of the visible slick. Station P-2S was located in mid-river near the plant outfall in a heavy slick, while station P-2 was adjacent in a much lighter slick. Station P-3 was located about a mile downriver from the mill in a light slick.

The concentration of total resolved aromatics in these SSM samples ranged from 4.5 to 47 ug/l. Concentrations at the upriver station were much higher in the slick than outside, and were also lower in the lighter slick near the plant outfall. At the most downstream station C-3 naphthalene accounted for nearly all the resolved aromatics in the SSM.

With the exception of C-3 naphthalene at stations P-1S and P-3, the compositions of these SSM samples is quite similar to those collected in Sarah Creek.

The results of TBT analysis on selected samples are shown in Table II-7. Enrichment factors ranged from 5 to 180 in samples from the York River and Sarah Creek. Concentrations of TBT in the SSM ranged from 120ng/l to a high of 2800ng/l. Concentrations of TBT in excess of 2 ug/l have been shown to be toxic to larvae of the blue mussel (Mytilus edulis) and produce abnormalities in the Pacific oyster (Crassostrea gigas). For the eastern oyster (Crassostrea virginica) 48 hr LC50 values of 1.3 ug/l and 4 ug/l have been reported for embryos and larvae, respectively. Similar toxicity of TBT has been observed for hard clams (Mercenaria mercenaria) (Roberts, et al. 1987).

TABLE II-7

TBT found in stations located on the York river system.

Sample	TBT (ng/l)	<u>Microlayer</u> subsurface H <sub>2</sub> O	Enrichment Factor
9/1/88 Sarah Creek	2,860	/ 16	179
6/20/88 Sarah Creek	211	/ 21	10
2-25-88 York	122	/ 24	5
5-31-88 York	146	/ <u>&lt;1</u>	<u>&lt;147</u>

Table II-8 shows enrichment factors for particulate carbon (PC) and particulate nitrogen (PN) for the York River system between January 1988 and March 1989.

The possibility that measured enrichments are low because of the limitations of sampling methods used is one which should be borne in mind. A number of authors (Liss, 1975; F. McIntyre, 1975) have discussed the possibility that enrichment factors observed with microlayer material, collected using any of the devices which take a slice of the surface of  $100 \pm 50$   $\mu\text{m}$ , are only minimum values. According to these authors, organic compounds at SSM really occur in either a monomolecular film (approximately  $2 \times 10^{-3}$   $\mu\text{m}$  thick) or in a layer one  $\mu\text{m}$  thick.

#### II-6.2 Perrin River study

SSM is a very fragile environment that is in constant change, and is thus a temporary sink of pollutants. For this reason, a new sampling approach was taken which involved sampling within short time intervals in a relatively clean, unpolluted area. This was done to establish time variability in the contents of the SSM temporary sink.

The location selected was the Perrin River, shown in figure II-4. SSM and air samples were taken concurrently at this location. On November 22nd and 23rd, 1988, the air sampler was set up next to Perrin River and sampled constantly for 42 hours. During that period, SSM samples were collected



TABLE II-8. Particulate carbon (PC) and nitrogen (PN) enrichment factors for SSM samples taken from the York River system

Date	n	PC	PN
January 1988	10	1.03 ± 0.10	NR
February 1988	3	1.11 ± 0.06	NR
March 1988	2	1.05 ± 0.03	NR
June 1988	2	5.54 ± 0.31	3.93 ± 0.22
August 1988	4	7.68 ± 0.30	3.27 ± 1.17
November 1988	7	0.13 ± 0.20	3.24 ± 2.10
December 1988	1	0.38	2.73
January 1989	8	1.28 ± 0.86	1.42 ± 1.08
March 1989	4	3.02 ± 0.44	2.10 ± 1.12

NR = not recorded

every three hours, from November 22nd at 0800 hours to November 23rd at 1530 hours.

SSM and water column samples were filtered through 0.45 micron filters. PAH may be sorbed on the filter material when water is filtered, but attempts to determine this possibility were unsuccessful. All the values reported are from the particulate fraction. The values of the aromatics in the dissolved fraction were below the detection limits. Detection limits ranged from 0.016 to 0.036 ng/g. The values reported here are total unresolved aromatics.

Table II-9 Total unresolved PAH in ng/g for the november 1988 sampling stations in Perrin river. (Particulate and dissolved phases)

SSM	Water column	Enrichment factor	SSM approx.thickness (um)
70.3	0.4	171.6	22.5
146.0	0.0	146.0	56.1
2.1	0.3	6.3	59.3
75.1	15.8	4.7	30.5
1.4	N.D.		50.2
0.9	0.1	8.5	59.9
0.1	0.0	2.7	66.0

The values obtained from the air sampler for that period of time:

Particulate phase: N.D. ng/m<sup>3</sup>

Vapor phase: 23.17 ng/m<sup>3</sup>

Table II-10 Percentage of total identified PAH in various ring classes  
for SSM and air samples in Perrin River.

November 1988 stations

Number of rings	Percentage of total identified PAH	
	SSM (n=12) diss.+ part.	Air vapor + part.
2	0.3	25.8
3	11.4	61.0
4	64.7	11.9
5	16.9	1.2
6	5.9	N.D.

Individual identified PAH values are not corrected for collection  
efficiency in calculating total identified PAH in air.

Table II-11 Most abundant species of PAH identified in the SSM, November, 1988 at stations in the Perrin River.

Number of rings	PAH
2	C2- Naphthalene
3	Anthracene
	4H-Cyclopenta (d,e,f) phenanthrene
	Methyldibenzothiophene
4	Methylphenylnaphthalene
	Flucranthene
	Benzo(a)fluorene
	Pyrene
5	Tetramethyloctahydrochrysene
	Trimethyltetrahydrochrysene
	Benzo(a,e)pyrene
6	Indeno (1,2,3,c,d)pyrene

The single most abundant PAH detected using the ARI system was methylphenylnaphthalene.

Table II-12 Principal PAH identified in air samples during november 1988  
on the Perrin River (vapor and particulate phases).

Number of rings	PAH
2	Dibenzofuran
	C2-Naphthalene
3	Fluorene
	Phenanthrene
	Anthracene
4	Fluoranthene
	Pyrene
5	Benzo(e)pyrene

Relative abundances were determined for identified PAH and were not corrected for collection efficiency.

In January 27, 1989, ten SSM samples were taken at Perrin River with 45 minute intervals, while the air sampler was concurrently run for 43 hours. This was an effort to see SSM variations at higher frequency and compare them to the high variability detected in sampling at three hours intervals during the November, 1988 sampling.

The observed variation in SSM composition may be caused by different chemical, physical and/or biological factors. In the case of PAH, photooxidation is very important. After five and ten hours exposures to natural light, laboratory experiments show significant degrees of photodegradation for eleven compounds (Table II-13, taken from Neff, 1979).

TABLE II-13  
 PHOTODEGRADATION OF PAH UNDER NATURAL LIGHT IN  
 MIXED ACETONE WATER OR CARBON TETRACHLORIDE  
 WATER SOLUTIONS. INITIAL QUANTITIES OF STARTING  
 MATERIALS ARE NORMALIZED TO 100mg, EXCEPT IN THE  
 MIXED 1-METHYLNAPHTHALENE HETEROAROMATIC TESTS  
 WHERE EQUIMOLAR QUANTITIES OF STARTING MATERIALS  
 WERE USED (FROM NAGATA AND KONDO, 1977, WITH  
 PERMISSION OF THE AMERICAN PETROLEUM INSTITUTE)

<i>Compound</i>	<i>Degree of photodegradation (mg compound remaining) at</i>	
	<i>5h</i>	<i>10h</i>
Anthracene	52.9	32.6
Phenanthrene	57.0	35.9
Benz[ <i>a</i> ]anthracene	45.5	0.0
Chrysene	96.0	94.0
Fluorene	94.3	91.9
Pyrene	94.6	89.1
Benzo[ <i>a</i> ]pyrene	93.6	90.5
Benzo[ <i>b</i> ]thiophene †	181.0	36.3
1-methylnaphthalene	0.0 <sup>a</sup>	0.0 <sup>a</sup>
Dibenzo[ <i>b</i> ]thiophene †	20.6	16.2
1-methylnaphthalene	40.1 <sup>a</sup>	0.0 <sup>a</sup>

<sup>a</sup> Quantity of naphthalene after photoirradiation.



Table II-14 Total unresolved PAH in ng/g from the January 1989 stations  
in the Perrin River (dissolved and particulate phases).

SSM	Water column	Enrichment factor	SSM thickness (um)
3.8	1.2	3.0	49.4
10.7		8.4	57.0
7.2		5.7	59.8
11.6		9.1	42.7
8.7		6.8	39.2
3.6		2.8	41.0
8.3		6.5	42.5

Enrichment factor was calculated from only one water column sample value.

The air samples values for that period:

Particulate phase: 0.2 ng/m<sup>3</sup>

Vapor phase: 216.0 ng/m<sup>3</sup>

Table II-15 Percentage of total identified PAH in various ring classes for  
SSM and air samples in Perrin River. January 1989, stations.  
(Dissolved and particulate phases)

Number of rings	Percentage	
	SSM (n=8)	Air
2	63.1	50.4
3	22.0	42.2
4	12.2	7.2
5	2.7	0.2

Individual identified PAH values are not corrected for collection efficiency in calculating total identified PAH in air.

Table II-16 Most abundant species of PAH identified in the SSM samples ,  
January, 1989 at stations in the Perrin River.

Number of rings	PAH
2	C2-Naphthalene
	C3-Naphthalene
3	Fluorene
	Methyldibenzofuran
	Dibenzofuran
4	Fluoranthene
	Pyrene
5	Benzo(a)pyrene

The most abundant compound identified was naphthalene.

Table II-17 Principal PAH identified in air samples during January  
1989 station (Vapor and particulate phases).

Number of rings	PAH
2	C3-Naphthalene
	C2-Naphthalene
3	Methyldibenzothiophene
	Methylphenanthrene
	Fluorene
4	Fluoranthene
	Methyl-phenylnaphthalene

The single most abundant PAH was C3-naphthalene.

Again, in January samples, 99.8% of the atmospheric PAH were in the vapor phase, only 0.2% in the particulate form. For both, SSM and air samples, over 90% of the identified PAH had 2 or 3 aromatic rings.

#### II-7 Discussion of field work

The field work was designed in terms of answering questions regarding airborne PAH transport to surface waters, and how the presence of SSM affects it. This work is an original contribution to air-water transport studies since no similar work has ever been published.

Lately, there has been a lot of concern about the greenhouse effect of gases, principally carbon dioxide, in the atmosphere in environmental and oceanographic studies. Some authors estimate an increase in global temperature of 4-6 degrees centigrades in the next 100 years. Some others disagree based on data collected during the last 10-15 years, and they predict warming of no more than 1 or 2 degrees. In these types of processes, SSM and air input to water play a major role. If SSM is present, uptake of gases from atmospheric sources is different than if no SSM is present, and eventually would play a major role in allowing oceanic waters to be a buffer system in the carbon global cycle.

Even though errors were introduced during sampling the SSM, water and air, very clear trends were established, which are pointed out in the summary of observations and conclusions (IV and V).

SSM time variability is a very important fact that should be studied very carefully, taking into consideration factors such as season, wind conditions, water quality and biology of the surface water (neuston), among others. There is a lot of field work to be done that would benefit marine scientists, meteorologists, biologists and remote sensing researchers.

The sampler used for the present research worked as well as it was expected. In laboratory experiments it showed collection of surface films efficiency of 90% or better. When compared to other samplers that are in use today in different institutions and universities, our skimmer performed in a comparable way, and many times it was more reliable and efficient. The sampling procedure was always limited in the accuracy of SSM thickness calculation. This was due to changes in water velocity with respect to the boat's and the drum's rotational velocity, changes of SSM thickness in the area sampled, and the amount of subsurface water collected.

This dissertation aims to open some doors for future research. The idea of using a sampler that moves vertically, instead of transversally, to the boat direction, and open in both ends, would avoid some of the wind and choppy water problems, and the accumulation of SSM on the leading end of the sampler. Studies of the physical changes and properties of SSM would help meteorological and satellite information gathering. Better knowledge of the

chemistry of the SSM would help to understand in more detail the atmospheric input of pollutants to surface waters and also it could give an estimate of expected survival rate of eggs, larvae and juvenile populations that inhabitate this microenvironment.

Compounds found in the SSM during this study are proven to be toxic, and in some cases very toxic, to aquatic life. If similar studies are continued, correlations could be made between the presence of different chemicals in the SSM, survival rates of some species and the effect on humans from a social and economical point of view.

### III TRANSPORT OF PAH (NAPHTHALENE) FROM THE VAPOR PHASE TO WATER UNDER LABORATORY CONDITIONS.

In all the air sampling stations during our field work it was found that atmospheric PAH were present mainly in vapor phase (>90%). If atmospheric transport provides a significant input of these compounds to the aquatic environment, the presence of an organic film (SSM) may play an important role in regulating the mechanism and kinetics of the process. To test this, a set of laboratory experiments was conducted, in which naphthalene vapor transport to water was measured in the presence and absence of sea surface microlayer.

#### III-1. Materials and methods

The experiment set up is shown in figure III-1. A naphthalene saturation column was built. It consisted of a 20 cm stainless steel tube of 5 mm internal diameter, packed with glass beads, of 1.5 mm diameter, coated with naphthalene (99.95 % grade). The beads were placed into a beaker containing a solution of naphthalene in hexane, placed under a fume hood until all solvent was evaporated.

Ultra high purity nitrogen was blown through the saturation column. A gas regulator and a needle valve (all stainless steel) were used to regulate the gas flow at slow rates (0.25-0.30 ml/sec) necessary to saturate the column effluent with naphthalene.

A special flask was designed for this transport study and built at the



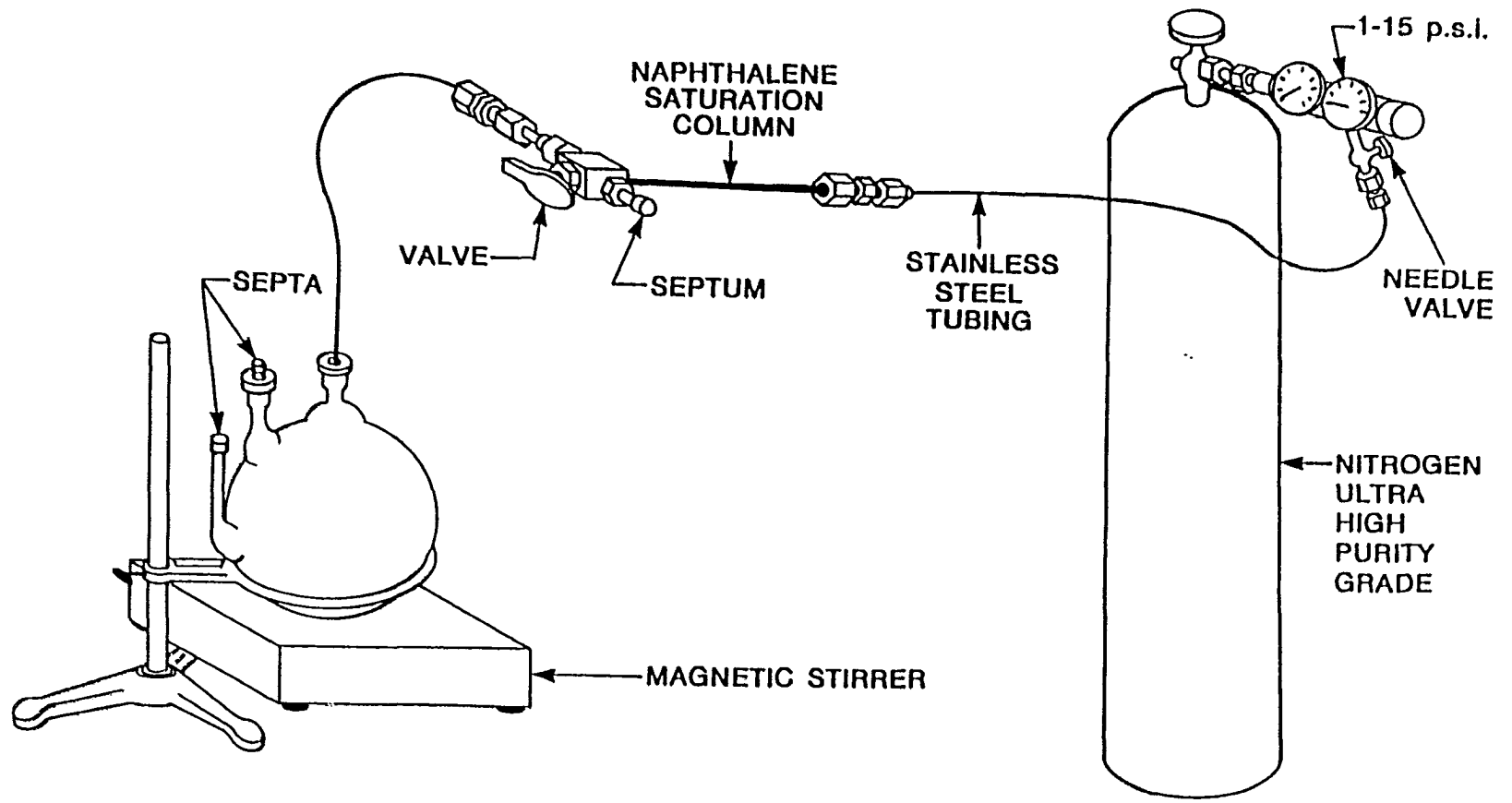

Figure III-1. Apparatus for measurement of of naphthalene transport between vapor and water.

Department of Chemistry, Virginia Commonwealth University, Richmond. A 1,000 ml. spherical flask was constructed with three openings: two on the top and one on the bottom. The center opening on the top, the naphthalene intake, the other was provided with a septum through which air was collected with an air tight syringe. The opening on the bottom was also filled with a septum, and was used for sampling water without disturbing the air-water interface. A 1.47 cm long glass-coated magnet bar was used to stir, very gently, the liquid inside the flask. It was rotated at 5-10 r.p.m. by a magnetic stirrer.

A stainless steel three way valve, between the saturation column and the flask, permitted sampling of the incoming gas at regular intervals (30 minutes). Gas samples were taken through a silicone rubber septum on the valve port using a gas tight chromatographic syringe. All connections were built with stainless steel tubing (1.2 mm internal diameter), nuts and ferrules.

Experiments were started by introduction of naphthalene saturated nitrogen into the flask. Samples of the water and the vapor inside the flask were then taken at later times to permit observation of gas to water transport. For the gas sampling, a 1 ml volume was collected with a gas tight syringe and immediately injected into a septum sealed, 20 ml glass vial, containing 10 ml of hexane, and shaken. After a period of 2-3 hours, the vial was opened and the extract transferred into a 50 ml graduated tube. The vials were rinsed 3 times with hexane, leaving samples of approximately 20 ml each. The efficiency of this procedure was 90% or better.

Water samples were drawn with a glass syringe. A 10 ml sample was transferred into a 60 ml separatory funnel and 3 ml of hexane added. The sample was shaken for three minutes and transferred to a 50 ml graduated tube. This procedure was repeated three times, so a 9 ml cumulative extract was obtained from each sample.

The hexane extracts of gas and water samples were blown down to 0.1 ml under a stream of nitrogen at 40o C and 1 ul injected into a gas chromatograph. The gas chromatograph used was a Varian 3700 with a capillary column, isothermically at 100 o C, with a flame ionization detector. An analysis program of six minutes duration was created, based on naphthalene retention time at that temperature. Peak identification and quantification was based on standard runs. Standards were run alternately with samples and the gas chromatograph was baked out at 300o C as necessary to maintain instrument response to standards. Some 0.1 ml concentrates were found to need dilution prior to injection, and were diluted to a volume of one ml prior to chromatography. A correction for this dilution was included in latter calculations.

### III-2. Experiments and results

Six transport experiments were performed and duplicated. In each experiment, 800 ml of liquid (high purity water, York River water, sea surface microlayer, and water with SSM) were placed into a flask. The total volume of the flask was 1,095 ml. Gas was allowed to flow into the system for seventeen minutes to fill the dead space (295 ml) prior to initiation of gas and water sampling.

### III-2.1. Experiment with high purity water

Gas flow: 0.25 ml/sec.

Naphthalene concentration in gas:  $1.58 \pm 0.12$  ug/ml (n=8)

Naphthalene input to the system: 23.40 ug/min.

time (min.)	total naphthalene		fraction of total input
	added (ug)	total naph. in water (ug)	
60	1404	$1.09 \times 800 = 872$	62.1%
120	2808	$1.61 \times 790 = 1272$	45.3%
180	4212	$3.25 \times 780 = 2535$	60.2%

The total volume of water in the flask was reduced by 10 ml after each sample was taken. This was included when calculation of the total amount of naphthalene in water.

Figure III-2 indicates a linear relation ( $r = 0.956$ ) between increasing amounts of naphthalene in air and in water, but this is based on only three points.

Figure III-3 indicates that the percentage of total naphthalene that is actually dissolving in the water is approximately constant (45-60%), over a period of three hours.

### FIGURE III 2 HIGH PURITY WATER

Naphthalene dissolved in water

80

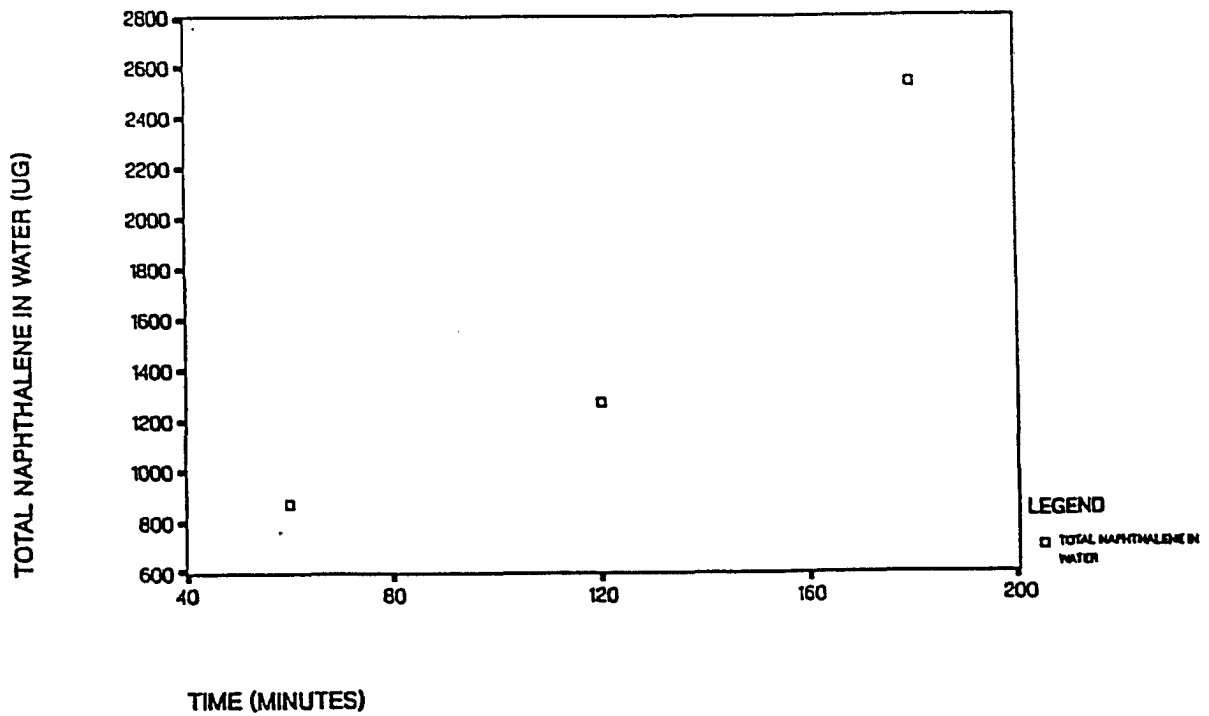

### FIGURE III 4 HIGH PURITY WATER

Ibid. III 2

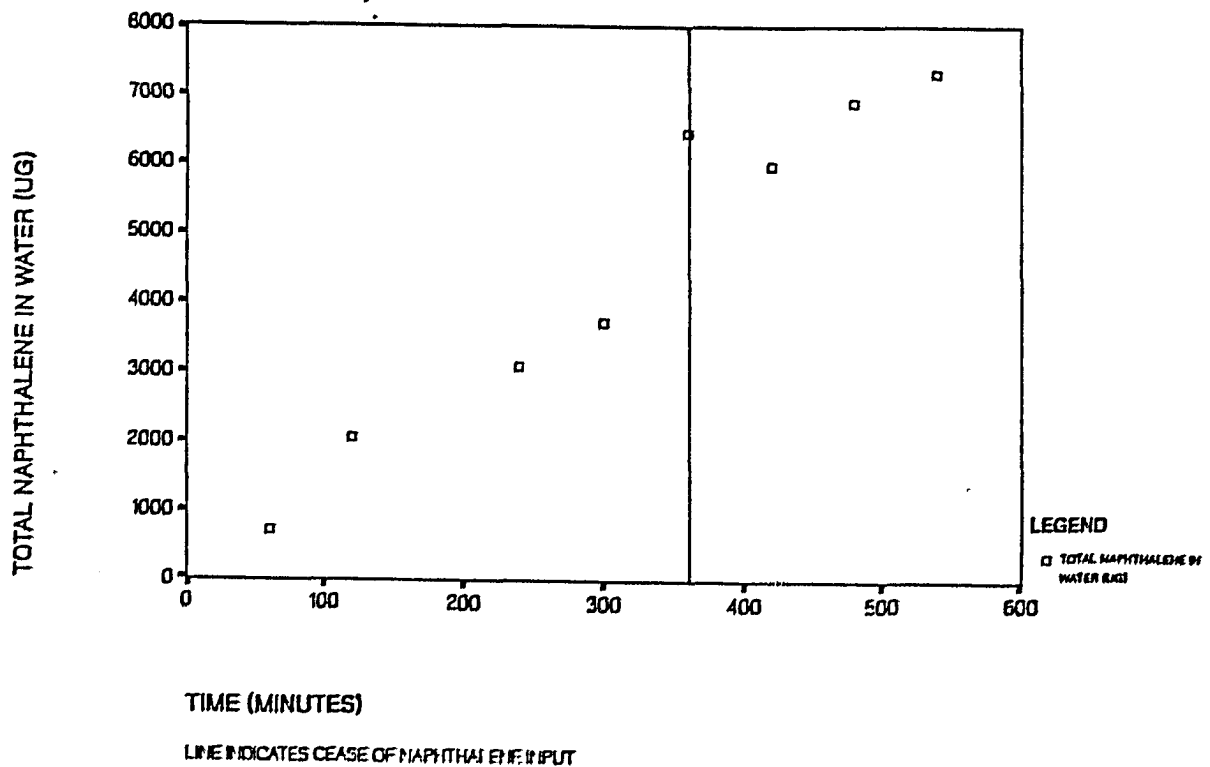

LINE INDICATES CEASE OF NAPHTHALENE INPUT

### III-2.2. Experiment with high purity water, part 2

In this experiment, the concentration of naphthalene was measured in the water and in the air inside the flask.

Gas flow: 0.29 ml/sec.

Concentration of naphthalene in the incoming gas:  $1.95 \pm 0.18$  ug/ml (n=8)

Total naphthalene added: 33.6 ug/min.

time (min)	total naph. added (ug)	total naph. in water (ug) and percentage of tot.input	total naph. in air (ug) and perc. of total input
		conc.x vol.	conc.x vol.
60	2016	0.90x800 = 720 35.7%	4.1x295 = 1209.5 60.0%
120	4032	2.60x790 = 2054 50.9%	4.0x305 = 1220.0 30.3%
180	6084	lost	8.3x315 = 2614.5 43.8%
240	8064	4.01x770 = 3080 38.3%	lost
300	10080	4.90x760 = 3724 37.0%	5.4x335 = 1809.0 18.0%
360	12096	8.60x750 = 6450 53.2%	6.0x345 = 2070.0 17.1%

Figure III-4 implies an increasing concentration in the water with time. Figure III-5 shows an increase in naphthalene in the air sampled from inside the flask up to 180 minutes (3 hours). After that, it decreases considerably. We must note that the scales used in these two graphs are different. When the total amount in water at 60 and 120 minutes are 720 ug and 2,054 ug respectively, the total amounts in the air are 1,209 ug and 1,220 ug for these times.

There is no trend in the percentage of naphthalene that is actually dissolving into the water. It is approximately constant, between 35 and 50%, in the interval from 60 to 360 minutes (figure III-6).

#### Experiment with high purity water, part 3

After six hours (360 minutes), the naphthalene input was suspended by shutting off the valve coming from the naphthalene column, all the other conditions remained the same. Air and water samples were taken at 420, 480 and 540 minutes, and the total concentrations of naphthalene in each phase calculated (figures III-4 and III-5).

time (min)	total naph. in water (ug)		total naph. in air (ug)	
	and perc. of total naph. at 360 min. to given time		and perc. of total naph. at 360 min. to given time	
420	$8.08 \times 740 = 5985.0$	92.8%	$3.7 \times 355 = 1311.0$	63.3%
480	$9.46 \times 730 = 6907.5$	107.1%	$2.0 \times 365 = 724.5$	35.0%
540	$10.18 \times 720 = 7327.5$	113.6%	$0.4 \times 375 = 138.0$	6.6%

### FIGURE III 5 HIGH PURITY WATER

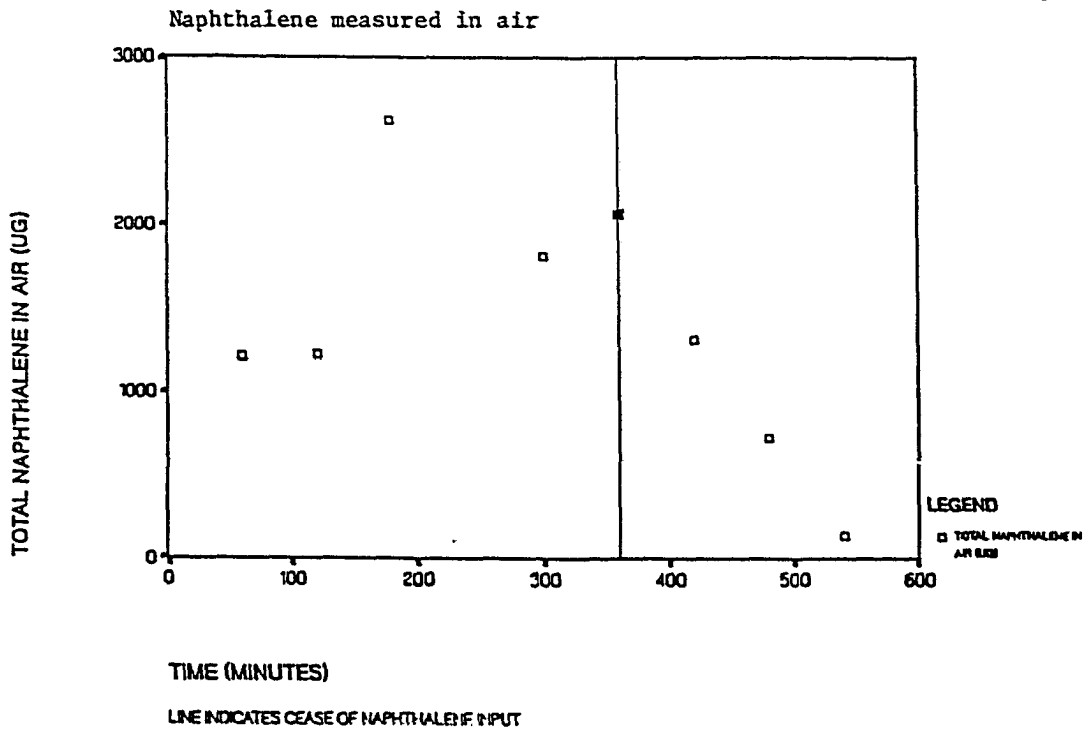

### FIGURE III 6 HIGH PURITY WATER

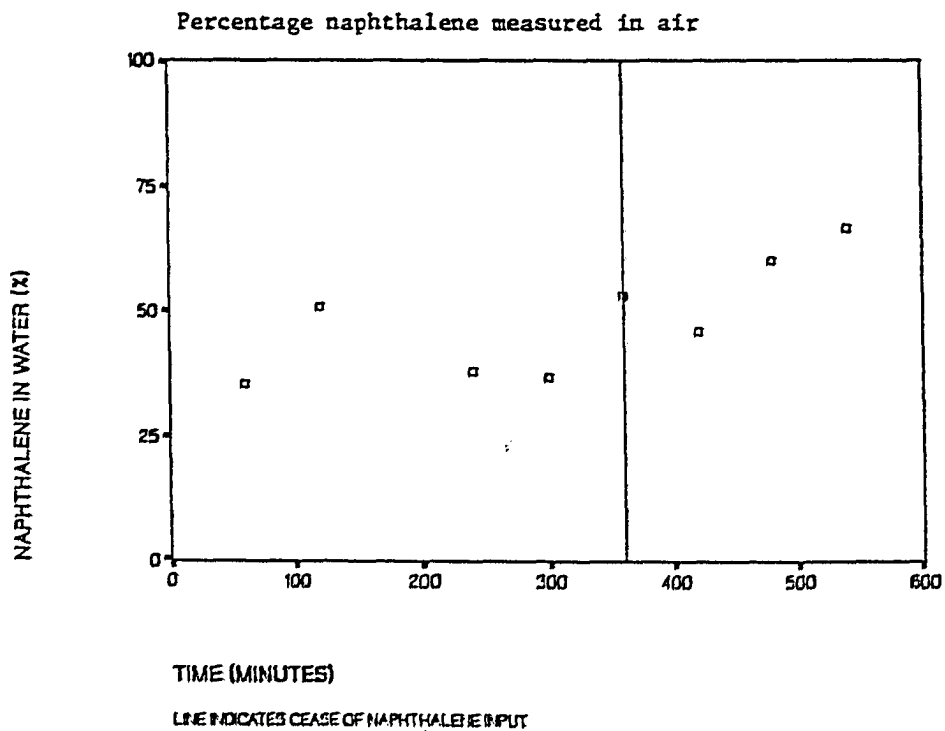



The percentage of total naphthalene in water at later times compared to that for 360 minutes tells about the direction of naphthalene transport: air to water or water to air.

After three hours, the dissolved naphthalene increased by 13.6% and the naphthalene in the air contained in the flask decreased to 6.6% of its value at 360 minutes. The transport of naphthalene from air to water continued, and there was no apparent release of naphthalene from water back to the air.

### III-2.3. Experiment with York River water

Gas flow: 0.31 ml/sec.

Concentration in gas coming in:  $2.36 \pm 0.21$  ug/ml (n=9)

Naphthalene added to the system: 43.80 ug/min.

time (min)	total naph. added (ug)	total naph. in water (ug) and perc. of total input conc.x vol.	total naph. in air (ug) and perc. of total input conc.x vol.
30	1314	$0.60 \times 800 = 480$ 36.5%	$2.0 \times 295 = 590$ 44.9%
60	2628	$1.07 \times 790 = 845$ 32.2%	$4.1 \times 305 = 1250$ 47.6%
120	5256	$1.36 \times 780 = 1061$ 20.2%	$4.2 \times 315 = 1323$ 25.2%
180	7884	$4.13 \times 770 = 3180$ 40.3%	$7.3 \times 325 = 2372$ 30.1%
240	10512	$5.24 \times 760 = 3982$ 37.9%	$6.0 \times 335 = 2010$ 19.2%
360	15768	$6.26 \times 750 = 4695$ 29.8%	$7.1 \times 345 = 2449$ 15.5%

# FIGURE III 7 HIGH PURITY WATER

Ibid. III 6

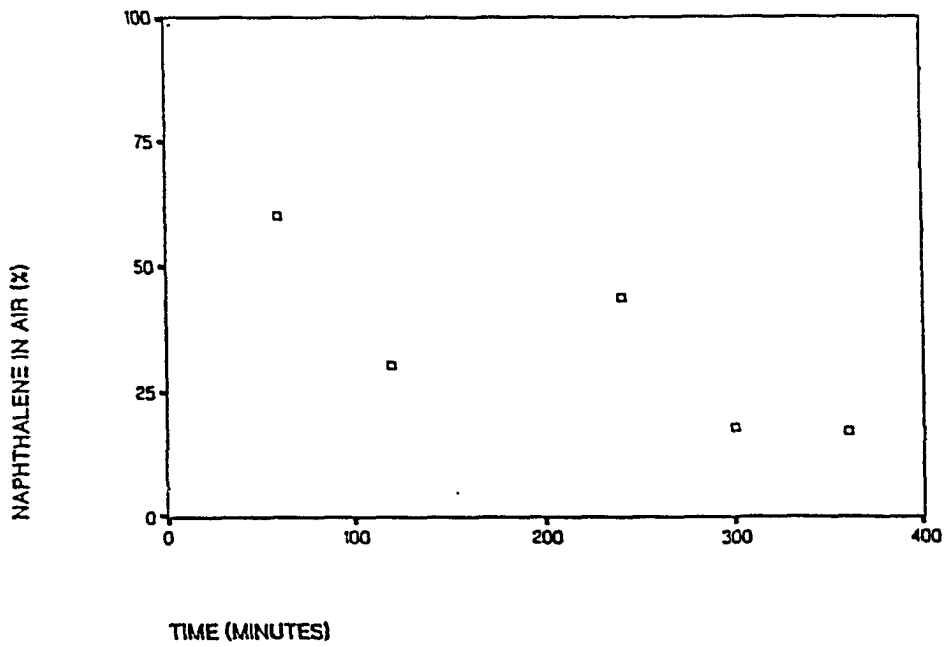

# FIGURE III 8 YORK RIVER WATER

Naphthalene dissolved in water

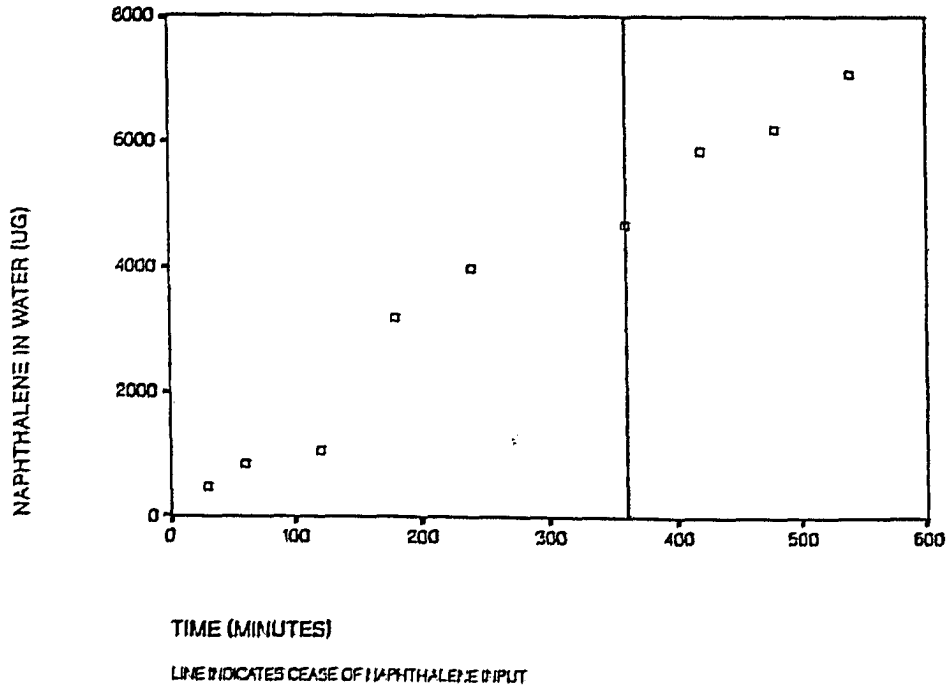

Figure III-8 indicates that there is a direct correlation between naphthalene input in the air and dissolution in water in a similar manner than for high purity water. Both cases present exactly the same correlation coefficient,  $r = 0.956$ . The naphthalene values in the air are shown in figure III-9.

Again, the percentage is approximately constant, with a dissolution rate of 30 to 40% (figure III-10).

#### Experiment with York River water, part 2

After six hours, the nitrogen tank and the valve were shut off. Sampling continued for three more hours (figures III-8 and III-9).

time (min)	total naph. in water (ug) and perc. of total naph. at 360 min. to given time		total naph. in air (ug) and perc. of total naph. at 360 min. to given time	
	420	$7.91 \times 740 = 5857$	124%	$2.8 \times 355 = 1000$
480	$8.49 \times 730 = 6202$	132%	$2.0 \times 365 = 724$	30%
540	$9.83 \times 720 = 7080$	151%	$0.6 \times 375 = 241$	10%

For the York River water experiment, water kept dissolving naphthalene from the air after the gas was cut off.

### FIGURE III 9 YORK RIVER WATER

Naphthalene measured in air

87

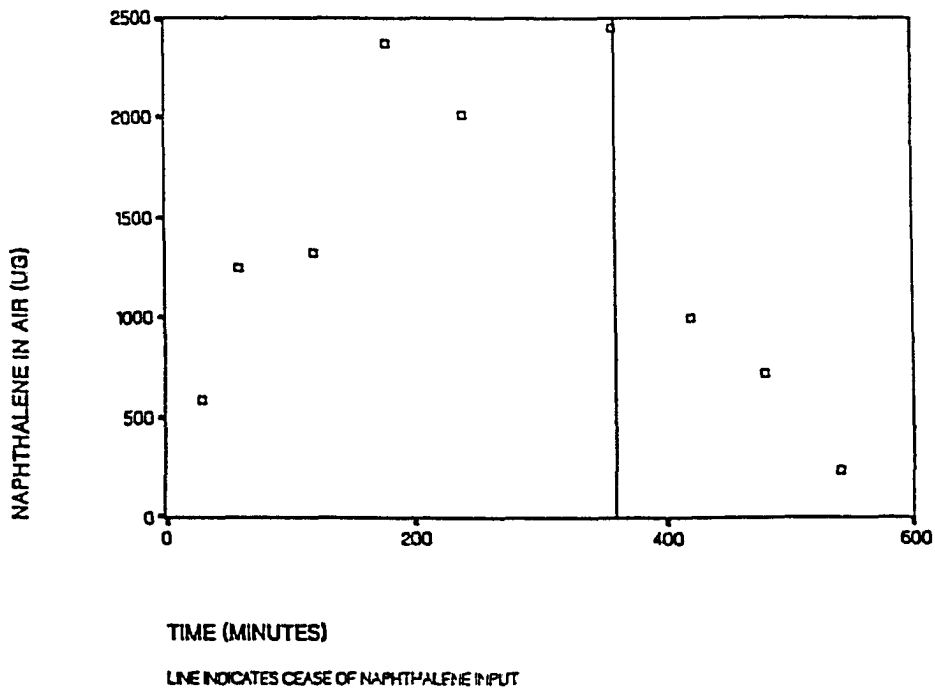

### FIGURE III 10 YORK RIVER WATER

Percentage naphthalene dissolved in water

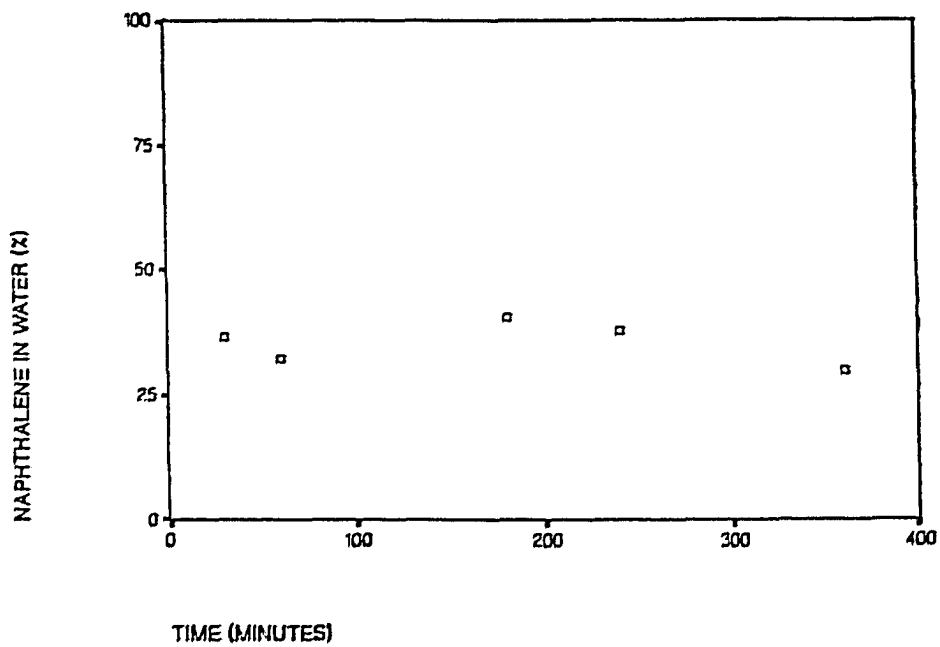

# FIGURE III 11 YORK RIVER WATER

Percentage naphthalene measured in air

88

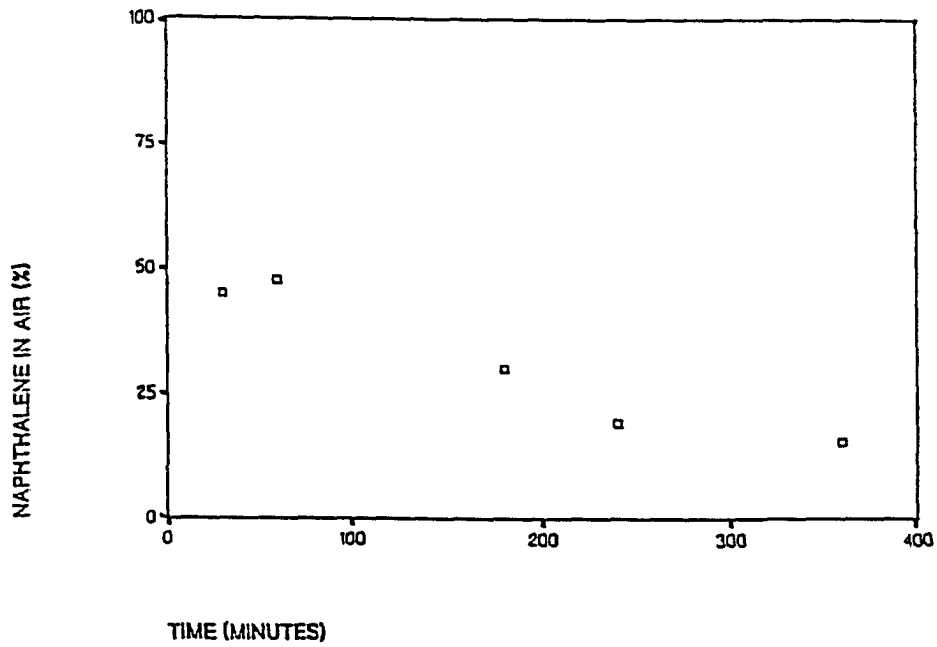

# FIGURE III 12 SSM ONLY

Naphthalene dissolved in SSM

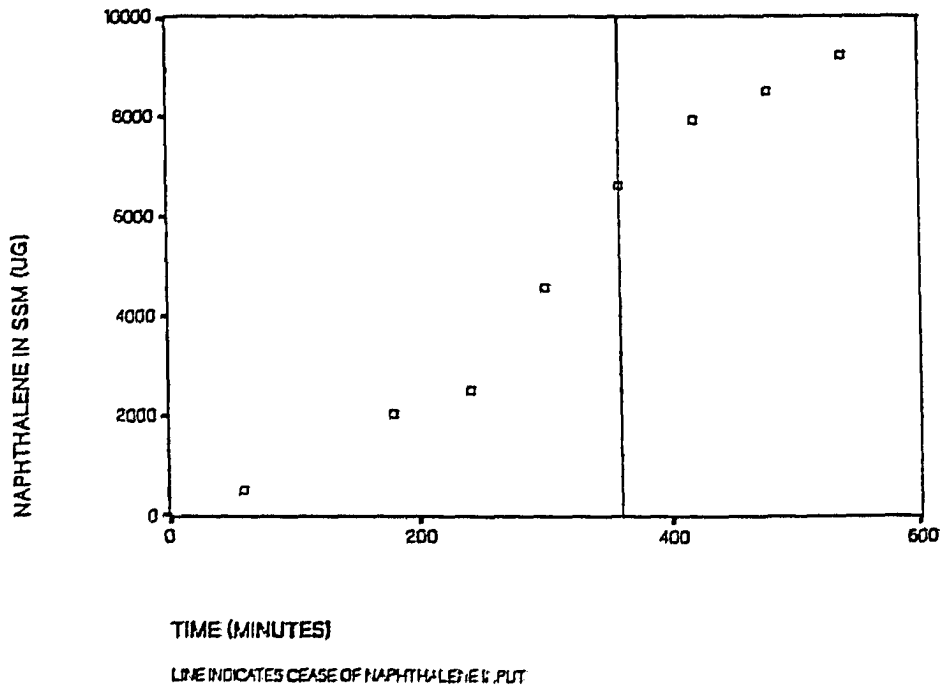

III-2.4. Experiment with sea surface microlayer only, part 1

Gas flow: 0.31 ml/sec.

Concentration of naphthalene in incoming gas:  $1.45 \pm 0.31$  ug/ml (n=8)

Total naphthalene added: 26.97 ug/min.

time (min)	total naph. added (ug)	total naph. in water (ug) and perc. of total input	total naph. in air (ug) and perc. of total input
		conc.x vol.	conc.x vol.
60	1618.2	0.65x800 = 520 32%	2.6x295 = 767 47%
120	3236.4		5.9x305 = 1799 55%
180	4854.6	2.61x780 = 2035 42%	6.4x315 = 2016 41%
240	6472.8	3.25x770 = 2502 39%	4.6x325 = 1495 23%
300	8091.0	6.02x760 = 4578 57%	3.7x335 = 1264 16%
360	9709.2	8.85x750 = 6637 68%	2.8x345 = 987 10%

In figure III-13 increasing amounts of naphthalene were observed in SSM and air with time, up to 180 minutes (3 hours). After that period of time, the uptake by SSM keeps increasing (figure III-12), and the amount of

### FIGURE III 13 SSM ONLY

Naphthalene measured in air

90

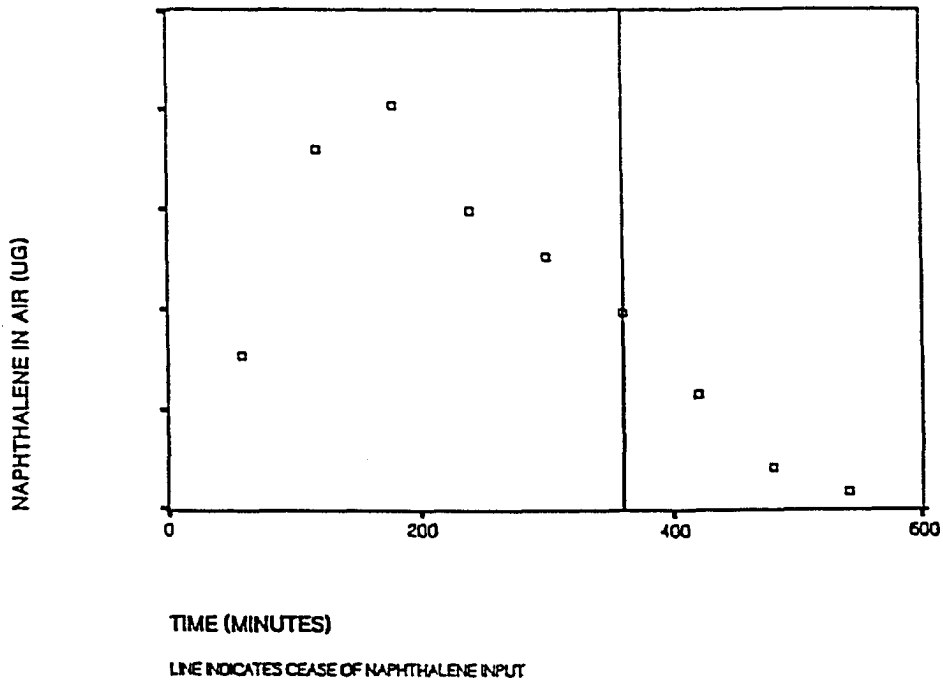

### FIGURE III 14 SSM ONLY

Percentage naphthalene dissolved in SSM

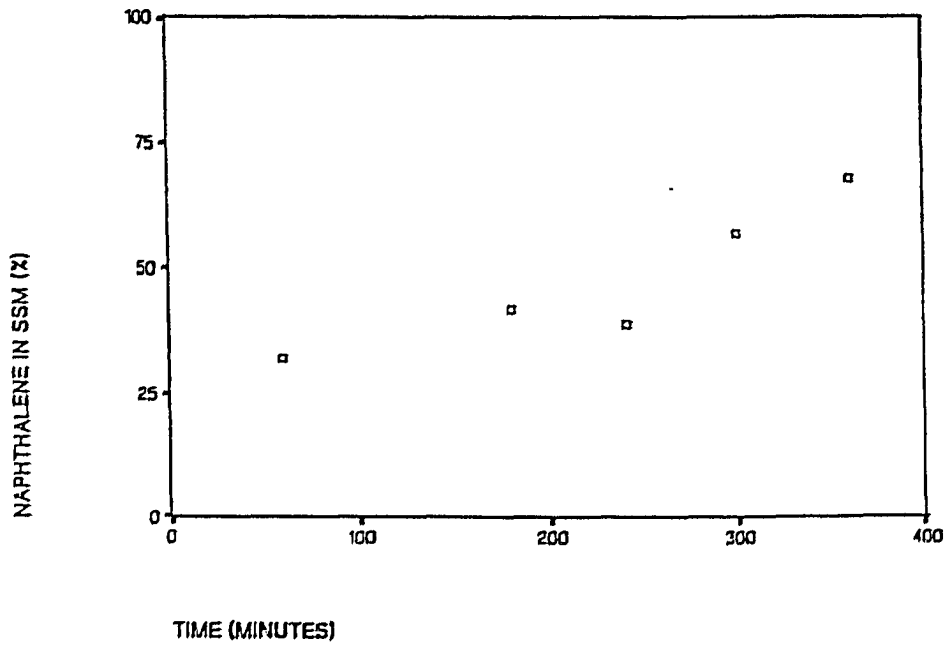

naphthalene in the air decreases (figure III-13). Again, the scales are different, e.g. for 60 and 180 minutes, amounts of naphthalene in SSM are 520 ug and 2,035.8 ug and in the air, 76.7 ug and 403.2 ug, respectively.

The situation here is very different compared to the experiments done with high purity and York River waters. Figure III-14 indicates that there is a positive correlation between input of naphthalene in the air and uptake by the SSM. This organic liquid presents an excellent media for the aromatic compound to be removed from the air inside the flask (figure III-15).

#### Experiment with SSM only, part 2

Three samples of air and water were taken after the naphthalene was stopped at 360 minutes (figures III-12 and III-13).

time (min)	total naph. in water (ug) and perc. of total naph. at 360 min. to given time		total naph. in air (ug) and perc. of total naph. at 360 min. to given time	
	420	$10.71 \times 740 = 7927$	119%	$1.64 \times 355 = 581$
480	$11.65 \times 730 = 8504$	128%	$0.59 \times 365 = 214$	22%
540	$12.79 \times 720 = 9213$	139%	$0.25 \times 375 = 93$	9%



# FIGURE III 15 SSM ONLY

Percentage naphthalene dissolved in SSM

92

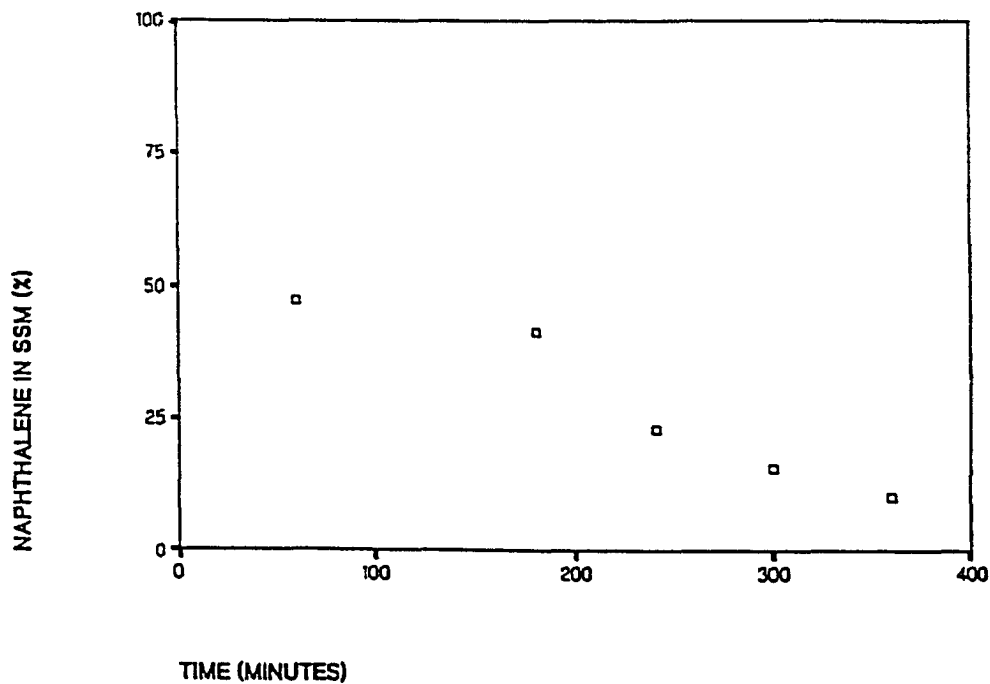

# FIGURE III 16 WATER + SSM

Naphthalene dissolved in water

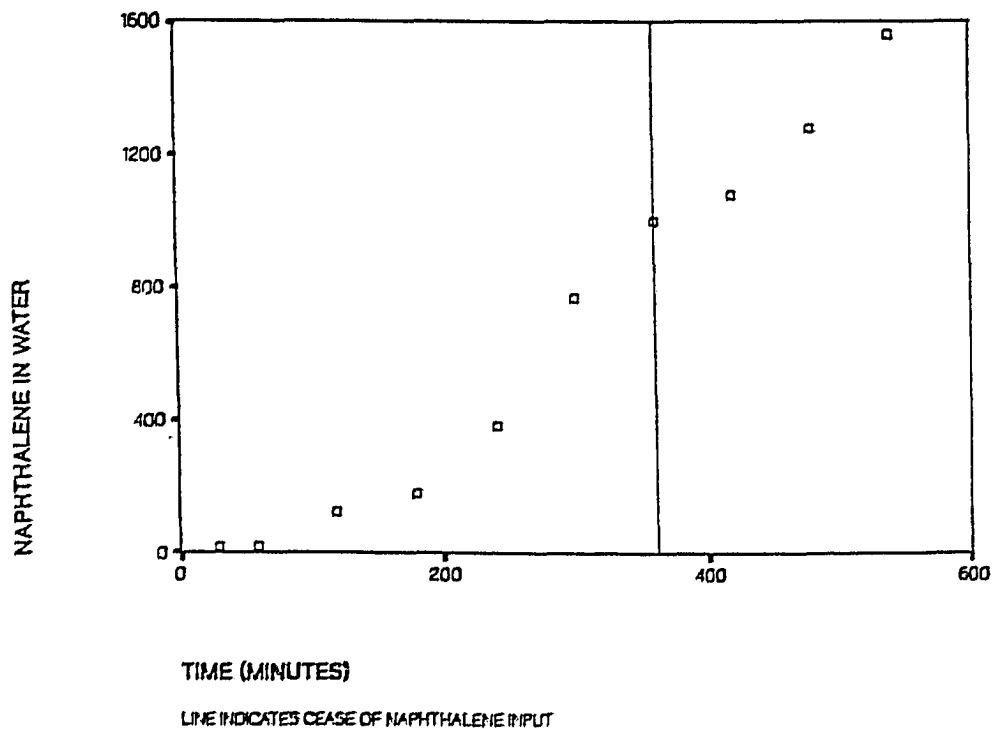

The SSM uptake of naphthalene continued until it was almost completely gone. SSM uptake was 9213.3 ug out of 9709.2, almost 95% removal, leaving less than 1% (92.7 ug) in the air.

### III-2.5. Experiment with high purity water and a 50 um surface microlayer, part 1

The water volume utilized was 800 ml as for the other set of experiments. A 50 um thick SSM was added. To obtain the desired SSM thickness :

Water surface diameter inside the flask: 12.0 cm.

Surface of the water area:  $3.1416 \times 36 = 113.1 \text{ cm}^2$ .

1 um =  $1 \times 10^{-4} \text{ cm}$ , so 50 um = 0.005 cm

Volume of SSM needed for a 0.005 cm thickness:

$113.1 \text{ cm}^2 \times 0.005 \text{ cm} = 0.565 \text{ cm}^3 \text{ (ml)}$ .

A volume of 0.6 ml of SSM was placed on top of the water very carefully with a pipet.

Gas flow: 0.28 ml/sec.

Concentration of naphthalene in incoming gas:  $1.77 \pm 0.19 \text{ ug/ml}$  (n=9)

Total naphthalene added: 29.70 ug/min.

time (min)	total naph. added (ug)	total naph.in water (ug) and		total naph.in air (ug) and		total naph.in SSM (ug) and	
		% of tot. input	% of tot. input	% of tot. input	% of tot. input	% of tot. input	% of tot. input
30	891	22.4	0.2%	474.6	55.6%	393.9	44.2%
60	1782	22.9	1.3%	345.3	19.4%	1413.8	79.3%
120	3564	124.8	3.5%	297.7	8.4%	3141.5	88.1%
180	5346	180.2	3.3%	268.4	5.1%	4897.4	91.6%
240	7128	385.3	5.3%	375.5	5.4%	6367.2	89.3%
300	8910	767.2	8.5%	1937.5	21.9%	6205.2	69.6%
360	10692	1003.4	9.3%	5131.9	48.1%	4556.7	42.6%

Figure III-16 shows the increasing total amount of naphthalene in the water underneath the surface microlayer and figure III-17 the total amounts in the air. Compared to the uptake by high purity water and York River water the slope of the line is similar but, the total amount of naphthalene that the SSM allowed to go through is much less. This is more evident when comparing percentage dissolution.

# FIGURE III 17 WATER + SSM

Naphthalene measured in air

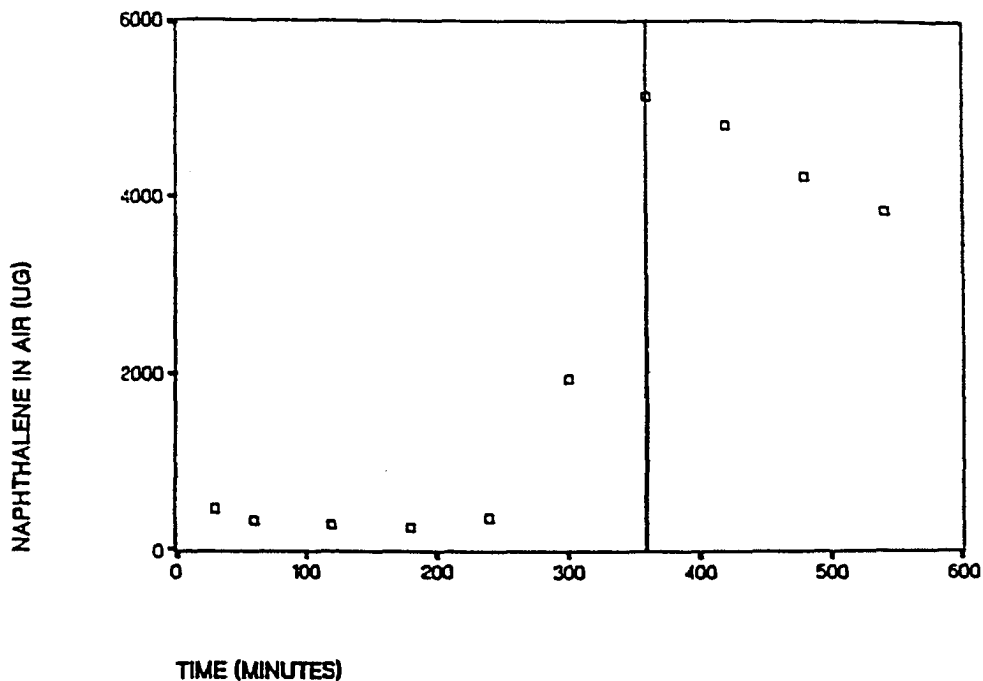

LINE INDICATES CEASE OF NAPHTHALENE INPUT

# FIGURE III 18 WATER + SSM

Naphthalene dissolved in SSM

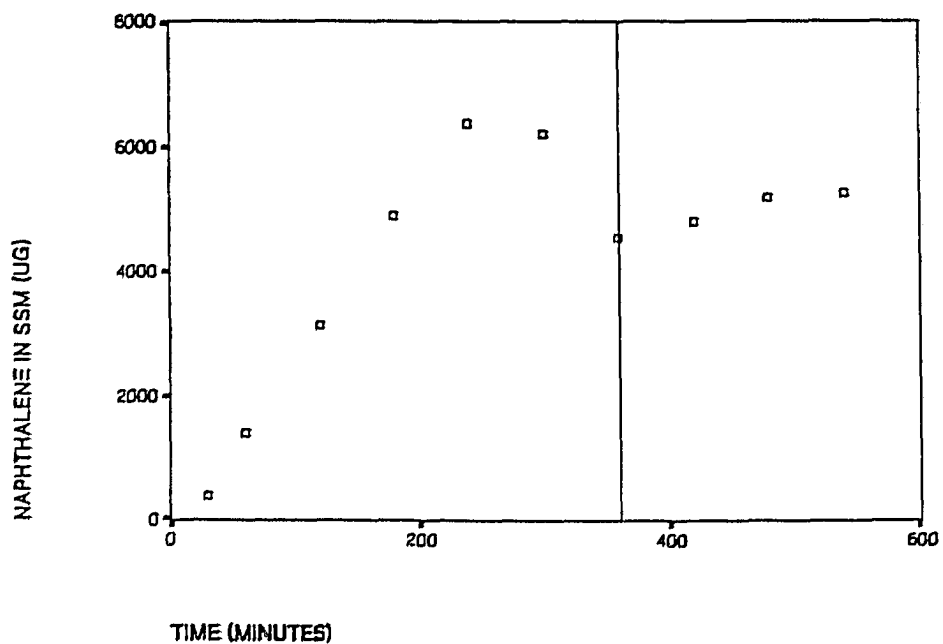

LINE INDICATES CEASE OF NAPHTHALENE INPUT

The difference between the total naphthalene added, and the naphthalene dissolved in water plus air, should be approximate to the uptake by SSM (figure III-18).

These values are approximate and do not take into consideration the naphthalene uptake by glass and septa. This value is not larger than 10% as described later.

Figure III-19 indicates that at approximately 180 minutes there is a saturation of the SSM. At this point, the uptake of naphthalene from air began to decline but, the input to the water from SSM was still increasing, as seen in figure III-20.

With a 50 um microlayer present, the percentage uptake of naphthalene by water increased with time. There was a very slow and constant release of the aromatic compound into the water, even though the total input to the air inside the bottle was very large.

### FIGURE III 19 WATER + SSM

Percentage naphthalene dissolved in SSM

97

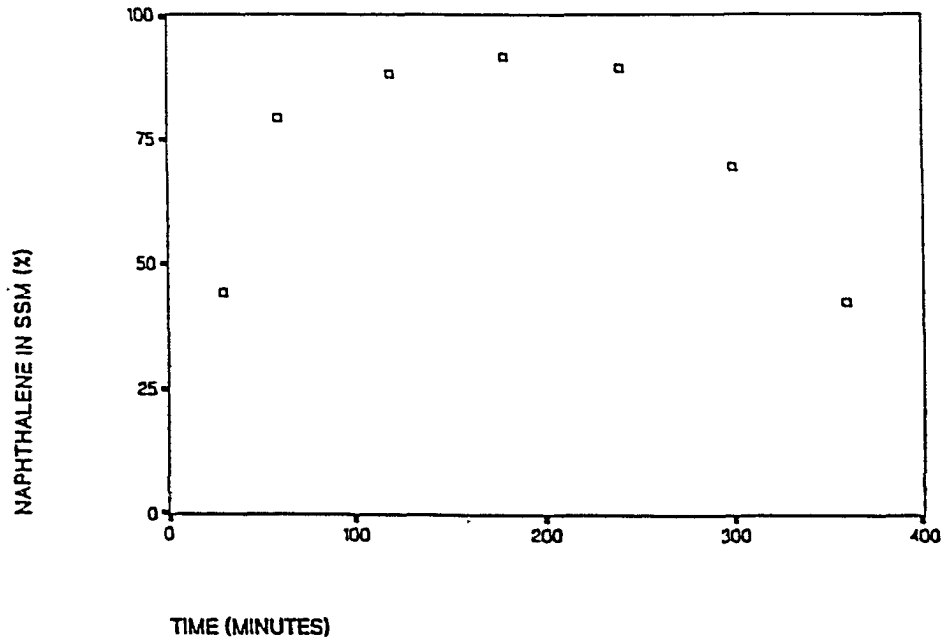

### FIGURE III 20 WATER + SSM

Naphthalene dissolved in water

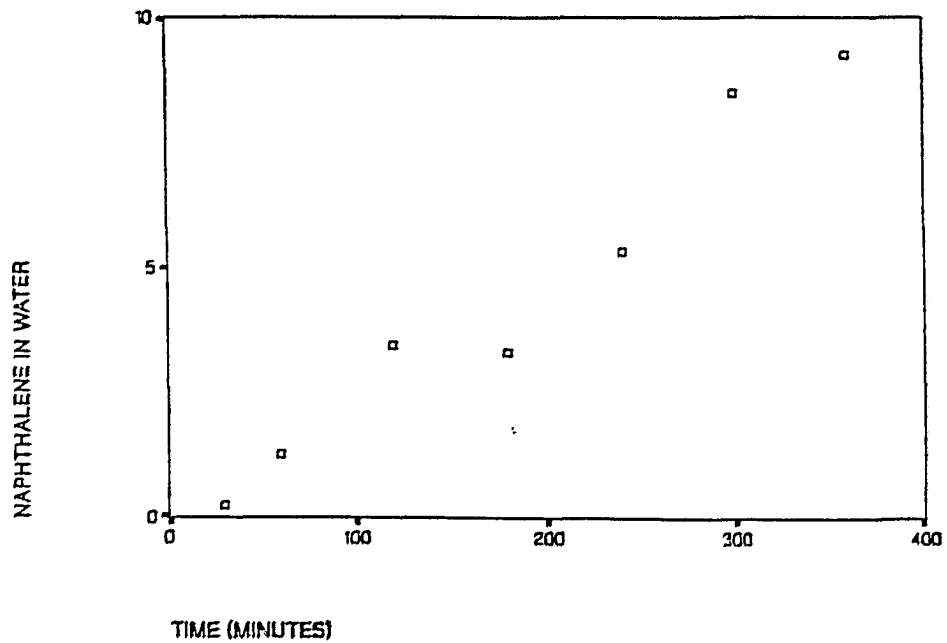

### Experiment with water and SSM, part 2

Naphthalene uptake by water and air after supply ceased (figures III-16 and III-17):

time (min)	total naph. in water (ug) and perc. of total naph. at 360 min. to given time		total naph. in SSM (ug) and perc. of total naph. at 360 min. to given time	
	420	1082.3	108%	4808.7
480	1279.1	127%	5194.2	114%
540	1598.7	159%	5270.1	116%

These numbers show that SSM kept dissolving naphthalene from the air (figure III-22), and during the same period of time, water kept dissolving it from the SSM (figure III-21).

#### III-2.6. Experiment without any liquid

This experiment was done in order to see how much naphthalene was adsorbed onto the flask, the septa and the glass stirrer.

Gas flow: 0.28 ml/sec.

Concentration of naphthalene in incoming gas:  $0.56 \pm 0.06$  ug/ml (n=7)

Naphthalene added: 9.41 ug/min.

### FIGURE III 21 WATER + SSM

Percentage difference of naphthalene dissolved in water

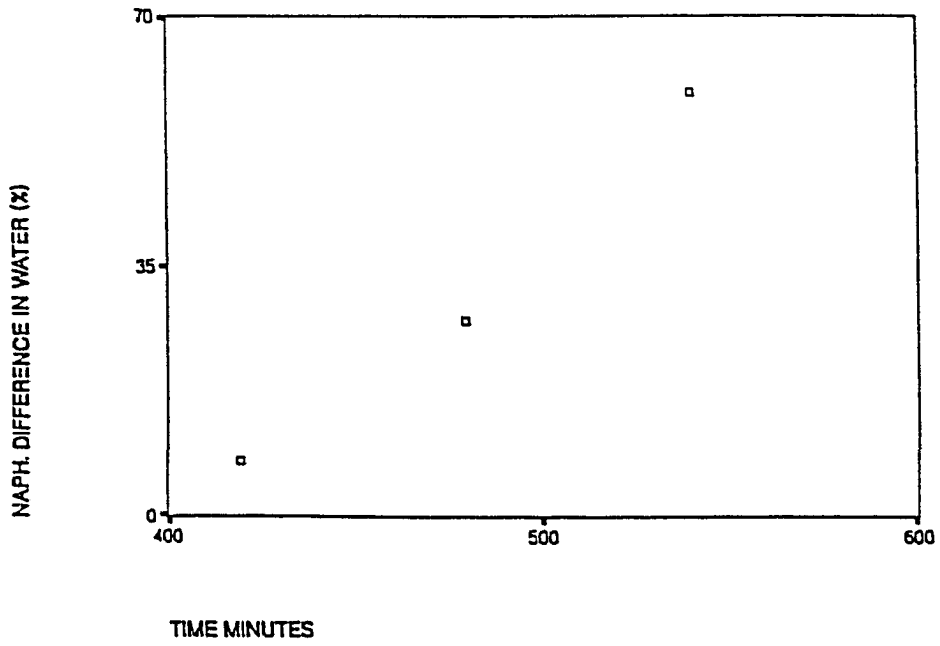

### FIGURE III 22 WATER + SSM

Percentage difference of naphthalene dissolved in SSM

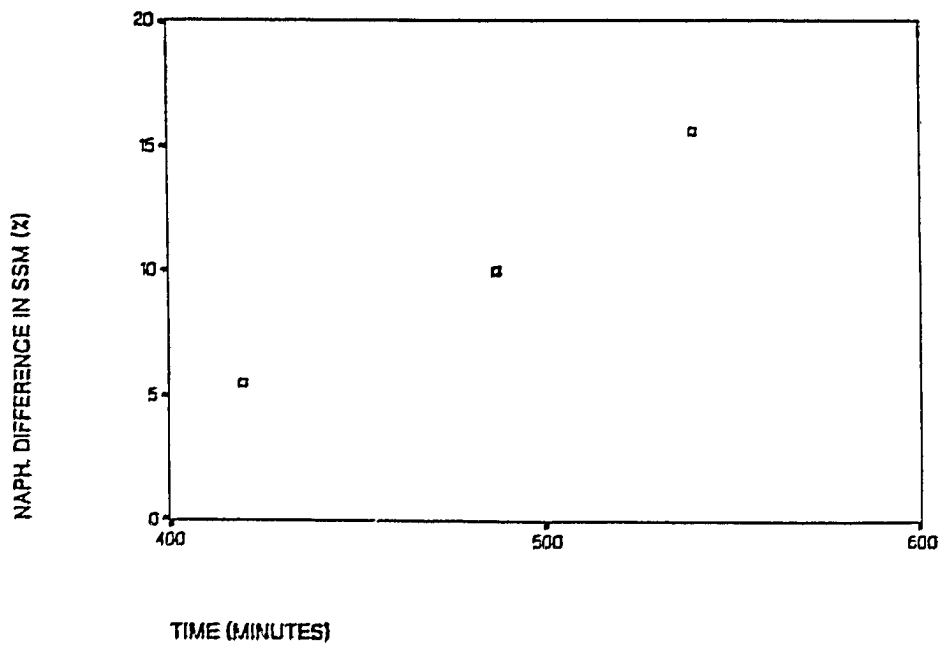



<u>time (min.)</u>	<u>total naph. added (ug)</u>	<u>total naph. in air (conc.x air vol.) (ug)</u>
20	188.16	$0.011 \times 1095 = 12.03$
40	376.32	$0.046 \times 1095 = 50.37$
60	564.48	$0.430 \times 1095 = 470.85$
120	1128.96	$0.801 \times 1095 = 878.89$
180	1693.44	$1.330 \times 1095 = 1458.23$
240	2257.92	$1.992 \times 1095 = 2176.80$
300	2823.00	$2.581 \times 1095 = 2821.87$

## naphthalene uptake by glass and septa

<u>time (min.)</u>	<u>(percentage of total input)</u>		
20	188.16/12.03	6.39	100 - 6.39 = 93.61 %
40	376.32/50.37	13.38	100 - 13.38 = 86.62 %
60	564.48/470.85	83.41	100 - 83.41 = 16.39 %
120	1128.96/878.89	77.85	100 - 77.85 = 22.15 %
180	1693.44/1458.23	86.11	100 - 86.11 = 13.89 %
240	2257.92/2176.80	96.41	100 - 96.41 = 3.59 %
300	2823.00/2821.87	99.69	100 - 99.69 = 0.31 %

In order to fill up the flask (1,095 ml) with gas at a flow rate of 0.28 ml/sec. approximately 65 minutes are needed (reference line in figure III-23). So, the high percentage values shown at 20 and 40 minutes samples do not represent adsorption. The values to be considered should be the percentages between one and five hours (16.39 and 0.31 %).

### FIGURE III 23 GLASS + SEPTA UPTAKE

Naphthalene uptake by glass and septa of the laboratory apparatus

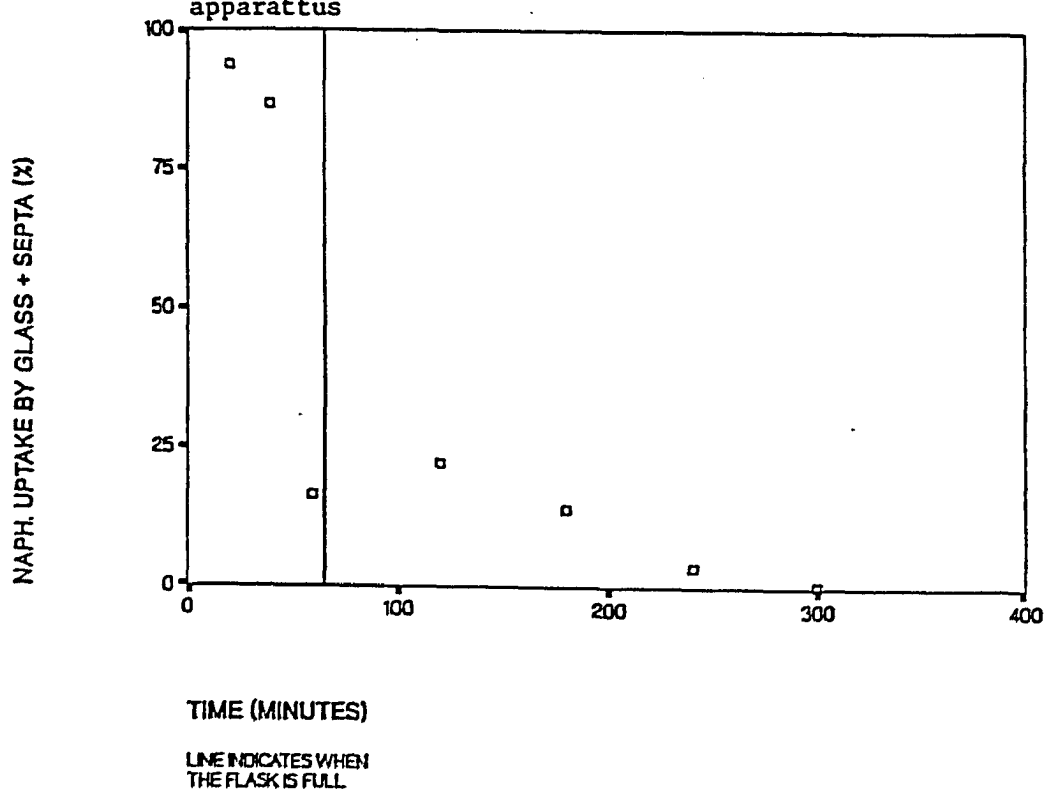

### III-3. Apparent Henry's law constants in the naphthalene transport study system

In 1803, William Henry (1775-1836) found a relationship between the partial pressure of a gas above a liquid and the solubility of that gas in the liquid at specified temperature and total pressure. The Henry's law constant  $H$  (atm.m<sup>3</sup>/mol) is the ratio of the atmospheric partial pressure  $P$  (atm) to the water concentration  $C$  (gmol/m<sup>3</sup>) at equilibrium. It is usually nearly constant at low pressures and concentrations and, for low solubility substances, can be estimated from the ratio of the substance's vapor pressure and solubility at given temperature and pressure (Mackay and Yuen, 1981). Both these equilibrium quantities are used for predicting environmental fate. In recent years there has been a marked improvement in techniques for measuring these quantities for organic molecules of environmental concern. Some are dynamic and involve the principle of flowing air or water through a column which contains the substance to be measured deposited on an inert packing, with subsequent trapping and quantity measurement of the evaporated or dissolved substance from a known volume of air or water. Flow rates must be sufficiently low that solute equilibrium is approached in the column between stationary and mobile phases.

At equilibrium, compounds with high  $H$  (e.g. oxygen) are partitioned preferentially into the atmosphere, whereas those of low  $H$  (e.g. sulfur dioxide) are partitioned preferentially into the water. As a general rule, compounds with  $H > 10^{-3}$  will partition into the atmosphere and compounds with  $H < 10^{-5}$  will partition into water.

As expressed in the definition of H, the system should be at equilibrium. If we have a closed system (isothermal and isobaric), adding more solute (naphthalene in our experiments) a new equilibrium will be reached. If the system is not at equilibrium, the components will be transported in such a manner to cause the system to shift to equilibrium. With sufficient time, it will eventually reach equilibrium.

The laboratory experimental system was not open to mass exchange of naphthalene so it could not approach equilibrium. The apparent H values obtained from our data are thus not Henry's law constant values. However, we can use these apparent H values to predict partition properties of naphthalene and its tendency to migrate between the atmosphere and natural water bodies. This may or may not be the direction of naphthalene transfer by other mechanisms such as wet or dry deposition. Apparent H values can be compared with literature H values for naphthalene water system to obtain a measure of how closely the open systems used here approach equilibrium.

From published data for naphthalene:

$$\text{Henry's law constant (H)} = 4.83 \times 10^{-4} \text{ m}^3 \cdot \text{atm} / \text{gmol}$$

$$\text{Vapor pressure (P) @ } 25^\circ \text{C} = 1.2 \times 10^{-4} \text{ atm}$$

(Mackay et al., 1979)

$$\text{gmol} = \text{weight in g} / 128.16 \text{ g/mol}$$

For our experimental results:

$$H = \frac{P \text{ (atm)}}{C \text{ (gmol/m}^3)} = \frac{P \text{ (atm)}}{(n_{\text{ap}} \cdot \mu\text{g} \times 10^{-6} / 128.16) \text{ gmol} / (\text{vol}(1) \times 10^{-4}) \text{ m}^3}$$

Table III 3.1- Apparent Henry's law constant (atm.cu.m/gmol) values from naphthalene transport experiments calculated at times given in minutes in parenthesis

High purity water	York river water	High purity water with approx. 50 um SSm
4.7x10(-4) (180)	3.7x10(-4) (180)	96x10(-4) (120)
3.8x10(-4) (240)	2.9x10(-4) (240)	31x10(-4) (240)

The apparent H values obtained from high purity water experiments ( $4.7 \times 10^{-4}$  and  $3.8 \times 10^{-4}$  atm.m<sup>3</sup>/gmol) and for York River water experiments ( $3.7 \times 10^{-4}$  and  $2.9 \times 10^{-4}$  atm.m<sup>3</sup>/gmol) approach closely to accepted value given in the literature ( $4.8 \times 10^{-4}$  atm.m<sup>3</sup>/gmol). Much higher values obtained from the experiments done with high purity water and a 50 um surface microlayer ( $96.0 \times 10^{-4}$  and  $31.1 \times 10^{-4}$  atm.m<sup>3</sup>/gmol) indicate that there was a much lower solubility of naphthalene in this water. So, we can state that Henry's law constant for an air-water system does not apply to water bodies that present a surface microlayer.

#### IV SUMMARY OF OBSERVATIONS.

##### IV.1- Field observations:

Tributyltin levels in the surface microlayer of the York River system would present a definite hazard to shellfish larvae.

Polycyclic aromatic hydrocarbons could present a hazard to biota if high concentration levels remain constant for prolonged periods of time.

The higher values of particulate carbon and nitrogen found in the SSM during the warm months (April-August) is a reflection of higher biological activity.

Continuous SSM sampling with a drum (intervals of weeks, days, three hours and intervals of forty five minutes) showed variability of SSM aromatic composition. These changes were not due to sampling operations.

Over 98% of the aromatic hydrocarbons sampled in the air were in the vapor phase. 100% of the aromatic hydrocarbons detected in the SSM were in the particulate phase ( $>0.45 \mu\text{m}$ ).

No correlation exists between air/surface water temperature and SSM thickness.

#### IV.2- Laboratory observations:

Clean surface water (i.e. without SSM) uptake of vapor phase naphthalene was high for York River and high purity water.

SSM dissolved twice as much of the total naphthalene supplied in gaseous form compared to water. The uptake data will tend towards 100% uptake due to its organic characteristics.

Glass and septa adsorption of naphthalene in the laboratory experiments was low compared to water samples after a period of 180 minutes.

During continuous input of naphthalene in the vapor phase, a 50 um SSM absorbed most of it, up to 92%. The subsurface water presented an increasing uptake of naphthalene, from 0% to 10% after six hours.

When a SSM is not present, the water dissolved large quantities of PAH from the vapor phase. By extracting large volumes of water, dissolved PAH content could be determined in field studies in the possible absence of surface microlayers.



Water covered by an organic film (SSM) of approximately 50  $\mu\text{m}$  took up PAH differently than water without SSM. The SSM will retain atmospheric vapor phase PAH and it will release them to subsurface waters in slow rates. In this case, very large volumes of subsurface water should be extracted in order to accomplish PAH detection.

Apparent H values for naphthalene in experiments using high purity and York River waters, under laboratory conditions, fell in a close range to the Henry's law constant at 25 $^{\circ}$  C.

The air-water Henry's law constant for PAH should not be used for environmental modeling of systems with natural surface microlayers.

When PAH are released to the atmosphere, their path of transport to the bulk water of the oceans appears to be the following:

- 1) The SSM extracts the vapor phase PAH from the air; in absence of SSM the dissolution of PAH follows Henry's law.
- 2) These aromatic compounds go from dissolved into particulate phase very rapidly once in the surface waters.
- 3) Part of the PAH load (0-10%) dissolves into the subsurface water during the first six hours.

- 4) Depending on environmental factors such as temperature and pressure, these products could go back into the atmosphere;
  
- 5) Particulate PAH in the SSM have a different pathway of being removed from this layer. It depends on mechanical and biological effects: biota uptake and fecal pellets release, adsorption onto larger particles and flocculation, wind pressure, waves, bubbles bursting, microjet ejection.

## V CONCLUSIONS

The sea surface microlayer is a very variable microenvironment. It changes constantly in space, time and composition.

Vapor phase PAH of low molecular weight (e.g. naphthalene) are extracted by the SSM and apparently go from dissolved into particulate phase very rapidly.

Water covered with a natural SSM will receive much less atmospheric inputs of vapor PAH (dissolved phase) than water without SSM in a given time period.

Henry's law constant does not apply when SSM is present. The high uptake capacity of this type of film takes it impossible to approach equilibrium conditions in the marine atmospheric environment.

## VI BIBLIOGRAPHY

- Adamson A.W. (1982). Physical chemistry of surfaces. 4th. ed., Wiley-Interscience
- Andren A., Strand, J. (1981). Atmospheric deposition of particulate organic carbon and PAH to Lake Michigan. In: *Atm. Poll. in Natural Waters*. Ann Arbor Sci. pp.459-479
- Atlas E. and C. Giam (1980). Global transport of organic pollutants: ambient concentrations in the remote marine atmosphere. *Science*,211:163-165.
- Atlas E., R. Foster and C. Giam (1982). Air-sea exchange of high molecular weight organic pollutants: laboratory studies. *Env. Sci. Technol.* v.16, n.5, 283-286.
- Baier R.E. (1972). Organic films in natural waters: their retrieval, identification and modes of elimination. *J. Geoph. Res.* sept.1972:5062.
- Baier R.E., D.W. Goupil, S. Perlmutter and R. King (1974). Dominant chemical composition of sea-surface films, natural slicks, and foams. *J. de Rech. Atm.* 8:571

- Barger W., W. Daniel and W. D. Garrett (1974). Surface chemical properties of banded sea slicks. *Deep Sea Res.* 21:89-89
- Barstow S.F. (1983). The ecology of Langmuir circulation: a review. *Mar. Env. Res.* 9:211-236
- Beaumont A.R. and P.B. Newman (1986). Low levels of tributyl tin reduce growth in marine micro-algae. *Mar. Poll. Bull.* 17(10):457-461
- Bender M., R.J. Huggett, A.Y. Kuo and R.J. Byrne (1984). Craney Island rehandling basin: physical and chemical studies. VIMS report to U.S. of Army Corps of Engineers, Norfolk District. Contract No.: DACW65-83-M-1082 and DACW65-84-M-0503
- Bernal J.D. (1967). *The origin of life.* The world publishing co. Cleveland Ohio.
- Bidleman T.F., C.G. Simon, N.F. Burdick and Feng You (1984). Theoretical plate measurements and collection efficiencies for high-volume air samplers using polyurethane foam. *J. of Chromatog.* 301:448-453
- Bidleman T.F., W.N. Billings and W.T. Foreman (1986). Vapor-particle partitioning of semivolatile organic compounds: estimates from field

collections. *Env. Sci. Technol.* v.20 #10: 1038-1043

Bieri R.H., C. Hein, R.J. Huggett, P. Shou, H. Slone, C. Smith and C. Su  
(1986). Polycyclic aromatic hydrocarbons in surface sediments from the  
Elizabeth River Subestuary. *Inter. J. Env. Anal. Chem.* v.26:97-113

Billings W.N. and T.F. Bidleman (1983). High volume collection of  
chlorinated hydrocarbons in urban air using three solid adsorbents.  
*Atm. Env.* v.17 #2:383-391

Blumer M. (1976). PAH compounds in nature. *Sci. Amer.*, v.234,n.3:35-45

Boesch D. (1977). Application of numerical classification in ecological in  
vestigations of water pollution. E.P.A. 600/3-77-033 March 1977

Boehm P. (1980). Evidence for the decoupling of dissolved, particulate and  
surface microlayer hydrocarbons in NW Atlantic continental shelf waters.  
*Mar. Chem.* 9 (1980):255-281

Brockman U., H. Huhnerfuss, G. Kattner, H. Broecker and G. Hentzschel  
(1982). Artificial surface films in the sea near Sylt. *Limnol.Ocean.*  
27(6):1050

Burdick N.F. and T.F. Bidleman (1981). Frontal movement of hexachlorobenzene and polychlorinated biphenyl through polyurethane foam. *Anal. Chem.* 53: 1926-1929

Butler A.C. and R.R. Sibbald (1987). Sampling and GC-FID, GC/MS analysis of petroleum hydrocarbons in the ocean surface microlayer off Richards Bay, South Africa. *Est. Cost. and Shelf Sc.* 25:27-42

Byrne, R.J., A.Y. Kuo, R.L. Mann, J.M. Brubaker, E.P. Ruzecki, P.V. Hyer, R.J. Diaz, J.H. Posenau (1986). New Port Island: an evaluation of potential impacts on marine resources of the Lower James River and Hampton Roads. Sp. Rep. in *Ap. Mar. Sc. and Oc. Eng.* No.XXX, VIMS

Carlson D.J. and L.M. Mayer (1980). Enrichment of dissolved phenolic material in the surface microlayer of coastal waters. *Nature*, v.286:482-483

Carlson D.J. (1982). A field evaluation of plate and screen microlayer sampling techniques. *Mar. Chem.* 11:189-208

Carlson D.J. (1983). DOM in surface microlayers: temporal and spatial variability and relation to sea state. *Limn. Ocean.* 28;415-431

Carlson D.J., J.L. Cantey, J.J. Cullen (1988). Description and results of a new surface microlayer sampling device. Submitted to Deep Sea Research.

Cohen Y., W. Cocchio and D. Mackay (1978). Laboratory study of liquid-phase controlled volatilization rates in presence of wind waves. *Env. Sci. Techno.* v.12, n.5:553-558

Cohen Y. (1983). Mass transfer across a sheared, wavy air-water interface. *Int. J. Heat Mass transfer* v.26,n.9:1289-1297

Cross J.N., J.T. Hardy, J.E. Hose, G.P. Hershelman, L.D. Antrim, R.W.

Gossett, E.A. Crecelius (1987). Contaminant concentrations and toxicity of surface microlayer near Los Angeles, California. *Mar. Env. Res.* 23:307

Crow S.A., D.G. Ahearn, N.L. Cook and A.W. Bourquin (1975). Densities of bacteria and fungi in coastal surface films as determined by membrane-adsorption procedure. *Limn. Oceanog.* 20:644

Doskey P. and A. Andren (1981). Modeling the flux of atmospheric PCBs across the air/water interface. *Env. Sci. Techno.* v.15,n.6:705\_711

Dragcevic D. and V. Pravdic (1981). Properties of seawater/air interface.



- Rates of surface film formation under steady state conditions. *Limn. Oceanog.* 26(3):492-499
- Duce R.A., J.G.Quinn, C.E. Olney, S.R. Piotrowicz, B.J. Ray, T.L. Wade (1972). Enrichment of heavy metals in the surface microlayer of Narragansett Bay, Rhode Island. *Science*, 176:161-163
- Duce R.A. and E.J. Hoffman (1976). Chemical fractionation at the air -sea interface. *Ann. Rev. Earth and Plan. Sc.* 4:187-225
- Dumas R.A., P.L. La Borde, J.C. Marty and A. Saliot (1976). Influence of sampling method on chemical composition of water surface film. *Limn. Oceanog.* 21:319
- Eisenreich S., A. Elzerman and D. Armstrong (1978). Enrichment of micronutrients, heavy metals, and chlorinated hydrocarbons in wind generated lake foam. *Env. Sci. Techno.* 12:413
- Eisenreich S., B. Looney and J. Thornton (1981). Airborne organic contaminants in the Great Lakes ecosystem. *Env. Sci. Techno.* v.15, n.1: 30-38
- Elzerman A. (1981). Mechanisms of enrichment at the air-water interface.

In: *Atm. Poll. in Natural waters*. Ann Arbor Science. pp.81-97

Fasching J., R. Courant, R. Duce and S. Piotrowicz (1974). A new surface microlayer sampler utilizing the bubble microtone. *J. Res. Atm.* 8:649-652

Foster P. and L. Morris (1970). The use of UV absorption measurements for the estimation of organic pollution in inshore seawater. *Water Res.* Perg. Press, v.5:19-27

Foreman W.T. and T.F. Bidleman (1987). An experimental system for investigating vapor-particle partitioning of trace organic pollutants. *Env. Sci. Technol.* v.21 #9:869-875

Fox W.S. (1965). *The origins of prebiological systems and of their molecular matrices*. Acad. Press, New York.

Garrett W.D. (1965). Collection of slick forming materials from the sea surface. *Limn. Oceanog.* 10:602

Garrett W.D. (1967). The organic chemical composition of the ocean surface. *Deep Sea Res.* 14:221-227

Garrett W.D. and R.A. Duce (1980). Surface microlayer samplers. In: Air Sea Interaction: Instruments and Methods, Dobson et al., editors, Plenum Press, New York, pp.471-490

Georgii H. and G. Schmitt (1983). Distribution of PAH in precipitation. In: Precipitation scavenging, dry deposition, and resuspension. v.1 Elsevier pp 395-402

Gill P. and T. Graedel (1983). Organic films on atmospheric aerosol particles, fog droplets, cloud droplets, raindrops and snowflakes. Rev. of Geoph. and Space Phys. 21, n.4:903-920

Goldberg E., V. Hodge, M. Koide, J. Griffin, E. Gamble, O. Bricker, G. Matisoff, G. Holdren and R. Braun (1978). A pollution history of Chesapeake Bay. J. Geochim. Acta v.42:1413

Gosjean D. (1983). PAH in Los Angeles air from samples collected on teflon, glass and quartz filters. Atm. env. v.17:2565-2573

Grant G.C. (ed.) (1979). Middle Atlantic Bight zooplankton: second year results and a discussion of the two-year BLM-VIMS survey. Chapter 4. Special report in Applied Marine Science and Ocean Engineering N.192. Virginia Institute of Marine Science, Virginia. 236pp

Green T. and D.F. Houck (1979). The removal of organic surface films by rain. *Limn. Oceanog.* 24(5):966-970

Groedel T., P. Gill and C. Weschler (1983). Effects of organic surface films on the scavenging of atmospheric gases by raindrops and aerosol particles. In: *Precipitation scavenging, dry deposition and resuspension.* v.1 Elsevier. pp. 417-431

Gucinski H., R.E. Baier, D.W. Goupil (1981). Sampling and composition of the surface microlayer. In: *Atmospheric pollutants in natural waters.* Ann Arbor Science.

Gucinski H. (1986). The effect of sea surface microlayer enrichment on TBT transport. *OCEANS' 86* 4:1266

Hamilton E.I. and R.J. Clifton (1979). Techniques for sampling the air-sea interface for estuarine and coastal waters. *Limn. Oceanog.* 24(1):188-193

Hardy J.T. (1982). The sea surface microlayer: biology, chemistry and anthropogenic enrichment. *Progr. Oceanog.* vol.11:307

Hardy J.T. and J. Apts (1984). The surface microlayer: phytoneuston productivity and effects of atmospheric particulate matter. *Mar. Biol.*

82:293-300

Hardy J.T., S. Kieser, L. Antrim, A. Stubin, R. Kocan, J. Strand (1987). The sea-surface microlayer of Puget Sound : Part I. Toxic effects on fish eggs and larvae. *Mar. Env. Res.* 23:227-249

Hardy J.T., S. kiesser, L. Antim, A. Stubin, R. Kocan and J. Strand (1987). Sea surface microlayer of Puget Sound. Parts I and II. *Mar. Env. Res.*

Hardy J.T., E. Crecelius, L. Antrim, V. Broadhurst, P. Boehm and W. Steinhauer (1987). Aquatic surface microlayer contamination in Chesapeake Bay. Maryland Power Plant Research Program, PPRP-1987.

Hardy J.T., J. Coley, L. Antrim and S. Kiesser (1988). A hydrophobic large-volume sampler for collecting aquatic surface microlayer : characterization and comparison with the glass plate method. *Can. J. Fish. Aquat. Sci.* v.44:822

Harvey G.W. (1966). Microlayer collection from the sea-surface: a new method and initial results. *Limn. Oceanog.* 11:608-613

Harvey G.W. and L.A. Burzell (1972). A simple microlayer method for small samples. *Limn. Oceanog.* 17(1):156-157

Hatcher R.F. and B.C. Parker (1974). Laboratory comparisons of four surface microlayer samplers. *Limn. Oceanog.* 19(1):162-165

Hodge V., S. Johnson and E. Goldberg (1978). Influence of atmospherically aerosols on surface ocean water composition. *Geochem. J.* v.12:7-20

Huhnerfuss H. (1981). On the problem of sea surface film sampling: a comparison of 21 microlayer-, 2 multilayer-, and 4 selected subsurface-samplers. Part I. *Marine Technology* 12:137-142

Hunter K. and P. Liss (1977). The input of organic material to the oceans: air-sea interactions and the organic chemical composition of the sea surface. *Mar. Chem.* 5:361-379

Hunter K.A. (1980). Processes affecting particulate trace metals in the sea surface microlayer. *Mar. Chem.* 9(1):49-70

Huzzey L. (1986). Lateral variability in a coastal plain estuary. V.I.M.S. dissertation

Jacobs T. (1978). Zooplankton distribution in the lower Chesapeake Bay. V.I.M.S. dissertation.

- Jarvis N. (1967). Adsorption of surface active material at the air-sea interface. *Limnol. Ocean.* 12:213-221
- Jullien D., G. Cauwet, J-C Marty, A. Saliot (1982). La matiere organique particulaire dans la microcouche de surface des eaux de mer, bilan, accumulation and complexation. *C.R. Acad. Sc. Paris*, t. 295. Serie II-367
- Kattner G.G., and U.H. Brockman (1978). Fatty- acid composition of dissolved and particulate matter in surface films. *Mar. Chem.* 6:233-241
- Kattner G.G., K. Nagel, K. Eberlein and K. Hammer (1985). Components of natural surface microlayers and subsurface water. *Oceanol. Acta* 8 n.2: 175
- Keller C.D. and T.F. Bidleman (1984). Collection of airborne PAH and other organics with a glass fiber filter-polyurethane foam system. *Atm. Env.* v.18 #4:837-845
- Kingsford M. and J. Choat (1986). Influence of surface slicks on the distribution and onshore movements of small fish. *Mar. Biol.* 91:161-171
- Kjelleberg S., T.A. Stenstrom and G. Odham (1979). Comparative study of different hydrophobic devices for sampling lipid surface films and

adherent microorganisms. *Mar. Biol.* 53:21-25

Knap A.H., K.A. Burns, R. Dawson, M. Ehrhardt and K.H. Palmork (1986).  
Dissolved/dispersed hydrocarbons, tarballs and the surface microlayer:  
experiences from an IOC/UNEP workshop in Bermuda, December, 1984. *Mar.*  
*Poll. Bull.* vol.17, N.7:313-319

Kocan R., H. von Westernhagen, M. Landolt, G. Furstenberg (1987). Toxicity  
of surface microlayer: effects of hexane extracts on Baltic Herring and  
Atlantic cod embryos. *Mar. Env. res.* 23:291-305

Langmuir I. (1938). Surface motion of water induced by wind. *Science* 87,  
n.2250:119-123

Larsson K., G. Odham and S. Sodergren (1974). On lipid surface films on the  
sea. Simple method for sampling and studies of composition. *Mar. Chem.*  
2:49-57

Ledet E.J. and J.L. Laester (1974). Alkanes at the air-sea interface from  
offshore Louisiana and Florida. *Science* 186:261-63

Leibovich S. (1980). Mixing the upper ocean layer by Langmuir circulation.  
*Ocean modelling* v.29:1-5



- Leibovich S. and S. Paolucci (1980). The Langmuir circulation instability as a mixing mechanism in the upper ocean. *J. Phys. Ocean.* 10:186-207
- Liss P. and P. Slater (1974). Flux of gases across the air-sea interface. *Nature*, v.247:181-184
- Liss, P.S. (1975). Chemistry of the sea-surface microlayer. In: *Chemical Oceanography*, J.P. Riley and G.S. Skirrow, editors, Academic Press, 2, 193-243
- MacIntyre F. (1974). Chemical fractionation and surface microlayer processes. In: *The Sea*. v.5 Mar. Chem. N. York, Wiley
- MacIntyre F. (1974). The top mm of the ocean. *Sci. Am.* 230(5):62-67
- MacIntyre W.G., C.L. Smith, J.C. Munday, V.M. Gibson, J.L. Lake, J.G. Windsor, J.L. Dupuy, W. Harrison and J.D. Oberholtzer (1974). *Investigation of surface films-Chesapeake Bay entrance*. EPA-670/12-73-099, Wash. D.C.. 168 pp.
- Mackay D. and P. Leinonen (1975). Rate of evaporation of low-solubility contaminants from water bodies to atmosphere. *Env. Sci. Technol.* v.9 n.13:1178-1181

Mackay D. and A. Yuen (1981). Transfer rates of gaseous pollutants between the atmosphere and natural waters. In: *Atm. Poll. in Nat. Waters*, Ann Arbor Sci. pp. 55-65

Mackay D. and A. Yuen (1983). Mass transfer coefficient correlations for volatilization of organic solutes from water. *Env. Sci. Techno.* v.17 n.4:211-217

Mackay D., S. Paterson and W. Schroeder (1986). Model describing the rates of transfer processes of organic chemicals between atmosphere and water. *Env. Sci. Techno.* v.20 n.8:810-816

Maguire R. and R. Kacz (1987). Concentration of TBT in the surface microlayer of natural waters. *Water Poll. Res. J. Canada* 22,n.2:227

Marty J. and A. Saliot (1976). Hydrocarbons in the surface microlayer of seawater. *Deep Sea Research* 23:863

McAlister J. and T. McLeish (1969). Heat transfer in the top millimeter of the ocean. *J. Geoph. Res.* 74:3408-3414

Nishizawa S. (1971). Concentration of organic and inorganic material in the surface skin at the Equator, 155° West. *Bull. Plank. Soc. Japan.*

18, n.2:42

Odham G., B. Noren, B. Norkans, A. Sodergren (1978). Biological and chemical aspects of the aquatic lipid surface microlayer. *Prog. chem. Fats other Lipids*. 16:31-44. Pergamon Press.

Oftad E.B., G. Lunde, H. Drangsholt (1979). Chlorinated organic compounds in the fatty surface film on water. *Intern. J. Environ. Anal. Chem.* 6:119-131

Parker H. and J. Barson (1970). Biological and chemical significance of surface microlayer in aquatic systems. *Bioscience* 20:87-93

Pattenden N.J., R.S. Cambray, K. Playford (1981). Trace and major elements in the sea-surface microlayer. *Geochim. Cosmochim. Acta* 45:93-100

Pitts J.N., Jr., D.M. Lokensgard, P.S. Ripley, K.A. van Cauwenberghe, L. van Vaeck, S.D. Shaffer, A.J. Thill, W.L. Belser, Jr. (1980). "Atmospheric" epoxidation of benzo(a)-pyrene-4,5-oxide. *Science*, 210:1347-1349

Fonnamperuma C. and N. Gabel (1968). Current status of chemical studies on the origin of life. *Space Fife Sc.* 1(1):64-96

- Provenzano A.J., Jr., J.R. McConaughy, K.B. Philips, D.F. Johnson and J. Clark (1983). Vertical distribution of first stage larvae of the blue crab Callinectes sapidus, at the mouth of the Chesapeake Bay. Estuar. Coast. Shelf Sci. 16, 489-499
- Rathbun R. and D. Tai (1981). Technique for determining the volatilization coefficients of priority pollutants in streams. Water research, v.15: 243-250
- Richardson S.L. (1975). Oregon's coastal ichthyoneuston: a preliminary report. Annual Meet. Amer. Assoc. Ichthyologist and Herpetologist, Williamsburg, VA, June 8-14.
- Riseborough, Huggett, Goldberg (1978). Pesticides: transatlantic movements in the northeast trades. Science, vol.159:1233-1236.
- Riznyk R.Z., J.T. Hardy, W. Pearson, L. Jabs (1987). Short-term effects of polynuclear aromatic hydrocarbons on sea-surface microlayer phytoneston. Bull. Env. Contam. Toxicol. 38:1037-1043
- Roberts M., M. Bemder, P. DeLisle, H. Sutton and R. Williams. Sex ratio and gamete production in American oysters exposed to TBT in the laboratory. Proc. Oceans '87 IEEE + MTS:1471-1476

Sehmel G.A. (1980). Particle and gas deposition: a review. *Atm. Env.* v.14:  
983-1011

Seba D. and E. Corcoran (1969). Surface slicks as concentrators of  
pesticides in the marine environment. *Pesticides Mon. Journal.*3:190

Shanks A.L. (1983). Surface slicks associated with tidally forced internal  
waves may transport pelagic larvae of benthic invertebrates and fishes  
shoreward. *Mar. Ecol. Prog. Ser.* 13, 311-315

Shanks, A. (1985). Behavioral basis of internal wave induced shoreward  
transport of megalopae of the blue crab *Pachygrapsus crassipes*. *Mar.*  
*Ecol. Prog. Ser.* 24:289

Slinn W.G. (1977). Some approximations for the wet and dry removal of  
particles and gases from the atmosphere. *Water, air and soil poll.*  
7(1977):513-543

Southworth G.R. (1979). The role of volatilization in removing PAH from  
aquatic environments. *Bull. Env. Contam. Toxicol.* 21:507-514

Sulkin S.D., E.S. Branscomb and R.E. Miller (1976). Induced winter spawning  
and culture of larvae of the blue crab, *Callinectes sapidus* Rathbun.

Aquaculture 8:103-113

Sutcliffe W., R. Sheldon, A. Prakash and D. Gordon (1971). Relations between wind, speed, Langmuir circulation and particulate concentration in the ocean. *Deep Sea Res.* 18:639-643

Strand J.W. and A.W. Andren (1980). Polyaromatic hydrocarbons in aerosols over Lake Michigan, fluxes to the lake. In: Polynuclear Aromatic Hydrocarbons: Chemistry and Biological Effects. Fourth International Symposium sponsored by U.S. E.P.A., Battelle Memorial Institute, Battelle's Columbus Laboratories, EPRI, Battelle Press, Columbus, OH, pp.127-137

Sutcliffe W., E. Baylor and D. Menzel (1963). Sea surface chemistry and Langmuir circulation. *Deep Sea Res.*, v.10:233-243

Szekielda K., S. Kupferman, V. Klemas and D. Polis (1972). Element enrichment in organic films and foam associated with aquatic frontal systems. *J. of Geoph. Res.* v.77, n.27:5278

Tsunogai S. and N. Tanaka (1980). Flux of oxygen across the air-sea interface as determined by the analysis of dissolved components in seawater. *Geochem. J.* 14:227-234

UNESCO (1985). IOC Manuals and guides, No. 15. Procedure for sampling the sea-surface microlayer.

Van Vleet E.S. and P.M. Williams (1980). Sampling sea surface films: a laboratory evaluation of techniques and collecting materials. *Limn. Oceanog.* 25(4):764-770

Van Vleet E.s. and P. Williams (1983). Surface potential and film pressure measurements in seawater system. *Limnol. Ocean.* 28(3):401-414

von Westernhazen H., M. Landot, R. Kocan, G. Furstenberg, D. Janssen, K. Kremling (1987). Toxicity of surface microlayer: effects on herring and turbot embryos. *Mar. Env. res.* 23:273-290

Wade T. L. and J.G. Quinn (1975). Hydrocarbons in the Sargasso Sea surface microlayer. *Mar. Poll. Bull.* 6, n.4:54-57

Webber D.B. (1983). Aerial flux of particulate hydrocarbons to the Chesapeake Bay estuary. *Mar. Poll. Bull.* 14:n.11:416-421

Wellander P. (1963). On the generation of wind streaks on the sea surface by action of surface film. *Tellus*, 15:67-71

Wheeler J.R. (1975). Formation and collapse of surface films. *Limn. Oceanog.* 20:338-342

Williams P.M. (1967). Sea surface chemistry: organic carbon and organic and inorganic nitrogen and phosphorous in surface films and subsurface waters. *Deep Sea Res.*, 14:791-800

Williams P.M. and K. Robertson (1975). Chlorinated hydrocarbons in sea surface films and sub-surface waters at nearshore stations and in the North Central Pacific Gyre. *Fish. Bull.* 73:445

Williams P.M., E. Van Vleet and C. Booth (1980). In situ measurements of surface microlayer potentials. *J. of Mar. Res.* 38, n.2:193-203

Williams P.M., D. Long, C. Price, K. Robertson and E. Van Vleet (1982). A mobile platform for studying surface microlayer. *Deep Sea Res.* 29, n.5A: 641-646

Williams P.M., A.F. Carlucci, S.M. Henrichs, E.S. Van Vleet, S.G. Horrigan, F.M.H. Reid and K.J. Robertson (1986). Chemical and microbiological studies of the sea-surface films in the southern Gulf of California and off the west coast of Baja California. *Mar. Chem.* 19, No.1:17-98



Williams R.M. (1981). Exchange of particles and gases across water surfaces.

In: *Atm. Poll. in Nat. Waters*, Ann Arbor Sci. pp.67-78

Word J.Q., J. T. Hardy, E. Crecelius and S. Kiesser (1987). A laboratory study of the accumulation and toxicity of contaminants at the sea surface from sediments proposed for dredging. *Mar. Env. res.* 23:325

You F. and T.F. Bidleman (1984). Influence of volatility on the collection of PAH vapors with polyurethane foam. *Env. Sci. Tech.* v.18 #5:330-333

Zaistev, Y.P. *Marine Neustonology* (1971). (Translated from russian). Nat. Mar. Fish. Serv. NOAA + NSF, Washington, D.C. 207 pp.