



W&M ScholarWorks

Reports

1-1-2006

Abundance, Biomass and Size Structure of Eastern Oyster and Hooked Mussel on a Modular Artificial Reef in the Rappahannock River, Chesapeake Bay

Rom Lipcius
VIMS

Russell P. Burke
Virginia Institute of Marine Science

Follow this and additional works at: <https://scholarworks.wm.edu/reports>

 Part of the [Marine Biology Commons](#)

Recommended Citation

Lipcius, R., & Burke, R. P. (2006) Abundance, Biomass and Size Structure of Eastern Oyster and Hooked Mussel on a Modular Artificial Reef in the Rappahannock River, Chesapeake Bay. Special Reports in Applied Marine Science and Ocean Engineering (SRAMSOE) No.390. Virginia Institute of Marine Science, William & Mary. <https://doi.org/10.21220/V5X752>

This Report is brought to you for free and open access by W&M ScholarWorks. It has been accepted for inclusion in Reports by an authorized administrator of W&M ScholarWorks. For more information, please contact scholarworks@wm.edu.

Abundance, Biomass and Size Structure of Eastern Oyster and Hooked Mussel on a Modular Artificial Reef in the Rappahannock River, Chesapeake Bay*

Romuald N. Lipcius and Russell P. Burke



Special Report in Applied Marine Science and Ocean Engineering
No. 390

Virginia Institute of Marine Science
The College of William and Mary
Gloucester Point, Virginia 23062

January 2006

* This report is based on an unpublished manuscript: Burke, R.P. and R.N. Lipcius. Abundance, biomass and size structure of Eastern oyster and hooked mussel on a novel artificial reef in lower Chesapeake Bay (20 January 2006). Contact R.N. Lipcius (rom@vims.edu), Virginia Institute of Marine Science, Gloucester Point, VA 23062, for further information.

ABSTRACT: Restoration efforts with native Eastern oyster, *Crassostrea virginica*, in Chesapeake Bay have been extensive, and there has been a continuing search for reef structures that will be effective under a range of environmental conditions. We quantified population structure, density, abundance and biomass of Eastern oyster and hooked mussel, *Ischadium recurvum*, on a novel concrete modular reef deployed subtidally (~ 7 m depth) in the lower Rappahannock River during October, 2000. The reef provided 3-D architectural complexity, substrate stability, and extensive surface settlement area (nearly 75 m² of reef surface over 5 m² of river bottom). Upon deployment, the reef was neither seeded with oyster spat nor exploited. After 4 ½ years of deployment (May 2005), we took 120 stratified random samples over the reef. The reef had been colonized heavily by oysters and mussels, which recruited and survived at densities per m² of reef surface area ranging from 28-168 for oysters and from 14-2177 for mussels. These surface densities on the modular reef translate to 1085 oysters and 8617 mussels per m² of river bottom, which are among the highest recorded for natural and restored oyster reefs. Hence, the reef supported about 10,000 suspension-feeding bivalves per m² of river bottom. The size structure of oysters indicated the presence of four year classes, with approximately half of all oysters more than two years old and therefore of reproductive age. Oyster density per m² of reef surface area was positively correlated with mussel density up to 2000 mussels per m², after which oyster density declined somewhat. This reef apparently provides an architecture that is conducive for settlement, growth and survival of the Eastern oyster and hooked mussel in suitable subtidal habitats, and which should therefore be considered as a viable alternative reef structure for Eastern oyster restoration.

KEY WORDS: Oyster restoration · Oyster reef · Artificial reef · Eastern oyster · *Crassostrea virginica* · Hooked mussel · *Ischadium recurvum* · Chesapeake Bay

INTRODUCTION

Restoration of the Eastern Oyster, *Crassostrea virginica*, in Chesapeake Bay has become a multi-agency effort with local, state, and federal partners. Numerous oyster shell mounds have been created in an attempt to mimic natural reef conditions and accelerate oyster recruitment to those systems. Within the last decade, substrates other than oyster shell, including surf clam shells, porcelain toilets and pelletized coal ash, have been used experimentally as alternative substrate (Nestlerode 2004).

European countries have been experimenting with various types of artificial reefs over the last 30 years. Often, such reefs serve a dual purpose, either as alternative fish or bivalve habitat or as an outlet for excess materials produced by industry (e.g. pelletized coal ash). For instance, at least 11 artificial reefs exist along the Italian Adriatic coast (Bombace et al. 2000). Seven of these (Cattolica, Porto Garibaldi 1, Portonovo 1 and 2, Porto Recanati, Rimini, Senigallia) serve as the best European examples to date of reefs that have provided successful commercial harvests, especially of bivalves, and which are used both by fishers and by aquaculturists (Jensen 2002).

The Porto Recanati reef, deployed in 1974, was the first Italian reef to be planned scientifically (Bombace et al. 1989). The aims of the scheme were protection from illegal trawling, repopulation of biota through the provision of habitat, and enhancement of harvestable sessile biomass, especially mussels and oysters, through the introduction of suitable surfaces. The initial costs were recovered three times over in about four years through small-scale fisheries and collection of the mussels settled on the artificial substrata (Bombace et al. 1994).

Portonovo 1 reef was used for experimental work on suspended shellfish culture (mussels and oysters; Fabi & Fiorentini 1997; Fabi et al. 1986). On this oyster reef, species richness, species diversity, and fish abundance increased after reef deployment (Fabi & Fiorentini 1994), particularly for reef-dwelling nekto-benthic species (e.g. Sparids and Sciaenids). Three years after deployment, the increase in average catch weight for these species was 10–42 times the initial values. The increment was positively correlated with reef dimension in terms of volume of immersed materials, and inversely correlated with distance between the oases. The reefs also had higher catch rates of reef-dwelling fish in comparison with unprotected areas (Fabi 1999), and seemed to be “buffered” against significant reduction compared to stocks in areas without reefs (Fabi & Fiorentini 1993). In eutrophic waters, annual settlement of bivalves on these structures provides mariculture opportunities for coastal communities; annual production was measured as 8 kg of mussels per m of rope (Fabi & Fiorentini 1990).

In Portugal, reefs were deployed off the island of Madeira and near the mainland (Neves dos Santos & Costa Monteiro 1997). The Madeira reefs used car bodies, tires, and wooden boats to enhance fishery harvests, but recently there has been a shift to deploy reef modules following baseline assessment of fish diversity and biomass. On the mainland, there were two reefs off the Ria Formosa, an estuarine system on the Algarve coast. There were two reef types, a “production reef” and an “exploitation” reef.

The production reef (735 concrete lattice units each 2.7 m³) was deployed to provide shelter for juveniles migrating from the lagoon to open coastal water. The exploitation reef (20 concrete structures in two sizes, 130 m³ and 174 m³) was placed further from the lagoon mouth to aggregate fish. The structures were physically stable, developed an epibiotic community within months, and concentrated fish (Neves dos Santos & Costa Monteiro 1998; Costa Monteiro & Neves dos Santos 2000). The success of these reefs led to the development of a much larger reef system for commercial exploitation, involving a 35-km² area of seabed off the Algarve coast, using more than 19,000 modules with a combined weight of 66,690 t, which represented one of the largest artificial reef systems in Europe.

The preceding examples demonstrate that alternative reef structures providing the stability and complexity of natural reefs can lead to higher abundance, biomass and diversity of species under restoration. In October 2000, a substantial rebar-reinforced concrete modular reef was deployed subtidally (~7 m depth) near the mouth of the Rappahannock River, a western-shore tributary of Chesapeake Bay. The designer, a retired engineer for the United States Navy (Captain Robert Jensen), intended to provide suitable substrate for Eastern oyster in a high-flow, low-siltation habitat. In this report, we document density, abundance, biomass and size structure of Eastern oyster (*Crassostrea virginica*) and hooked mussel (*Ischadium recurvum*) on the modular reef.

This report provides a summary of the major results of the sampling of the reef structure. Further details are available in the associated manuscript: Burke, R.P. and R.N. Lipcius, Abundance, biomass and size structure of Eastern oyster and hooked mussel on a novel artificial reef in lower Chesapeake Bay, 20 January 2006. [Contact R.N. Lipcius (rom@vims.edu), Virginia Institute of Marine Science, Gloucester Point, VA 23062, for further information.]

MATERIALS AND METHODS

Sampling Procedure and Design. The modular reef was located at Steamer Rock in the Rappahannock River, and consisted of five Module Layers (ML, see one ML in Figure 1) stacked on each other, with four faces (top, side, hole, bottom) per ML. Due to logistical constraints, we were only able to sample the top three layers. However, a commercial diver indicated that the lowest two layers appeared equivalent in oyster and mussel abundance to the upper three layers. The three layers were secured simultaneously with straps by a commercial diver and brought to the surface by a crane aboard a commercial barge (Figure 2); the set of three layers was placed on the deck of the barge for sampling (Figure 3). To access all faces on each ML, the crane on the commercial barge lifted one ML off the lower ML until all samples were collected. Upon completion, the layers were stacked in order on board the barge and returned to the site on the river bottom. Documentation of the reef recovery and sampling procedures was compiled the day of removal (27 May 2005) through photography and videography.

The modular reef was sampled using a stratified random sampling design (Appendix 1) following Cochran (1977) and Williams et al. (2002). Two stratum types were defined, Module Layer (ML) and Face (F). The surface area for each face was calculated using a schematic (Figure 1) provided by Reeftek-McLean. All potential sample plots for each ML-F combination (Appendix 1) were calculated with Microsoft Excel[®] 2000; sample plots were selected using random numbers generated by Excel. On site, surface area of each sample was defined using a 25.4 cm x 25.4 cm quadrat (2.54 cm x 2.54 cm Riverdale mesh). A total of 120 samples (each approximately 7.250 m²) was collected; 10 samples were taken from each of the 12 ML-F combinations.

Upon removal of the three MLs, it became apparent that the lifting straps had removed epifauna at each strap-reef interface. Sample plots that were impacted by the straps were discarded and the next random plot selected. Epifauna were removed from each plot with hand scrapers, placed in large trays, and stored in large freezer bags on ice.

Laboratory Processing. Samples were processed in the laboratory in increments of 24 samples (3 MLs x 4 Fs x 2 replicates). The first 24 samples were haphazardly selected from freezer storage. Each sample was thawed and rinsed over a 1-mm mesh sieve. Bivalve (oyster and mussel) and sponge volume were measured using volumetric displacement. Shell height (SH), width, and depth were measured for all bivalves, living and dead. For oysters, SH was considered as the distance from the umbo to the farthest posterior end of the shell. Additionally, all internal tissues were collected for each oyster in pre-weighed aluminum weigh boats for dry mass (DM) and ash-free dry mass (AFDM) measurements. Of the 924 mussels collected, 138 mussels representing the full range of SH values were processed for DM and AFDM.

Condition Indices (CIs; Mercado-Silva 2005) were calculated for most of the 108 oysters collected. All oysters were cleaned of fouling organisms and washed with tap water. After cleaning, oysters were blotted dry before being measured. Measurements made on each oyster included total mass (nearest 0.001 g), total length (SH, nearest 0.1 mm), and wet shell mass (nearest 0.001 g). After shucking, shells and tissue were dried at 60°C for at least 48 h and weighed. The following condition indices were calculated:

$CI_1 = [\text{dry tissue weight (g)} / \text{shell cavity volume}] \times 100$ (Abbe & Albright 2003)

$CI_2 = [\text{dry tissue weight (g)} / \text{dry shell cavity volume}] \times 100$ (Abbe & Sanders, 1988)

$CI_3 = [\text{dry tissue weight (g)} / \text{dry shell weight (g)}] \times 100$ (Rainer & Mann 1992)

These indices are considered to be the most accurate indicators of condition (Hickman and Illingworth 1980, Davenport and Chen 1987). For CI_1 and CI_2 , shell cavity volume is equal to the difference between the mass of the whole oyster (g) and the mass of the empty valves (g) (Abbe & Sanders 1988, Crosby & Gale 1990). CI_1 considered the mass of the empty shells immediately after shucking whereas CI_2 used the mass of the shells after a period of drying (Abbe & Albright 2003). For all analyses, condition indices were used where shell volume was calculated by a gravimetric method. These measures are linearly related to those where CI is calculated by a volumetric method (i.e. by water displacement of the shells, Schumacker et al. 1998). Of the remaining 96

samples, volume was measured as indicated previously. SH was measured for all oysters. Live and dead mussels were counted but SH was not measured.

Population Structure. In the analysis of size structure for oysters we used all 120 samples (523 oysters), whereas for mussels we used only the first 24 samples (924 mussels). Peaks were analyzed with FISAT II (Gayaniolo et al. 2000) to delineate individual year classes. The peaks were separated using Bhattacharya's Method (Bhattacharya 1967). The program uses a set of equations that yields mean lengths, population sizes (in numbers), standard deviations and separation indices (SI) for each year class, where SI is the difference between two successive means divided by the difference between their estimated standard deviations.

Density Estimates. The number of oysters and mussels per plot were calculated for each ML and F. Confidence bounds were calculated using an estimator based on a stratified random sampling design with unequal sample areas (Williams et al. 2002).

Biomass Estimates. The DM data for oysters and mussels was used in a length-weight regression to estimate biomass over the entire 5-ML reef, assuming the size structure produced from all 120 samples was consistent with the size structure produced from the first 24 samples. Biomass estimates were also derived from density data; both methods produced similar results.

Pathology. Thirty large oysters (75.6-125.2 mm SH) were haphazardly sampled from the different ML faces for pathology tests performed within two weeks of sampling. Samples were brought back to the Pathology group at VIMS live and on ice. Presence and concentration of Dermo (*Perkinsus marinus*) and MSX (*Haplosporidium nelsoni*) were determined. A number of other parasites and pathogens commonly found in oyster tissue, but not generally associated with serious disease and mortality, were noted. These included *Nematopsis*, Rickettsia-like organisms, *Sphenophyra*-like ciliates, *Stegotricha* ciliates, and viral gametocytic hypertrophy.

RESULTS

Population Structure. A total of 520 of the possible 523 oysters was used in the size-structure analysis (Figure 4a). Oyster SH ranged from 7.1 to 139.0 mm, with a maximum of four year classes (2001-2004) since the reef was deployed in 2000 at the end of the settlement season and sampled in May 2005 before the 2005 settlement season. The four peaks that were distinguished from the composite distributions (Figure 4b) indicated that approximately half of all oysters were 2+ years of age and of reproductive age. The mussel PSS (Figure 5) produced a conglomeration of several intermixed year classes spanning the range of mussel SHs (9.2 to 61.0 mm).

Density and Abundance. Oyster density and mussel density (Table 1) were analyzed across Module Layer and Face using a two-factor ANOVA model. Oyster density differed significantly by Face ($p < 0.0005$) with highest densities on the top of the

module layers. There was no effect of Module Layer ($p = 0.926$) and no interaction effect between Face and Module Layer ($p = 0.701$). Oysters and mussels recruited and survived at densities per m^2 of reef surface area ranging from 28-168 for oysters and from 14-2177 for mussels. These surface densities on the modular reef translated to 1085 oysters and 8617 mussels per m^2 of river bottom (See Table 2 for reef surface areas per 5 m^2 of river bottom). Oyster and mussel densities were significantly and positively correlated up to approximately 2000 oysters per m^2 , after which oyster density declined somewhat as mussel density increased further (Figure 6, $p < 0.0005$, $r^2 = 0.46$).

Biomass and Abundance. Biomass was estimated for oysters and mussels using simple linear regression of shell height-dry mass (SH-DM) data. Both regressions were highly significant ($p < 0.0005$; $r^2 > 0.84$). Oyster and mussel biomass values were high, 1.643 kg and 0.67 kg per m^2 of river bottom, respectively.

Pathology. Of the thirty large oysters processed for disease assessment, none were infected with MSX and 30 % were infected with Dermo. Of the nine oysters infected with Dermo, none had serious infections (four infections were light and five were rare). The following pathogens were found in one or more oysters: *Nematopsis* (1), Rickettsia-like organisms (1), *Sphenophyra*-like ciliates (11), *Stegotricha* spp. Ciliates (1), and viral gametocytic hypertrophy (1).

Condition Index. Sixty-two oysters throughout the full size range were processed to yield three CIs documented in the literature (Rainer & Mann 1992). There was no difference in any of the CIs as a function of Face or Module Layer. The mean CI values for the three indices were 12.2, 8.8 and 6.0, respectively, which are all near the upper end of reported CI values (Rainer & Mann 1992).

CONCLUSIONS

The oyster population on the modular reef in the lower Rappahannock River was relatively free of disease, in good physiological condition, and composed of four year classes. The estimated collective density of 1085 oysters and biomass of 1.643 kg per m^2 of river bottom are among the highest recorded for natural and restored oyster reefs. In addition, on the reef there were approximately 8617 mussels per m^2 of river bottom, such that the modular reef supported about 10,000 suspension-feeding bivalves per m^2 of river bottom. The size structure of oysters indicated that of the four year classes present on the reef, approximately half of all oysters were more than two years old and therefore of reproductive age. Moreover, oyster density per m^2 of reef surface area was positively correlated with mussel density up to 2000 mussels per m^2 , after which oyster density declined somewhat. Consequently, the modular reef provides an architecture that is conducive for settlement, growth and survival of the Eastern oyster and hooked mussel, when located in environmentally suitable habitats. Artificial reefs of this type of structural design should therefore be considered as viable alternative reefs in Eastern oyster restoration efforts.

Acknowledgements. We express appreciation to Captain Robert W. Jensen, the Rappahannock Preservation Society, Reeftek, Richard Hoffman and McLean Contracting Company, David Bushey and Commonwealth Pro-Dive, Ryan Carnegie and Gene Burreson of the VIMS Pathology Group, and Roger Mann, Juli Harding and Melissa Southworth of the VIMS Molluscan Ecology Group for their assistance, advice and support. Special thanks go to the students and staff of the Marine Conservation Biology Program at VIMS, particularly Jacques van Montfrans and Katie Knick, for their assistance in the lab and field. Funding was provided by grants to R.N. Lipcius and R.D. Seitz from (1) the Chesapeake Bay Office of the National Oceanic and Atmospheric Administration through the Blue Crab Advanced Research Consortium and (2) the Norfolk Office of the Army Corps of Engineers (D. Schulte, program manager).

LITERATURE CITED

- Abbe GR, Sanders JG (1988) Rapid decline in oyster condition in the Patuxent River, Maryland. *J Shellfish Res* 7:57-59
- Abbe GR, Albright BW (2003) An improvement to the determination of meat condition index for the Eastern Oyster *Crassostrea virginica* (Gmelin 1791). *J Shellfish Res* 22:747-752
- Bhattacharya CG (1967) A simple method of resolution of a distribution into Gaussian components. *Biometrics* 23:115-135
- Bombace G (1989) Artificial reefs in the Mediterranean Sea. *Bull Mar Sci* 44:1023-1032
- Bombace G, Fabi G, Fiorentini L, Speranza S (1994) Analysis of the efficacy of artificial reefs located in five different areas of the Adriatic Sea. *Bull Mar Sci* 55:559-580
- Bombace G, Fabi G, Fiorentini L (2000) Artificial reefs in the Adriatic Sea. *In* Artificial Reefs in European Seas, 31-64. Ed. by AC Jensen, KJ Collins, and APM Lockwood. Kluwer. 508 pp
- Cochran WG (1977) Sampling techniques. Wiley, New York
- Costa Monteiro C, Neves dos Santos M (2000) Portuguese artificial reefs. *In* Artificial Reefs in European Seas, 249-262. Ed. by AC Jensen, KJ Collins, and APM Lockwood. Kluwer. 508 pp
- Crosby MP, Gale LD (1990) A review and evaluation of bivalve condition index methodologies with a suggested standard method. *J Shellfish Res* 9:233-237
- Davenport J, Chen X (1987) A comparison of methods for the assessment of condition in the mussel (*Mytilus edulis* L.). *J Moll Stud* 53:293-297
- Fabi G, Fiorentini L (1990) Shellfish culture associated with artificial reefs. *FAO Fish Rep* 428:99-107
- Fabi G, Fiorentini L (1993) Catch and growth of *Umbrina cirrosa* (L.) around artificial reefs in the Adriatic Sea. *Boll Oceanol Teor Applic* 11:235-242
- Fabi G, Fiorentini L (1994) Comparison of an artificial reef and a control site in the Adriatic Sea. *Bull Mar Sci* 55:538-558
- Fabi G, Fiorentini L (1997) Molluscan aquaculture on reefs. *In* European Artificial Reef Research, 123-140. Ed. by AC Jensen. Southampton Oceanography Centre. ISBN 0-904175-28-6. 449 pp

- Gayanilo Jr. FC, Sparre P, Pauly D (2002) FISAT II version 1.2.0. Food and agriculture Organization (FAO) of the United Nations, Rome
- Hickman RW, Illingworth J (1980) Condition cycle of the green-lipped mussel *Perna canaliculus* in New Zealand. *Mar Biol* 60:27-38
- Jensen, AC (2002) Artificial reefs of Europe: perspective and future. *ICES J Mar Sci* 59:S3-S13
- Mercado-Silva N (2005) Condition index of the Eastern Oyster *Crassostrea virginica* (Gmelin 1791) in Sapelo Island Georgia—effects of site, position on bed and peacrab parasitism. *J Shellfish Res* 24:121-126
- Nestlerode JA (2004) Evaluating restored oyster reefs in Chesapeake Bay: How habitat structure influences ecological function. PhD dissertation Virginia Institute of Marine Science, The College of William and Mary, Gloucester Point, Virginia
- Neves dos Santos, M, and Costa Monteiro C (1997) The Olhão artificial reef system (south Portugal): fish assemblages and fishing yield. *Fish Res* 30:33-41
- Neves dos Santos, M, Costa Monteiro C and Lasse`rre G (1997) A four-year overview of the fish assemblages and yield on two artificial reef systems off Algarve (south Portugal). *In Responses of Marine Organisms to Their Environments*, 345-352. Ed. by LE Hawkins, S Hutchinson, AC Jensen, M Sheader, and JA Williams. Proceedings 30th European Marine Biology Symposium, Southampton. Southampton Oceanography Centre. 362 pp
- Neves dos Santos, M, and Costa Monteiro C (1998) Comparison of the catch and fishing yield from an artificial reef system and neighbouring areas off Faro (south Portugal). *Fish Res* 39:55-65
- Rainer JS, Mann R (1992) A comparison of methods for calculating condition index in Eastern oysters *Crassostrea virginica* (Gmelin 1791). *J Shellfish Res* 11:55-58
- Schumacker EJ, Dumbauld BR, Kauffman BE (1998) Investigations using oyster condition index to monitor the aquatic environment of Wilapa Bay Washington. *J Shellfish Res* 17:338-339.
- Williams BK, Nichols JD, Conroy MJ (2002) Analysis and Management of Animal Populations. Academic Press. San Diego, California 92101-4495, USA

Table 1. Oyster and mussel density by Module Layer-Face stratum combination.

Module Layer (ML)	----Face----							
	Top		Side		Hole		Bottom	
	Oyster	Mussel	Oyster	Mussel	Oyster	Mussel	Oyster	Mussel
ML-5 (Top)	168	1717	28	169	60	211	35	14
ML-4 (Near Top)	151	2177	33	123	68	727	51	36
ML-3 (Middle)	159	1086	56	141	37	540	32	23
Total	478	4980	117	433	165	1478	118	73

Table 2. Surface area (m²) of the modular reef system.

Face	Area (m ²)
Top	3.107
Side	2.890
Hole	5.729
Bottom	3.107
Total/Module	14.834
Reef Total	74.168

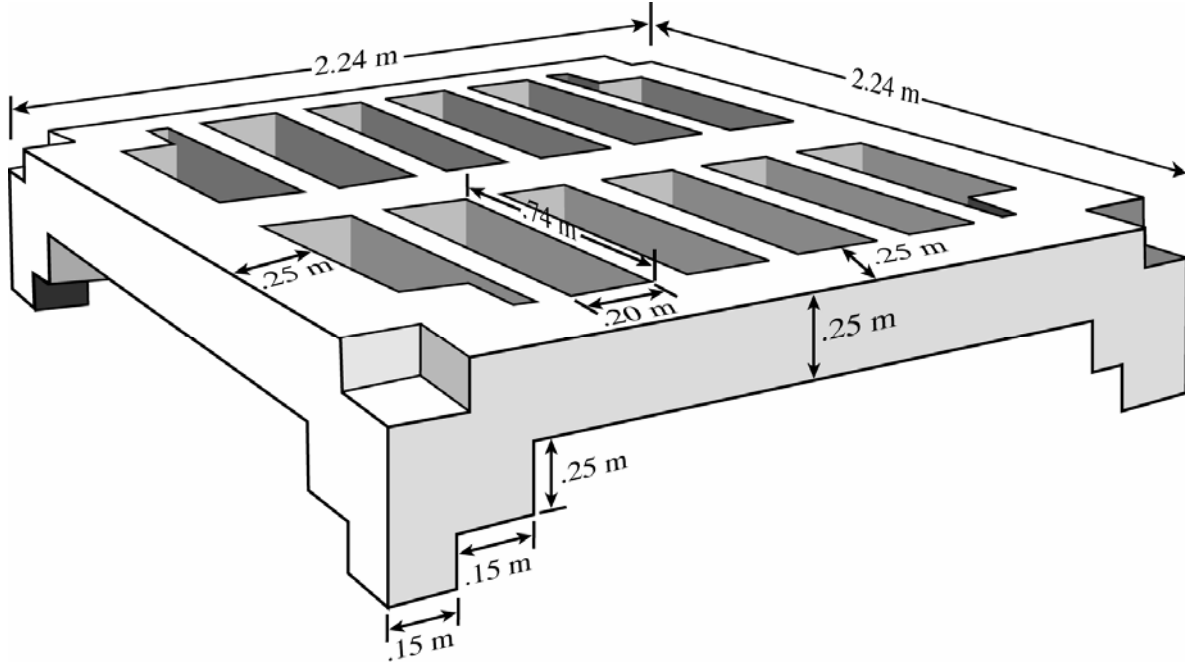

Figure 1. Schematic design of a single module. Five modules were stacked and deployed subtidally (~7 m depth) in the Rappahannock River, Virginia in October 2000.



Figure 2. Recovery of the top three layers of the modular reef in May, 2005.



Figure 3. Top three layers of the modular reef recovered in May, 2005 and from which 120 samples were collected.

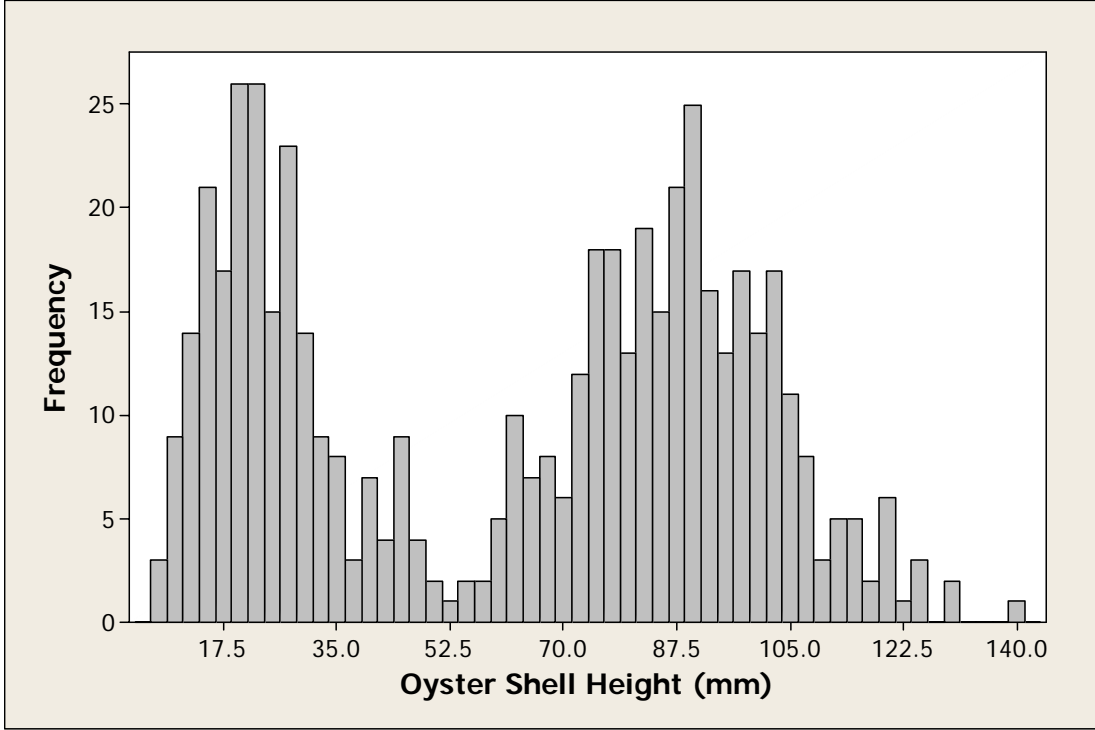

Figure 4a. Population structure of oysters on the modular reef system.

FiSAT 2: FAO-ICLARM Stock Assessment Tools
 Separation of Normal Distributions Using Bhattacharya's
 Method of Decomposing Composite Distributions

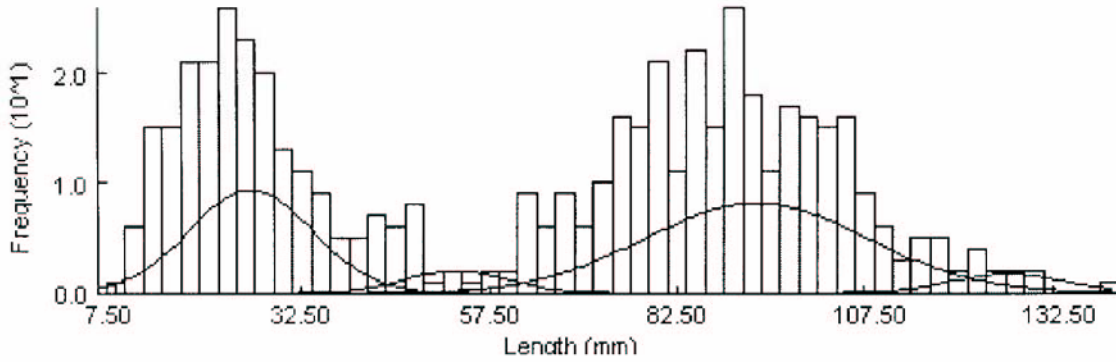

Figure 4b. Separation of length-frequency data into individual year classes.

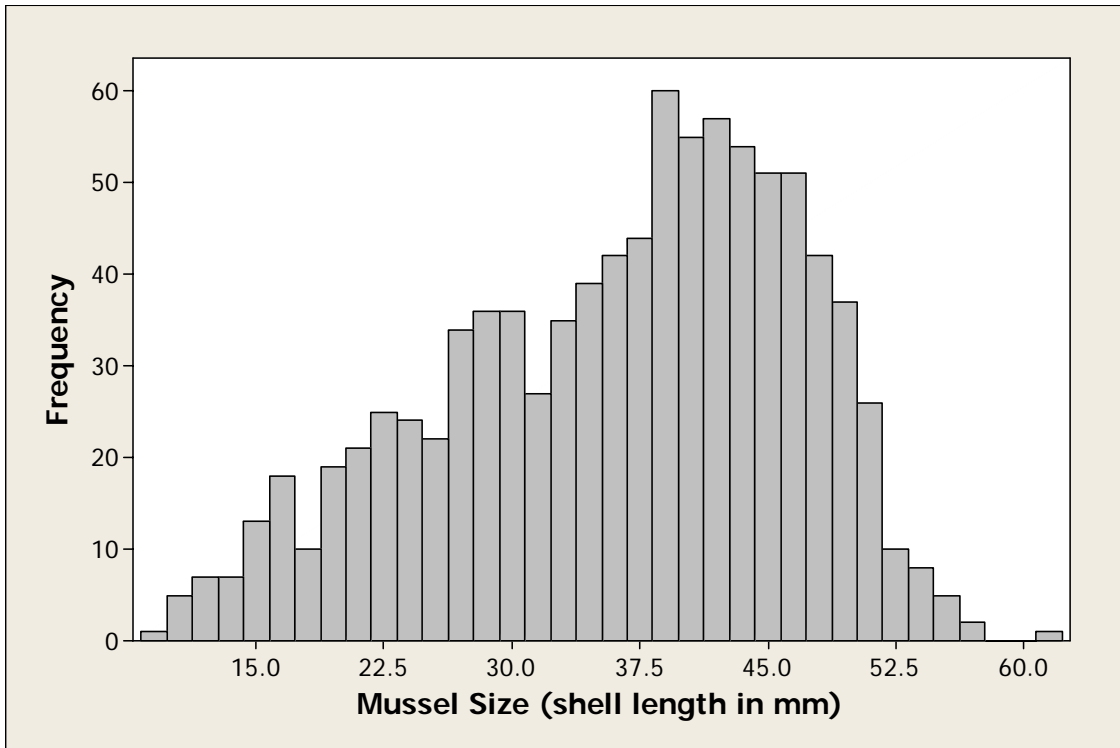

Figure 5. Population structure of mussels on the modular reef system.

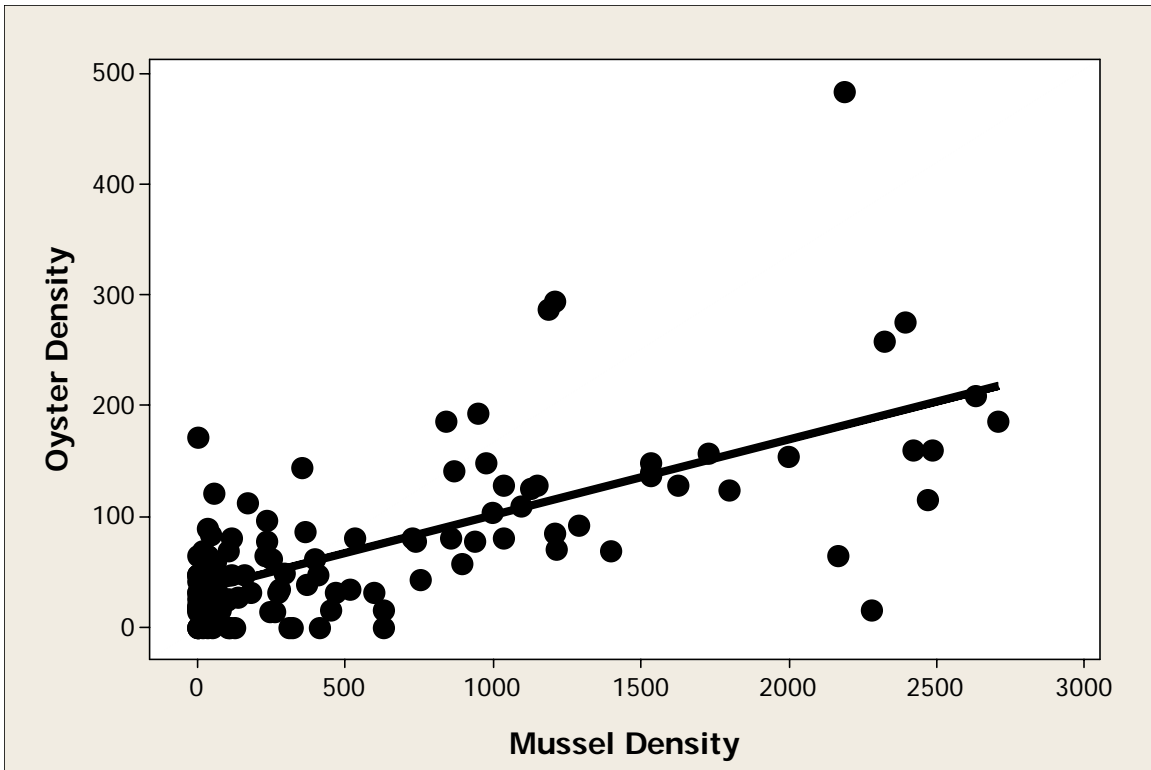
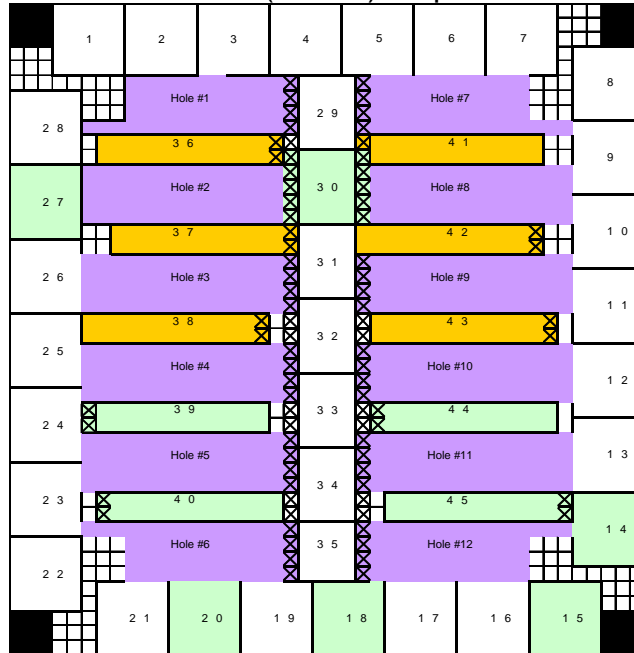

Figure 6. Regression of Oyster Density (no. m⁻²) versus mussel density (no. m⁻²)

APPENDIX

Appendix 1. Examples of Stratified Random Sampling Design.

Module 3 (Middle): Top Face



Module 3 (Middle): Bottom Face

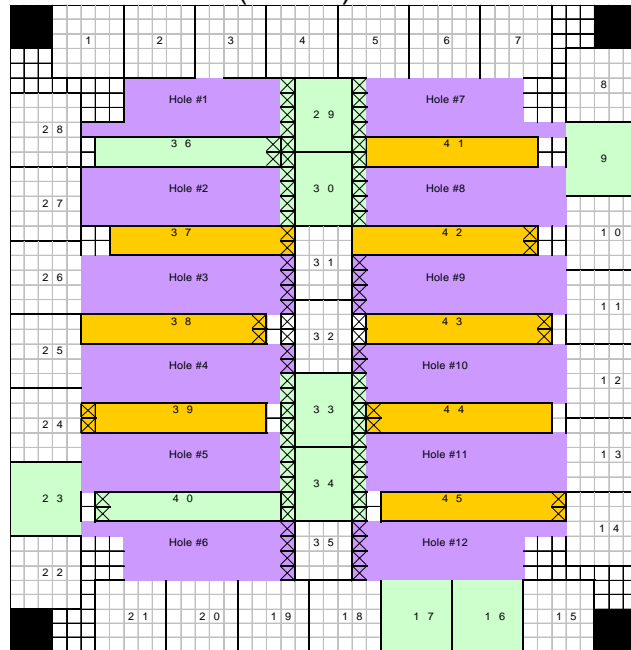

Module 3 (Middle): Side Face (North)

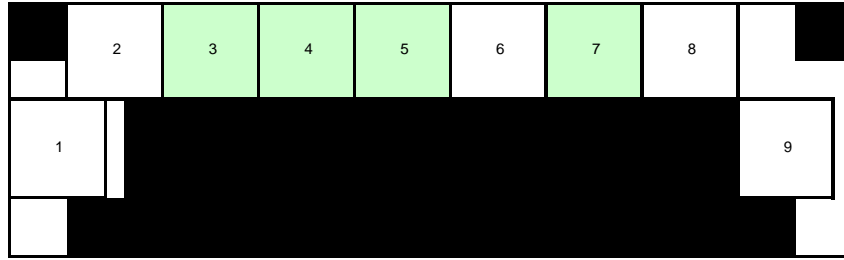

Module 3 (Middle): Side Face (East)



Module 3 (Middle): Side Face (South)

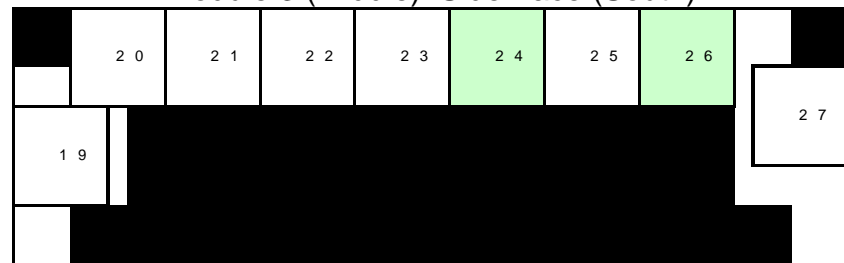

Module 3 (Middle): Side Face (West)

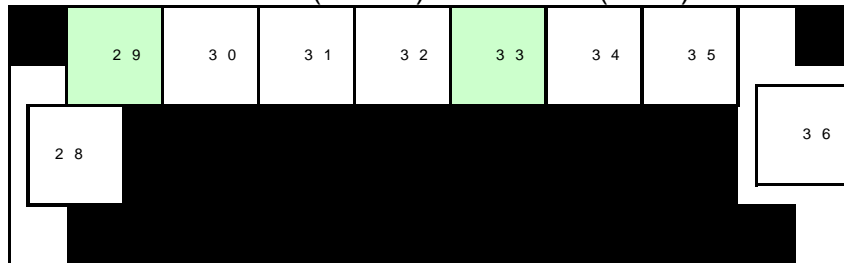

Module 3 (Middle): Hole Face

1	1	2	3	4	5	6	7	8
2	9	10	11	12	13	14	15	16
3	17	18	19	20	21	22	23	24
4	25	26	27	28	29	30	31	32
5	33	34	35	36	37	38	39	40
6	41	42	43	44	45	46	47	48
7	49	50	51	52	53	54	55	56
8	57	58	59	60	61	62	63	64
9	65	66	67	68	69	70	71	72
10	73	74	75	76	77	78	79	80
11	81	82	83	84	85	86	87	88
12	89	90	91	92	93	94	95	96