

# The Effect of Quarter-wave Transformer Matching Network to The X-Circular Polarized Antenna

M.Z.A. Abd. Aziz<sup>1</sup>, N.A.A. Muffit<sup>1</sup>, M.K. Suaidi<sup>1</sup>, M.K.A. Rahim<sup>2</sup>

<sup>1</sup>Center for Telecommunication Research and Innovation (CeTRI), Faculty of Electronic and Computer Engineering, Universiti Teknikal Malaysia Melaka (UTeM), Malaysia

<sup>2</sup>Faculty of Electrical Engineering, Universiti Teknologi Malaysia (UTM), Malaysia  
mohamadzoinol@utem.edu.my

**Abstract**—This technical paper presents the 2 design of x-circular polarized with slanted rectangular slot microstrip patch antenna by using single port in X-form is at 45°, 135°, 225° and 315°. The combination of 4 circular patches of Design 1 and the additional of quarter wave impedance matching technique for Design 2 have been used to design the X-circular polarized with slanted rectangular slot microstrip patch antenna. The designs are simulated using Computer Simulation Technology (CST) with dielectric constant,  $\epsilon_r=4.3$  and  $\tan \delta=0.019$  and thickness of substrate,  $t=1.6\text{mm}$ . The simulation results such as return loss, bandwidth, gain, directivity and polarization have been compared.

**Index Terms**—circular polarized, x-circular polarized, quarter-wave transformer, microstrip antenna.

## I. INTRODUCTION

The development of wireless communication system has been rapidly growth in this era with increasing demand in the level of enhancement and performance. The concepts of Multiple Input Multiple Output (MIMO) system have been used since 1980's. They were first investigated by using computer simulation [1] and later many researchers explore about MIMO system [2]. In features, MIMO can be a very important technology in wireless systems which is required high data rates such as wireless local area network (WLAN's), broadband wireless access network (WiMaX) and third and fourth generation cellular networks (3G and 4G) [1].

Types of polarizations are linear polarization, circular polarization, dual-polarization and others. The coupled patches, slot and single fed are the popular method for linear polarization [3][4][5]. Circular polarization can occur when two different signals of equal amplitude with 90° phase shifted excite simultaneously into same radiator. The circular polarization antenna can be designed by using techniques such as slotted, double layer, aperture coupled patch, single feed and double feed [7]-[10]. Nowadays, the dual polarization transmission has been important in polarization diversity system because its ability to enhance system performance. Furthermore, the dual polarization transmission can combat multipath effect on wireless communication. Polarization diversity is a combination of antennas with orthogonal

polarization either in horizontal or vertical combination,  $\pm 45^\circ$  combination or left or right hand combination [11][12].

Impedance matching is important in order to minimize the signal losses and maximized power transmission to the load. Impedance matching can improve the signal to noise ratio of the system. Thus, the amplitude and phase errors can be reduced [13]. The dual polarization antenna design can be obtained by using either two probe feed as proposed by G.S. Row [14] or a single port inset feed technique as proposed in [15].

$$\Gamma = \frac{Z_L - Z_0}{Z_L + Z_0} \quad (1)$$

Based on reflection coefficient ( $\Gamma$ ) equation above, the miss match between the load impedance ( $Z_L$ ) and transmission line characteristic impedance ( $Z_0$ ) will increase the reflected wave [15]. Thus, the efficiency of the power transmission between the signal generator and load will be reduced as well. So, there is very important to make sure the  $Z_L$  and  $Z_0$  in matched condition by using matching network.

## II. DESIGN

### A. Design 1 (without matching)

Figure 1 shows x-circular polarized with slanted rectangular slot without matching technique.  $D$  is the diameter of the circular patch 15.58mm. A rectangular slanted slot with  $L$  is length of slot 7.8mm and  $w$  is the width of slot 1mm is located at the center of the circular patches.  $A_1$  and  $A_2$  are length and width of 50 $\Omega$  feedline where  $A_1$  is 43.7mm or  $\frac{\lambda}{2}$  and  $A_2$  is 3mm. While,  $B_1$  and  $B_2$  are 50 $\Omega$  transmission line where  $B_1$  is a length transmission line 18mm and  $B_2$  is width of transmission line 1.3mm.

### B. Design 2 (with matching)

Figure 2 shows antenna structure for x-circular polarized with a slanted rectangular slot with matching technique. The x-circular polarized microstrip patch as shown in Figure 2 is using single coaxial port of 50 $\Omega$  as the feed port. The diameter of circular patch,  $D$  is 32mm. While, the length of the feedline,

III. RESULTS

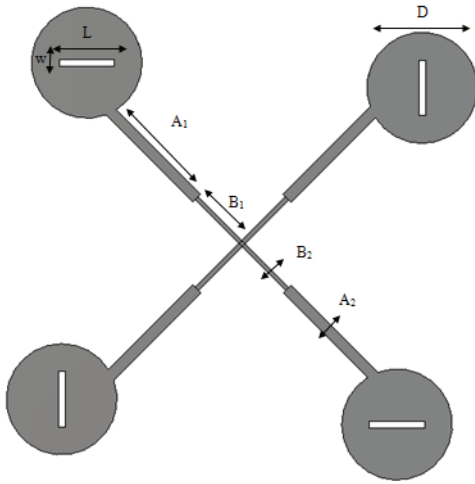

Figure 1: Antenna structure for x-circular polarized with slanted rectangular slot without matching (Design 1).

$A_1$  is  $43.7\text{mm}$  or  $\frac{\lambda}{2}$  and width of feedline  $A_2$  is  $3\text{mm}$ . Similar

to Design 1, the center of circular patch consist of rectangular slot slanted at  $45^\circ$  and lengths of slot,  $l$  is  $7.8\text{mm}$  and width slot  $w$  is  $2\text{mm}$ . The transmission line is designed to feed the circular patch from the  $50\Omega$  feed port. Length,  $D_1$  and width,  $D_2$  of the transmission line is  $16\text{mm}$  and  $1.3\text{mm}$ . In order to increase the impedance matching,  $B_1, B_2, C_1$  and  $C_2$  is quarter wavelength binomial transformer is implemented.  $B_1$  is  $2.2\text{mm}$ ,  $B_2$  is  $16\text{mm}$ ,  $C_1$  is  $1.1\text{mm}$  and  $C_2$  is  $16\text{mm}$ .

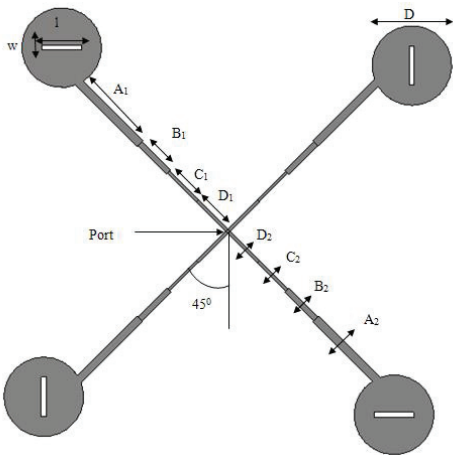

Figure 2: Antenna structure for x-circular polarized with slanted rectangular slot without matching (Design 2).

A. Design 1

a. Return Loss

Figure 3 shows the return loss for x-circular polarized with slanted rectangular slot without matching. The return loss is not less than  $-10\text{dB}$ . Thus, the bandwidth for circular patch is a  $0\text{MHz}$  since the return loss is not more than  $-10\text{dB}$ .

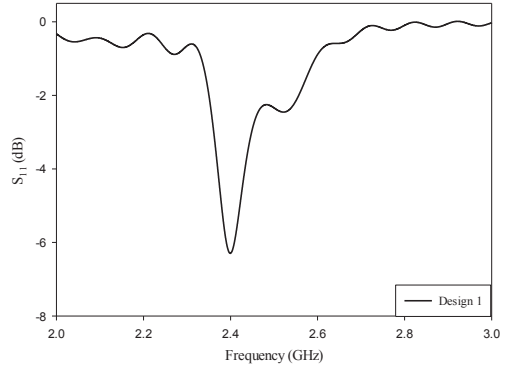

Figure 3: Return loss for Design 1

b. Gain and Directivity

Gain and directivity of Design 1 is  $5.5\text{dB}$  and  $6.1\text{dBi}$  respectively.

c. Impedance and Total efficiency

At marker point 1 in Figure 4, impedance for Design 1 is  $-23.47-j18.55\Omega$ . Total efficiency for Design 1 is  $-1.9\text{ dB}$ .

d. Surface Current

Figure 5 show a surface current which is the current flow through antenna at angle of  $0^\circ, 45^\circ, 90^\circ, 135^\circ, 225^\circ$ , and  $315^\circ$ .

e. Radiation pattern

Figure 6 below shows 2D radiation pattern for Design 1 which is cut at  $0$  degree and  $90$  degree and another one is cut at  $-45$  degree and  $45$  degree for comparison.

B. Design 2

a. Return Loss

Figure 7 shows the return loss for x-circular polarized with a slanted rectangular slot with a matching. The return loss is less than  $-10\text{db}$  which is  $-34.85\text{dB}$ . Thus, the bandwidth for circular patch is  $32\text{MHz}$ .

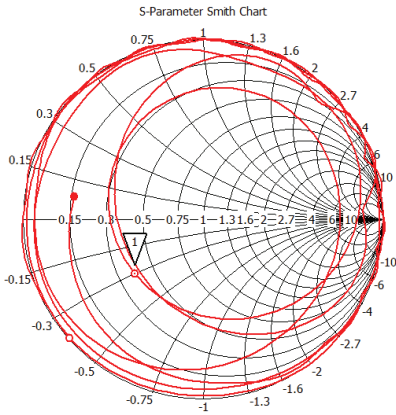

Figure 4: Smith chart for Design 1

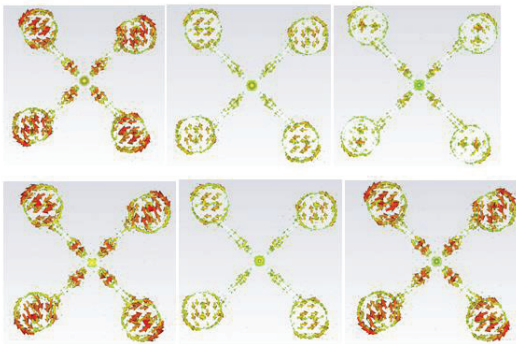

Figure 5: Surface current for Design 1

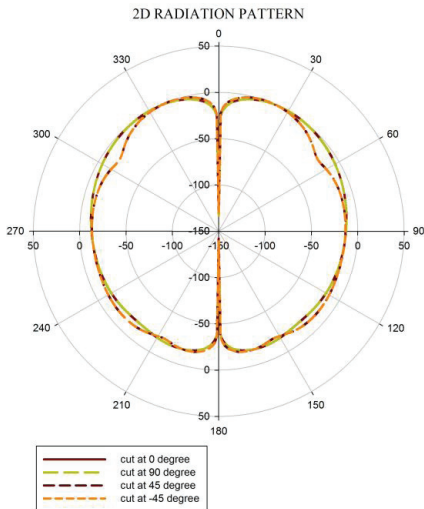

Figure 6: 2D radiation pattern for Design 1

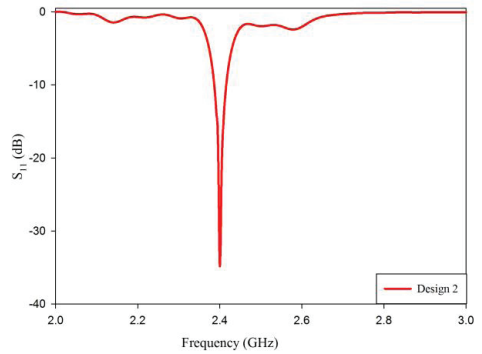

Figure 7: Return loss for Design 2

*b. Gain and Directivity*

Gain and directivity of Design 2 is 6.79dB and a 7.54 dBi respectively.

*c. Impedance and Total efficiency*

At point 1 in Figure 8, impedance for Design 2 is  $63-j0.96\Omega$ . Total efficiency in design 2 is -0.76 dB.

*d. Surface Current*

Figure 9 shows a surface current which is the current flow through an antenna at an angle of  $0^\circ$ ,  $45^\circ$ ,  $90^\circ$ ,  $135^\circ$ ,  $225^\circ$ , and  $315^\circ$ .

*e. Radiation pattern*

Figure 10 shows radiation pattern for design 2 which is cut at  $0^\circ$  and  $90^\circ$  and another one is cut at  $-45^\circ$  and  $45^\circ$  for comparison.

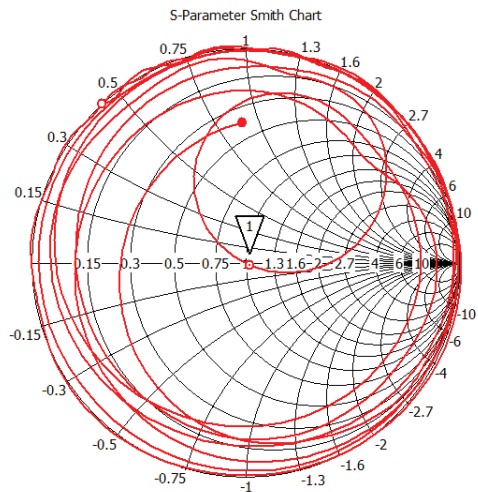

Figure 8: Smith chart for Design 2

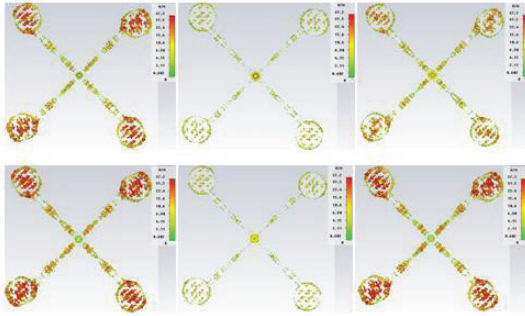

Figure 9: Surface current for Design 2

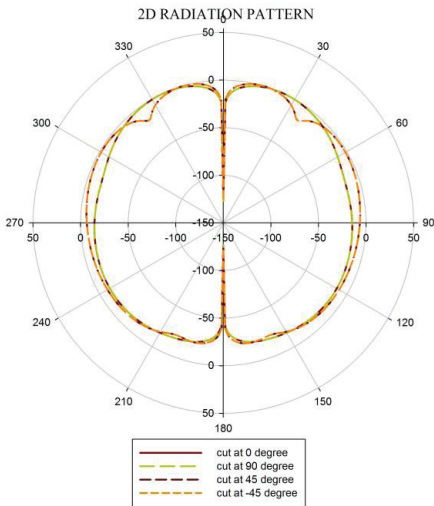

Figure 10: 2D radiation pattern for Design 2

IV. COMPARISON

Table 3 shows the comparison between x-circular polarized without matching and x-circular polarized with the binomial matching network. Return loss for Design 2 is -34.85 which is greater than Design 1 as shown in Figure 11. The bandwidth for Design 1 is 0 MHz because the return loss is not less than -10dB which is not achieve the requirement for 90 % transmission efficiency. Figure 12 shows Design 2 has a better gain and directivity which are 6.78dB and 7.54dBi respectively. Figure 13 shows the total efficiency of Design 2 is 1.14 dB higher compared to Design 1. This is due to the improvement of miss matched of the load achieved by using a quarter - wave transformer. If the total efficiency is increased, power transmits also increase and will reduce the loss in antenna. This additional performance will lead to better channel capacity for MIMO wireless communication system [18]. Figure 14 shows the comparison of axial ratio between

Design 1 and Design 2 from 2GHz to 3GHz. Design 2 produces a better degree of circular polarization radiation compare to Design 1 at 2.4 GHz. The axial ratio (AR) for Design 2 is 1.75dB, while the AR for Design 1 is more than 3dB. Furthermore, Design 2 has 3dB AR bandwidth of 213.9MHz which is covered from frequency 2.35GHz to 2.58GHz.

Table 3  
Comparison Table For Design 1 And Design 2

Parameters	Design 1	Design 2
Return loss (dB)	-6.29	-34.85
Bandwidth (MHz)	0	32
Gain (dB)	5.5	6.79
Directivity (dBi)	6.1	7.54
Impedance ( $\Omega$ )	-23.47-j18.55 $\Omega$ .	63-j0.96 $\Omega$
Total efficiency (dB)	-1.90	-0.76
AR (dB)	6.97	1.75
3dB AR BW	0	213.9
Polarization	Linear polarization	Circular polarization

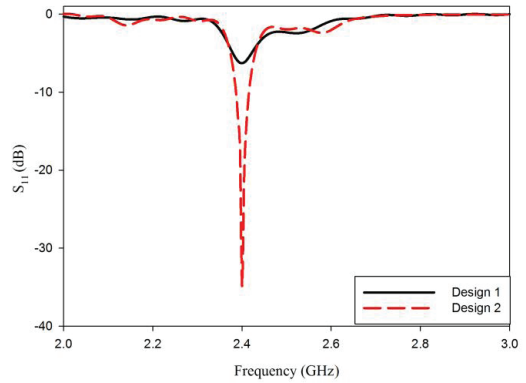

Figure 11: Return loss comparison for Design 1 and Design 2

V. CONCLUSION

The design of x-circular polarized antenna without matching (Design 1) and x-circular polarized antenna with double quarter wave impedance matching network (Design 2) have been investigated in this paper. Both antennas were simulated and designed by using CST software at frequency 2.4GHz. Design 1 has gain, directivity and efficiency of 5.5dB, 6.1dBi and -1.9dB respectively. While, Design 2 has a better return loss and bandwidth which are -34.85dB and 32MHz at 2.4GHz. Furthermore, the additional quarter-wave transformer also improve the gain, directivity and efficiency for Design 2.

REFERENCES

- [1] D. Gesbert, M. Shafi, D. Shan Shiu, P. J. Smith, and A. Naguib, "From theory to practice: an overview of MIMO space-time coded wireless systems," *IEEE J. Selected Areas Comm.*, vol. 21, pp. 281–302, 2003
- [2] J. H. Winters, "On the capacity of radio communications systems with diversity in Rayleigh fading environments," *IEEE J. Selected Areas Comm.*, vol. 5, pp. 871–878, June 1987
- [3] Cui WeiDong, "High gain linear polarization microstrip antenna with four element electromagnetically coupled patch," *Synthetic Aperture Radar, 2009. APSAR 2009*, Pg. 250-253, Oct. 2009.
- [4] Sen Feng ; Nishiyama, E. ; Aikawa, M. "Linear polarization switchable slot ring array antenna with SPDT switch circuit" *Microwave Conference, 2009. APMC 2009. Asia Pacific*, Pg. 2794-2797, Dec. 2009.
- [5] Azad, H.M.; Nishiyama, E.; Aikawa, M., "Gain enhanced linear polarization switchable microstrip array antenna," *Antennas and Propagation Society International Symposium (APSURSI), 2010 IEEE* , Pg. 1-4, July 2010.
- [6] Andrew R. Weily, Y. Jay Guo, "Circularly polarized Ellipse Loaded Circular Slot Array for Millimeter Wave WPAN Application," *IEEE Transaction on antenna and Propagation*, Vol. 57, No. 10, Oct. 2009.
- [7] Choon Sae Lee, Vahakn Nalbandian, Feliz Schwering, "Circularly Polarized Microstrip Antenna with a Single Feed," *IEEE Transaction on Antennas And Propagation*, Vol. 44, No 10, Oct 1996.
- [8] Hyeonjin Lee, Yeongsog Lim, "Design of Circular Polarized Microstrip Aperture Coupled Patch Antenna for 5.8GHz ISM Band," *Microwave Conference 2001, APMC 2001*, Vol. 1, Pg. 220-223, Dec 200.
- [9] Cui WeiDong, "High gain linear polarization microstrip antenna with four element electromagnetically coupled patch," *Synthetic Aperture Radar, 2009. APSAR 2009*, Pg. 250-253, Oct. 2009.
- [10] Liqiang Hao, Jungang Miao, Xin Zhao. "A Method to Improve the Performance of the Stacked Circularly Polarized Microstrip Antenna," *EMC Technology for Wireless Communication*, Pg. 519-522, Aug. 2007.
- [11] A. Uz Zaman, L. Manholm and A. Demeryd, "Dual polarized microstrip patch antenna with high port isolation", *Electron.Lett.*, 10,2007, Vo1.43, No.10.
- [12] kadir et. Al. (2009), "MIMO Beamforming Network Having Polarization Diversity," 3<sup>rd</sup> European Conference on Antennas and Propagation, (Kadir, M.F.A.; Aziz, M.Z.A.A.; Suaidi, M.K.; Ahmad, M.R; Daud, Z.; Rahim, M.K.A) Pg. 1743-1747.
- [13] David M. Pozar, *Microwave Engineering*, Third Edition, John Wiley, New Jersey.
- [14] G. S. Row, S. H. Yeh, and K. L. Wong, "Compact dual-polarized microstrip antennas," *Microwave Opt. Technol. Lett.* 27, 284–287, Nov. 20, 2000.
- [15] Shah, M.S.R.M.; Suaidi, M.K.; Aziz, M.Z.A.A.; Rose, M.R.C.; Kadir, M.F.A.; Ja'afar, A.S.; Rahim, M.K.A., "Design of 1x2, 1x4, and 2x2 Dual Polarization Microstrip Array Antenna," *Telecommunication Technologies 2008 and 2008 2nd Malaysia Conference on Photonics. NCTT-MCP 2008*, Pg. 113-116, Aug. 2008.
- [16] C. A Balanis (2005), *Antenna Theory Analysis and Design* third edition, Wiley, New Jersey
- [17] Compact Meander Type Slot Antenna, *Antennas and Propagation Society International Symposium 2001 IEEE*, Jung-Min Kim; Jong Gwan Yook; Woo-Young.
- [18] M.Z.A. Abd. Aziz, Z. Daud, M.K. Suaidi, M.K.A. Rahim, "Analysis of Indoor MIMO Channel Capacity Using Spatial Diversity Technique", *Journal of Telecommunication, Electronic and Computer Engineering (JTEC)*, Vol.2, No. 2, pp. 55-60, July-December 2010.

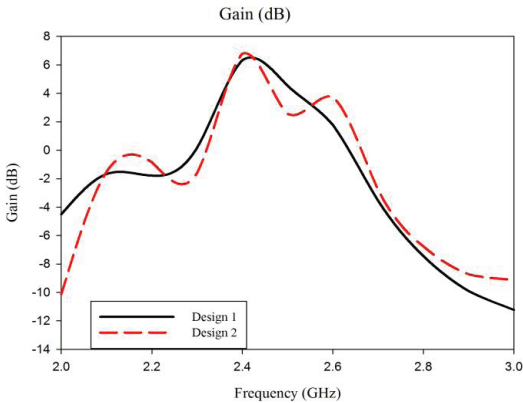

Figure 12: Gain comparison for Design 1 and Design 2

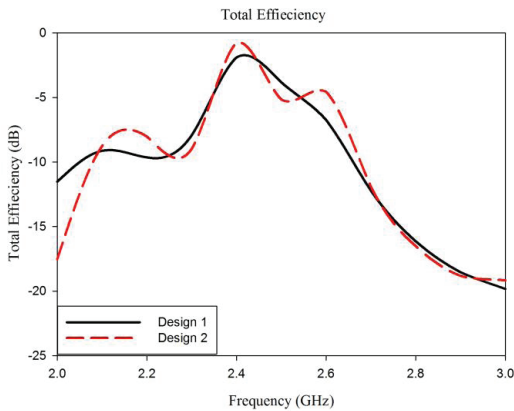

Figure 13: The comparison of total efficiency for Design 1 and Design 2

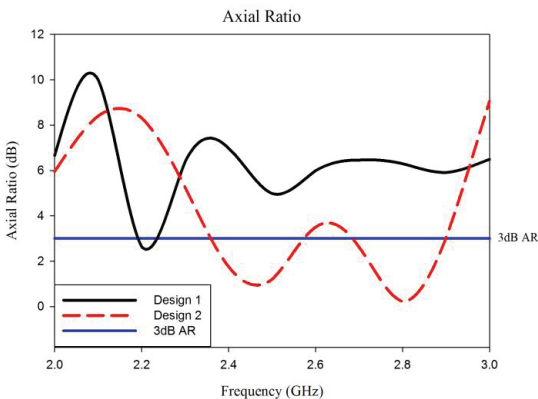

Figure 14: Axial ratio comparison for Design 1 and Design 2

