

Effect of unequal power allocation in turbo coded multi-route multi-hop networks

Tadahiro Wada, Abbas Jamalipour, Kouji Ohuchi, Hiraku Okada, and Masato Saito

Abstract— Multi-hop ad hoc networks are promising candidates for next generation mobile communications. They have sufficient channel capacity to achieve high data rate transmission for large number of users. One advantage of multi-hop networks is to realize multi-route transmissions. Since information bit streams can be transmitted over multiple routes, we can obtain route diversity effect. In order to enhance the route diversity effect, we usually introduce forward error correction schemes. Turbo coding is one of suitable coding methods for multi-hop networks. The turbo encoder generates one message stream and two parity streams whilst the message stream is more important than the parity streams for achieving reliable communications. Thus an unequal power allocation to the message and parity streams could be effective in improving the performance. In this paper, the effect of unequal power allocation for turbo coded multi-hop networks is investigated. Assuming the channel as additive white Gaussian and binary symmetric, we will show considerable performance improvement by unequal power allocation in terms of the bit error rate performance in multi-route multi-hop networks.

Keywords— multi-route transmissions, turbo codes, power allocation.

1. Introduction

For next generation mobile communications, the high channel capacity is required to realize high data rate transmission for large number of users. One way to achieve high channel capacity is to use small cell size such as pico cells. However, there is always the difficulty of installing large number of wired base stations for a small cell environment. One useful way to enhance the channel capacity without any substantial infrastructure increase is to realize a multi-hop ad hoc network [1–3]. By using a multi-hop network (because the transmitted data is relayed by mobile terminals) the data would virtually transmit in a small cell environment. A multi-hop network also has other essential advantages, such as good routing capability, small power consumption, guarantee of quality of communication service in poor channel conditions.

However, still there are some problems which prevent us to achieve a reliable and efficient use of the multi-hop networks. A major problem of the networks is to establish routes from a given source node to a given destination node. Since the topology of the network always changes by the movement of the source and intermediate nodes, routing of multi-hop network is a non-trivial work. Furthermore, battery operated mobile terminals require severe energy lim-

itation for routing. Thus, many routing algorithms for the multi-hop networks have been studied. The most popular routing approach is on-demand routing [2, 3]. Instead of periodically exchanging route information in order to maintain routing table, on-demand routing protocols establish routes only when a source node requires data transmission. Since the protocols need to flood the pilot packets over the network in order to discover the available routes (which may causes the small throughput degradation), they have the capability to built suitable routes against the frequent change of the topology.

By transmitting information on a multi-hop network, we can choose either a multi-route or a single-route transmission from the source node to the destination node. Figure 1 shows the concept of a two-route multi-hop network. The multi-route transmission has sufficient capability to achieve a reliable communication without a rapid and strict routing update. By every route helping one another, a diversity effect from the multi-route transmissions can be obtained.

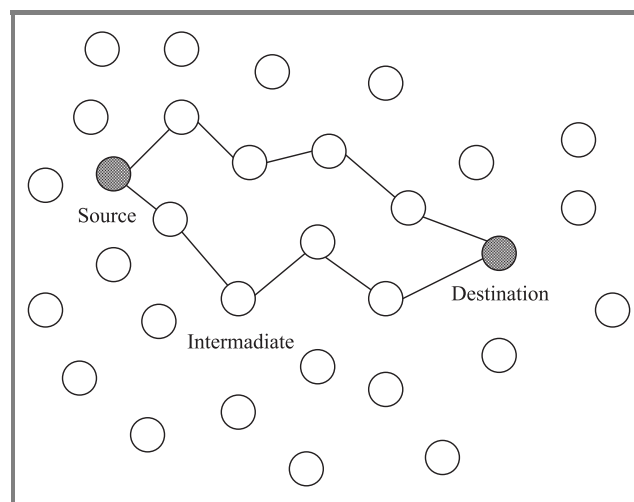

Fig. 1. Concept of route diversity in multi-hop networks.

One problem is how to use multi routes for reliable communications. There are two options in considering how to use the alternative route in multi-route transmission. The first one is that the alternative route can be used when the primary route is broken [2] and the second option is that an alternative route is simultaneously used for the transmission with the primary route [3]. Although the latter approach increases the number of packets (which may de-

grade throughput performance), it has enough capability to achieve reliable communications under the severe wireless environment by a diversity effect, namely the "route diversity."

In order to enhance the diversity effect, forward error correction (FEC) schemes should be introduced. By transmitting the same information for all routes, the effect of a repetition coding can be obtained. Since the repetition coding is trivial, another coding method which gives better performance should be considered. In this paper, turbo coding is adopted as the suitable FEC scheme for a multi-route transmission.

Turbo codes, proposed by Berrou *et al.* in 1993 [4], are very attractive means to improve the bit error rate (BER) performance. They are capable of operating at near Shannon capacity in an additive white Gaussian noise (AWGN) channel. Turbo encoder generates one message stream and two parity streams. The message stream essentially contains important information compared with parity streams. Thus it can be expected that reliability of communications increases if the message stream is transmitted on the route having good channel condition. Furthermore, we also expect to obtain a performance improvement by a suitable power allocation to the streams for a multi-route transmission.

In this paper, the effect of the route diversity in multi-route multi-hop networks using turbo codes is examined. In order to enhance the effect of the turbo codes, we investigate the suitable power allocation of turbo codes for multi-route networks assuming that every route has the same channel condition. First, we provide a brief introduction of turbo coding and explain the effect of unequal power allocation to message and parity streams. Next the effectiveness of unequal power allocation is examined. The BER performances with the AWGN channel and the binary symmetric channel (BSC) are introduced before concluding the paper.

2. Turbo codes and route diversity

2.1. Overview of turbo codes and route diversity

A typical structure of turbo encoder is illustrated in Fig. 2. The turbo encoder consists of two recursive systematic

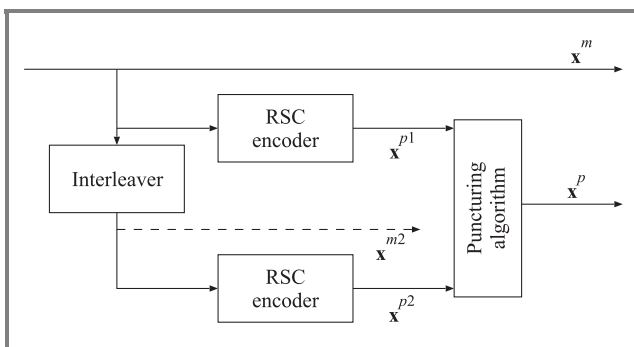

Fig. 2. Block diagram of turbo encoder with coding rate 1/2.

convolutional (RSC) element encoders, an interleaver and a puncturing algorithm. Each element encoder generates one message stream and one parity stream. Because the turbo encoder has two RSC element encoders, it generates two message streams, \mathbf{x}^m and \mathbf{x}^{m2} , and two parity streams, \mathbf{x}^{p1} and \mathbf{x}^{p2} . Since two message streams have the same information, we usually transmit only \mathbf{x}^m in order to improve the coding rate. This fact indicates that the message stream essentially contains very important information compared with the parity streams [5]. For high reliable communications in severe channel condition such as in a low signal-to-noise ratio (SNR) channel, we should consider a way to protect the message stream from disturbances, e.g., a large noise and severe fading.

An effective way for this protection is unequal power allocation to the message and parity streams [5]. By allocating larger power to the message stream compared with the parity streams, we can achieve reliable communication in a low SNR channel¹. Let $\lambda (= \lambda_m/\lambda_p)$ be the power allocation ratio, where λ_m and λ_p correspond to the power allocated to the message and parity streams, respectively. In the case of rate 1/2 turbo codes, we assume $\lambda_m + \lambda_p = 1$. The message and parity signals should be amplified by $\sqrt{\lambda/(1+\lambda)}$ and $\sqrt{1/(1+\lambda)}$. On the other hand, in the case of rate 1/3 turbo codes, we can assume $\lambda_m + 2\lambda_p = 1$ by allocating the same power to both parity streams, \mathbf{x}^{p1} and \mathbf{x}^{p2} , respectively. In this case, the amplification factor for the message signal and for the parity signals are $\sqrt{\lambda/(2+\lambda)}$ and $\sqrt{1/(2+\lambda)}$, respectively.

2.2. Brief review of iterative decoding

We introduce the Bahl-Cocke-Jelinek-Raviv (BCJR) algorithm for iterative decoding for turbo codes [8]. Figure 3

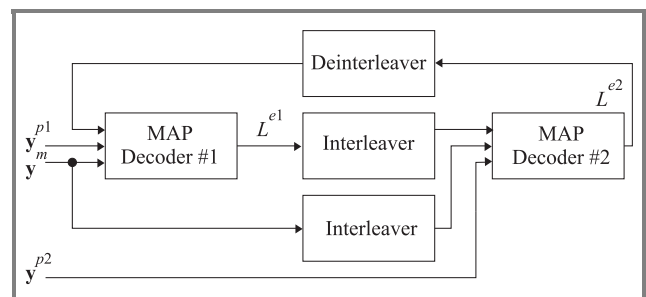

Fig. 3. Block diagram of iterative decoder.

shows a block diagram of iterative decoder, where \mathbf{y}^m , \mathbf{y}^{p1} and \mathbf{y}^{p2} are received streams for \mathbf{x}^m , \mathbf{x}^{p1} , and \mathbf{x}^{p2} , respectively. The decoder has two element decoders operated by a maximum a posteriori (MAP) probability decoding algorithm. L^{e_j} denotes extrinsic information from j th MAP decoder.

¹It should be noted that it is difficult to obtain a desirable performance by allocating large power to the message stream at high SNR. The performance of rate 1/3 turbo codes usually has an improvement by allocating large power to the parity stream in the case of a good channel condition, e.g., on near an error floor region [6, 7].

As it is known, the logarithm of a posteriori probability (LAPP) for k th bit, $L(u_k)$, is given by [8]

$$\begin{aligned} L(u_k) &= \lg \left(\frac{P(u_k = +1|\mathbf{y})}{P(u_k = -1|\mathbf{y})} \right) \\ &= \lg \left(\frac{\sum_{S^+} (s_{k-1} = s', s_k = s, \mathbf{y}) / p(\mathbf{y})}{\sum_{S^-} (s_{k-1} = s', s_k = s, \mathbf{y}) / p(\mathbf{y})} \right) \\ &= \lg \left(\frac{\sum_{S^+} \alpha_{k-1}(s') \gamma_k(s', s) \beta_k(s)}{\sum_{S^-} \alpha_{k-1}(s') \gamma_k(s', s) \beta_k(s)} \right), \end{aligned} \quad (1)$$

where $\gamma_k(s', s)$ is defined as

$$\gamma_k(s', s) = p(s_k = s, y_k | s_{k-1} = s'). \quad (2)$$

\mathbf{y} is the received signal, $s_k \in S$ is the state of the encoder at time k , S^+ is the set of ordered pairs (s', s) corresponding to all state transitions $(s_{k-1} = s') \rightarrow (s_k = s)$ caused by data input $u_k = +1$, and S^- is similarly defined for $u_k = -1$.

$\alpha_k(s)$ and $\beta_k(s')$ are derived by recursive calculation as shown in the following:

$$\alpha_k(s) = \sum_{s' \in S} \alpha_{k-1}(s') \gamma_k(s', s), \quad (3)$$

$$\beta_{k-1}(s') = \sum_{s \in S} \beta_k(s) \gamma_k(s', s), \quad (4)$$

where the initial conditions for $\alpha_k(s)$ are $\alpha_0(0) = 1$ and $\alpha_0(s \neq 0) = 0$ and those for $\beta_k(s')$ are $\beta_N(0) = 1$ and $\beta_N(s \neq 0) = 0$.

The LAPP ratio can be expressed using Bayes' rule [9]:

$$L(u_k) = \lg \left(\frac{P(\mathbf{y}|u_k = +1)}{P(\mathbf{y}|u_k = -1)} \right) + \lg \left(\frac{P(u_k = +1)}{P(u_k = -1)} \right). \quad (5)$$

The second term is a priori information and is denoted as L_k^e , i.e.,

$$L_k^e = \lg \left(\frac{P(u_k = +1)}{P(u_k = -1)} \right). \quad (6)$$

The L_k^e is provided by the previous decoder on the iterative decoding.

By using L_k^e , the value of $\gamma_k(s', s)$ is given by

$$\gamma_k(s', s) \propto \exp \left(\frac{1}{2} u_k (L_k^e + L_c^m y_k^m) + \frac{1}{2} L_c^p y_k^p x_k^p \right), \quad (7)$$

where y_k^m is the k th received signal corresponding to the message bit x_k^m and y_k^p is one corresponding to the parity bit x_k^p .

L_c^m and L_c^p are channel information of the message and parity streams, respectively. In an AWGN channel, they are expressed as

$$\begin{aligned} L_c^m &= 2r\lambda_m E_b / (N_0/2) \\ L_c^p &= 2r\lambda_p E_b / (N_0/2), \end{aligned} \quad (8)$$

where r is the code rate of turbo coding. In the case of the equal power allocation, we obviously obtain $L_c^m = L_c^p$.

2.3. Binary symmetric channels assumption of multi-hop networks

In multi-hop networks, multiple routes can be assumed to be binary symmetric channels [10]. When the bit streams are relayed by intermediate nodes, we have to face a severe power restriction. In order to reduce the load in these nodes, we employ a hard decision for all bits in the stream and reconstruct the new stream which is passed to the next node. This procedure can significantly reduce the energy consumption.

In usual, the SNR at the receiver is measured and the result of the measurement is utilized as the channel information. But in multi-hop networks, the SNR estimation at the received side is of no worth for the iterative decoder because every received signal is multiple hopped and hard detected at the intermediate nodes. Therefore, the result of the SNR measurement does not reflect the whole route except for the final hop. One solution to obtain the channel information is that we assume the channel as a BSC and estimate the channel condition by counting errors of pilots at the destination node. In this paper, therefore, the effect of the unequal power allocation on the BSC is introduced as well.

In this paper, to enhance the effect of the unequal power allocation, the destination node is assumed to know the ideal BER performance. The channel information of the BSC are introduced in [11, 12]. In the BSC, the terms in Eq. (7), $L_c^m y_k^m$ and $L_c^p y_k^p$ should be replaced to $R^m Y_k^m$ and $R^p Y_k^p$, respectively, where $Y_k^m = \lambda_m \text{sgn}(y_k^m)$ and $Y_k^p = \lambda_p \text{sgn}(y_k^p)$. Terms R_m and R_p indicate the channel information for the BSC and are derived as follows:

$$\begin{aligned} R^m &= \ln \frac{1 - P_m}{P_m}, \\ R^p &= \ln \frac{1 - P_p}{P_p}, \end{aligned} \quad (9)$$

where P_m and P_p are BER performance of the message and the parity streams, respectively. If every link is affected by AWGN, P_m and P_p can be expressed as follows:

$$\begin{aligned} P_m &\simeq MQ(2r\lambda_m E_b / N_0), \\ P_p &\simeq MQ(2r\lambda_p E_b / N_0), \end{aligned} \quad (10)$$

where M denotes the number of hops and $Q(t) = (1/\sqrt{2\pi}) \int_t^\infty \exp(-\tau^2/2) d\tau$.

3. Numerical results

3.1. System model and assumptions for simulations

Some numerical examples are shown in this section. In order to obtain essential performances of turbo codes on route diversity, we make ideal assumptions to simplify the evaluation.

First, the number of routes from the source node to the destination node is assumed to be two or three and the routes

are statistically independent. This assumption is actually appropriate because we may have difficulty in finding large number of statistical independent routes. We consider that each message and parity stream transmits on its own route. In the AWGN channel, the variance of the noise is assumed to be the same for all routes and the destination node knows the ideal SNR value. In the BSC, we assume the destination node knows the BER performance of all routes.

Figure 4 illustrates the system model of rate 1/3 turbo encoder with unequal power allocation. It has two (31,27) RSC element encoders and a random interleaver with the length of 5000.

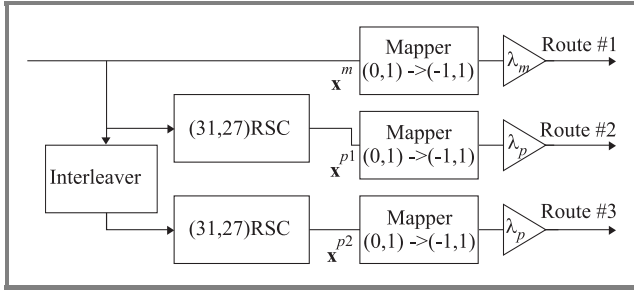

Fig. 4. System model of turbo encoder for performance evaluation. The code rate of this system is 1/3.

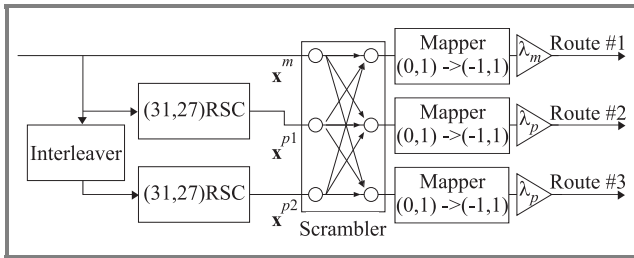

Fig. 5. System model of turbo encoder having a scrambler. The code rate of this system is 1/3.

In order to emphasize the effectiveness of unequal power allocation, we derive another performance, which comes from Fig. 5. This figure shows the system model of turbo encoder having a scrambler which scrambles the message and parity streams. Since we can make the importance of all streams be equal by scrambling the streams, it can be expected to neglect the effect of unequal power allocation. The permutation rule of the scrambler for the rate 1/3 encoder is assumed as following:

$$\begin{aligned} \mathbf{x}^1 &= (\dots, x_k^m, x_{k+1}^{p2}, x_{k+2}^{p1}, \dots), \\ \mathbf{x}^2 &= (\dots, x_k^{p1}, x_{k+1}^m, x_{k+2}^{p2}, \dots), \\ \mathbf{x}^3 &= (\dots, x_k^{p2}, x_{k+1}^{p1}, x_{k+2}^m, \dots), \end{aligned} \quad (11)$$

where \mathbf{x}^i is the scrambled stream transmitting on the i th route, $i = 1, 2, 3$. Of course a descrambler at the receiving end is required. Assuming that we allocate the same power, expressed as λ_2 , to \mathbf{x}^2 and \mathbf{x}^3 and another power allocated to \mathbf{x}^1 , expressed as λ_1 . The ratio of the allocated powers, λ_1/λ_2 , is expressed as λ .

Although Figs. 4 and 5 illustrate rate 1/3 turbo encoders, the performances of not only rate 1/3 but rate 1/2 turbo codes can be derived. The permutation rule of the scrambler for the rate 1/2 encoder is

$$\begin{aligned} \mathbf{x}^1 &= (\dots, x_k^m, x_{k+1}^m, x_{k+2}^{p1}, x_{k+3}^{p2}, \dots) \\ \mathbf{x}^2 &= (\dots, x_k^{p1}, x_{k+1}^{p2}, x_{k+2}^m, x_{k+3}^m, \dots). \end{aligned} \quad (12)$$

The iteration number for the decoding process is set to 10.

3.2. Effect of unequal power allocation in AWGN channel

Figures 6 and 7 show the BER performance with the unequal power allocation for rates 1/2 and 1/3 turbo codes, respectively. We set the range of the power allocation ratio, λ , between 0.8 and 2.0, where $\lambda = 1$ is a typical value.

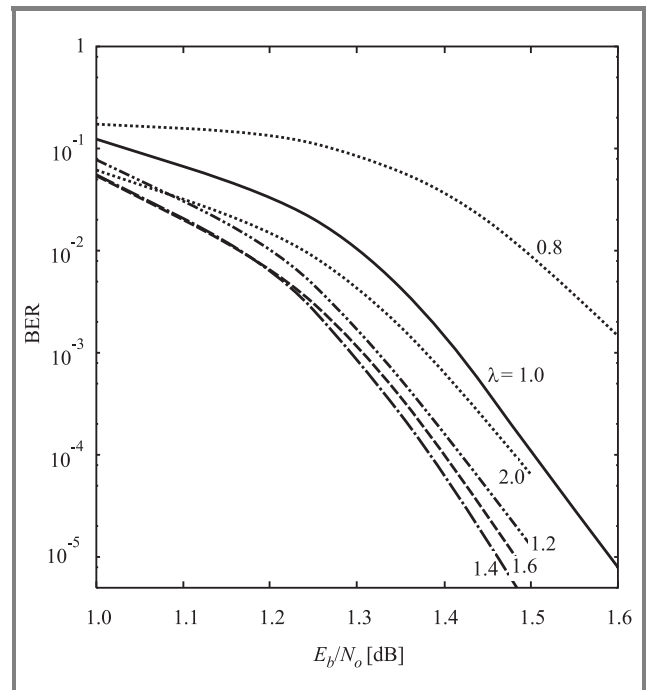

Fig. 6. Bit error rate performance versus E_b/N_0 for varying the power allocation ratio. The code rate is set at 1/2.

From the results, we find the effectiveness of the unequal power allocation. When the power allocated to the message streams decreases, i.e., $\lambda = 0.8$, the BER performance degrades in both coding rates. In contrast, we observe performance improvement by allocating a large power to the message stream. It can be found that a suitable unequal power allocation offers approximately a 0.15 dB performance improvement over the equal power allocation.

Figures 8 and 9 show the BER performance with a scrambler for rates 1/2 and 1/3 turbo codes, respectively. The range of the power allocation ratio is from 0.8 to 2.0. From these figures, it can be found that the BER performance at $\lambda = 1$ is the best, i.e., we face the performance degradation with scrambling the streams by unequal power allocation.

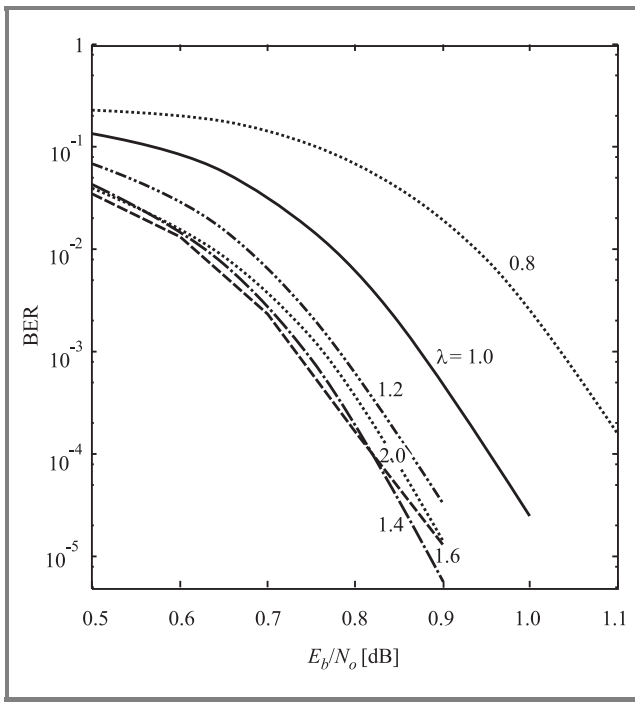

Fig. 7. BER performance versus E_b/N_0 for varying the power allocation ratio. The code rate is set at $1/3$.

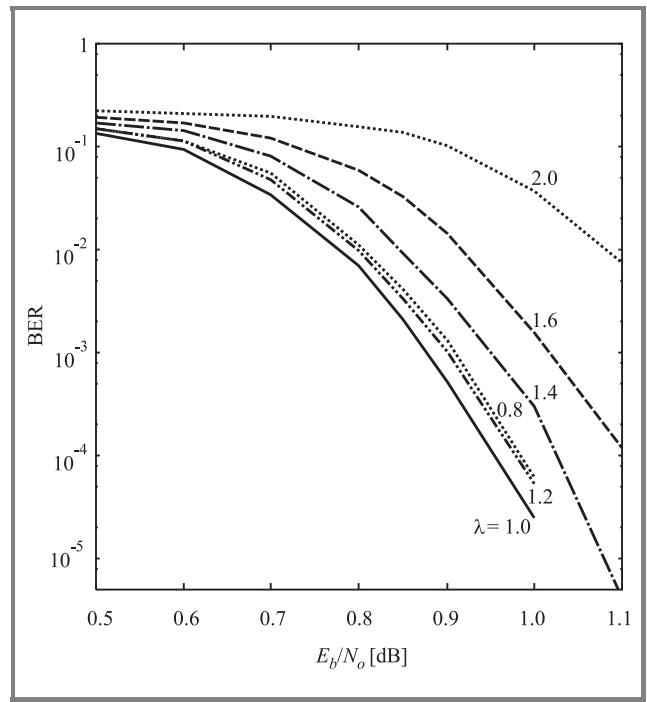

Fig. 9. BER performance versus E_b/N_0 for varying the power allocation ratio with the scrambler. The code rate is set at $1/3$.

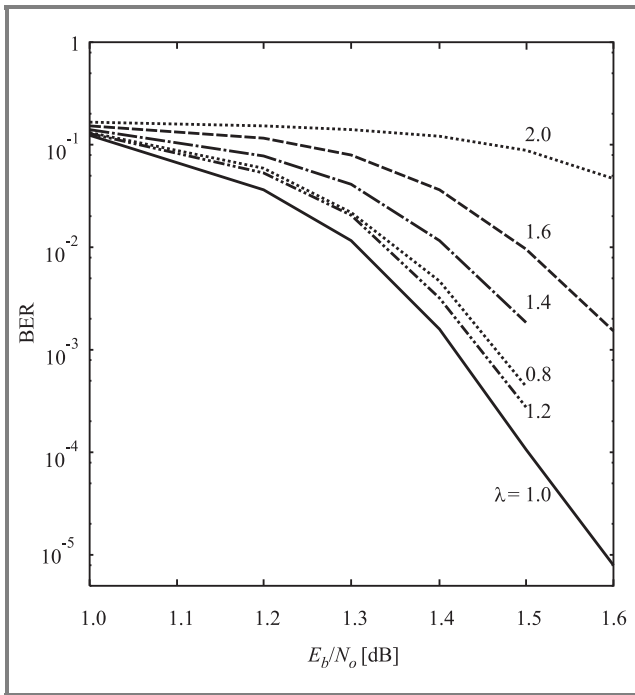

Fig. 8. BER performance versus E_b/N_0 for varying the power allocation ratio with the scrambler. The code rate is set at $1/2$.

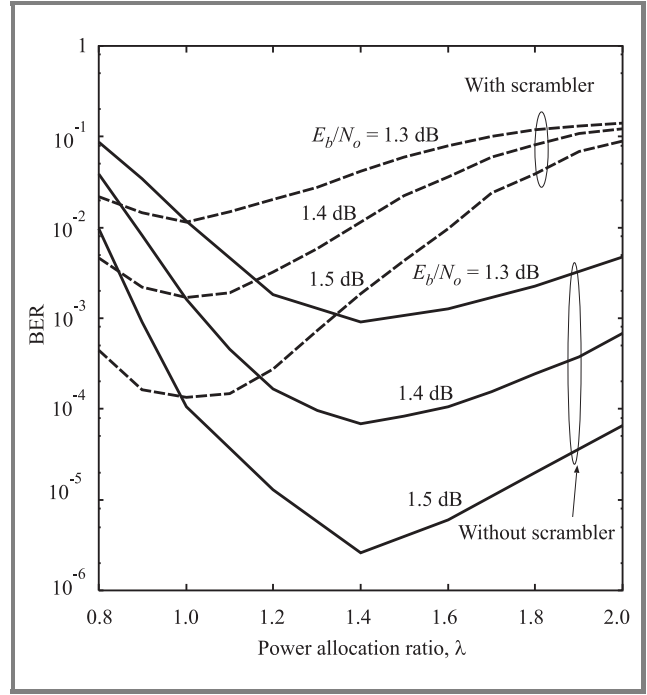

Fig. 10. BER performance versus λ . The code rate is $1/2$. The performances of both with and without the scrambler are plotted.

The results show that the importance of the message stream is neglected by the scrambling and we cannot obtain any performance improvement from unequal power allocation. Figures 10 and 11 show the BER performance as a function of the power allocation ratio, λ , for rates $1/2$ and $1/3$ turbo codes, respectively. From Fig. 10, which indicates the per-

formance of the rate $1/2$ codes, we can obtain the best performance by the unequal power allocation when λ is around 1.4. On the other hand, we can obtain the best performance when λ is around 1.5 in the case of rate $1/2$ turbo codes. We also find that the performance improvement can be kept over the wide range of λ .

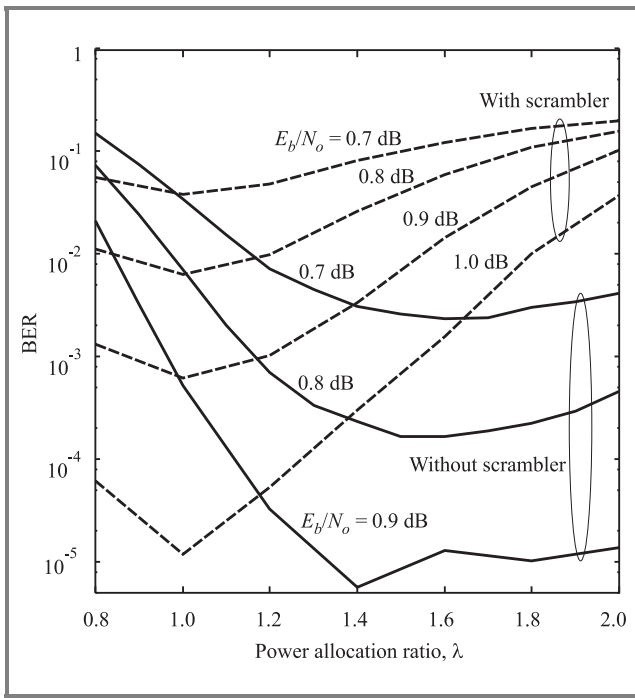

Fig. 11. Bit error rate performance versus the power allocation ratio when the code rate is 1/3. The performances of both with and without the scrambler are plotted.

3.3. Effect of unequal power allocation in BSC

Figures 12 and 13 show BER performance with the unequal power allocation in the BSC. We do not utilize the scrambler in this subsection. We set the power allocation ratio, λ , between 0.8 and 2.0. As we expected, the BER

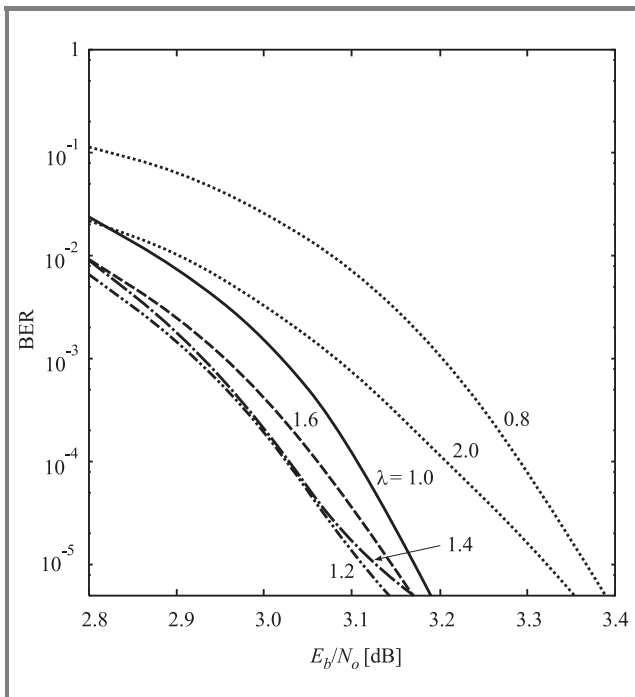

Fig. 12. Bit error rate performance versus E_b/N_0 for varying the power allocation ratio in the BSC. The code rate is set at 1/2.

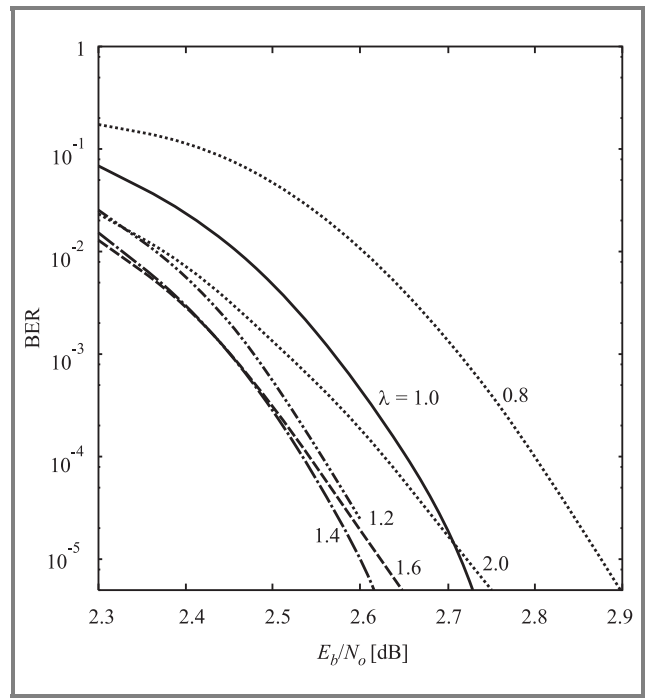

Fig. 13. Bit error rate performance versus E_b/N_0 for varying the power allocation ratio in the BSC. The code rate is set at 1/3.

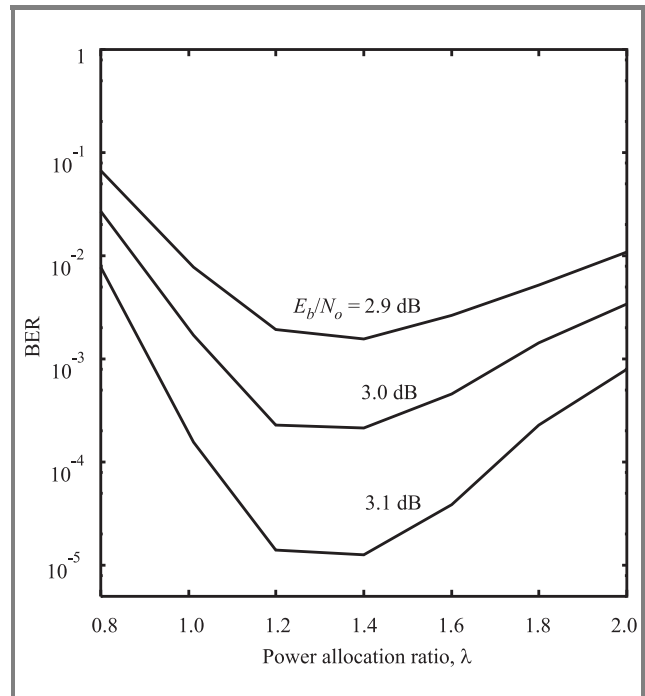

Fig. 14. Bit error rate performance versus the power allocation ratio when the code rate is 1/2. The channel is assumed as the BSC.

performance with the BSC degrades compared with that of the AWGN channel. But the tendency of the performance of BSC is similar to that of the AWGN channel by changing the power allocation ratio, i.e., we can find performance improvement by allocating the large power to the message stream.

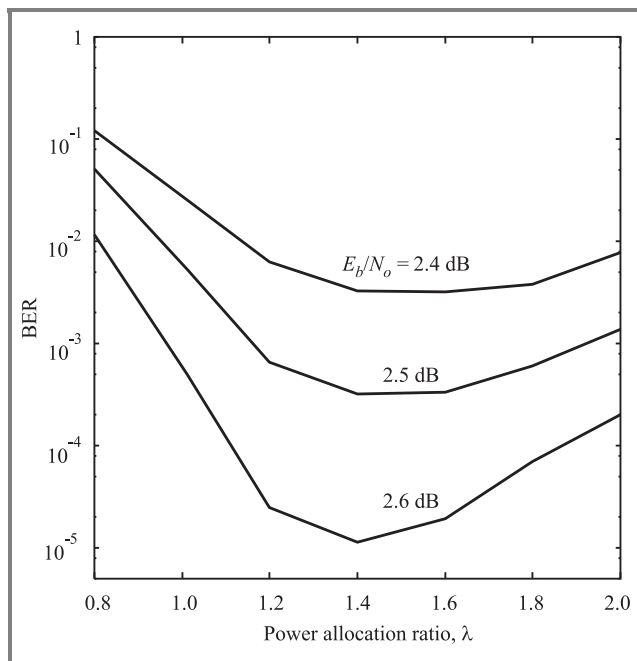

Fig. 15. Bit error rate performance versus the power allocation ratio when the code rate is 1/3. The channel is assumed as the BSC.

Figures 14 and 15 illustrate the BER performance as a function of the power allocation ratio, λ , for rates 1/2 and 1/3 turbo codes, respectively. From Fig. 10, we can obtain the best performance when λ is around 1.3. On the other hand, we can obtain the best performance when λ is around 1.5 in the case of rate 1/2 turbo codes. In contrast with the performance in Fig. 11, the performance improvement is not kept as λ increases.

4. Conclusions

In this paper, the effect of unequal power allocation to message and parity streams in turbo coded multi-route networks by route diversity was investigated. Additive white Gaussian and binary symmetric channels have been used. It is found that it is possible to obtain considerable performance improvement by allocating larger power to the message stream compared with that of the parity stream. The results suggest that unequal power allocation is an efficient way in improving the bit error rate performance in multi-hop networks. Although in this paper all routes have been assumed to have similar channel conditions, each route actually could have its own condition. The results also suggest that a suitable power allocation can prevent performance degradation by taking individual channel conditions into account.

Acknowledgements

This work is partially supported by Strategic Information and Communications R&D Promotion Programme (SCOPE) by Ministry of Internal Affairs and Communications, Japan.

References

- [1] S. Toumpis and A. J. Goldsmith, "Capacity regions for wireless ad hoc networks", *IEEE Trans. Wirel. Commun.*, vol. 2, no. 4, pp. 736–748, 2003.
- [2] A. Nasipuri and S. R. Das, "On-demand multipath routing for mobile ad hoc networks", in *IEEE Int. Conf. Comput. Commun. Netw.*, Boston, USA, 1999, pp. 64–70.
- [3] S.-J. Lee and M. Gerla, "Split multipath routing with maximally disjoint paths in ad hoc networks", in *IEEE Int. Conf. Commun.*, Helsinki, Finland, 2001, pp. 3201–3205.
- [4] C. Berrou, A. Glavieux, and P. Thitimajshima, "Near Shannon limit error correcting coding and decoding: turbo-codes", in *Int. Conf. Commun.*, Geneva, Switzerland, 1993, pp. 1064–1070.
- [5] J. Hokfelt and T. Maseng, "Optimizing the energy of different bit-streams of turbo codes", in *Turbo Cod. Sem. Proc.*, Lund, Sweden, 1996, pp. 59–63.
- [6] T. M. Duman and M. Salehi, "On optimal power allocation for turbo codes", in *Int. Symp. Inform. Theory*, Ulm, Germany, 1997, p. 104.
- [7] S.-J. Park and S. W. Kim, "Transmission power allocation in turbo codes", in *Veh. Technol. Conf. 2000*, Boston, USA, 2000, pp. 2073–2075.
- [8] W. E. Ryan, "A turbo code tutorial", www.ece.arizona.edu/~ryan/
- [9] D. Applebaum, *Probability and Information*. Cambridge: Cambridge University Press, 1996.
- [10] T. Wada, N. Nakagawa, H. Okada, A. Jamalipour, K. Ohuchi, and M. Saito, "Performance improvement of turbo coded multi-route multi-hop networks using parity check codes", in *2005 IEEE Worksh. High Perform. Switch. Rout.*, Hong Kong, China, 2005.
- [11] J. Hagenauer, E. Offer, and L. Papke, "Iterative decoding of binary block and convolutional codes", *IEEE Trans. Inform. Theory*, vol. 42, no. 2, pp. 429–445, 1996.
- [12] C. Zheng, T. Yamazato, H. Okada, M. Katayama, and A. Ogawa, "A study on turbo soft-decision decoding for hard-detected optical communication signals", *IEICE Trans. Commun.*, vol. 86, no. 3, pp. 1022–1030, 2003.



Tadahiro Wada was born in Gifu, Japan, in 1969. He received the B.E. degree in electrical, electronic and information engineering from Nagoya University in 1993, and the M.E. and Ph.D. degrees in information electronics from Nagoya University in 1995 and 1997, respectively. Since April 1998, he was with Department

of Electrical and Electronics Engineering in Shizuoka University, Japan, as an Assistant Professor. From 2004 to 2005, he was a Visiting Scholar at the School of Electrical and Information Engineering, University of Sydney, Australia. Since 2005, he has been a lecturer in Division of Applied Science and Basic Engineering, Shizuoka University, Japan. His research interests lie in the areas of spread-spectrum communications, satellite communications, CDMA systems, power line communications, coding theory and mobile communications. He was a recipient of the IEICE Young Investigators Award in 2002. Doctor Wada is a Member of IEEE, IEICE, and SITA.

e-mail: tetwada@ipc.shizuoka.ac.jp

Department of Electrical and Electronic Engineering
Shizuoka University Johoku 3-5-1
Hamamatsu, 432-8561 Japan



Abbas Jamalipour received the Ph.D. degree in electrical engineering from Nagoya University, Nagoya, Japan. He is a Professor at the School of Electrical and Information Engineering, University of Sydney, Australia, where he is responsible for teaching and research in wireless data communication networks, wireless

IP networks, network security, and satellite systems. He is the author for the first technical book on networking aspects of wireless IP, "The Wireless Mobile Internet – Architectures, Protocols and Services" (Chichester: Wiley, 2003). In addition, he has authored another book on satellite communication networks, "Low Earth Orbital Satellites for Personal Communication Networks" (Norwood: Artech House, 1998) and coauthored four other technical books in wireless telecommunications. He has authored over 150 papers in major journals and international conferences, and given short courses and tutorials in major international conferences. He is the Editor-in-Chief of the "IEEE Wireless Communications" and a Technical Editor of the "IEEE Communications", and the "International Journal of Communication Systems". Professor Jamalipour is the Technical Program Vice-Chair of IEEE WCNC 2005, Co-Chair of Symposium on Next Generation Networks, IEEE ICC 2005, Technical Program Vice-Chair IEEE HPSR 2005, Chair of the Wireless Communications Symposium, IEEE GLOBECOM 2005, and Co-Chair of Symposium on Next Generation Mobile Networks, IEEE ICC 2006. He is a Fellow Member of IEAust; Chair of IEEE Communications Society Satellite and Space Communications Technical Committee; Vice Chair of Asia Pacific Board, Technical Affairs Committee; and Vice Chair of Communications Switching and Routing Technical Committee. He is a Distinguished Lecturer of the IEEE Communications Society and a Senior Member of IEEE.

e-mail: a.jamalipour@ieee.org

School of Electrical and Information Engineering
The University of Sydney
Sydney, NSW 2006, Australia



Kouji Ohuchi was born in Ibaraki, Japan, in 1970. He received the B.E., M.E. and E.D. degrees from Ibaraki University, Japan, in 1994, 1996, and 1999, respectively. He has been a Research Associate at Graduate School of Electronic Science and Technology, Shizuoka University, since 1999. He is a Member of IEEE and IEICE.

His research interests are in spread spectrum communications, synchronization systems, and error correcting techniques.

e-mail: dkoouti@ipc.shizuoka.ac.jp
Graduate School of Electronic Science
and Engineering
Shizuoka University Johoku 3-5-1
Hamamatsu, 432-8561 Japan



Hiraku Okada received the B.Sc., M.Sc. and Ph.D. degrees in information electronics engineering from Nagoya University, Japan, in 1995, 1997 and 1999, respectively. From 1997 to 2000, he was a Research Fellow of the Japan Society for the Promotion of Science. Since 2000, he has been an Assistant Professor of the Center for In-

formation Media Studies at Nagoya University, Japan. His current research interests include the packet radio communications, multimedia traffic, wireless multi-hop/multi-cell networks, and CDMA technologies. He received the Inose Science Award in 1996, and the IEICE Young Engineer Award in 1998. Doctor Okada is a Member of IEEE, IEICE, and SITA.

e-mail: okada@nuee.nagoya-u.ac.jp
EcoTopia Science Institute
Nagoya University
Furo-cho, Nagoya, 464-8603 Japan



Masato Saito received the B.E., M.E., and Ph.D. degrees from Nagoya University, Japan, in 1996, 1998, 2001, respectively. He is currently an Assistant Professor of the Graduate School of Information Science at Nara Institute of Science and Technology (NAIST), Japan. His current research interests include spread-spectrum modulation schemes, mobile communications, CDMA schemes, multi-carrier modulation schemes, packet radio networks, and multi-hop networks. Doctor Saito is a Member of IEEE and IEICE.

e-mail: saito@is.aist-nara.ac.jp
Graduate School of Information Science
Nara Institute of Science and Technology (NAIST)
8916-5 Takayama-cho
Ikoma, Nara, 630-0192 Japan