



1973

Tree and string analysis of a Copala Trique sentence

Bruce Hollenbach
SIL-UND

David Thomas
SIL-UND

Follow this and additional works at: <https://commons.und.edu/sil-work-papers>

Recommended Citation

Hollenbach, Bruce and Thomas, David (1973) "Tree and string analysis of a Copala Trique sentence," *Work Papers of the Summer Institute of Linguistics, University of North Dakota Session*: Vol. 17 , Article 14.

DOI: 10.31356/silwp.vol17.14

Available at: <https://commons.und.edu/sil-work-papers/vol17/iss1/14>

This Article is brought to you for free and open access by UND Scholarly Commons. It has been accepted for inclusion in Work Papers of the Summer Institute of Linguistics, University of North Dakota Session by an authorized editor of UND Scholarly Commons. For more information, please contact zeineb.yousif@library.und.edu.

Tree and String Analysis of a Copala Trique Sentence

Bruce Hollenbach and David Thomas

This paper is simply a presentation of two analyses of the same Copala Trique sentence. The first analysis is done by David Thomas and represents a string analysis, with a distinction between deep structure and surface structure. The second analysis is done by Bruce Hollenbach and represents a tree analysis done from the point of view of generative semantics. We hope that this presentation may be useful to those who might be interested in comparing and contrasting these two analytical techniques. The sentence is the following:

reke ³²	dyose ⁵	ze ³	za? ⁵	ma ³	ni? ³²	zih ⁵	noko? ⁵
give	God	stuff	good	to	us	who	follow
ma ³	zo? ³						
to	him						

String Analysis

The formulas are followed by diagrams of the structures, concluding with a summary diagram of deep structure constituents and the corresponding surface form (DS = deep structure, SS = surface structure.) The formulas do not give the full range of Trique structure but only give enough of each formula as is relevant to the sentence at hand. (→ = is manifested as)

A well-formed Statement Sentence = +Statement:Clause/...+Inton.

DS Statement → SS Clause

(Discourse)

Sent: | C1
+-----+

God gives good stuff to us who follow him

A well-formed Benefactive Clause = +Pred:VP_{ben} /... + Agent:NP/...
 +Patient:NP/... + Later Possessor:RelAxP/...

DS Pred, Ag, Pat, LatPos → SS Pred - Ag - Pat - LatPos

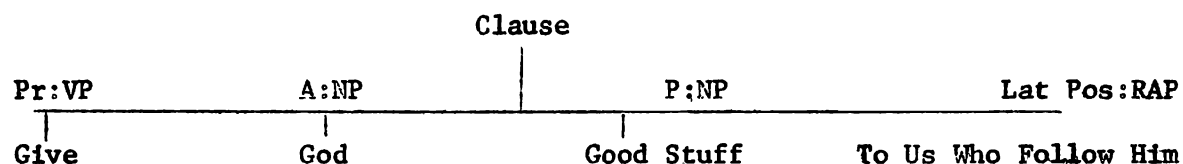

A well-formed Benefactive Verb Phrase = +V:V_{ben} /...

DS Action → SS Verb

A well-formed Noun Phrase = +NH:N/RelCl/NN/... ± Mod:Adj /...

DS Item, Characteristics → SS NH-Mod

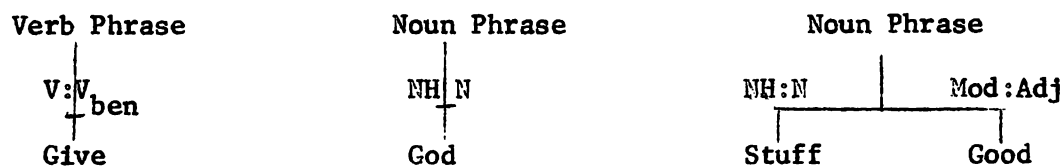

A well-formed Relator-Axis Phrase = +Rel:ma³ + Axis:NP/...

DS Marker, Item → SS Relator, Axis

A well-formed Relative Clause = + Mark:zih⁵ + Clause:BenCl/

DS Marker, Clause → SS Agent-zih⁵ - V_{ben} - LatPos

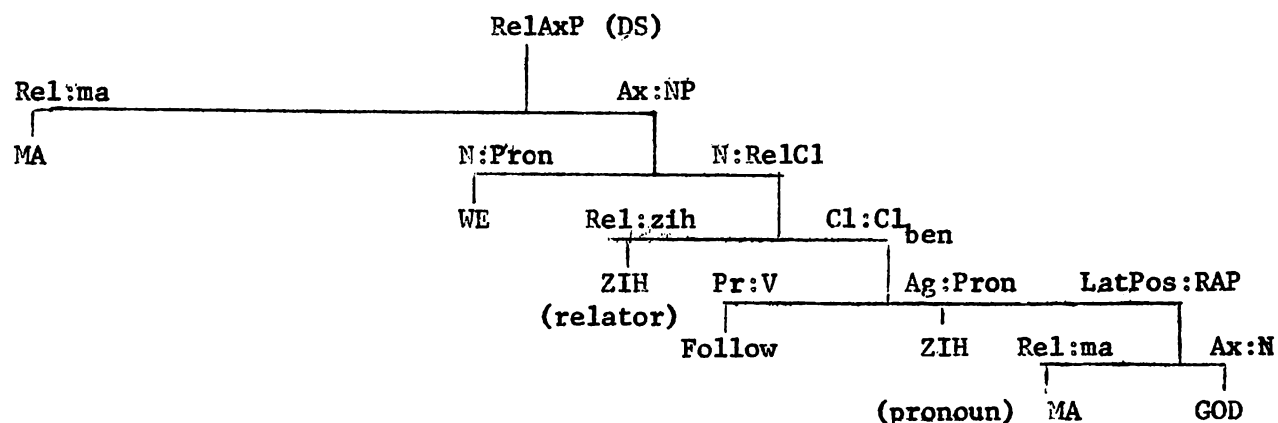

ss: Ma We Zih Follow Ma God

lexemes: GIVE, GOD, STUFF, GOOD, MA, ZIH, FOLLOW, WE

- see dictionary for forms

pronominalization: When a lexeme is to occur twice in a sentence, the second occurrence is substituted for by the appropriate pronoun. Lexemes denoting men take him as their pronoun.

COMBINED DIAGRAM OF DEEP STRUCTURE

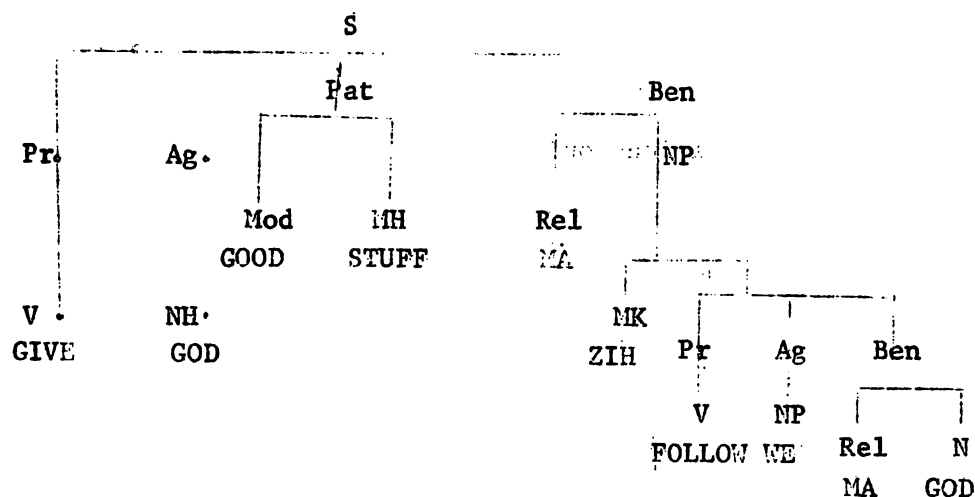

ULTIMATE SURFACE FORM

Give God Stuff Good Ma We Zih Follow Ma God

TREE ANALYSIS

The logical structure of the sentence is given first. It is understood that, apart from differences regarding which features must be specified, this structure represents the meaning of the sentence for any language in which it might be uttered. Then follow the derivational processes which are necessary in order to convert the logical structure into the surface structure peculiar to Copala Trique.

LOGICAL STRUCTURE

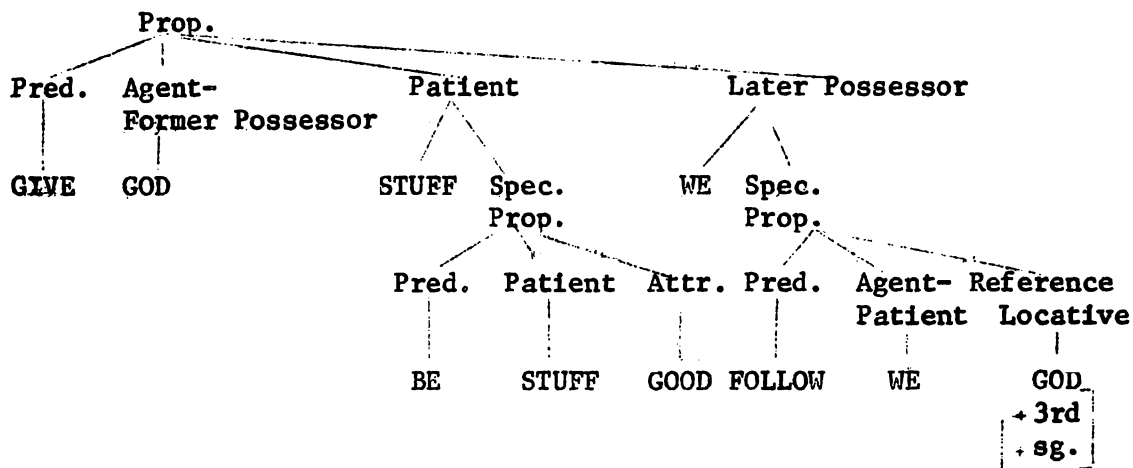

CYCLE 1 BEGINS - embedded propositions only

PREPOSITION INSERTION:
(In this case marking
Reference-Locative)

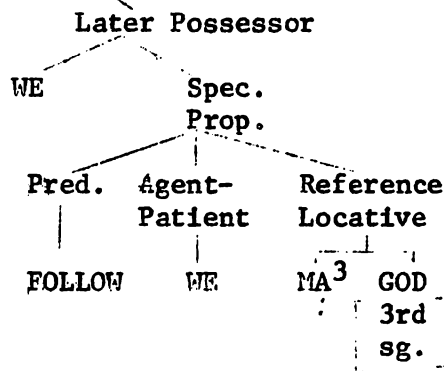

SUBJECTIVALIZATION and OBJECTIVALIZATION
would normally occur here, but these
processes seem to be unnecessary for
Copala Trique

LINEARIZATION

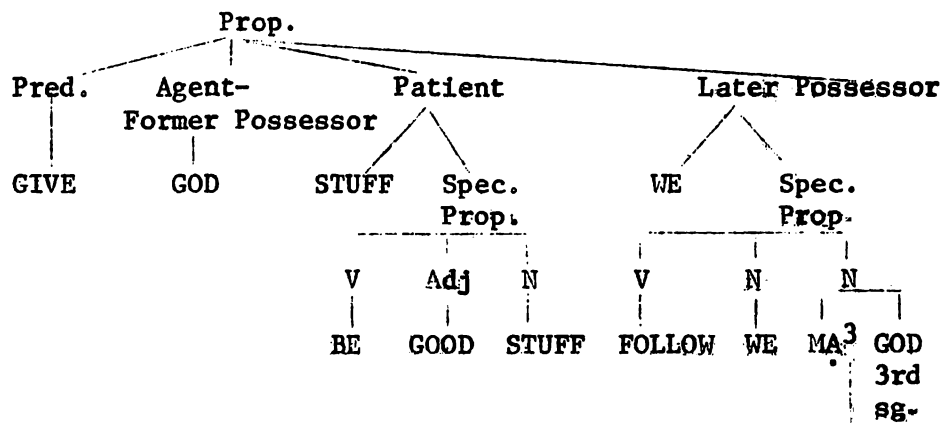

RELATIVE FRONTING:

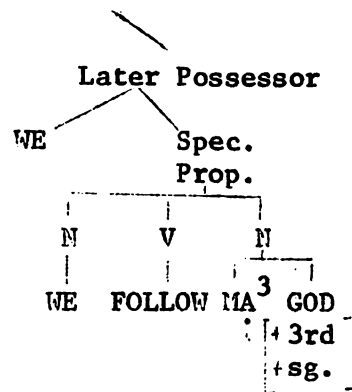
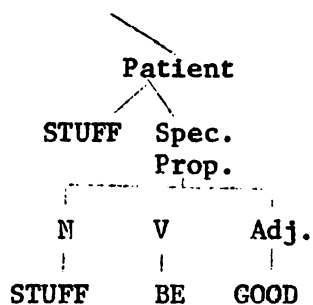

BE DELETION:

(perhaps optional - conditions of application not known)

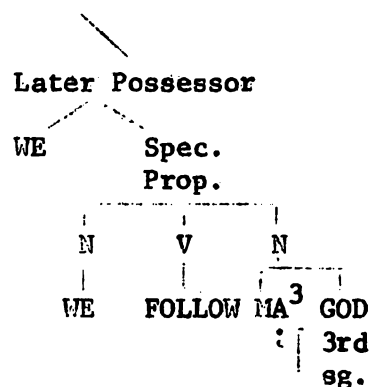
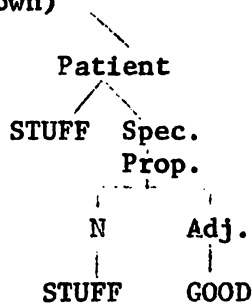

RELATIVE SUBSTITUTION:

(only for personal pronouns)

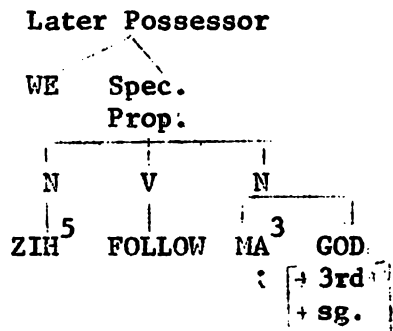
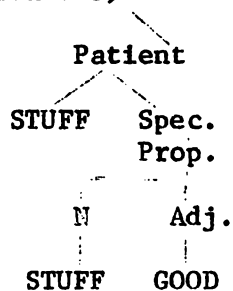

EQU-N DELETION:

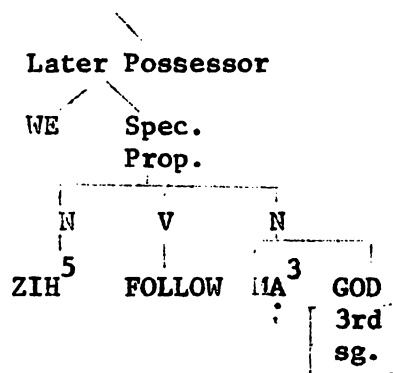
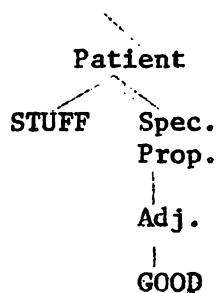

RELATIVE INCORPORATION

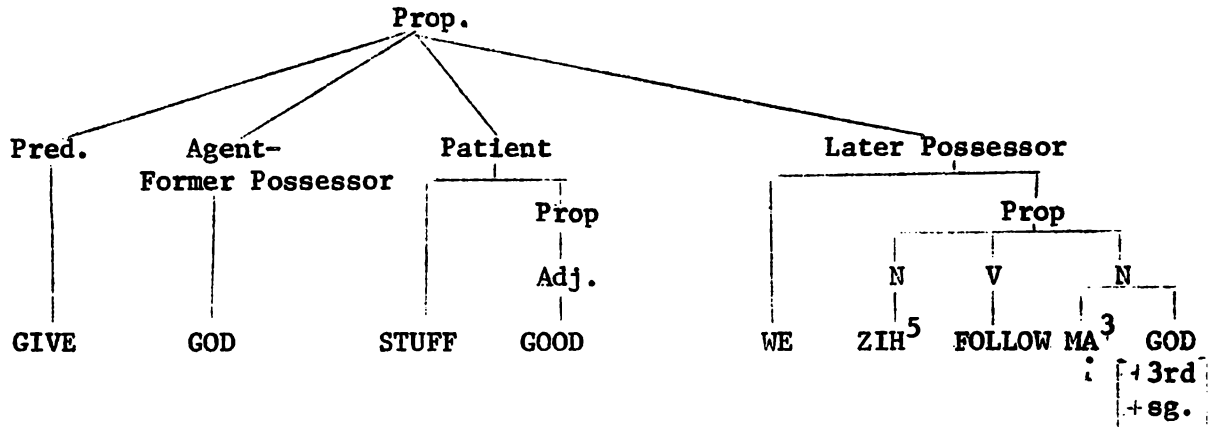

CYCLE 2 BEGINS - matrix proposition
 PREPOSITION INSERTION:
 (in this case marking
 Later Possessor)

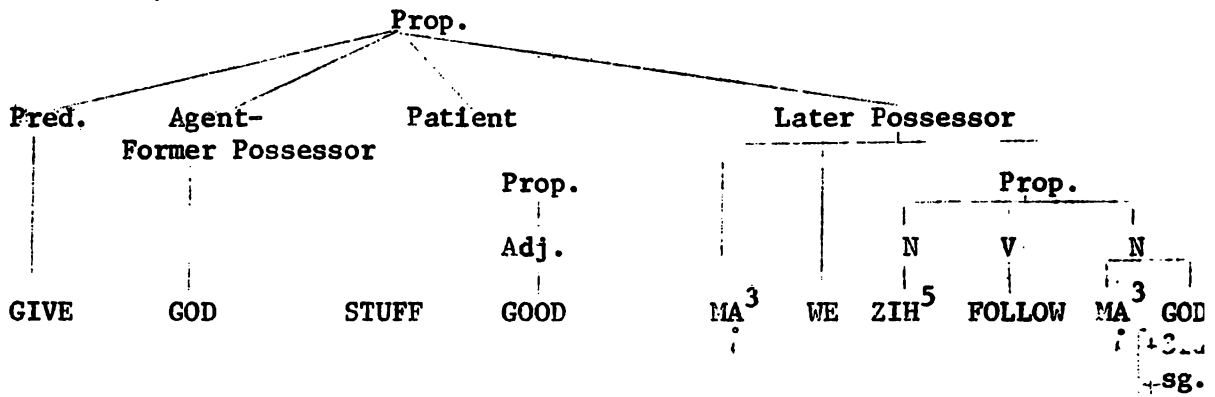

SUBJECTIVALIZATION and OBJECTIVALIZATION
 would occur here, if necessary

LINEARIZATION:
 and PRONOUN SUBST. (OPT.):
 (for second and later occurrences
 of same nominal element)

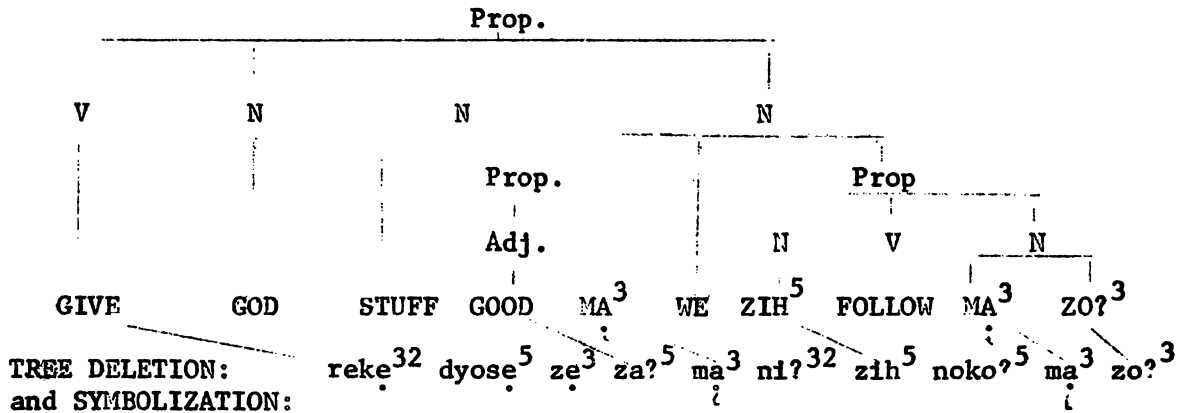

TREE DELETION:
 and SYMBOLIZATION: