

# Loom Settings and Fabric Structure: Two Major Influencing Factors of Warp Tension Variation

Toufique Ahmed<sup>a\*</sup>, Jahid Sarker<sup>b</sup>, S. M Ashique<sup>c</sup>

<sup>a,b,c</sup>Lecturer, National Institute of Textile Engineering and Research, Savar, Dhak-1350, Bangladesh.

<sup>a</sup>Email: [atoufique@gmail.com](mailto:atoufique@gmail.com)

<sup>b</sup>Email: [protikniter@gmail.com](mailto:protikniter@gmail.com)

<sup>c</sup>Email: [s.m.ashique33@gmail.com](mailto:s.m.ashique33@gmail.com)

## Abstract

The Warp tension has a great influence on fabric quality and production. Warp tension is related with various loom settings like backrest position, backrest height, dropper position, dropper height and fabric structure. If backrest roller is moved at backward position keeping the dropper line intact then the required warp tension will be reduced. But if the intact dropper line comes at the middle due to the changing of backrest roller position then the required tension will be high. Tension is also influenced by backrest height like higher backrest height will need high tension and lower backrest height will need low tension. Again, dropper position and dropper height affect the tension at a large scale. When the dropper position (distance from backrest to dropper line) increases then the required tension will also increase. In case of dropper height, when dropper line is lifted then the required tension will be decreased provided that the dropper line is situated about the middle position of warp yarn. However when the dropper line is situated closer to the heald frame then the effect of dropper height will be substituted by the effect of dropper position. On the other hand fabric structure or weave has substantial influence on warp tension. Plain weave require more tension than any other weave.

**Keywords:** fabric structure; loom settings; warp tension.

---

\* Corresponding author.

## **1. Introduction**

The most important fabric manufacturing processes is weaving. For producing good quality fabric proper warp tension is a vital need. For ensuring proper warp tension electronic warp control is used in modern looms. But changing of different loom setting points can play an important role in assuring proper warp tension which may be an important tool for eliminating starting mark, weaving damage etc. as tension varies with the change of fabric structure, the tension should be readjusted just after changing any design.

### ***1.1. Literature review***

Weaving is one of the most significant parts of the textile manufacturing. The precise gathering of weaving loom components has substantial effect on the quality and quantity of fabrics produced. Among loom components, the backrest roller is a crucial part which adjusts the tension of warp yarns and therefore it could affect fabric properties [1, 2]. The backrest roller motion has also significant effect in improving the efficiency of the weaving performance, especially when the loom moves faster [3]. The properties of denim fabric is affected by the tension of warp which is studied by Adanur and Jing [4, 5] the swinging motion of backrest roller has an influencing effect on variation in warp yarn tension. During the weaving process variation in tension become smaller by the swinging motion of backrest roller's. It could be possible to obtain a suitable relationship between movements of the backrest roller and tension of warp during running at high speed [6]. Sheikhzadesh and his colleagues investigated the relationship between the ration of the force applied on the warp yarn by the backrest roller to the warp yarn [7]. They also find out the vertical and horizontal displacement of the backrest roller with the variation in warp beam radius during the weaving process as the beam diameter decreases with the advancement of weaving process. Weinsdorfer and his colleagues [8] studied the relation between shed geometry and warp tension. The distribution of warp tension over the warp width connected with the changes in shed geometry (backrest positions). They found that by changing the shed geometry, the warp tension also varies. By lifting the backrest, the elongation of warp yarn in the lower shed increases, as a result the warp tension in the lower shed also increases. On the other hand, the warp tension in the upper shed decreases.

Turhan and his colleagues [9] formulated experimental, computational intelligence depended and statistical investigations of warp tensions in different backrest oscillations. To have different backrest oscillations, springs with different stiffness were used. For each spring, fabrics with various weft densities were woven, and the warp tensions were measured and saved during the weaving process. The empirical data were analysed by using linear multiple and quadratic multiple regression, and an artificial neural network model. Osthus and his colleagues [10] reported that the warp end tensions are influenced by changing the height of the backrest roller. They evaluated the fabric appearance using an image processing system. The results for different backrest heights show that in the higher position of the backrest, the colour of the fabric become darker; and the fabric density is greater with an increasing backrest height. Turhan and Eren [11] inspected the effect of weaving machine settings on the weave ability limits of air-jet machines. They found that changing the shed adjustment from the zero level of the backrest to higher values increased the maximum weave able weft density slightly; however, increasing the shed asymmetry further (backrest height) has no significant influence on the weave ability limit. Haghighat and his colleagues [12] studied the effect of the backrest roller position on the physical and

mechanical properties of worsted fabrics. The results showed that the position of the backrest roller has a significant effect on the breaking strength in the warp direction, weight per area unit, and thickness of fabric.

During weaving warp tension will be frequently changes due to the decrease in beam diameter with continuous weaving. To maintain constant warp tension from full to empty warp beam synchronized warp let-off and take up mechanism has been developed. Because tension variation may lead irregularity in weft density, physical properties and coloring of woven fabric. Hence, it is recommended to keep the average warp tension at constant level and if the mean warp tension during every cycle of the loom was the same throughout a warp, let off would be considered perfect from this angle of view [13]. Let off are of two types like positive let off and negative let off. In case of positive let off motions (mechanical or electrical) the backrest is used as a measuring element of warp tension. Changing of backrest position effects on warp tension. To compensate the warp variation the amount of warp which is unwound from the beam should be changed. In modern weaving machine the backrest oscillates due to the exerted tension on it. The backrest is supported by a couple of strong spring. There is a load cell to measure the tension of the warp sheet.

Finally, after the adjustment of warp tension (to have a constant length of warp sheet in the weaving zone) the backrest moves to its original position (because of force applied on it by using spring having weights). By controlling the backrest roller in the specific position, warp tension variation during weaving will be kept constant. The changing of the warp beam diameter is the main reason of warp tension variation during weaving will be kept constant. A constant length of warp sheet in the weaving zone the backrest moves to its original position (because of force applied on it by using spring, having weights). By controlling the backrest roller in the specific position, warp tension variation during weaving will be kept constant. The changing of the warp beam diameter is the main reason of warp tensions variation. Hence, different studies have been explained on mechanical and electronic let-offs. During 1950, Hunt mechanical let-off was installed on British and American weaving machines [14]. Sulzer Ruti Company invented let-off mechanism that used servo motor for feeding warp yarn. The motor speed was controlled by the position of backrest roller (tension bar). Lunenschloss and Schlichter observed that DC motors or special synchronous motor can be used for electronic let-off [15]. In mechanical let off mechanism, leverage mechanism has to be used to control the position of backrest roller, but in electronic let-off there are different methods to control the variation in tension in warp sheet. Now a days, the conventional method for measuring the warp tension in electronic warp let-off incorporate in backrest roller in other word the backrest roller works like a measuring tool for warp tension [16].

## **2. Materials and Methods**

The looms were manufactured by Promatech and branded as Leonardo HI drive and Leonardo silver looms. The origin of the loom is Italy. Leonardo is an automatic rapier loom. Here shedding mechanism is electronic dobby system, picking is flexible double rapier system and beating is modern cam beat up system. In case of HI drive version automatic rpm change is possible without changing driver and driven pulley. The details of the loom is give in table 1.

**Table 1:** Details of the Leonardo loom

Model	Leonardo- Hi drive
Machine width	1900 cm
No. of frames	up to 20 healds
Speed (rpm)	250-620
Reeded width	65 inch
Weave	Any Design
Count	up to 80 Ne
Weight	4600 kg
Year of manufacturing	2006

The simplified view of the Leonardo loom is illustrated in the following Figure (Figure.1)

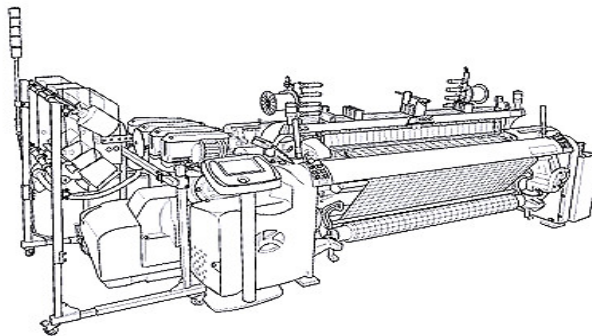

**Figure 1:** Leonardo- Hi Drive loom

In the looms required tension and settings are recorded. The data are collected with changing the settings like backrest, dropper line etc. Then by comparing the data of two looms with keeping all settings identical except the experimental one a result has been found. The tension per end is measured by tension meter (figure 2) in centinewton (cN).



**Figure 2:** Digital yarn tension meter

### 2.1. Various setting points

In loom there are various setting points. They are-

- Backrest roller position (horizontal displacement of backrest roller)
- Backrest height (vertical displacement of Backrest roller)
- Dropper position (distance of dropper line from backrest)
- Dropper height (vertical movement of dropper line)

### 2.2. Effect of changing backrest position

Backrest roller is a crucial part of weaving machine. Proper positioning of backrest roller may give good quality of fabric it also helps to achieve good efficiency. It is investigated earlier that upper position of backrest roller increase tension of lower shed and lower position of backrest roller increase the tension of upper shed. Several looms were analyzed in order to establish a relationship between backrest position and tension. In figure 3 the backrest position and backrest height is depicted.

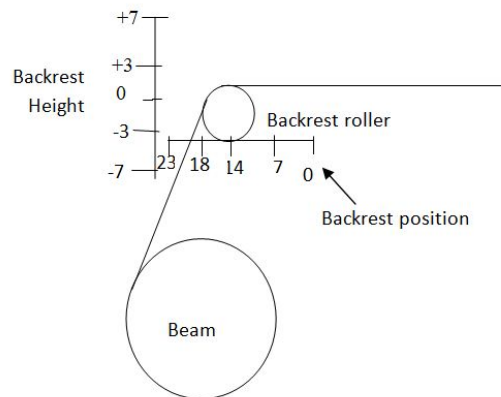

**Figure 3:** Backrest roller position and height

The observation is done with an identical setting of backrest height, dropper position (distance from backrest to dropper line), and dropper height but difference in backrest position.

### 2.3. Effect of changing backrest height

Backrest roller can be moved upward and downward. The schematic diagram of the backrest height changing is shown in the figure 3. In this case the all parameters like backrest position, dropper position, and dropper height except backrest height are kept constant.

### 2.4. Effect of changing dropper position

Dropper position is defined as the distance of dropper line from backrest roller. The dropper line may move

horizontally to backrest or heald frame. The distance of dropper line from heald frame is defined as dropper depth (shown in figure 4) for assessing the effect of changing dropper position all parameters except dropper position is kept constant.

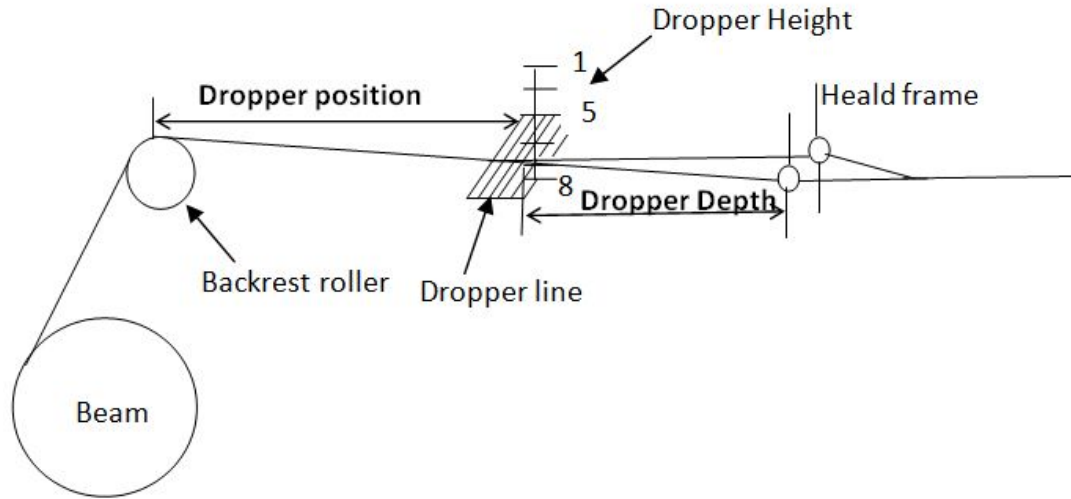

**Figure 4:** Dropper position and dropper height

**2.5. Effect of changing dropper height**

The dropper line may be moved vertically. It can be moved upward or downward. If the dropper line is upward then the value of dropper height will be higher whether the downward movement of dropper line will lessen the value of backrest height (shown in Figure.5). But if the dropper line is situated closer to the heald frame then this effect will be nullified by the effect of dropper position.

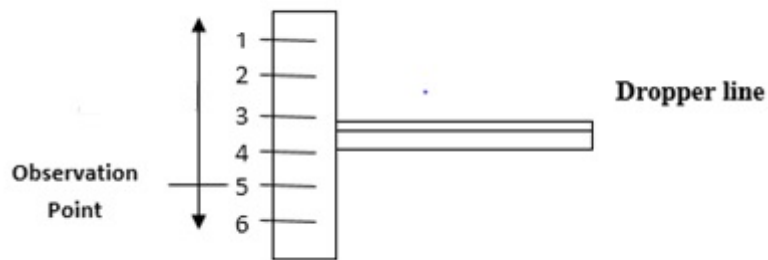

**Figure 5:** Dropper arrangement downward movement will reduce dropper height

**2.6. Effect of different fabric structure**

Fabric structure or weave has substantial influence on warp tension and it is shown in table 2. Longer floating or less interlacement of warp and weft require low warp tension. When  $\frac{2}{2}$  (2) matt or  $\frac{2}{2}$  herringbone or  $\frac{3}{1}$  twill

or  $\frac{2}{2}$  (3) matt or any weave other than plain (1/1) are produced then it is needed lower tension than that of plain weave. For assessing the effect of weave on tension we have assigned plain weave and other weave in 6 looms with identical settings. The observations are tabulated in table 2. Here the (-) ve sign indicates downward position of backrest height. It is seen from the table 2 that tension per end of 2/2 herring bone,  $\frac{2}{2}$  (2) matt are always lower than that of plain weave.

**Table 2:** Effect of fabric structure on warp tension

Observations	Backrest position	Backrest Height	Fabric structure	Tension (cN)
1	20	0	2/2 herringbone	26
	20	0	plain	34
2	14	0	$\frac{2}{2}$ (2) matt	23
	14	0	plain	27
3	19	0	$\frac{2}{2}$ (2) matt	25
	19	0	plain	27
4	17	-2	2/2 herringbone	32
	17	-2	plain	34
5	15	0	$\frac{2}{2}$ (2) matt	20
	15	0	plain	24
6	12	-3	$\frac{2}{2}$ (3) matt	25
	12	-3	plain	31

It is seen from the Table 2 that tension per end of 2/2 herring bone,  $\frac{2}{2}$  (2) matt,  $\frac{2}{2}$  (3) matt are always lower than that of plain weave. Because the interlacement in plain weave is more than that of any other weaves. So plain weave always needs higher tension than that of other weaves.

### 3. Discussion of Results

#### 3.1 Effect of changing backrest position

The observation is done with an identical setting of backrest height, dropper position (distance from backrest to dropper line), and dropper height but difference in backrest position.

From the figure 6 and table 3 it is seen that tension tends to increase with the increase of backrest position from 11cm to 16cm. But after backrest position 16cm it tends to decrease.

**Table 3:** Backrest roller position on warp tension

Backrest position (cm)	Dropper height (cm)	Dropper Position (cm)	Dropper height (cm)	Tension /End (cm)
11	0	35	5.5	27
13	0	35	5.5	31
14	0	35	5.5	32
16	0	35	5.5	33
18	0	35	5.5	31
19	0	35	5.5	28
20	0	35	5.5	27

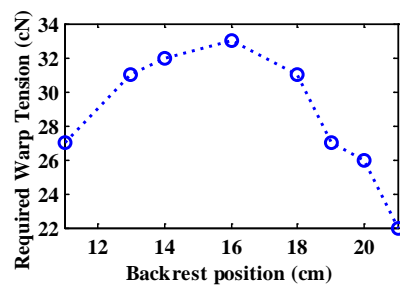

**Figure 6:** Effect of backrest roller position on warp tension

The effect of Backrest position is influenced by the position of dropper line. At the nearest backrest position (i.e 11 cm to 16cm at Leonardo loom) increasing backrest position will put the dropper line at the middle of the warp yarn. The dropper impose more downward tension by its weight when it is at the middle so more tension will be required to make the warp yarn proper level. But for the higher backrest position (i.e above 17cm at Leonardo loom) where dropper line is kept constant position from backrest (i.e dropper line comes relatively closer to the backrest) then the backward movement of the backrest roller will reduce the required tension. (as shown in graph in figure 6).

### 3.2 Effect of changing backrest height

The effect of backrest height is illustrated in figure 7 and table 4. Here the digit having (-) ve sign indicates downward position and the digit without sign indicates upward position of backrest. The required warp tension will be low when the backrest is moved downward but it increases with the increase of backrest height. From the figure 7 it is seen that downward position of backrest roller will require low tension but upward position of



backrest roller will require high tension

**Table 4:** Backrest height on warp tension

Backrest position (cm)	Backrest Height (cm)	Dropper position (cm)	Dropper Height (cm)	Tension/end (cN)
18	-2	36	5	30
18	-3	36	5	26
18	0	36	5	31
18	1	36	5	33
18	2	36	5	34

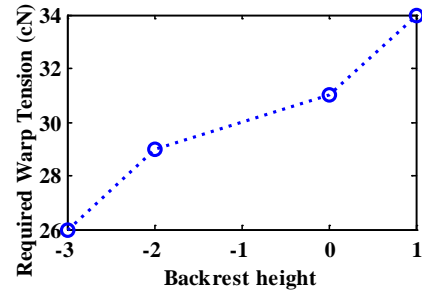

**Figure 7:** Effect of backrest height on warp tension

**3.3 Effect of changing dropper position**

The effect of dropper position on warp tension is shown in the figure 8 and table 5. Dropper position means the distance between backrest to dropper line.

Required warp tension increase with the increase of dropper position. From figure 8 it is seen that when dropper position from backrest increases then the required tension on warp yarn will be more.

Increasing dropper position means the movement of dropper toward the heald frame which ultimately needs more tension.

**Table 5:** Dropper position on warp tension

Backrest position (cm)	Backrest Height (cm)	Dropper position (cm)	Dropper Height (cm)	Tension /end (cN)
18	0	32	5	28
18	0	33	5	29
18	0	35	5	31
18	0	37	5	32
18	0	41	5	33

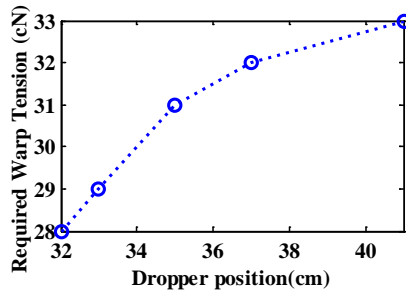

**Figure 8:** Effect of dropper position on warp tension.

**3.4 Effect of changing dropper height**

The effect of dropper height is illustrated in figure 9 and table 6 with the increase of dropper height (lifting the dropper line) warp tension tends to decrease provided that the dropper line is situated at the middle of the warp. But if the dropper line is situated closer to the heald frame then this effect will be nullified by the effect of dropper position. From the figure 9 and table 6 it is observed that with the increase of dropper height the tension reduces if the dropper lies at the middle of the warp. Because increase of dropper height means lifting of dropper, which will decrease the downward tension imposed on the yarn.

**Table 6:** Dropper height on warp tension

Backrest position (cm)	Backrest Height (cm)	Dropper position (cm)	Dropper Height (cm)	Tension/end (cN)
18	0	36	5	33
18	0	36	5.5	31
18	0	36	6	29
18	0	36	6.5	26

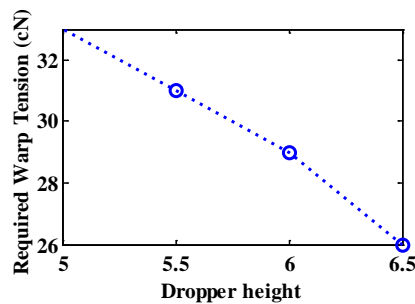

**Figure 9:** Effect of dropper height on warp tension.

### 3.5 Effect of fabric structure on tension

It was seen from the table.1 that tension per end of 2/2 herring bone , 2x2 Matt, 3x2 Matt are always lower than that of plain weave. Because the interlacement in plain weave is more than that of any other weaves (as shown in figure 10). So plain weave always needs high tension. From the following figures it is seen that the less interlacement is took place in case of  $\frac{2}{2}$ (3) matt, so less tension will be required here.

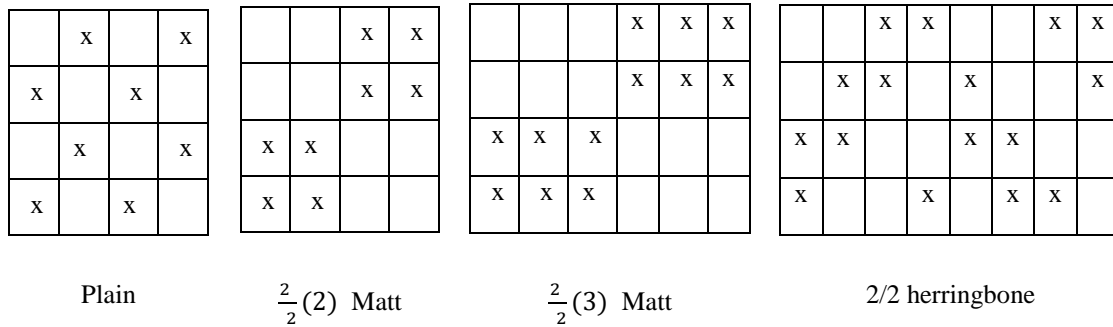

**Figure 10:** Weave of plain,  $\frac{2}{2}$ (2) Mat,  $\frac{2}{2}$ (3) Matt and 2/2 herringbone

### 4. Conclusions

Loom settings are frequently changed in the factory when fabric faults like weaving damage, starting mark etc. appear. And due to various structure of woven fabric the warp tension is needed to be changed. Here optimum tension plays an important role because with a little variation in weaving tension may cause different problems like warp breakage. From this study it will be easy to achieve optimum tension after changing loom setting. Moreover faults like starting mark are directly related to warp tension. The causes of the warp tension variation and the probable aftermath on warp tension variation is needed to be studied with modern technology like digital image processing. The loom settings may be optimized by using simulation technique like Fuzzy logic, genetic algorithm or Artificial Neural Network.

### 5. Limitations and Recommendations

The data has been taken when the loom is at the stoppage condition. It is too difficult to take the data on different positions especially near about the heald frame, as the yarn swing and tension fluctuate. It can be done to measure actual tension in running stage of the loom by applying statistical tools from a wide number of data. The study on influencing factors of warp tension is a matter of higher degree research. It includes research based on textile physics, mathematical evaluation, modern simulation techniques etc. simultaneously. The implication of this study lies in solving the problem of starting mark. Research should be conducted on effect of warp tension on starting marks and probable solution of starting marks by adjusting the warp tension in a correct manner.

## References

- [1]. Adanur S. Handbook of Weaving. Technomic Publishing Company, Inc., Lancaster, Pennsylvania, USA, 2001.
- [2]. Ronz C, Scholze G. Influence of Warp Tension on Fabric Quality in Air Jet Weaving. *Melliand Textilberichte* 1993; 74(11): E378
- [3]. Weinsdorfer H, Chen M. Warp Tension Simulation in Weaving. *Melliand Textilberichte* 2000; 81(7): E148- E149.
- [4]. Adanur S, Qi J. Property Analysis of Denim Fabrics Made on Air-jet Weaving Machine Part I: Experimental System and Tension Measurement. *Textile Research Journal*. 2008; 78(1): 3-9.
- [5]. Adanur S, Qi J. Property Analysis of Denim Fabrics Made on Air-jet Weaving Machine: Effects of Tension on Fabric Properties. *Textile Research Journal*. 2008; 78 (1): 10-20.
- [6]. Kloppels M, Gries T, Bosing T, Potthoff F-J. Practical Trial of the Freely Programmable Active Backrest Roller System. *Melliand-International* 2002; 8(2): 115-116.
- [7]. Sheikhzadeh M, Hosseini SA, Darvishzadeh M. Theoretical Evaluation of Warp Tension Variations during Weaving Process. *Indian Journal of Fibre Textile Research*. 2007; 32(3): 337-380.
- [8]. Weinsdorfer H, Wolfrum J Stark U. The Distribution of the Warp End Tension over the Warp Width and how it is influenced by the Weaving Machine Setting. *Melliand Textilberichte* 1991; 72(11): E360-E362.
- [9]. Turhan Y, Tokat S, Eren R. Statistical and Computational Intelligence Tools for the Analyses of Warp Tension in Different Back-rest Oscillations. *Information Sciences* 2007; 177: 5237-5252.
- [10]. Osthus T, Wulfhorst B, Bosing T, Lanvermann G, Potthoff F-J. Automatic Setting of Backrest and Drop-wires in Mill Trial. *Melliand Textilberichte* 1995; 76 (10): E207- E209.
- [11]. Turhan Y, Eren R., The Effect of Loom Settings on Weavability Limits on air-jet Weaving Machines, *Textile Research Journal*. 2012; 82(2): 172-182.
- [12]. Haghghat E, Hadizadeh M, AlamdarYazdi AA. The Effect of Backrest Movement on the Physical and Mechanical Properties of Worsted Woven Fabrics. In: 8<sup>th</sup> National Conference on Textile Engineering, Yazd, Iran, 2012.
- [13]. Foster R. Positive Let-off Motions, Wool Industries Research Association, Leeds 1961.
- [14]. Deroche P, L'Industrie Text, 1195 (1989) 47, 3 and Traynard O, L' Industrie Text 198: 51.
- [15]. Lunenschloss J, Schlichter S, Influence of Various Machines and Material Parameters on Properties and Appearance of Goods By The Installation Of Electrically Controlled Warp Let Off On Filament Yarn Weaving Machines, *Melliand* 1987; 11: 821.
- [16]. Robinson ATC, Marks R, Principles of weaving (The Textile Institute) 1976; 178