



POLITECNICO DI TORINO  
Repository ISTITUZIONALE

Rail Potential Calculation: Impact of the Chosen Model on the Safety Analysis

*Original*

Rail Potential Calculation: Impact of the Chosen Model on the Safety Analysis / Colella, Pietro; Pons, Enrico; Tortora, Andrea. - ELETTRONICO. - (2018), pp. 1-6. ((Intervento presentato al convegno 110th AEIT International Annual Conference, AEIT 2018 tenutosi a Bari (IT) nel 3-5 October 2018.

*Availability:*

This version is available at: 11583/2724232 since: 2020-01-16T16:38:27Z

*Publisher:*

Institute of Electrical and Electronics Engineers Inc.

*Published*

DOI:10.23919/AEIT.2018.8577295

*Terms of use:*

openAccess

This article is made available under terms and conditions as specified in the corresponding bibliographic description in the repository

*Publisher copyright*

iee

copyright 20xx IEEE. Personal use of this material is permitted. Permission from IEEE must be obtained for all other uses, in any current or future media, including reprinting/republishing this material for advertising or promotional purposes, creating .

(Article begins on next page)

# Rail Potential Calculation: Impact of the Chosen Model on the Safety Analysis

Pietro Colella\*, Enrico Pons\*, Andrea Tortora<sup>§</sup>

\* Politecnico di Torino, DENERG, Torino, Italy, [pietro.colella@polito.it](mailto:pietro.colella@polito.it)

<sup>§</sup> Gruppo Torinese Trasporti (GTT S.p.A.), Torino, Italy, [tortora.a@gtt.to.it](mailto:tortora.a@gtt.to.it)

**Abstract**—In Traction Electrification Systems (TEEs), a current flows into the rails both in normal operation and fault conditions. Therefore, in both cases, a voltage between rails and earth, called *Rail Potential (RP)*, occurs. The international Standard EN 50122-1 requires to evaluate the RP on the basis of the voltage drop in the return circuit. In this work, this approach is named Voltage Drop Method (VDM). Usually, in this approach, the rails are considered isolated from ground, the type of interconnection between the negative pole of the converter and the grounding system of the TPS is not taken into account, and the RP in a generic point of the railway is computed multiplying the current flowing in the return path and the longitudinal resistance of the rails up to the Traction Power Substation (TPS). If the RP exceeds the maximum permissible effective touch voltages, function of time, indicated by EN 50122-1, provisions to reduce the electrocution risk shall be applied. Even if the VDM generally provides conservative values for the RP, it cannot be considered completely faithful, due to the simplifying assumptions usually adopted. Therefore, the decision process to evaluate if some measures to reduce the RP shall be adopted can lead to wrong results. In this work, a faithful circuital model of the railways was used to compute the RP for several scenarios; a comparison with the results computed by VDM was carried out. The goal is to evaluate the trustworthiness of the VDM, highlighting the differences with a more faithful model.

**Index Terms**—rail potential; railway; safety; touch voltage; voltage drop method

## I. ACRONYMS AND NOMENCLATURE

OCL	Overhead Contact Line
RP	Rail Potential
TES	Traction Electrification System
TPS	Traction Power System
VDM	Voltage Drop Method
VLD	Voltage-Limiting Device
VLD-O	Voltage-Limiting Device of Type 2
$U_{te,max}$	Maximum permissible effective touch voltage

## II. INTRODUCTION

DC railway networks are normally divided into linear sections. Each section can be fed by one or two Traction Power Substations (TPSs), located at one or both ends, respectively. TPSs contain power transformers, AC/DC converters and circuit breakers. Positive cables interconnect the positive pole of AC/DC converters to Overhead Contact Lines (OCLs), which are conductors for supplying traction units with electrical energy via current-collection equipment [1], [2]. The return circuit for the traction current is composed by the running rails,

which are interconnected to the negative pole of the converter through the negative cables [3], [4]. The negative pole of the converter can be grounded to the earthing system of the TPS or kept floating [3].

During normal operation, when a traction current flows through the rails, a voltage occurs between each point of the running rails and the negative pole of the converter. At the same time, a voltage can be measured between rails and remote earth, whose electric potential is taken as equal to zero. This voltage is referred to as Rail Potential (RP). According to the interconnection strategy between the negative pole and earth, the RP distribution can be different.

In case of fault scenarios, a similar behavior can be observed. During the railway lifetime, several unfortunate events can occur: for example, the OCL can fall down or a broken current collector can get in touch with a metallic element along the rails. According to the conventional protection strategy, the metallic objects in the proximity of the rails shall be interconnected to the return circuit [5]. In fact, if this condition is fulfilled, the path of the fault current is characterized by a low impedance with a consequent increment of the ground fault current magnitude. The ground fault can therefore be easily detected and cleared by the circuit breaker in the TPS. Also in this case a voltage occurs between running rails and earth, as well as between rails and the negative pole of the converter. The lower the RP, the lower the risk of electrocution for people. The higher the RP, instead, the higher the touch voltage.

If the negative pole is solidly grounded, earth can be considered a second path for traction and fault currents. According to the value of the conductance to earth of the rails, a significant current can be leaked into the ground with a consequent reduction of the RP. This current is normally referred to as “stray current” [3]. If this configuration is the most convenient for the protection against electrocution, stray currents can cause serious damage to the metallic structures located near the railway: any buried metallic element can be considered as a low impedance path for stray currents; at the points where the current leaves its metallic path to return to the earth, an electrolysis reaction occurs with a consequent corrosion of the object [6]. This event is particularly dangerous if reinforced concrete infrastructures, such as bridges, metal tanks or earthing systems are involved. On the other hand, if the negative pole is kept floating, stray currents are signifi-

cantly reduced (four times less than in an equivalent grounded system) but touch voltages can increase [3].

The International Standard EN 50122 provides the technical compromise to manage both touch voltages and stray currents [1], [2]. In particular, it provides criteria for bonding and earthing, based on the dimensions and electrical properties of the metal objects in the proximity of the railways. In this context, EN 50122 requires to evaluate the RP for normal operation and for fault conditions. If touch voltages exceed the maximum permissible effective touch voltages  $U_{te,max}$ , that are function of time, measures to reduce the risks of electrocution are suggested. Standard EN 50522-1 suggests for example the reduction of the feeding section length, the increment of the return circuit conductance, the insulation of the standing surface, or the installation of Type 2 Voltage-Limiting Devices (VLDs-O). These devices have a high resistance when the applied voltage is below a specified level and become conductive when the specified level is exceeded [1]. In other words, if no dangerous touch voltages occur, the return circuit can be considered isolated from ground (except for the natural conductance to ground of the rails), with a reduction of the stray currents. Otherwise, an equipotential bonding is provided, with advantages for electrical safety. VLDs-O are normally connected between the return circuit and structure earth, e.g. in passenger stations or TPSs.

The method suggested by the Standard to evaluate the RP is based on the voltage drop in the return circuit. Usually, when Voltage Drop Method (VDM) is adopted, simplifying hypothesis are assumed: the type of interconnection between the negative pole of the converter and the grounding system is not taken into account (negative poles solidly grounded, isolated and interconnected through VLDs-O are considered the same); the conductance to earth of the rails is neglected.

Though at first glance, VDM is for the sake of safety (in the sense that current is supposed to flow only through the rails, with an increment of the computed RP), it can provide an erroneous RP distribution profile.

The decision process to evaluate if VLDs-O are required and, eventually, their positions can be mistaken.

In this work, a circuital model of the railways was implemented, considering also the presence of VLDs-O and the conductance to earth of the rails. The model is presented in Section IV.

The goal is to evaluate the error in the RP calculated with the VDM and the possible associated problems in the choice and positioning of the VLDs.

### III. VOLTAGE DROP METHOD

Standard EN 50122-1 requires to compute the RP. One of the most common methods is to adopt the VDM, that is, to compute the voltage drop in the return circuit both for normal operation and for fault condition. Usually, the rails are considered isolated from ground and the type of interconnections between the negative pole of the converter is not taken into account.

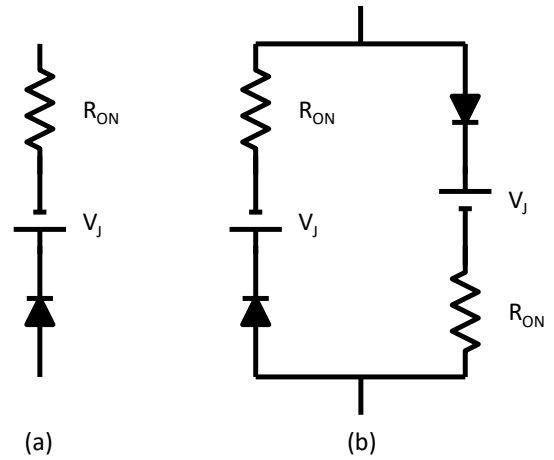

Fig. 1. VLD-O models: (a) unidirectional; (b) bidirectional devices.

The steady-state RP in a point distant  $d$  from the TPS, computed by VDM ( $RP_{VDM}$ ), can therefore be estimated through eq. (1):

$$RP_{VDM} = r_{RC} \cdot d \cdot I \quad (1)$$

where  $r_{RC}$  is the resistance per unit length of the return circuit and  $I$  is the current in the return circuit [5], [7].

### IV. CIRCUITAL MODEL

For the computation of the RP distribution in normal operation and in case of ground fault, each component of the Traction Electrification System (TES) is modeled as presented in the paragraphs below. The blocks representing the different components are then assembled and finally the full model is solved using the node method to calculate the steady-state currents in all branches and the voltages in all nodes.

#### A. Substations

The transformer and rectifier group is modeled as a Thevenin equivalent. The equivalent voltage source  $V_{eq}$  is the rated open circuit voltage of the considered railways, while the equivalent series resistance  $R_{es}$  can be deduced by the data-sheet provided by the manufacturer, by field measurement and analytical or numerical simulations [8].

The local grounding grid is modeled as a resistance.

In TPS, the rails can be solidly grounded, kept floating or interconnected to the local earthing system through a VLD-O. In the first two cases, the interconnection is modeled as a short-circuit and an open circuit, respectively. If a VLD-O is present, it can be modeled, as shown in Fig. 1, as an ideal diode in series with a voltage source  $V_J$  and a resistance  $R_{ON}$ , which are chosen according to the VLD-O forward biased characteristic. VLDs-O are unidirectional or bidirectional devices. In the first case, attention shall be paid to the polarity of the series circuit of Fig. 1-a that has to be modeled; in the latter case, two unidirectional VLD-O models are connected in anti-parallel, as shown in Fig. 1-b.

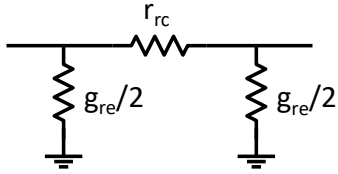

Fig. 2. Rail model.

For each TPS, circuit breakers are modeled only in case of faults. First the fault current is computed not considering the current-limiting effect of the circuit breakers. Then, the limited fault current and the duration of the fault are evaluated according to the circuit breaker characteristic trip curves.

### B. Overhead Contact Lines and Positive Cables

Each section of OCL that interconnects a train or a fault to a TPS is modeled as the series of an inductance and a resistance, whose values are computed on the base of the per-unit length characteristics of the conductor.

The resistance of positive cables is instead neglected.

### C. Return Circuit

Rails are modeled as the series of several elementary pi-models, as the one shown in Fig. 2. The longitudinal resistance of the return circuit  $r_{rc}$  and the shunt conductance to ground  $g_{re}$  of each cell are computed according to the per unit length characteristics of the rails.

### D. Train

A train is modeled through an ideal current generator  $I_T$ , positioned between the OCL and the rails.

### E. Fault

The fault is modeled with a resistance, named  $R_f$ , which interconnects the OCL and the rails.

## V. CIRCUITAL MODEL VALIDATION

Field measurements were conducted in a real TES in order to validate the analytical model. In paragraph V-A, measurement setup and results are presented. In paragraph V-B, a comparison between the measured RP and those computed by the circuital model is carried out.

### A. Field measurements

In order to validate the model, field measurements were carried out on the railway named “Canavesana”, operated by Gruppo Torinese Trasporti (GTT), in normal operation. A schematic view of the railway is reported in Fig. 3. The main parameters required for the railway model are reported in Table I. Two TPSs feed the TES. Bidirectional VLDs-O, characterized by a tripping threshold of 200 V, are installed in each TPS to interconnect rails to the TPS earthing system.

The measurements were conducted in the railway section between the TPS “San Benigno” and the passenger station “Rivarolo”, as shown in Fig. 3. This section is fed by only

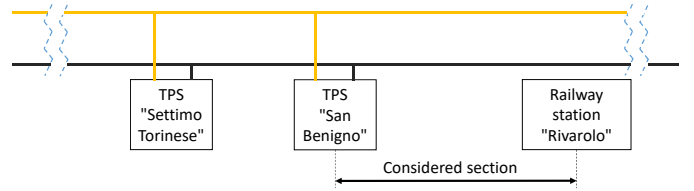

Fig. 3. Schematic view of the railway “Canavesana”.

TABLE I  
MAIN CHARACTERISTICS OF THE RAILWAYS

Parameter	Unit	Value
Rated open-circuit voltage	[V]	3800
Longitudinal resistance p.u.l. of the rails	[ $\Omega$ / km]	0.02
Resistance p.u.l. of the OCL	[ $\Omega$ / km]	0.059

the TPS “San Benigno”. The rails run upstream the TPS and downstream the railway station.

The measurement setup is outlined in Fig. 4. Two highspeed recorders (HIOKI MR8880-20) were installed near the TPS “San Benigno” and near the station “Rivarolo” in order to measure the RP at both ends of the considered railway section, as well as the traction current. The sampling time was 1 ms. The full-scale was set to 100 V for the RP and to 500 mV for the current, corresponding to 1000 A due to the A/V ratio of the current clamp.

For the RP measurements, earth rods were buried far away from the railways in order to get the “zero potential”.

The traction current was measured by AC/DC current clamps (HIOKI 3285), with full-scale set to 2000 A, installed at the negative cables, as shown in Fig. 5, in the proximity of the TPS “San Benigno”. For a simpler comparison between the measured and computed analysis, only a train was present in the considered section.

### B. Comparison between experimental and analytical results

The scenario characterized by the highest measured RP was chosen to carry out the comparison. It occurred when the train left the railway station “Rivarolo” and the traction current was 494 A. In the model, a conductance to earth  $g_{re}$  equal to

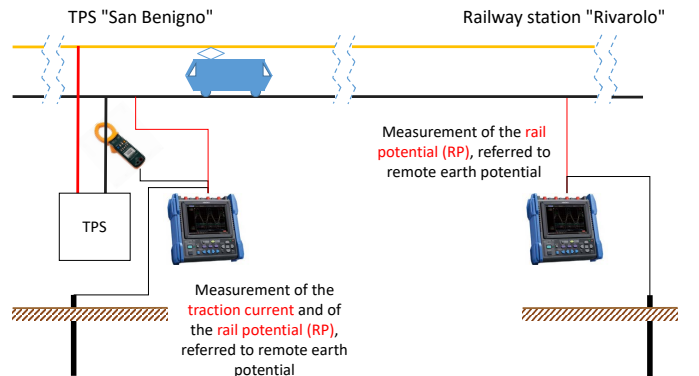

Fig. 4. Measurement setup.

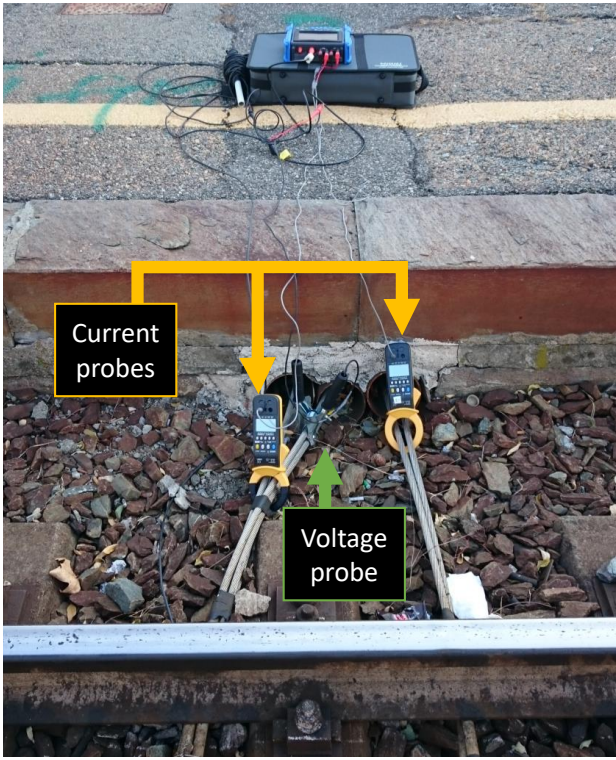

Fig. 5. Current and Voltage Probes.

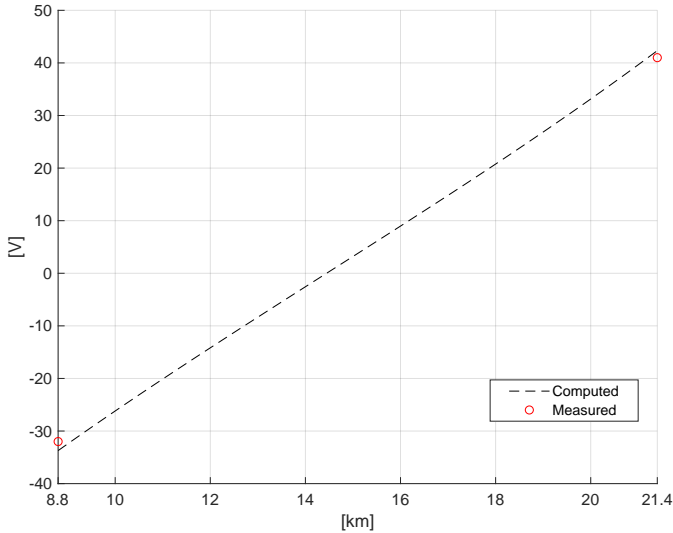

Fig. 6. Comparison between the computed and measured RP, when the train is in Rivarolo and the traction current is equal to 494 A.

0.35 S/km was set; this value is within the typical range for this parameter [2], [5], [9]. For this scenario, the comparison between the computed and measured RP is reported in Fig. 6: the circuital model is in a great accordance with the field measurement results.

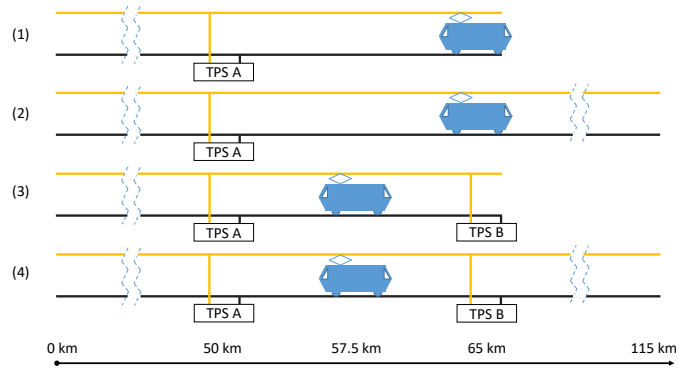

Fig. 7. The considered case studies.

## VI. COMPARISON BETWEEN THE CIRCUITAL MODEL AND THE VOLTAGE DROP METHOD

Four case studies are analyzed in order to compare the circuital model presented in section IV to the VDM. All of them are in normal operations, even if similar considerations can be done for fault conditions. The only differences would be the current and RP values.

For all the scenarios, the RP in a railway section 15 km long is computed. The OCLs of the different sections are connected in parallel through the DC bus bars in the TPSs, while the rails are never interrupted. The rail section is divided into 100 m elements, modeled as described in section IV-C and Fig. 2.

The per unit length longitudinal resistance and conductance to earth of the rails are considered 0.059  $\Omega/km$  and 0.35 S/km, respectively.

Only a train is present and the traction current is set equal to 500 A.

The scenarios differ for the number of TPS feeding the railway section (one TPS in scenarios 1 and 2, two TPSs in scenarios 3 and 4), for the position of the train (at the right endpoint in scenarios 1 and 2, and in the middle of the section in scenarios 3 and 4) and for the length of rails after the right endpoint of the considered section (0 km in scenarios 1 and 3, 50 km in scenarios 2 and 4).

### A. Case study 1

In case study 1, a railway section fed by only one TPS is modeled. The rails are interrupted at the right end of the section.

The RP distribution for case study 1 is reported in Fig. 8 for both the VDM and the circuital model. Since the RP at the negative pole of the converter is lower than the voltage threshold of the VLD-O installed in the TPS A, the rails can be considered floating (not considering their conductance to earth).

The maximum RP computed by the VDM is about 75% higher than that one obtained through the circuital model. This is mainly due to two reasons:

- in the VDM, the path through the ground is not taken into account, thus the entire traction current flows through the return circuit increasing the RP;

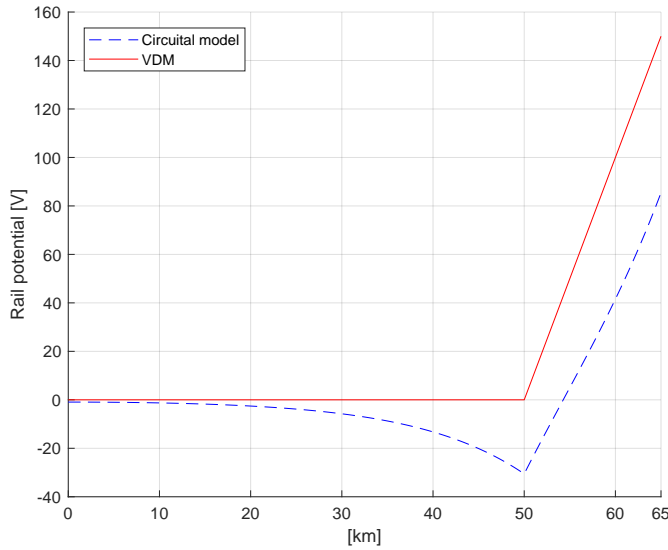

Fig. 8. Comparison between the RP computed by the circuital model and the VDM for the case study 1.

- in the VDM, the rails at the substation is tied to earth. Vice-versa, in the circuital model, it floats at a negative potential with reference to earth, reducing the RP in each point of the line. This is in line with the results available in literature [10].

However, the distribution profile and the maximum values are comparable. The results obtained with the VDM are for the sake of safety and they can be considered valid if the length of the rails outside the considered railway section is sufficiently high (e.g. in the case study, the portion of the rails on the left of the TPS, which is 50 km long). The shorter the length, the higher the error. If the rails were interrupted at both the ends, the zero voltage would be in the middle of the considered section with an error approximately equals to 50%.

### B. Case study 2

This scenario differs from case study 1 for the fact that 50 km long rails lay both before and after the considered railways section. It is quite uncommon considering that the railway section fed by only one substation are usually at the terminal part of railway lines and that a section is generally not longer than 20 km. However, it can occur, for example, when just a portion of the railway is electrified.

The comparison between the RP distribution computed by the circuital model and the VDM for case study 2 is reported in Fig. 9.

Also in this case, the maximum RP obtained by the VDM (150 V) is higher than that one gotten with the circuital model (42 V); the effects described in the paragraph VI-A are here accentuated by the presence of rails beyond the considered section. If the RP computed by VDM is always below  $U_{te,max}$ , no further actions are required as the results are for the sake of safety. Vice-versa, if RP is over the safety threshold, deeper analysis should be carried out to evaluate if measures to reduce

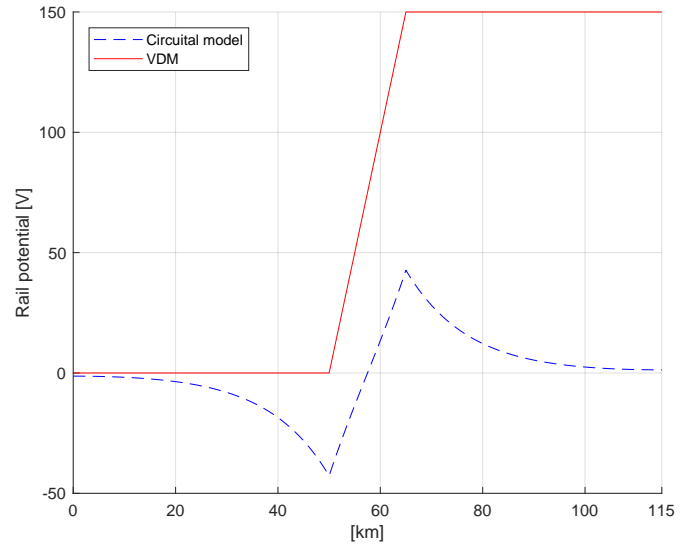

Fig. 9. Comparison between the RP computed by the circuital model and the VDM for the case study 2.

touch voltages are really necessary and, eventually, to identify the portion of the rails with the highest RP.

### C. Case study 3

This case study differs from case study 1 for:

- the position of the train;
- the presence of a second TPS that feeds the OCL.

The comparison between the RP distribution computed by the circuital model and the VDM for case study 3 is reported in Fig. 10.

As expected, the maximum RP is about 25% of that one computed in case 1: a coefficient 0.5 is due to the different length of the rails that determines the voltage drop on the return circuit, since the train is just in the middle of the section; an additional coefficient 0.5 is due to the presence of the two substations that split the traction current in two parts.

The maximum RP computed by the VDM is higher than the one computed with the circuital model, even if, in this case, the difference between the models is about 50%.

The RP distribution calculated by the two models has the same trend. Once again, the difference lays in the proximity of the TPSs.

### D. Case study 4

In this case study, probably the most common scenario is analyzed: two TPSs at both ends of the railway section feed the electrical load. Rails run upstream and downstream the considered section.

The comparison between the RP distribution computed by the circuital model and the VDM for case study 4 is reported in Fig. 11. The maximum RP computed by the VDM is 35% higher with reference to the circuital model. Anyway, it can be affirmed that the difference between the RP distribution profiles computed by the two methods is not significant from a practical point of view.

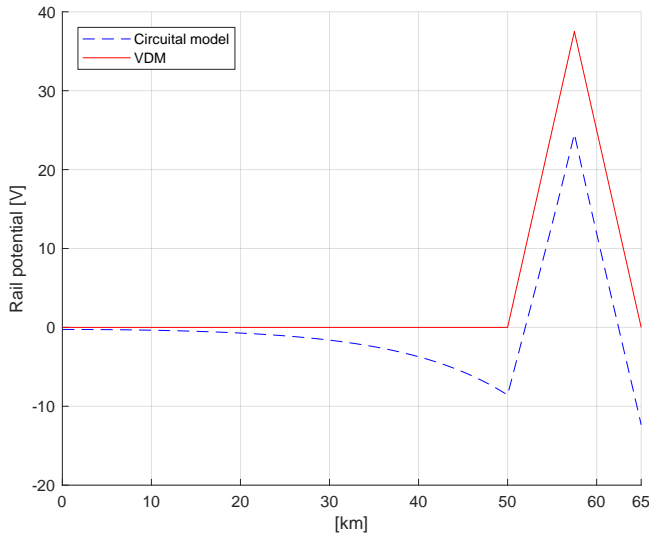

Fig. 10. Comparison between the RP computed by the circuital model and the VDM for the case study 3.

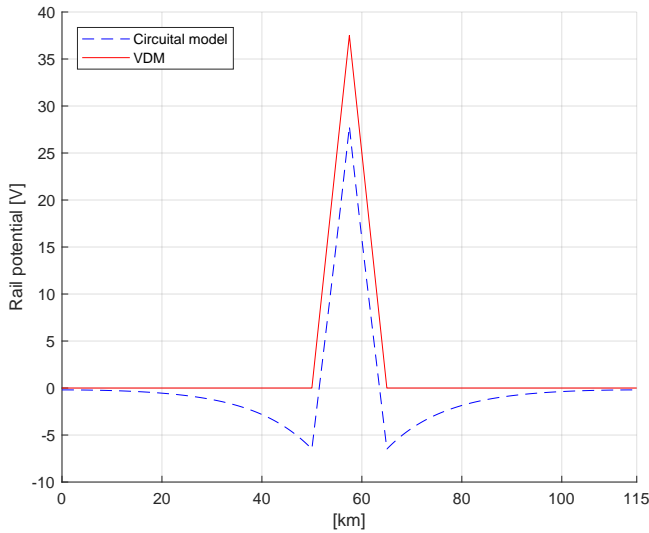

Fig. 11. Comparison between the RP computed by the circuital model and the VDM for the case study 4.

## VII. CONCLUSION

The International Standard EN 50122-1 requires to compute the Rail Potential both for normal operation and for fault conditions. If the RP exceeds the maximum permissible effective touch voltage  $U_{te,max}$ , measures to reduce the electrocution risk should be adopted. For example, Voltage-Limiting Devices of Type 2 (VLDs-O) can be installed in passenger stations or in Traction Power Substations (TPSs) to achieve an equipotential bonding between the rails and the local earthing systems (normally disconnected in a DC railway to reduce the stray currents) and therefore to equipotentialize the area.

EN 50122-1 requires to evaluate the RP on the basis of the Voltage Drop Method (VDM). When this method is adopted, some simplifying hypothesis are usually made: the conduc-

tance to earth of the rails is usually neglected and the negative pole of the AC/DC converter is considered directly bonded to the local earthing system of the TPS. In this work, a more complete circuital model to compute the Rail Potential (RP) was developed and validated throughout field measurements.

Four case studies were analyzed and the RP distributions computed with the two methods were compared. According to the results, it can be concluded that the maximum RP computed through the VDM is always higher than the one calculated with the circuital model. Moreover, the two methods generally provide a comparable RP distribution, even if, according to the characteristics of the railways, differences can be noticed, especially in the proximity of the TPSs.

In conclusion, if the RP computed by the VDM is always below  $U_{te,max}$ , no further actions are required, because the VDM provides safe results. If not, a more complete model should be implemented, such as the one developed in this work, in order to verify if RP really exceeds the permissible threshold and, if it is the case, to compute a more faithful RP distribution. In this way, the decision process to identify the position of VLDs-O would be fully supported.

## ACKNOWLEDGMENT

The authors would like to thank the personnel of GTT for their valuable support in this research.

## REFERENCES

- [1] *Railway applications - Fixed installations - Electrical safety, earthing and the return circuit - Part 1: Protective provisions against electric shock.* EN 50122-1, 08 2012.
- [2] *Railway applications - Fixed installations - Electrical safety, earthing and the return circuit - Part 2: Provisions against the effects of stray currents caused by d.c. traction systems.* EN 50122-2, 02 2012.
- [3] M. Niasati and A. Gholami, "Overview of stray current control in DC railway systems," in *International Conference on Railway Engineering*, vol. 2008. IET, 2008, pp. 1–6.
- [4] E. Pons, P. Colella, R. Rizzoli, and R. Tommasini, "Distinguishing short circuit and normal operation currents in dc urban light railway systems," in *Environment and Electrical Engineering and 2017 IEEE Industrial and Commercial Power Systems Europe (EEEIC/I&CPS Europe), 2017 IEEE International Conference on.* IEEE, 2017, pp. 1–6.
- [5] E. De Boni and E. Tartaglia, *Il coordinamento dell'isolamento per la protezione contro le sovratensioni e la sicurezza elettrica*, CIFI, Ed., 2001.
- [6] A. Ibrahim, A. Elrayyah, Y. Sozer, and J. A. De Abreu-Garcia, "Dc railway system emulator for stray current and touch voltage prediction," *IEEE Transactions on Industry Applications*, vol. 53, no. 1, pp. 439–446, 2017.
- [7] C. Spalvieri, R. Lamedica, F. Gatta, A. Ruvio, and L. Pantalone, "A simulation model to estimate touch voltage in dc railway systems," in *AEIT International Annual Conference (AEIT), 2016.* IEEE, 2016, pp. 1–6.
- [8] E. Pons, R. Tommasini, and P. Colella, "Fault current detection and dangerous voltages in dc urban rail traction systems," *IEEE Transactions on Industry Applications*, vol. 53, no. 4, pp. 4109–4115, 2017.
- [9] A. Mariscotti and P. Pozzobon, "Experimental results on low rail-to-rail conductance values," *Vehicular Technology, IEEE Transactions on*, vol. 54, no. 3, pp. 1219–1222, 2005.
- [10] K. Bahra and P. Batty, "Earthing and bonding of electrified railways," 1998.