



POLITECNICO DI TORINO
Repository ISTITUZIONALE

Resilience assessment at the state level

Original

Resilience assessment at the state level / Kammouh, Omar; Dervishaj, ; Cimellaro, GIAN PAOLO. - ELETTRONICO. - (2016). ((Intervento presentato al convegno 1st International Conference on Natural Hazards & Infrastructure (ICONHIC2016) tenutosi a Chania, Greece nel 28-30 June, 2016.

Availability:

This version is available at: 11583/2656565 since: 2019-08-02T16:30:32Z

Publisher:

United Nation Office for Disaster Risk Reduction (UNISDR)

Published

DOI:

Terms of use:

openAccess

This article is made available under terms and conditions as specified in the corresponding bibliographic description in the repository

Publisher copyright

(Article begins on next page)

Resilience assessment at the state level

Omar Kammouh, Glen Dervishaj, Gian Paolo Cimellaro¹,
Politecnico di Torino

ABSTRACT

This paper presents an analytical approach to evaluate the level of post-disaster adaptation (Bounce-Back) of communities based on their resilience. While resilience is the intrinsic characteristics of a system, adaptation considers external agents in its assessment. The presented work is to some extent a parallelism to the risk assessment concept. Generally, risk is a function of vulnerability, exposure, and hazard, whereas adaptation considers resilience instead of vulnerability in its estimation. This leads to the evaluation of a system's ability to cope with after-shock consequences and to return back to a functional state rather than the likelihood of a system to experience damage. The paper also proposes a quantitative framework for assessing resilience at the state level based on the Hyogo Framework for Action (HFA), a work done by the UN. HFA has succeeded in assessing the resilience of every state in a quantifiable fashion. HFA estimates the resilience of countries based on a number of indicators that are weighted equally. Those indicators, however, do not contribute equally to the resilience output; therefore, it is necessary to weigh those indicators according to their contribution towards resilience. To do so, we are introducing the Dependence Tree Analysis (DTA), which identifies the strength of relationships between the indicators and the resilience, giving weights to the indicators accordingly. A full case study composed of 37 countries is presented in this paper, where the resilience and the Bounce Back indices of each country are evaluated.

Keywords: Community resilience, Vulnerability, Risk management, Hyogo Framework for Action

INTRODUCTION

Community Resilience has gained a great deal of attention quickly due to the recent unexpected natural and man-made disasters. Resilience itself is a broad and multidisciplinary subject. In engineering, resilience is the ability to “withstand stress, survive, adapt and bounce back from a crisis or disaster and rapidly move on” (Wagner & Breil, 2013). Allenby and Fink (2005) defined resilience as “the capability of a system to stay in a functional state and to degrade gracefully in the face of internal and external changes” (Allenby & Fink, 2005). According to Bruneau et al. (2003), resilience is “the ability of social units (e.g. organizations, communities) to mitigate hazards, contain the effects of disasters when they occur, and carry out recovery activities in ways to minimize social disruption and mitigate the effectors of further earthquakes”. The concept of resilience in the engineering field is more recent compared to other disciplines (Hosseini et al., 2016), which makes it difficult to agree upon a definition.

In the risk management, evaluating risk depends on three factors: vulnerability, hazard, and exposure. The vulnerability, in specific, is a critical factor to assess the overall risk (Papadopoulos, 2016). Vulnerability has long been linked to resilience in several scientific disciplines (Richard et al., 1998). According to Cardon et al. (2012), vulnerability can be seen as a lack of capacity, where increasing capacity means reducing vulnerability and vice versa. Manyena (2006) has gathered numerous definitions for resilience and vulnerability in an attempt to differentiate between them. Some definitions indicate that the two concepts are just the opposite sides of the same coin (Klein et al., 2003), while others suggest that resilience and vulnerability may coincide in some areas but they are definitely not the flip sides of each other (Gallopín, 2006). Generally, resilience is concerned more with the human capacity to recover from a disaster within a short time with no

¹ Corresponding Author: Gian Paolo Cimellaro, *Politecnico di Torino*, gianpaolo.cimellaro@polito.it

outside assistance, while vulnerability is the production of nature to resist the stress resulting from a natural hazard.

Risk is the probability of damage or any negative occurrence that is caused by internal or external agents. It is usually connected with the pre-disaster phase during which we have uncertainties about the occurrence and the intensity of disasters. Once the disaster occurs, the risk phase finishes, while the recovery phase starts. If vulnerability is replaced by resilience in the risk equation, the output would no longer represent a probability of damage, but rather a probability of adaptation to a given hazard. The new relationship resulting from replacing vulnerability by resilience would give an indication on the capacity of a system to bounce back to its initial, functional state. A new index, which is hereafter called “Bounce-Back” index, can be considered. This index is the combination between resilience, hazard, and exposure.

Due to the lack of a clear, systematic methodology, evaluating resilience is considered one of the hardest tasks. The United Nations (UN) through their advancements in the Disaster Risk Reduction have released an international blueprint, Hyogo Framework for Action (HFA), to help build the resilience of nations and communities. HFA proposed detailed measures to be adopted by the countries at the governmental and policy levels. The plan was to give participating countries the chance of implementing the HFA in their respective laws within the span of ten years, from 2005 to 2015. Afterwards, each government had to fill a periodic report regarding the advancement of their progress. The UN in their turn gave a score to each report based on criteria related to the achievements each country had made. While HFA estimates the intrinsic resilience of countries based on 22 equally weighted indicators, those indicators do not contribute equally to the resilience output; therefore, it is necessary to weigh them according to their contribution towards resilience. To do so, we are introducing the Dependence Tree Analysis (DTA), which identifies the strength of relationships between an event and its subevents (i.e. between resilience and its indicators), giving weights to the subevents (i.e. indicators) accordingly.

In this paper, we are proposing an analytical formulation to evaluate the level of adaptation in communities based on their resilience. This formulation allows obtaining a new index, Bounce Back index (BB), which takes into account the countries’ resilience, exposure, and hazard in its evaluation. Moreover, we are introducing a methodology to evaluate the resilience at the state level based on Hyogo Framework for Action (HFA), a work done by the UN. The framework allows classifying countries according to their resilience level. The resilience results are then used in the evaluation of the bounce back index. To illustrate this, a full case study composed 37 countries is presented in this paper, where the resilience and the Bounce Back indices of each country are computed.

BACKGROUND

Hyogo Framework for Action (HFA)

Hyogo Framework for Action (HFA), adopted in Kobe, Japan, is an international blueprint for disaster risk reduction and the implementation of laws regarding the risk of natural hazards (UNISDR, 2007). The framework is the result of a long initiative by the UN within the International Strategy of Disaster Reduction (ISDR), which builds upon the experience of the International Decade for Natural Disaster Reduction (1990-1999).

HFA’s main objective was to further increase awareness regarding disaster risk and to guide committed States in implementing strategies that would prevent loss of lives and the great economic impact caused by natural hazards. The framework is composed of 5 priorities for action. Each priority is met with a certain number of indicators, as listed in Table 1. These priorities outline the different sectors where countries should put their efforts in order to endorse disaster resilience. The purpose of the framework was to quantify the progress made by governments within fixed timeframes. The progress is calculated based on a five-point scale, where achieving one point implies poor advancements and little signs of planning and action, while on the other hand achieving five points indicates a great effort and commitment in that particular area (UNISDR, 2008).

With the conclusion of Hyogo and its ten-year plan, a new framework took its place for future years. The Sendai Framework is the updated and improved version of the HFA. It was adopted after the Third World Conference on Disaster Risk Reduction in Sendai, Japan (2015) (UNISDR, 2015b). Although the HFA raised the awareness for disaster risk reduction, a great number of lives were lost in the 10-year period of implementing Hyogo. In that regard, the Sendai framework emphasizes on the importance of early warning systems and risk assessment. Moreover, measuring progress will start after defining risk baselines and adopting the new indicators, which is expected to be discussed at the next session in 2017 (UNISDR, 2015a).

Table 1. Priorities and indicators used in the assessment of Hyogo framework

PRIORITY 1: Ensure that disaster risk reduction (DRR) is a national and a local priority with a strong institutional basis for implementation	
E1	National policy and legal framework for disaster risk reduction exists with decentralized responsibilities and capacities at all levels.
E2	Dedicated and adequate resources are available to implement disaster risk reduction plans and activities at all administrative levels
E3	Community Participation and decentralization is ensured through the delegation of authority and resources to local levels
E4	A national multi sectoral platform for disaster risk reduction is functioning.
PRIORITY 2: Identify, assess and monitor disaster risks and enhance early warning	
E5	National and local risk assessments based on hazard data and vulnerability information are available and include risk assessments for key sectors.
E6	Systems are in place to monitor, archive and disseminate data on key hazards and vulnerabilities
E7	Early warning systems are in place for all major hazards, with outreach to communities.
E8	National and local risk assessments take account of regional / trans boundary risks, with a view to regional cooperation on risk reduction.
PRIORITY 3: Use knowledge, innovation, and education to build a culture of safety and resilience at all levels	
E9	Relevant information on disasters is available and accessible at all levels, to all stakeholders (through networks, development of information sharing systems etc.)
E10	School curricula, education material and relevant trainings include disaster risk reduction and recovery concepts and practices.
E11	Research methods and tools for multi-risk assessments and cost benefit analysis are developed and strengthened.
E12	Countrywide public awareness strategy exists to stimulate a culture of disaster resilience, with outreach to urban and rural communities.
PRIORITY 4: Reduce the underlying risk factors	
E13	Disaster risk reduction is an integral objective of environment related policies and plans, including for land use natural resource management and adaptation to climate change.
E14	Social development policies and plans are being implemented to reduce the vulnerability of populations most at risk.
E15	Economic and productive sectorial policies and plans have been implemented to reduce the vulnerability of economic activities
E16	Planning and management of human settlements incorporate disaster risk reduction elements, including enforcement of building codes.
E17	Disaster risk reduction measures are integrated into post disaster recovery and rehabilitation processes
E18	Procedures are in place to assess the disaster risk impacts of major development projects, especially infrastructure.
PRIORITY5: Strengthen disaster preparedness for effective response at all levels	
E19	Strong policy, technical and institutional capacities and mechanisms for disaster risk management, with a disaster risk reduction perspective are in place.
E20	Disaster preparedness plans and contingency plans are in place at all administrative levels, and regular training drills and rehearsals are held to test and develop disaster response programs.
E21	Financial reserves and contingency mechanisms are in place to support effective response and recovery when required.
E22	Procedures are in place to exchange relevant information during hazard events and disasters, and to undertake post-event reviews

World Risk Report (WRR)

The World Risk Report is a work done by the United Nations University for Environment and Human Security (UNU-EHS), and published by the relief organizations in the Alliance Development Works (Mucke, 2015). The report considers different measures to come out with a set of different rankings for the countries around the world. Those rankings are based on the countries' exposure, vulnerability, and risk level.

This report plays a crucial part for the purpose of this paper. As we mentioned, one of the paper's goals is to find an index (Bounce-Back index) that is capable of listing the countries according to their recovery capacity

level. This index is a combination between the country's resilience, exposure and hazard level. While resilience is obtained from the HFA by modifying its results, as explained in the previous section, the exposure is taken from the World Risk Report. Table 2 indicates the 10 most exposed countries as reported in the WRR, where the exposure percentage represents the fraction of people who are exposed to hazards.

Table 2- The 10 most exposed countries

Country	Exposure (%)	Rank
Vanuatu	63.66	1
Tonga	55.27	2
Philippines	2.46	3
Japan	45.91	4
Costa Rica	42.61	5
Brunei Darussalam	41.1	6
Mauritius	37.35	7
Guatemala	36.3	8
El Salvador	32.6	9
Bangladesh	31.7	10

THE CONCEPT: ADAPTATION-BASED ASSESSMENT OF COMMUNITIES

Disaster Risk describes the probability of losses (human life, physical infrastructure, economic) as the result of an unfortunate event in the future (UNISDR, 2009). Risk is the combination of vulnerability, exposure and hazard. These three properties have various definitions and each of them overlap one another due to their interconnectivity. Generally, Vulnerability is the property related to how much the system is willing to suffer from a disastrous event (UNISDR, 2009), while Exposure is the amount of resources affected in a given area if a disruptive event occurs. On the other hand, Hazard describes the type and intensity of the event.

The above raises the question of what would happen once the hazard occurs. Following a disruptive event, the resilience is the factor that decides whether a community is able to cope with the disaster. When analyzing the response over time, resilience takes the place of vulnerability as it can better reflect the ability of a system to adapt after a disaster. Combining the previous properties of Exposure and Hazard with Resilience, as shown in Figure 1, leads up to the ability of a community to adapt to the new conditions. For this reason, we are introducing the bounce back index (BBI) that describes a community's ability to adapt after a disastrous event.

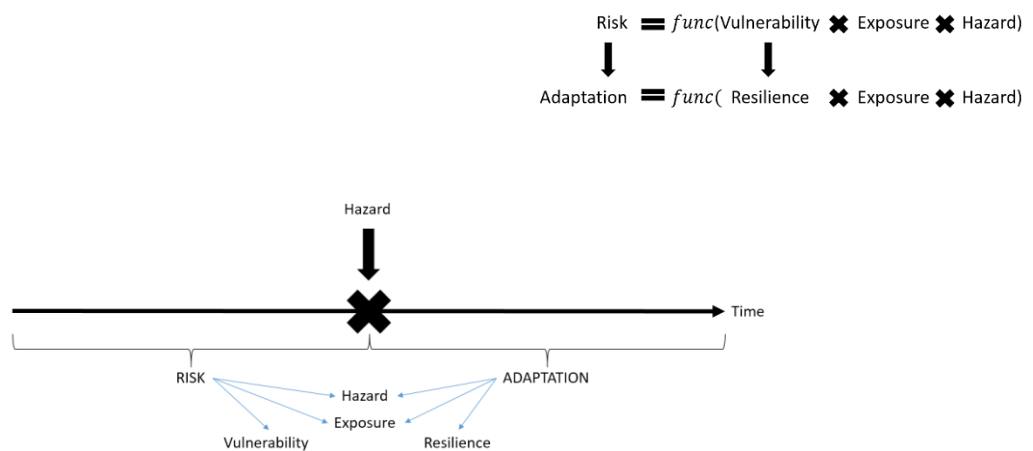

Figure 1. Difference between risk and adaptation

Countries are exposed to different hazards and have different coping experiences. The intensity at which a disaster occurs also differs. Regardless, the amount of time it takes for a system to bounce back from a disruptive event relates to its capability and effort to increase resilience. Figure 2 describes the previous

statement. A system with both high exposure and a high impacting disaster can recover faster if the system is more resilient, whereas communities with low capacity of adaptation (low resilience) would need more time to recover, and it might not return to its initial state.

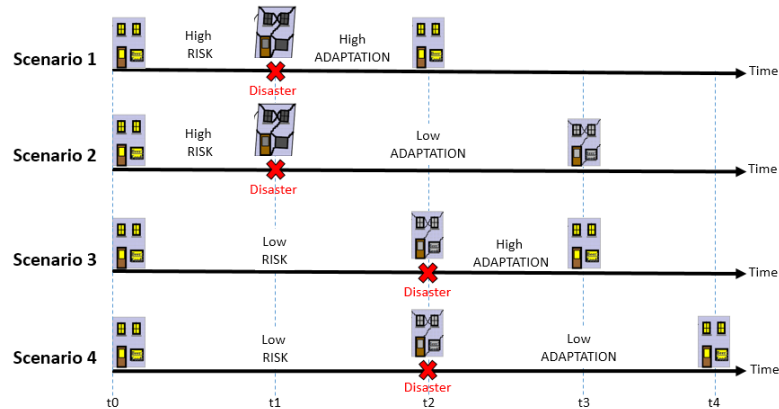

Figure 2. Multiple scenarios for different levels of risk and post-disaster adaptation of a building

The problem with resilience is that it describes the internal characteristics of a system to react to a certain type of disasters, and it is independent of any external agents. Comparing communities based on the intrinsic resilience is not meaningful because some countries have very little exposure to disasters, and being prepared to unlikely events is rather uneconomic. For instance, coastal regions are usually exposed to tsunamis and they must have a predefined plan for such an event. This is not the case for internal spots where the probability of occurrence of tsunami is almost zero. However, one cannot say that coastal areas are safer when it comes to tsunami just because they are more prepared to it. In fact, if you do not have the input (disaster) you do not need to have the system (resilience). Moreover, resilience does not give a clear indication on the adaptation, but rather on the preparedness of the community. The most adaptable spot would be the one that is highly prepared to confront disasters but at the same time is exposed to no disasters.

The main objective of this research is to come up with normalized indices that allow comparing the resilience and the adaptation level (capacity to bounce back) among different countries. Figure 3 illustrates the framework we follow in this work. Combining the resilience, exposure and hazard allows getting a new index which is hereafter referred to as ‘Bounce-Back index (BBI)’. The resilience can be obtained from different sources. In this work, we use the results Hyogo Framework for Action (HFA), as described earlier in this document. On the other hand, the exposure is obtained from the World Risk Report (WRR), while hazard can be expressed in terms of probability of occurrence, and is obtained from past data on disasters.

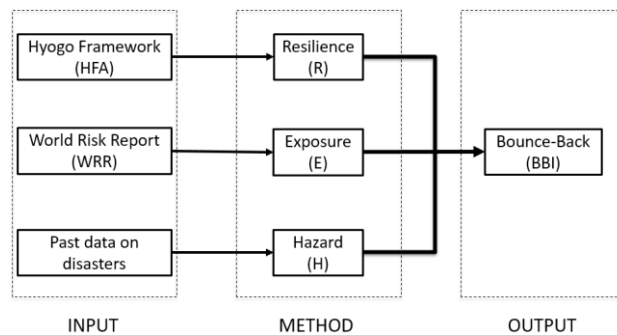

Figure 3. Scheme of the proposed framework.

Bounce-Back index (BBI)

Bounce-Back index which refers to the capacity of a community to return to a functional state can be computed using the following equation, where BBI is the Bounce-Back index, R is the resilience index, E is the exposure to natural disasters, H is the hazard information.

$$BBI = 1 - (1 - R) \times E \times H \quad (1)$$

According to Equation (1), and considering a given hazard, if a country is not exposed to disasters ($E=0$), the Bounce-Back index of this country would be 1 regardless the level of resilience. On the other hand, if the country is exposed to disasters, the Bounce-Back index would depend on the resilience state of the country. Likewise, a resilient country ($R=1$) is guaranteed to have a high Bounce-Back index ($BBI=1$) regardless the exposure level. However, if the country is characterized by a certain amount (but not maximum) resilience, BBI would depend on the exposure level.

The resilience index (R) can be secured from different sources. For the purpose of this work, the resilience is obtained by modifying the results found in the UN report (HFA), as explained in the next section. On the other hand the exposure is obtained from the World Risk Report (WRR).

Resilience index (R)

As we previously mentioned, the 22 indicators in HFA are equally-weighted, and this implies that all indicators have the same level of importance. The authors believe that in order for those indicators to be summed up to a single scalar number, they need to be modified and weighted in a certain way because they do not have the same significance level. In this section, we introduce a new method inspired by the fault tree analysis, which is here referred as the Dependence Tree Analysis (DTA). DTA can identify the strength of the relationship between an event and a subevent in a quantitative manner. In more details, the method allows computing the effect of the absence of one subevent on the underlying event. The maximum output that can be achieved by the main event is 1, this is when all subevents exist. If one of the subevents is not fulfilled, the final output would be less than 1. In the following, we will see in detail how to build the dependence tree and how to carry out the calculations.

Building the dependence tree

The first step in building the dependence tree is to identify all possible potential events that may affect the underlying output or event. This can be done by brainstorming or by relating to previously learned lessons. Three types of events can be identified here, the main or the underlying event, the intermediate event, and the primary event. A main event is a task that we need to get out of a system, and is placed on the top of the tree. Intermediate events are the necessary components that help the main event to be achieved. The primary or basic events are those who cannot be split into smaller pieces any further.

Figure 4 shows an example of a dependence tree diagram whose top event is the achievement of a resilient building. The intrinsic resilience can be split into two components, preparedness and recovery capacity. If we focus only on the preparedness, we notice that in order to have a high level of preparedness the building must have undergone a risk assessment and should be redundant and designed efficiently. All of these events can be further decomposed. For example, the design efficiency of the building can be achieved only if we have a computing machine and data on previous earthquakes (response spectrum). In addition, one can say that the computing machine and the past data cannot offer much without the presence of an engineer that is able to use these tools. This in turn necessitates the presence of an engineer as a basic event. Further decomposition of the tree depends on the level of accuracy that we seek. It is worth to note that the non-accomplishment of one of the intermediate events doesn't eliminate the accomplishment of the top event. For instance, if the two intermediate events "Preparedness, Recovery" are only partially achieved, the intrinsic resilience will be partially achieved as well.

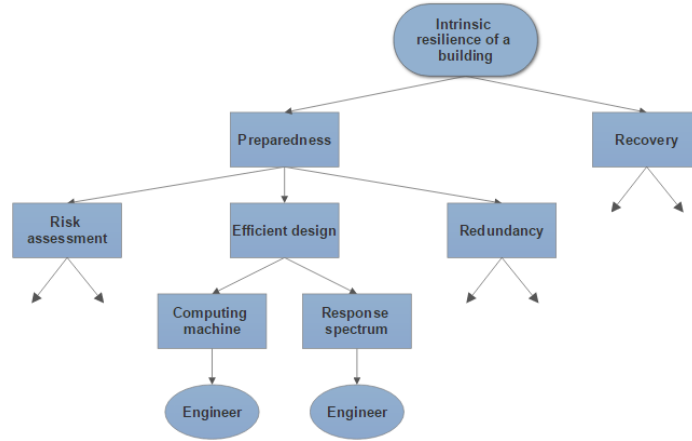

Figure 4. Example of a dependence tree diagram whose objective is to achieve a resilient building.

Quantitative analysis

Like the Fault Tree Analysis (FTA), this method is also governed by a basic mathematical foundation. Fulfilling a specific event is tied with not only to the achievement of the subsequent events but also on its intrinsic existence. This means that the achievement of all subsequent events does not guarantee the accomplishment of the underlying event. Equation (2) gives the relationship between an event and its subsequent events, where A is the accomplishment indicator of an event, E is the intrinsic existence of the underlying event, i is the event number, j is the number of subsequent events.

$$A_i = \frac{(A_{i,1} + A_{i,2} + \dots + A_{i,j})}{j} \times E_i = 0 \rightarrow 1 \quad (2)$$

Equation (2) is governed by the following assumptions:

- The intrinsic existence can be either zero or one, $E_i = 0$ or 1
- All subsequent events contribute equally to the underlying event
- Basic events are characterized only by their intrinsic existence, $A_i = E_i$

Sensitivity Analysis

Once the tree is filled out, a sensitivity analysis is performed to determine the percentile contribution of each event towards the top event. The intrinsic existence of each intermediate and basic event is set to zero ($E=0$) once at a time while keeping those of other events equal to one. For each time the intrinsic existence of an event is set to zero, the accomplishment of the top event is computed using Equation (2). The event is considered significant if the accomplishment of the top event approaches to zero.

Weighting factor

Applying a sensitivity analysis to the dependence tree allows having all events classified from the most to the least important. Equation (3) is used to compute the weighting factors for each of the HFA indicators taking into account the results of the sensitivity analysis.

$$W_i = \frac{1 - I_i}{\text{avg}(1 - I_1, 1 - I_2, \dots, 1 - I_j)} = \frac{1 - I_i}{\sum_1^j (1 - I_i)} j \quad (3)$$

where W_i is the weighting factor of event i , I_i is the impact value or the accomplishment value of the top event when the intrinsic existence of event i is set to zero, j is the number of events.

NUMERICAL EXAMPLE

In this section, the previously introduced methodology is applied to a sample of countries that participated in the Hyogo framework assessment project. The sample consists of 37 countries chosen randomly from all five continents. The applicative example is divided into two main steps: the first step is to get a resilience index, while the second step is to obtain a Bounce-Back index (BBI) for each of the countries.

Resilience index (R)

Input: Hyogo Framework for Action (HFA)

The table below lists the countries' resilience scores according to the HFA reports. Although the study sample consists of 37 countries, we present only a ten of them in such a way to give an example on how the scores are obtained. The latest reports to date were used to compile the list. The final score of each country represents the sum of all 22 indicators with a maximum achievable score of 110. The scores are also presented in a percentage (%) form, where 100 indicates a score of 5 in all indicators. The framework presented here starts from the results in Table 3.

Table 3. Scores per indicator for ten of the 37 studied countries

Country	E 1	E 2	E 3	E 4	E 5	E 6	E 7	E 8	E 9	E1 0	E1 1	E1 2	E1 3	E1 4	E1 5	E1 6	E1 7	E1 8	E1 9	E2 0	E2 1	E2 2	Total (110)	Total (%)	
Fiji	5	4	5	5	5	5	5	5	5	5	5	5	5	5	5	5	5	5	5	5	5	5	5	109	99.1
Costa Rica	5	4	4	5	3	4	5	4	4	4	5	4	4	4	3	5	5	5	5	5	5	5	5	97	88.2
Singapore	5	5	5	2	5	5	5	5	5	5	5	5	2	5	5	4	1	1	5	5	4	5	94	85.5	
Japan	5	4	4	5	4	4	4	4	5	4	3	5	4	4	4	4	4	5	5	4	4	4	93	84.5	
UAE	5	4	5	4	4	4	3	3	3	4	4	5	5	5	5	5	5	5	4	4	3	4	93	84.5	
Austria	4	5	5	3	4	4	5	5	4	4	3	4	4	4	4	4	4	5	5	4	4	4	92	83.6	
UK	4	4	5	4	4	4	5	4	4	4	4	4	4	4	4	4	4	4	4	4	4	4	5	91	82.7
Greece	4	4	4	4	4	4	5	4	4	4	4	4	4	4	4	5	4	4	4	4	4	4	90	81.8	
Australia	4	4	4	4	4	4	5	4	4	4	4	4	4	4	4	4	4	4	4	4	4	4	89	80.9	
Italy	2	4	4	4	4	4	5	4	5	4	4	4	4	3	3	3	5	4	5	5	4	4	88	80.0	

Method: the Dependence Tree Analysis (DTA)

After analyzing the results above, it was decided to find a way of weighing the importance of each indicator in the overall goal of achieving resilience. As explained in the previous chapter, the indicators (Table 1) were weighed using the Dependence Tree Analysis (DTA). The final form of the dependence tree is presented in Figure 5, where all events (indicators) are arranged based on their logical relationships with other indicators.

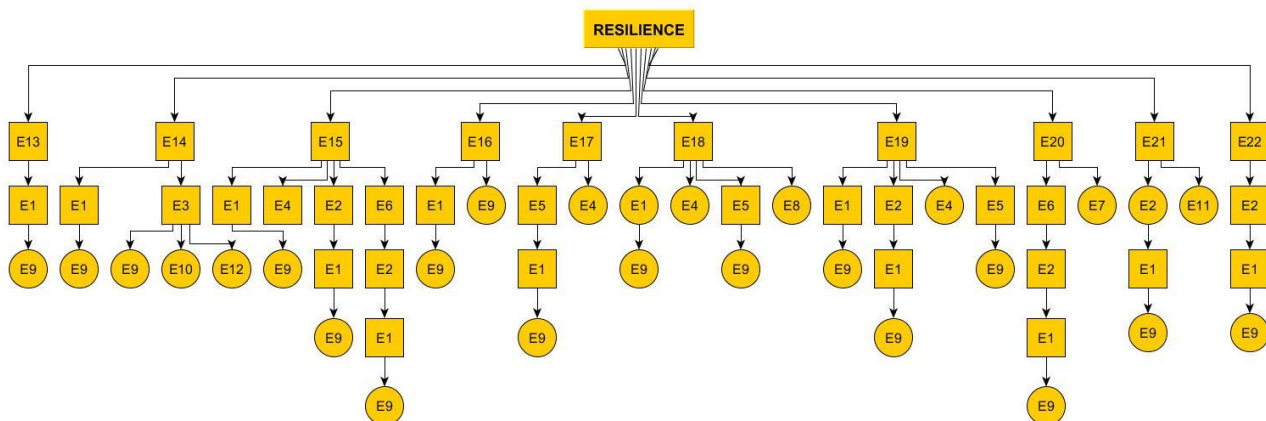

Figure 5. The dependence tree of Hyogo Framework's indicators

Output: Resilience Index (R)

Performing the quantitative analysis, followed by the sensitivity analysis (using Equations (2) and (3)) allows obtaining the new list of scores. Figure 6 compares the two set of scores: (a) The unmodified resilience, (b) The modified resilience, or the resilience index (R). We notice that rankings have changed for some countries due to the new weights assigned to the indicators. The percentage of modification for each country is presented in Figure 7. Some of the countries had an increase in their resilience after the modification, while some of them

had a decrease. Monaco was the most influenced country with more than 20% of decrease in its initial resilience score. Only a few number of countries have witnessed no change.

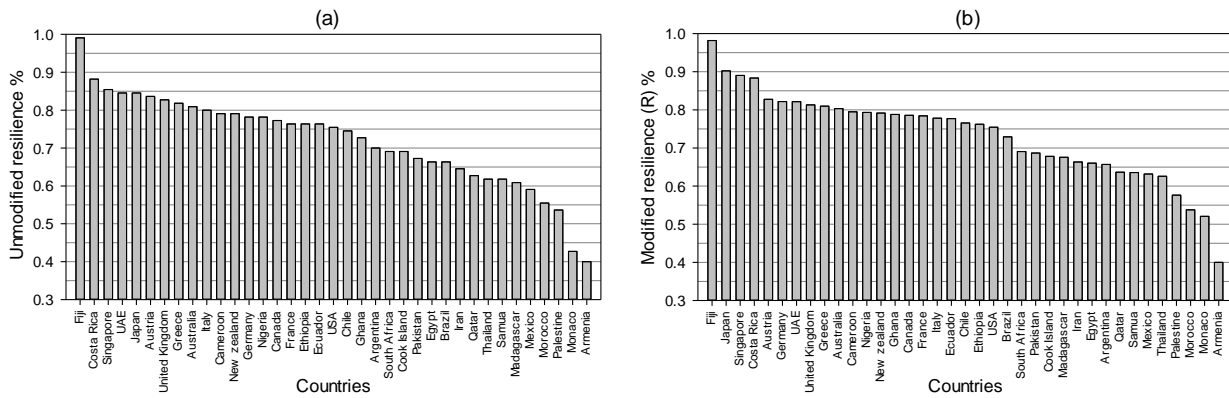

Figure 6. (a) Resilience scores of the countries as reported in Hyogo framework assessment. (b) Resilience index (R): the modified resilience scores using DTA

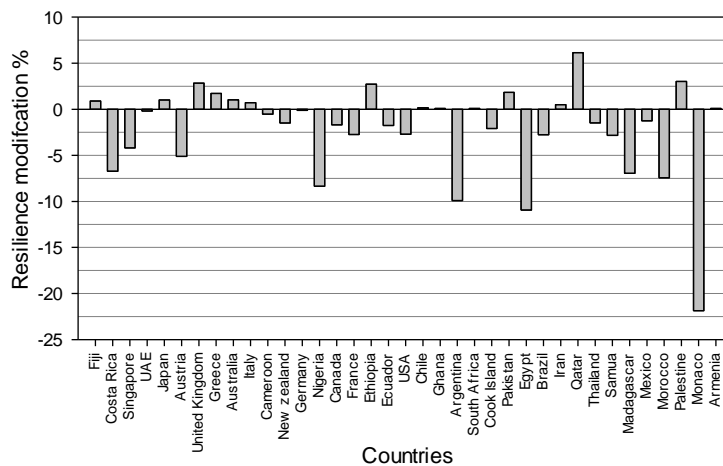

Figure 7. The difference between resilience scores before and after modification

Table 4 shows the resilience ranking of countries before and after modification. It is clear that most countries have experienced a shift in their position. It is worth noting that the new ranks are more representative to the observer. For instance, Japan is well known for its preparedness to confront natural disasters. According to HFA, Japan is ranked 5th in the resilience race, behind Fiji, Costa Rica, Singapore, and UAE. After the modification of the HFA using the Dependence Tree method, Japan has made it to the 2nd place, which makes more sense to the audience. In addition, Germany has also witnessed a significant change in the rank, going up from the 13th to the 6th place. This implies that weighting the indicators of Hyogo framework is capable of better describing the resilience of countries. On the other hand, Fiji remained in the first place even after modification. In fact, the score obtained by Fiji in the HFA was 109/110, which means that it has achieved a score of 5 in almost all of the indicators; therefore, the modification of the indicators was meaningless because changing the importance/weight of indicators that have achieved a maximum score would not change the final output. Moreover, it was surprising that Fiji was the lead country in resilience. In fact, Hyogo Framework is based on reports filled by the governments of the countries and assessed by a UN representative; therefore, the results are subjective to the person who fills the report and the one who assesses the answers.

Table 4. Ranking of countries before and after scores modification

Country	Rank before	Rank After	Country	Rank before	Rank After	Country	Rank before	Rank After	Country	Rank before	Rank After
Fiji	1	1	Cameroon	11	11	Ghana	21	14	Thailand	31	33
Costa Rica	2	4	New Zealand	12	13	Argentina	22	29	Madagascar	32	26

Singapore	3	3	Germany	13	6	South Africa	23	23	Mexico	33	32
UAE	4	7	Nigeria	14	12	Cook Island	24	25	Morocco	34	35
Japan	5	2	Canada	15	15	Pakistan	25	24	Palestine	35	34
Austria	6	5	France	16	16	Brazil	26	22	Monaco	36	36
UK	7	8	Ecuador	17	18	Egypt	27	28	Armenia	37	37
Greece	8	9	Ethiopia	18	20	Iran	28	27			
Australia	9	10	USA	19	21	Qatar	29	30			
Italy	10	17	Chile	20	19	Samoa	30	31			

Bounce-Back index (BBI)

The last step of the presented framework is to get the Bounce-Back index (BBI). As we mentioned before, (BBI) is the combination between resilience (R), exposure, and the hazard. For the sake of this example, the hazard is assumed 1 in an attempt to ignore its effect as it would be impossible to generalize between the different type of disasters each country is exposed to and the related intensity. For this particular case study, the Bounce-Back index is dependent on resilience and exposure only. The table below shows the results of the resilience index that we obtained in the previous step, the level of exposure of each of the studied countries, taken from the World Risk Report (WRR), and the Bounce-Back index (BBI) of each country, which is obtained using Equation (1). The final arrangement of the countries based on the Bounce-Back index is presented in Figure 8. We notice the new arrangement is significantly different than the resilience's arrangement in Figure 6-b, and this supports the idea that the most resilient countries are not necessary the most adapted to post-hazard circumstances. For instance, Japan is one of the most prepared countries, being 2nd in the resilience race (see Figure 6-b); nevertheless, it went back to the 26th place in the Bounce-Back ranking, and this is because Japan is one of the most exposed countries.

Table 5. Resilience index (R), exposure (E), and Bounce-Back index (BBI) of each of the studied countries

Country	Fiji	Japan	Singapore	Costa Rica	Austria	Germany	UAE	UK	Greece	Australia	Cameroon	Nigeria
Resilience index	98.20	90.23	89.03	88.35	82.78	82.18	82.15	81.31	80.98	80.33	79.51	79.35
Exposure	27.71	45.91	7.82	42.61	13.60	11.41	5.93	11.60	21.11	15.05	18.19	12.06
Bounce-Back index	0.99	0.95	0.99	0.95	0.97	0.97	0.98	0.97	0.95	0.97	0.96	0.97

Country	New Zealand	Ghana	Canada	France	Italy	Ecuador	Chile	Ethiopia	USA	Brazil	South Africa	Pakistan
Resilience index	79.18	78.80	78.58	78.45	77.82	77.71	76.56	76.23	75.45	72.93	69.09	68.68
Exposure	15.44	14.48	10.25	9.25	13.85	16.15	30.95	11.12	12.25	9.53	12.08	21.11
Bounce-Back index	0.96	0.96	0.97	0.98	0.96	0.96	0.92	0.97	0.96	0.97	0.96	0.93

Country	Madagascar	Iran	Egypt	Argentina	Qatar	Mexico	Thailand	Palestine	Morocco	Monaco	Armenia
Resilience index	67.57	66.33	66.02	65.70	63.65	63.20	62.59	57.62	53.78	52.07	40.00
Exposure	16.03	10.19	4.71	9.55	30.30	13.84	13.70	6.41	13.25	9.25	14.51
Bounce-Back index	0.94	0.96	0.98	0.96	0.89	0.95	0.95	0.97	0.94	0.95	0.91

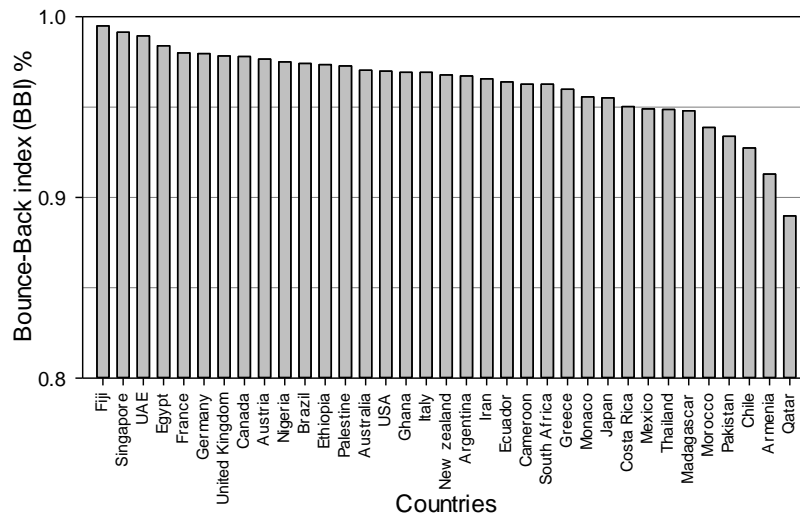

Figure 8. The Bounce-Back indices of the studied countries, using Equation (1)

CONCLUSIONS

In this paper, we propose an analytical approach for computing the post disaster-adaptation of communities. To do so, we introduced a new index, Bounce-Back index (BBI). The analytical formulation of this index is similar to the risk evaluation formulation. The only difference is that in the risk assessment, risk is a function of vulnerability, exposure, and hazard, while here we consider the resilience of the country instead of the vulnerability. This in turn leads to substantially different results. The bounce-Back index is an indication of the capacity of the community to return to the initial, functional state within a short time. Unlike risk assessment, which is involved in the pre-disaster phase. As for the resilience assessment, we introduced a new methodology based on the Hyogo Framework for Action (HFA). The problem with the HFA is that the indicators used in the resilience assessment are weighted equally; those indicators, however, do not contribute with the same weight to the resilience output. For this reason, we decided to give weights to the indicators according to their contribution in the overall goal of computing resilience. To do so, we introduced the Dependence Tree Analysis (DTA) which identifies the strength of relationships between the indicators and the resilience, giving weights to the indicators accordingly. To illustrate the proposed approach, we applied it to a case study composed of 37 countries for which we computed the resilience and the Bounce-Back indices.

The proposed approach offers a new way for understanding hazards. Recently, much attention has been given to preparation and risk assessment that is based on the vulnerability, while the concept of adaptation (Bounce-Back index), on the other hand, gives more insight into the recovery capacity of a system or a community after disasters. This can be as important as the pre-disaster risk assessment and preparation because it tells to which extend a community can cope with the post-disaster circumstances, as well as the time needed to bounce-back to the initial state.

ACKNOWLEDGMENTS

The research leading to these results has received funding from the European Research Council under the Grant Agreement n° ERC_IDEal reSCUE_637842 of the project IDEAL RESCUE— Integrated DEsign and control of Sustainable CommUnities during Emergencies.

REFERENCES

Allenby B., & Fink J. (2005). Toward Inherently Secure and Resilient Societies. *Science*, 309(5737), 1034-1036. doi:10.1126/science.1111534

- Bruneau M., Chang S. E., Eguchi R. T., Lee G. C., O'Rourke T. D., Reinhorn A. M., Winterfeldt D. v. (2003). A Framework to Quantitatively Assess and Enhance the Seismic Resilience of Communities. *Earthquake Spectra*, 19(4), 733-752. doi:doi:10.1193/1.1623497
- Cardon O.D., Maarten v. A., Joern B., Maureen F., Glenn M., & R M. (2012). *Determinants of Risk: Exposure and Vulnerability Managing the Risks of Extreme Events and Disasters to Advance Climate Change Adaptation*: Cambridge University Press.
- Gallopín G. C. (2006). Linkages between vulnerability, resilience, and adaptive capacity. *Global Environmental Change*, 16(3), 293-303. doi:<http://dx.doi.org/10.1016/j.gloenvcha.2006.02.004>
- Hosseini S., Barker K., & Ramirez-Marquez J. E. (2016). A review of definitions and measures of system resilience. *Reliability Engineering & System Safety*, 145, 47-61. doi:<http://dx.doi.org/10.1016/j.res.2015.08.006>
- Klein R. J. T., Nicholls R. J., & Thomalla F. (2003). Resilience to natural hazards: How useful is this concept? *Global Environmental Change Part B: Environmental Hazards*, 5(1-2), 35-45. doi:<http://dx.doi.org/10.1016/j.hazards.2004.02.001>
- Manyena S. B. (2006). The concept of resilience revisited. *Disasters*, 30, 434-450. doi:10.1111/j.0361-3666.2006.00331.x
- Mucke P. (2015). *WorldRiskReport*. United Nations University for Environment and Human Security (UNU-EHS). *Bündnis Entwicklung Hilft*.
- Papadopoulos G. (2016). Chapter 6 - Hazard, Vulnerability, and Risk Assessment *Tsunamis in the European-Mediterranean Region* (pp. 137-178). Boston: Elsevier.
- Richard J. T. K., Smit M. J., Goosen H., & Hulsbergen C. H. (1998). Resilience and Vulnerability: Coastal Dynamics or Dutch Dikes? *The Geographical Journal*, 164(3), 259-268. doi:10.2307/3060615
- UNISDR. (2007). Hyogo Framework for Action 2005-2015: Building the Resilience of Nations and Communities to Disasters.
- UNISDR. (2008). Indicators of progress: guidance on measuring the reduction of disaster risks and the implementation of the Hyogo Framework for Action.
- UNISDR. (2009). UNISDR Terminology on Disaster Risk Reduction.
- UNISDR. (2011). Hyogo Framework for Action 2005-2015 mid-term review.
- UNISDR. (2015a). Reading the Sendai Framework for Disaster Risk Reduction 2015 - 2030.
- UNISDR. (2015b). Sendai Framework for Disaster Risk Reduction 2015-2030.
- Wagner I., & Breil P. (2013). The role of ecohydrology in creating more resilient cities. *Ecohydrology & Hydrobiology*, 13(2), 113-134. doi:<http://dx.doi.org/10.1016/j.ecohyd.2013.06.002>