



POLITECNICO DI TORINO  
Repository ISTITUZIONALE

Real World Operation of a Complex Plug-in Hybrid Electric Vehicle: Analysis of Its CO2 Emissions and Operating Costs

*Original*

Real World Operation of a Complex Plug-in Hybrid Electric Vehicle: Analysis of Its CO2 Emissions and Operating Costs / MILLO F.; ROLANDO L.; FUSO R.. - In: ENERGIES. - ISSN 1996-1073. - ELETTRONICO. - 7:7(2014), pp. 4554-4570.

*Availability:*

This version is available at: 11583/2588162 since:

*Publisher:*

MDPI AG, POSTFACH, CH-4005 BASEL, SWITZERLAND

*Published*

DOI:10.3390/en7074554

*Terms of use:*

openAccess

This article is made available under terms and conditions as specified in the corresponding bibliographic description in the repository

*Publisher copyright*

(Article begins on next page)

Article

## Real World Operation of a Complex Plug-in Hybrid Electric Vehicle: Analysis of Its CO<sub>2</sub> Emissions and Operating Costs

Federico Millo \*, Luciano Rolando and Rocco Fuso

Politecnico di Torino, C.so Duca degli Abruzzi, Torino 24 10129, Italy;

E-Mails: luciano.rolando@polito.it (L.R.); rocco.fuso@polito.it (R.F.)

\* Author to whom correspondence should be addressed; E-Mail: federico.millo@polito.it;  
Tel.: +39-011-090-4517; Fax: +39-011-090-4599.

Received: 16 April 2014; in revised form: 7 July 2014 / Accepted: 7 July 2014 /

Published: 16 July 2014

---

**Abstract:** Plug-in hybrid electric vehicles (pHEVs) could represent the stepping stone to move towards a more sustainable mobility and combine the benefits of electric powertrains with the high range capability of conventional vehicles. Nevertheless, despite the huge potential in terms of CO<sub>2</sub> emissions reduction, the performance of such vehicles has to be deeply investigated in real world driving conditions considering also the CO<sub>2</sub> production related to battery recharge which, on the contrary, is currently only partially considered by the European regulation to foster the diffusion of pHEVs. Therefore, this paper aims to assess, through numerical simulation, the real performance of a test case pHEV, the energy management system (EMS) of which is targeted to the minimization of its overall CO<sub>2</sub> emissions. The paper highlights, at the same time, the relevance of the CO<sub>2</sub> production related to the battery recharge from the power grid. Different technologies mixes used to produce the electricity required for the battery recharge are also taken into account in order to assess the influence of this parameter on the vehicle CO<sub>2</sub> emissions. Finally, since the operating cost still represents the main driver in orienting the customer's choice, an alternative approach for the EMS, targeted to the minimization of this variable, is also analyzed.

**Keywords:** plug-in hybrid electric vehicle (pHEV); CO<sub>2</sub> emissions; energy cost; real world driving cycles

---

## 1. Introduction

In 2010, the United Nations Intergovernmental Panel on Climate Change (IPCC) concluded that a reduction of at least 50% in global CO<sub>2</sub> emissions, compared to 2000 levels, had to be achieved by 2050, in order to limit the long-term rise of the global average temperature due to the greenhouse gas effect [1]. Although this target has been set for all sources of CO<sub>2</sub> emissions, the transportation sector, which is responsible for 33% of carbon dioxide emissions [2], unlike most of the other sectors, has shown an increase in total greenhouse gas emissions, which have been predicted to grow further in the coming years [3], due to the expansion of the global vehicle fleet.

In this framework, electric vehicles (EVs) could pave the way toward a more sustainable mobility since they do not generate pollutant emissions locally and can potentially rely on energy from a selection of renewable sources.

Nevertheless, since the range capability and long recharging time still limit the market penetration of EVs [4], nowadays plug-in hybrid electric vehicles (PHEVs) seem to be the most promising solution to bridge the gap between the desirable features of an electric powertrain and the range of conventional vehicles. In a PHEV, the presence of an additional energy reservoir (*i.e.*, an electric battery) shifts a portion of the emissions burden, during the automobile travel, from on-road fossil fuel combustion to electricity generation from stationary power plants improving the efficiency of the powertrain. Although the European regulation only partially takes into account the CO<sub>2</sub> production related to battery recharge in order to foster the diffusion of such vehicles, the impact of this shift on the overall CO<sub>2</sub> emissions depends on the average efficiency of the internal combustion engine (ICE), and on the amount of the electricity required from the grid. It has been shown from different impact studies (for example, [5]) that emissions caused by electrical power generation, used for charging EV batteries, may vary significantly according to the combination of several factors, among which the period of the day used for charging and the energy demand daily profiles [6,7], the generation portfolio, and the amount of installed “green” power. Hence possible further reductions of CO<sub>2</sub> emissions related to the charging from the grid phases strongly depend on factors on which governments have no direct control in a liberalized market framework. A possible way to avoid this uncertainty could be tailor-made contracts between vehicle’s owners and energy suppliers, in order to drive the choices of the PHEVs owners towards lower CO<sub>2</sub> emissions recharging patterns.

Moreover, not only CO<sub>2</sub> emissions, but also the operating cost of the vehicle should be taken into account in the definition of the vehicle targets since it is one of the main drivers in orienting the customer’s choice and it depends to a greater extent on both fuel and electricity costs.

Although similar approaches have already been applied in literature for relatively simple hybrid architectures [8], the optimization and the full exploitation of the potentials of complex plug-in hybrids such as the one analyzed in this work still represent a quite challenging issue, which is worth to be addressed more in depth. Moreover, the assessment of the CO<sub>2</sub> emissions reduction potential of complex plug-in hybrids along driving patterns representative of real world operation, including significant altitude variations, which have been traditionally representing the Achille’s heel of energy management strategies of hybrid powertrains, is also of paramount importance.

This paper therefore aims to assess, through numerical simulation, the real performance of a test case PHEV the energy management system (EMS) of which is targeted towards the minimization of its

overall CO<sub>2</sub> emissions, and to highlight, at the same time, the main differences with respect to the regulatory European test procedure. Different technology mixes used to produce the electricity required for the battery recharge are also taken into account in order to assess the influence of this parameter on the vehicle CO<sub>2</sub> emissions. Finally, since the operating cost still represents the main driver orienting the customer's choice, an alternative approach for the EMS, targeted to the minimization of this variable, is also analyzed.

After a brief description of the methodology (Section 2), the paper presents the main features of the case study hybrid architecture (Section 3) and the reference performance achieved with a control strategy focused on the minimization of the overall CO<sub>2</sub> emissions (Section 4.1). The main findings of the sensitivity analysis, performed on the technology mixes used to produce electricity to recharge batteries are then presented (Section 4.2). Finally, the main differences between CO<sub>2</sub> minimization and cost minimization strategies are pointed out (Section 4.3).

## 2. Methodology

The most noticeable feature of using a hybrid electric vehicle (HEV) is the additional degrees of freedom that can be obtained due to the presence of an additional energy reservoir—the electric battery—besides the fuel tank [9]. Indeed at each instant of time the power requested by the driver can be provided by either one of these sources or by a combination of the two. The choice among all the available powersplit strongly depends on the objective of the specific application: in most cases, it tends to minimize the fuel consumption of the vehicle, but it could also include the minimization of pollutant emissions, the maximization of power delivery, or a compromise among all these goals [10].

In general, the design of the EMS of a hybrid vehicle is an implementation of optimal control [11] and it can usually be addressed through several methodologies which can differ in performance, computational requirements and computational efforts [12,13]. Since the main focus of this paper is not the definition of the EMS, a global optimization algorithm, the dynamic programming (DP) [14,15], has been used to set the ideal performance of the case study hybrid architecture and to highlight the effects of some parameters on vehicle performance. The DP generates a numerical solution for an optimal control problem and it gives sufficient conditions for the global optimality. It is based on Bellman's principle of optimality [11] and is able to manage dynamic models of the system; since DP is commonly used to solve time-continuous control problems, the model has to be discretized in a sequence of time steps for which DP is capable of determining the optimal control laws. Even though the need for a backward procedure means that the solution can be obtained only offline, for a driving cycle known a priori, and therefore it is not implementable on a real vehicle, the optimal control law can be used to gather information for the development of simpler and implementable strategies and to benchmark their performance [16,17].

All the analyses presented in this paper were carried out through numerical simulation performed on a vehicle model developed in Matlab environment. It relies on a kinematic approach [18], based on a backward methodology where the input variables are the speed of the vehicle and the grade angle of the road. From these variables, the powertrain output speed and the traction force that should be provided to the wheels can be easily determined [19]. Both the ICE and the electric machines are represented through performance maps that were experimentally measured under steady state

operating conditions. Despite the simple approach, other works proved good agreement [20] in the calculation of the instantaneous fuel consumption over the most common regulatory driving cycles.

The consistent number of control/state variables, coupled with long mission profiles, requires high computational power and leads to huge amount of processing data. Therefore, in order to avoid unacceptable computational time, the high performance computer (HPC) provided by the Department of Control and Computer Engineering of the Politecnico di Torino was exploited [21].

### 3. Case Study

The case study selected for this study is a pHEV featuring a complex architecture integrated in a mid-size European passenger car, the main specifications of which are represented in Table 1.

**Table 1.** Basic specifications of the plug-in hybrid electric vehicle (pHEV).  
EM: electric motor; and ICE: internal combustion engine.

<b>Complex plug-in hybrid</b>		
<b>Vehicle: mid-size European passenger car</b>	Vehicle mass (kg)	1,760
	Frontal area (m <sup>2</sup> )	2.3
	Drag coefficient (-)	0.3
	$P_{\text{dmd}}@100 \text{ km/h}$ (kW)	12.8
<b>Electric generator: permanent magnet</b>	Max power (kW)	40
	Max torque (N·m)	100
	Max speed (rpm)	14,000
	$\tau_1 = \omega_{\text{GEN}}/\omega_{\text{ICE}}$	2
<b>EM: permanent magnet</b>	Max power (kW)	60
	Max torque (N·m)	300
	Max speed (rpm)	6,000
	$\tau_1 = \omega_{\text{GEN}}/\omega_{\text{ICE}}$	1
<b>Battery data: Li-ions</b>	Energy	6 kW·h
<b>ICE: spark ignition engine</b>	Displacement (cm <sup>3</sup> )	2,000
	Max torque (N·m)	168@5,500 rpm
	Max power (kW)	104@6,500 rpm

As depicted in Figure 1, the vehicle is equipped with a 6 kW·h lithium-ion battery connected to a 60 kW electric motor (EM) which ensure an all-electric range of approximately 30 km in city driving. It also features another electric machine, which mainly works as a generator, and a 2.0-L, four-cylinder engine, paired with a six-gear manual transmission.

The two electric machines are connected to the crankshaft with a fixed gear of appropriate ratio to fully exploit their operating range. A clutch allows disconnecting the ICE and the generator from the EM and from the wheels, so that several operating modes can be selected from the EMS: series mode, parallel mode and all electric modes. Moreover, opening the clutch, the engine is not dragged during regenerative braking or all electric modes, with significant fuel savings.

Figure 1. Vehicle architecture.

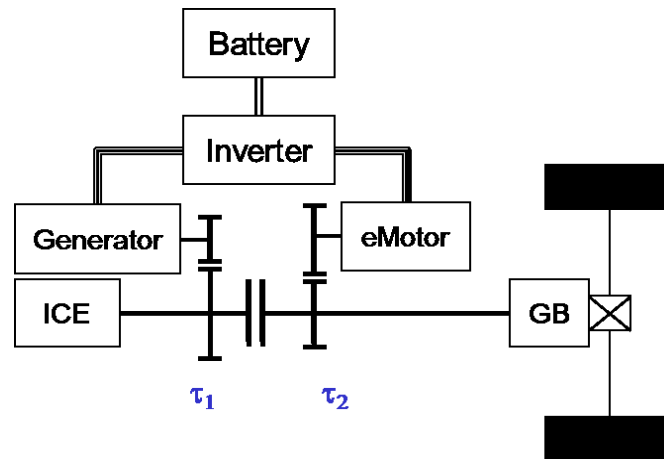

Although most of the powertrain control strategies for HEVs aims to reduce the fuel consumption, such an approach may not be suitable for plug-in architectures since it neglects the energy consumption related to the battery, which is not an energy buffer, like in a charge sustaining HEV [9], but an additional energy source that has to be recharged from the power grid.

Moreover, in order to prove the enhanced emissions performance of HEVs, complete life cycle analysis is also often considered in literatures [22,23]. However, the production process of these new vehicles cannot be easily compared with processes of conventional cars which have been optimized through several decades. Therefore, for this reason and for a fair comparison with the current legislation, in the present work equivalent “tank-to-wheel” emissions will be calculated.

A possible way of taking both the electrical and fuel contributions into account, is to minimize the overall CO<sub>2</sub> emissions of the vehicle. As shown in Equation (1), besides considering the CO<sub>2</sub> produced by the engine, a second term related to the battery discharge and to the technology mix used to produce the electricity supplied by the grid is also considered:

$$J = \frac{\mu_{\text{CO}_2}}{\mu_{\text{fuel}}} \int_0^T \dot{m}_f(t, u(t)) dt + \frac{1}{\eta_{\text{chg}} \cdot \eta_{\text{grid}}} \text{CO}_{2,\text{pr}} \cdot \Delta \text{SOC} \cdot E_{\text{batt}} \quad (1)$$

where  $J$  is the cost-to-go function;  $\mu_{\text{CO}_2}$  and  $\mu_{\text{fuel}}$  are the molar mass of CO<sub>2</sub> and fuel, respectively;  $\dot{m}_f$  is the instantaneous fuel consumption of the engine;  $u(t)$  is the vector of the control variables;  $T$  is the duration of the vehicle mission;  $\eta_{\text{chg}}$  is the average battery charging efficiency;  $\eta_{\text{grid}}$  is the transmission and distribution efficiency of a typical grid;  $\text{CO}_{2,\text{pr}}$  is the average CO<sub>2</sub> emission related to the production of the electrical energy that is supplied by the grid to recharge the battery;  $\Delta \text{SOC}$  is the variation of the state of charge (SOC) from the beginning to the end of the vehicle mission; and  $E_{\text{batt}}$  is the total electrical energy that can be stored in the battery.

As far as batteries charging and grid efficiencies were concerned, according to the data reported in literatures [24,25] grid transmission and distribution losses were estimated to be equal to 6% of the generated electrical power, while, for the lithium batteries considered in this work, a charging efficiency equal to 86% was considered [26].

Moreover, the minimization of the cost function should ideally consider the entire life cycle of the vehicle. Nevertheless, in practical cases, the optimization horizon is finite and usually coincides with a short trip: according to several studies [27], about 70% of the daily driving distances in Europe

do not exceed 50 km, and could therefore be covered by pure EVs. In this study a reference trip length of about 70 km was considered with the aim of satisfying most of the customers' requirements (about 90% in Europe).

Finally since the real performance of pHEVs could significantly differ from the one recorded through the type approval procedure, the following analysis were performed in different driving conditions considering not only typical regulatory driving cycles (such as New European Driving Cycle (NEDC), Worldwide harmonized Light vehicles Test Procedures (WLTP) [28], US06, *etc.*), but also taking into account two real world driving schedules, experimentally measured, as representative of typical urban driving conditions (Aachen cycle—Figure 2a) and of extra-urban driving conditions with significant altitude variations (Arco-Merano cycle—Figure 2b) [29,30].

**Figure 2.** Real world driving cycles considered in the analysis: (a) Aachen cycle and (b) Arco-Merano cycle.

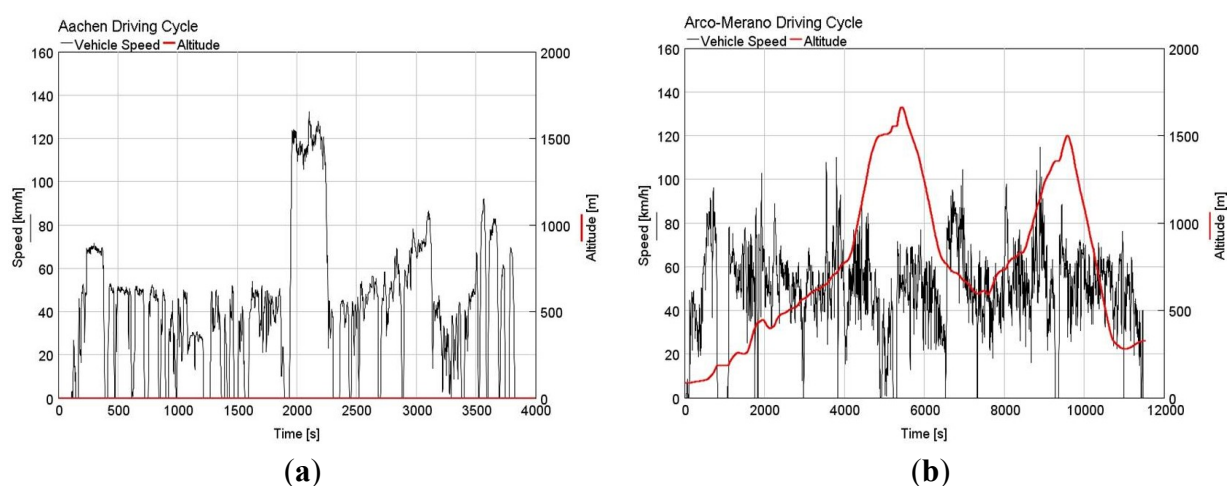

## 4. Results and Discussion

### 4.1. CO<sub>2</sub> Minimization: Reference Case

The aim of this analysis was to define the optimal control strategy which minimizes the total CO<sub>2</sub> produced by the vehicle, for several driving schedules, which were obtained through the repetition of the considered driving cycles until the target trip distance of about 70 km is reached. These tests were performed in charge depleting mode, starting from a battery *SOC* of 66%. This value was arbitrarily chosen in place of 100% only to avoid excessive simulation time to reach the minimum *SOC* of about 20%.

The simulations were performed assuming a value of 326 g/kW·h for the CO<sub>2,pr</sub> (Equation (1)) as representative of the average for the European countries belonging to the Organization for Economic Cooperation and Development (OECD) for the year of 2009 [31]. Taking into account the  $\eta_{\text{grid}}$  and  $\eta_{\text{chg}}$  values previously specified, an overall CO<sub>2</sub> production rate of about 400 g/kW·h is obtained.

Figure 3, where the operating mode selected by the DP is represented, shows that, despite of the relatively low energy capacity of the battery, the vehicle mainly operates in EV mode and the thermal engine only supports the propulsion during high demanding phases (*i.e.*, vehicle accelerations or the extra-urban drive). Furthermore the DP does not exploit the series mode because of its low efficiency,

which is the result of multiple energy conversions between the ICE and the electric machines. On the contrary the parallel mode represents the best way to transmit power to the wheels.

**Figure 3.** Mode selection—enlargement of the last Worldwide harmonized Light vehicles Test Procedures (WLTP) cycle. EV: electric vehicle.

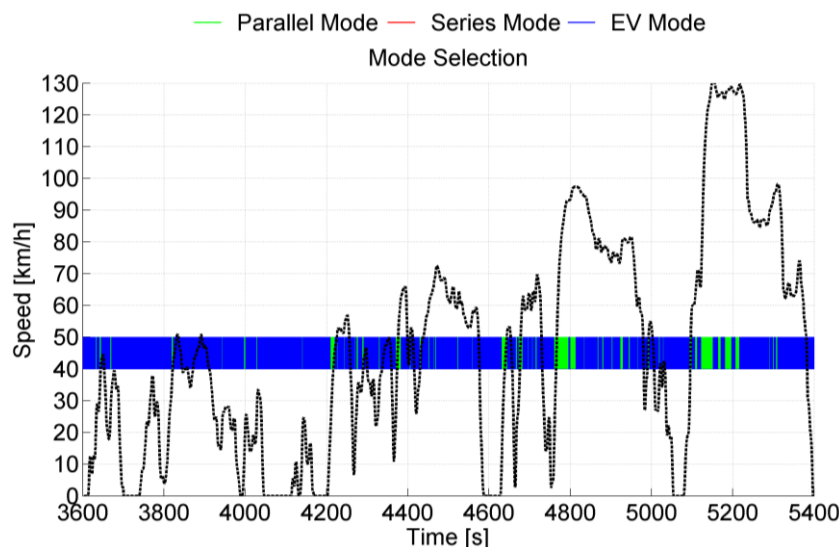

Moreover, the analysis of the powersplit represented in Figure 4 points out the limited contribution of the generator due to the efficiency maps of the electric machines and to the kinematic constraints imposed by the architecture. Indeed the DP uses the EM for regenerative braking and as an electric booster, while the generator (GEN) assists the EM for the electrical generation when the ICE is on (Figure 4).

**Figure 4.** Powersplit—enlargement of a section of the WLTP cycles. GEN: generator; and DP: dynamic programming.

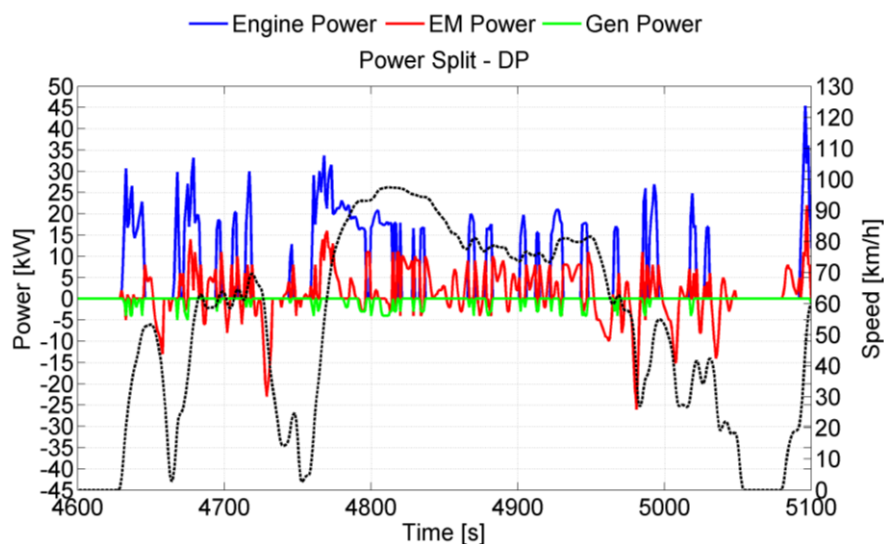

Globally such a control law mainly intends to keep the engine on its best efficiency region (Figure 5a) and to achieve a linear discharge of the battery (Figure 5b) which represents the best exploitation of the energy stored in the battery as already highlighted by scientific literature for different hybrid architectures [32,33]. As a matter of fact, the CO<sub>2</sub> specific emission of the engine



(about 650 g/kW·h on average) is significantly higher in comparison with the average CO<sub>2</sub> production rate CO<sub>2,pr</sub> of industrialized countries (Section 2); therefore the DP exploits the battery as much as possible, trying to reach the minimum SOC at the end of the trip.

**Figure 5.** Effect of the control law defined by the DP on both New European Driving Cycle (NEDC) and WLTP driving cycles: (a) engine operating points (BSFC: brake specific fuel consumption) and (b) battery state of charge (SOC).

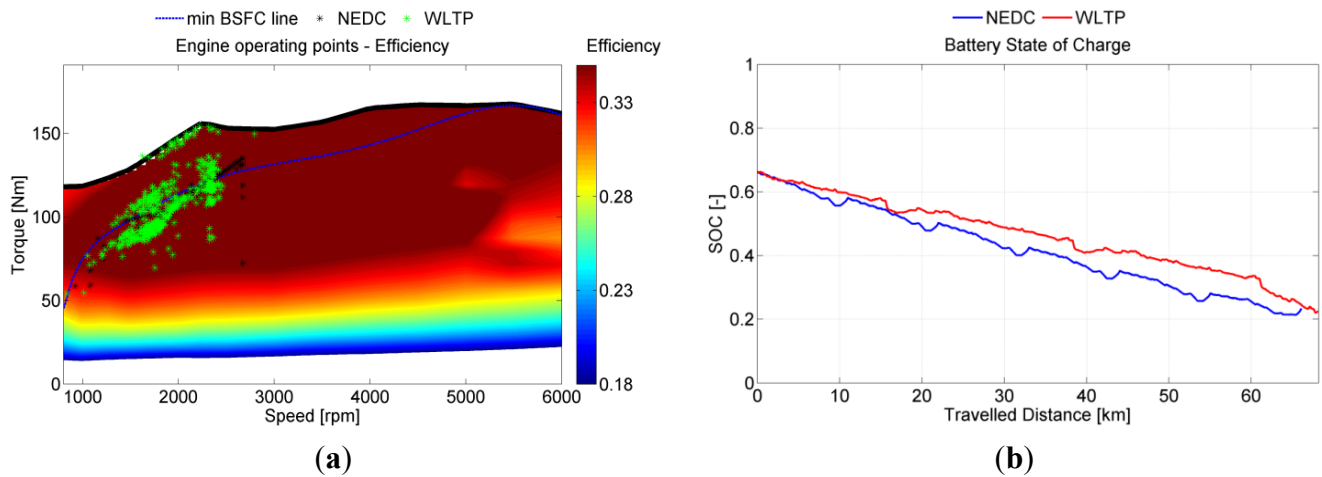

The same behavior can be observed on the Aachen cycle (Figure 6a), which represents typical real world urban driving conditions, but not on the Arco-Merano cycle (Figure 6b). Its particular altitude pattern, with two strong downhill, leads to a SOC evolution which is no more linear with the travelled distance. In this case the DP prefers to collect all the CO<sub>2</sub> saving coming from the usage of the battery during the first half of the cycle (when the powertrain provides power to the wheels) and then to recover the kinematic energy of the vehicle during the downhill.

**Figure 6.** SOC vs. distance and altitude vs. distance: (a) Aachen cycle and (b) Arco-Merano cycle.

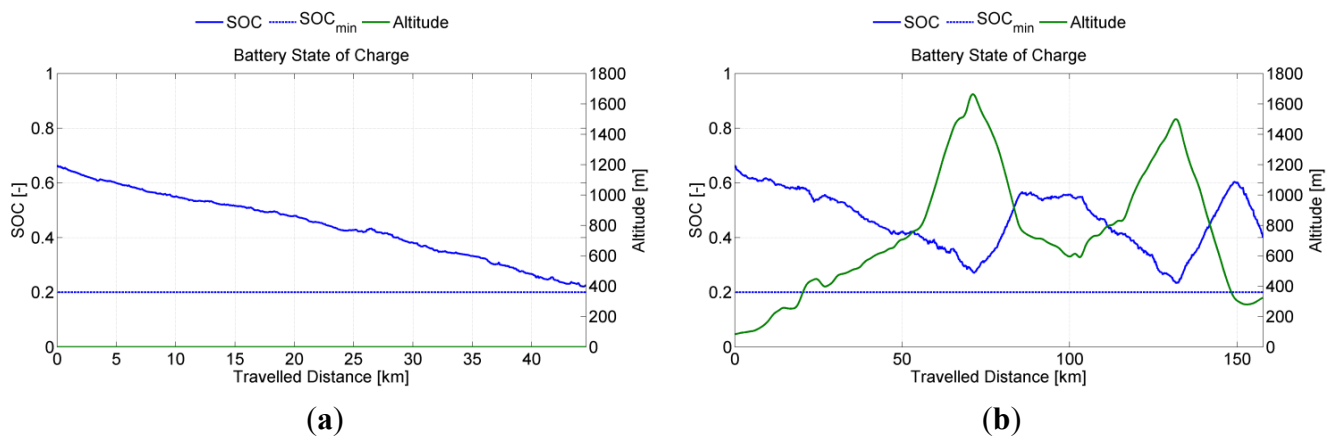

Moreover, it is eye-catching that, at the end of the driving cycle, the battery is no more fully depleted. Since a strong downhill occurs just before the end of the trip, the only chance to reach the lower limit of the SOC at the end of the mission would have been to push the discharge of the battery

below the lower *SOC* limit before the last downhill, but, since the violation of the minimum *SOC* limit is prohibited, the best the DP can do is to reach the minimum *SOC* immediately before the last downhill.

The CO<sub>2</sub> emissions results obtained over the repetition of the selected driving cycles are shown in Table 2: it can be noticed that the full exploitation of the hybrid powertrain potential in terms of CO<sub>2</sub> emissions reduction achieved by the DP is quite impressive, since, even considering real world driving cycles, and taking into account the contribution of the battery recharge, remarkably low CO<sub>2</sub> emissions are reached, all below 100 g/km.

**Table 2.** Multiple cycles emissions.

Driving cycle	Vehicle CO <sub>2</sub> emissions (g/km)		
	Engine	Battery	Total
NEDC	61	16	77
WLTP	74	16	90
Aachen	69	23	92
Arco-Merano	96	4	100

From the analysis of Table 2, it is also worth pointing out that, if the contribution of the battery recharge phases is taken into account as in the proposed methodology, the overall CO<sub>2</sub> emissions of the proposed pHEV are significantly higher than the values calculated through the European regulation for plug-in hybrid vehicles, which only partially takes into account the CO<sub>2</sub> produced by the engine. As a matter of fact the European Union (EU) procedure requires two tests [34]:

- Condition A: which is carried out with a fully charged electrical energy storage device;
- Condition B: which is carried out with an electrical energy storage device in the minimum *SOC* (maximum discharge of battery capacity).

Consequently the actual CO<sub>2</sub> emissions of the vehicle are represented by the weighted average of the data recorded in the previous tests and the weights are the vehicle electric range and the average distance between two battery recharges (Equation (2)):

$$M = \frac{D_e \cdot M_1 + D_{av} \cdot M_2}{D_e + D_{av}} \quad (2)$$

where  $M_1$  and  $M_2$  (g/km) are the CO<sub>2</sub> emissions recorded in Conditions A and B, respectively;  $D_e$  is the electric range of the vehicle (the distance covered in EV mode on the considered cycle or its multiple); and  $D_{av}$  is the average distance between two battery recharges (which is assumed to be about 25 km).

As depicted in Table 3, applying the above-mentioned procedure to the tested pHEV, the benefits of the hybridization are emphasized. As a matter of fact, during Condition A, when the battery is fully charged, there is no CO<sub>2</sub> production since the DP only exploits the EV mode (only on the WLTP cycle the capacity of the battery is not enough to perform the entire test, so a small amount of emissions is recorded). On the contrary, if the CO<sub>2</sub> emissions due to the battery recharge phases are taken into account as in the proposed methodology, the pHEV CO<sub>2</sub> emissions result to be significantly higher, although still remarkably lower than those of a conventional vehicle.

**Table 3.** Emissions according to type approval European regulation.

Driving cycle	Condition A				Condition B			
	Final SOC	$D_{\text{test1}}$ (km)	$D_e$ (km)	$M_1$ (g/km)	Final SOC	$D_{\text{test2}}$ (km)	$D_{\text{av}}$ (km)	$M_2$ (g/km)
NEDC	0.68	11	30	0	0.23	11	25	80
WLTP	0.31	23	21	4	0.22	23	25	93
Overall results								
$M = \frac{D_e \cdot M_1 + D_{\text{av}} \cdot M_2}{D_e + D_{\text{av}}}$					M (g/km)			
					NEDC			
WLTP				52				

#### 4.2. Energy Mix Influence: A Parametric Analysis of CO<sub>2</sub> Rate

As it was already pointed out in the previous sections, different technology mixes to produce the electricity required for the battery recharge may hugely affect the decisions taken by the DP since they change the *cost* of the electric energy (Equation (1)).

Statistics data collected by the International Energy Agency (IEA) revealed that the CO<sub>2</sub> specific emissions related to electricity production depend to a great extent on the considered geographical region [31]: the values can vary from 90 g/kW·h (e.g., for France, where a significant fraction of the electrical energy is produced through nuclear power plants), up to about 1000 g/kW·h in emerging countries (Table 4). Therefore in order to emphasize the effects of this parameter on the control law defined by the DP and on the vehicle performance, a sensitivity analysis was performed in the range from 75 g/kW·h to 1000 g/kW·h. Despite some works in literatures (for instance, [1]) report that using the average CO<sub>2</sub> intensity of electricity generation to estimate the emissions caused by charging EVs could lead to imprecise results, the range of emissions here analyzed is so wide to bypass this issue.

**Table 4.** CO<sub>2</sub> production rate of the main countries in recent years. US: United States; and EU: European Union.

Country	2003	2004	2005	2006	2007	2008	2009	Average of 2007–2009
World	495	500	500	503	508	504	500	504
US	571	571	570	542	549	535	508	531
Japan	444	427	429	418	452	438	415	435
France	81	79	93	87	90	87	90	89
Germany	434	436	406	404	468	441	430	447
Italy	511	459	449	468	440	421	386	416
The United Kingdom	478	486	485	507	499	490	450	480
EU 27	374	366	358	362	373	355	339	356
China	776	804	787	787	758	744	743	748
India	892	931	923	921	943	954	951	950

The simulation results showed that, as expected, the higher the CO<sub>2</sub> production rate is, the higher the energy produced by the ICE will be (Table 5). Nevertheless significant changes in the control strategy can be appreciated only if the CO<sub>2,pr</sub> is about 600 g/kW·h (the energy provided by the ICE figures in Table 5), as shown in Figure 7. Below this threshold the CO<sub>2</sub> production rate related to the battery recharge is lower than the average specific emission of the engine (about 650 g/kW·h),

so the DP exploits the energy stored in the battery, while above 600 g/kW·h the use of the engine is more convenient.

**Table 5.** Main findings of the sensitivity analysis on the CO<sub>2,pr</sub> (test performed on three repetitions of the WLTP).

Final SOC (-)	0.22	0.22	0.24	0.62	0.88	0.89	0.89
Energy provided by the ICE (kW·h)	7.2	7.2	7.3	9.2	11	11	11
Total CO <sub>2</sub> Emission (battery + engine) (g/km)	76	90	93	96	108	108	108

**Figure 7.** SOC trends obtained by changing the CO<sub>2</sub> production rate.

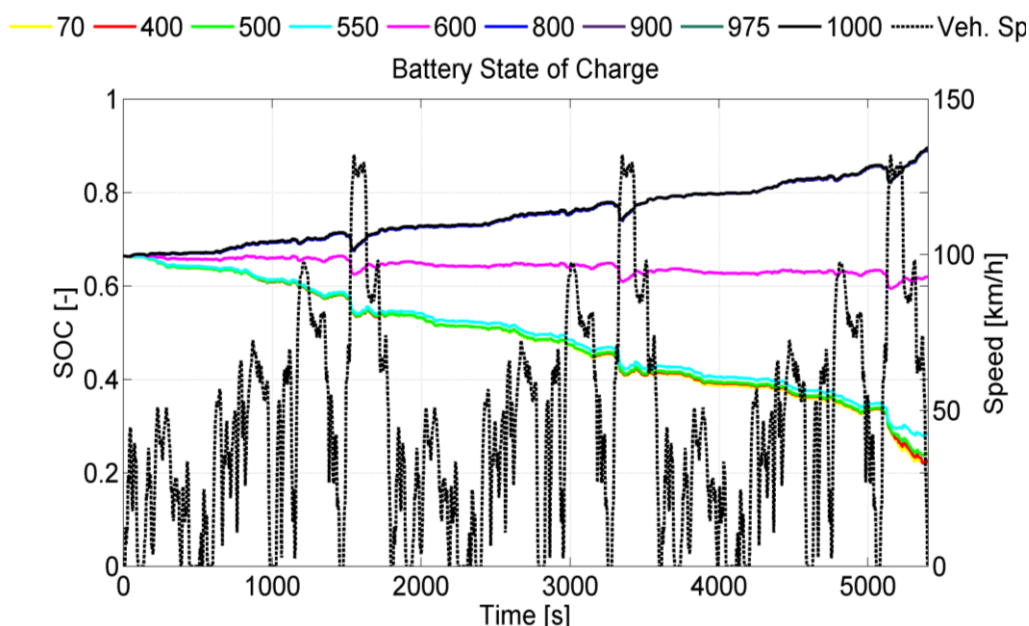

Globally if the CO<sub>2</sub> production rate is higher, also the overall CO<sub>2</sub> emissions increase since the reduction of the battery contribution is not able to balance the increase of the engine usage.

#### 4.3. Customer Perspective: The Operating Cost Approach

Although nowadays customers are more and more aware of environmental issues, from their perspective HEVs primarily represent a way to reduce fuel expenditure. Therefore, the performance of the EMS, described in the previous sections, will be compared with an alternative methodology aiming to minimize the energy cost (Equation (3)):

$$J = \frac{C_{\text{fuel}}}{\rho_{\text{fuel}}} \int_0^T \dot{m}_f(t, u(t)) dt + C_{\text{elec}} \cdot \Delta SOC \cdot E_{\text{batt}} \quad (3)$$

As for the CO<sub>2</sub> emissions, the cost function is composed of two parts: the first is related to the fuel cost, while the second is related to the electrical energy cost.  $C_{\text{fuel}}$  and  $C_{\text{elec}}$  represent fuel and electricity costs, respectively, and they were assumed to be equal to the 2011 European average [35,36].

In order to highlight possible differences in the effects of this new EMS, a comparison between the operating modes chosen in this case with the operating modes of the reference case (targeted to the CO<sub>2</sub> minimization) can be analyzed as shown for instance in Figure 8.

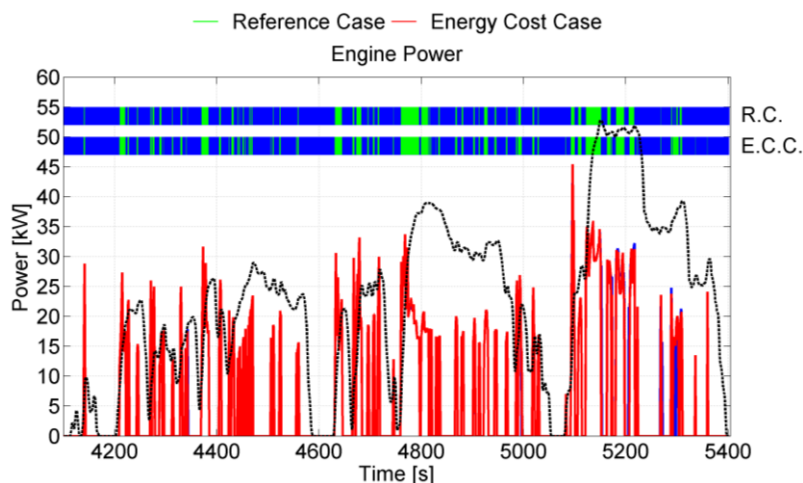
**Figure 8.** Enlargement of the last WLTP repetition.

The analysis of Figure 8 does not reveal any significant differences in the control law defined by the DP if the optimization is targeted to the minimization of the energy cost instead of the CO<sub>2</sub> emissions. As a result, these approaches almost attain the same performance, as depicted in Table 6.

**Table 6.** Comparison of CO<sub>2</sub> emissions and energy costs for different driving cycles for two different optimization strategies.

Driving cycle	End user cost (€)			CO <sub>2</sub> emission (g/km)			End user cost (€)			CO <sub>2</sub> emission (g/km)		
	Fuel cost	Electricity cost	Total cost	CO <sub>2</sub> engine	CO <sub>2</sub> grid	Total CO <sub>2</sub>	Fuel cost	Electricity cost	Total cost	CO <sub>2</sub> engine	CO <sub>2</sub> grid	Total CO <sub>2</sub>
NEDC	2.48	0.48	2.96	61	15	76	2.48	0.48	2.96	61	16	77
WLTP	3.07	0.49	3.56	74	16	90	3.07	0.49	3.56	74	16	90
Aachen	2.31	0.49	2.8	69	23	92	2.31	0.49	2.8	69	23	92
Arco-Merano	11.4	0.29	11.71	96	4	100	11.4	0.29	11.71	96	4	100

This lack of difference is a consequence of the huge difference between the specific cost of the fuel (0.42 €/kW·h) and the specific cost of the electricity (0.184 €/kW·h), as in the CO<sub>2</sub> optimization. Hence, since the ratio between these costs (2.27) is quite close to the ratio between the specific CO<sub>2</sub> emissions of the engine and the CO<sub>2</sub> production rate (1.6), also the path defined by the DP to minimize the cost function is almost the same.

Therefore, it can be stated that an EMS aiming to minimize the CO<sub>2</sub> emissions of the vehicle will also achieve the minimum of the energy expenditure. Nevertheless, since these results could significantly change depending on the future trends of fuel and electricity costs, additional scenarios for these parameters were analyzed in order to point out their effects on the powertrain control strategy. Two parameter sweeps, for electricity and fuel costs respectively, were performed keeping fixed all the other parameter values. The fuel cost was varied in the range 1.25–2 €/L while the electricity cost in the range 0.1–0.25 €/kW·h.

The comparison of the *SOC* profiles, represented in Figure 9, points out that the control law defined by the DP is not affected by these sensitivity sweeps since, in each scenario, the cost of the fuel is significantly higher than the electricity cost in each considered case. The battery discharge is always the preferred option of the EMS, even if the total cost of the trip will increase.

**Figure 9.** Variation of the SOC profile obtained through a sensitivity analysis: (a) on the fuel cost and (b) on the electricity cost.

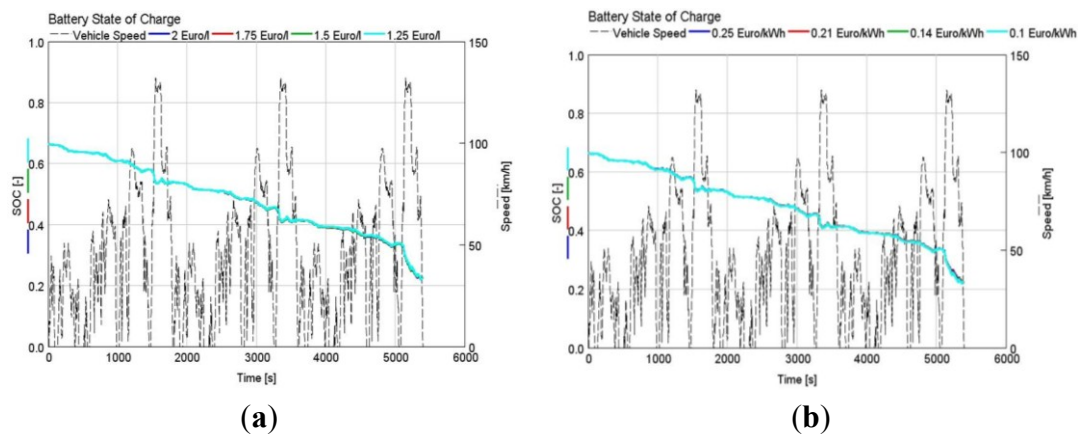

## 5. Conclusions

This work analyzed, through a global optimization algorithm, the real benefit of a plug-in hybrid architecture integrated into a mid-size European passenger car. The optimal powertrain control strategy was primarily obtained in different driving conditions with the goal of minimizing the overall CO<sub>2</sub> emissions of the vehicle. The analysis of the DP results showed that a linear discharge of the battery over the travelled distance represents the optimal strategy only for vehicle missions without altitude variations. The relevance of the CO<sub>2</sub> related to battery recharge from the grid was also highlighted comparing the real emission of the vehicle with the values attained through the European regulation which neglects the contribution of the battery recharge.

Furthermore, the proposed methodology based on the minimization of the CO<sub>2</sub> emissions was also proved to be able to minimize the energy cost which is the most important parameter from the customer perspective. In both cases, the use of the engine was in fact shown to be significantly more expensive than the battery discharge. This finding was also strengthened by the sensitivity analysis on the CO<sub>2</sub> production rate, which showed negligible effects on the control law defined by DP when typical data from industrialized countries such as the US, EU and Japan, were used (appreciable effects could only be observed for very high CO<sub>2</sub> production rates, which are typical of China and India).

## Acknowledgments

The authors would like to gratefully acknowledge the valuable support provided by Michael Fischer (Honda R&D Europe) and Tobias Rodemann (Honda Research Institute Europe) for the definition of the test case analyzed in the paper and for their helpful and valuable suggestions during the analysis.

## Author Contributions

All the authors provided their valuable contribution to the development of this work. Federico Millo and Luciano Rolando proposed the topic of this research activity in the framework of the 2011 Honda Initiation Grant Europe. Luciano Rolando developed the approach used for the evaluation of the global CO<sub>2</sub> produced by a plug-in HEV. Rocco Fuso developed the model of the considered hybrid

architecture and performed all the simulations. Federico Millo was the project supervisor and played a key role in the analysis of the simulation results.

### Definitions/Abbreviations

BSFC	Brake Specific Fuel Consumption
DP	Dynamic Programming
EMS	Energy Management System
EU	European Union
EV	Electric Vehicle
HEV	Hybrid Electric Vehicle
HPC	High Performance Computer
ICE	Internal Combustion Engine
IEA	International Energy Agency
IPCC	Intergovernmental Panel on Climate Change
NEDC	New European Driving Cycle
OECD	Organization for Economic Cooperation and Development
pHEV	Plug-in Hybrid Electric Vehicle
<i>SOC</i>	State of Charge
US	United States
WLTP	Worldwide Harmonized Light vehicles Test Procedure

### Symbols

$C_{elec}$	Electricity cost
$C_{fuel}$	Fuel cost
$CO_2$	Carbon dioxide
$CO_{2,pr}$	$CO_2$ production rate
$D_{av}$	Average distance between two battery recharges
$D_e$	Electric range
$E_{batt}$	Energy of the battery
$J$	Cost Function
$\dot{m}_f$	Fuel mass flow rate
$M_1$	$CO_2$ emissions calculated through the Condition A of the European regulation
$M_2$	$CO_2$ emissions calculated through the Condition B of the European regulation
$T$	Trip duration
$t$	Time
$u(t)$	Control vector
$\Delta SOC$	State of charge variation
$\eta_{chg}$	Average battery charging efficiency
$\eta_{grid}$	Transmission and distribution efficiency
$\mu_{CO_2}$	$CO_2$ molar mass
$\mu_{fuel}$	Fuel molar mass

## Conflicts of Interest

The authors declare no conflict of interest.

## References

1. *Energy Technology Perspectives 2010—Scenarios & Strategies to 2050*; International Energy Agency (IEA): Paris, France, 2010.
2. U.S. Energy Information Administration. Annual Energy Outlook. Available online: <http://www.eia.doe.gov/oiaf/aeo/index.html> (accessed on 20 October 2010).
3. Kampman, B.; Leguijt, C.; Bennink, D.; Wienders, L.; Rijkee, X.; de Buck, A.; Braat, W. *Green Power for Electric Cars—Development of Policy Recommendations to Harvest the Potential of Electric Vehicle*; Committed to the Environment (CE) Delft: Delft, The Netherlands, 2010.
4. Warth, M.; Bassett, M.; Hall, J.; Korte, V.; Mahr, B. Design and Development of the MAHLE Range Extender Engine. In Proceedings of the 20th Aachen Colloquium Automobile and Engine Technology, Aachen, Germany, 10–12 October 2011.
5. Verzijlbergh, R.A.; Lukszo, Z. System impacts of electric vehicle charging in an evolving market environment. In Proceedings of the 2011 IEEE International Conference on Networking, Sensing and Control (ICNSC), Delft, The Netherlands, 11–13 April 2011; pp. 20–25.
6. Verzijlbergh, R.A.; Lukszo, Z.; Ilic, M.D. Comparing different EV charging strategies in liberalized power systems. In Proceedings of the 2012 9th International Conference on the European Energy Market (EEM), Florence, Italy, 10–12 May 2012; pp. 1–8.
7. Verzijlbergh, R.A.; Lukszo, Z.; Veldman, E.; Slootweg, J.G. Deriving electric vehicle charge profiles from driving statistics. In Proceedings of the 2011 IEEE Power and Energy Society General Meeting, San Diego, CA, USA, 24–29 July 2011; pp. 1–6.
8. Millo, F.; Rolando, L.; Fusco, R.; Mallamo, F. Real CO<sub>2</sub> emissions benefits and end user's operating costs of a plug-in hybrid electric vehicle. *Appl. Energy* **2014**, *114*, 563–571.
9. Paganelli, G.; Ercole, G.; Brahma, A.; Guezennec, Y.; Rizzoni, G. General supervisory control policy for the energy optimization of charge-sustaining hybrid electric vehicle. *JSAE Rev.* **2001**, *22*, 511–518.
10. Sciarretta, A.; Back, M.; Guzzella, L. Optimal control of parallel hybrid electric vehicle. *IEEE Trans. Control Syst. Technol.* **2004**, *12*, 352–363.
11. Lewis, F.L.; Syrmos, V.L. *Optimal Control*; John Wiley & Sons, Inc.: New York, NY, USA, 1995.
12. Lin, C.C.; Peng, H.; Grizzle, J.W.; Kang, J. Power management strategy for a parallel hybrid electric truck. *IEEE Trans. Control Syst. Technol.* **2003**, *11*, 839–849.
13. Serrao, L. A Comparative Analysis of Energy Management Strategies for Hybrid Electric Vehicle. Ph.D. Thesis, The Ohio State University, Columbus, OH, USA, October 2009.
14. Sundstrom, O.; Guzzella, L. A generic dynamic programming Matlab function. In Proceedings of the 2009 IEEE Control Applications, (CCA) & Intelligent Control, (ISIC), St. Petersburg, Russia, 8–10 July 2009; pp. 1625–1630.
15. Sundstrom, O.; Ambuhl, D.; Guzzella, L. On implementation of dynamic programming for optimal control problems with final state constraints. *Oil Gas Sci. Technol. Rev. IFP* **2009**, *65*, 91–102.



16. Bianchi, D.; Rolando, L.; Serrao, L.; Onori, S.; Rizzoni, G.; Al-Khayat, N.; Hsieh, T.; Kang, P. Layered control strategies for hybrid electric vehicles based on optimal control. *Int. J. Electr. Hybrid Veh.* **2011**, *3*, 191–217.
17. Bianchi, D.; Rolando, L.; Serrao, L.; Onori, L.; Rizzoni, G.; Al-Khayat, N.; Hsieh, T.M.; Kang, P. A Rule-based strategy for a series/parallel hybrid electric vehicle: An approach based on dynamic programming. In Proceedings of the ASME 2010 Dynamic Systems and Control Conference (DSCC), Cambridge, MA, USA, 12–15 September 2010.
18. Millo, F.; Rolando, L.; Andreato, M. Numerical simulation for vehicle powertrain development. In *Numerical Analysis—Theory and Application*; Awrejcewicz, J., Ed.; InTech: Rijeka, Croatia, 2011; Volume 24, pp. 519–540.
19. Genta, G. *Motor Vehicle Dynamics: Modeling and Simulation*; World Scientific Publishing Co. Inc.: Singapore, 1997.
20. Cipolla, G.; Mallamo, F.; Paladini, V.; Vassallo, A.; Millo, F.; Mafrici, G. Transient correction of diesel engine steady-state emissions and fuel consumption maps for vehicle performance simulation. In Proceedings of the 16th Aachener Kolloquium Fahrzeug und Motorentechnik, Aachen, Germany, 8–10 October 2007.
21. Dipartimento di Automatica e Informatica (DAUIN)—Politecnico di Torino—HPC Project. Available online: <http://www.dauin-hpc.polito.it> (accessed on 19 November 2011).
22. Baptista, P.; Ribau, J.; Bravo, J.; Silva, C.; Adcock, P.; Kells, A. Fuel cell hybrid taxi life cycle analysis. *Energy Policy* **2011**, *39*, 4683–4691.
23. Ribau, J.; Viegas, R.; Angelino, A.; Moutinho, A.; Silva, C. A new offline optimization approach for designing a fuel cell hybrid bus. *Transp. Res. Part C* **2014**, *42*, 14–27.
24. ABB Inc. Energy Efficiency in the U.S. Power Grid. Available online: <http://www.abb.com/cawp/seitp202/64cee3203250d1b7c12572c8003b2b48.aspx> (accessed on 3 March 2013).
25. *Quaderno: L'efficienza nel Settore delle reti Energetiche*; Italian National Agency for New Technologies, Energy and Sustainable Economic Development (ENEA): Rome, Italy, 2011. (In Italian).
26. Bossel, U. Driving Sustainability. In Proceedings of the SIAM Conference on Applications of Dynamical Systems (DS07), Reykjavik, Iceland, 28 May–1 June 2007.
27. Rust, A.; Graf, B. NVH of electric vehicles with range extender. *SAE Int. J. Passeng. Cars Mech. Syst.* **2010**, *3*, 860–867.
28. Experts from the European Commission and Japan. Proposal for a new UN global technical regulation on Worldwide Harmonized Light Vehicles Test Procedures (WLTP). In Proceedings of the World Forum for Harmonization of Vehicle Regulations, Geneva, Switzerland, 14 November 2013.
29. Millo, F.; Rolando, L.; Fuso, R.; Shafiabady, F.; Bergshoeff, E. Analysis of different energy management strategies for complex hybrid electric vehicles. *Comput. Aided Des. Appl.* **2014**, *11*, 1–10.
30. Marcos, D.; Bordons, C. Power management of a plug-in hybrid electric vehicle based on cycle energy estimation. *Engine Powertrain Control Simul. Model.* **2012**, *3*, 363–370.
31. *CO<sub>2</sub> Emissions from Fuel Combustion—2011 Highlights*; International Energy Agency (IEA): Paris, France, 2011.

32. Larsson, V.; Johannesson, L.; Egardt, B.; Larsson, A. Benefit of route recognition in energy management of plug-in hybrid electric vehicles. In Proceedings of the 2012 American Control Conference (ACC), Montreal, QC, Canada, 27–29 June 2012; pp. 1314–1320.
33. Larsson, V.; Johannesson, L.; Egardt, B. Impact of trip length uncertainty on optimal discharging strategies for pHEVs. In Proceedings of the 6th IFAC Symposium Advances in Automotive Control, Munich, Germany, 12–14 July 2010; pp. 55–60.
34. *CO<sub>2</sub> Emission/Fuel Consumption*; Regulation No. 101-Rev.2; United Nations Economic Commission for Europe (UNECE): Geneva, Switzerland, 2005.
35. EUROSTAT Energy Statistics. Available online: <http://epp.eurostat.ec.europa.eu/portal/page/portal/eurostat/home> (accessed on 10 March 2013).
36. Europe's Energy Portal. Historical Fuel Price Data. Available online: <http://www.energy.eu/> (accessed on 10 March 2013).

© 2014 by the authors; licensee MDPI, Basel, Switzerland. This article is an open access article distributed under the terms and conditions of the Creative Commons Attribution license (<http://creativecommons.org/licenses/by/3.0/>).