



POLITECNICO DI TORINO
Repository ISTITUZIONALE

Direct measurement of ultrasonic activity on microbial metabolism and analysis of related uncertainty

Original

Direct measurement of ultrasonic activity on microbial metabolism and analysis of related uncertainty / Erriu, Matteo. - STAMPA. - (2013).

Availability:

This version is available at: 11583/2507350 since:

Publisher:

Politecnico di Torino

Published

DOI:10.6092/polito/porto/2507350

Terms of use:

openAccess

This article is made available under terms and conditions as specified in the corresponding bibliographic description in the repository

Publisher copyright

(Article begins on next page)

POLITECNICO DI TORINO
Graduate School

*Ph.D. Course in Metrology: Measuring Science and
Technique*

Ph.D. Thesis

**Direct measurement of ultrasonic
activity on microbial metabolism and
analysis of related uncertainty**



Supervisor:
Prof. Raffaello Levi
Co-examiner
Dr. Germano Orrù

Candidate:
Matteo Erriu

Student number:
169872

Academic year 2011/12

To my father.

Table of contents

1.	Aims and scope	p. 1
2.	Introduction	p. 2
2.1.	Metrology in medicine and biology	p. 2
2.1.1.	History	p. 2
2.1.2.	The International System of Units (SI) and the dimensionless quantities	p. 3
2.1.3.	The Uncertainty in measurement and metrological concepts	p. 5
2.1.4.	Metrology of biosciences	p. 7
2.2.	Ultrasounds	p. 8
2.3.	Microbial biofilm modulation by ultrasounds, current concepts and controversies	p. 10
2.3.1.	Introduction	p. 10
2.3.1.1.	Bacterial biofilm	p. 10
2.3.1.2.	Therapeutic ultrasound	p. 11
2.3.1.3.	Current concepts about ultrasound effects on bacteria population	p. 14
2.3.1.4.	Bacteria response to US activity	p. 16
2.3.1.5.	Therapeutic US in medical field	p. 17
2.3.2.	Experimental approaches on bacteria biofilm	p. 18
2.3.2.1.	Literature's analysis	p. 18
2.3.2.2.	Evaluation of US effect on biofilm	p. 20

2.3.3.	Discussion and conclusions	p. 24
2.4.	Conclusions	p. 25
3.	Material and Methods	p. 27
3.1.	Choice of methods and experimental plan	p. 27
3.2.	Step 1	p. 28
3.2.1.	Description	p. 28
3.2.2.	Ultrasonic bath and tripod-grid creation	p. 29
3.2.3.	Hydrophone calibration	p. 32
3.2.4.	Ultrasonic transparency of sonication tubes exposed to various frequencies: a metrological evaluation of modifications and uncertainty of acoustic pressures.	p. 34
3.2.4.1.	Principle	p. 34
3.2.4.2.	Discussion and conclusions	p. 43
3.2.5.	Conclusions (From step 1 to step 3)	p. 43
3.3.	Step 2	p. 44
3.3.1.	Description of the method	p. 44
3.3.2.	Microtiter spectrophotometric biofilm production assay analyzed with metrological methods and uncertainty evaluation	p. 45
3.3.2.1.	Introduction	p. 45
3.3.2.2.	Materials and methods	p. 47
3.3.2.3.	Results	p. 51
3.3.2.4.	Discussion	p. 53

3.3.3.	Metrological analysis of base values for planktonic growth and biofilm development of various microorganisms using the improved method	p. 55
3.3.3.1.	Statistical analysis	p. 55
3.3.3.2.	Results	p. 56
3.3.3.3.	Discussion	p. 58
3.3.4.	Conclusions (From step 2 to step 3)	p. 60
3.4.	Step 3	p. 61
3.4.1.	Description	p. 61
3.4.2.	Analysis of planktonic growth and biofilm development after ultrasonic exposure	p. 63
3.4.3.	Metrological evaluation of step 3	p. 71
4.	Results	p. 72
4.1.	Statistical analysis	p. 72
4.1.1.	Biofilm development	p. 87
4.1.1.1.	Analysis of the acoustic pressure effect	p. 87
4.1.1.2.	Analysis frequency by frequency	p. 97
4.1.2.	Planktonic growth	p. 105
4.1.2.1.	Analysis of the acoustic pressure effect	p. 105
5.	Discussion	p. 113
5.1.	Acoustics	p. 113
5.2.	Biology	p. 114

5.3.	Metrology	p. 119
6.	Conclusions	p. 123
7.	References	p. 125
8.	Acknowledgements	p. 134



1. AIMS AND SCOPE

The scope of this work is to identify the relation that exists between the alterations of the bacterial metabolism and the exposition to an ultrasonic field. To made this relation quantifiable they will be used repeatable and reproducible metrological methods.

To obtain this result the research will be focused on 3 specific goal:

1. To realise a measurement of the ultrasonic field, generated by an ultrasonic bath, using an hydrophone calibrated specifically with the wavelengths applied.
2. To choose a method, through uncertainty evaluation, to expose microbes to the ultrasonic field without an excessive alteration of the generated acoustic pressure.
3. To find a method to measure bacterial viability, represented by the planktonic growth and the biofilm development, after exposure to the ultrasounds.

Studying the relationship between the bacteria metabolism and ultrasonic exposure it will be possible to identify novels and more precise methods to treat bacterial colonisations. This result will be in fact useful in various fields where the bacterial presence, and in particular biofilm development, is today an unresolved problem.

At the same time this research will put the basis for many further studies that will be realized applying the same method with different bacterial species, ultrasounds exposition conditions or ultrasonic devices.



2. INTRODUCTION

2.1. Metrology in medicine and biology

2.1.1 History

Metrological sciences saw their birth between the eighteenth and nineteenth century with the creation and implementation in France of the decimal metric system. That moment signed the first step to achieve a world unification of measurement unit and methods, today still uncompleted. After the first phase of development and divulgation the most important moment for metrological evolution is related to the year 1875 with the “Metre Convention” and the creation of the “International Bureau of Weights and Measures” or “Bureau International des Poids et Mesures” (BIPM) in Paris [1]. The first prototypes deposited in the bureau were meter and kilogram for the use of all member governments of the convention. Other than the bureau, from the conference born an organizational structure having at its base the “General Conference on Weight and Measures” (CGPM), that meets in Paris every four years, and the “International Committee for Weight and Measures” (CIPM) [1, 2].

In 1881 after meter, weight and temperature, during the “First International Congress of Electrician” in Paris, it was proposed to include electrical standard into the Metre Convention but this was not accepted. In 1889 the 1st CGPM sanctioned the international prototypes for the metre and the kilogram, together with the adoption of the astronomical second as the unit of time. In 1901 Giorgi showed that it is possible to combine the mechanical units of this metre–kilogram–second system with the practical electric units to form a single coherent four-dimensional system by adding to the three base units a fourth unit, of an electrical nature such as the ampere or the ohm. After the revision of the Metre Convention by the 6th CGPM in 1921, which extended the scope and responsibilities of the BIPM to other fields in physics, the Consultative Committee for Electricity (CCE, now CCEM) was created. The 10th CGPM, in 1954, approved the introduction of the ampere, the kelvin and the candela as base units, respectively, for electric current, thermodynamic temperature and luminous intensity.

In 1960 the International System of Units (SI) was established at the 11th CGPM, and BIPM was authorized to maintain radium standard No. 5430 as standard for ionizing radiations. In 1971 the unit of amount of substance, the mole, was defined, and in 1993 the responsibility for the metrology in chemistry [2] added to BIPM.

Finally, in 1999, members of the CGPM accepted that the BIPM should have authority to take action in any field of science for which there was a need for international work in metrology [2].

Today the metrology has a fundamental role in all aspects of life, all fields, from engineering to economic, from telecommunication to transport, from agriculture to climatic changes, are strictly dependent on Metrology that have to provide measurement methods and instruments adequate for practical, technical and scientific requirements [2]. In this optic, modern biology and medicine methods need of specific quantification approaches too. This to obtain results with the highest level of accuracy.

2.1.2. The International System of Units (SI) and the dimensionless quantities

The term International System of Units (SI) was adopted in 1960 during the 11th CGPM. This adoption were preceded by that in 1954 were approved to add as base units the ampere, the Kelvin and the candela. Then in 1971 to these units were added the mole bringing the total number of base units to seven [1-3].

Base quantity		SI base unit	
Name	Symbol	Name	Symbol
length	$l, x, r, \text{etc.}$	metre	m
mass	m	kilogram	kg
time, duration	t	second	s
electric current	I, i	ampere	A
thermodynamic temperature	T	kelvin	K
amount of substance	n	mole	mol
luminous intensity	I_v	candela	cd

Definition of SI base units changed in time from the first in 1889 to the current adopted in 1983. Actually the definition of each SI base unit has to be unique and to provide a sound theoretical basis upon which the most accurate and reproducible measurements can be made.

Length (metre): *The metre is the length of the path travelled by light in vacuum during a time interval of $1/299.792.458$ of a second [4, 5].*

Mass (kilogram): *The kilogram is the unit of mass; it is equal to the mass of the international prototype of the kilogram [6].*

Time (second): *The second is the duration of $9.192.631.770$ periods of the radiation corresponding to the transition between the two hyperfine levels of the ground state of the caesium 133 atom [7].*

Electric current (ampere): *The ampere is that constant current which, if maintained in two straight parallel conductors of infinite length, of negligible circular cross-section, and placed 1*



metre apart in vacuum, would produce between these conductors a force equal to 2×10^{-7} newton per metre of length [8].

Thermodynamic temperature (Kelvin): *The kelvin, unit of thermodynamic temperature, is the fraction 1/273,16 of the thermodynamic temperature of the triple point of water [9, 10].*

Amount of substance (mole): *The mole is the amount of substance of a system which contains as many elementary entities as there are atoms in 0,012 kilogram of carbon 12; its symbol is “mol” [11].*

Luminous intensity (candela): *The candela is the luminous intensity, in a given direction, of a source that emits monochromatic radiation of frequency 540×10^{12} hertz and that has a radiant intensity in that direction of 1/683 watt per steradian [12].*

In 1960, during the 11th CGPM, prefixes, derived units and former supplementary units were established too.

Derived quantity		SI coherent derived unit	
Name	Symbol	Name	Symbol
area	A	square metre	m^2
volume	V	cubic metre	m^3
speed, velocity	v	metre per second	m/s
acceleration	a	metre per second squared	m/s^2
wavenumber	$\sigma, \tilde{\nu}$	reciprocal metre	m^{-1}
density, mass density	ρ	kilogram per cubic metre	kg/m^3
surface density	ρ_A	kilogram per square metre	kg/m^2
specific volume	v	cubic metre per kilogram	m^3/kg
current density	j	ampere per square metre	A/m^2
magnetic field strength	H	ampere per metre	A/m
amount concentration ^(a) , concentration	c	mole per cubic metre	mol/m^3
mass concentration	ρ, γ	kilogram per cubic metre	kg/m^3
luminance	L_v	candela per square metre	cd/m^2
refractive index ^(b)	n	one	1
relative permeability ^(b)	μ_r	one	1

(a) In the field of clinical chemistry this quantity is also called substance concentration.

(b) These are dimensionless quantities, or quantities of dimension one, and the symbol “1” for the unit (the number “one”) is generally omitted in specifying the values of dimensionless quantities.



Today, using the seven base units and their derived units, it is possible to describe and to analyze almost all kind of physical quantities. The exceptions are represented by those quantities that cannot be described in terms of the seven base quantities of the SI and that are defined as “dimensionless quantities”[3]. Dimensionless quantities can be found in some kind of conditions:

- Ratio of two quantities of the same kind, and are thus dimensionless, or have a dimension that may be expressed by the number one (As example absorbance value in spectrophotometric measures).
- Quantities defined as a more complex product of simpler quantities in such a way that the product is dimensionless (As example values derived by hydrophone calibration and expressed in dB_{spl}).
- Number that represent a count (As example bacterial quantification).

In these cases the SI unit to use is the number one itself, because all of these counting are defined dimensionless or of dimension one, so that the unit one is considered a base unit.

2.1.3. The Uncertainty in measurement and metrological concepts

Until the 1977 didn't exist an international harmonized method for the calculation of the uncertainty in measurement. In that year the CIPM requested the BIPM to realize this harmonization to achieve an international consensus on the expression of uncertainty in measurement. The BIPM, to obtain an internationally accepted procedure for expressing measurement uncertainty and for combining individual uncertainty components into a single total uncertainty, convened a meeting to create a work group formed by 11 experts from eleven national metrology laboratories. This group, named Working Group on the Statement of Uncertainties, realized in 1980 the Recommendation INC-1 (Expression of Experimental Uncertainties) that was approved by the CIPM in 1981. From this first step in 1993 born the Guide to the expression of uncertainty in measurement (GUM) [1] then corrected various times until the last version of the 2008 supported by seven organizations as:

- BIPM: Bureau International des Poids et Mesures
- IEC: International Electrotechnical Commission
- IFCC: International Federation of Clinical Chemistry
- ISO: International Organization for Standardization
- IUPAC: International Union of Pure and Applied Chemistry
- IUPAP: International Union of Pure and Applied Physics
- OIML: International Organization of Legal Metrology

The guide gives not only the significance of uncertainty in measurement but also guidelines in the use of concept and terms for the metrology as expressed by the “International vocabulary of metrology - basic and general concepts and associated terms” (VIM).

uncertainty (of measurement)

parameter, associated with the result of a measurement, that characterizes the dispersion of the values that could reasonably be attributed to the measurand (GUM 2.2.3)

This definition shows that what is defined uncertainty has to be always related to the measurand and how. If the results are out of the interval declared, this occurs with a probability corresponding to the risk of error of the first type [13]. With the concept of uncertainty is fundamental to define other concepts related to the measure as:

- **Measurand:** *particular quantity subject to measurement (VIM 2.6).*
- **Measuring instrument:** *device used for making measurements, alone or in conjunction with one or more supplementary devices (VIM 3.1).*
- **Measuring system:** *set of one or more measuring instruments and often other devices, including any reagent and supply, assembled and adapted to give information used to generate measured quantity values within specified intervals for quantities of specified kinds (VIM 3.2).*
- **Resolution:** *smallest change in a quantity being measured that causes a perceptible change in the corresponding indication (VIM 4.14).*
- **Stability:** *[...] metrological properties remain constant in time (VIM 4.19).*
- **Repeatability:** *condition of measurement, out of a set of conditions that includes the same measurement procedure, same operators, same measuring system, same operating conditions and same location, and replicate measurements on the same or similar objects over a short period of time (VIM 2.20).*
- **Reproducibility:** *condition of measurement, out of a set of conditions that includes different locations, operators, measuring systems, and replicate measurements on the same or similar objects (VIM 2.24).*
- **Accuracy:** *closeness of the agreement between the result of a measurement and a true value of the measurand (VIM 3.5).*



- **Precision:** *closeness of agreement between indications or measured quantity values obtained by replicate measurements on the same or similar objects under specified conditions* (VIM 2.15).

Each one of these concept are indispensable to understand the significance of “to do a measurement”.

2.1.3. Metrology of biosciences

In 1999 the BIPM participated, with a keystone role, in the creation of the Joint Committee for Traceability in Laboratory Medicine (JCTLM) which brought together the BIPM with the International Federation of Clinical Chemistry and Laboratory Medicine and the International Laboratory Accreditation Cooperation (ILAC) as well as representatives of manufacturers and regulators in the field of clinical chemistry [2]. In 2000 it born the Bioanalysis Working Group (BAWG) that became a member of the Consultative Committee on Quantity of Matter (CCQM), from this date the CCQM BAWG will be the most important organization related to the development of the metrology for biosciences. One of the last investigative about metrology for bioscience was published in 2011 from the BIPM and shows how this research field is rich of future developments [14].

Biometrology could be divided into different classes related to three factors strictly dependent each other:

- Type of measurement method to use;
- Type of biological material to analyse;
- Type of biological phenomena to describe.

The type of measurement methods applicable to execute measurements in biology are strictly related to the other two factor. The dimension of biological materials linked to their stability made really hard to obtain a good level of accuracy and of precision at the same time. For this reason measuring instruments give often results that need to be interpreted. At the same time specific phenomena needs more then one dimension to be understood and explained so need more than one instruments to obtain the final measure.

Biological materials could be divided in relation of their dimension and type:

- 0.3-3 nm: Small molecules
- 4-20 nm: Proteins



- 2-200 nm: Glycans
- 2nm-2m (in length): Nucleic acids
- 4-100 nm: Viruses
- 0,2-2 μm : Bacteria
- 2-30 μm : Yeast cell
- 2-10 μm : Mamm. cells

All these needs a specific approach to be quantified and often more than a single method is needed to obtain an adequate accuracy. Between all the biological materials the ones, that is more and better analysed today, are the nucleic acids thanks to the *polymerase chain reaction* (PCR) method. The problem is that often biological phenomena cannot be explained using only a count base method and there is the need to apply other kind of measures or measurement methods for describing them.

Biological phenomena, as activity, viability, efficacy, toxicity, are also that called “method-dependent quantities” need, to be quantified, of complex procedures that are strictly linked to the knowledge of biological cells and their metabolism [15]. Principal problem to describe these phenomena is the low stability of the measurands, so that often an experiment, even if performed very carefully, could be really hard to be reproduced. So that near to repeatability and reproducibility there is the problem of the comparability linked to the high instability of biological measurands.

The problem of stability is one of the big problems of metrology applied to the biosciences. In fact the biological materials instability could be influenced by environmental factors but, at the same time, is related to their tendency to change state and characteristics very fast compared to the times required to perform repeated measurements in order to increase the accuracy. For this reason two experiments at the same conditions but in two different moment could give different results, so showing a very high uncertainty. To avoid part of this problem one may, however, work with comparison measurements using a reference a value with a good stability common to both measurands.

1.2. Ultrasounds

Sound is a rapid motion of molecules transmitted through a gas, liquid, or solid in the form of a travelling wave. This propagated wave is generated by the mechanical motion of consecutive compression and rarefaction of these molecules that produce a pressure variation in the medium [16].

The sound is described in its time and space characteristics. About time, there is a periodical variation of molecular positions and the corresponding pressure, therefore an important parameter is the frequency (f) (SI unit: Hz). The frequency is then classified in relation with the frequency range, or spectrum, over which human beings can hear sounds called audible sound. Audible frequencies are between 20 Hz and 20 kHz approximately. Frequencies less than 20 Hz produce infrasound while above 20 kHz are called ultrasound (**Fig. 2.2.1**).

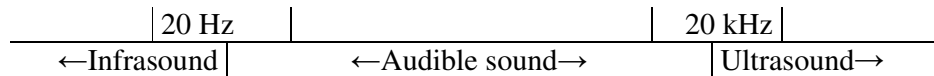

Fig 2.2.1. Acoustic spectrum

The pressure change in the medium produces a propagation in space, characterized by a wave peak to peak distance.

Other than for the frequency the sound wave is characterized by:

- **Amplitude value:** it is represented by half of the difference between maximum and minimum pressure.
- **Wavelength:** it is the distance between two adjacent crest and it is denoted by λ . (**Fig 2.2.2**)
- **Period:** it is the time that it takes for one cycle to occur and it is denoted by T and it is the reciprocal of frequency ($T=1/f$). (**Fig 2.2.2**)

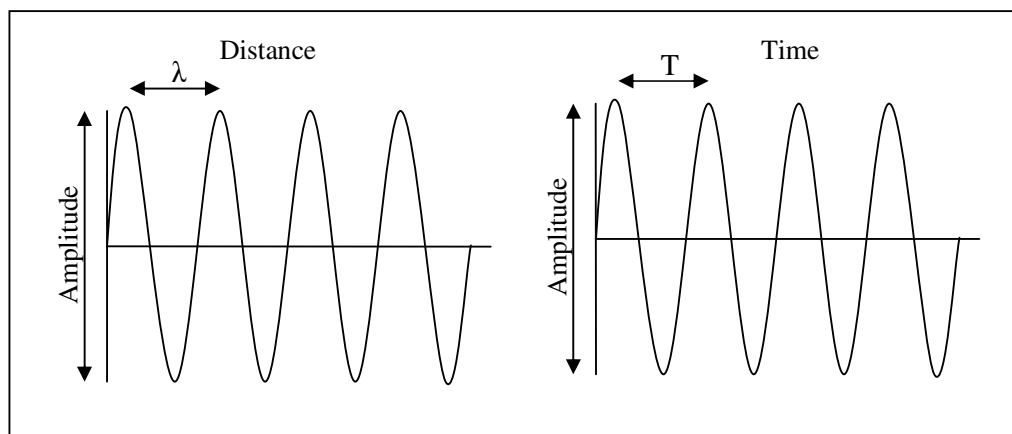

Fig 2.2.2. Acoustic waveform, amplitude vs distance (wavelength) and amplitude vs time (period)

During its motion the ultrasonic wave is modified in relation with the kind of medium that it passed through or better from medium characteristic of impedance and attenuation [16]. When the ultrasounds is propagated into a biological medium two specific effects were analyzed and described that are thermal and not-thermal mechanisms. Thermal mechanism is strictly related to



the attenuation of the wave, during its motion ultrasounds attenuation is due to either absorption or scattering. While the scattering is the effect that give a different direction to the ultrasonic wave, the absorption transform the kinetic energy into heat. In this last case the amplitude decreases with the distance with a simultaneous increase in temperature. This thermal mechanism increases with the increasing of medium attenuation [16].

The not-thermal mechanism is principally represented by mechanical effects, acoustic pressure and cavitation that will be described in later chapters.

2.3. Microbial biofilm modulation by ultrasounds, current concepts and controversies.

2.3.1. Introduction

2.3.1.1. Bacterial biofilm

Bacterial biofilm has been described since seventeenth century by van Leeuwenhoek and fully recognised in 1978 when a complete theory was formulated [17-19].

Bacterial biofilm is currently defined as “*a microbially derived sessile community characterized by cells that are irreversibly attached to a substratum or interface or to each other, are embedded in a matrix of extracellular polymeric substances that they have produced, and exhibit an altered phenotype with respect to growth rate and gene transcription*” [19]. A biofilm is characterised by cells adhesion to a not exfoliative surface, immersed in an aqueous medium and on other bacteria cells. The attachment mechanism could be explained by participation of several factors represented by the effects of the *substratum*, conditioning films forming on the substratum, hydrodynamics of the aqueous medium, characteristics of the medium, and various properties of the cell surface [18].

Proprieties of the cell surface linked to cell surface hydrophobicity, presence of fimbriae and flagella, and production of polysaccharide all influence the rate and extent of attachment of microbial cells [18]. These properties determine phenomenon of co-aggregation (interaction between planktonic micro-organisms of a different strain or species) and of co-adhesion (interaction between a sessile, already adhering organism and planktonic micro-organisms of a different strain or species) both fundamental for biofilm development [20, 21]. All those factors are required to obtain adhesion as surface-cell as cell-cell, with a constant competition between different bacteria species involved in this mixed community.



Another specific characteristic of bacteria biofilm is the presence of the “*matrix of extracellular polymeric substance*”, that contains polysaccharide, proteins and DNA and its formation is the consequence of metabolism of the microbial community forming the biofilm. This link explains why biofilm structure changes according to bacteria species that compose it [18, 20, 22, 23]. During the biofilm development, matrix creates a tridimensional structure with bacteria cells located in matrix-enclosed defined in literature “towers”, “stalk” or “mushrooms”. Many of these “structures” result in architecture with water channels between the “bacterial buildings”. The water channels look like a circulatory system which protects cell bacteria against toxic metabolites activity and operates as a source of nutrients [19, 20, 24]. Development and integrity of Biofilm structure are linked to a system of communication between bacteria species (spp). This system is represented by pheromones that allow cell-to-cell communication that could make bacteria forming biofilm to react against external stress as one. This communication system is called Quorum Sensing (QS) and it is closely involved both in biofilm formation and in surface motility in the opportunistic pathogens, its activation being linked to the activity of specific molecules called autoinducers (AIs) [20, 25]. Biofilm organization give to bacteria cells a strong resistance against pharmacological and chemical therapies. This resistance could be explained by the impermeability of the matrix, by the QS activation, by the negative influence that internal environment of biofilms has on antibacterials agent’s activity as oxygen gradients and by an altered growth rate of biofilm organisms [19, 26-28]. Biofilms resistance to the drug regimens, as well as their ability to grow by adhering firmly to surfaces, make them central to the pathogenesis and persistence of nosocomial infections associated with contaminate pipelines, dental unit water lines, catheters, ventilators and medical implants [19, 20]. Association between biofilms and diseases is not always straightforward, because biofilm infection cannot be proven according to Koch’s postulates. Infections strongly linked to biofilm development, such as periodontal disease, endodontic infections, valve endocarditis, cystic fibrosis, urinary catheter cystitis, all have in common the resistance to non-invasive therapies (as drug therapy) [20, 29, 30]. Starting from this perspective, US therapy were applied in these last years to obtain biofilm removal without biological damage to human cells, trying to reach the results obtained in water and food disinfections [30-35].

2.3.1.2. Therapeutic ultrasound

Therapeutic ultrasound (US) can be divided into two classes determined by the maximum spatial average field intensity: ‘low’ intensity (up to 3 W/cm^2) and ‘high’ intensity (over 5 W/cm^2). Low intensity treatments are aimed at stimulating physiological responses to injury, or accelerating



some biological processes. The purpose of high intensity treatments is rather to selectively destroy tissues. In this field, a wide range of US frequencies are employed, from about 20 kHz up to several MHz, with frequencies lower than a few hundred kHz generally defined as 'low frequency US' and frequencies of the order of 1 MHz and above 'high frequency US'. An alternative classification scheme would be in terms of applications for which the sound waves are directly propagated to the tissue via a coupling medium, and those for which the ultrasound transducer is coupled to a waveguide terminated with a tool specifically designed for the task required [36].

Among US medical applications, in the last 10 years there has been a considerable spread of US usage in dental clinical practice [37]. Since the 1950s studies can be found related to the use of ultrasonic scalers in periodontal therapy against bacteria biofilm, while the technology of modern instruments based on piezoceramic transducers, born a decade ago, is currently increasing its importance for many therapeutic surgical protocols [35, 37-39].

Ultrasonic scalers are instruments that allow the removal of root-surface accretions with a vibrating mechanical device [38]. In the literature it can be found how ultrasonic debridement allows to obtain similar clinical results to those registered with manual scaling and root-planing in periodontitis' therapy respect to probing depth reduction, gain of clinical attachment and decreased clinical inflammation [32, 37-42]. The advantages of ultrasonic debridement are represented by a shorter chair time and operator fatigue against using manual instrumentation [32, 42], but at the same time the application of ultrasound seems to be associated with a number of hazards that need to be avoided, to ensure safety of operators and patients in the dental practice [43].

Although this clinical role, we can find very few scientific works on ultrasonic application on oral bacteria [32, 41], and on the ultrasonic influence on bacteria in general too, principally based on *E. coli*, *S. aureus*, *B. subtilis*, and *P. aeruginosa* which represent the various structural types of bacteria and possible contaminants of common-use water facilities [44] (**Fig 2.3.1, 2.3.2**).

Therapeutic US effects are commonly classified into thermal and non-thermal effects. Indeed this division is merely theoretical because the two effects are often not separable except in special cases like extracorporeal lithotripsy [16, 36, 45, 46]. Absolute thermal effects are normally generated when a substantial amount of energy is transferred to a tissue by exposure to a continuous or discontinuous wave (with duration of the order of 1 s or more). On the other hand, non-thermal (mechanical) effects are produced by exposure to a high-power pulsed wave (with pulse duration much shorter than 1 s). However, some devices designed to produce non-

thermal effects (like the ultrasonic scalers cited above) employ continuous waves and therefore are likely to yield thermal effects also. A reasonable approach is then to assume that non-thermal effects will always be accompanied by some heating, because the interaction between ultrasound and tissue is simultaneously thermal and mechanical and there is insufficient evidence as to whether there is a true threshold for bioeffects resulting from either mechanism [16, 45].

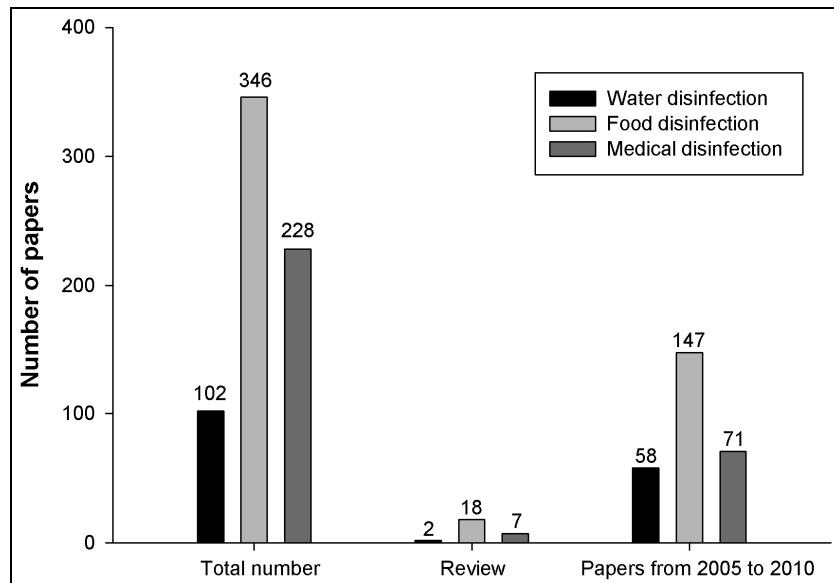

Fig 2.3.1. Papers published about the use of ultrasound to obtain an antimicrobial effect divided between its use in water disinfection, food disinfection and medical disinfection. Its interesting how while the total number of works showed that ultrasound using for medical disinfection represented the 34%, this percentage go down to 26% from 2005 to 2010. (<http://www.ncbi.nlm.nih.gov/pubmed/>)

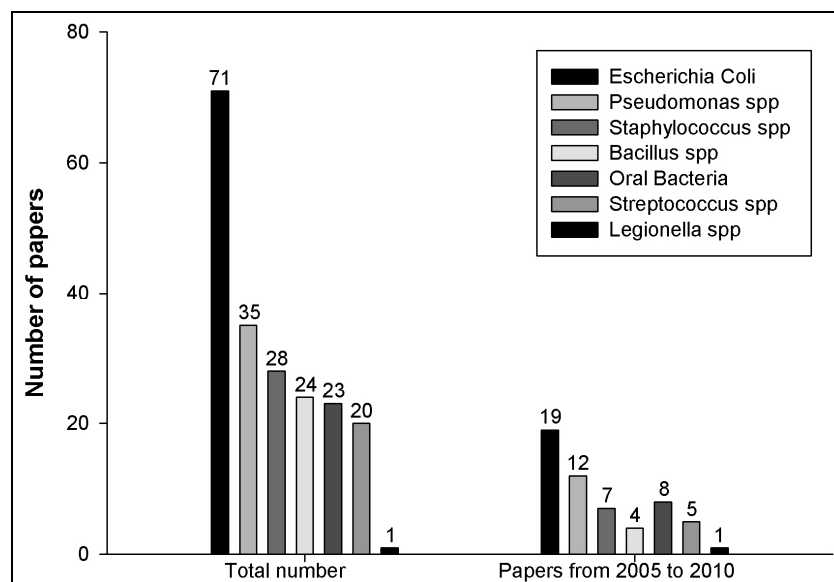

Fig 2.3.2. Papers published about ultrasound effects on different bacteria species. No strong differences can be highlighted between all article published and those of the years between 2005 and 2010. (<http://www.ncbi.nlm.nih.gov/pubmed/>)



2.3.1.3. Current concepts about ultrasound effects on bacteria population

Study of US effect on bacteria can be divided into different periods. Until the first half of 90 years we can see how the researchers concentrated their efforts to understand and outline the behavior of ultrasound in microbiology. These studies led to the acknowledgment of the mechanism of cavitation as the main responsible for the bactericidal power derived by US activity. From 1994 start the analysis of US effects combined with antibiotics or other bactericidal substances to obtain a bactericidal effect using US in vivo without sides effect. These studies led, in 2003, to understand the capabilities of ultrasound, under certain conditions, to stimulate bacterial metabolism. From this year we can find in literature many works about the analysis of US effect on bacteria in planktonic or in biofilm form but no one has yet described what cellular mechanisms are activated in bacterial cells when affected by ultrasonic field (**Table 2.3.1**). The US activities on bacteria are linked to both thermal and non-thermal effects and, on top of these effects, the most important on microbes is represented by the acoustic cavitation defined as “*the formation of tiny gas bubbles in the tissues as the result of ultrasound vibration*” [45, 47, 48]. Cavitation effects can have different consequences on bacteria cells based on bubble stability. The cycles of low and high acoustic pressure in the incident acoustic wave cause the gas bubbles to expand and shrink, which in turn creates shear flow around the oscillating bubbles [45, 47, 49, 50]. Stable cavitation results when the acoustic intensity is sufficiently low that the bubbles do not collapse violently during their contraction cycle. Collapse (or transient) cavitation is produced when the bubble radius is reduced to a very small value at the end of the contraction cycle [47, 51]. The sudden reversal of motion of the gas/liquid interface at the time of bubble rebound produces an outgoing shock wave, and the internal gas at peak compression reaches temperatures near 5000 K, which in turn can fragment water and other molecules into free radicals [31, 50]. In 2003 Joyce et al [52] described the antimicrobial activity of collapse cavitation, dividing this effect in four: (1) a surface resonance of the bacterial cells, “*pressures and pressure gradients resulting from the collapse of gas bubbles which enter the bacterial solution on or near the bacterial cell wall*”, (2) “*shear forces induced by microstreaming occurs within bacterial cells*”, (3) effects of free radicals derived from gases in the aqueous medium, (4) formation of a strong bactericide as the hydrogen peroxide (H_2O_2) derived by the sonochemical degradation of water. In the same work it is also cleared that, to obtain the maximum effect, high ultrasonic intensities are required. In the same year (2003) Piyasena et al [34] write a review about the use of US in food decontamination. In this work the authors describe in depth different US applications according to their antimicrobial effects. Opposed to the sonication (US application with only non-thermal effects) they study effects of thermosonication (heat plus

sonication), manosonication (pressure plus sonication), and manothermosonication (heat and pressure plus sonication) on food processing and microbial food safety.

	Authors	Year	Freq.	Objective	Tested bacteria	Conclusions
1	Scherba et al.	1991	26 kHz	Study of Bactericidal effect of US	<i>E. coli</i> , <i>S. aureus</i> , <i>B. subtilis</i> , <i>P. aeruginosa</i>	Cavitation is the mechanism responsible of bacteria damaging with similar result on Gram- and Gram+.
2	Pitt et al.	1994	67 kHz	US to grow antibiotic activity on biofilm	<i>P. aeruginosa</i> , <i>E. coli</i> , <i>S. epidermidis</i> , <i>S. aureus</i>	Bacteria in a biofilm may become susceptible to antibiotics through ultrasonic treatment.
3	Phull et al.	1997	38 kHz, 800 kHz	US biocidal effect with or without chemical disinfectant	<i>E. coli</i>	US are suitable for water disinfection. US at high frequency are more effective to obtain biocidal effect. Chemical disinfectant activity is improved by US.
4	Rediske et al.	1998	70 kHz	Bactericidal effect of US alone or combined with an antibiotic	<i>E. aerogenes</i> , <i>S. marcescens</i> , <i>S. derby</i> , <i>S. mitis</i> , <i>S. epidermidis</i>	Bacterial viability was reduced when US were combined with antibiotics. No difference were seen between Gram+ and Gram- bacteria.
5	Peterson and Pitt	2000	70 kHz, 500 kHz	Bactericidal effect of US combined with an antibiotic	<i>E. coli</i>	The combination of the ultrasound and antibiotic appears to be very effective. Low frequency with high power intensity show better results then high frequency.
6	Piyasena et al.	2003	Various (Review)	Inactivation of microbes using US	Various (Review)	The use of US in the food industry for bacterial destruction is currently unfeasible; however, the combination of ultrasound and pressure and/or heat shows considerable promise.
7	Joice et al.	2003	20 kHz, 38 kHz, 512 kHz, 850 kHz	Effect of US at different powers and frequencies on <i>Bacillus subtilis</i> .	<i>B. subtilis</i>	Sonication has two effects: Bacterial declumping and bacterial killing. The overall effect of applying US is the result of a competition between killing and declumping bacteria.
8	Pitt and Ross	2003	70 kHz	US can increase the growth rate of bacterial cells.	<i>S. epidermidis</i> , <i>P. aeruginosa</i> , <i>E. coli</i>	Applying low frequency and intensity US increased the growth rate of the cells.
9	Carmen et al.	2005	28.5 kHz	Treatment of biofilm infections with US and antibiotics in vivo	<i>E. coli</i> , <i>P. aeruginosa</i>	Antibiotic-US treatment for 48 h reduced viable bacteria. When <i>P. aeruginosa</i> biofilms were treated for 24 and 48 h, no reduction of viable bacteria was observed.
10	Runyan et al.	2006	70 kHz	Study on US activity on bacterial membrane	<i>P. aeruginosa</i>	US create holes or perturbations in the outer membrane lipid bilayer sufficiently large for the passage of relatively large hydrophilic compounds, including antibiotics.
11	Kirzhner et al.	2009	20 kHz	US efficiency to remove microbial biofilm.	Wastwater heterotrophic aerobic bacteria	US treatment is effective in removing bacteria biofilm that otherwise adhere to the roots, by more then two orders of magnitude.
12	Declerck et al.	2010	36 kHz	Evaluation of power US for disinfection of some bacteria species	<i>L. pneumophila</i> , <i>A. castellanii</i>	Possible application of power ultrasound in the control of both studied bacteria. However, the energies required to use ultrasound alone as a disinfection technique are rather high and therefore not recommended to use for general large-scale microbiological decontamination

Tab 2.3.1. Selection of various papers that showed from 1991 to today novels concepts about ultrasound effect on microorganisms.



Bacteria, and in particular spores, are resistant to non-thermal effects alone, so, to obtain the killing effect, US would most likely have to be used in conjunction with pressure treatment and/or heat treatment. About this Piyasena et al write that “*the enhanced mechanical disruption of cells is the reason for the enhanced killing when ultrasound is combined with heat or pressure*”. This work shows how it is necessary to know the activity that thermal effects, mechanical effects and cavitation (with shock waves) effects have respectively, to understand US global effects on bacteria. Another interesting work about US activity outside human medicine by Kirzhner et al, in 2009, describes the use of cavitation effect to remove bacteria biofilm on Water Hyacinth plants roots [33]. In this paper the authors, applying low frequency sonication, proved that the US treatment is effective in decreasing microorganisms that otherwise adhere to the roots, by more than two orders of magnitude.

2.3.1.4 Bacteria response to US activity

US activity can determine two possible response by bacteria: a bactericidal effect opposed to a stimulation of bacterial growth.

US bactericidal effect seems linked to collapse cavitation that occurs at higher intensity levels and lower frequencies for which the oscillating bubbles can violently accelerate the fluid around them. During bubble collapse, the adiabatic heating of the internal gas produces very high temperatures, which in turn generate free radicals, high liquid shear force, and a shock wave as the collapsing spherical wall suddenly reverses its motion [53]. With a sufficient number of collapse cavitation events, cell membranes can be stressed by high fluid shear rates, or damaged by the heat or free radicals [34]. Furthermore, cavitation adjacent to a solid surface (such as a bacterium) generates stress on the cell membrane during bubble expansion; and then during contraction an asymmetric collapse propels a high velocity jet of liquid towards the surface [53-55].

Bactericidal effect has been described first by Scherba et al. who, in 1991, wrote a work in which they described US bactericidal effect on *E. coli*, *S. aureus*, *B. subtilis* and *P. aeruginosa* in planktonic form. In this paper the authors studied the effect of US applied on bacteria species with a frequency of 26 kHz, using three different intensity descriptors: spatial-peak temporal-peak intensity (I_{SPTP}), spatial-peak temporal-average intensity (I_{SPTA}) and spatial-average temporal-average intensity (I_{SATA}), and three exposure levels (defined low, medium, and high). The exposure durations examined for the bacterial experiments were 1, 2, 4, 8, 16, and 32 min. Results of this work show how all the bacteria species analysed were killed by US application, with a killing rate directly proportional with the exposure time and with the intensity level. The



principal ultrasonic effect, at low frequency, responsible for bactericidal power seemed to be cavitation effect with no difference between Gram- or Gram+ bacteria [44].

In 1994 Pitt et al. described the synergism between US activity with antibiotics to kill the bacteria forming biofilm (*P. aeruginosa*, *E. coli*, *S. epidermidis*, *S. aureus*). In this paper the authors showed how ultrasonic treatment alone, with a frequency of 67 kHz and intensity of 0,3 W/cm², appeared to have no statistically significant effect on viability. Testing US with antibiotic addition the authors obtained a bactericidal effect better than the bactericidal effect of antibiotics alone while US alone, at 67 kHz, showed an increasing in bacteria growth rate. About this increased growth the authors wrote that it cannot be attributed to a higher oxygen concentration or modification of the terrain nutrient, but it may be possible that cells are under some stress and show stress-induced growth [56]. A similar work, about US bactericidal activity associated to disinfectants on *E. coli*, was written by Phull et al in 1997 [57], then other works on the synergism between US and antibiotics by Rediske et al. appeared in 1998 and 1999 (first on *E. aerogenes*, *S. marcescens*, *S. derby*, *S. mitis* and *S. epidermidis*, then on *P. aeruginosa*) [58, 59]. In 2000 Peterson and Pitt, studying *E. coli*, showed how low frequency US with high power intensity show better antimicrobial results than high frequencies US [57, 60]. In 2004 Duckhouse et al studied US bactericidal effect associated to sodium hypochlorite solution with good results on *E. coli* [61], in the same year Stanley et al. demonstrated that *E. coli* inactivation can be obtained by high-intensity ultrasonication with the presence of salts [62].

2.3.1.5 Therapeutic US in medical field

In medicine US has found applications since 1924, when Wood and Loomis first described the biological changes related to ultrasonic treatment [63]. Today US is used in medicine from diagnostic to therapeutic applications. Talking about ultrasound activity on bacteria, we can find in literature three principal fields of application: the direct action of US on bacteria biofilm [31, 64, 65], their activity to reinforce drugs' activities, and US action to obtain optimal bacteria growth to get easier infection's diagnosis [66, 67]. In 1991 Scherba et al. first describe ultrasound activity on various microorganism studying effect of low frequency (26 kHz) sonication applied on suspensions of bacteria (*Escherichia coli*, *Staphylococcus aureus*, *Bacillus subtilis*, and *Pseudomonas aeruginosa*), fungus (*Trichophyton mentagrophytes*), and viruses (*feline herpesvirus type 1* and *feline calicivirus*) [44]. For bacteria quantification, after US exposure, each sample was plated separately and incubated for 3 days, after which the number of colonies was counted. For fungus quantification, after the US exposures, the fungal plugs were blotted on sterile filter paper and plated on similar agar media. The plates were then incubated at



26°C and ranked daily according to the amount of growth. Viruses quantification titler was measured by a microtitration procedure. The authors' conclusion was that tested US frequency has efficacy in inactivating some disease agents with some uncertainty about viruses response. Their results show that cavitation effect is the physical mechanism responsible for damaging the microorganisms with similar result on Gram- and Gram+.

In 2003 an interesting paper by Carmen et al. analyse which bacteria are commonly involved in orthopedic implant infections. They report how, in those kind of infections 35% of the organisms were *S. aureus*, 15% were *S. epidermidis*, 25% were coliforms, and 25% were anaerobes and others as previously described by Sanderson [68]. In their work Carmen et al. investigated the combination of low frequency US and vancomycin treating *S. epidermidis* infections in a rabbit model. In a second time they compared their results with those obtained by the combination of US and gentamicin against *E. coli*. Treatment of *S. epidermidis* biofilms with vancomycin and 48 h of ultrasound significantly enhanced the reduction of viable bacteria in the biofilm. Despite this result, the author admitted that the combination of ultrasound and gentamicin is more effective against *E. coli* in vivo than the combination of ultrasound and Vancomycin against *S. epidermidis* [69]. In 2009 Tor Monsen et al. describe sonication activity applied to stimulate bacterial growth to analyze the contamination of prosthetic joint infection [30]. In this work the authors found different activity of US among different bacteria species. The aim of this study was to evaluate the effects of temperature, duration, composition of the sonication buffer, and material during sonication of bacteria often associated with prosthetic infections prior to culture. Gram+ shows a greater resistance against ultrasonic action than Gram-. In their work, the authors underline that the container material has an influence too: tubes of glass show a higher influence on US diffusion than plastic tubes. This work was based only on bacteria related on prosthetic joint infection but takes important information about US action on human pathogens bacteria as *Escherichia coli*, *Haemophilus influenza*, *Pseudomonas aeruginosa*, *Enterococcus faecalis*, *Staphylococcus aureus* and *Staphylococcus epidermidis*.

2.3.2. Experimental approaches on bacteria biofilm

2.3.2.1 Literature's analysis

After the work in 1994 by Pitt et al., about US effect on oral biofilm [56], we have to wait 10 years to find in literature an update on this topic. In 2004 Carmen et al. executed new series of test on bacteria response to the combined activity of US+antibiotics in vivo. They chose to work with a US frequency of 28,48 kHz applied on the *S. epidermidis*. Their work described how

ultrasonic treatment increased the killing of viable bacteria without causing bacteremia or tissue damage [69]. In 2005 Ensing et al. and Carmen et al. published others works on synergism of US and antibiotics in vivo on bacterial biofilm. Ensing et al. work on *E. coli* analyzed how, with 70 kHz US in combination with gentamicin, they could obtain an enhanced killing of bacteria [67]. Carmen et al. paper studied US+gentamicin activity on *E. coli* and *P. aeruginosa* biofilms in vivo. Their results reported the successful use of ultrasound in vivo when the treatment of *E. coli* biofilms was extended to 48 h, and the failure of such therapy to reduce viable bacteria in *P. aeruginosa* biofilms. The *P. aeruginosa* biofilm resistance was linked to the extraordinary outer membrane impermeability of that bacterium [26, 70]. In 2006 Ensing et al. extended their work in vivo on *P. aeruginosa* and *S. aureus* too. Their results showed a resistance of *P. aeruginosa* biofilm to US+antibiotic activity, confirming Carmen et al. results but without finding an explanation [66]. Following these results, in 2006 Runyan et al. published a paper based on the analysis of permeabilization of *P. aeruginosa* biofilm after US application in vitro. In this work they applied US at 70 kHz of frequency and 4.6 W/cm² of intensity on both *P. aeruginosa* forms (planktonic and biofilm). Their work demonstrated that US in vitro creates holes or perturbations in the outer membrane lipid bilayer sufficiently large for the passage of relatively large hydrophilic compounds, including antibiotics [53]. Despite these conclusions, it remains unresolved why previously experiments in vivo showed a strong *P. aeruginosa* biofilm resistance to US+antibiotics activity [67, 70, 71].

In 1997 O'Leary et al. wrote the only paper in literature related to US bactericidal effect on oral bacteria which *A. actinomycetemcomitans* and *P. gingivalis*. Those bacteria, defined as periodontal pathogens, are two of the principals responsible for periodontal disease in human [40]. This study showed how ultrasonic debridement with a dental ultrasonic scaler (frequency ~25 kHz) in vitro destroyed bacteria biofilm but authors could not demonstrate any bactericidal effect related to acoustic phenomena. In their conclusions they admitted that further investigations will be necessary of the acoustic bacteriolytic potential of ultrasonic scalers while the principal bactericidal effect seemed to be linked principally to the mechanical oscillation of the tip [41].

In their review of 2003, Piyasena et al, analysing antimicrobial inactivation by US activity described how further study on US will need to determine the effect of ultrasound on microbial inactivation efficiency when used with other processing technologies (high pressure, heat or others), to identify the mechanisms of microbial inactivation when used in combination with other technologies and the critical process factors when ultrasound is used in hurdle technology [34].



In 2003 Pitt and Ross described US stimulation of bacterial growth rate [50], an effect already described by Pitt et al. in 1994 [56]. In this paper they analyzed three species of bacteria as *S. epidermidis*, *P. aeruginosa* and *E. coli* after application of US with frequency of 40 kHz and intensity variable from 2 to 4 W/cm². They studied bacteria adhesion ability and bacterial quantification with and without US application, and their results showed how bacterial biofilms grow better exposed to low intensity and low frequency US while the growth of planktonic cultures also appears to be enhanced by US. Authors proposed that this effect could be caused by increased nutrient and waste transport during biofilm development, following various works about the nutrient concentration gradient within the bacterial biofilms [22, 71, 72]. In 2009 Tor Mosen et al., as previously described, applied US activity to obtain an easier diagnosis of prosthetic infection. In their work they used US prior to conventional culture to obtain a better bacterial growth. In conclusion they found that a recovery of bacteria after sonication is dependent on the type of microorganism tested, the temperature of the sonication buffer, the time of exposure to ultrasound, and the material and composition of the sonication tube [30].

Another study in 2008 reproduced in vitro US effect on *E. coli* biofilm. In this paper the authors analyzed bacteria viability after biofilm destruction, using High-intensity focused ultrasound (HIFU) with a pulse repetition frequency of 1000 Hz. Authors determined US biocidal effect analysing the number of colony forming units (CFU) and found that the US treatment was able to completely destroy the biofilm for most exposures at the two highest exposure levels. During CFU analysis they found still a residual bacteria viability at those exposure level too. Their results showed how a two step study to determine biofilm destruction and then bacteria killing is inefficient to determine real effect of US on biofilm because their method, to study bacteria viability, based on biofilm scraping after US exposure, could alone falsify final results [31].

2.3.2.2 Evaluation of US effects on biofilm

US and bacterial motility and adhesion: Bacterial motility and adhesion are linked to various specific structures placed on cell surface as flagella (linked to motility) and fimbriae (linked to adhesion) [18]. Those structures make bacteria able to interact with the environment and with others eukaryotic cells.

Flagellum is the most common and best studied motility structure, it enables bacteria to swim through their medium and to change direction in response to attractants or repellents in the environment, which cells detect with chemotaxis system [73]. US activity on bacterial motility was studied analyzing effect of the sonification on a *P. aeruginosa* population [56]. During the experiment quick darting motion were analysed, typical of flagellated bacteria, from quivering or



shaking motion without any net forward movement. This study showed how cellular stress, induced by ultrasonic field, reduced flagella motility after 9 hours of sonication at 67 kHz. These data should not necessarily imply that during and after US application bacterial cells are stationary and immersed in the medium. They still showed movement, although reduced, due to the activity of remaining flagella but linked to possible Brownian motion too [74].

Bacterial attachment ability is strongly influenced by US action as before as after biofilm formation. US ability to remove bacterial cells from surface is today fully recognized, so that such application is commonly applied in many field and has been studied and described in many articles [31-33, 64, 75, 76]. However, this effect is related to a simple mechanical destruction of the biofilm extracellular matrix due to the effect of ultrasonic cavitation (derived by High intensity and Low frequency US) or to the direct contact of the transducer with the biofilm without any interaction with adhesive mechanism. Studies about this US removal power showed also how sonification is unable to strip all bacteria from surfaces. Many works show how detachment percentages of bacterial cell are all around 85-90% after US low frequency application (from 40 to 100 kHz) with a peak of 95% obtained applying highest power density at 38 kHz [75]. In all cases bacterial cell detachment is linked to cavitation effect that can be generated only by low frequency US which, at high intensity ($> 10 \text{ W/cm}^2$), is also able to lyse cellular membrane causing to kill cells in addition to partially removing them from surfaces [77]. More recent studies have verified how US activity stimulates bacterial metabolism and in particular, in our case, the ability of bacteria to adhere to surfaces by enhancing the related mechanisms [30, 50]. At high intensity this stimulation could be the explanation of the US inability to completely destroy biofilm structure mechanically. When US are applied at low frequency and low intensity (2 W/cm^2), their effects on bacteria adhesion mechanism and metabolism are instead diametrically opposite. At low intensity US is not able to deliver enough mechanical energy to obtain biofilm structure destruction and cell detachment, unless up to a minimal degree, and instead it will stimulate bacterial metabolism with formation of a biofilm which is more resistant and strongly adherent to surfaces [50].

US and matrix's structure and water channels: Extracellular Polymeric Substances (EPS), composed fundamentally by polysaccharides, are the primary matrix material of biofilm [18, 78]. Their chemical composition and characteristics are strictly linked to bacterial type forming biofilm: Gram- bacteria principally forms neutral or anionic EPS while for Gram+ EPS chemical composition may be cationic [18]. These differences determine different relationships between matrix and external environment, as example if there is the presence of divalent cations such as



calcium and magnesium [78]. EPS showed a highly hydrated structure with both hydrophilic and hydrophobic characteristics, and these enable EPS to protect bacteria forming biofilm by dehydration if exposed to hostile environment and by antibacterial agents preventing their penetration by binding them directly [19, 28, 78]. Matrix development is principally linked to a good nutrient status of the growth medium and by presence of slow bacterial growth [18]. Biofilm final architecture is represented by a dynamic structure that changes constantly following environmental and internal stimuli. Water channels work actively to promote biofilm adaptation both with nutrient and oxygen transportation but, more important, enabling cell-to-cell communication through the QS and, eventually, their movement into biofilm buildings [18, 19].

US activity on the matrix must be divided into high intensity US effect and low intensity US effect. High intensity US seems to be principally linked to a mechanical destruction of the polymeric substance with bactericidal effect [34] while low intensity shows to stimulate bacterial growth and biofilm development [30, 50]. Both these effects are related to a dual effect that US has on the biofilm structure: while there is a mechanical destruction of extracellular substance by cavitation effect there is also a stimulation of bacteria metabolism and the increase of oxygen and nutrients transport in the deeper layers of the biofilm [60, 79]. The prevalence of one or the other effect gives the final result. Low intensity US show bactericidal effect only when combined with antibiotics as gentamicin [80]. This result can be explained with various hypotheses, firstly that US enhances drug transport through the extracellular matrix and increases the concentration surrounding the bacteria, while at the same time antibiotic activity seems to be increased when cells at the base of a mature biofilm, usually dormant, become active [59, 69]. Activation occurs when the upper layers of the biofilm are killed and subsequently removed, thus making increased levels of nutrients available to the underlying bacteria [70, 71]. When US are applied to a mature biofilm is necessary to understand well how they operate and what final result the operator wants to obtain.

US and bacterial viability: Biofilm structure and its biochemical environment give bacteria a strong resistance to external agents, resistance comparable to that of spore-forming bacteria. The biofilm infection appears to be from 10 to 1000 times more resistant to antimicrobial agent than planktonic infections [28]. This biofilm resistance can be explained with multiple mechanisms that work all together to evade antimicrobial agents effects. Among these effects can be cited the inability of antibacterial agents to penetrate the matrix, the starved state of many bacteria present into the biofilm and physiological changes due to the biofilm mode of growth [19, 20]. Antimicrobial agents diffusion through matrix structure is a necessary condition to obtain the

antibacterial effect. Matrix composition play a fundamental role in biofilm resistance and its impenetrability can obviously be influenced by extracellular polymeric substances composition [19]. An interesting case is that of *P. aeruginosa* which, in the form of biofilms, has a great resistance to antibacterial agents with the ability to produce alginate [19, 20, 81]. This substance showed the ability to inhibit the distribution of various antibacterial agents as gentamicin and tobramycin through the matrix [81, 82].

The altered growth rate of biofilm organisms is another possible condition that gives bacteria forming biofilm a best resistance against antibacterial agents. A slower bacterial metabolism is obviously linked to a reduction in antimicrobial power of antibacterial agents. The low oxygen and nutrient concentrations in biofilm deeper layers well explains how bacteria cause biofilm drug resistance [19, 20, 78].

Another crucial feature of biofilms which explains their resistance to antimicrobial agents is the quorum sensing. A mature biofilm is characterised by the presence of various bacteria species, and quorum sensing makes them able to communicate with each other by exchanging information or even to stimulate mutations to entire sections of their genome [83-86]. US have four possible ways, yet previously explained, to determinate a bactericidal effect: through acoustical cavitation, increasing antimicrobial agents' activity, producing a mechanical oscillation of a tip or generating high temperatures. At the same time it is necessary to remember again how US could also determine stimulation of bacterial growth (for example with the frequency and intensity used to increase drugs activity) (**Fig 2.3.3**).

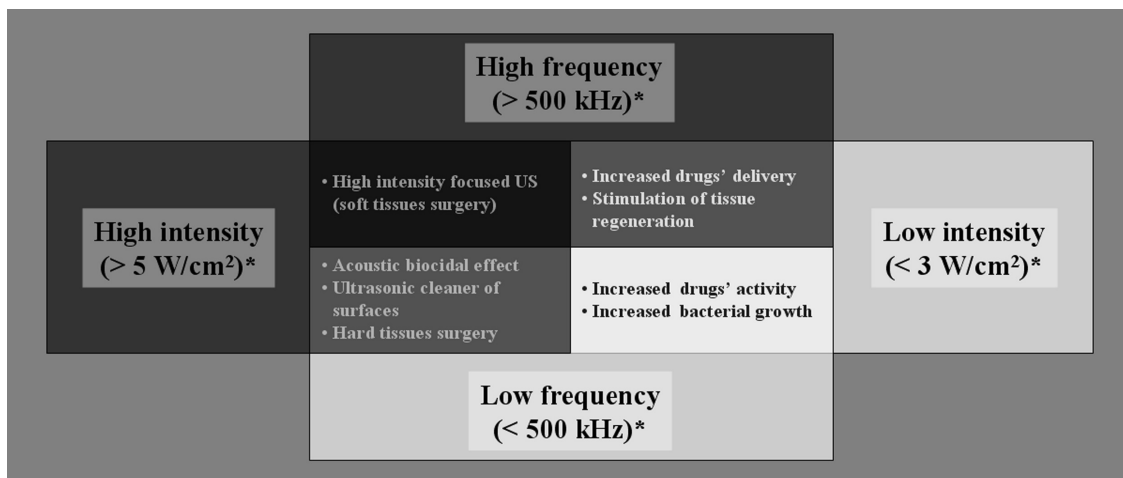

Fig 2.3.3. Different biological effect derived by ultrasound application depending on frequency and intensity variations. (*Concept of high or low frequency and intensity derived by the analysis of work published about biological activity of ultrasounds and are not linked to the same concepts for others scientific fields.)



Often, several of these effects can be present together, obtaining a final effect very difficult to study and to analyse. For this reason scientific papers in literature describe, in most cases, only one effect alone and never analyse QS responses. This approach have obviously the limit of not determining precisely the final bactericidal or bacterial growth stimulation effect in vivo.

2.3.3. Discussion and conclusions

US technologies applied to antibacterial treatment have already been developed extensively to play a key role for their future use in food industry as well as for water decontamination [34, 57]. In these applications US antibacterial activity can be used without great risk of side effects by choosing frequencies and intensities high enough to avoid the bacterial growth stimulation [50] (Fig 3). In particular, in food industry, US was been used for many years as a measuring or analysis tool while its decontamination power is still under study [34]. The use of therapeutic US for antimicrobial treatment in vivo is principally based today on its ability to improve antibiotics activity [69]. This application is employed for example to eradicate infections in joint prostheses adding US activity with gentamicin [51, 52]. Many studies in literature report about this activity as the only way to treat biofilm infection when it is impossible to realize a mechanical treatment [53]. Recent studies about biofilm destruction using only US activity show well how, when ultrasonic action at high frequency is unable to kill bacteria, yet it is able to perform tissue damage [15, 72]. In literature there is also some confusion about the ability, showed by bacteria, of an adaptability to US exposures at lower level than the bactericidal level, so that some bacteria develop as an answer the ability to produce a stronger biofilm with a high resistance to further therapeutic actions [3, 66]. In particular it is very interesting the case of *P. aeruginosa*, that showed to have a great resistance to US procedures when in biofilm form. Many studies about this resistance could not find a clear explanation to this phenomenon, as previously described. The most probable explanation for this behavior could be maybe found in the formation of a stress-induced resistance correlated with mechanisms of quorum sensing. The quorum sensing genes are fundamental for the *P. aeruginosa* pathogenesis and have a key role for its biofilm formation [25]. *P. aeruginosa* quorum sensing modulation is linked to two specific N-acylhomoserine lactones, wich are the Ais of Gram negative bacteria, termed Las RI and Rhl R1 [20]. The Las and Rhl systems work directing the synthesis of N-3-oxododecanoyl-homoserine lactone (3OC12- HSL) and N-butanoylhomoserine lactone (C4-HSL) fundamental to generate a mature biofilm. The *P. aeruginosa* biofilm is characterized also by the bacterial production of alginate linked to the expression of a specific gene called mucA [84, 87]. Many studies show that alginate production by *P. aeruginosa* is not stable in time but is stress related, when the



bacterium is exposed to a stimulus that causes harm, whether physical, mechanical or chemical, there is activation of the quorum sensing and secondary of the gene predisposed to the development of alginate [87]. By alginate system activation the *P. aeruginosa* is able to develop a biofilm highly resistant to standard therapies, this could explain the large difference between the action of US on bacterial in planktonic or in biofilm form. When US activity isn't sufficient to produce a rapid bactericidal effect the stress-induced added to growth stimulation probably allows the bacterium to develop, through mechanisms of quorum sensing, a more resistant biofilm.

As for *P. aeruginosa*, the US double effect of killing and stimulation probably acts similarly on other bacterial species, with perhaps less obvious effects. Further studies in this direction, focusing just on quorum sensing and gene expression, would better understand the action of ultrasound at frequencies not even fully bactericidal.

In the light of what has been reported so far, US activity against bacteria and in the biofilm modulation still has many unclear points. Through studies realized until now we have a good analysis about US diffusion and macroscopic response by bacteria in planktonic or biofilm form. What is yet undetermined is a critical study about how the activity of US could alter the bacterial quorum sensing and gene expression. Another further topic will be studying how to determine the mechanisms of bacterial inactivation both in terms of proteomics and by means of other factors that may influence the US action (pressure, temperature, chemical activity).

Although many studies have led to a rapid increase in knowledge about the ultrasonic technology, much remains to be studied. This awareness can leave a great deal of future research in order to achieve full awareness of the potential of this instrument.

2.4. Conclusions

The low stability of bacteria during their growing in association with the not well understood double effect that the US have on microbial species, make it difficult to assess the correct relationship between them.

In order to identify biological mechanisms related to US effect on microbial cells, a close control of the uncertainty is required in relation not only with the measurement instrument but also with the method and the measurand.



The application of a metrological approach, to investigate all these three factors at the same time, is at the base of this work and it will try to highlight the weaknesses that could exist and, where possible, to correct them.

The results of the thesis will allow to identify, with the higher accuracy possible, the microbial metabolism's changes in response to the exposition to an ultrasonic field and specifically to an acoustic pressure.

3. MATERIALS AND METHODS

3.1. Choice of methods and experimental plan

To achieve the research scope it was created an experimental plan in which the work was divided in three steps. Each step was related to a different kind of field and was development in different place. The first step was the phase of physical analysis, the second was the phase of biological analysis while the third was a mixed phase where the results from the first two steps were applied. (Table 3.1.1, 3.1.2). To achieve these objectives an analysis of methods, materials and instruments that were used was performed.

Step 1	Acoustic measures
Step 2	Biological measures
Step 3	Mixed measures
	Uncertainty and statistical analysis of data
	Future prospective

Tab 3.1.1. Experimental plan

Step 1	Creation of a support to perform the measurements with an hydrophone into an ultrasound bath
	Hydrophone calibration
	Acoustic pressure measurement in baseline condition (P0)
	P0 repetition putting the Hydrophone into different type of tubes where will be put bacteria (P1-P2-P3)
	Uncertainty and clustering of data
	Acoustic pressure analysis and choice of frequencies
Step 2	Metrological evaluation of the method to analyse bacteria viability and biofilm development (microtiter plate assay)
	Eventual method correction
	Analysis and evaluation of base values of bacterial growth
Step 3	Bacterial viability and biofilm development measurement after ultrasonic exposure
	Uncertainty and statistical analysis of data
	Future prospective

Table 3.1.2. Experimental plan with details

3.2. Step 1

1. Creation of a support to perform the measurements with an hydrophone into an ultrasound bath
2. Hydrophone calibration
3. Acoustic pressure measurement in baseline condition (P0)
4. P0 repetition putting the Hydrophone into different type of tubes where will be put bacteria (P1-P2-P3)
5. Uncertainty and clustering of data
6. Acoustic pressure analysis and choice of frequencies

3.2.1. Description

The first step is related to ultrasound analysis procedure. To perform this kind of evaluation an ultrasonic bath from the acoustics and ultrasounds department of the National Institute of Metrological Research (INRIM) in Turin was used (**Fig 3.2.1.1**).



Fig 3.2.1.1. Ultrasoni bath

To realise the measurements were identified four critical conditions:

- To identify the frequencies to explore;
- To find a method to achieve repeatable and reproducible measurements;
- To find an instruments do realise measurements of acoustic pressure;
- To identify the method to expose the bacteria to the ultrasonic field without contaminating the system.

Frequencies: To choose the frequencies to use, it was studied which of them were normally used for decontamination, in contact with human cells or to delicate instruments and, at the same time, which were used for short periods of time (at least 60 seconds). For these reasons frequencies from 20 to 40 kHz have been chosen.

Method for repeatable and reproducible measurements: To try to lower as much as possible the variability of the various measures has been chosen to build a tripod-grid to be placed above the bath so as to be able to repeat the measurements in the same points at each replication.

Instrument to measure acoustic pressure: To measure the acoustic waves produced and calculate the various acoustic pressures was chosen a hydrophone needle.

System to avoid contaminations: To avoid contamination, it was decided to use tubes that will be immersed inside the tank and that will contain within the culture medium with the bacteria.

3.2.2. Ultrasonic bath and tripod-grid creation

To perform ultrasound analysis the ultrasonic bath was measured to create a support that could be used to guide the measures.

To realise the support they were chosen as materials aluminium and plexiglass. The aluminium was used to create the base for the grid and for the legs, the grid was built in plexiglass with three niches to be blocked on the basis. The tripod-grid creation was made at the workshop of the Department of Management Engineering and Production (DIGEP) of the Polytechnic of Turin (**Fig 3.2.2.1-3.2.2.13**).

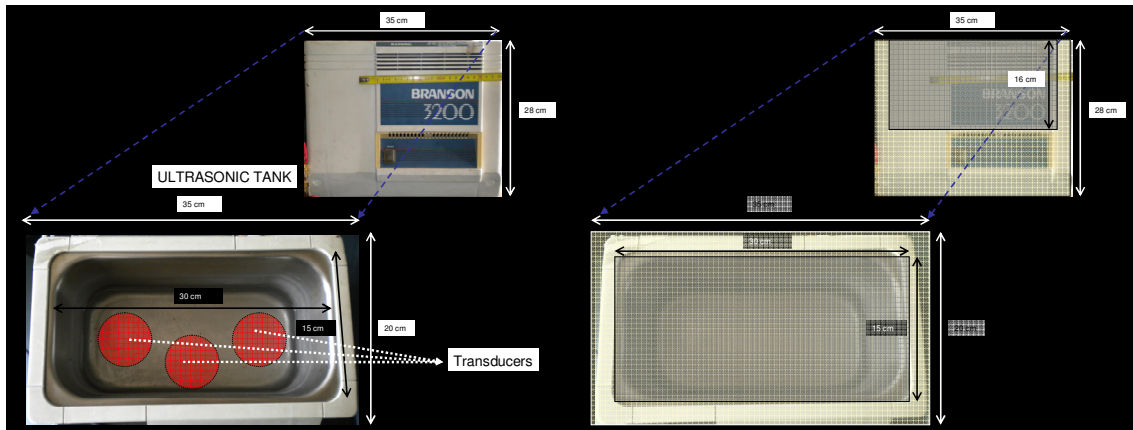

Fig 3.2.2.1 and 3.2.2.2. Measures of the tank and schematization of its structure.

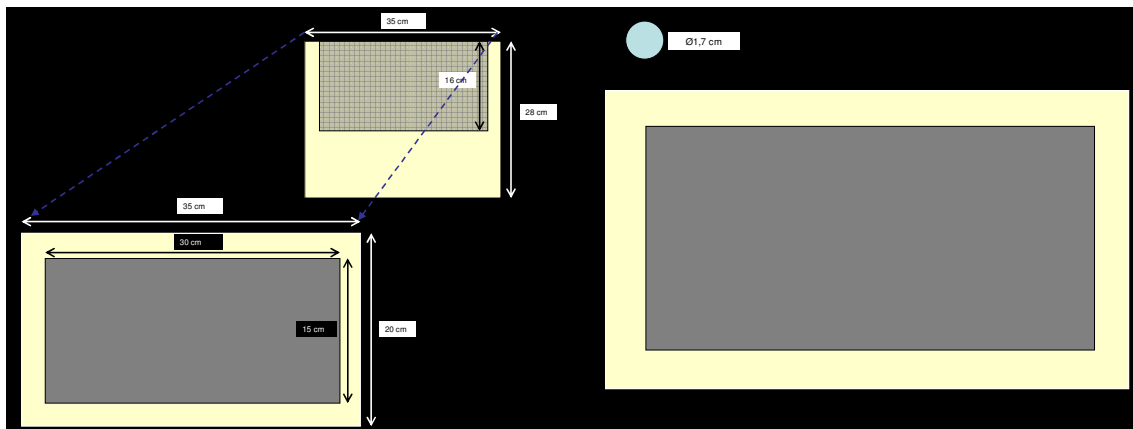

Fig 3.2.2.3 and 3.2.2.4. Evaluation of the space and of tubes dimension related to tank length, width, height and depth

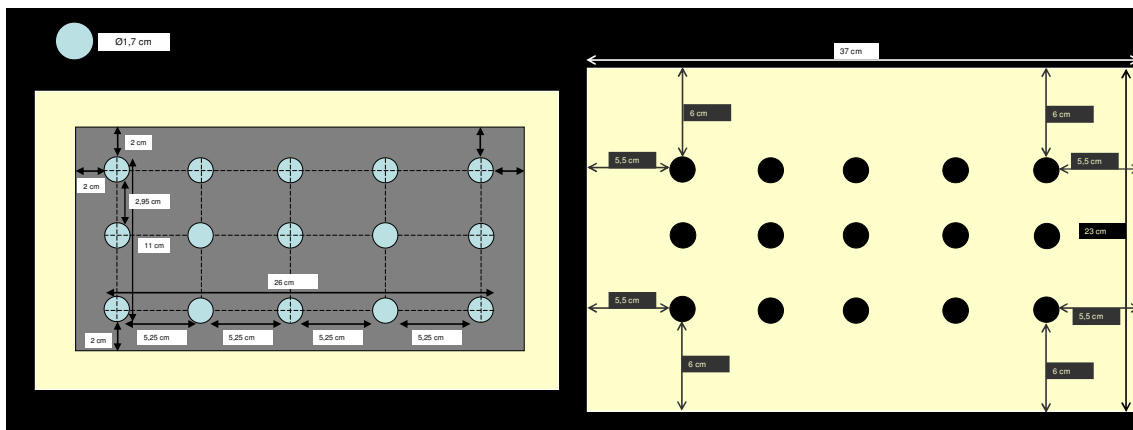

Fig 3.2.2.5 and 3.2.2.6. Planning of the grid, distribution of the holes and design of the upper structure. Evaluation of the edge in relation with the position of the support legs.

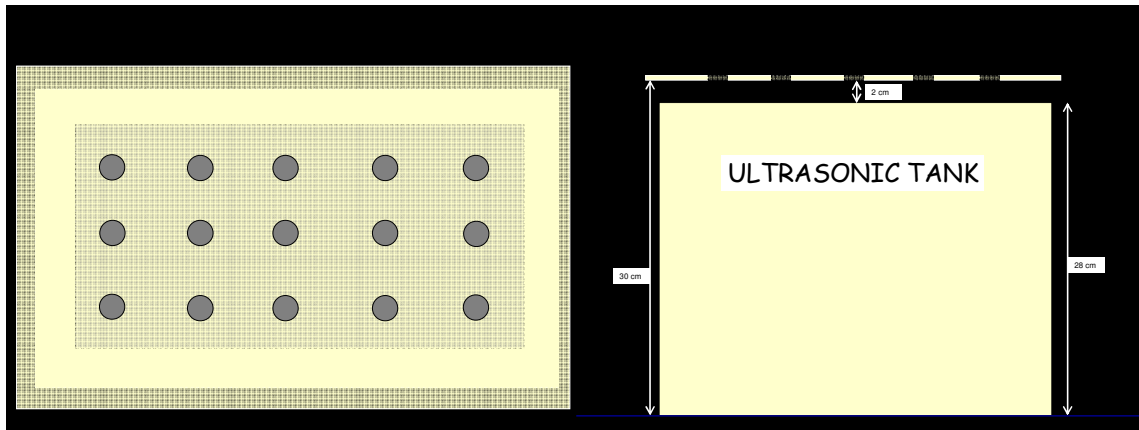

Fig 3.2.2.7 and 3.2.2.8. Evaluation of the tank height and of the distance between the grid and the bath.

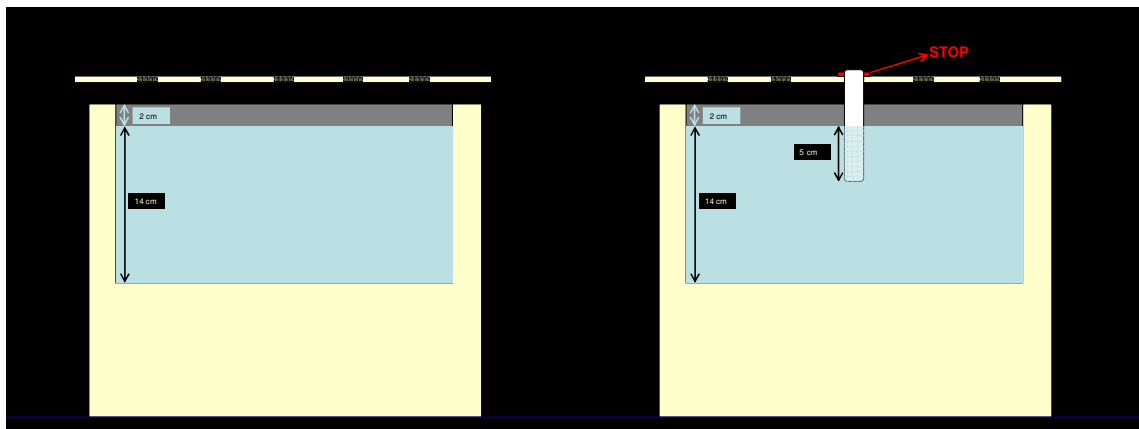

Fig 3.2.2.9 and 3.2.2.10. Simulation of water position in relation with the grid and of tube insertion.

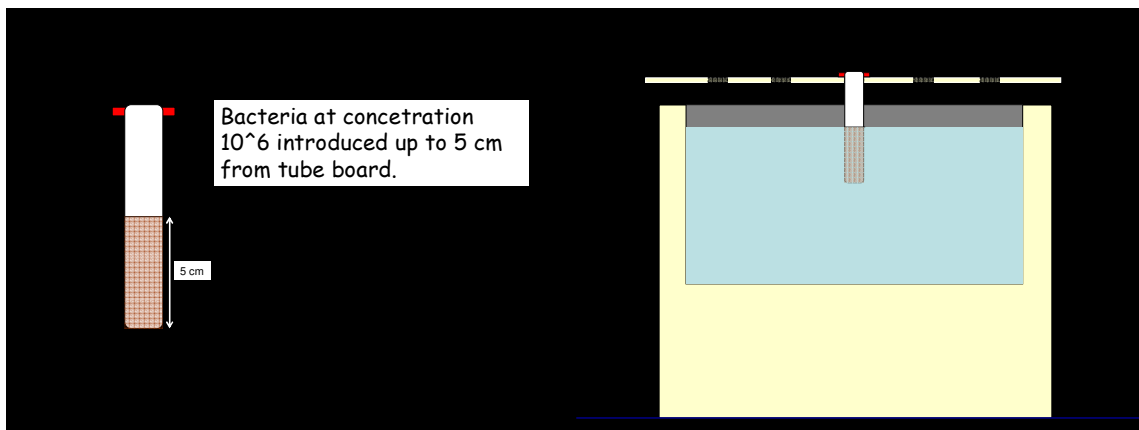

Fig 3.2.2.11 and 3.2.2.12. Simulation of medium position into the tubes and of mutual position of the level of the culture medium compared to the level of the water in the tank



Fig 3.2.2.13. Work completed. The creation of the grid was made at the DIGEP workshop of the Polytechnic of Turin.

3.2.3. Hydrophone calibration

An hydrophone from INRIM was chosen to measure the acoustic pressure developed by ultrasound into the ultrasonic bath (**Fig 3.2.3.1**). To realize the calibration of this instruments, for the frequencies that will be used for the study, the hydrophone has been brought to the Rome CNR.

At the department of acoustic of the Rome CNR the test instrument was compared with a standard for the frequencies under 100 kHz. Both the hydrophones (test and standard) were put at the same distance from a transducer that produced an acoustic wave at the frequencies choices (**Fig 3.2.3.2-3.2.3.5**). The calibration was realised with four measures executed in two consecutive days (in the morning and in the afternoon for each day). As result of the calibration process four values expressed in decibel Sound Pressure Level (dB_{SPL}), for each frequency that will be used, were obtained (**Table 3.2.3.1**). After this phase, the values of sensitivity will be used to calculate the uncertainty of the instrument for each frequency and to calculate the acoustic pressure.



Fig 3.2.3.1. Hydrophone used for this work (from Acoustic Department of INRIM)

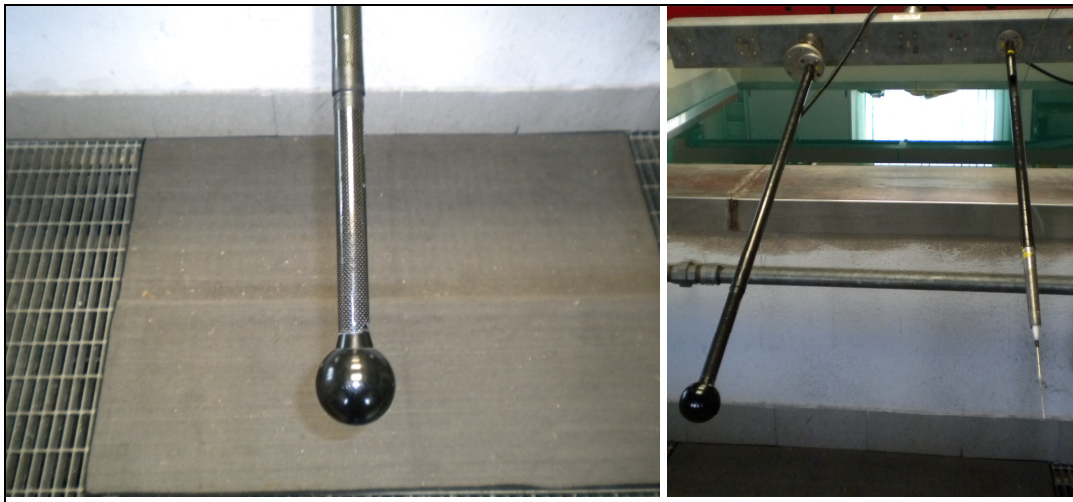

Fig 3.2.3.2 and 3.2.3.3. The transducer and the position of the hydrophone before of the immersion underwater.

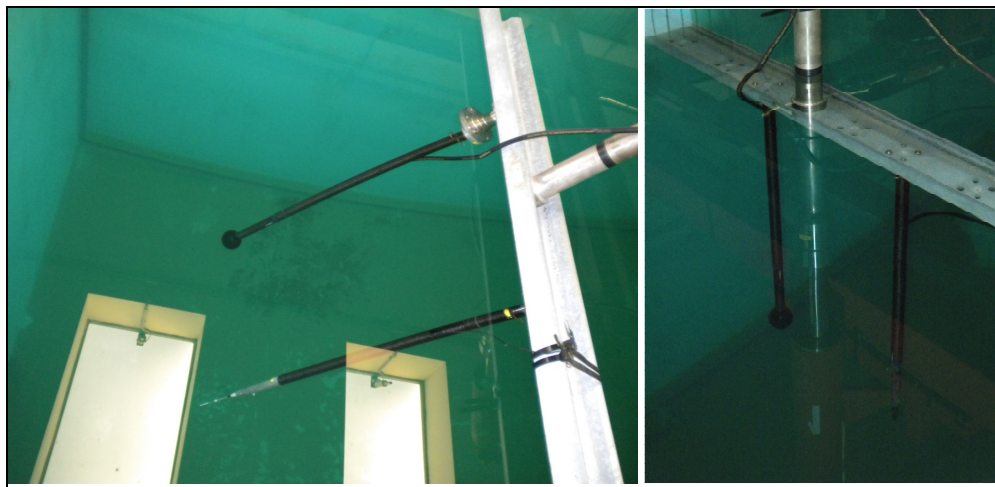

Fig 3.2.3.4. and 3.2.3.5. Ultrasound emission with the test instrument and with the standard.

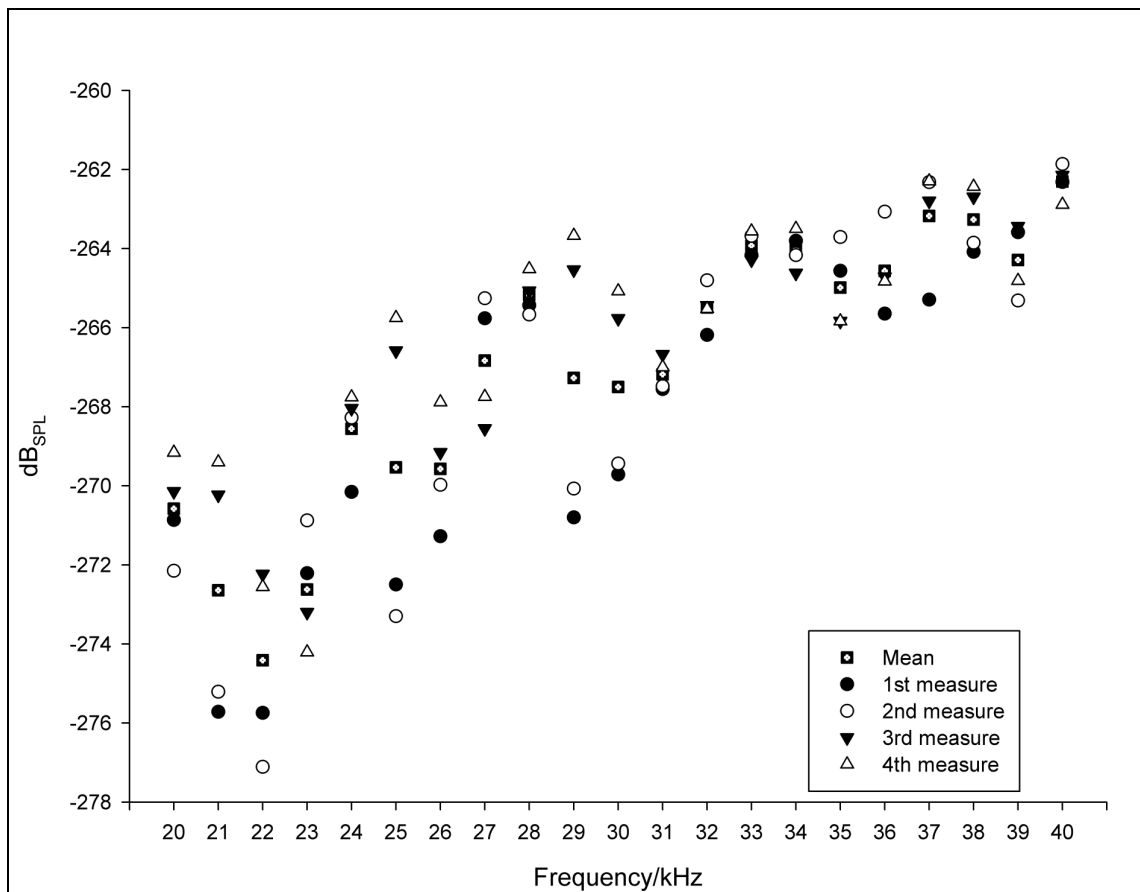

Fig 3.2.3.6. Results of the calibration with the value expressed in dB_{SPL} (decibel Sound Pressure Level) as value of sensitivity.

3.2.4. Ultrasonic transparency of sonication tubes exposed to various frequencies: a metrological evaluation of modifications and uncertainty of acoustic pressures.

3.2.4.1. Principle

To study US activity on microorganism the simpler method is to expose prokaryotic cells to the ultrasonic wave immersed into a liquid medium into a sonication tank. To avoid a contamination of the generator there is the need to use a sonication tube immersed into the medium where will be suspended microorganisms. The sonication will be performed into the tube without alteration of disinfected condition of the liquid medium into the tank [30].

The effect of US on prokaryotic cells changes among microorganisms, at the same time AP shows an high variability linked to sonication tube position, kind of liquid medium and material and form of sonication tube; therefore the development of an *in vitro* condition is fundamental to perform tests with a good rate of reproducibility and a value of uncertainty as low as possible.

For the analysis, three different kinds of tubes housing the hydrophone were chosen (Fig 3.2.4.1), the case in which no tube is used being denoted by P0:

P1: glass tube with hemispherical bottom;

P2: plexiglass tube with hemispherical bottom;

P3: plexiglass tube with taper bottom.

In order to find out which sonication tube exhibits better transparency to ultrasonic waves, the three kinds of tubes were tested, exposed to different frequencies (from 20 to 40 kHz) without variations of power (30 W) and placed always in the same location and depth, compared to AP measured in absence of any tube. Using a platform build specifically for this experiment was possible to obtain tests with high repeatability reproducibility and, especially, comparability.

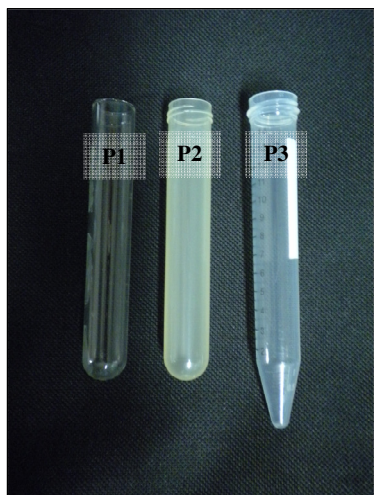

Fig 3.2.4.1. Tested tubes

The platform was a simple tripod with, at the top, a grid for the placement of the tubes. Tripod and grid were separable so that is possible to add water in the tank without remove the tripod. When the grid was put on its support the position is related to three centering so that, as long as the tripod was not moved, the position of the tubes in the grid will always be orthogonally the same. The depth of immersion of the tubes was instead made repeatable by a fixed stop on the same tube that rests on the grid (Fig 3.2.4.2).

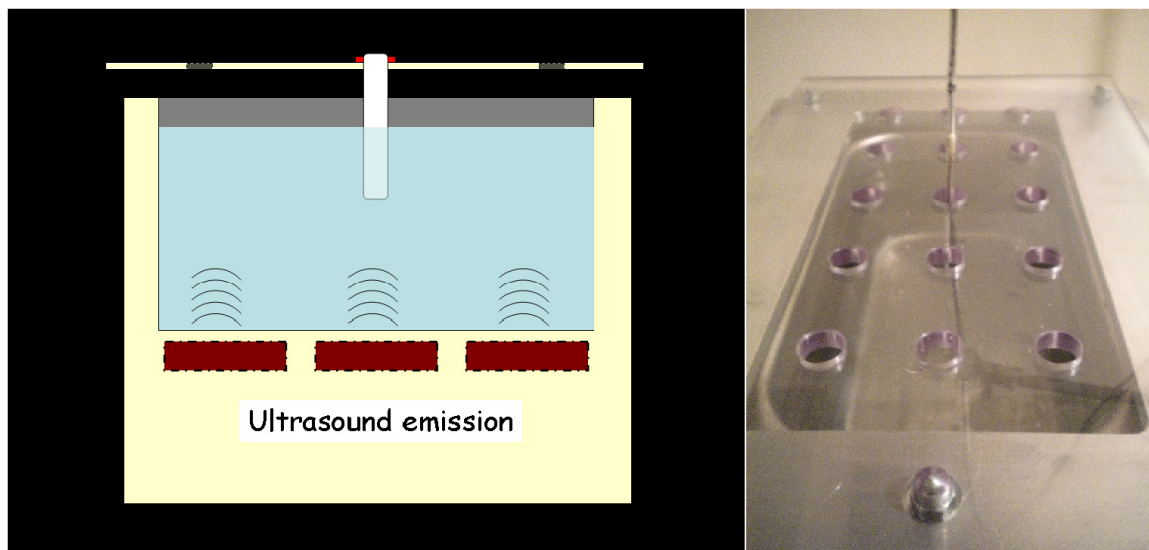

Fig 3.2.4.2. Position of the tripod-grid and of the hydrophone during the measures

AP measurements were performed using a 3 mm OD piezoelectric needle hydrophone equipped with a glass coating, previously calibrated in the working frequency range (as shown in Fig. 3.2.3.6.) at the *O. Corbino Institute* in Rome. Table 3.2.4.1. displays the mean values of sensitivity, expressed as decibel Sound Pressure Level (dB_{SPL}) and as microvolt per pascal, and the relevant uncertainty intervals for each frequency at 95% confidence level.

Frequency/kHz	Sensitivity/ dB_{SPL}			Sensitivity/ $(\mu\text{V}/\text{Pa})$		
	<i>M</i>	<i>L</i>	<i>U</i>	<i>m</i>	<i>L</i>	<i>U</i>
20	-270,6	-272,6	-268,6	$2,96 \cdot 10^{-2}$	$2,35 \cdot 10^{-2}$	$3,73 \cdot 10^{-2}$
21	-272,6	-277,9	-267,4	$2,33 \cdot 10^{-2}$	$1,28 \cdot 10^{-2}$	$4,26 \cdot 10^{-2}$
22	-274,4	-278,2	-270,6	$1,90 \cdot 10^{-2}$	$1,23 \cdot 10^{-2}$	$2,95 \cdot 10^{-2}$
23	-272,6	-274,9	-270,4	$2,34 \cdot 10^{-2}$	$1,80 \cdot 10^{-2}$	$3,03 \cdot 10^{-2}$
24	-268,6	-270,3	-266,8	$3,73 \cdot 10^{-2}$	$3,06 \cdot 10^{-2}$	$4,55 \cdot 10^{-2}$
25	-269,5	-275,8	-263,3	$3,34 \cdot 10^{-2}$	$1,63 \cdot 10^{-2}$	$6,83 \cdot 10^{-2}$
26	-269,6	-271,8	-267,3	$3,32 \cdot 10^{-2}$	$2,56 \cdot 10^{-2}$	$4,31 \cdot 10^{-2}$
27	-266,8	-269,3	-264,3	$4,55 \cdot 10^{-2}$	$3,41 \cdot 10^{-2}$	$6,07 \cdot 10^{-2}$
28	-265,2	-266,0	-264,4	$5,51 \cdot 10^{-2}$	$5,03 \cdot 10^{-2}$	$6,04 \cdot 10^{-2}$
29	-267,3	-273,1	-261,4	$4,33 \cdot 10^{-2}$	$2,20 \cdot 10^{-2}$	$8,50 \cdot 10^{-2}$
30	-267,5	-271,3	-263,7	$4,22 \cdot 10^{-2}$	$2,71 \cdot 10^{-2}$	$6,57 \cdot 10^{-2}$
31	-267,2	-267,8	-266,5	$4,38 \cdot 10^{-2}$	$4,06 \cdot 10^{-2}$	$4,72 \cdot 10^{-2}$
32	-265,5	-266,4	-264,6	$5,32 \cdot 10^{-2}$	$4,79 \cdot 10^{-2}$	$5,89 \cdot 10^{-2}$
33	-263,9	-264,5	-263,4	$6,36 \cdot 10^{-2}$	$5,96 \cdot 10^{-2}$	$6,79 \cdot 10^{-2}$
34	-264,0	-264,8	-263,3	$6,29 \cdot 10^{-2}$	$5,76 \cdot 10^{-2}$	$6,88 \cdot 10^{-2}$
35	-265,0	-266,6	-263,3	$5,63 \cdot 10^{-2}$	$4,65 \cdot 10^{-2}$	$6,82 \cdot 10^{-2}$
36	-264,6	-266,3	-262,8	$5,91 \cdot 10^{-2}$	$4,85 \cdot 10^{-2}$	$7,21 \cdot 10^{-2}$
37	-263,2	-265,5	-260,9	$6,94 \cdot 10^{-2}$	$5,34 \cdot 10^{-2}$	$9,01 \cdot 10^{-2}$
38	-263,3	-264,6	-262,0	$6,86 \cdot 10^{-2}$	$5,90 \cdot 10^{-2}$	$7,98 \cdot 10^{-2}$
39	-264,3	-265,8	-262,8	$6,10 \cdot 10^{-2}$	$5,15 \cdot 10^{-2}$	$7,22 \cdot 10^{-2}$
40	-262,3	-263,0	-261,6	$7,67 \cdot 10^{-2}$	$7,09 \cdot 10^{-2}$	$8,30 \cdot 10^{-2}$

Tab 3.2.4.1. Uncertainty in hydrophone calibration. Mean values *m* and limits *L* and *U* of 95% confidence intervals (uncertainty intervals) of sensitivity, expressed as decibel Sound Pressure Level (dB_{SPL}) and as microvolt per pascal, at explored frequencies.

The Sound Pressure Level, or sound level L_p is a logarithmic measure of the effective sound pressure p relative to a reference sound pressure p_0 . i.e.

$L_p = 20 \log_{10} \left(\frac{p}{p_0} \right)$	(1)
---	-----

From the sound levels L_p , it is possible to determine the sensitivity of hydrophone expressed as microvolt per pascal at each frequency, which is equal to

$$10^{\frac{L_p}{20}} \frac{\text{V}}{\mu\text{Pa}} = 10^{12} \cdot 10^{\frac{L_p}{20}} \frac{\mu\text{V}}{\text{Pa}} \quad (2)$$

Three preliminary measurement sessions, without a tube, with five replications each were performed for each frequency. Therefore, a total of 15 measurements were performed for each frequency. Outputs are given in microvolt, then, according to sensitivities shown in Table 3.2.4.1, values of AP expressed in pascal are derived. Table 3.2.4.2 shows mean values and uncertainty intervals (95% confidence level) of AP for each frequency. Expanded uncertainty of AP takes into account the resolution and the reproducibility relevant to the output and the calibration uncertainty relevant to the sensitivity for each frequency.

Frequency/kHz	AP/kPa		
	<i>m</i>	<i>L</i>	<i>U</i>
20	2,3	1,3	3,4
21	5,1	1,9	8,3
22	6,4	3,2	9,7
23	6,7	0,0*	14,3
24	2,8	1,1	4,5
25	1,8	0,6	2,9
26	3,8	0,0*	8,7
27	2,0	0,0*	4,7
28	2,1	1,3	3,0
29	1,5	0,0*	3,3
30	3,0	0,4	5,6
31	5,4	0,4	10,5
32	2,9	0,1	5,7
33	3,2	0,1	6,3
34	3,6	0,8	6,5
35	2,5	1,0	3,9
36	2,1	0,8	3,4
37	2,2	0,8	3,5
38	4,8	3,4	6,1
39	5,2	2,4	8,0
40	3,7	0,0*	7,9

Tab 3.2.4.2. Mean values *m* and limits *L* and *U* of 95% confidence intervals (uncertainty intervals) of AP.

(*related to a negative value, calculated analytically, without physical significance.)

Table 3.2.4.3 shows, as an example, the uncertainty budget relevant to the frequency 20 kHz. The mathematical model considered is

$$AP = \frac{output}{10^{12} \cdot 10^{\frac{L_p}{20}}} \cdot 10^{-3} \quad (3)$$

where the *output* is expressed in microvolt, L_p in decibel Sound Pressure Level and AP in kilopascal. The resolution of the output is 1 μV , while the reproducibility, i.e. the standard deviation of the 15 measurements, is 14 μV . The calibration uncertainty relevant to the sensitivity is 2 dB_{SPL} (see Table 3.2.4.1), which corresponds to a standard uncertainty equal to 0,63 dB_{SPL} (assuming 95% confidence level and 3 degrees of freedom). Further details on methods for uncertainty evaluation are given in [13].

x_j		Note	s_j	a_j	k_{aj}	$u^2(x_j)$	c_j	$u_j^2(y)$	ν_j	$u_j^4(y)/\nu_j$
Symbol	Value									
<i>output</i>	69	Res		0,5	3	$8,3 \cdot 10^{-2}$	$3,4 \cdot 10^{-2}$	$9,5 \cdot 10^{-5}$	1	$9,1 \cdot 10^{-9}$
		Repr,	14,0			$2,0 \cdot 10^2$	$3,4 \cdot 10^{-2}$	$2,2 \cdot 10^{-1}$	14	$3,6 \cdot 10^{-3}$
L_p	-270,6	Bias	0,63			$4,0 \cdot 10^{-1}$	$-2,7 \cdot 10^{-1}$	$2,8 \cdot 10^{-2}$	3	$2,6 \cdot 10^{-4}$
AP	2,3	Variance of y , $u^2(y)$						$2,5 \cdot 10^{-1}$	Σ	$3,9 \cdot 10^{-3}$
Standard deviation of y , $u(y)$								$5,0 \cdot 10^{-1}$	ν_y	16
Confidence level								95%		
Coverage factor (Student's t)								2,1		
Expanded uncertainty, $U(y)$								1,1		

Tab 3.2.4.3. Uncertainty table, showing main contributions and resulting expanded uncertainty.

With reference to Table 3.2.4.2, frequencies which correspond to lowest values of uncertainty of AP have been chosen. Figure 3.2.4.3 shows AP uncertainty intervals for the chosen frequencies.

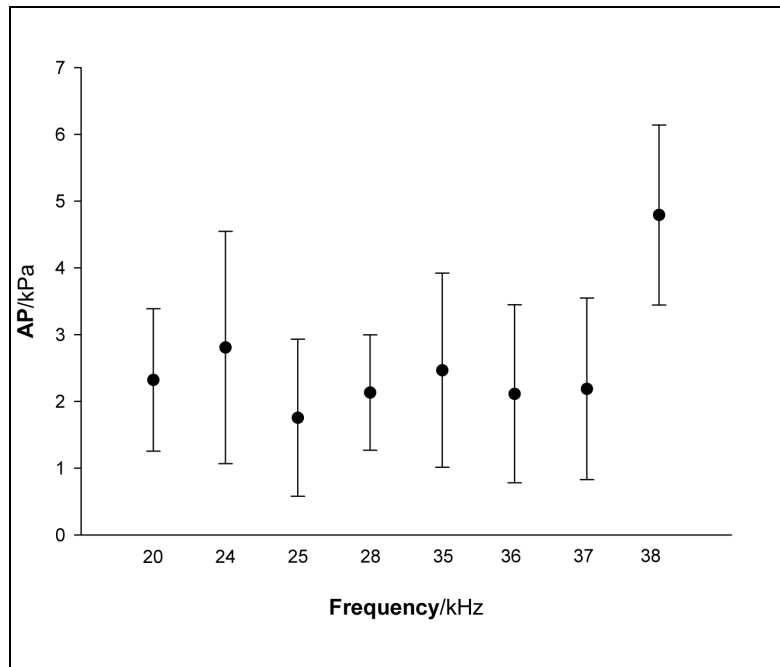

Fig 3.2.4.3. Acoustic pressure measures for each frequency

Three measurement sessions, with the three different types of tube, with five replications each were performed for the chosen frequencies. Uncertainties on AP were calculated in the same way as the preliminary session without the tube. The results are given in Fig. 3.2.4.4 (a-g).

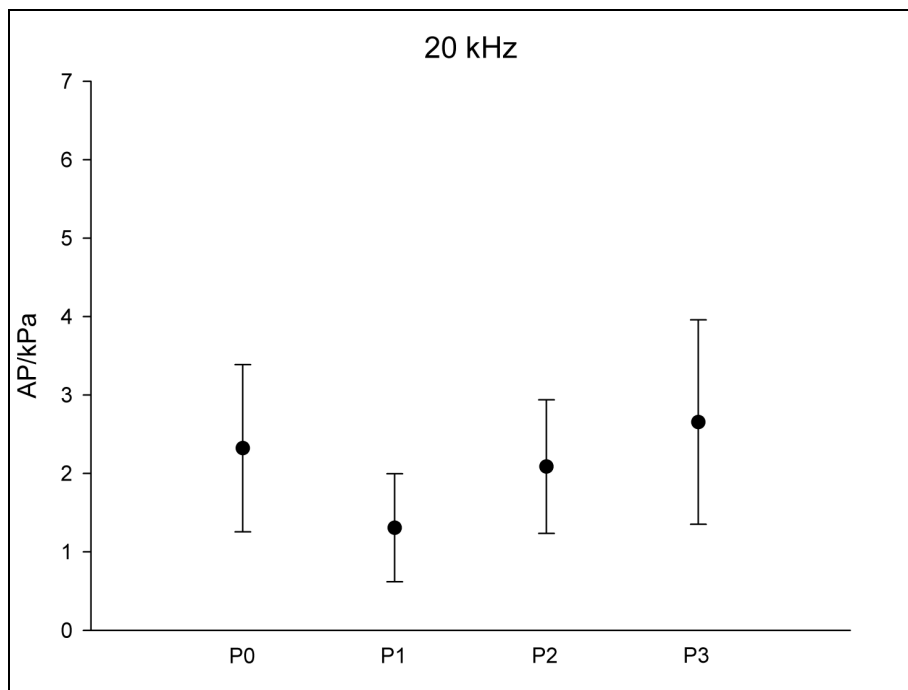

Fig 3.2.4.4.a. Acoustic pressure confrontation between P0 and tested tubes.

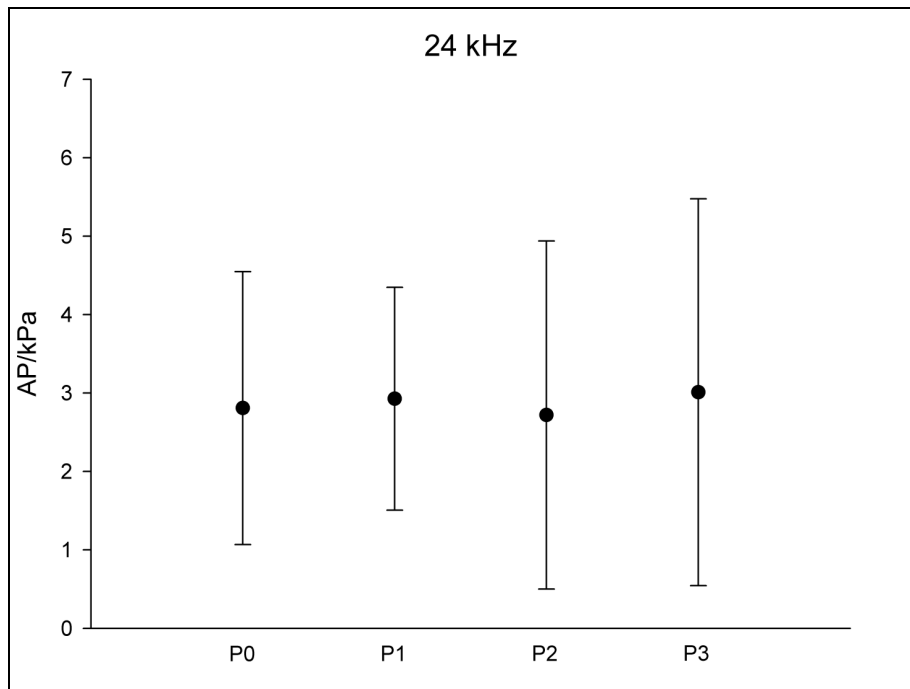

Fig 3.2.4.4.b. Acoustic pressure confrontation between P0 and tested tubes.

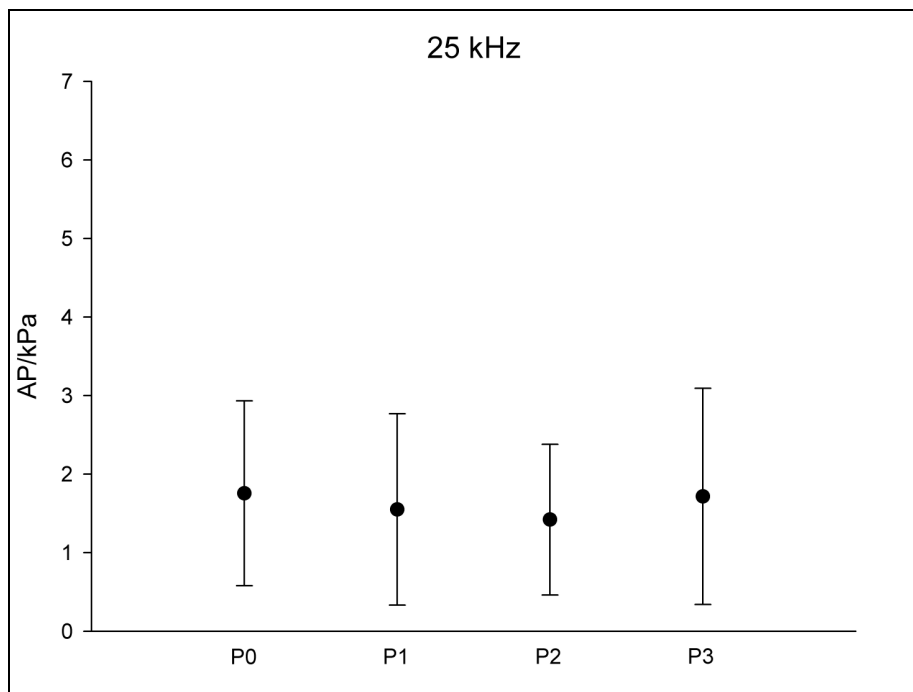

Fig 3.2.4.4.c. Acoustic pressure confrontation between P0 and tested tubes.

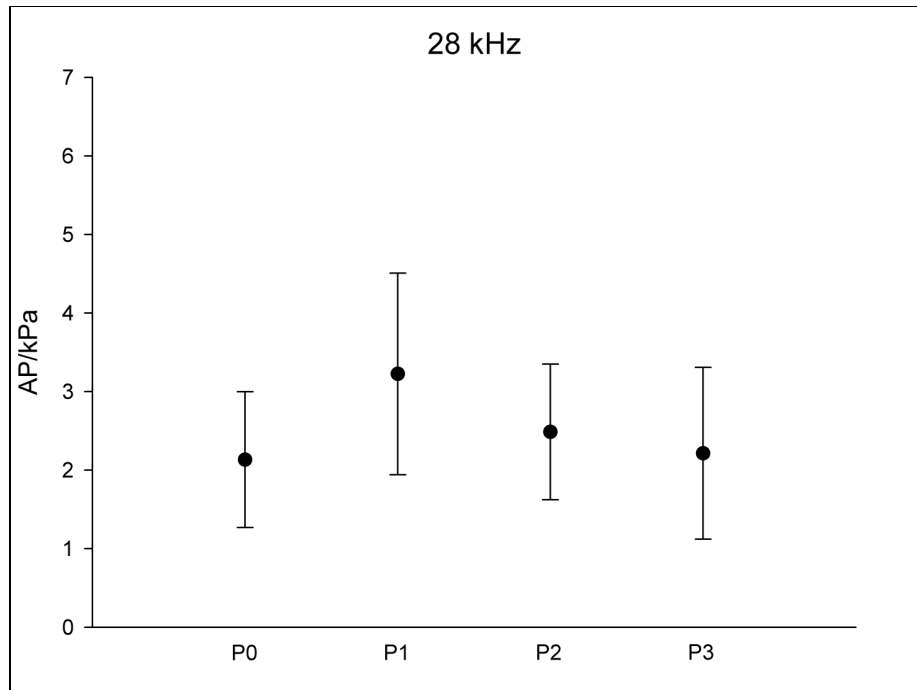

Fig 3.2.4.4.d. Acoustic pressure confrontation between P0 and tested tubes.

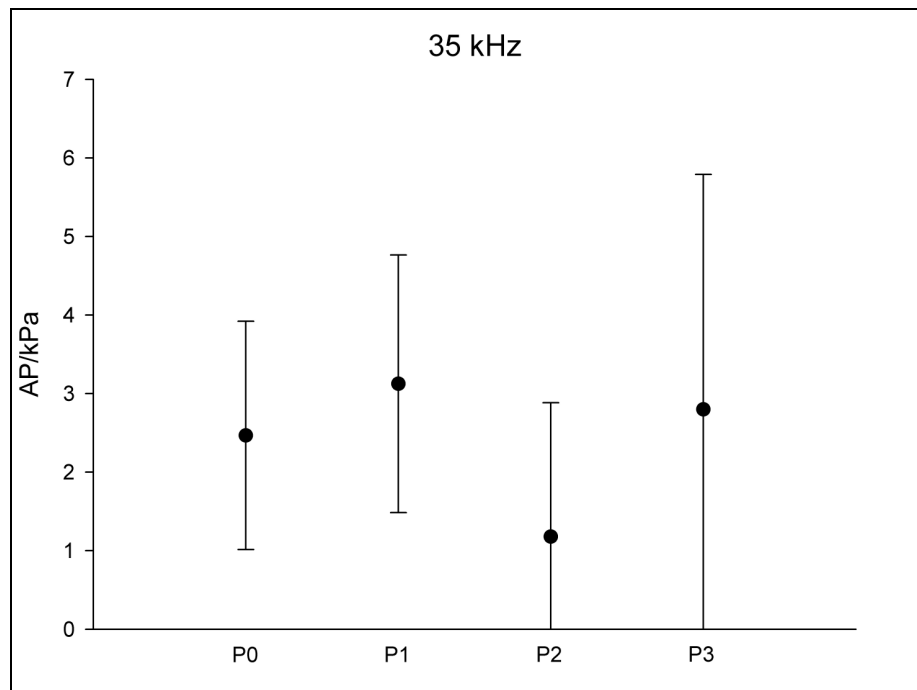

Fig 3.2.4.4.e. Acoustic pressure confrontation between P0 and tested tubes.

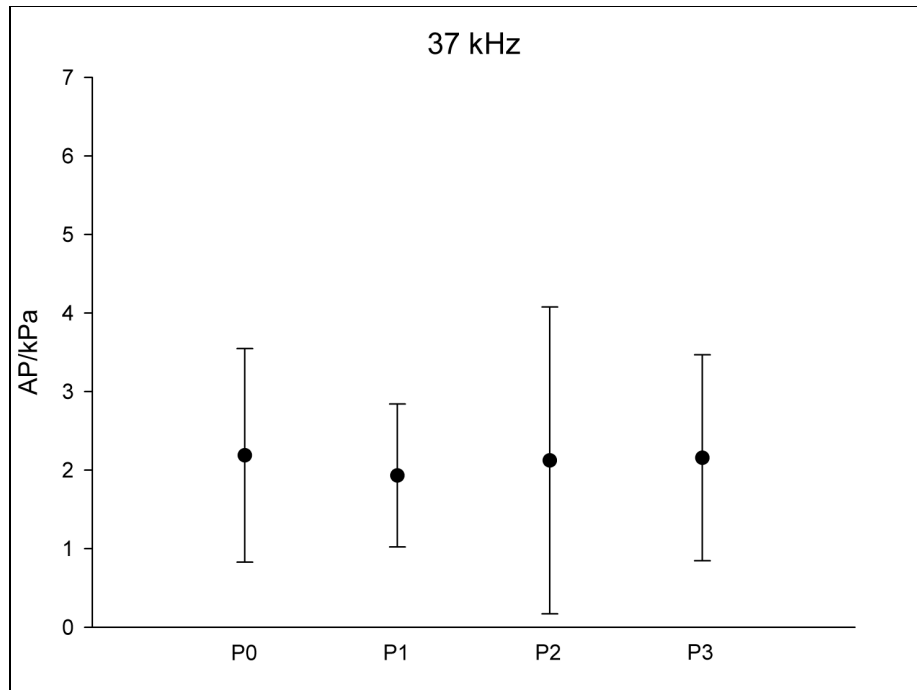

Fig 3.2.4.4.f. Acoustic pressure confrontation between P0 and tested tubes.

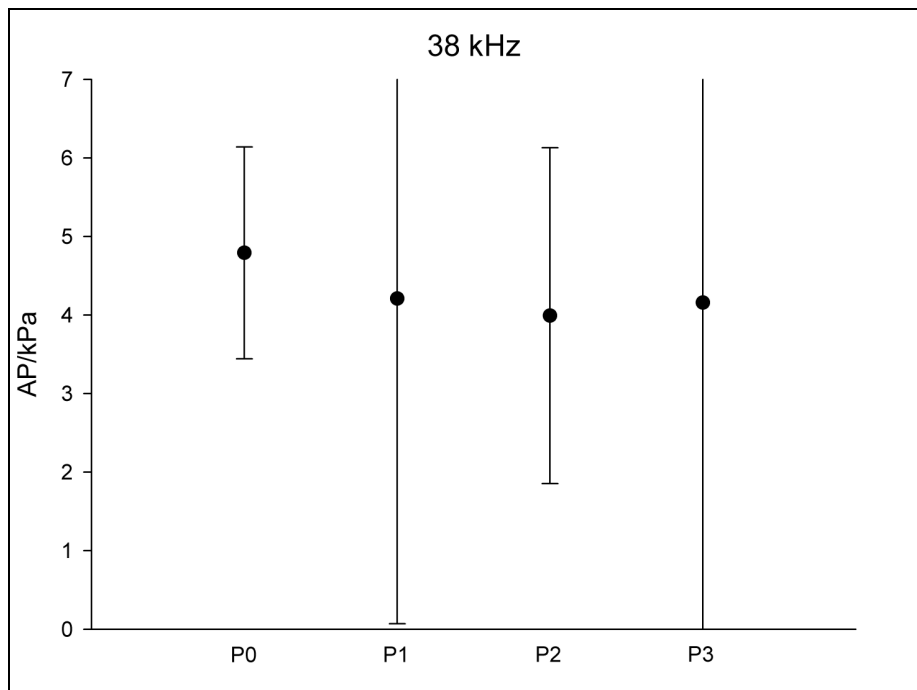

Fig 3.2.4.4.g. Acoustic pressure confrontation between P0 and tested tubes.

3.2.4.2. Discussion and conclusion

The analysis of US activity on bacteria species is always related to a lot of factors that could make high variation in results as sound pressure, environmental changes, tube position, cavitation activity. In this work is tested a method to be able to realize a correlation between exposition to an acoustic pressure derived from an ultrasonic device with exclusion of other factors.

Cavitation effect is the most variable factor during US emission and, specifically on microbial species, could product many different and often contradictory results. Using low frequency and intensity is possible to avoid bubbles formation, in addition tubes made able to stop shock waves before that they could reach the cells. The platform build specifically for this experiment made possible to analyze tubes always in the same position obtaining tests with high repeatability reproducibility and, especially, comparability.

From the results obtained is possible to determine how both form as material of tubes determined an influence to the acoustic pressure, at the same time with the variation of the frequency was possible to highlight a different behavior related principally to the material. In conclusion the method used in this work made possible to identify which kind of tube is the best to perform analyze about acoustic pressure effect of US on biological tissue or microorganism when is necessary to avoid cavitation effect.

3.2.5. Conclusions (From step 1 to step 3)

At the end of the first phase seven frequencies was chosen based on the lower uncertainty values obtained by the analysis (Table 3.2.5.1).

Frequency/kHz	Acoustic Pressure/kPa	Uncertainty
20	1,3-3,4	46%
24	1,1-4,5	62%
25	0,6-2,5	67%
28	1,3-3,0	40%
35	1,0-3,9	59%
37	0,8-3,5	62%
38	3,4-6,1	28%

Table 3.2.5.1. Frequencies chosen

A tube, of specific form and material, was determined as the better one to realise biological analysis for each frequency. The variables used to choose the tubes were the transparency to the acoustic wave and, in case of similar transparency between more tubes, the lower uncertainty.



The transparency was evaluated finding the tube where was possible to detect the acoustic pressure more similar to that detected without tubes (Table 3.2.5.2).

Frequency/kHz	Tube chosen	Acoustic Pressure/kPa		Uncertainty	
		P0	Tube	P0	Tube
20	P2 (Plexiglass)	1,3-3,4	1,2-2,9	46%	41%
24	P1 (Glass)	1,1-4,5	1,5-4,3	62%	49%
25	P2 (Plexiglass)	0,6-2,5	0,5-2,4	67%	68%
28	P2 (Plexiglass)	1,3-3,0	1,6-3,3	40%	35%
35	P1 (Glass)	1,0-3,9	1,5-4,8	59%	52%
37	P1 (Glass)	0,8-3,5	1,0-2,8	62%	47%
38	P2 (Plexiglass)	3,4-6,1	1,9-6,1	28%	54%

Table 3.2.5.2. Tubes chosen for each frequency

3.3. Step 2

1. Metrological evaluation of the method to analyse bacteria viability and biofilm development (microtiter plate assay)
2. Eventual method correction
3. Analysis and evaluation of base values of bacterial growth

3.3.1. Description of the method

Spectrophotometry, a technique based on the interaction of light and matter, investigates the absorption of different substances within the wavelength range 190-780 nm. In this range the absorption of the electromagnetic radiation is caused by the excitation of the bonding and non-bonding electrons of the ions or molecules. Spectrophotometry is used for both qualitative and quantitative investigations of samples. The wavelength at the maximum of the absorption band is related to the amount of the species absorbing the light.

Spectroscopic techniques are based on the exchange of energy that occurs between radiant energy and matter. In particular, the absorption spectrophotometry is concerned within the phenomena of absorption of the electromagnetic radiation in the region of the electromagnetic spectrum belonging to the visible range (350-700 nm) and near ultraviolet (200-350 nm). The absorption of these types of radiation on the part of the molecules is capable of producing the energy transitions of the outer electrons of the molecules, as well as those engaged in a bond as those not engaged. To perform qualitative analyzes are used polychromatic rays in continuous spectrum, then separated by monochromators in the various components (monochromatic radiations), in practice the individual monochromatic radiations of that radius are made to pass,

one at a time, through the substance under examination, which will absorb in a different way, ie with different intensity, the different radiation. Bringing the values plotted on a graph wavelength-absorption, the absorption spectrum of the substance to be tested is obtained. Since each substance has its absorption spectrum, the examination of such spectra allows to identify a substance (for direct comparison with known samples or via databases of spectra) or to control the degree of purity. To perform quantitative analyzes using monochromatic rays, ie constituted by radiation of a single frequency. In practice, because of the difficulties of having rays with this property, radiation beams comprising a very narrow band of the spectrum, ie monochromatic beams, are used.

The quantitative determinations are based on the fact that, when a radiation passes through a solution, is absorbed more or less intensely depending on the concentration, in other words the absorption depends on the concentration. Disposing of instruments capable of measuring the absorption is possible to determine the concentration of the solution. In fact, if it is passed through a solution to unknown concentration, a monochromatic radiation (ie in a specific λ) and of intensity I_0 , beyond the solution will be found a radiation intensity equal to I , which will be less than I_0 if a part of the radiation is absorbed by the solution itself, or equal to I_0 if there was no absorption.

3.3.2. Microtiter spectrophotometric biofilm production assay analyzed with metrological methods and uncertainty evaluation.

3.3.2.1. Introduction

Microorganisms can live in one of two possible states: sessile or planktonic. The sessile phenotype results from attachment and usually develops into a biofilm that has unique characteristics [20]. The biofilm is commonly defined as “*an assemblage of microbial cells that is irreversibly associated (not removed by gentle rinsing) with a surface and enclosed in a matrix of primarily polysaccharide material.*” [18]. This definition is not entirely satisfactory, since a biofilm may be not only an aggregation of bacteria but also, as recently defined, “*a microbially derived sessile community characterized by cells that are irreversibly attached to a substratum or interface or to each other, are embedded in a matrix of extracellular polymeric substances that they have produced, and exhibit an altered phenotype with respect to growth rate and gene transcription*” [19]. A biofilm is characterized by the adhesion of the cells to a non exfoliative surface, immersed in an aqueous medium and/or on other bacteria cells. The mechanism of attachment may be explained in terms of several factors, namely substratum effects, conditioning



films forming on the substratum, hydrodynamics of the aqueous medium, characteristics of the medium, and various properties of the cell surface [18]. The association between biofilms and diseases is not always easy, because the biofilm infection cannot be proved according to Koch's postulates [20]. Infections strongly linked to a biofilm development, such as periodontal disease, endodontic infections, candidiasis, valve endocarditis, cystic fibrosis, urinary catheter cystitis, have all in common the resistance to non-invasive therapies (as drug therapy). The study of this microbial state is today indispensable to obtain a diagnosis and to decide an appropriate therapy [20, 26, 29, 88-90]. Biofilm infections are often originated by nosocomial infections linked to poorly sterilized surfaces of medical devices, entailing critical consequences for involved patients [20, 91, 92]. Among the microbial species involved in biofilm infections are some microbes having a primary role or considered model organisms for in vitro analysis, and therefore are among the most studied microbial species (spp) both in vivo and in vitro. Eight of these microbes, namely *Escherichia coli* (*Ec*), *Pseudomonas aeruginosa* (*Pa*), *Klebsiella pneumonia* (*Kp*), *Bacillus subtilis* (*Bs*), *Enterococcus faecalis* (*Ef*), *Staphylococcus aureus* (*Sa*), *Candida albicans* (*Ca*) and *Aggregatibacter actinomycetemcomitans* (*Aa*) [20, 88, 91-97] (**Table 3.3.2.1**), were considered in this study.

The development of a reproducible, specific and sensitive biofilm measurement method is today necessary in both medical and industrial fields. Among the various methods, indirect and direct applications may be distinguished. Indirect applications, such as standard plate counts, roll techniques, and sonication, allow the operator to obtain a quantification analysis of the biofilm after a detaching action. Other indirect techniques, such as radiolabeled bacteria, enzyme-linked immunosorbent assay, biologic assays, stained bacterial films, and microtiter plate procedures, enable the observer to obtain a quantification evaluation of the biofilm by measuring some attribute for the attached organism [98]. While many works in literature found limits often linked to the indirect methods [98-100], the direct methods show a better performance in terms of biofilm assessment, offset however by greater difficulties associated with techniques and equipment which may not be readily available (laser-scanning confocal, transmission electron and scanning electron microscopes) [98].

An indirect method which showed a good level of reproducibility, specificity and sensitivity, along with substantial simplicity, is the microtiter or microplate spectrophotometric assay [98, 101-104]. This method, first described in 1977 [101] and modified and improved in 1998 and in 2002 [98], is highly adaptable to the type of organisms to be studied in various and different growing conditions, is used routinely [105, 106], and is nowadays considered as the gold standard for the indirect evaluation of biofilm [104].

Biofilm microbial species	Infection or disease	Nosocomial
<i>Escherichia coli (Ec)</i>	Biliary tract infection	NO
	Bacterial prostatitis	NO
	Orthopedic devices infection	YES
<i>Pseudomonas aeruginosa (Pa)</i>	Cystic fibrosis	NO
	Contact lens infection	YES
	Central venous catheters infection	YES
	Orthopedic devices infection	YES
<i>Klebsiella pneumonia (Kp)</i>	Urinary catheter cystitis	YES
	Central venous catheters infection	YES
<i>Bacillus subtilis (Bs)</i>	Model organism	-
<i>Enterococcus faecalis (Ef)</i>	Endodontic infection	NO
	Urinary catheter cystitis	YES
	Mechanical heart valves infection	YES
	Orthopedic devices infection	YES
	Intra-Uterin devices infection	YES
<i>Staphylococcus aureus (Sa)</i>	Arteriovenous shunts infection	YES
	Intra-Uterin devices infection	YES
	Pentile prostheses infection	YES
<i>Candida albicans (Ca)</i>	Candidiasis	NO
	Vaginitis	NO
	Peritoneal dialysis peritonitis	YES
	Vascular catheters infection	YES
	Joint prostheses infection	YES
	Central venous catheters infection	YES
<i>Aggregatibacter actinomycetemcomitans (Aa)</i>	Periodontal disease	NO
	Meningitis	NO
	Heart disease	NO

Tab 3.3.2.1. Main diseases related to bacterial spp examined. Nosocomial infections are identified.

This work is aimed at validation of the microtiter spectrophotometric biofilm production assay as a measurement tool using a metrological approach, exploiting statistical methods in order to perform an uncertainty evaluation [1].

3.3.2.2. Materials and methods

Culture preparation

The following species were used for this study:

1. Gram positive bacteria: *Staphylococcus aureus* ATCC 6538, *Enterococcus faecalis* ATCC 29212 [107], *Bacillus subtilis* (clinical strain) [90].



2. Gram negative bacteria: *Escherichia coli* ATCC 7075, *Pseudomonas aeruginosa* ATCC 27853, *Aggregatibacter actinomycetemcomitans* DSM 11123 (genotype JP2) (Deutsche Sammlung von Mikroorganismen und Zellkulturen GmbH, Braunschweig, Germany) [107], *Klebsiella pneumoniae* (clinical strain) [108].
3. Fungi: *Candida albicans* from oral clinical isolates. These specimens were plated in Sabouraud glucose agar for 48 hours at 35 °C (Microbiol, UTA, Cagliari, Italy). The colonies were identified with an API ID32C system (Biomerieux, St Louis, MO) and maintained at – 20 °C in skimmed milk (Oxoid, Basingstoke, UK) [107].

Before the application of the spectrophotometric assay method, the selected microorganisms were divided into three groups:

- i) strains of *Staphylococcus aureus*, *Enterococcus faecalis*, *Bacillus subtilis*, *Escherichia coli*, *Pseudomonas aeruginosa* and *Klebsiella pneumoniae* were incubated in Müller Hinton agar, (MH Microbiol, UTA, Cagliari Italy) at 37 °C for 24 hours,
- ii) one strain of *Candida albicans* was cultured in Sabouraud glucose agar at 37 °C for 48 hours,
- iii) one strain of *Aggregatibacter actinomycetemcomitans* was incubated in Anaerobic difficile agar (Microbiol, UTA, Cagliari, Italy) at 37 °C for 24 hours with a CO₂ concentration of 5% [109].

After the incubation, group (i) was suspended in Müller Hinton broth (MH), group (ii) in Sabouraud glucose broth (SAB) and group (iii) in vials containing Schaedler Broth (SH) [109]. Bacterial suspensions were performed to obtain a concentration with a turbidity equivalent to the no. 3 McFarland standard (about 10⁸ CFU/ml), then diluted to 1/100 (obtaining a 10⁶ CFU/ml) using a spectrophotometer at 620 nm (DMS100s, Varian, New Hampshire, USA) [29].

Microtiter plate biofilm production assay

The protocol described in 2007 [104] was applied to perform the biofilm analysis. During the application of the method, each step was numbered and analyzed, reading at 620 nm with a microtiter plate reader (Microplate Reader TECAN SPECTRA II) for the metrological evaluation. To realize the colorimetric assay, 200 µl of each suspended strain, were added to six wells of a 96-well plate and incubated for 24 hours. After the incubation (STEP 1: initial condition) the medium was removed (STEP 2: pre-washing) and the microtiter plate wells were washed three times with 200 µl of PBS (0,1 M, pH 7,4) buffer using a multichannel pipette, and allowed to dry for 15 min (STEP 3: post-washing). The microtiter wells were stained with 200 µl of 0.4% crystal violet for 15 min at room temperature. The unbound crystal violet stain was removed and the wells were washed three times with 200 µl of PBS buffer (STEP 4: post-crystal

violet). The wells were air-dried for 15 min and the crystal violet in each well was solubilized by adding 200 μ l of 33% acetic acid (STEP 5: post-acetic acid). The biofilm value was represented by the analysis of the absorbance carried out with a spectrophotometer at 620 nm (SLT-Spectra II™, SLT Instruments, Germany) (Fig 3.3.2.1).

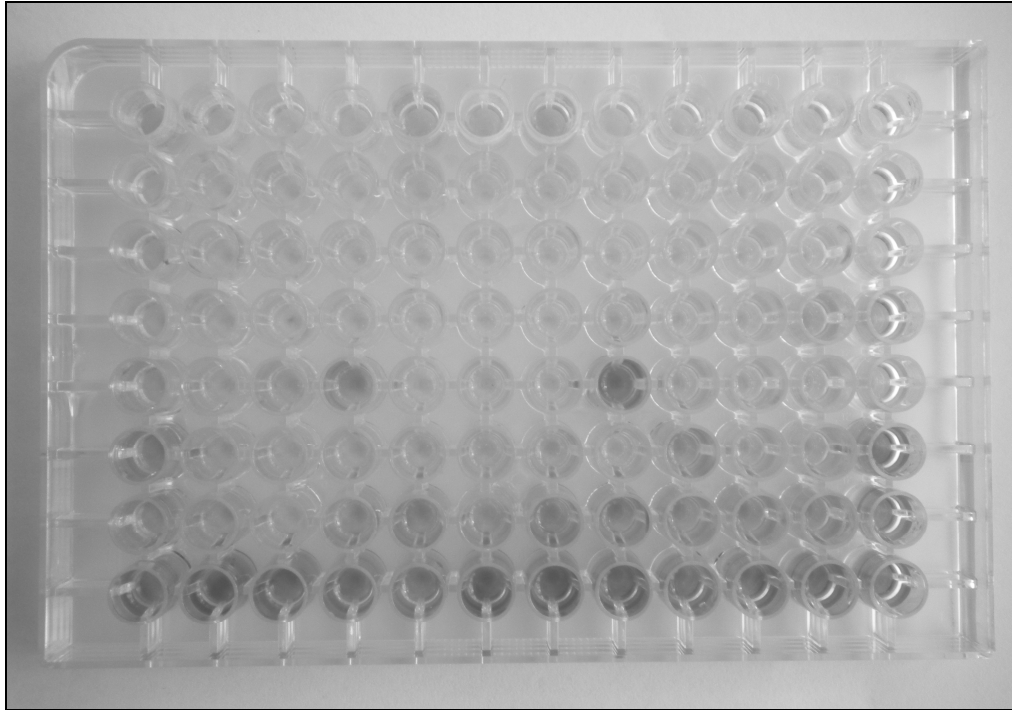

Fig 3.3.2.1. Microtiter spectrophotometric assay example: full colored plate with different levels of absorbance in each well which show different levels of biofilm development.

Step by step spectrophotometric measurement

During the colorimetric assay, the five critical steps previously described, i.e. STEP 1 to STEP 5, were identified. Each phase was analyzed through a spectrophotometric reading at 620 nm obtaining 240 measurements of absorbance. In STEP 1 the absorbance value of the bacteria planktonic growth after the incubation was obtained; it could be considered as the value representing the development of each microorganism in an aqueous medium before any manipulation. By STEP 2 the value that represents the turbidity of each well after the broth removal was obtained. STEP 3 determined the absorbance after the first washing phase. In STEP 4 the turbidity of the dried colored biofilm after washing and before suspension was analyzed. STEP 5 was the final phase of the microtiter plate biofilm production assay method; by this phase the turbidity of the colored biofilm suspended by acetic acid may be determined. Table 3.3.2.2 shows some descriptive statistics (mean and standard deviation) and values for each specie at each step, corrected subtracting a relevant *C*-value different for each broth (MH, SAB



or SH). Since negative values of absorbance are physically meaningless, such values were arbitrarily set equal to zero, enabling the evaluation of metrological characteristics using statistical methods.

	STEP 1 Initial condition			STEP 2 Pre-washing			STEP 3 Post-washing			STEP 4 Post-crystal violet			STEP 5 Post-acetic acid		
	Mean	St. Dev.	Corrected	Mean	St. Dev.	Corrected	Mean	St. Dev.	Corrected	Mean	St. Dev.	Corrected	Mean	St. Dev.	Corrected
<i>Kp (MH)</i>	1,381	0,07	1,282	0,134	0,04	0,102	0,093	0,07	0,000	0,087	0,02	0,022	0,273	0,05	0,174
<i>Bs (MH)</i>	0,739	0,07	0,639	0,339	0,12	0,307	0,093	0,06	0,000	0,073	0,07	0,009	0,123	0,03	0,025
<i>Sa (MH)</i>	0,549	0,08	0,449	0,136	0,02	0,104	0,103	0,07	0,008	0,094	0,05	0,030	0,158	0,05	0,060
<i>Pa (MH)</i>	0,933	0,06	0,833	0,113	0,02	0,082	0,113	0,05	0,018	0,109	0,07	0,045	0,138	0,03	0,039
<i>Ec (MH)</i>	0,991	0,04	0,892	0,100	0,02	0,068	0,122	0,04	0,026	0,103	0,08	0,039	0,108	0,03	0,009
<i>Ef (MH)</i>	0,149	0,05	0,049	0,073	0,01	0,041	0,105	0,07	0,009	0,070	0,02	0,006	0,127	0,03	0,029
<i>Ca (SAB)</i>	1,232	0,04	1,145	0,324	0,05	0,289	0,107	0,04	0,000	0,104	0,08	0,028	0,147	0,04	0,051
<i>Aa (SH)</i>	0,359	0,04	0,258	0,247	0,02	0,196	0,270	0,06	0,151	0,274	0,09	0,136	0,380	0,05	0,259
<i>C- (MH)</i>	0,100	0,01		0,032	0,00		0,095	0,04		0,064	0,03		0,099	0,01	
<i>C- (SAB)</i>	0,088	0,01		0,035	0,01		0,114	0,01		0,076	0,04		0,096	0,01	
<i>C- (SH)</i>	0,101	0,01		0,051	0,04		0,119	0,03		0,138	0,02		0,120	0,01	

Tab 3.3.2.2. Descriptive statistics and values for each specie at each step, corrected subtracting relevant C- value (negative values were arbitrarily set equal to zero).

Statistical analysis

An uncertainty evaluation of the whole process has been performed according to the GUM [1]. This may be properly organized in a tabular format (Table 3.3.2.3), referring to EA-4/02:1999 [110]. A minor modification was adopted by substituting the standard deviations with variances, in order to show the individual contribution to the variance of output quantity y [13, 111].

Symbol	x_j Value	Note	s_j	a_j	k_{a_j}	$u^2(x_j)$	c_j	$u_j^2(y)$	v_j	$u_j^2(y)/v_j$	
<i>x</i>	0,279	Res		5,0E-04	3	8,3E-08	1,0E+00	8,3E-08	100	6,9E-17	
		Repr,	4,4E-02			2,0E-03	1,0E+00	2,0E-03	100	3,9E-08	
<i>b</i>	0,089	Res		5,0E-04	3	8,3E-08	-1,0E+00	8,3E-08	100	6,9E-17	
		Repr,	4,4E-02			2,0E-03	-1,0E+00	2,0E-03	100	3,9E-08	
<i>y</i>	0,191	Variance of y, $u^2(y)$						3,9E-03	Σ		7,7E-08
		Standard deviation of y, $u(y)$							6,3E-02	v_y	200
		Confidence level							95%		
		Coverage factor (Student's t)								2,0	
		Expanded uncertainty, $U(y)$									1,2E-01

Tab 3.3.2.3. Uncertainty table

The considered mathematical model is:

$$y = x - b \quad (1)$$

where x is the general mean of the means of six replications of absorbance values considering all the microorganisms at each step, while b is the overall mean of the means of six replications of absorbance values considering all the C- values at each step. The value of y is $1,9 \cdot 10^{-1}$.

The resolution of the spectrophotometer is equal to $1 \cdot 10^{-3}$. The reproducibility, calculated as the standard deviation of biases from the means of six replications considering all the absorbance values at each step, was found equal to $4,4 \cdot 10^{-2}$. The resulting expanded uncertainty at 95% confidence level is $1,2 \cdot 10^{-1}$, i.e. relative expanded uncertainty of about 65%.

This value concerns the whole process, namely the 5 steps referred to above. To detect some possible criticalities of the method, linked to biological behavior or to practical implementation, a statistical comparison among the 5 steps was performed in terms of variance. In particular, a F -test [112] was exploited to check, for each microbe, whether there are significant differences in terms of variability among the different phases (Table 3.3.2.4). Only step 4 for microbe *Ec* exhibits a variance significantly greater than the variance of the mean of the 5 steps, at a 5% level.

	Var m	STEP 1 Initial condition		STEP 2 Pre-washing		STEP 3 Post-washing		STEP 4 Post-crystal violet		STEP 5 Post-acetic acid	
		Var	Ratio	Var	Ratio	Var	Ratio	Var	Ratio	Var	Ratio
<i>Kp</i>	0,003	0,005	1,82	0,002	0,64	0,005	1,68	<0,001	0,10	0,002	0,76
<i>Bs</i>	0,006	0,005	0,83	0,014	2,50	0,004	0,65	0,005	0,90	0,001	0,12
<i>Sa</i>	0,003	0,006	1,92	<0,001	0,12	0,005	1,53	0,002	0,73	0,002	0,70
<i>Pa</i>	0,003	0,004	1,58	<0,001	0,09	0,002	0,88	0,006	2,12	0,001	0,33
<i>Ec</i>	0,002	0,002	0,75	<0,001	0,12	0,002	0,82	0,006	2,80	0,001	0,52
<i>Ef</i>	0,002	0,003	1,58	<0,001	0,05	0,004	2,46	<0,001	0,28	0,001	0,63
<i>Ca</i>	0,003	0,002	0,56	0,003	1,03	0,002	0,58	0,007	2,33	0,001	0,50
<i>Aa</i>	0,003	0,002	0,52	<0,001	0,14	0,003	1,04	0,008	2,46	0,003	0,84

Tab 3.3.2.4. F-test relative to variability among different phases for all species. Degrees of freedom being 5 for numerator, and 25 for denominator, F value at 95% confidence level is 2,60. Only step 4 exhibits a significant variance ratio for *Ec* (boldface), significance level being barely approached for *Aa* and *Ca*.

3.3.2.3. Results

Preliminary results

Given the different strains of microorganisms, they are best considered individually. Since the turbidity of the suspended biofilm is the focus of the method, step 5 was examined in detail. In

this step, considering absorbance values corrected with respect to C - values, Ec , Ef , Bs show some negative values, making the evaluation of the uncertainty meaningless. Furthermore, Pa , Sa , Ca exhibited a very large variability, entailing excessively large values of uncertainty. On the other hand, results related to Kp and Aa showed an acceptable variability. The method described in Table 3 was applied, obtaining values of the relative expanded uncertainty, respectively, equal to 28% for Kp and to 22% for Aa (Table 3.3.2.5). The experiments were repeated for Ec , Kp and Aa in order to improve the method.

	Before improvement			After improvement		
	m	U	U/m	m	U	U/m
Ec	-	-	-	0,051	0,013	26%
Kp	0,174	0,049	28%	0,546	0,124	22%
Aa	0,259	0,057	22%	0,147	0,063	43%

Tab 3.3.2.5. Mean values, relevant absolute and relative expanded uncertainties (95% confidence level), before and after improvement of method.

Method improvement

The preliminary analysis enabled identification of some critical phases with step-by-step spectrophotometric measurements. In particular, a strong criticality was highlighted in the values during STEP 3, exhibiting an increase of the dispersion of results (but for Ca and Bs). Another problem is due to the tendency shown by many microorganisms to have an absorbance value near zero at STEP 5, requiring remedial action. Since STEP 3 is the most critical phase, an improvement in the method of washing was devised, by a closer control of pipette tip during the insertion into the wells and a softer release of the washing liquid (PBS). To achieve these objectives, a single pipette tip was adopted, avoiding the use of the multichannel pipette (Fig 3.3.2.1), thus enabling the operator to improve control during washing phases (STEP 3 and before STEP 4).

Final results

After improvement of the method, values of the relative expanded uncertainty equal to 26% for Ec , 22% for Kp , and 43% for Aa (Table 3.3.2.5), were obtained. On the other hand, comparing the values of absorbance before and after improvement of the method, Kp showed the highest values.

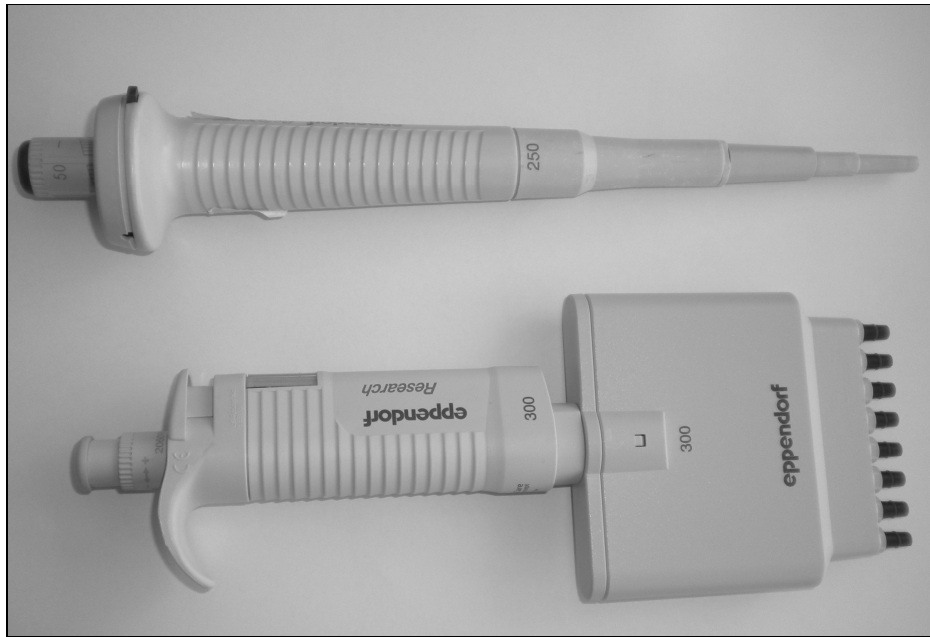

Fig 3.3.2.2. Pipettes used in the study: multichannel pipette (bottom) then substituted by single pipette (top) for the method improvement.

3.3.2.4. Discussion

The microbial biofilm development process is strictly related to the presence or absence of a variety of influencing factors [103]. Bacterial metabolism, genotype presence or absence of specific nutrients, level of O_2 , pH, temperature are some examples of factors which could up- or down-regulate biofilm both quantitatively and qualitatively [103, 106]. Bearing this in mind, since the biofilm is a dynamic structure, slight alterations among experiments may result into very different growth in vitro. Therefore comparative experiments with the method described above are best performed at the same time with the same conditions, since comparison among absorbance values obtained for the same bacteria grown in different times and/or under different conditions might yield inconsistent results.

Observing STEP 1 before and after improvement of the method, significant differences at the 95% confidence level for *Aa* and *Kp* planktonic growth may be observed, with a marked reduction of dispersion. In fact, *Aa* shows in STEP 1 of the first test a mean value of absorbance equal to 0.36 with an upper confidence limit of 0,40 and a lower confidence limit of 0.32, while in the second test the mean decreases to 0,29 with limits of 0,30 and 0,27. Accordingly, *Kp* shows in STEP 1 of the first test a mean of 1,38 with limits equal to 1,46 and 1,31, while in the second test these values change to a mean of 1,22 and limits of 1,24 and 1,21. *Ec* showed a similar planktonic growth in both tests obtaining a mean of 0,99 before the method improvement and of 1,00 after the method improvement, with limits equal to 1,03 and 0,95 against 1,06 and



0,95. These results highlight the growth stability of this bacteria, supporting the choice of *Ec* as a standard for studies in the microbiological field. The different growth rates showed by *Aa* and *Kp* may not be easily explained, since in both tests the same protocol performing the cultural phase was applied; some uncontrolled environmental factor may somehow influenced the bacterial growth.

Further considerations are necessary to understand why the method showed substantially different results between different microbial species. In the first analysis, for some microbial species biofilm analysis was made impossible by negative results and/or excessive variability. These problems may be related to a too light and thin biofilm; indeed, the biofilm is a microbial structure linked to both virulence and preservation, as well as the result of an intra-species cooperation [26, 29, 106]. Experiments in vitro may not readily replicate the conditions necessary to determine the development of virulence factors, as the analysis of each microorganism alone (necessary to understand the biodynamic linked to the biofilm development) implies the formation of a much thinner biofilm than when many bacteria grow together. The use of antibacterial substances at low concentrations might determine the formation of a thicker biofilm, however this could negate comparison among different microorganisms.

The improvement of the method enabled to determine *Kp* and *Ec* biofilms with a reasonable uncertainty thanks to a major compliance with the biofilm light base-structure, on the contrary *Aa* showed the worst results with respect to the first analysis (see **Table 3.3.2.5**). This problem may be explained by the bio-dynamic of *Aa*; during the planktonic growth, this bacteria forms micelle with consequent precipitation on the bottom of the walls, so that these structures, while not participating in the formation of the biofilm, develop a weak adhesion to the biofilm surface [105, 106]. Previous studies show that removal of loosely adherent or non-adherent cells requires many washings, up to 15, i.e. 6 more than the base protocol [105].

In conclusion, the microtiter spectrophotometric assay proved to be a valid method to perform biofilm analysis and measurements. Key factors for proper use are knowledge of the dynamics of the biofilm formation of the species to be tested, and application of the method on all samples simultaneously when performing comparative studies.

3.3.3. Metrological analysis of base values for planktonic growth and biofilm development of various microorganisms using the improved method

The method described in the previous chapter was used again with the same bacterial species at the same condition to evaluate again the uncertainty of PG and BD of all microbial species after the improving of the method.

3.3.3.1. Statistical analysis

Uncertainty evaluation was performed according to GUM [1], along the lines developed in [113]. In a nutshell, the analysis was organized in a tabular format (**Table 3.3.3.1**), according to EA-4/02:1999 [110] with some minor modifications aimed at showing more clearly the individual contribution to the variance of output quantity y [111].

Symbol	x_i Value	Note	s_j	a_j	k_{aj}	$u^2(x_j)$	c_j	$u_j^2(y)$	ν_j	$u_j^2(y)/\nu_j$
x	0,807	Res		5,0E-04	3	1,0E-08	1,0E+00	1,0E-08	100	1,1E-18
		Repr.	1,6E-01			3,3E-03	1,0E+00	3,3E-03	7	1,6E-06
b	0,180	Res		5,0E-04	3	1,0E-08	-1,0E+00	1,0E-08	100	1,1E-18
		Repr.	7,6E-03			7,3E-06	-1,0E+00	7,3E-06	7	7,5E-12
y	0,627	Variance of y , $u^2(y)$						3,3E-03	Σ	1,6E-06
		Standard deviation of y , $u(y)$						5,8E-02	ν_y	7
		Confidence level						95%		
		Coverage factor (Student's t)						2,4		
		Expanded uncertainty, $U(y)$						1,4E-01		
		Relative expanded uncertainty, $U(y)/y$						22%		

Tab 3.3.3.1. Uncertainty table, showing main contributions and resulting relative expanded uncertainty, for biofilm development of *Kp*.

A simple mathematical model was considered, namely

$$y = x - b \tag{1}$$

where x is the mean of eight replications of absorbance values considering a single microorganism, and b is the mean of eight replications of absorbance values considering the corresponding C- values. Table I shows e.g. the uncertainty budget relevant to the biofilm development of *Klebsiella pneumoniae*. Resolution of the spectrophotometer is equal to $1 \cdot 10^{-3}$. The reproducibility of x and b is calculated as the standard deviation of eight replications of

absorbance values, respectively equal to $1,6 \cdot 10^{-1}$ and $7,6 \cdot 10^{-3}$. Further details on methods for uncertainty evaluation are given in [13].

3.3.3.2. Results

		Mean	Std. Dev,	Upper limit	Lower limit	Uncertainty
Planktonic Growth	<i>Kp</i>	1,04	0,07	1,09	0,98	7%
	<i>Bs</i>	0,78	0,13	0,89	0,67	18%
	<i>Sa</i>	0,40	0,06	0,45	0,35	22%
	<i>Pa</i>	0,78	0,02	0,80	0,76	3%
	<i>Ec</i>	0,82	0,04	0,86	0,79	5%
	<i>Ef</i>	0,45	0,04	0,48	0,41	13%
	<i>Ca</i>	0,63	0,05	0,68	0,59	9%
	<i>Aa</i>	0,31	0,02	0,33	0,29	10%
	C- SH	0,10	0,01	0,11	0,09	11%
	C- MH	0,17	0,01	0,17	0,16	6%
	C- SAB	0,10	0,03	0,12	0,08	36%
Biofilm Development	<i>Kp</i>	0,81	0,16	0,94	0,67	22%
	<i>Bs</i>	0,80	0,24	1,01	0,60	32%
	<i>Sa</i>	0,63	0,11	0,72	0,54	20%
	<i>Pa</i>	0,35	0,08	0,42	0,28	41%
	<i>Ec</i>	0,25	0,02	0,27	0,24	25%
	<i>Ef</i>	0,35	0,12	0,45	0,24	55%
	<i>Ca</i>	0,29	0,06	0,35	0,24	36%
	<i>Aa</i>	0,33	0,08	0,39	0,27	31%
	C- SH	0,12	0,01	0,13	0,11	13%
	C- MH	0,18	0,01	0,19	0,17	5%
	C- SAB	0,15	0,01	0,16	0,14	9%

Tab 3.3.3.2. Descriptive statistics, limits of 95% confidence interval and corresponding relative uncertainty pertaining to tested microbial species and C- values.

Table 3.3.3.2 shows values of relative uncertainty obtained for tested microbial species.

In their planktonic condition, all microorganisms show a rather small uncertainty. In fact, only for *Bacillus subtilis* and *Staphylococcus aureus* relative uncertainty exceeds 15% (see also **Fig. 3.3.3.1**).

In biofilm state, differences among tested microbial species are larger (Fig. 3.3.3.2).

Microorganism tested may be divided into three groups:

1. Relative uncertainty lower than 30%, which includes *Klebsiella pneumoniae* (22%), *Staphylococcus aureus* (20%) and *Escherichia coli* (25%).
2. Relative uncertainty between 30% and 40%, which includes *Bacillus subtilis* (32%), *Candida albicans* (36%) and *Aggregatibacter actinomycetemcomitans* (31%).

3. Relative uncertainty greater than 40%, which includes *Pseudomonas aeruginosa* (41%) and *Enterococcus faecalis* (55%).

Furthermore, relative uncertainty for PG is lower than for BD for all microorganisms, but for *Staphylococcus aureus* (22% against 20%).

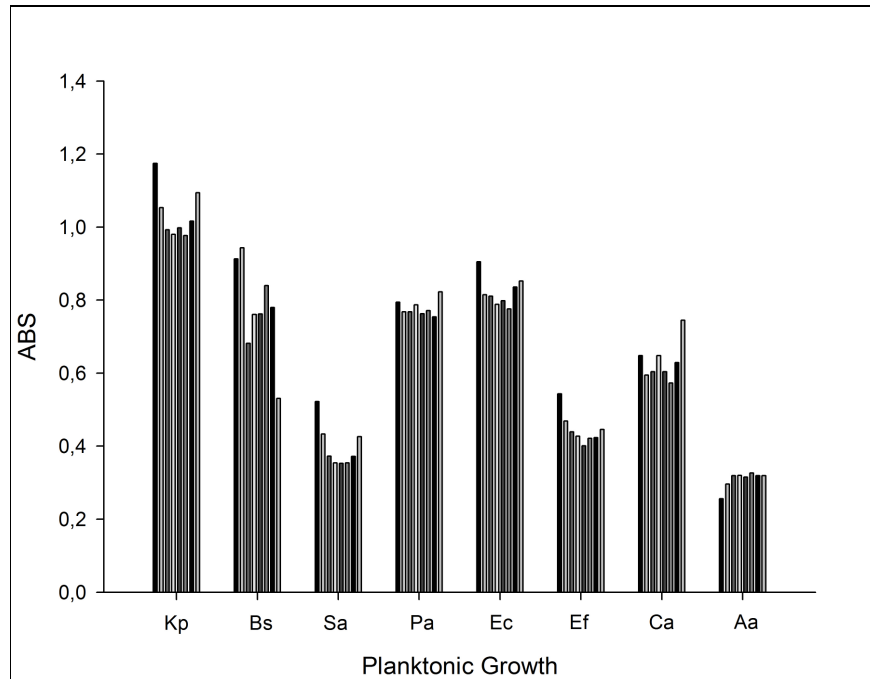

Fig 3.3.3.1. Distribution of the eight absorbance values relevant to the planktonic growth for each microbial species.

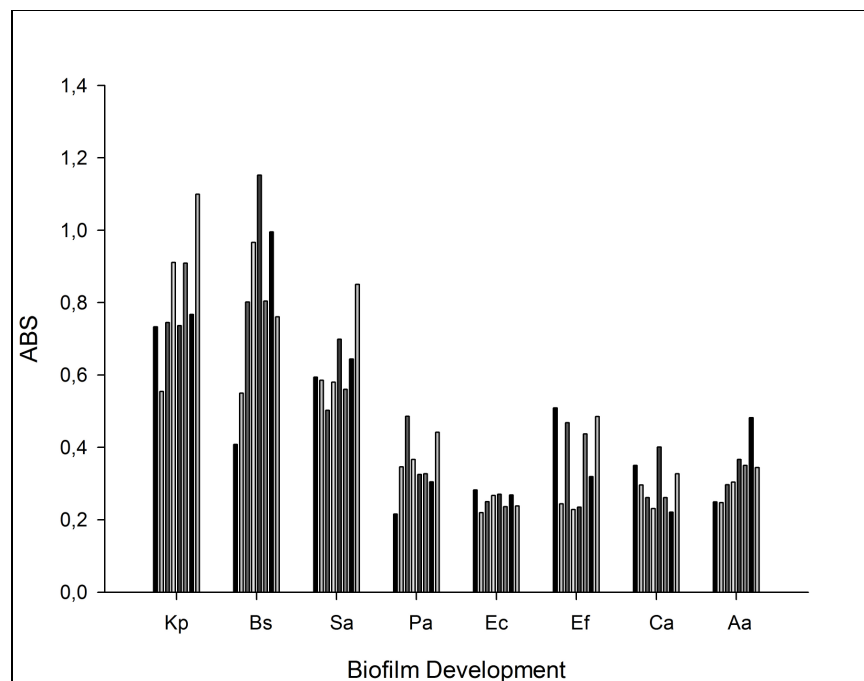

Fig 3.3.3.2. Distribution of the eight absorbance values relevant to the biofilm development for each microbial species.



3.3.3.3. Discussion

A rapid quantification analysis of different condition of prokaryotic cells, sessile or planktonic, is fundamental to determine the metabolic state of a pathogen as well to determine the activity of a therapy. In particular microbial biofilm formation is the key-stone of an impressive number of chronic infections with an high resistance against conventional antibiotic therapy [18, 20]. The analysis of its development became indispensable to highlight all the different variables that could influence sessile structures and characteristics. These conditions work during the five stages of BD, in the first stage of the attachment for example, microbial cells activity is influenced by environmental signals that change by organism but are linked to changes in nutrients and nutrient concentrations, pH, temperature, oxygen concentration, osmolality and iron too [20].

Therefore it is very important to quantify biofilm production with a method as sensible as possible, and with high reproducibility and repeatability. This permits to isolate accurately the potential biofilm production ability of each bacteria, and to determination of a proper therapeutic approach.

In this work we tested whether the Microtiter plate biofilm production assay of Christensen et al.[114], after its modification in literature[98, 104, 113], might still be considered the gold standard to study BD. To achieve this goal we applied to this method a metrological analysis covering extended uncertainty, in order to evaluate whether it may be considered equally valid for various microbial species. All factors other than microbial diversity, such as PH or nutrient concentration, were controlled and standardized to reduce as much as possible environmental influences. To minimize operator's effect, the analysis were performed by an expert user. Results show that the method exhibits a different sensitivity depending upon which microorganism it is applied to. *Kp*, *Sa* and *Ec* show a low uncertainty linked to the capacity to develop a stable and resistant biofilm also in an *in vitro* condition and without other bacteria interaction [93, 97, 115]. The second group of microorganism identified in this work, characterized by an uncertainty between 30% and 40%, is formed by *Bs*, *Ca* and *Aa*, three broadly different kind of microbial species. *Bacillus subtilis* is a Gram positive, aerobe bacterium with the ability to generate a tough endospore [96], *Candida albicans* is the most commonly fungus species associated with biofilm infection, frequently found in the normal microbiota of humans [88]. *Aggregatibacter actinomycetemcomitans* is a gram-negative, facultative anaerobe, implicated in numerous human diseases [109]. These three microbial organisms have very different characteristic so that

there is the need to find for each one of them a specific explanation for the high value of uncertainty described.

Bs characteristically generate solid surface-associated biofilms as well as biofilm similar to a pellicle at the air-liquid interface, following a distinct developmental pathway as respect to others bacteria such as *Ec*, *Sa* or *Kp*. When *Bs* cells reach a concentration of 5×10^7 CFU/ml, they begin to form a floating pellicle on the air-liquid interface with the development of aerial projections [90]. This kind of aerial structure can be easily destroyed during the Microtiter plate biofilm production assay method, accounting for the substantial uncertainty detected.

Ca biofilm is strictly related with its virulence and in these last decades it became the third leading cause of catheter-related infections [116]. *Ca* sessile state have some specific characteristics that made this microorganism hard to treat by applying the Microtiter plate biofilm production assay method. First of all its cells need for their initial attachment a bio-surface while the plate were is realized the biofilm coloration is obviously synthetic; despite this, thanks both to the proteins present in the broth and to other adhesive capacity of cells, the primary adhesion, although weaker, takes place however [88]. Therefore during the washing phases a part of the biofilm may be easily removed from the plate's walls, leading to higher uncertainty than pertaining to microorganisms which produce a biofilm with a better attachment.

Aa uncertainty may be explained by its bio-dynamic, this bacteria being characterized by the formation of micelle during its planktonic growth. This structure shows a tendency to settle to the bottom of plate's wall where it forms the biofilm. When the micelle came into contact with the biofilm surface they develop a mutual adhesion that may be hard to remove by washing [105, 106]. Previous studies show that removal of loosely adherent or non-adherent cells requires many washings, up to 15, i.e. 6 more than the base protocol [105].

Eventually two bacteria were identified with a relative uncertainty exceeding 40%, namely *Ef* and *Pa*. *Enterococcus faecalis* needs to produce its biofilm with a high concentration of glucose in the medium, since it is linked to that of a glucose-dependent transcriptional regulator [117]. The surface protein of *Ef* involved in biofilm production showed improvement in presence of strain with glucose at 1%; lacking this it was reported that only BD were reduced without any effect on PG [118]. Presence of human serum in the medium is reported too as condition that enable the formation of a more resistant biofilm as well to promote a better regulation to pass from initiation to mature biofilm [117]. In this work was used as medium for the *Ef* the MH that not presents in its composition or glucose or human serum. For this reason it has formed a biofilm less resistant than that in vivo, a biofilm which therefore has suffered the washing steps more then for other microbial species.

Pseudomonas aeruginosa biofilm formation and maturation are strictly linked to environmental conditions. In literature is described that this bacteria needs to develop a mature biofilm a medium contained glucose and a carbon source both absent in the MH used in this study [119]. In conclusion this work shows how the Microtiter plate biofilm production assay is a good method to perform a quantitative and qualitative evaluation of both PG and BD. To use it properly for BD is always indispensable to have an excellent knowledge about the metabolism and about the growth mechanism of the microorganism to analyze.

3.3.4. Conclusions (From step 2 to step 3)

At the end of the second phase a microorganism was selected to be subjected to ultrasound so as to perform the third phase. To choose which bacteria could be the better, three variable were evaluated:

1. Uncertainty of PG evaluated as absorbance value after seven days of incubation.
2. Uncertainty of BD evaluated as absorbance value obtained by the microtiter plate assay method.
3. Knowledge about its metabolism.

For these reasons *Escherichia coli* has been chosen, in fact it presented a low uncertainty for both the evaluated conditions (**Table 3.3.3.2**) and, at the same time, it is consider the model organism for the study of surface colonization.

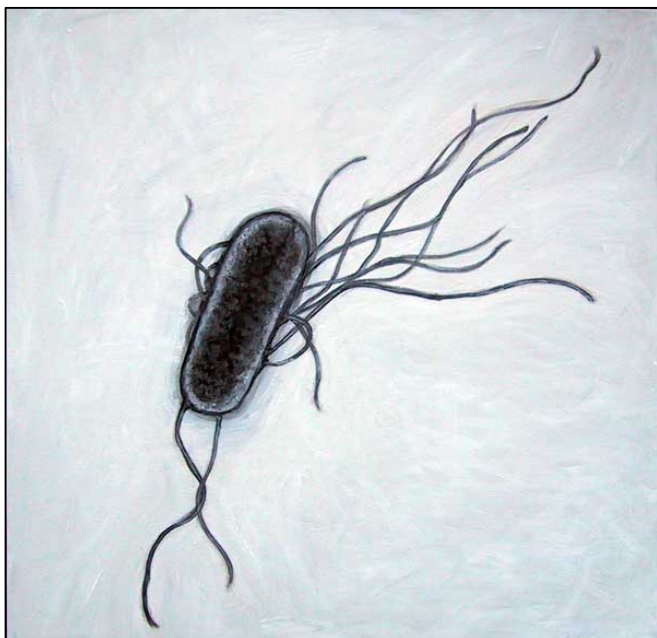

Fig 3.3.4.1. *Escherichia coli* macroscopic aspect

E. coli (**Fig 3.3.4.1**) is a facultative anaerobic bacteria of the gastrointestinal tract and, with more than 250 serotype, it is recognised as primary causes of infection of the urogenital tract as well of contaminator of medical devices [93]. Its biofilm formation is related to four different phases well described in literature:

1. Approaching the surface;
2. Primary adhesion to surface;
3. Irreversible adhesion to surface;
4. Building the mature biofilm.

The first phase is related to the active motility of the microorganism in a liquid or semi-liquid medium. This ability is related to a flagellar apparatus that allows to gram-negative bacteria, as *E. coli*, to swim up to increase their chance to reach a surface to colonize [93]. Recent studies have shown that the presence and magnitude of an active motility is even essential for the formation of a biofilm [120].

The second phase is strongly influenced by different kind of factors, as well as the environmental conditions, such as medium ph or temperature, as the characteristics of adhesion surface, such as rugosity or if it is made by an hydrophobic or an hydrophilic material [18]. These factors directly influence the physicochemical and electrostatic interactions between the bacteria and the adhesion surface [93].

The third phase is based on the role of the fimbriae and in particular on their capacity to develop an irreversible attachment of bacteria to the surface of adhesion. These protein structures can be divided into three classes such as type 1 fimbriae, curli, and conjugative pili. All of them are related to the expression of specific genes whose mutation or inhibition may lead to the development of a biofilm less resistant or to the lack of formation of it.

3.4 Step 3

1. Bacterial viability and biofilm development measurement after ultrasonic exposure
2. Uncertainty and statistical analysis of data (RESULTS)
3. Future prospective (DISCUSSION AND CONCLUSIONS)

3.4.1. Description

After steps 1 and 2 the US frequencies, the types of tubes to use and the bacteria to test have been chosen. In the step 3 all these elements will be used all together to reach the goals described in the Chapter 1.

To perform the exposition of the *E. coli* to the acoustic pressure first of all there was the need to analyze its growth curve to identify the best timing to perform the experiments (**Fig 3.4.1.1**).

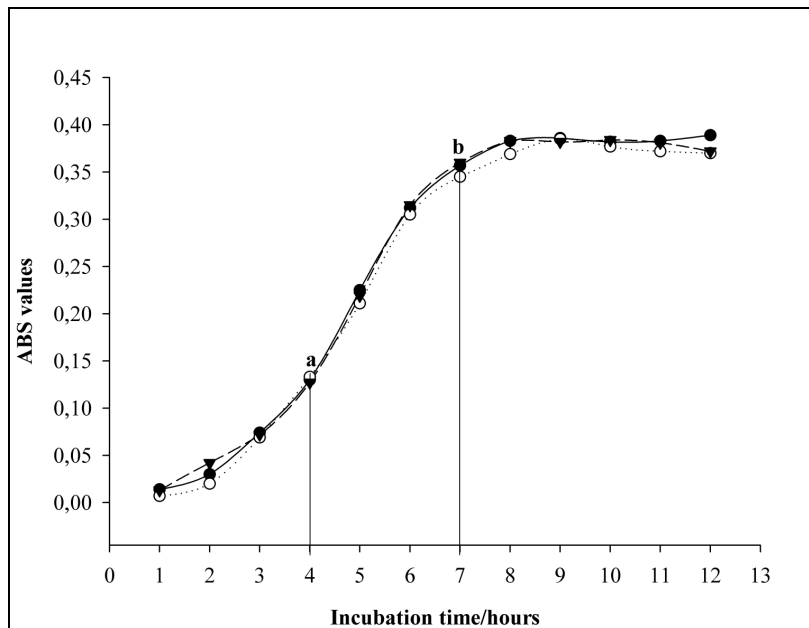

Fig 3.4.1.1. *E. coli* growth curve made to identify the phases of growth of the bacterium and based on 3 replications of measurement. The point “a” is the beginning of the exponential growth while the point “b” is the beginning of the stationary growth. The best time to achieve the experiments is at the beginning of the stationary growth phase as it is the one with the greater stability of the sample.

Growth and preparation of *E. coli* were carried out according to the same protocol described in Section 3.3. To determine the exposure time and to test the protocol a preliminary experiment was done. In this first test only the 20 kHz frequency was used and six exposure times, from 10 to 60 seconds, were tested with 10 second intervals between each of them. One tube containing the culture of *E. coli* at a concentration of 10^6 CFU/ml was prepared for each exposure time (test tube named 10, 20, 30, 40, 50 and 60) more one tube for the analysis of bacterial growth without US exposition (named C+). Each tube was inserted into the central hole of the grid and it was

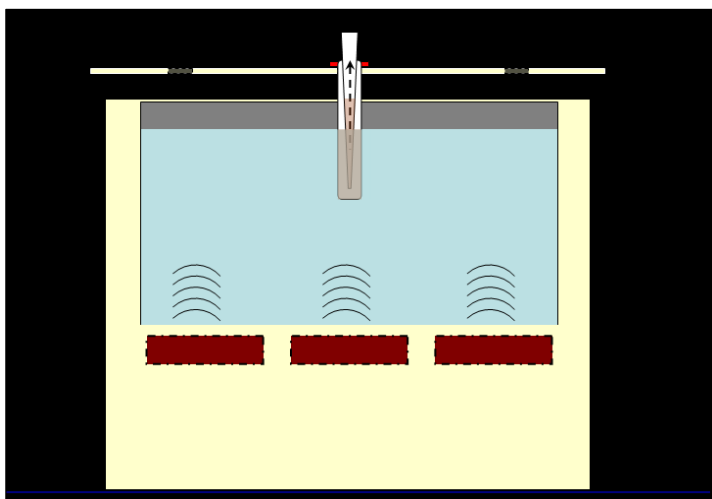

Fig 3.4.1.2. Step 3 experiment

immersed into the ultrasonic tank as described in the chapter 3.2. At this point the US were emitted for the time chosen for each test at the chosen frequency. After the US exposition from each tube were collected eight samples and seeded in multiwall to achieve the incubation and then the spectrophotometric measurement as described in the chapter 3.3 (Fig

3.4.1.2). Each exposure time was analyzed both for its activity in relation with the PG as for the BD. From this preliminary analysis no difference was identified in PG in relation with the exposure times, while three exposure times have showed to be the more interesting in relation with the BD and they were the 10 seconds, 40 seconds and 60 seconds (**Fig 3.4.1.3**).

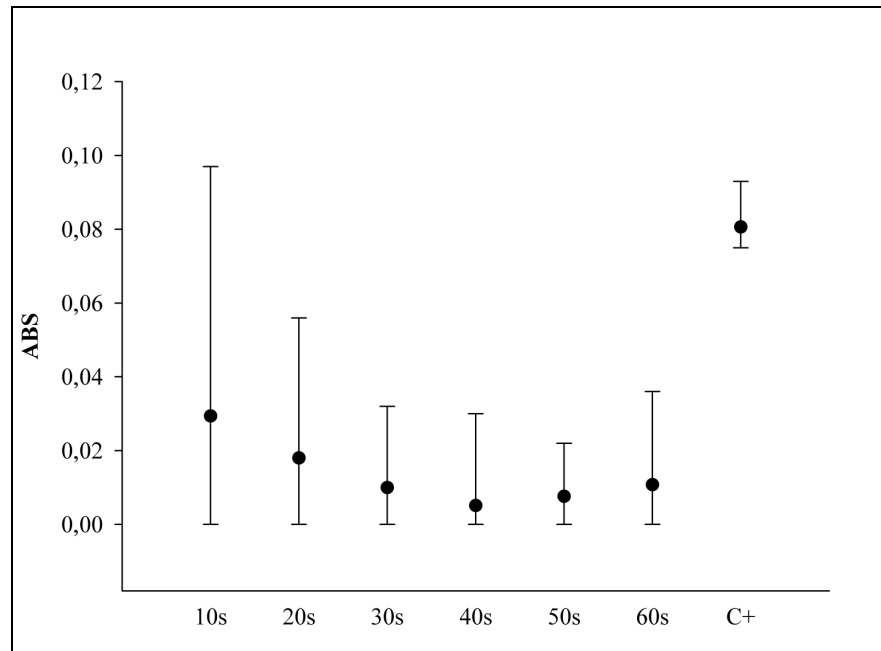

Fig 3.4.1.3. Biofilm development values after *E. coli* exposition at different exposure times to an acoustic pressure related to the ultrasonic wave with a length-wave of 20 kHz and seven days of incubation.

3.4.2. Analysis of planktonic growth and biofilm development after ultrasonic exposure

After the exposure times were chosen, the main experiment was started following the same protocol of the preliminary. For each frequency and each exposure time to be tested it was decided to prepare three tubes containing 5 ml of *E. coli* in Müller Hinton broth at a concentration of $10 \cdot 10^6$ CFU/ml for a total of 63 bacterial cultures. In addition for each frequency will be also prepared three tubes, under the same conditions described above, for the sample for comparison (C +) to a total of 84 test tubes. To perform spectrophotometric analysis after US exposure each sample will be divided in eight wall of a multiwall plate to be incubated for seven days. At the end of the incubation 504 values for both PG and BD will be obtained to be compared with the 168 C+ for both the bacterial condition. To perform the analysis, they were carried out on three different days, 15 days apart from each other, always at the same hour of the day and checking that the environmental conditions (such as temperature and humidity of the room) were the same every time (**Fig 3.4.2.1-14**).

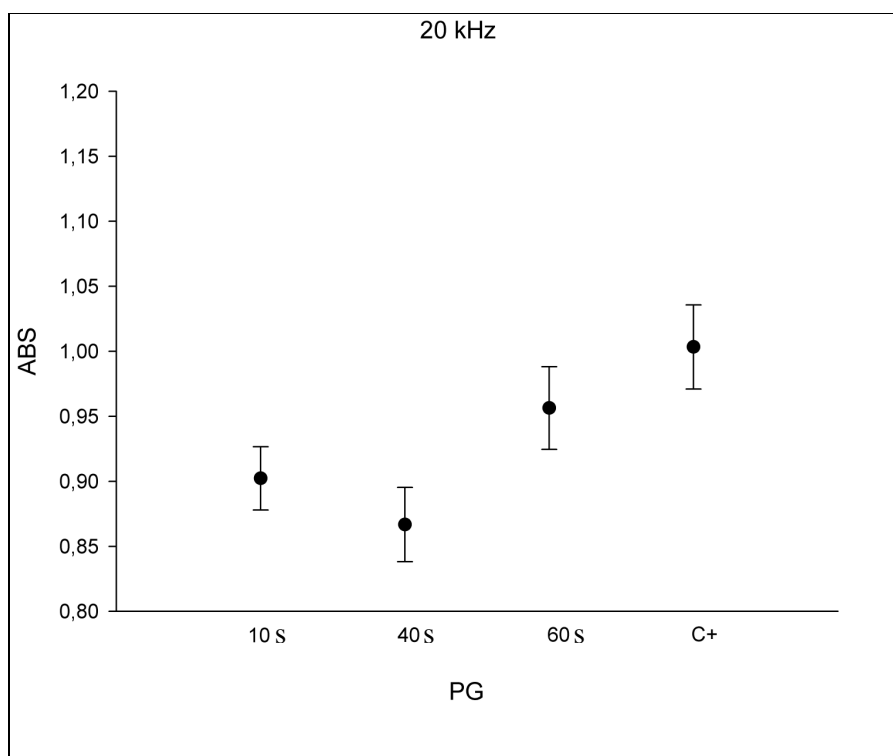

Fig 3.4.2.1. Planktonic growth (PG), represented by an absorbance value (ABS), of *Escherichia coli* after exposure to an ultrasonic wave at 20 kHz for 10, 40 and 60 seconds compared to the PG ABS obtained without ultrasounds (C+). Results are related to 24 measures for each condition.

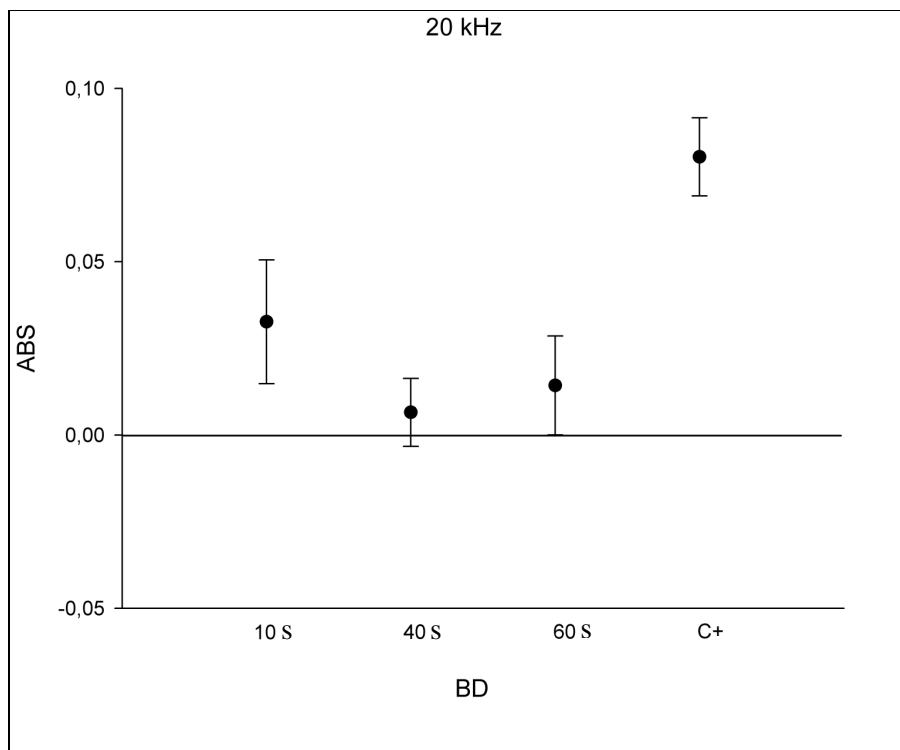

Fig 3.4.2.2. Biofilm development (BD), represented by an absorbance value (ABS), of *Escherichia coli* after exposure to an ultrasonic wave at 20 kHz for 10, 40 and 60 seconds compared to the BD ABS obtained without ultrasounds (C+). Results are related to 24 measures for each condition.

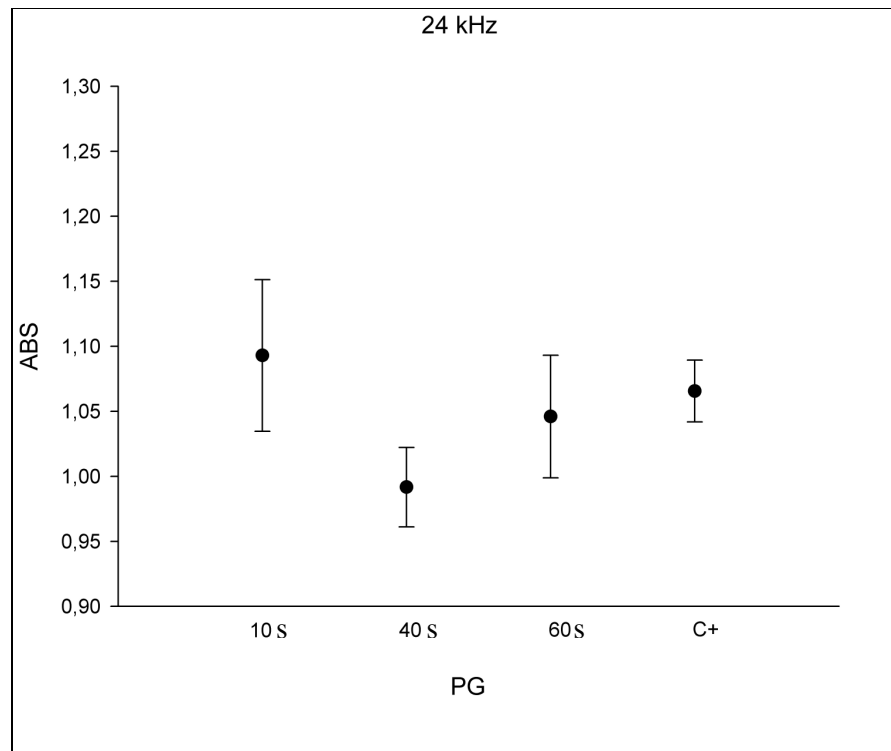

Fig 3.4.2.3. Planktonic growth (PG), represented by an absorbance value (ABS), of *Escherichia coli* after exposure to an ultrasonic wave at 24 kHz for 10, 40 and 60 seconds compared to the PG ABS obtained without ultrasounds (C+). Results are related to 24 measures for each condition.

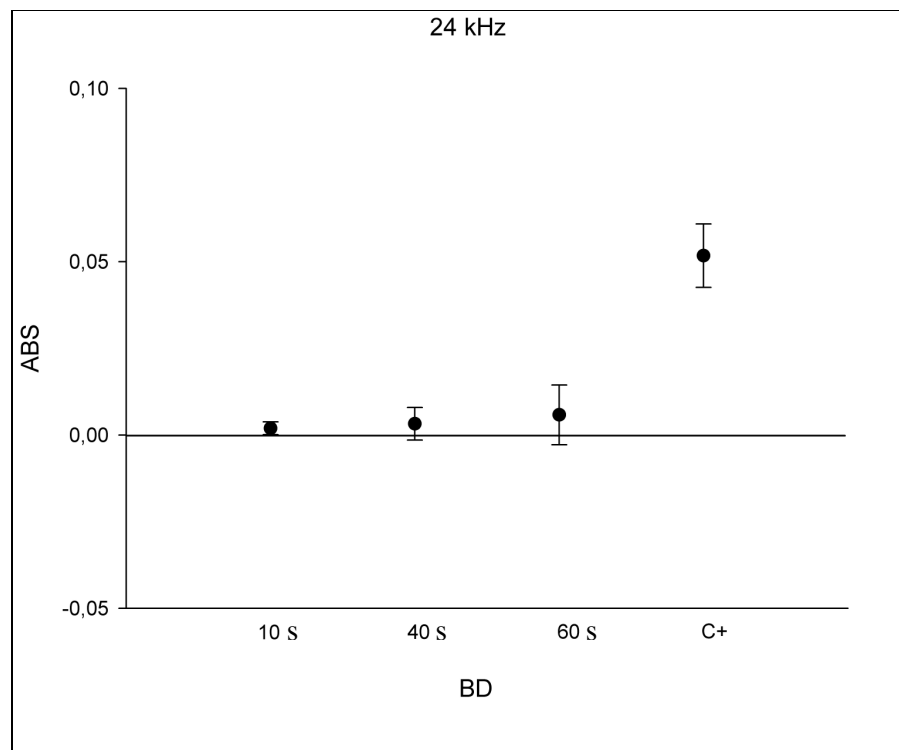

Fig 3.4.2.4. Biofilm development (BD), represented by an absorbance value (ABS), of *Escherichia coli* after exposure to an ultrasonic wave at 24 kHz for 10, 40 and 60 seconds compared to the BD ABS obtained without ultrasounds (C+). Results are related to 24 measures for each condition.

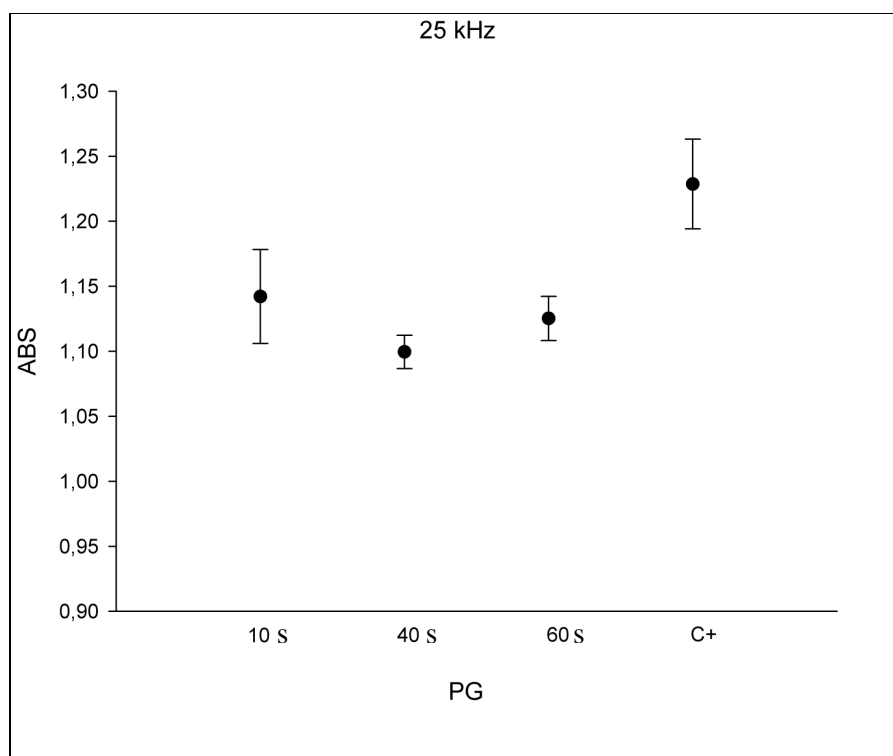

Fig 3.4.2.5. Planktonic growth (PG), represented by an absorbance value (ABS), of *Escherichia coli* after exposure to an ultrasonic wave at 25 kHz for 10, 40 and 60 seconds compared to the PG ABS obtained without ultrasounds (C+). Results are related to 24 measures for each condition.

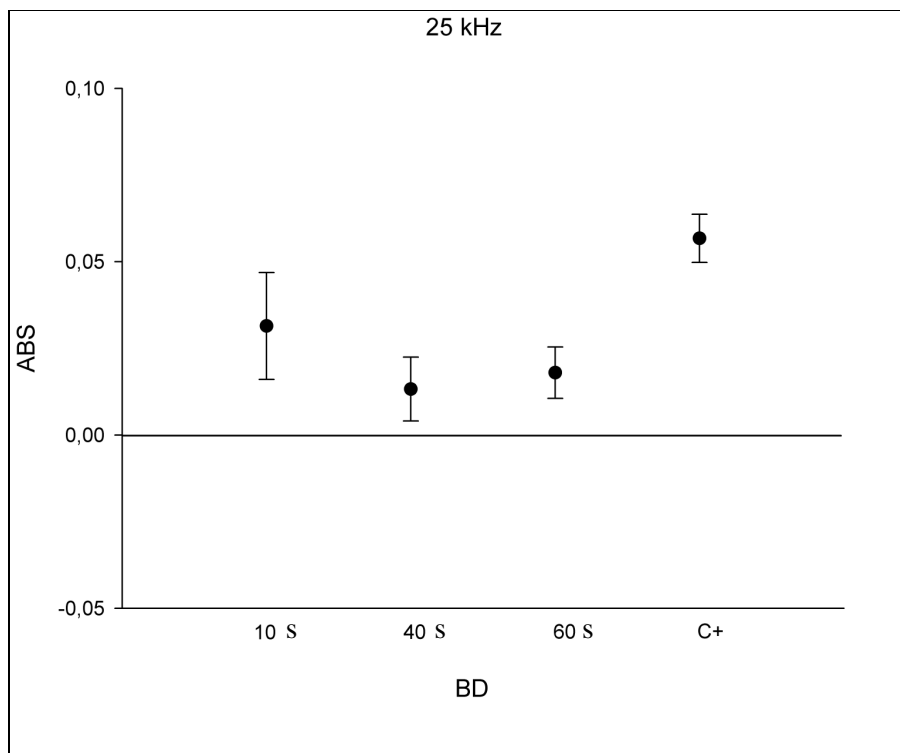

Fig 3.4.2.6. Biofilm development (BD), represented by an absorbance value (ABS), of *Escherichia coli* after exposure to an ultrasonic wave at 25 kHz for 10, 40 and 60 seconds compared to the BD ABS obtained without ultrasounds (C+). Results are related to 24 measures for each condition.

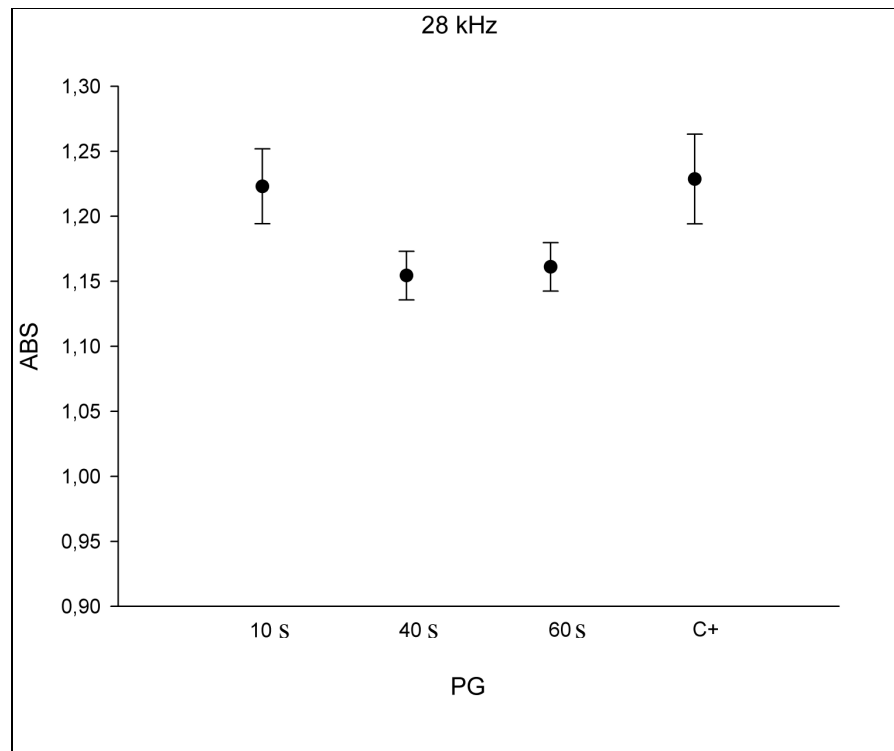

Fig 3.4.2.7. Planktonic growth (PG), represented by an absorbance value (ABS), of *Escherichia coli* after exposure to an ultrasonic wave at 28 kHz for 10, 40 and 60 seconds compared to the PG ABS obtained without ultrasounds (C+). Results are related to 24 measures for each condition.

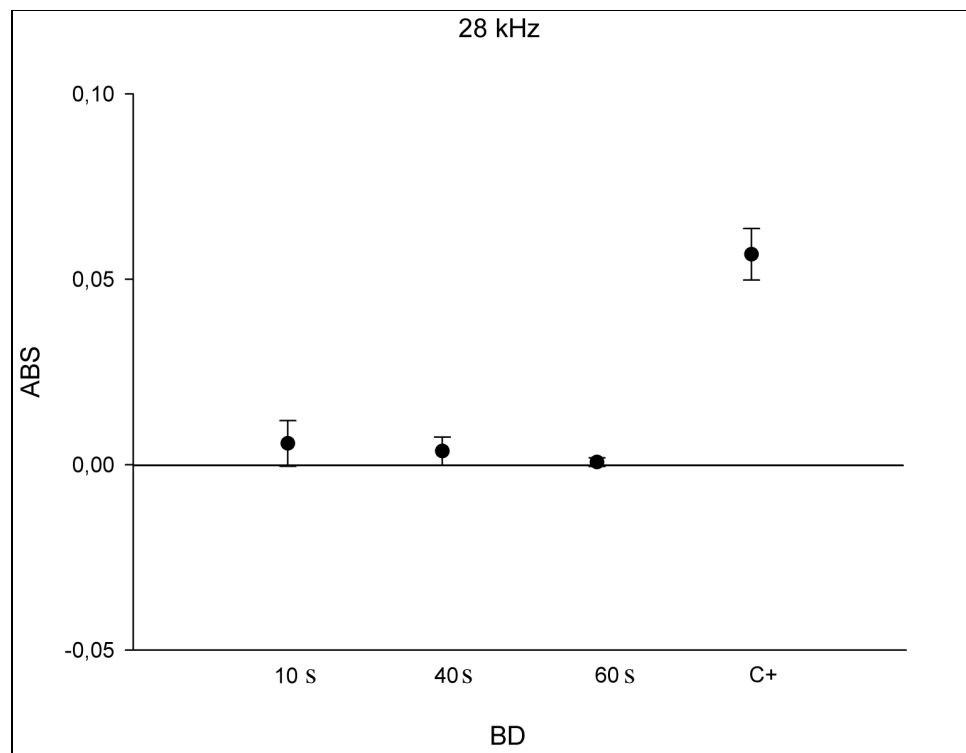

Fig 3.4.2.8. Biofilm development (BD), represented by an absorbance value (ABS), of *Escherichia coli* after exposure to an ultrasonic wave at 28 kHz for 10, 40 and 60 seconds compared to the BD ABS obtained without ultrasounds (C+). Results are related to 24 measures for each condition.

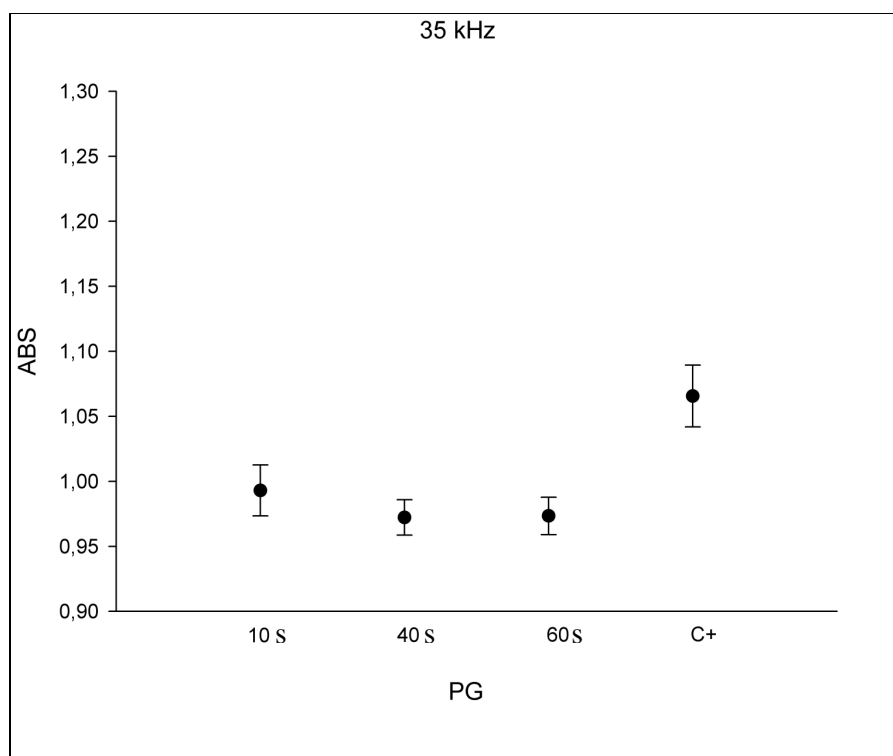

Fig 3.4.2.9. Planktonic growth (PG), represented by an absorbance value (ABS), of *Escherichia coli* after exposure to an ultrasonic wave at 35 kHz for 10, 40 and 60 seconds compared to the PG ABS obtained without ultrasounds (C+). Results are related to 24 measures for each condition.

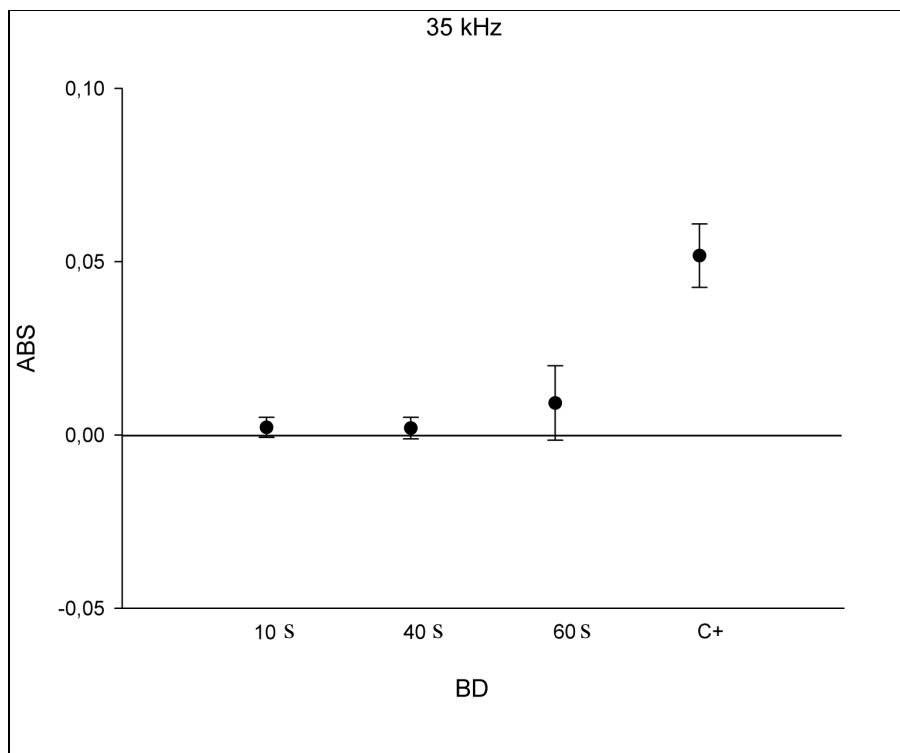

Fig 3.4.2.10. Biofilm development (BD), represented by an absorbance value (ABS), of *Escherichia coli* after exposure to an ultrasonic wave at 35 kHz for 10, 40 and 60 seconds compared to the BD ABS obtained without ultrasounds (C+). Results are related to 24 measures for each condition.

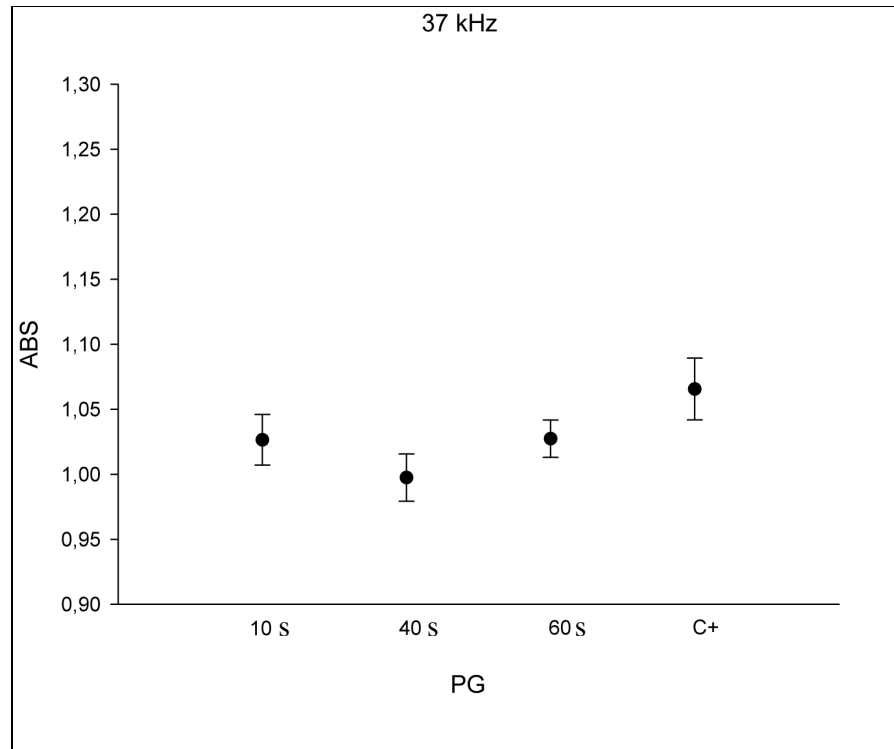

Fig 3.4.2.11. Planktonic growth (PG), represented by an absorbance value (ABS), of *Escherichia coli* after exposure to an ultrasonic wave at 37 kHz for 10, 40 and 60 seconds compared to the PG ABS obtained without ultrasounds (C+). Results are related to 24 measures for each condition.

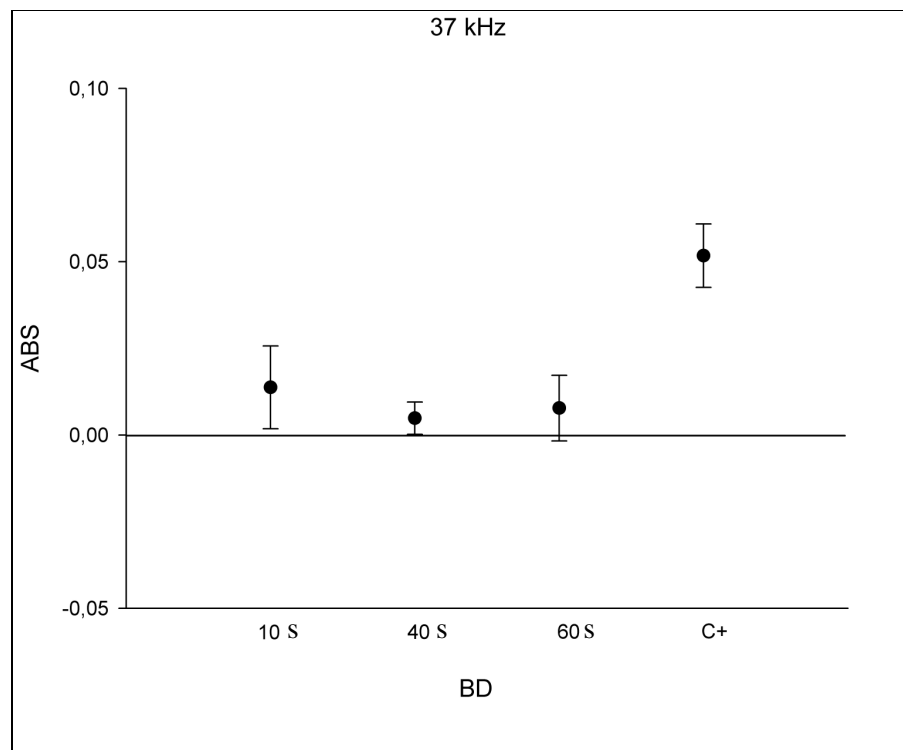

Fig 3.4.2.12. Biofilm development (BD), represented by an absorbance value (ABS), of *Escherichia coli* after exposure to an ultrasonic wave at 37 kHz for 10, 40 and 60 seconds compared to the BD ABS obtained without ultrasounds (C+). Results are related to 24 measures for each condition.

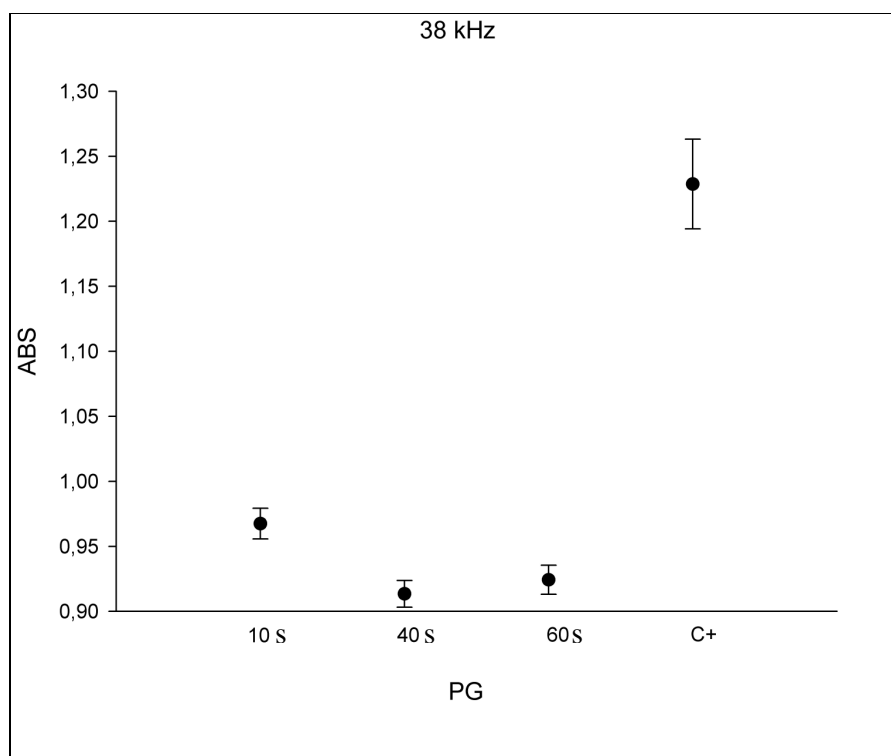

Fig 3.4.2.13. Planktonic growth (PG), represented by an absorbance value (ABS), of *Escherichia coli* after exposure to an ultrasonic wave at 38 kHz for 10, 40 and 60 seconds compared to the PG ABS obtained without ultrasounds (C+). Results are related to 24 measures for each condition.

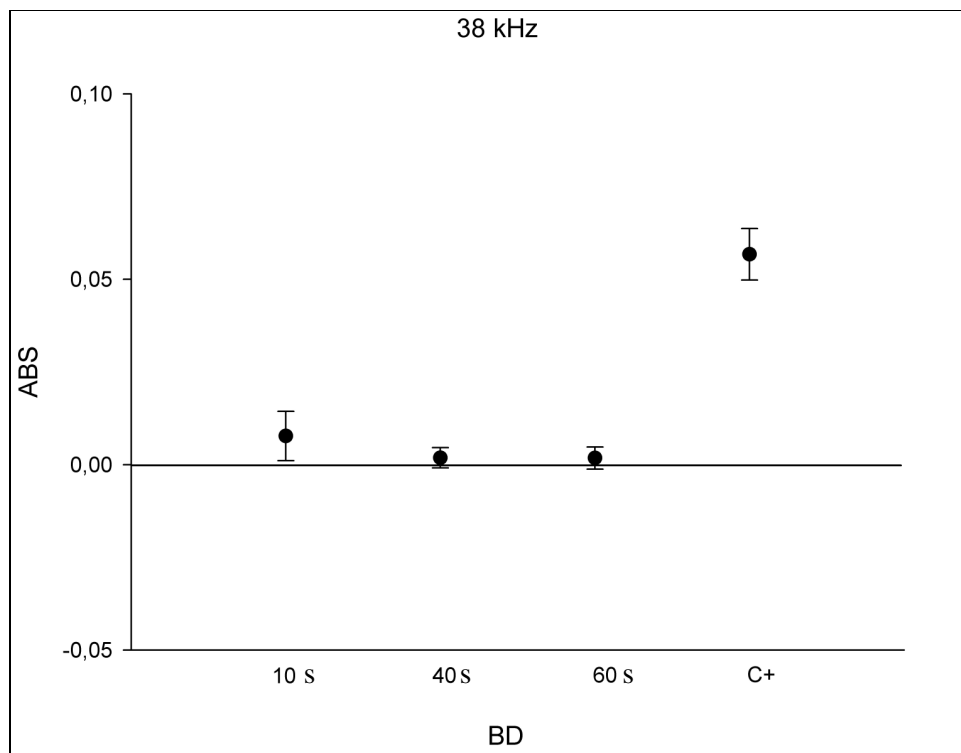

Fig 3.4.2.14. Biofilm development (BD), represented by an absorbance value (ABS), of *Escherichia coli* after exposure to an ultrasonic wave at 38 kHz for 10, 40 and 60 seconds compared to the BD ABS obtained without ultrasounds (C+). Results are related to 24 measures for each condition.

3.4.3. Metrological evaluation of step 3

The analysis the uncertainty at 95% confidence level was evaluated as first thing to determine the stability of our samples. To determine the uncertainty was used the same table previously exposed (see Tables 3.3.2.3 and 3.3.3.1). The PG showed little uncertainty as regards both the cultures exposed to the US that the control samples. In several cases it was found in the samples less uncertainty than in the control (Table 3.4.3.1). On the contrary the BD showed very high values of uncertainty in relation to the samples exposed to ultrasound, uncertainty that has remained low in the controls. In particular it has been possible to note how the uncertainty would increase passing from 10 to 40 seconds of exposure and then decreased again towards the 60 seconds for almost all frequencies studied (Table 3.4.3.1).

In the next chapter an analysis frequency by frequency of the two states will be performed to try to identify a trend that allows to hypothesize the reasons for these results.

Frequency (kHz)	Uncertainty values							
	PG				BD			
	10 s	40 s	60 s	C+	10 s	40 s	60 s	C+
20	3%	4%	4%	4%	60%	300%	130%	15%
24	6%	4%	5%	3%	310%	3030%	330%	12%
25	4%	2%	2%	3%	55%	95%	53%	16%
28	3%	2%	2%	3%	250%	800%	80%	14%
35	2%	2%	2%	3%	480%	400%	180%	12%
37	2%	2%	2%	3%	120%	310%	210%	13%
38	2%	2%	2%	3%	160%	340%	330%	16%

Table 3.4.3.1. Uncertainty of planktonic growth (PG) and biofilm development (BD) for each exposure time to US.

4. RESULTS

4.1. Statistical Analysis

Minitab[®] 16.1.1 was used to perform statistical analysis of the absorbance values (**ABS**) obtained by the step 3. In the first phase of the analysis the ABS variables related to PG and BD are called simply **PG** and **BD**, while the factors taken in consideration are the frequency (**kHz**), the exposure time (**t**), and the minimum, medium and maximum values of acoustic pressure (**kPa min**, **kPa mean** and **kPa max**). After this phase the variables PG and BD will be normalized using the acoustic pressure values (**Table 4.1.1**)

Factors		Variables	Variables normalized
kHz	kPa min	PG	PG/kPa min, PG/kPa mean, PG/kPa max
	kPa mean		
t	kPa max	BD	BD/kPa min, BD/kPa mean, BD/kPa max

Table 4.1.1. Schematization of the factors and variables used to perform the statistical analysis of data.

In order to be able to compare the values of ABS between a frequency and another, due to the high variability of the samples, each individual value of PG and BD has been transformed into a value of comparison. This value, expressed on a scale 0-1, has as a reference the average of C + for each frequency and bacterial state that is used as a value of unit (**Table 4.1.2**).

Frequency (kHz)	Acoustic Pressure (kPa)	ABS mean (comparison value with C+)							
		Planktonic Growth (PG)				Biofilm Development (BD)			
		10 s	40 s	60 s	C+	10 s	40 s	60 s	C+
20 (Plexiglass)	2,09 ± 0,85 (1,24-2,94)	0,90	0,86	0,95	1,00	0,41	0,08	0,18	1,00
24 (Vetro)	2,93 ± 1,43 (1,5-4,36)	1,03	0,93	0,98	1,00	0,04	0,06	0,11	1,00
25 (Plexiglass)	1,42 ± 0,96 (0,46-2,38)	0,93	0,89	0,92	1,00	0,55	0,23	0,32	1,00
28 (Plexiglass)	2,49 ± 0,87 (1,62-3,36)	1,00	0,94	0,94	1,00	0,10	0,06	0,01	1,00
35 (Vetro)	3,13 ± 1,63 (1,5-4,76)	0,93	0,91	0,91	1,00	0,04	0,04	0,18	1,00
37 (Vetro)	1,93 ± 0,91 (1,02-2,84)	0,96	0,94	0,96	1,00	0,27	0,09	0,15	1,00
38 (Plexiglass)	3,99 ± 2,15 (1,84-6,14)	0,79	0,74	0,75	1,00	0,14	0,03	0,03	1,00

Table 4.1.2. Means of the variables ready to be compared with each other and with the factors time, pressure and frequency.

The first analysis was the evaluation of the effects of kHz, t and kPa min, kPa mean and kPa max on PG and BD, using the analysis of the variance (ANOVA) (**Fig 4.1.1-4.1.2**).

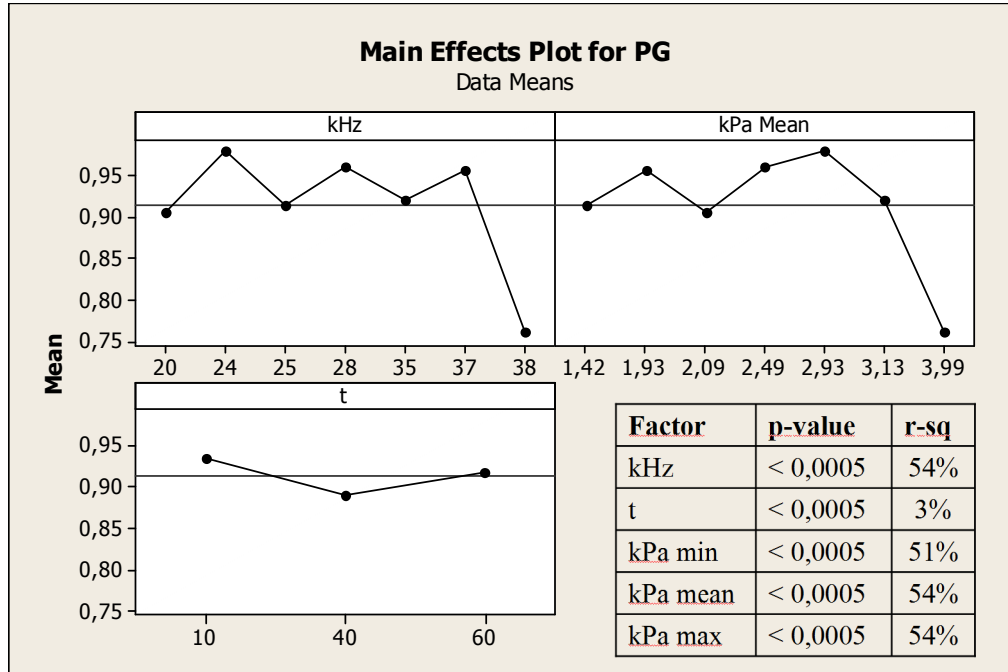

Fig 4.1.1. The mean value of ABS for PG does not appear affected by the acoustic pressure if not for values higher than 3.11 kPa, the exposure time shows a trend, apparently parabolic, between 10, 40 and 60 seconds, finally, there seems to be a effect of frequency regardless of pressure.

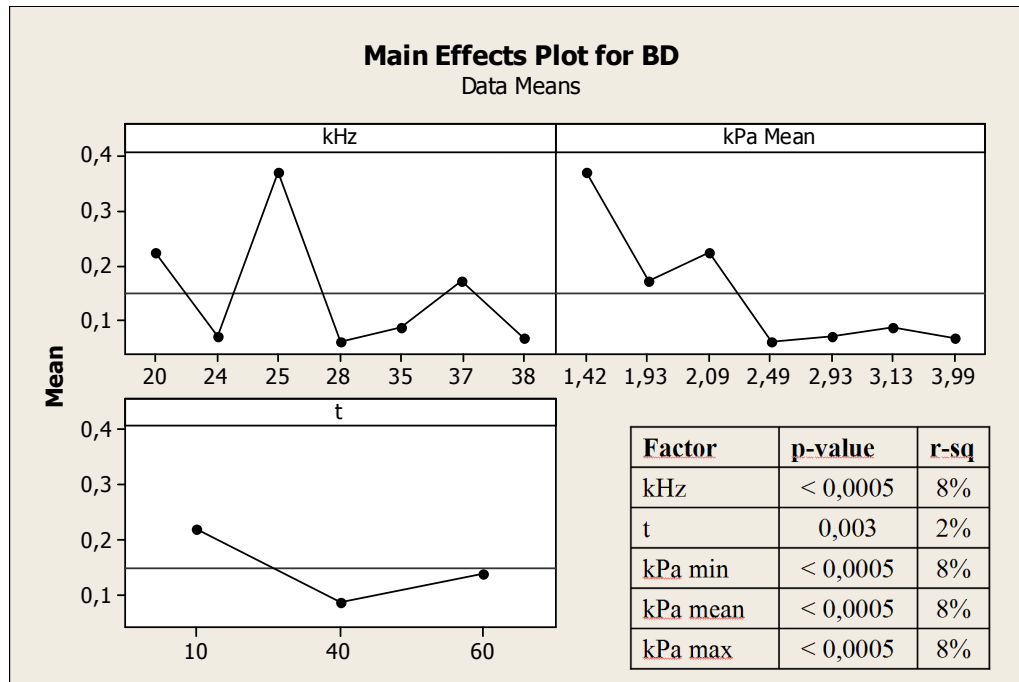

Fig 4.1.2. Unlike PG, the mean values of ABS for BD shows a rather pronounced influence of the acoustic pressure. A parabolic trend is present for the time factor, while the frequency factor requires more detailed analysis.

A matrix plot was used to explore graphically relations between factors and variables (**Fig 4.1.3**).

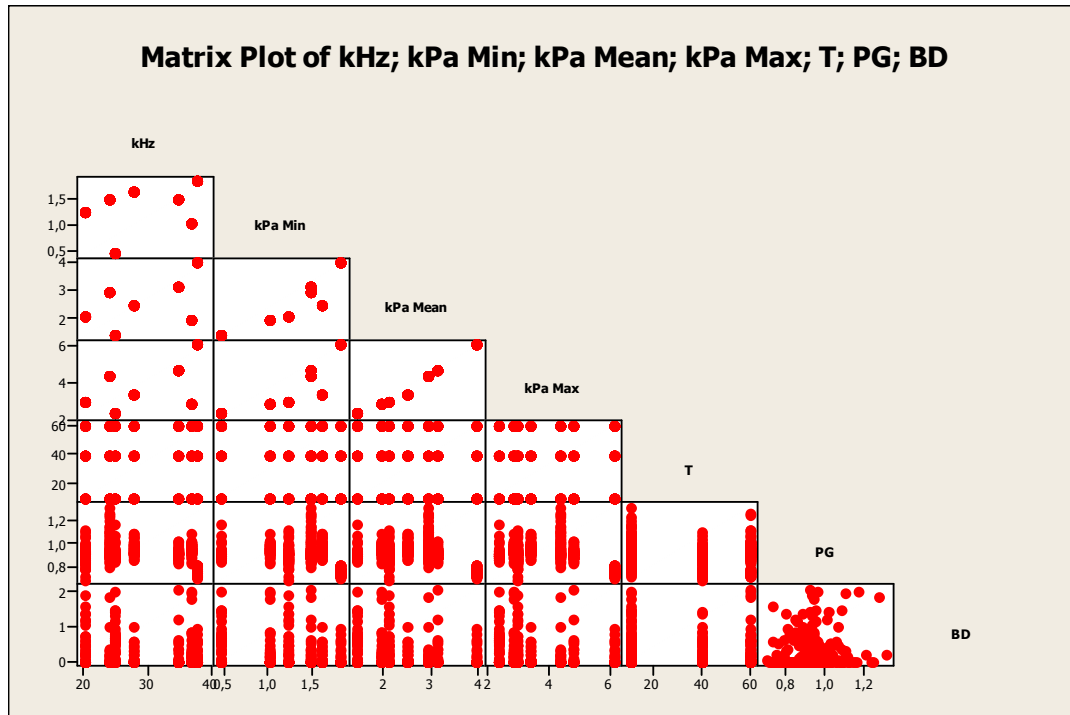

Fig 4.1.3. No clear relationship between PG and BD appears.

Before beginning the analysis of individual variables a check was performed to identify a correlation if any between variation of the two variable in relation with frequency. A descriptive statistic was realized to evaluate the variables in relation with each factor (Table 4.1.3-4.1.5) and then Pearson’s correlation coefficient was computed for all combinations of variables and factors (Table 4.1.6).

Variable	Mean	StDev	Minimum	Q1	Median	Q3	Maximum	Range
PG	0,91	0,09	0,69	0,88	0,92	0,96	1,31	0,62
BD	0,15	0,36	0,00	0,00	0,00	0,03	2,09	2,09

Table 4.1.3. Descriptive statistic of the ABS values separated in function of PG and BD.

Variable	kHz	Mean	StDev	Minimum	Q1	Median	Q3	Maximum	Range
PG	20	0,91	0,08	0,69	0,86	0,91	0,94	1,12	0,43
	24	0,98	0,11	0,81	0,91	0,94	1,04	1,31	0,51
	25	0,91	0,05	0,84	0,89	0,90	0,93	1,17	0,33
	28	0,96	0,05	0,86	0,92	0,95	0,99	1,09	0,22
	35	0,92	0,04	0,84	0,90	0,92	0,94	1,02	0,18
	37	0,95	0,04	0,83	0,93	0,96	0,98	1,09	0,27
	38	0,76	0,03	0,70	0,74	0,76	0,78	0,82	0,12
BD	20	0,22	0,44	0,00	0,00	0,00	0,26	1,93	1,93
	24	0,07	0,26	0,00	0,00	0,00	0,00	1,91	1,91
	25	0,37	0,48	0,00	0,00	0,03	0,65	2,03	2,03
	28	0,06	0,18	0,00	0,00	0,00	0,00	1,04	1,04
	35	0,09	0,31	0,00	0,00	0,00	0,00	2,09	2,09
	37	0,17	0,42	0,00	0,00	0,00	0,15	2,03	2,03
	38	0,07	0,19	0,00	0,00	0,00	0,00	0,99	0,99

Table 4.1.4. Descriptive statistic of the ABS values in function of PG and BD and in relation with kHz.

Variable	t	Mean	StDev	Minimum	Q1	Median	Q3	Maximum	Range
PG	10	0,93	0,10	0,72	0,89	0,93	0,98	1,31	0,59
	40	0,89	0,08	0,69	0,87	0,90	0,94	1,10	0,41
	60	0,92	0,09	0,72	0,90	0,93	0,96	1,27	0,55
BD	10	0,22	0,44	0,00	0,00	0,00	0,24	2,03	2,03
	40	0,09	0,24	0,00	0,00	0,00	0,00	1,43	1,43
	60	0,14	0,36	0,00	0,00	0,00	0,02	2,09	2,09

Table 4.1.5. Descriptive statistic of the ABS values in function of PG and BD and in relation with t.

	kHz		t		kPa min		kPa mean		kPa max		Other variable	
	p-value	pearson	p-value	pearson	p-value	pearson	p-value	pearson	p-value	pearson	p-value	pearson
PG	<0,0005	-0,315	0,042	-0,091	<0,0005	-0,238	<0,0005	-0,427	<0,0005	-0,471	0,009	0,117
BD	<0,0005	-0,121	0,018	-0,105	<0,0005	-0,277	<0,0005	-0,237	<0,0005	-0,211		

Table 4.1.6. Pearson’s correlation coefficients, and related p-values

The results of Pearson correlation analysis could be influenced by the values related to 38 kHz, that is the frequency with the highest acoustic pressure, and have a strong influence on both PG and BD (see Fig 4.1.1 and 4.1.2). Therefore Pearson’s analysis was repeated without the ABS values related to that frequency (Table 4.1.7).

	kHz		t		kPa min		kPa mean		kPa max		Other variable	
	p-value	Pearson	p-value	Pearson	p-value	Pearson	p-value	Pearson	p-value	Pearson	p-value	Pearson
PG	0,129	0,073	0,040	-0,099	<0,0005	0,179	0,002	0,149	0,011	0,123	0,158	0,068
BD	0,070	-0,087	0,045	-0,096	<0,0005	-0,273	<0,0005	-0,253	<0,0005	-0,223		

Table 4.1.7. Pearson’s correlation coefficients, and related p-values, without ABS values related to 38 kHz.

Eliminating the values of ABS related to the exposure to ultrasound at 38 kHz, it was possible to correct the initial error, related to too strong an influence of 38 kHz against PG. In fact, Table 4.1.7 shows that the correlation of frequency value with the values of PG and BD falls below significance. At the same time, however, it can be pointed out that other factors do not show marked variations in respect of the values of BD, variations that are present for the values of PG (see Table 4.1.6 and 4.1.7). Moreover, without the 38 kHz values there is no correlation between PG and BD appears any more.

ANOVA for the two bacterial state separated with each factors was then performed, to find a specific influence that each factor could have on the variables.

First of all PG and BD variation with frequency is analyzed (Fig 4.1.4-4.1.5)

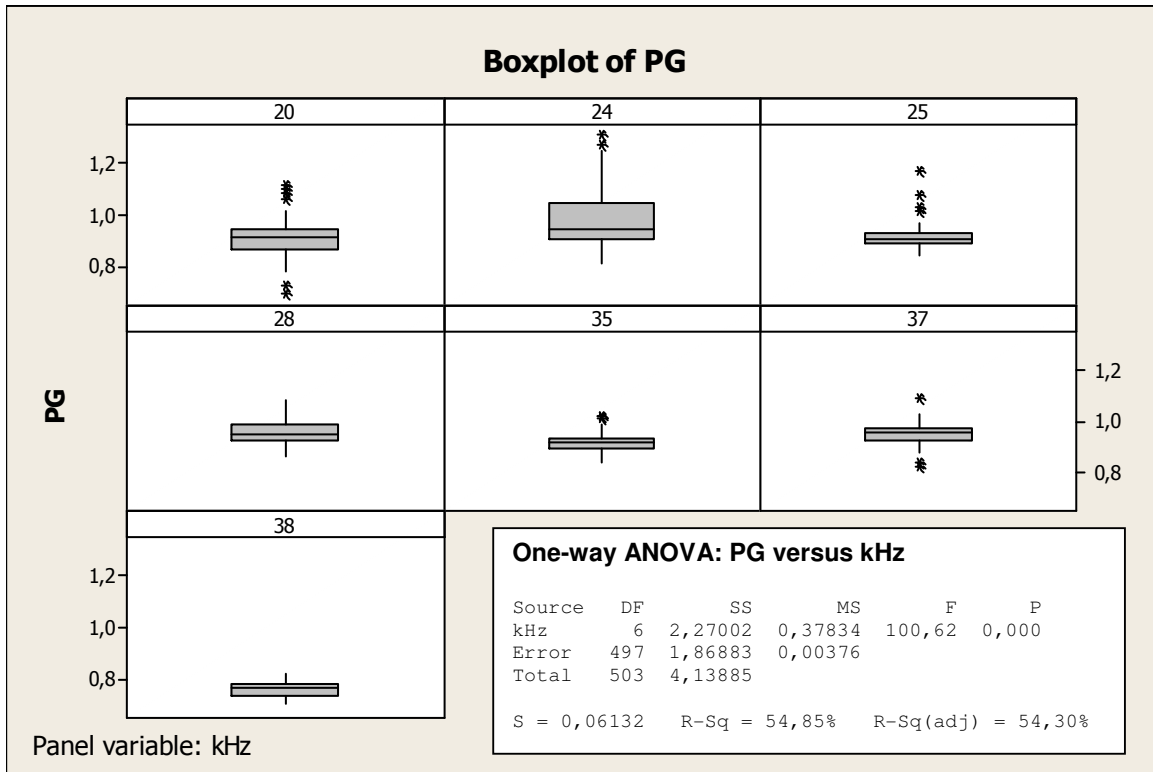

Fig 4.1.4. Boxplots of PG versus frequency (asterisks denote suspected outliers)

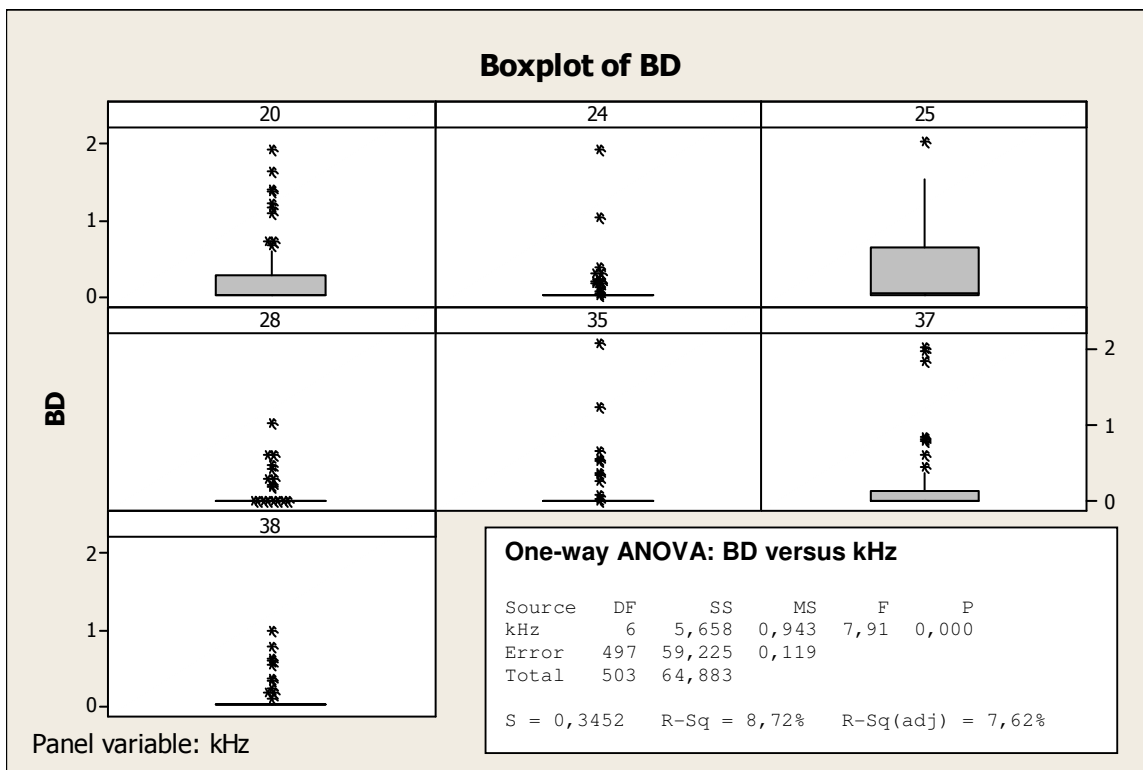

Fig 4.1.5. Boxplots of BD versus frequency (asterisks denote suspected outliers)

The values of BD, as also noted above, tend to decrease with increasing pressure, their analysis is therefore postponed to the subsequent analysis of the factors kPa min, mean and max. The

values of PG seem to be influenced by the frequency applied, with the exclusion of the 38 kHz for which the highest value of pressure seems to overpower the possible effect of frequency. Analyzing frequencies up to 37 kHz it would seem possible to divide the frequency values into two groups on the basis of the values of ABS (Fig 4.1.6-4.1.8).

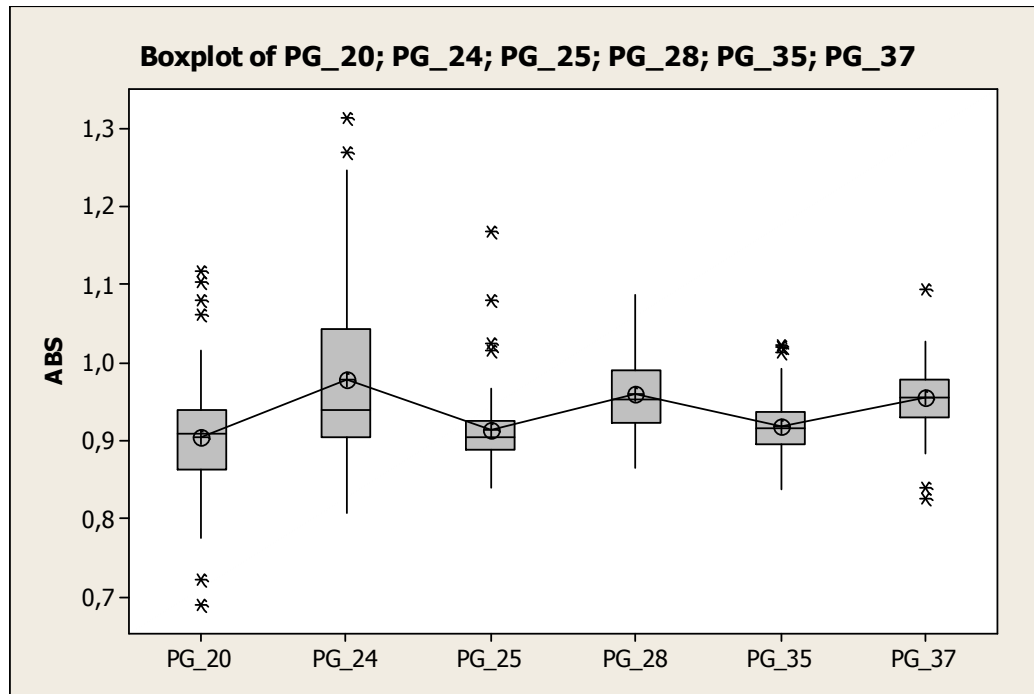

Fig 4.1.6. Boxplots for all the ABS values without those related to the 38 kHz points out to systematic effects; the presence of two group of values is hinted at by the graph.

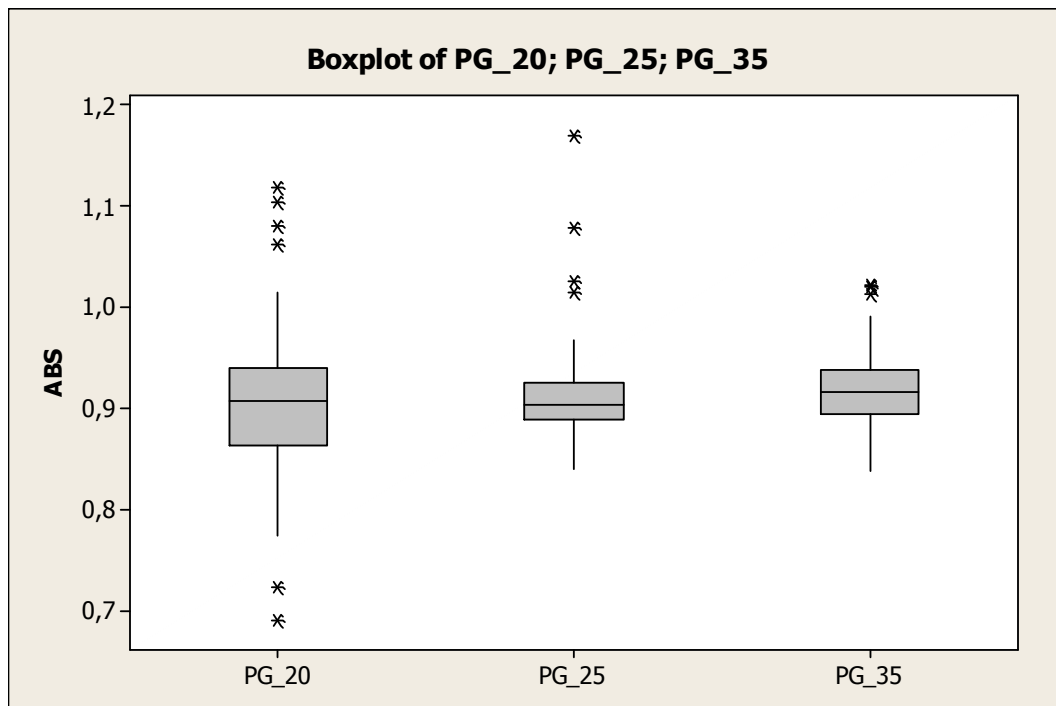

Fig 4.1.7. No significant difference between averages of these three groups appears.

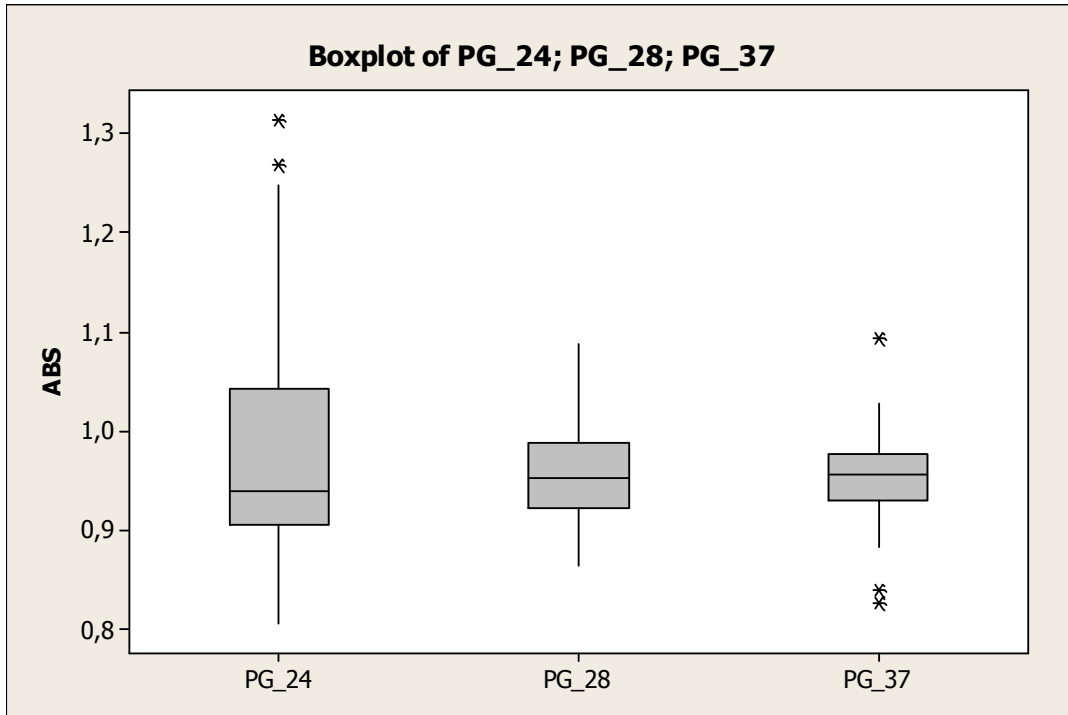
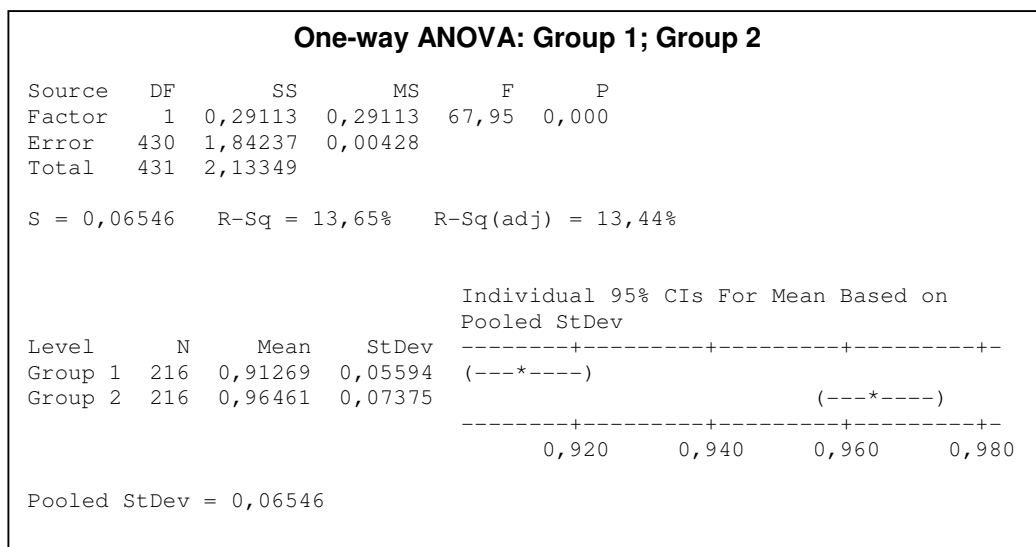

Fig 4.1.8. No significant difference between group averages appears.

Group 1 (20 kHz, 25 kHz and 35 kHz) is represented by ABS mean values near 0.91 while group 2 (24 kHz, 28 kHz and 37 kHz) have ABS mean values near 0.96, with hardly a significant difference.



The same analysis performed for the frequencies was realized for the exposure times (**Fig 4.1.9-4.1.10**).

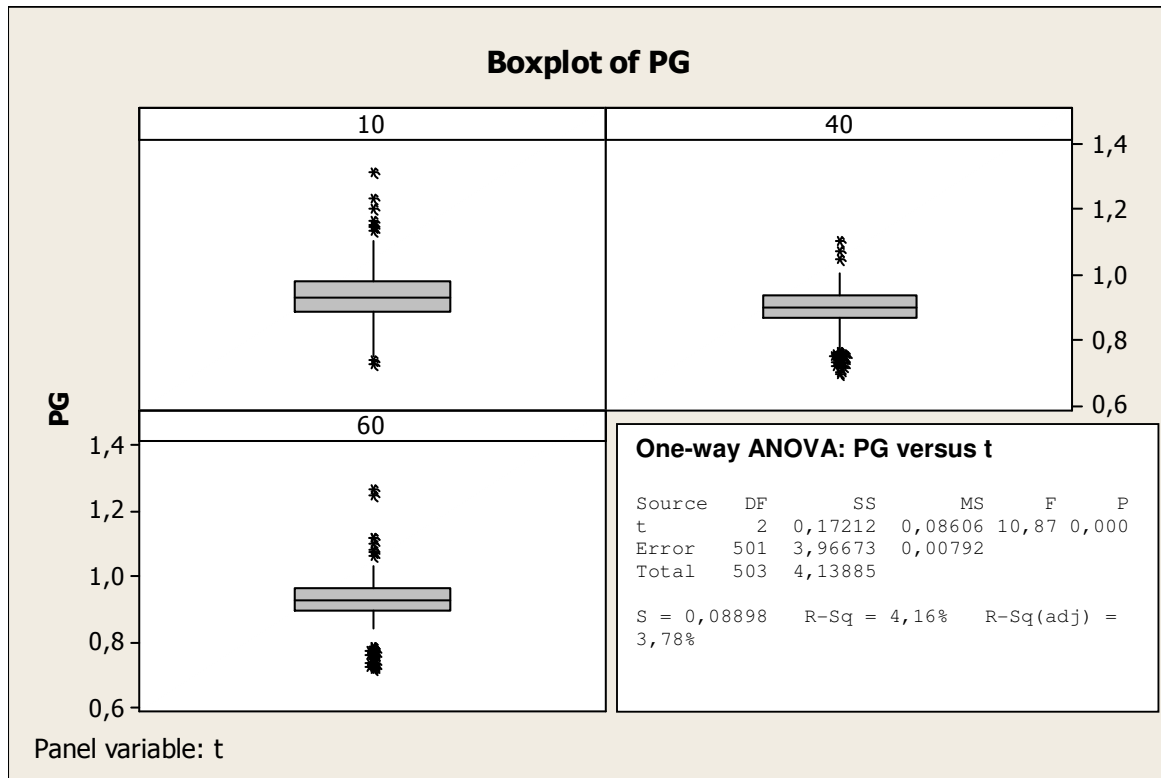

Fig 4.1.9. Boxplots of PG versus exposure time.

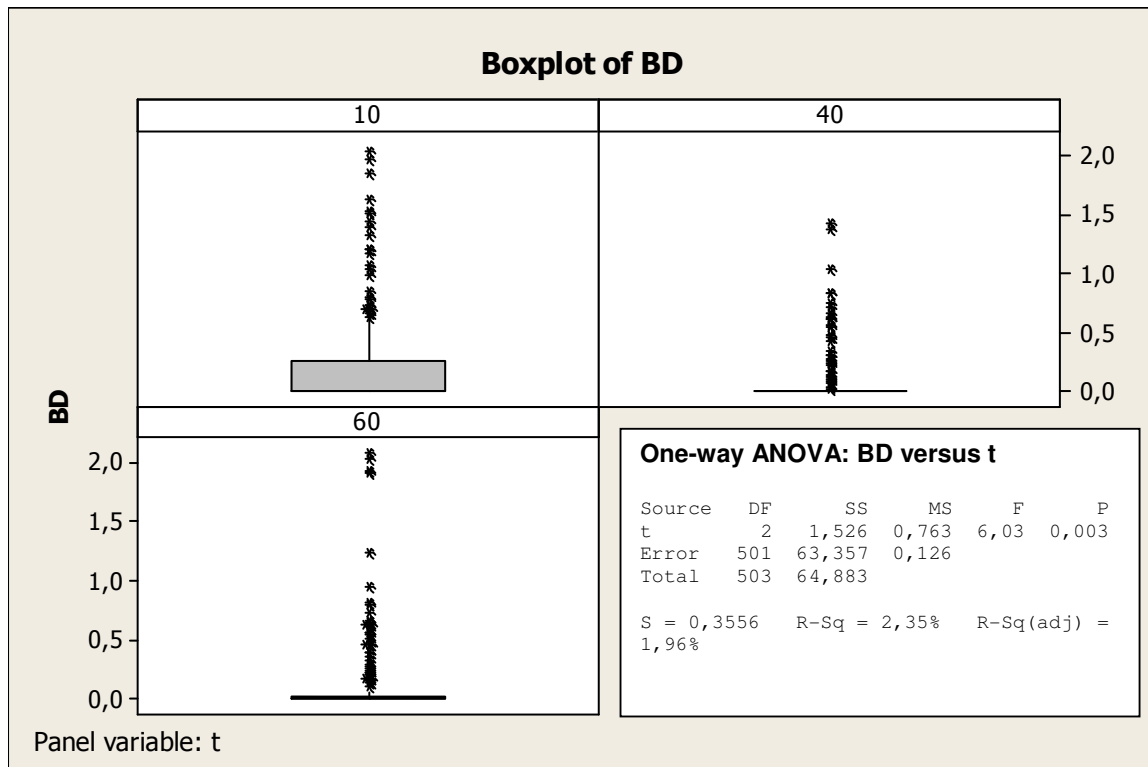

Fig 4.1.10. Boxplots of BD versus exposure time.

Exposure time has a different effect on PG and BD, the former shows a pattern between the values which is maintained for all exposure times tested. Also examining the behavior of the variable according to the change of frequency can be identified as the relationships identified above (see **Fig 4.1.6-4.1.8**) and the two groups found previously are no longer identifiable (**Fig 4.1.11-4.1.13**).

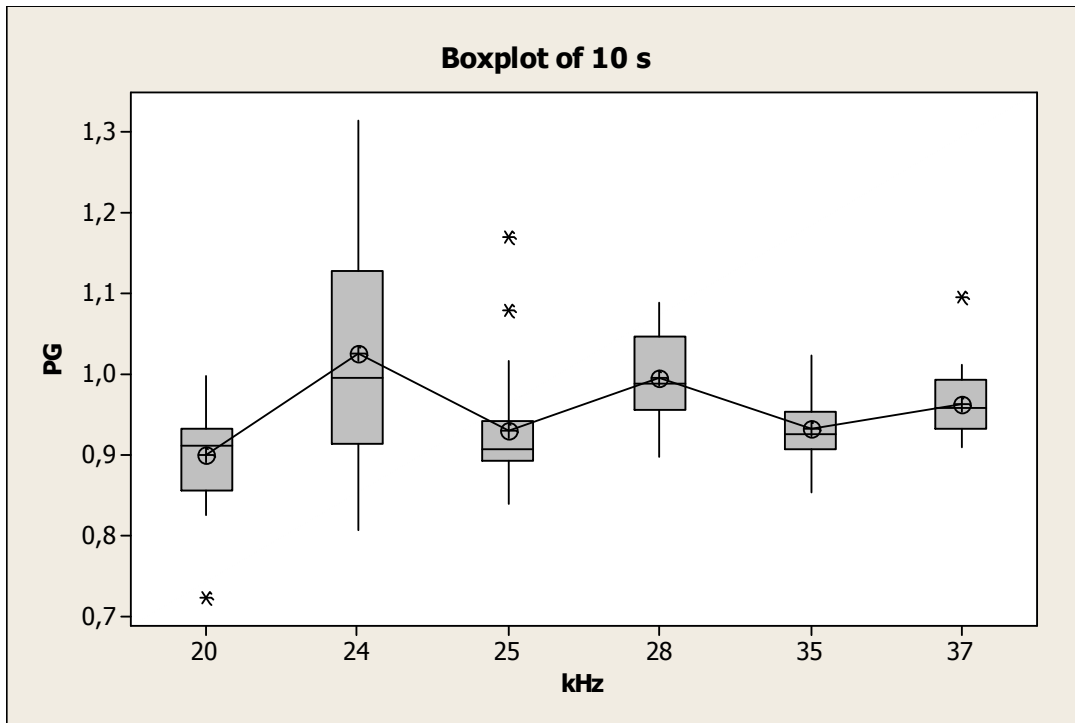
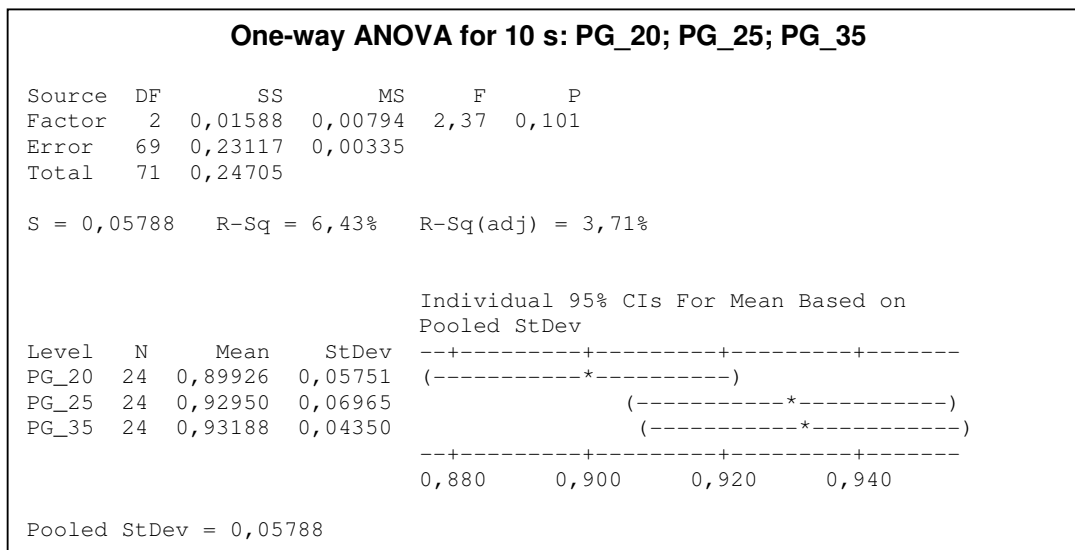

Fig 4.1.11. Boxplots of PG values after 10 seconds of exposure time at the different frequencies. (p-value <0,0005)



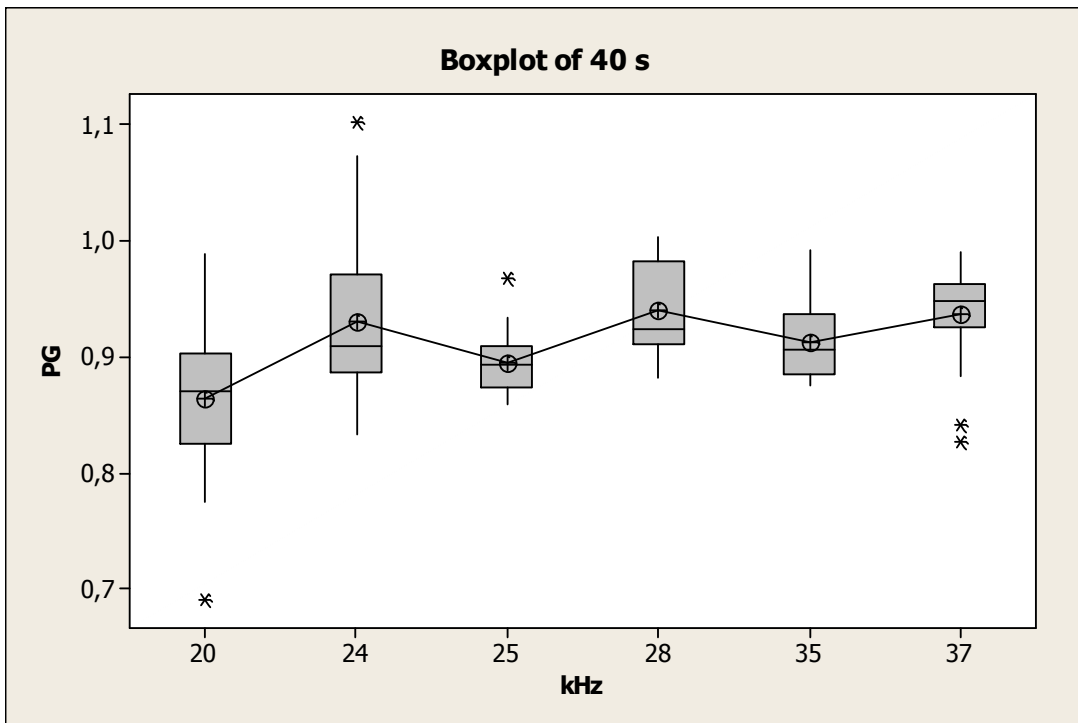
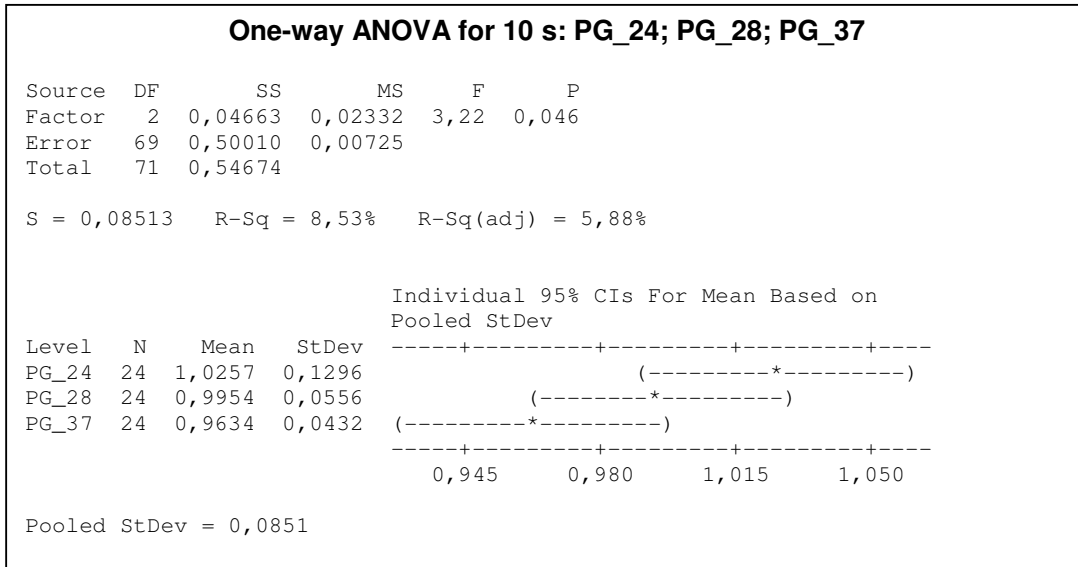

Fig 4.1.12. Boxplots of PG values after 40 seconds of exposure time at the different frequencies. (p-value <0,0005)



One-way ANOVA for 40 s: PG_20; PG_25; PG_35

Source	DF	SS	MS	F	P
Factor	2	0,02904	0,01452	7,17	0,001
Error	69	0,13975	0,00203		
Total	71	0,16879			

S = 0,04500 R-Sq = 17,20% R-Sq(adj) = 14,80%

Individual 95% CIs For Mean Based on Pooled StDev

Level	N	Mean	StDev	CI Lower	CI Upper
PG_20	24	0,86383	0,06747	0,850	0,875
PG_25	24	0,89484	0,02469	0,875	0,900
PG_35	24	0,91241	0,03023	0,900	0,925

Pooled StDev = 0,04500

One-way ANOVA for 40 s: PG_24; PG_28; PG_37

Source	DF	SS	MS	F	P
Factor	2	0,00095	0,00048	0,19	0,828
Error	69	0,17321	0,00251		
Total	71	0,17416			

S = 0,05010 R-Sq = 0,55% R-Sq(adj) = 0,00%

Individual 95% CIs For Mean Based on Pooled StDev

Level	N	Mean	StDev	CI Lower	CI Upper
PG_24	24	0,93067	0,06786	0,915	0,930
PG_28	24	0,93950	0,03597	0,930	0,945
PG_37	24	0,93607	0,04041	0,930	0,960

Pooled StDev = 0,05010

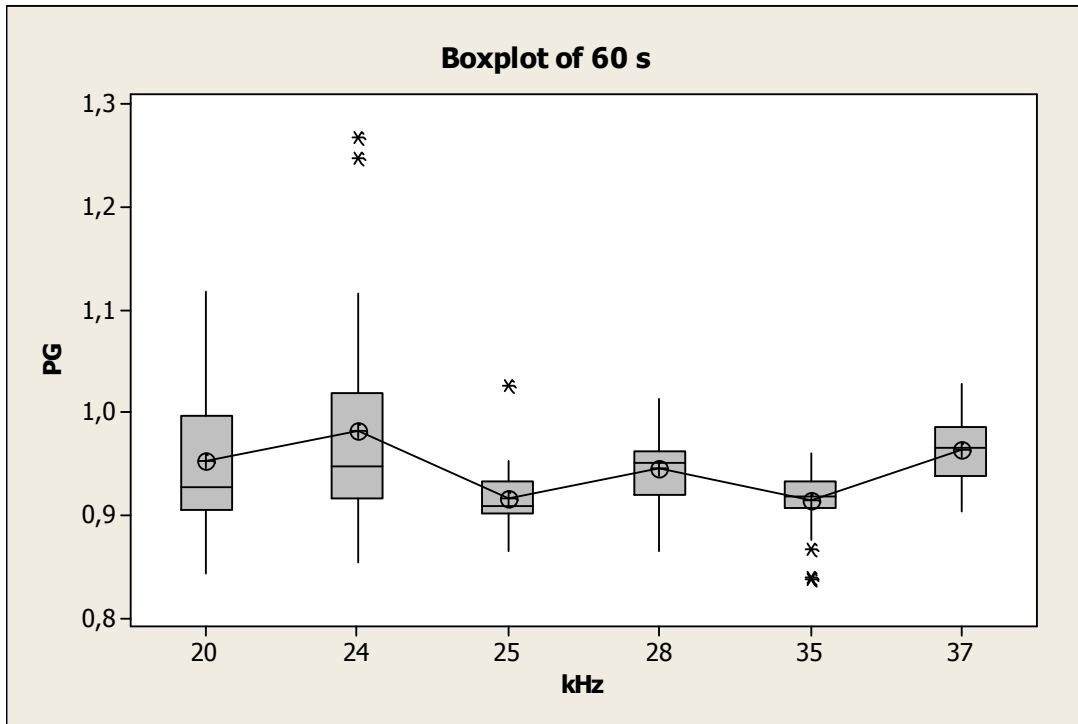

Fig 4.1.13. Boxplots of PG values after 60 seconds of exposure time at the different frequencies. (p-value <0,0005)

One-way ANOVA for 60 s: PG_20; PG_25; PG_35

Source	DF	SS	MS	F	P
Factor	2	0,02379	0,01189	4,62	0,013
Error	69	0,17755	0,00257		
Total	71	0,20134			

S = 0,05073 R-Sq = 11,81% R-Sq(adj) = 9,26%

Level	N	Mean	StDev
PG_20	24	0,95316	0,07504
PG_25	24	0,91580	0,03268
PG_35	24	0,91351	0,03195

Individual 95% CIs For Mean Based on Pooled StDev

Pooled StDev = 0,05073

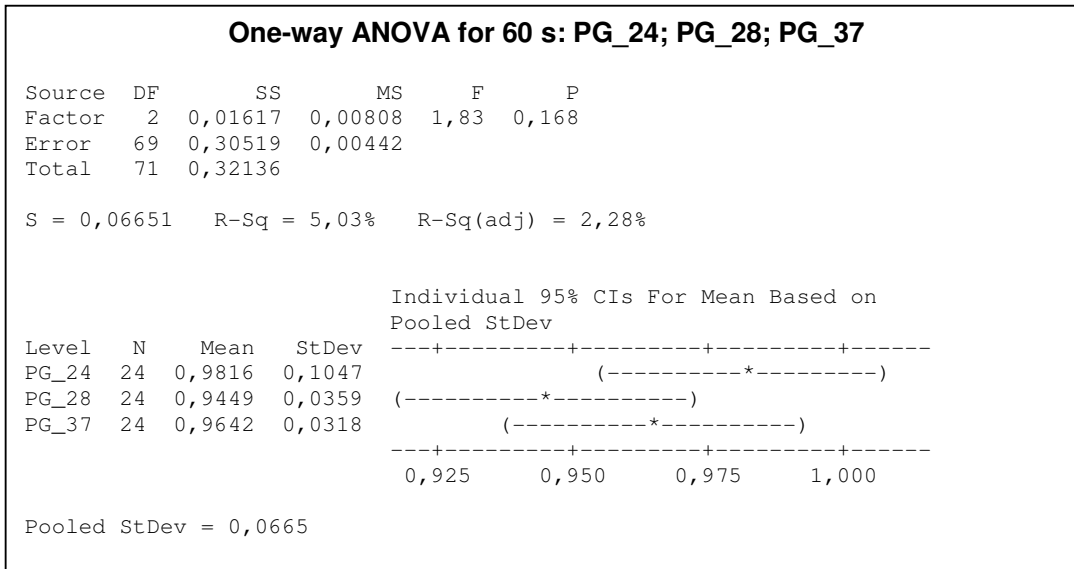

BD shows instead an effect of sound pressure that reflects what has been seen previously only in the 10 seconds of exposure; in 40 and 60 seconds almost all values tend to 0 losing that trend. ANOVA shows a statistical significance only for the values relating to 10 seconds of exposure.

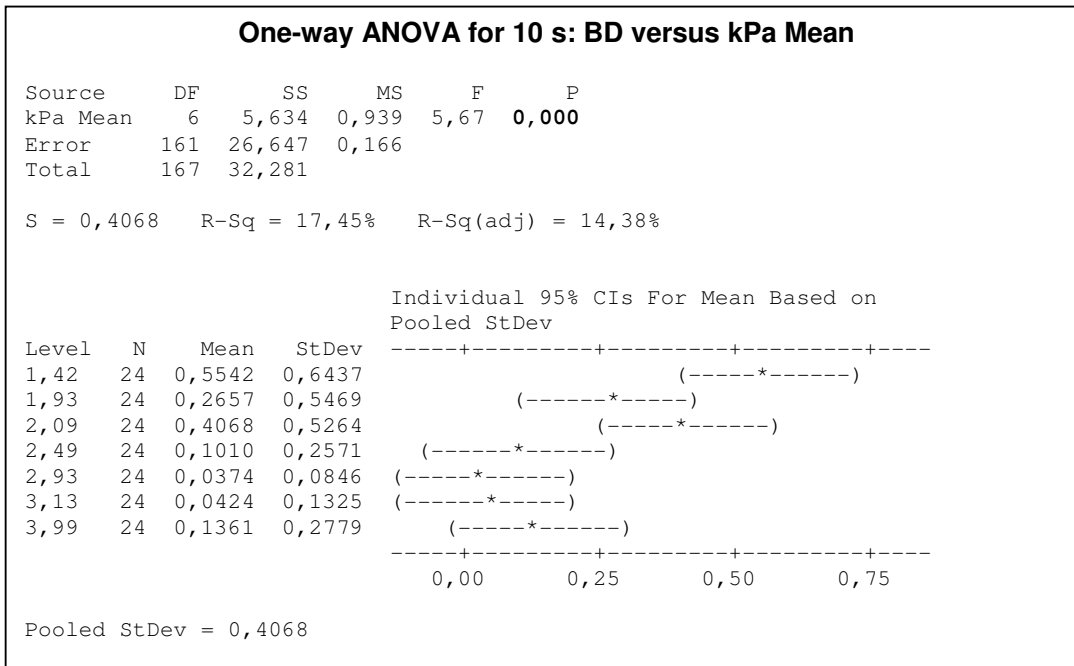

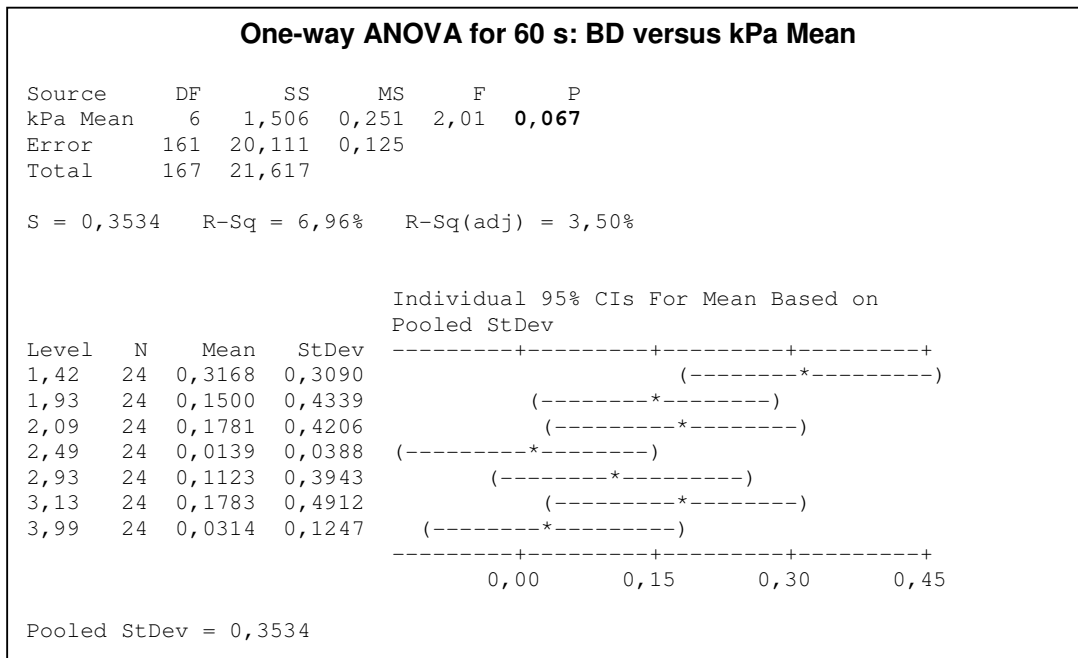
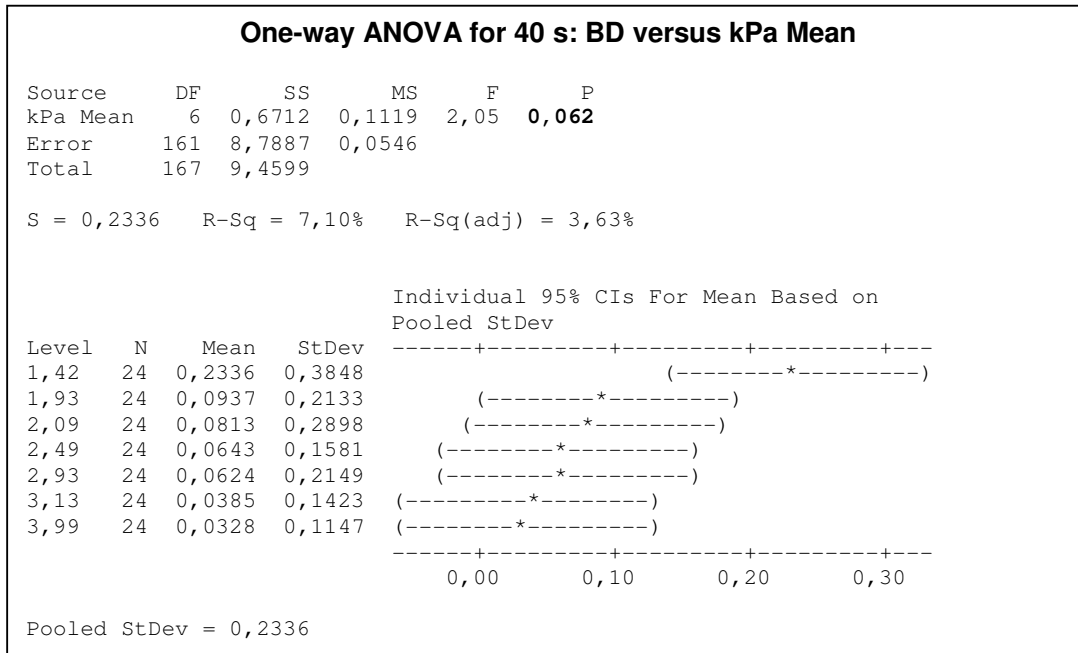

The values of ABS were normalized according to the values of kPa min, kPa mean and kPa max for both PG and BD, to enable analysis on the influence of pressure values on other factors (Table 4.1.8).



Frequency (kHz)	Exposure time (t)	BD/kPa Min	BD/kPa Mean	BD/kPa Max	PG/kPa Mean	PG/kPa Max	PG/kPa Min
20	10	0,33	0,20	0,14	0,43	0,31	0,73
24		0,03	0,01	0,01	0,35	0,24	0,68
25		1,20	0,39	0,23	0,65	0,39	2,02
28		0,06	0,04	0,03	0,40	0,30	0,62
35		0,03	0,01	0,01	0,30	0,20	0,62
37		0,26	0,14	0,10	0,50	0,34	0,94
38		0,08	0,04	0,02	0,20	0,13	0,43
20		40	0,06	0,04	0,03	0,41	0,29
24	0,04		0,02	0,01	0,32	0,21	0,62
25	0,50		0,16	0,10	0,63	0,37	1,93
28	0,04		0,02	0,02	0,38	0,28	0,58
35	0,03		0,01	0,01	0,29	0,19	0,61
37	0,09		0,05	0,03	0,49	0,33	0,92
38	0,02		0,01	0,00	0,19	0,12	0,40
20	60		0,15	0,09	0,06	0,45	0,32
24		0,07	0,04	0,03	0,34	0,23	0,65
25		0,70	0,23	0,13	0,65	0,39	2,00
28		0,01	0,00	0,00	0,38	0,28	0,58
35		0,12	0,06	0,04	0,29	0,19	0,61
37		0,15	0,08	0,05	0,50	0,34	0,95
38		0,02	0,01	0,00	0,19	0,12	0,41

Table 4.1.8. Normalization of ABS values.

4.1.1. Biofilm development

4.1.1.1. Analysis of the acoustic pressure effect

The values of BD, as pointed out earlier, seem to be mainly influenced by the variation of acoustic pressure, on the contrary the frequency factor appears to have a secondary effect while the exposure time factor would seem predominant only from 40 seconds of exposure (**Fig 4.1.1.1-4.1.1.5**).

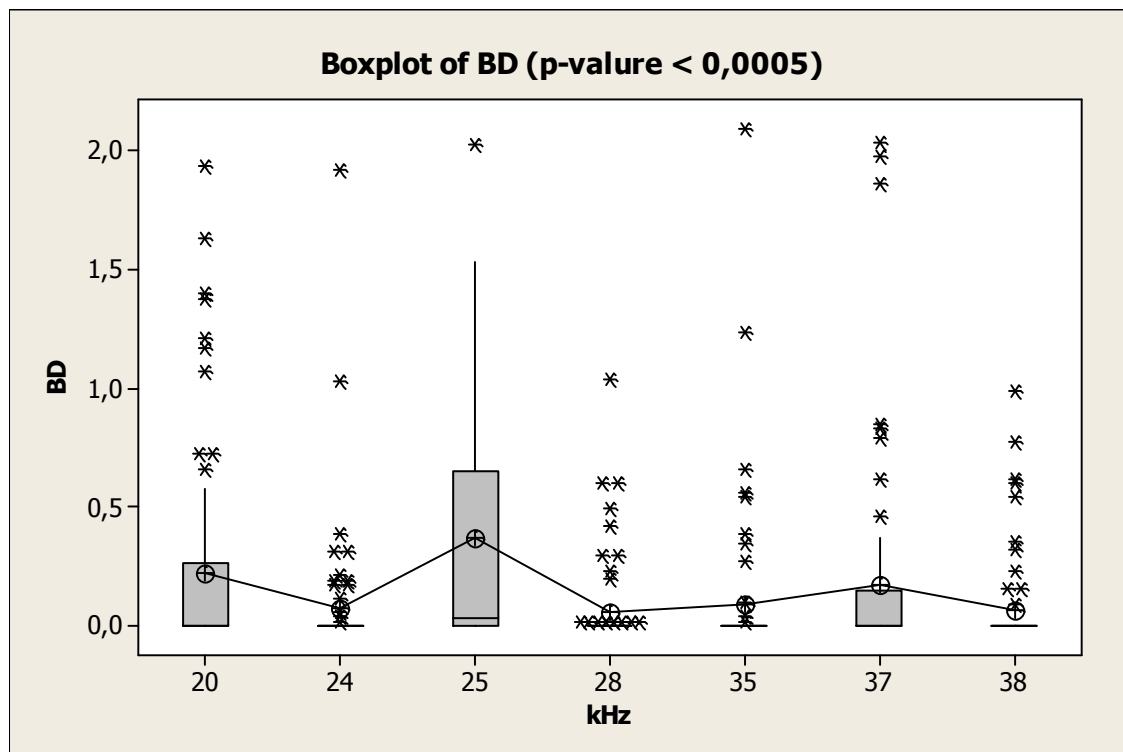

Fig 4.1.1.1. ABS value variation in relation to the different frequency. (p-value related to the ANOVA)

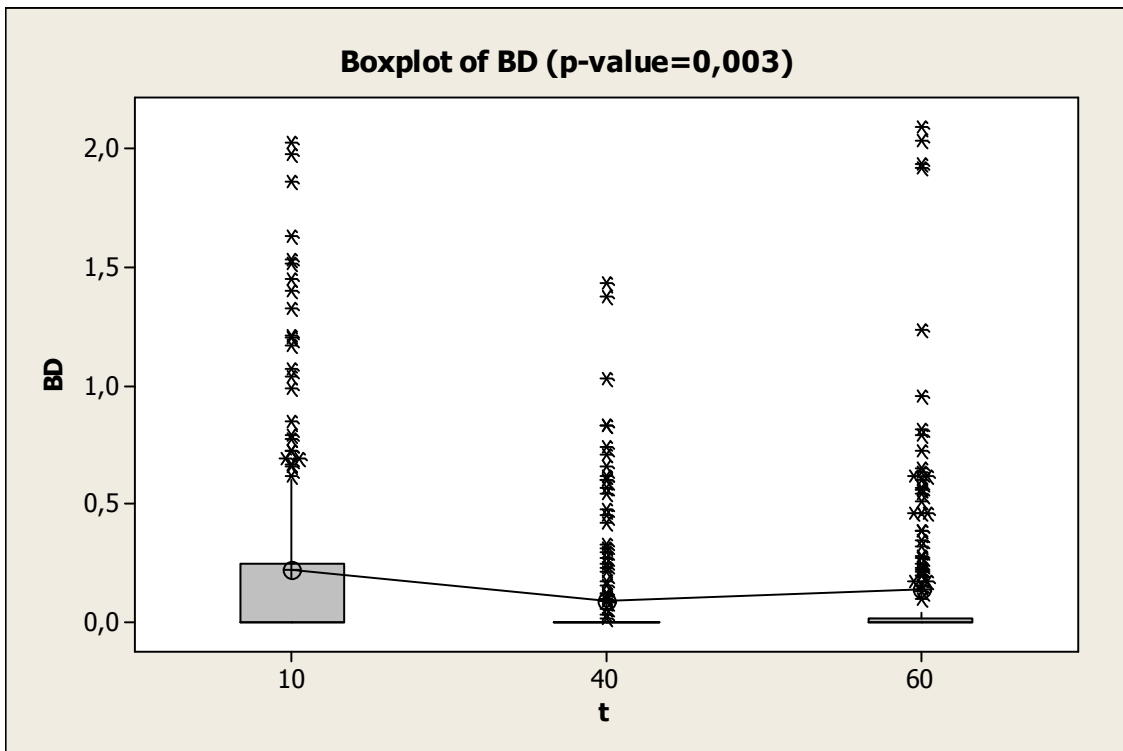

Fig 4.1.1.2. ABS value variation in relation to the different exposure time. (p-value related to the ANOVA)

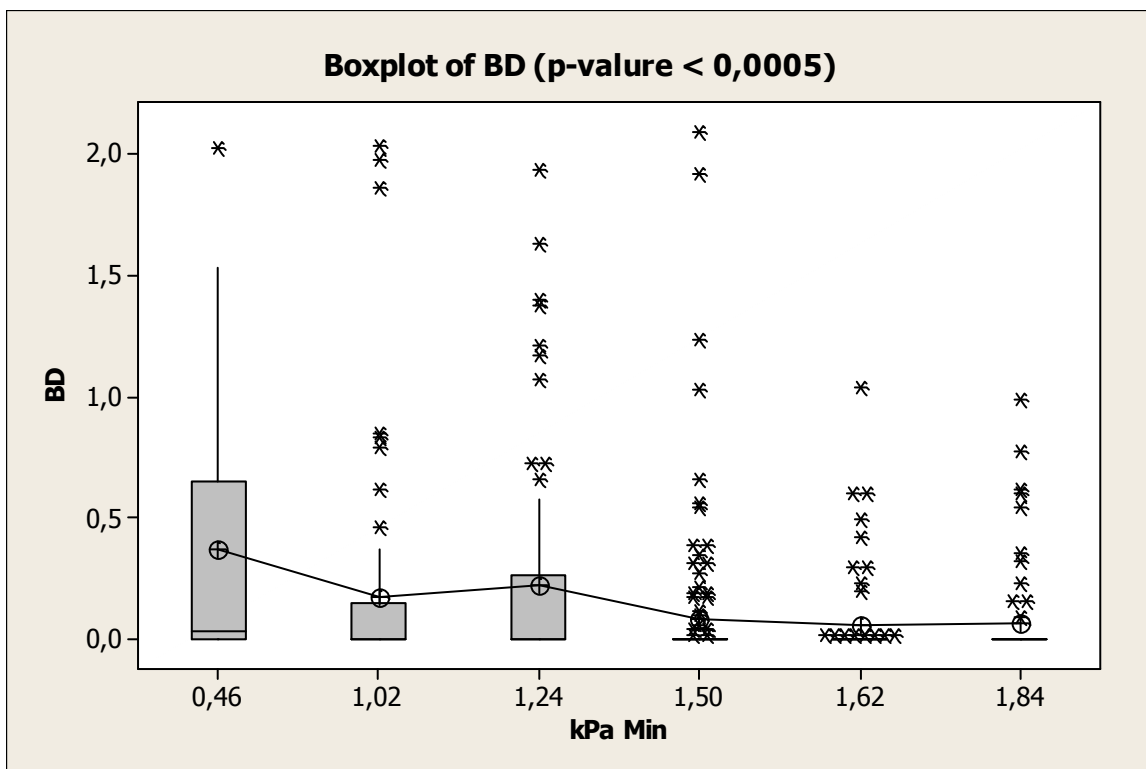

Fig 4.1.1.3. ABS value variation in relation to the different minimum acoustic pressure. (p-value related to the ANOVA)

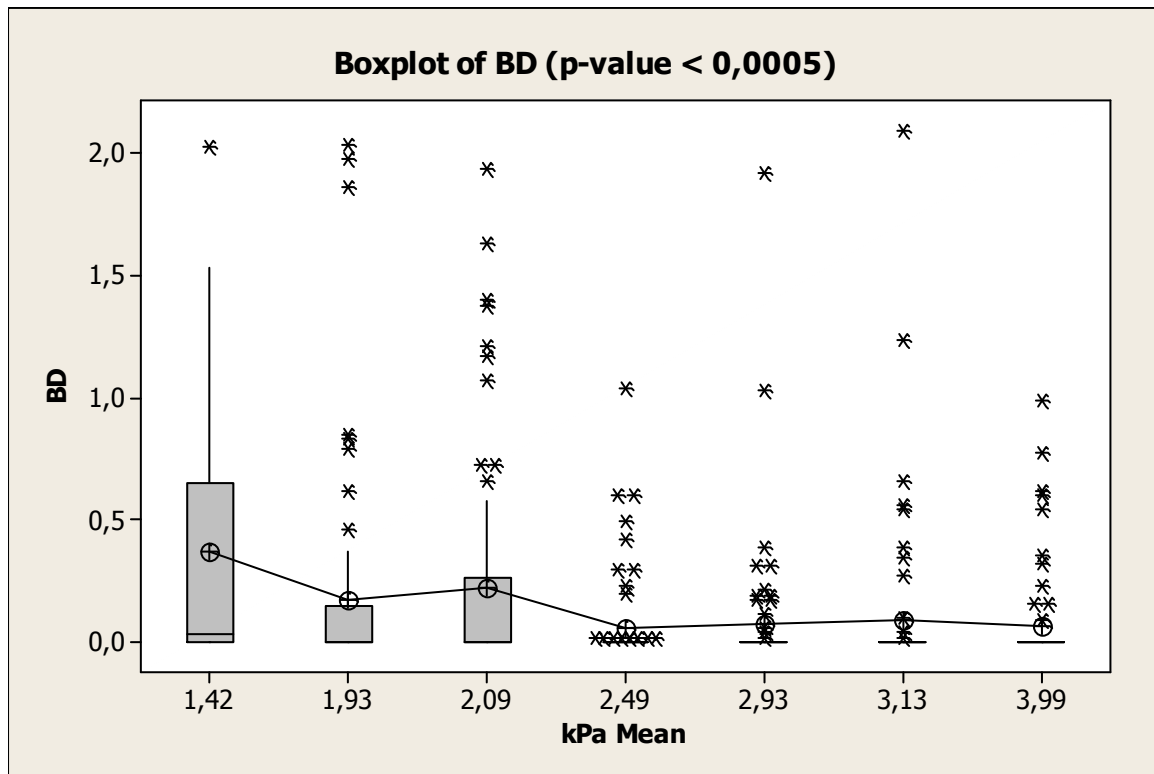

Fig 4.1.1.4. ABS value variation in relation to the different mean acoustic pressure. (p-value related to the ANOVA)

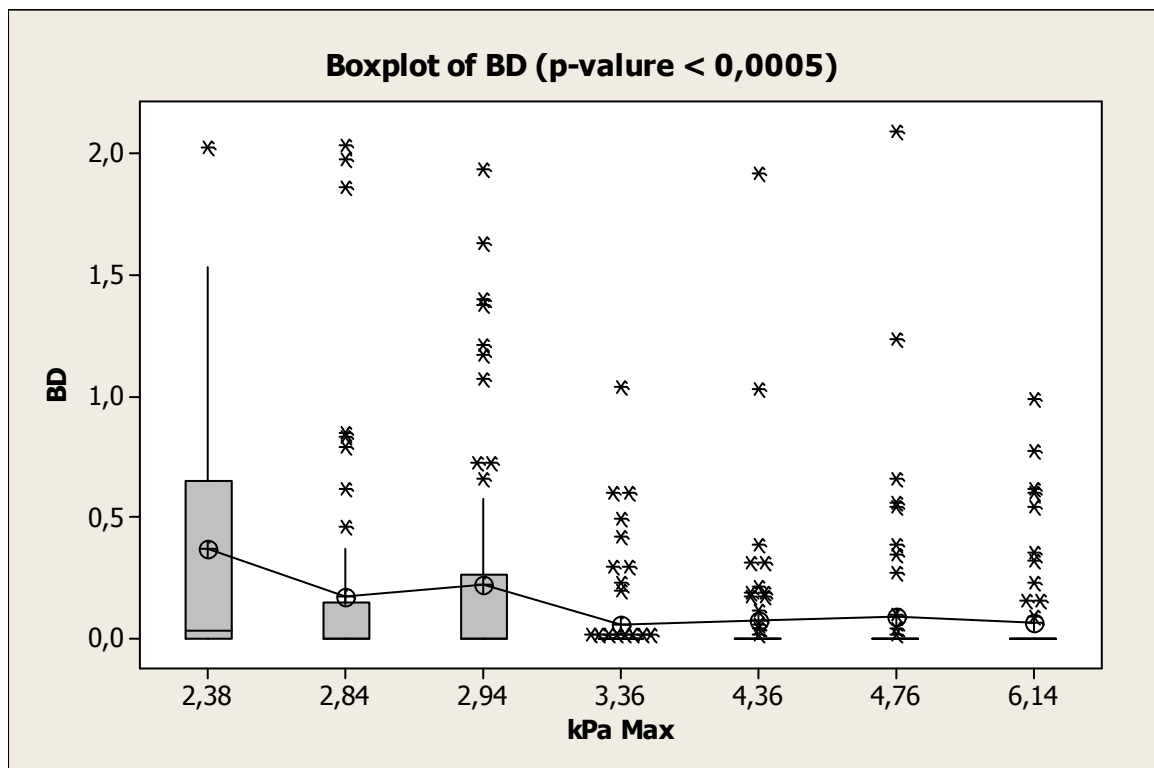

Fig 4.1.1.5. ABS value variation in relation to the different maximum acoustic pressure. (p-value related to the ANOVA)

Before starting with the analysis of the acoustic pressure, a last assessment of the possible interaction between frequency and exposure time (**Fig 4.1.1.6**) was performed by two-way ANOVA.

Source	DF	SS	MS	F	P
kHz	6	5,6582	0,943027	8,20	0,000
t	2	1,5258	0,762914	6,63	0,001
Interaction	12	2,1526	0,179385	1,56	0,100
Error	483	55,5465	0,115003		
Total	503	64,8831			

S = 0,3391 R-Sq = 14,39% R-Sq(adj) = 10,84%

ANOVA shows there's no interaction between that these factors when all the ABS values are examined together.

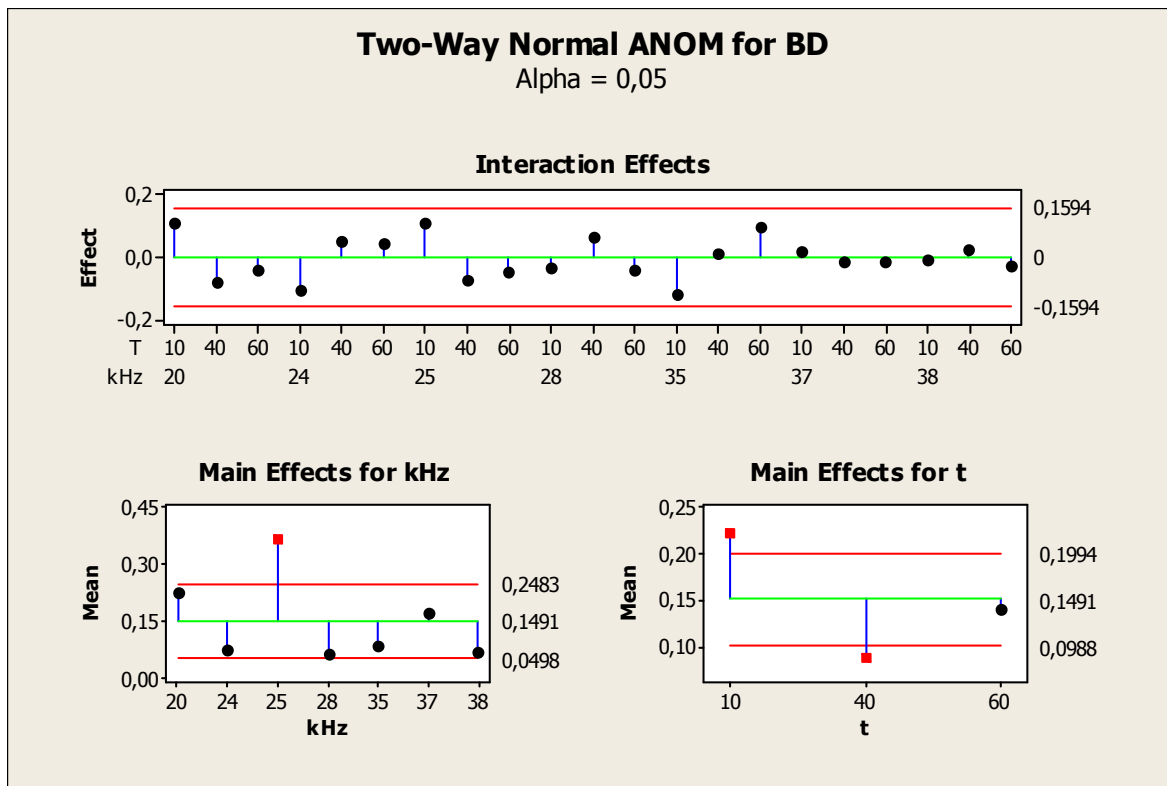

Fig 4.1.1.6. Analysis of interaction between frequency and exposure time on the ABS value of the BD.

To evaluate the influence of acoustic pressure, and to identify interaction of kHz or t factors with BD value if any, a normalization of the variables with the values of kPa min, kPa mean and kPa max was performed (**Table 4.1.1.1-4.1.1.3**).

Variable	Mean	StDev	Minimum	Q1	Median	Q3	Maximum	Range	IQR
BD/kPa min	0,19	0,52	0,00	0,00	0,00	0,02	4,40	4,40	0,021
BD/kPa mean	0,08	0,20	0,00	0,00	0,00	0,01	1,43	1,43	0,010
BD/kPa max	0,05	0,13	0,00	0,00	0,00	0,01	0,85	0,85	0,007

Table 4.1.1.1. BD values normalized for acoustic pressure values

Variable	kHz	Mean	StDev	Minimum	Q1	Median	Q3	Maximum	Range	IQR
BD/kPa min	20	0,18	0,35	0,00	0,00	0,00	0,21	1,56	1,56	0,210
	24	0,05	0,17	0,00	0,00	0,00	0,00	1,27	1,27	0,000
	25	0,80	1,05	0,00	0,00	0,07	1,40	4,40	4,40	1,404
	28	0,04	0,11	0,00	0,00	0,00	0,00	0,64	0,64	0,000
	35	0,06	0,21	0,00	0,00	0,00	0,00	1,39	1,39	0,000
	37	0,17	0,41	0,00	0,00	0,00	0,14	1,99	1,99	0,145
BD/kPa mean	38	0,04	0,10	0,00	0,00	0,00	0,00	0,54	0,54	0,000
	20	0,11	0,21	0,00	0,00	0,00	0,12	0,92	0,92	0,125
	24	0,02	0,09	0,00	0,00	0,00	0,00	0,65	0,65	0,000
	25	0,26	0,34	0,00	0,00	0,02	0,45	1,43	1,43	0,455
	28	0,02	0,07	0,00	0,00	0,00	0,00	0,42	0,42	0,000
	35	0,03	0,10	0,00	0,00	0,00	0,00	0,67	0,67	0,000
BD/kPa max	37	0,09	0,22	0,00	0,00	0,00	0,08	1,05	1,05	0,076
	38	0,02	0,05	0,00	0,00	0,00	0,00	0,25	0,25	0,000
	20	0,08	0,15	0,00	0,00	0,00	0,09	0,66	0,66	0,089
	24	0,02	0,06	0,00	0,00	0,00	0,00	0,44	0,44	0,000
	25	0,15	0,20	0,00	0,00	0,01	0,27	0,85	0,85	0,271
	28	0,02	0,05	0,00	0,00	0,00	0,00	0,31	0,31	0,000
BD/kPa min	35	0,02	0,06	0,00	0,00	0,00	0,00	0,44	0,44	0,000
	37	0,06	0,15	0,00	0,00	0,00	0,05	0,71	0,71	0,052
	38	0,01	0,03	0,00	0,00	0,00	0,00	0,16	0,16	0,000

Table 4.1.1.2. BD values normalized for the values of acoustic pressure and divided by frequency

Variable	T	Mean	StDev	Minimum	Q1	Median	Q3	Maximum	Range	IQR
BD/kPa min	10	0,28	0,70	0,00	0,00	0,00	0,19	4,40	4,40	0,186
	40	0,11	0,38	0,00	0,00	0,00	0,00	3,10	3,10	0,000
	60	0,17	0,42	0,00	0,00	0,00	0,01	2,07	2,07	0,011
BD/kPa mean	10	0,12	0,26	0,00	0,00	0,00	0,10	1,43	1,43	0,097
	40	0,05	0,14	0,00	0,00	0,00	0,00	1,00	1,00	0,000
	60	0,07	0,17	0,00	0,00	0,00	0,01	1,05	1,05	0,007
BD/kPa max	10	0,08	0,16	0,00	0,00	0,00	0,07	0,85	0,85	0,067
	40	0,03	0,09	0,00	0,00	0,00	0,00	0,60	0,60	0,000
	60	0,05	0,11	0,00	0,00	0,00	0,01	0,71	0,71	0,005

Table 4.1.1.3. BD values normalized for the values of acoustic pressure and divided by exposure time

Variability, indicated by IQR, is greater for the minimum pressure and decreases while passing to the median pressure and the maximum pressure. When the pressure is greater, this factor becomes dominant over the others; other factors are analyzed in relation to the normalized values with a specific attention about the minimum pressure (Fig 4.1.1.8-4.1.1.11).

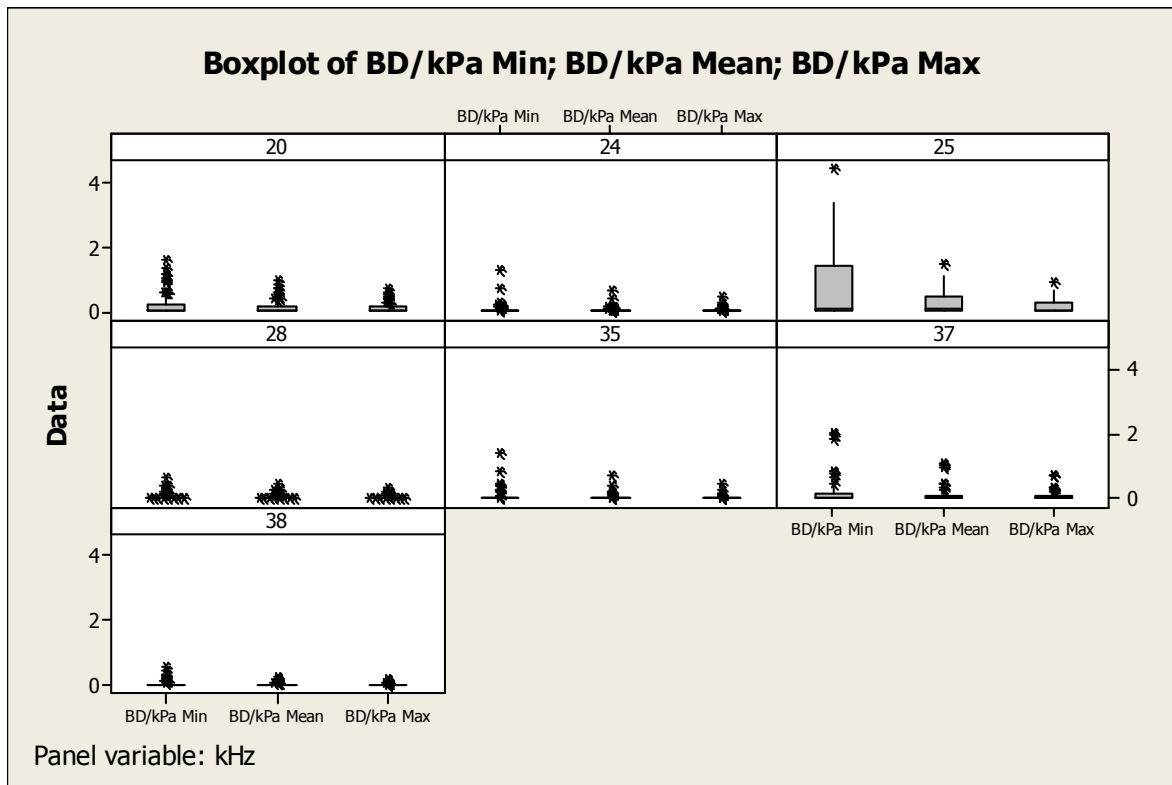

Fig 4.1.1.8. Distribution of BD normalized values by frequency

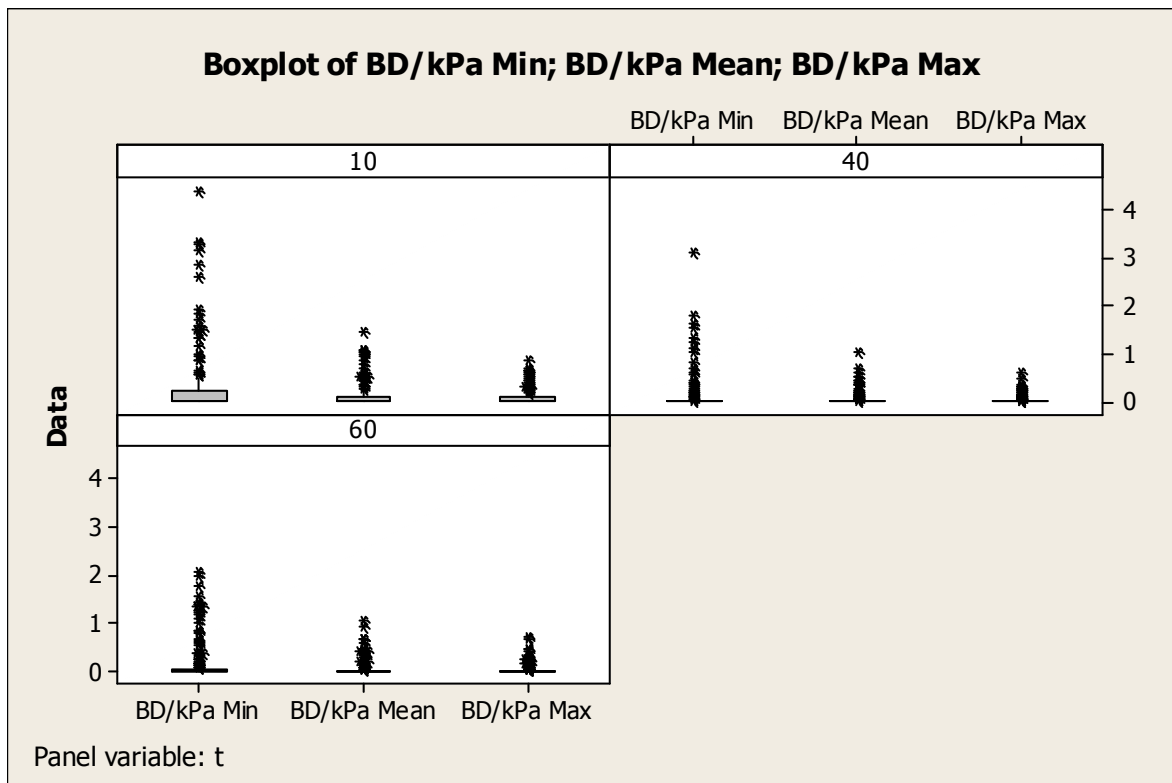

Fig 4.1.1.9. Distribution of BD normalized values by exposure time

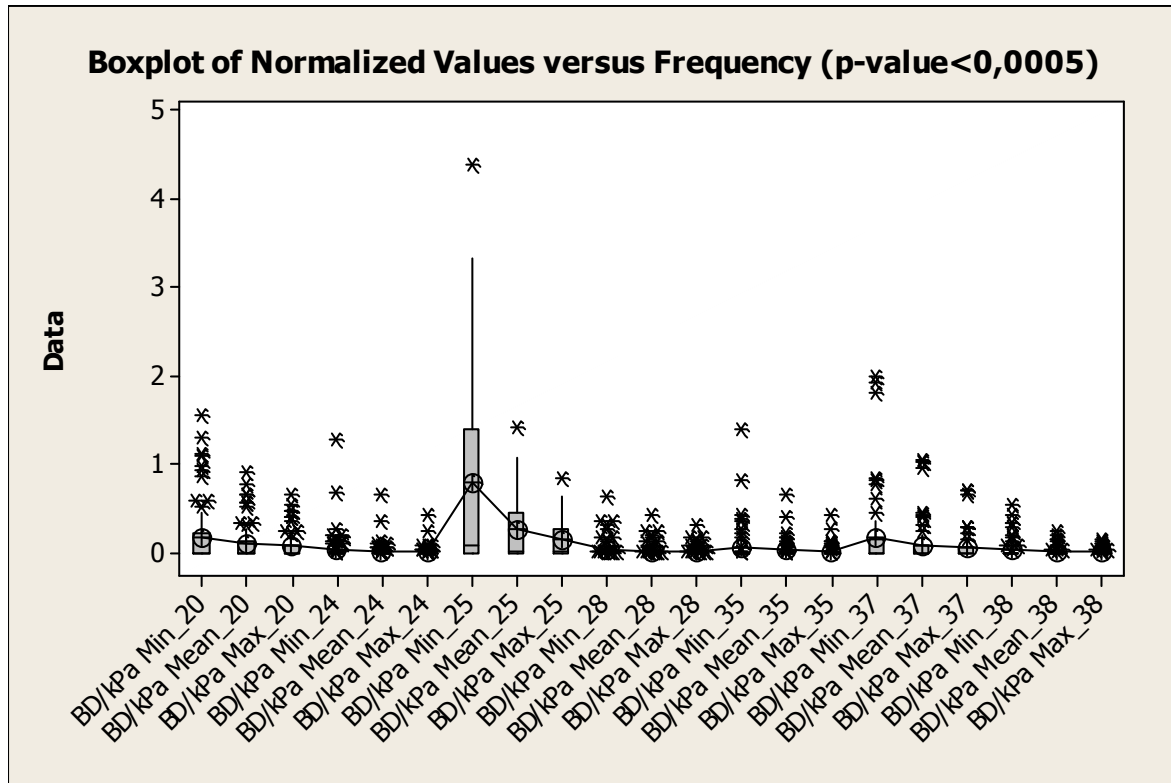

Fig 4.1.1.10. Boxplots for the general variance of the BD normalized values versus the different frequencies.

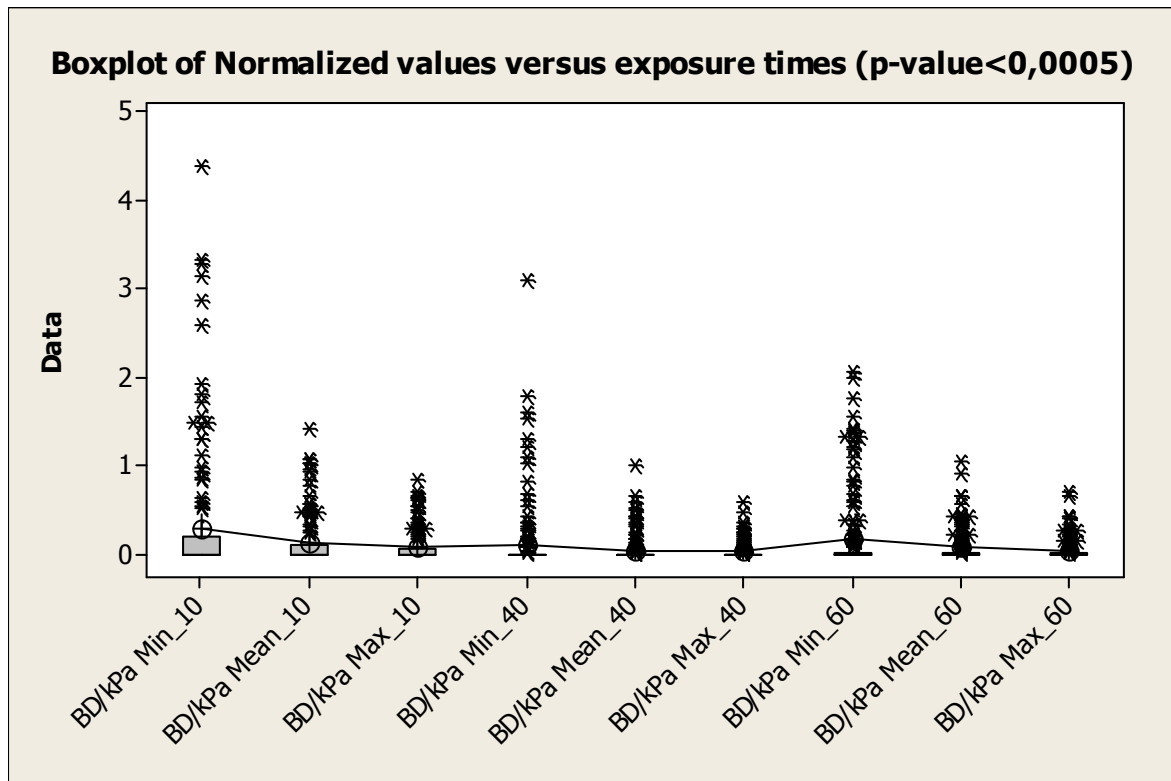

Fig 4.1.1.11. Boxplots for the general variance of the BD normalized values versus the exposure times.

The analysis of interaction between frequency and exposure time was repeated using the BD normalized values one by one as variables. ANOVA highlighted how frequency and exposure time interact at statistically relevant level when analyzed with BD/kPa min (p-value: 0,013), this result becomes less noticeable with the BD/kPa mean (p-value: 0,048), and statistically irrelevant with the BD/kPa max (p-value: 0,060) (Fig 4.1.1.12-4.1.1.14).

Two-way ANOVA: BD/kPa Min versus kHz; t					
Source	DF	SS	MS	F	P
kHz	6	32,994	5,49893	27,14	0,000
t	2	2,520	1,26010	6,22	0,002
Interaction	12	5,239	0,43659	2,15	0,013
Error	483	97,855	0,20260		
Total	503	138,608			

S = 0,4501 R-Sq = 29,40% R-Sq(adj) = 26,48%

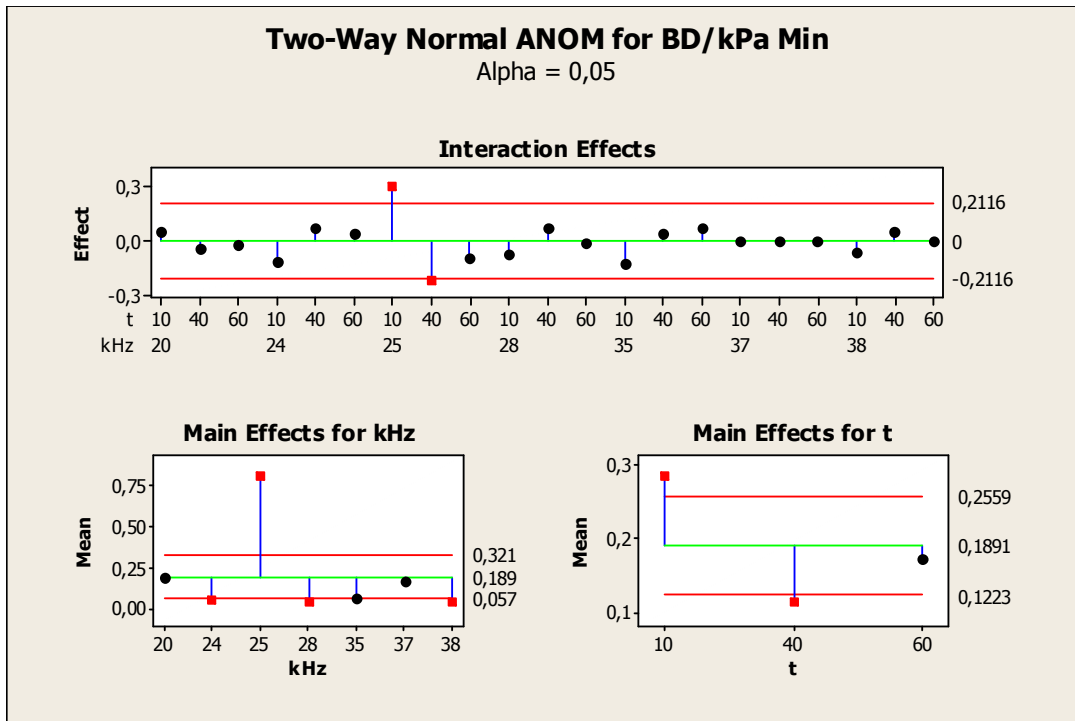

Fig 4.1.1.12. Interaction between frequency and exposure time using as variable BD/kPa min

Two-way ANOVA: BD/kPa Mean versus kHz; t					
Source	DF	SS	MS	F	P
kHz	6	3,3027	0,550452	17,33	0,000
t	2	0,4490	0,224510	7,07	0,001
Interaction	12	0,6810	0,056754	1,79	0,048
Error	483	15,3380	0,031756		
Total	503	19,7708			

S = 0,1782 R-Sq = 22,42% R-Sq(adj) = 19,21%

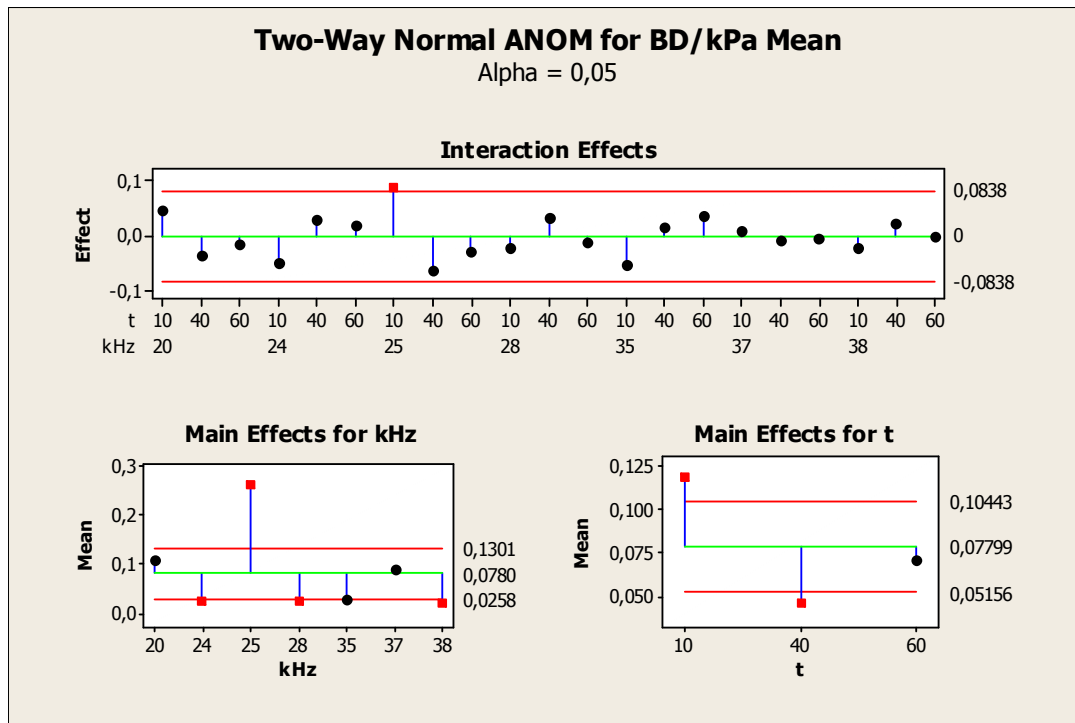

Fig 4.1.1.13. Interaction between frequency and exposure time using as variable BD/kPa mean

Two-way ANOVA: BD/kPa Max versus kHz; t

Source	DF	SS	MS	F	P
kHz	6	1,18309	0,197182	14,85	0,000
t	2	0,19137	0,095686	7,21	0,001
Interaction	12	0,27401	0,022834	1,72	0,060
Error	483	6,41141	0,013274		
Total	503	8,05989			

S = 0,1152 R-Sq = 20,45% R-Sq(adj) = 17,16%

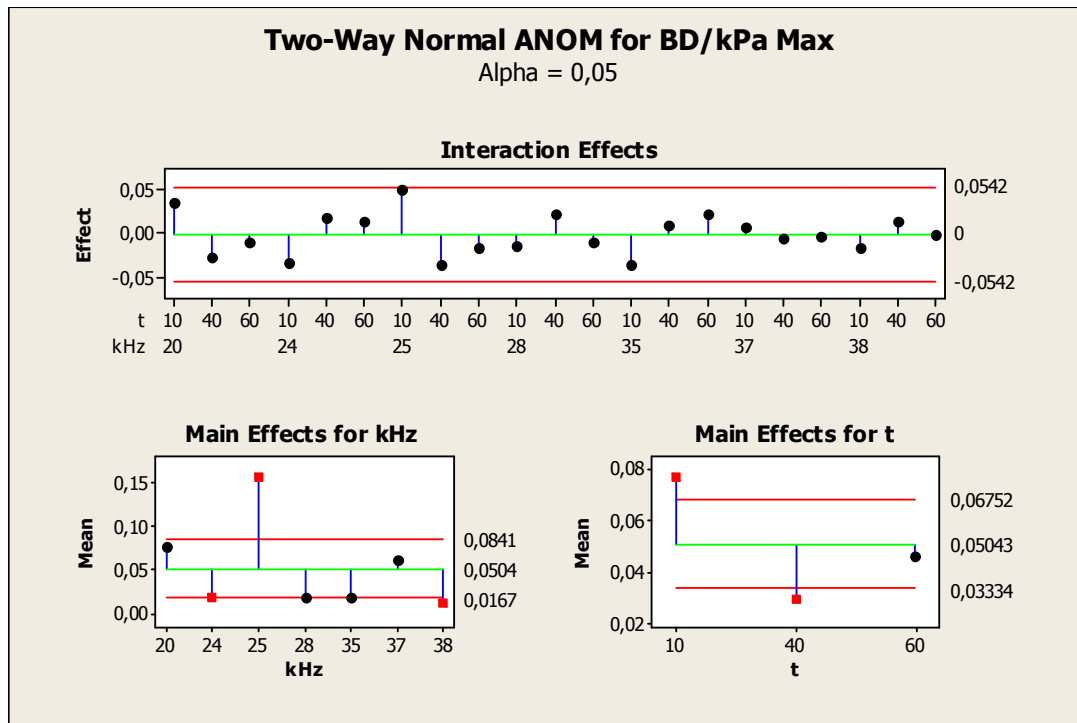

Fig 4.1.1.14. Interaction between frequency and exposure time using as variable BD/kPa max

After these analysis the evaluation was performed frequency by frequency to identify whether there is some kind of trend in relation with each frequency using as variables the BD normalized values and as factor the exposure time.

4.1.1.2. Analysis frequency by frequency

In the analysis of BD acoustic pressure results to have a major role in the general effects described above. In this section we will analyze the frequencies explored one by one to try to detect if there is any kind of trend that goes beyond the simple effect of the pressure (**Fig 4.1.1.2.1-4.1.1.2.7**).

An analysis of the evolution of values of ABS, three main patterns are highlighted (**Fig 4.1.1.2.8**):

- Parabolic (20 kHz, 25 kHz and 37 kHz)
- Constant (24 kHz and 35 kHz)
- Descending (28 kHz and 38 kHz)

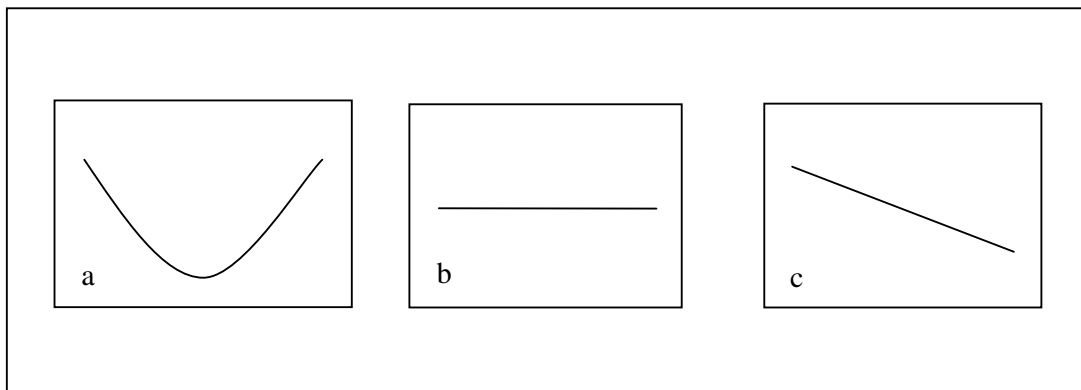

Fig. 4.1.1.2.8. Three different trend identified of the variable depending by the frequency. (a. parabolic, b. constant, c. descending)

The interpretation of these results will be discussed in the chapter 5 (Discussion).

20 kHz
Acoustic Pressure: 2,09 ± 0,85 kPa (1,24 kPa – 2,94 kPa)

Variable	Mean	StDev	Minimum	Q1	Median	Q3	Maximum	Range	IQR	
BD/kPa	Min_20-10	0,33	0,42	0,00	0,00	0,08	0,57	1,32	1,32	0,569
	Mean_20-10	0,19	0,25	0,00	0,00	0,05	0,34	0,78	0,78	0,338
	Max_20-10	0,14	0,18	0,00	0,00	0,04	0,24	0,55	0,55	0,240
	Min_20-40	0,07	0,23	0,00	0,00	0,00	0,00	1,10	1,10	0,000
	Mean_20-40	0,04	0,14	0,00	0,00	0,00	0,00	0,66	0,66	0,000
	Max_20-40	0,03	0,10	0,00	0,00	0,00	0,00	0,47	0,47	0,000
	Min_20-60	0,14	0,34	0,00	0,00	0,00	0,17	1,56	1,56	0,175
	Mean_20-60	0,09	0,20	0,00	0,00	0,00	0,10	0,92	0,92	0,104
Max_20-60	0,06	0,14	0,00	0,00	0,00	0,07	0,66	0,66	0,074	

One-way ANOVA

Source	DF	SS	MS	F	P
Factor	8	1,7419	0,2177	3,66	0,001
Error	207	12,3109	0,0595		
Total	215	14,0528			

S = 0,2439 R-Sq = 12,40% R-Sq(adj) = 9,01%

Pooled StDev = 0,2439

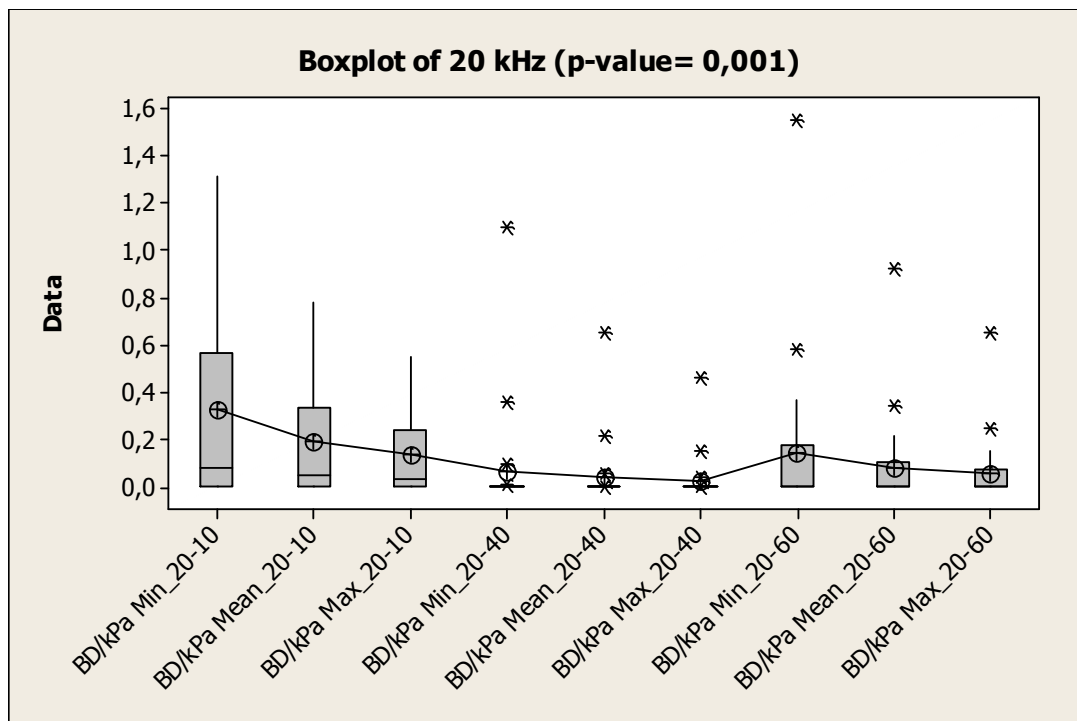

Fig 4.1.1.2.1. Evaluation of BD normalized values for the 20 kHz

24 kHz
Acoustic Pressure: $2,93 \pm 1,43$ kPa (1,5 kPa - 4,36 kPa)

Variable	Mean	StDev	Minimum	Q1	Median	Q3	Maximum	Range	IQR	
BD/kPa	Min_24-10	0,02	0,06	0,00	0,00	0,00	0,00	0,20	0,20	0,000
	Mean_24-10	0,01	0,03	0,00	0,00	0,00	0,00	0,10	0,10	0,000
	Max_24-10	0,01	0,02	0,00	0,00	0,00	0,00	0,07	0,07	0,000
	Min_24-40	0,04	0,14	0,00	0,00	0,00	0,00	0,68	0,68	0,000
	Mean_24-40	0,02	0,07	0,00	0,00	0,00	0,00	0,35	0,35	0,000
	Max_24-40	0,01	0,05	0,00	0,00	0,00	0,00	0,23	0,23	0,000
	Min_24-60	0,07	0,26	0,00	0,00	0,00	0,00	1,27	1,27	0,000
	Mean_24-60	0,04	0,13	0,00	0,00	0,00	0,00	0,65	0,65	0,000
	Max_24-60	0,03	0,09	0,00	0,00	0,00	0,00	0,44	0,44	0,000

One-way ANOVA					
Source	DF	SS	MS	F	P
Factor	8	0,0800	0,0100	0,70	0,689
Error	207	2,9463	0,0142		
Total	215	3,0263			

S = 0,1193 R-Sq = 2,64% R-Sq(adj) = 0,00%

Pooled StDev = 0,1193

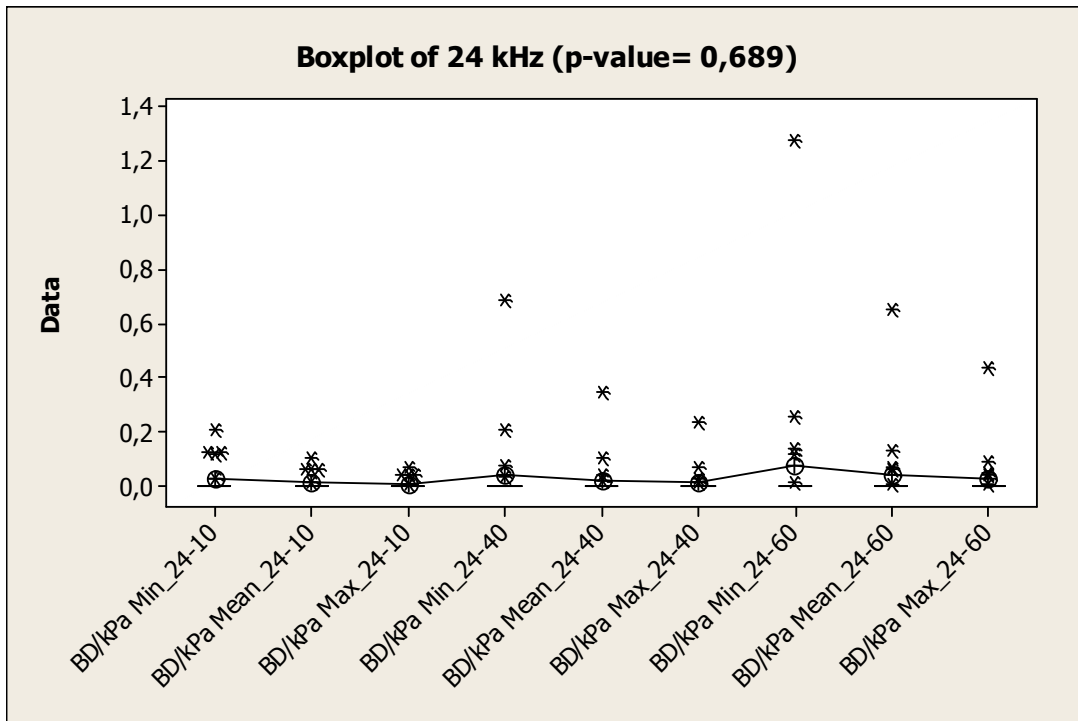

Fig 4.1.1.2.2. Evaluation of BD normalized values for the 24 kHz

25 kHz
Acoustic Pressure: 1,42 ± 0,96 kPa (0,46 kPa - 2,38 kPa)

Variable	Mean	StDev	Minimum	Q1	Median	Q3	Maximum	Range	IQR
BD/kPa	Min_25-10	1,21	1,40	0,00	0,00	0,74	2,38	4,40	2,382
	Mean_25-10	0,39	0,45	0,00	0,00	0,24	0,77	1,43	0,772
	Max_25-10	0,23	0,27	0,00	0,00	0,14	0,46	0,85	0,460
	Min_25-40	0,51	0,84	0,00	0,00	0,00	1,17	3,10	1,174
	Mean_25-40	0,16	0,27	0,00	0,00	0,00	0,38	1,00	0,380
	Max_25-40	0,10	0,16	0,00	0,00	0,00	0,23	0,60	0,227
	Min_25-60	0,69	0,67	0,00	0,00	0,65	1,31	2,07	1,308
	Mean_25-60	0,22	0,22	0,00	0,00	0,21	0,42	0,67	0,424
	Max_25-60	0,13	0,13	0,00	0,00	0,13	0,25	0,40	0,253

Source	DF	SS	MS	F	P
Factor	8	24,468	3,059	7,75	0,000
Error	207	81,686	0,395		
Total	215	106,155			

S = 0,6282 R-Sq = 23,05% R-Sq(adj) = 20,08%

Pooled StDev = 0,6282

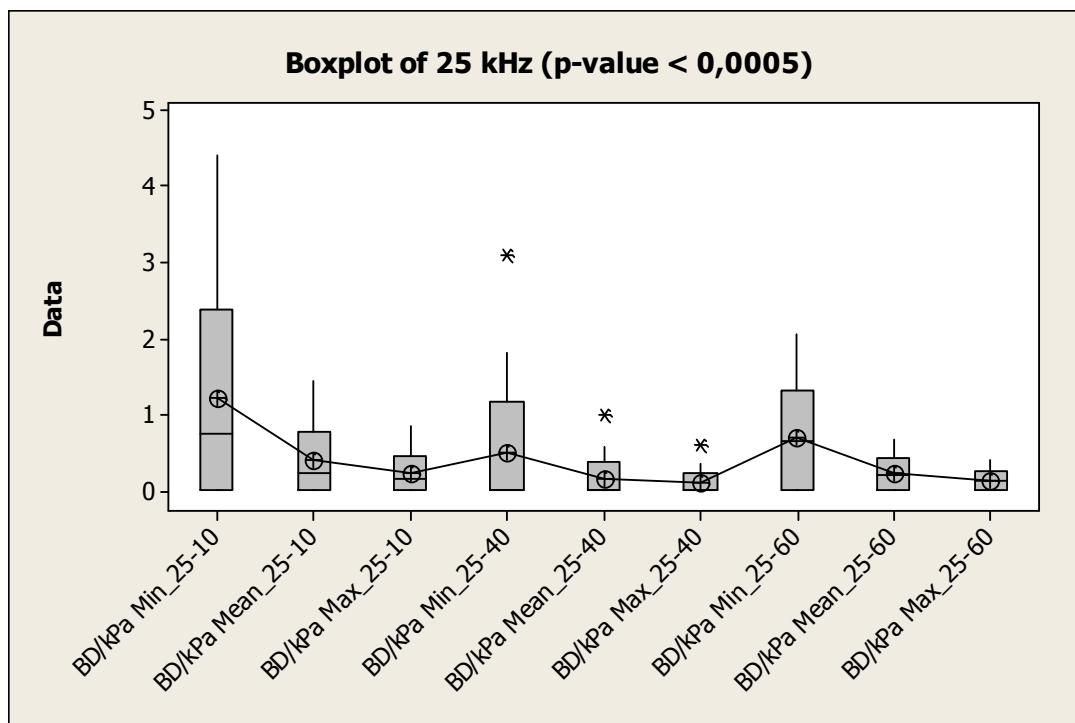

Fig 4.1.1.2.3. Evaluation of BD normalized values for the 25 kHz

28 kHz
Acoustic Pressure: 2,49 ± 0,87 kPa (1,62 kPa - 3,36 kPa)

Variable	Mean	StDev	Minimum	Q1	Median	Q3	Maximum	Range	IQR	
BD/kPa	Min_28-10	0,06	0,16	0,00	0,00	0,00	0,00	0,64	0,64	0,000
	Mean_28-10	0,04	0,10	0,00	0,00	0,00	0,00	0,42	0,42	0,000
	Max_28-10	0,03	0,08	0,00	0,00	0,00	0,00	0,31	0,31	0,000
	Min_28-40	0,04	0,10	0,00	0,00	0,00	0,00	0,37	0,37	0,000
	Mean_28-40	0,03	0,06	0,00	0,00	0,00	0,00	0,24	0,24	0,000
	Max_28-40	0,02	0,05	0,00	0,00	0,00	0,00	0,18	0,18	0,000
	Min_28-60	0,01	0,02	0,00	0,00	0,00	0,01	0,12	0,12	0,011
	Mean_28-60	0,01	0,02	0,00	0,00	0,00	0,01	0,08	0,08	0,007
	Max_28-60	0,00	0,01	0,00	0,00	0,00	0,01	0,06	0,06	0,005

One-way ANOVA

Source	DF	SS	MS	F	P
Factor	8	0,07165	0,00896	1,38	0,207
Error	207	1,34354	0,00649		
Total	215	1,41519			

S = 0,08056 R-Sq = 5,06% R-Sq(adj) = 1,39%

Pooled StDev = 0,08056

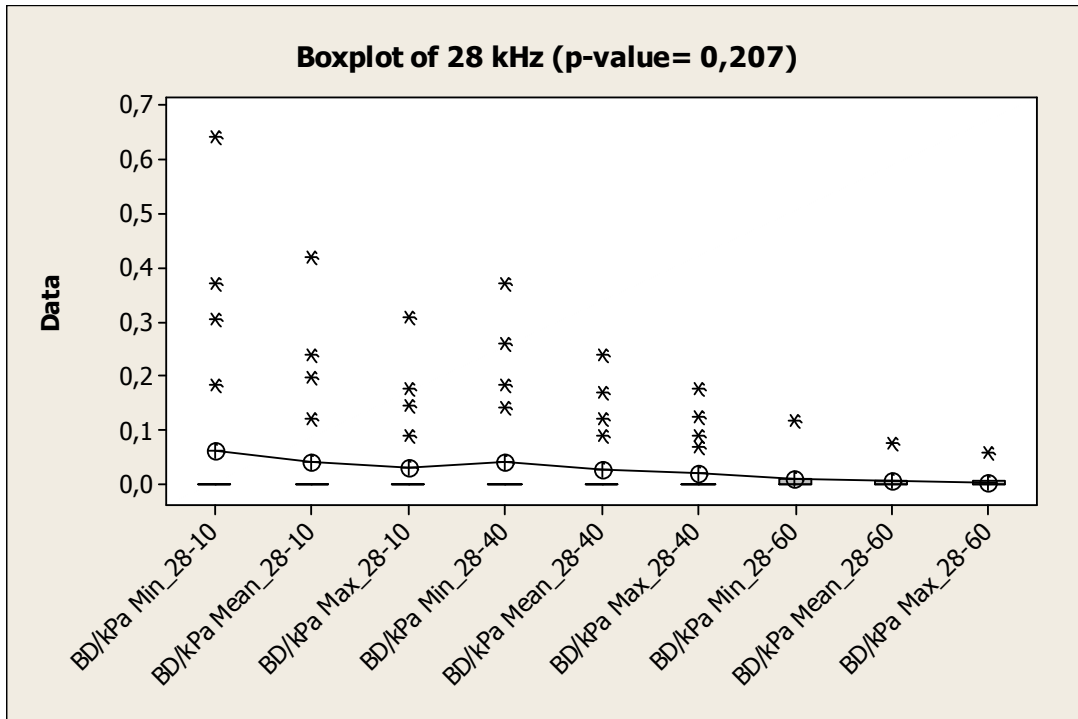

Fig 4.1.1.2.4. Evaluation of BD normalized values for the 28 kHz

35 kHz
Acoustic Pressure: 3,13 ± 1,63 kPa (1,5 kPa - 4,76 kPa)

Variable	Mean	StDev	Minimum	Q1	Median	Q3	Maximum	Range	IQR	
BD/kPa	Min_35-10	0,03	0,09	0,00	0,00	0,00	0,00	0,36	0,36	0,000
	Mean_35-10	0,01	0,04	0,00	0,00	0,00	0,00	0,17	0,17	0,000
	Max_35-10	0,01	0,03	0,00	0,00	0,00	0,00	0,11	0,11	0,000
	Min_35-40	0,03	0,09	0,00	0,00	0,00	0,00	0,44	0,44	0,000
	Mean_35-40	0,01	0,05	0,00	0,00	0,00	0,00	0,21	0,21	0,000
	Max_35-40	0,01	0,03	0,00	0,00	0,00	0,00	0,14	0,14	0,000
	Min_35-60	0,12	0,33	0,00	0,00	0,00	0,01	1,39	1,39	0,009
	Mean_35-60	0,06	0,16	0,00	0,00	0,00	0,00	0,67	0,67	0,004
Max_35-60	0,04	0,10	0,00	0,00	0,00	0,00	0,44	0,44	0,003	

One-way ANOVA					
Source	DF	SS	MS	F	P
Factor	8	0,2407	0,0301	1,64	0,114
Error	207	3,7909	0,0183		
Total	215	4,0316			

S = 0,1353 R-Sq = 5,97% R-Sq(adj) = 2,34%

Pooled StDev = 0,1353

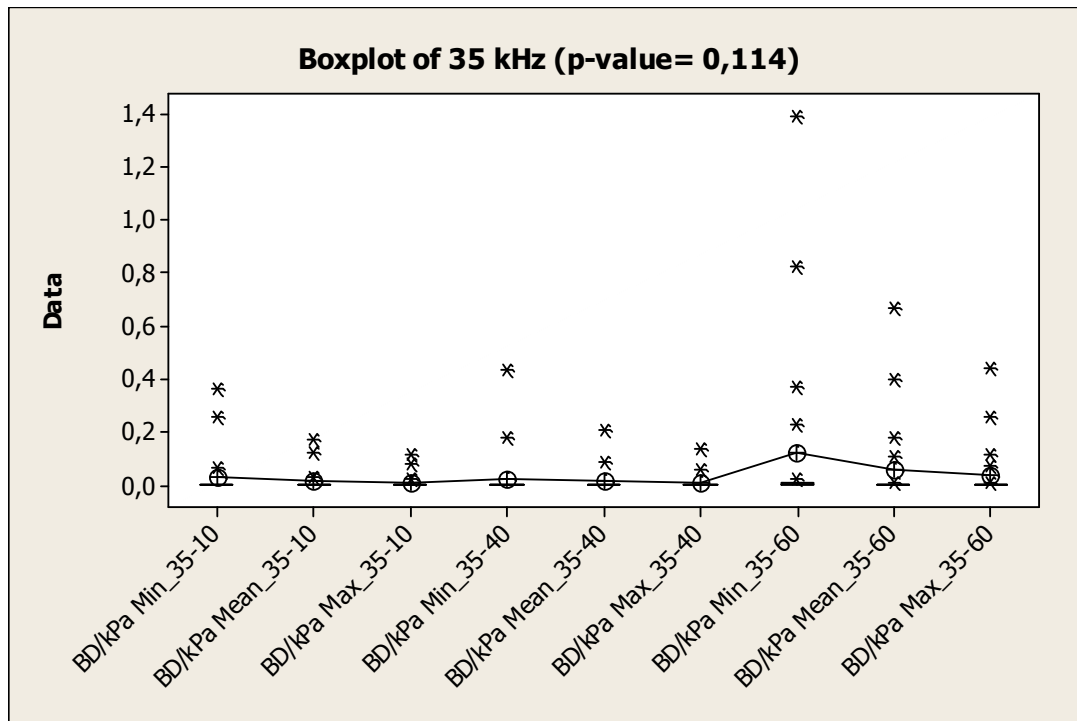

Fig 4.1.1.2.5. Evaluation of BD normalized values for the 35 kHz

37 kHz
Acoustic Pressure: 1,93 ± 0,91 kPa (1,02 kPa - 2,84 kPa)

Variable	Mean	StDev	Minimum	Q1	Median	Q3	Maximum	Range	IQR	
BD/kPa	Min_37-10	0,26	0,54	0,00	0,00	0,00	0,24	1,93	1,93	0,244
	Mean_37-10	0,14	0,28	0,00	0,00	0,00	0,13	1,02	1,02	0,129
	Max_37-10	0,09	0,19	0,00	0,00	0,00	0,09	0,69	0,69	0,088
	Min_37-40	0,09	0,21	0,00	0,00	0,00	0,07	0,81	0,81	0,069
	Mean_37-40	0,05	0,11	0,00	0,00	0,00	0,04	0,43	0,43	0,037
	Max_37-40	0,03	0,08	0,00	0,00	0,00	0,02	0,29	0,29	0,025
	Min_37-60	0,15	0,43	0,00	0,00	0,00	0,12	1,99	1,99	0,121
	Mean_37-60	0,08	0,22	0,00	0,00	0,00	0,06	1,05	1,05	0,064
	Max_37-60	0,05	0,15	0,00	0,00	0,00	0,04	0,71	0,71	0,043

One-way ANOVA

Source	DF	SS	MS	F	P
Factor	8	0,9399	0,1175	1,47	0,171
Error	207	16,5889	0,0801		
Total	215	17,5288			

S = 0,2831 R-Sq = 5,36% R-Sq(adj) = 1,70%

Pooled StDev = 0,2831

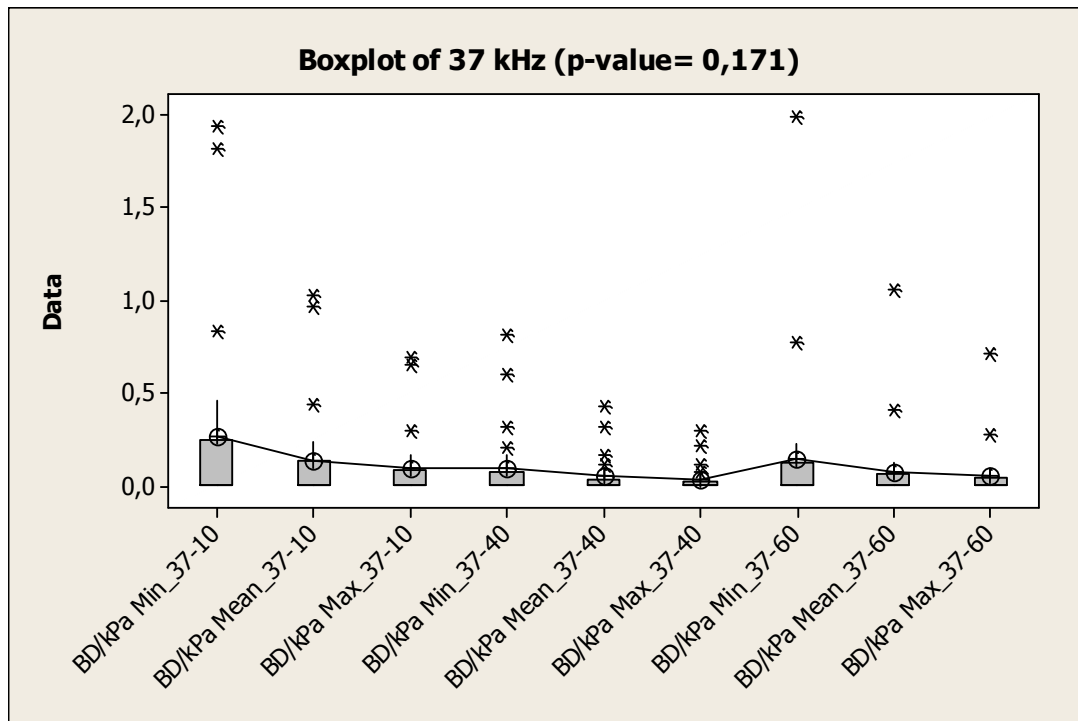

Fig 4.1.1.2.6. Evaluation of BD normalized values for the 37 kHz

38 kHz
Acoustic Pressure: 3,99 ± 2,15 kPa (1,84 kPa - 6,14 kPa)

Variable	Mean	StDev	Minimum	Q1	Median	Q3	Maximum	Range	IQR
BD/kPa	Min_38-10	0,07	0,15	0,00	0,00	0,00	0,09	0,54	0,093
	Mean_38-10	0,03	0,07	0,00	0,00	0,00	0,04	0,25	0,043
	Max_38-10	0,02	0,05	0,00	0,00	0,00	0,03	0,16	0,028
	Min_38-40	0,02	0,06	0,00	0,00	0,00	0,00	0,30	0,000
	Mean_38-40	0,01	0,03	0,00	0,00	0,00	0,00	0,14	0,000
	Max_38-40	0,01	0,02	0,00	0,00	0,00	0,00	0,09	0,000
	Min_38-60	0,02	0,07	0,00	0,00	0,00	0,00	0,32	0,000
	Mean_38-60	0,01	0,03	0,00	0,00	0,00	0,00	0,15	0,000
	Max_38-60	0,01	0,02	0,00	0,00	0,00	0,00	0,10	0,000

One-way ANOVA

Source	DF	SS	MS	F	P
Factor	8	0,09210	0,01151	2,54	0,012
Error	207	0,93749	0,00453		
Total	215	1,02960			

S = 0,06730 R-Sq = 8,95% R-Sq(adj) = 5,43%

Pooled StDev = 0,06730

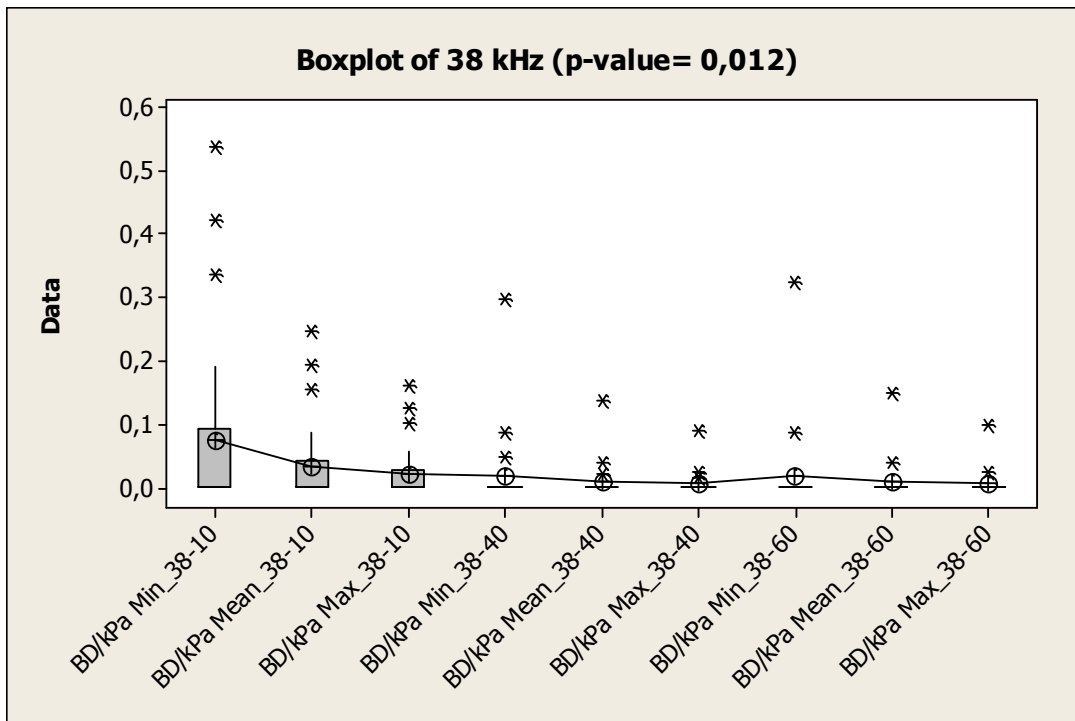

Fig 4.1.1.2.7. Evaluation of BD normalized values for the 38 kHz

4.1.2. Planktonic growth:

4.1.2.1. Analysis of the acoustic pressure effect

Analysis of dependence of variable PG from frequency and exposure time showed that these factors have a decisive effect. In this perspective, the analysis of factors acoustic pressure minimum, mean and maximum re-emphasizes the existence of three distinct groups of values . The first two groups are characterized by the effect of the primary frequency, and have been highlighted previously; the third group, formed from the values related to the single frequency of 38 kHz, appears instead probably related to the fact that acoustic pressure reaches, for this frequency, the maximum value recorded (Fig 4.1.2.1-4.1.2.3).

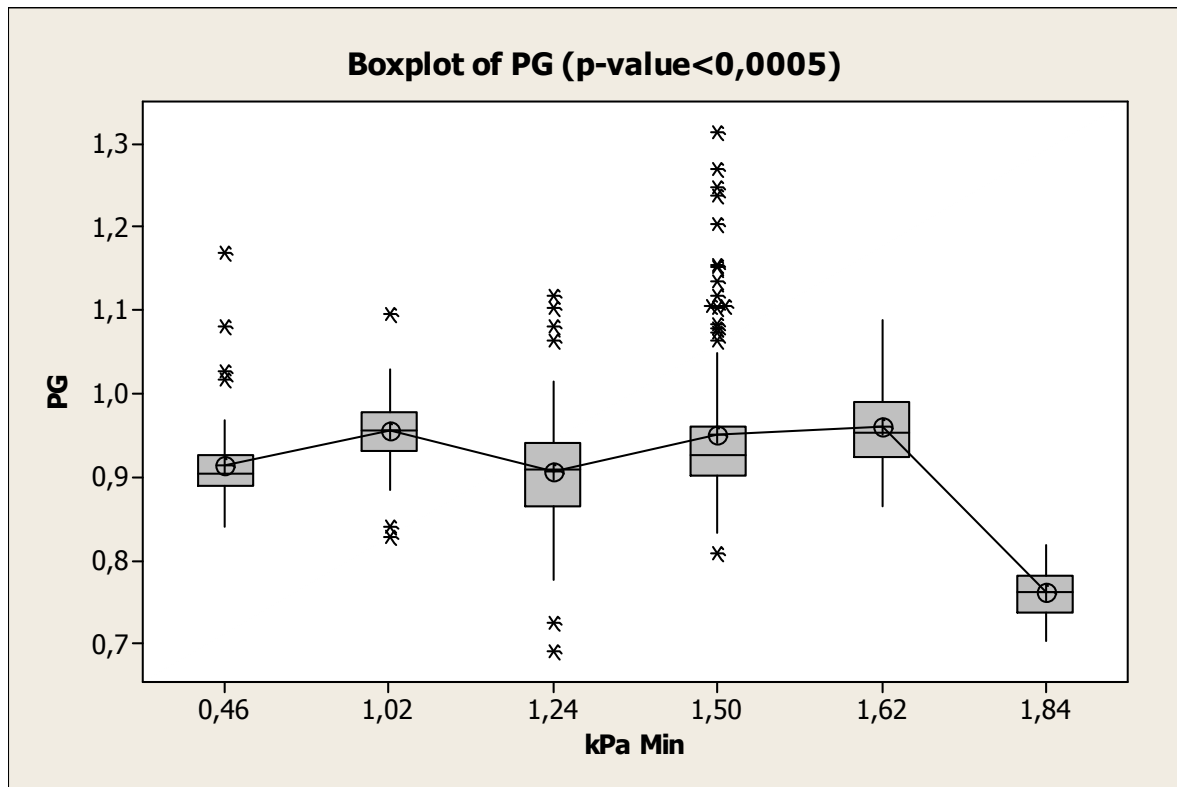

Fig 4.1.2.1. ABS value variation in relation to the different minimum acoustic pressures. (p-value related to the ANOVA)

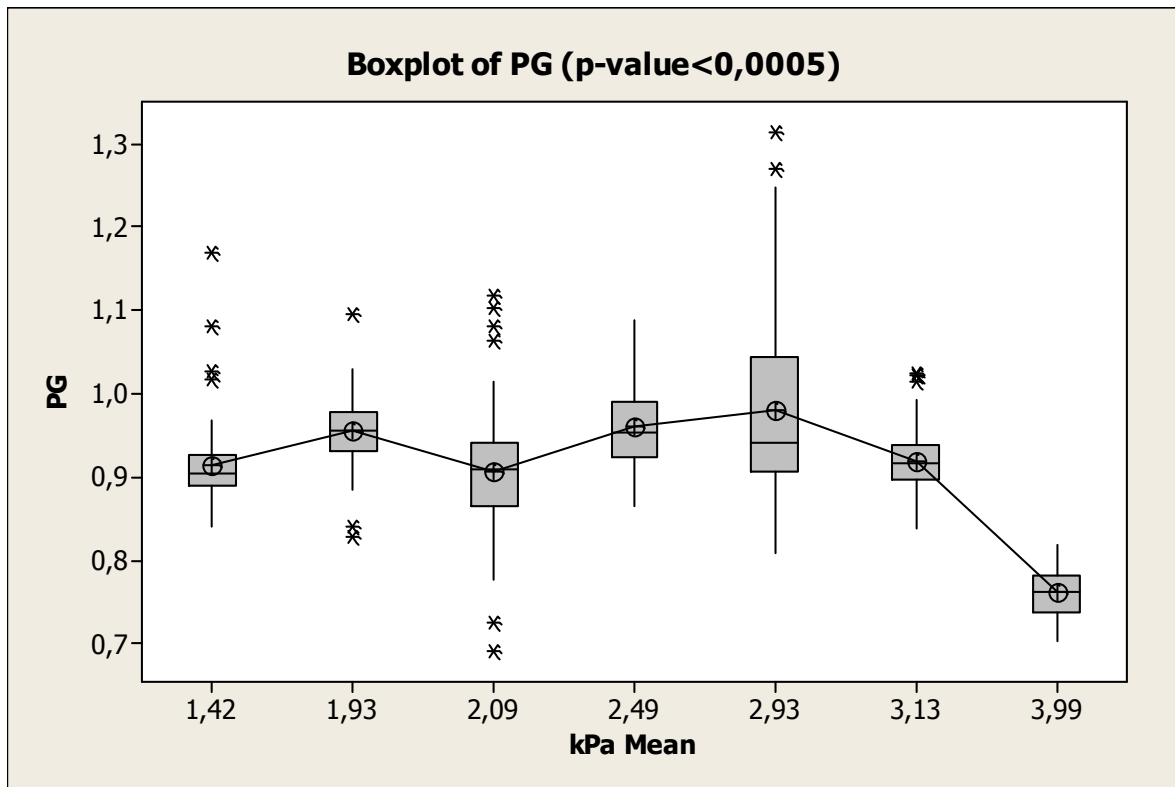

Fig 4.1.2.2. ABS value variation in relation to the different mean acoustic pressures. (p-value related to the ANOVA)

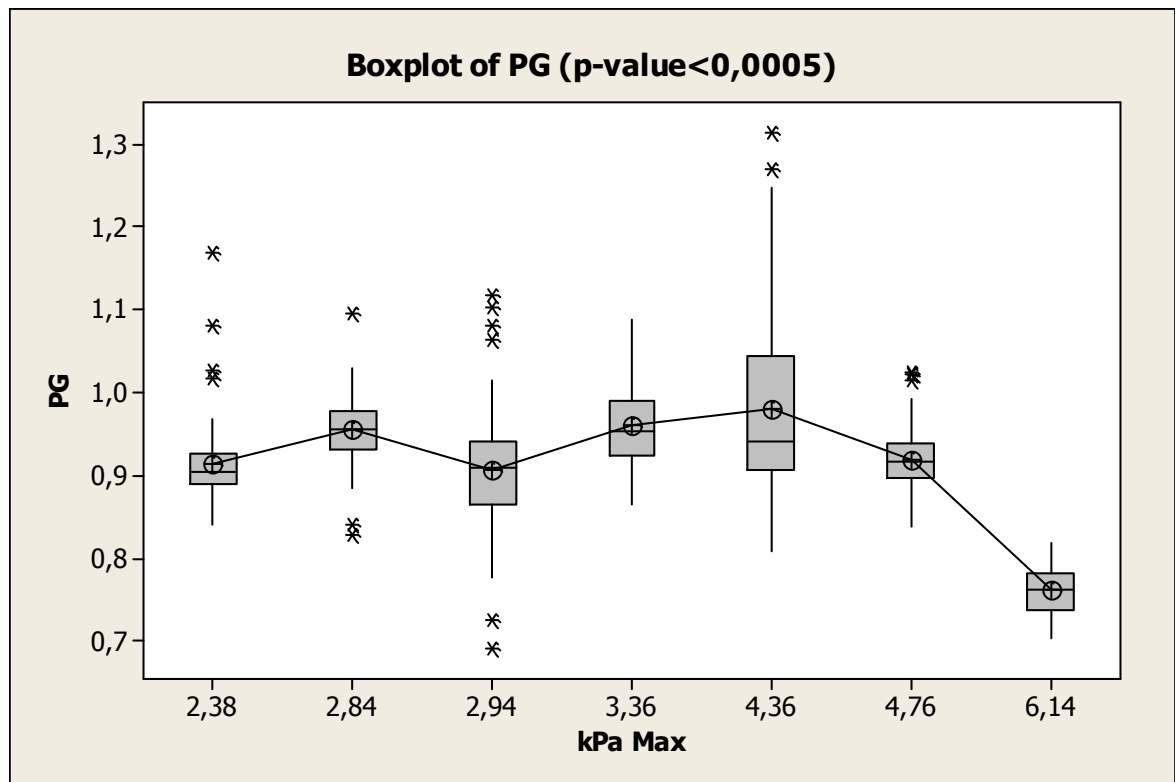

Fig 4.1.2.3. ABS value variation in relation to the different maximum acoustic pressures. (p-value related to the ANOVA)

The evaluation of the interaction between frequency and time of exposure, previously performed for BD, shows for PG a statistically significant interaction (p-value <0,0005) between the two factors and the variable (**Fig 4.1.2.4**).

Two-way ANOVA: PG versus kHz; t					
Source	DF	SS	MS	F	P
kHz	6	2,27002	0,378336	117,23	0,000
t	2	0,17212	0,086058	26,67	0,000
Interaction	12	0,13789	0,011491	3,56	0,000
Error	483	1,55882	0,003227		
Total	503	4,13885			

S = 0,05681 R-Sq = 62,34% R-Sq(adj) = 60,78%

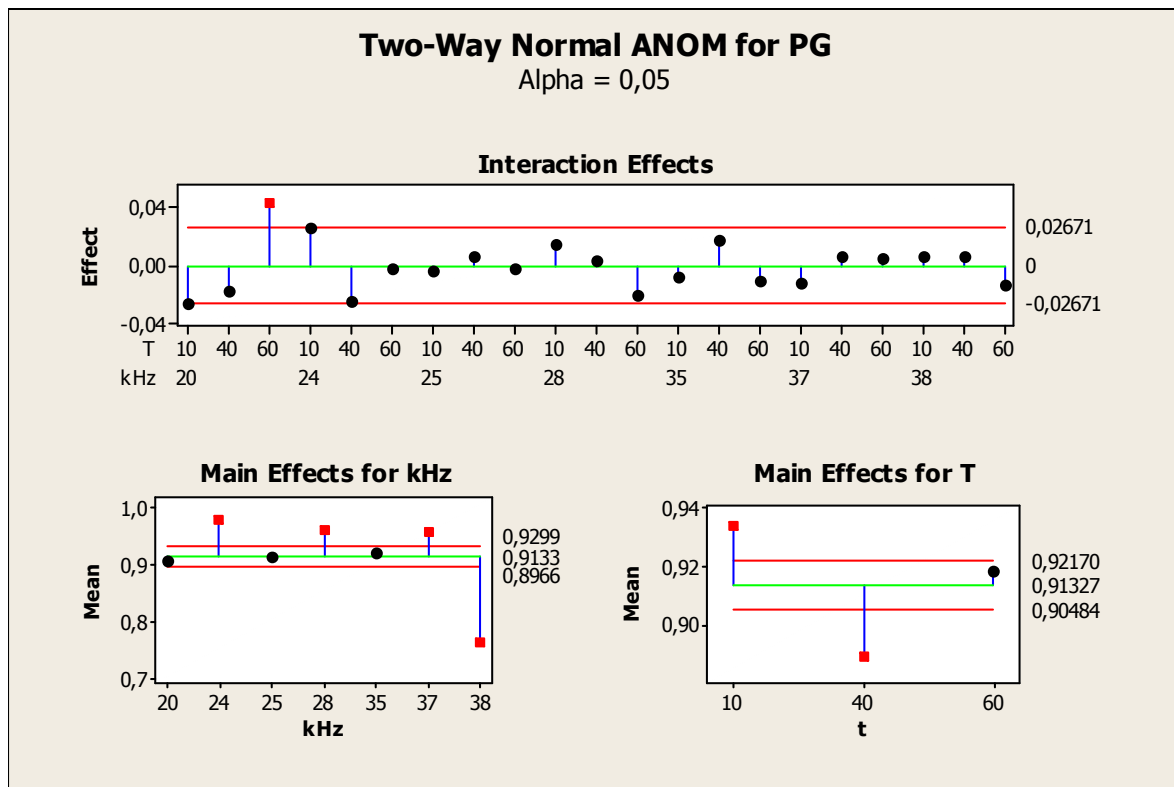

Fig 4.1.2.4. Analysis of the interaction between frequency and exposure time on the ABS value of the PG.

To determine whether the acoustic pressure effect could be relevant on the PG values, a normalization of the variable PG for the factor kPa min, kPa mean and kPa max is performed (**Table 4.1.2.1**). At this point the PG normalized values are confronted with factors frequency and exposure time (**Fig 4.1.2.5-4.1.2.6**).

Variable	Mean	StDev	Minimum	Q1	Median	Q3	Maximum	Range	IQR	
PG/kPa	Min	0,85	0,49	0,38	0,59	0,64	0,91	2,54	2,16	0,324
	Mean	0,40	0,14	0,18	0,30	0,38	0,49	0,82	0,65	0,188
	Max	0,27	0,08	0,11	0,20	0,28	0,33	0,49	0,38	0,137

Table 4.1.2.1. PG values normalized for acoustic pressure values

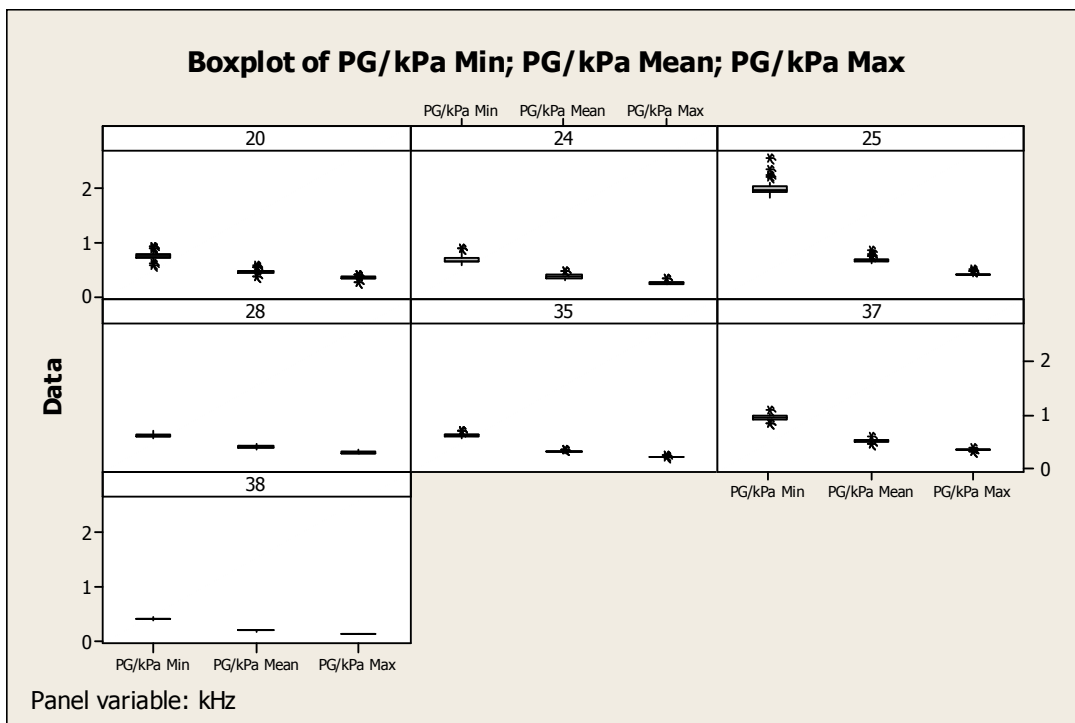

Fig 4.1.2.5. Distribution of PG normalized values by frequency

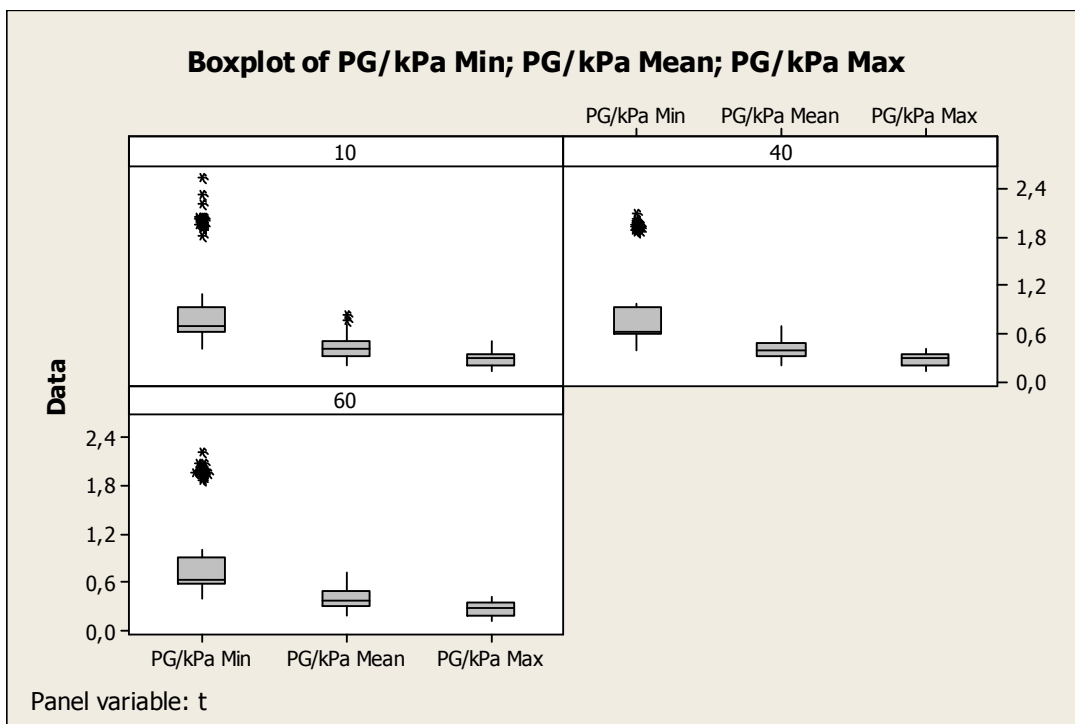

Fig 4.1.2.6. Distribution of PG normalized values by exposure time

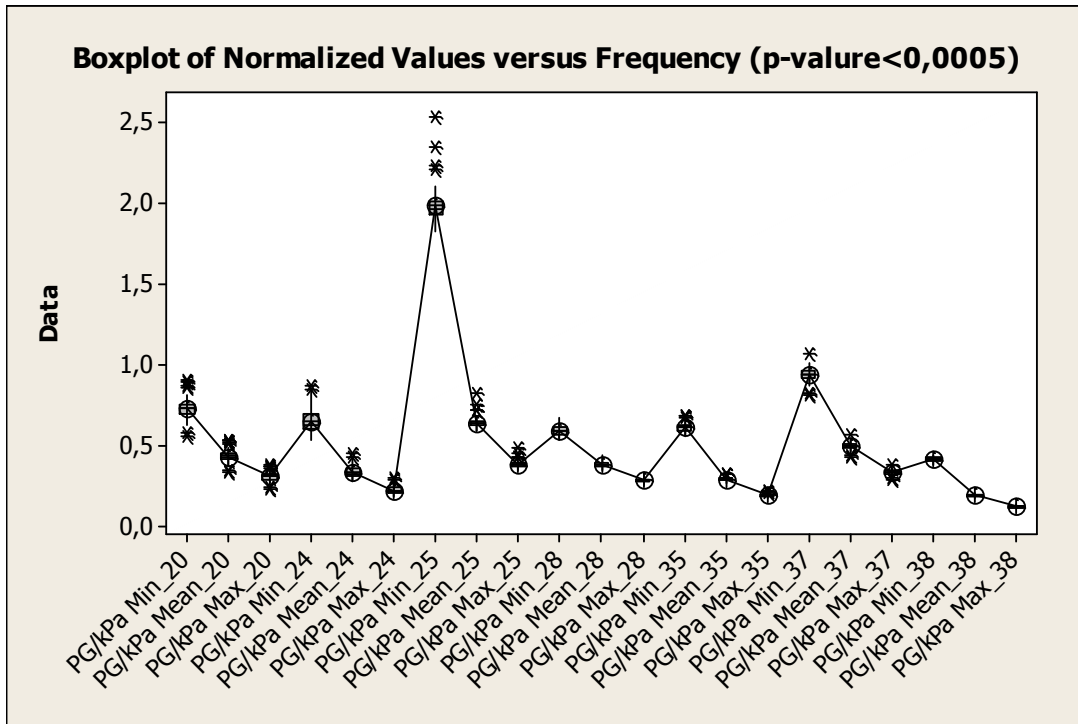

Fig 4.1.2.7. ANOVA for the general variance of the PG normalized values versus the different frequencies.

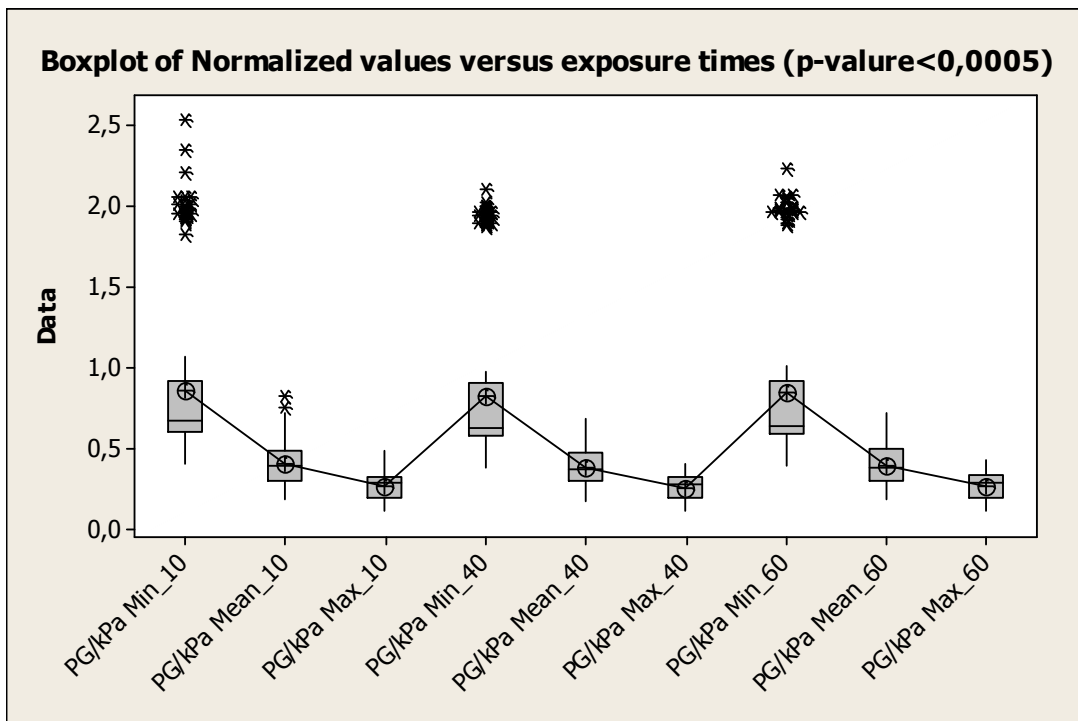

Fig 4.1.2.8. ANOVA for the general variance of the PG normalized values versus the different exposure times.

Eventually a two way ANOVA to analyze the interaction between frequency and exposure time was performed using as variables PG normalized values (Fig 4.1.2.9-4.1.2.11).

Two-way ANOVA: PG/kPa Min versus kHz; t					
Source	DF	SS	MS	F	P
kHz	6	119,740	19,9566	6692,65	0,000
t	2	0,128	0,0639	21,42	0,000
Interaction	12	0,092	0,0077	2,58	0,003
Error	483	1,440	0,0030		
Total	503	121,400			

S = 0,05461 R-Sq = 98,81% R-Sq(adj) = 98,76%

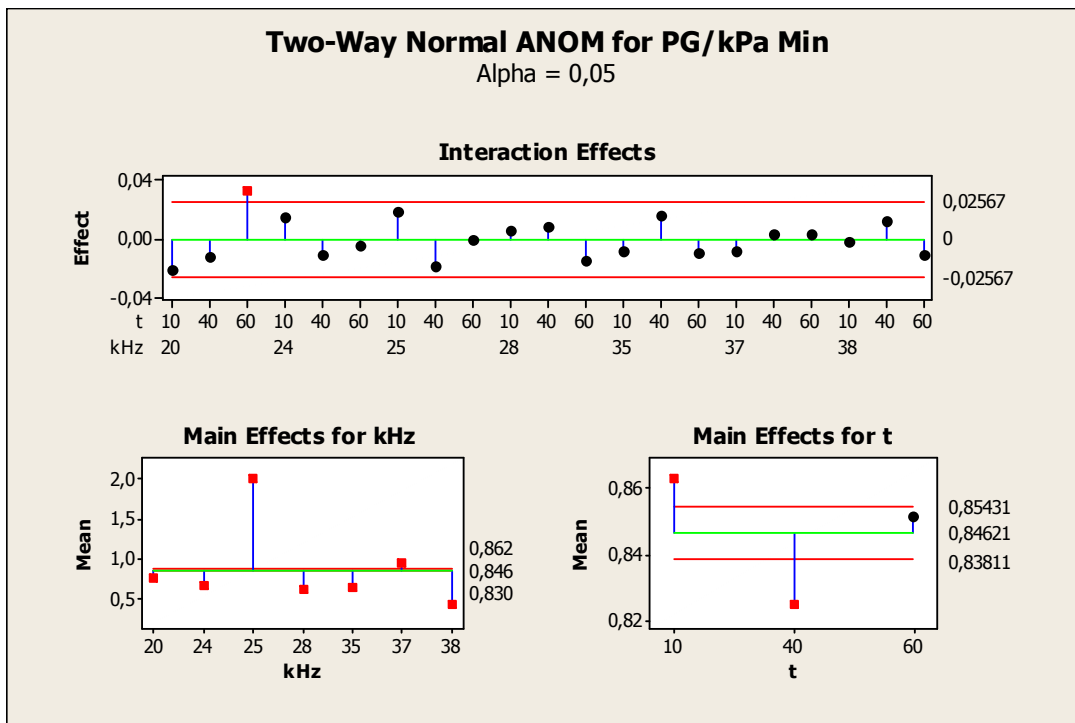

Fig 4.1.2.9. Interaction between frequency and exposure time using as variable PG/kPa min

Two-way ANOVA: PG/kPa Mean versus kHz; t

Source	DF	SS	MS	F	P
kHz	6	9,26986	1,54498	2554,82	0,000
t	2	0,03004	0,01502	24,84	0,000
Interaction	12	0,02498	0,00208	3,44	0,000
Error	483	0,29208	0,00060		
Total	503	9,61695			

S = 0,02459 R-Sq = 96,96% R-Sq(adj) = 96,84%

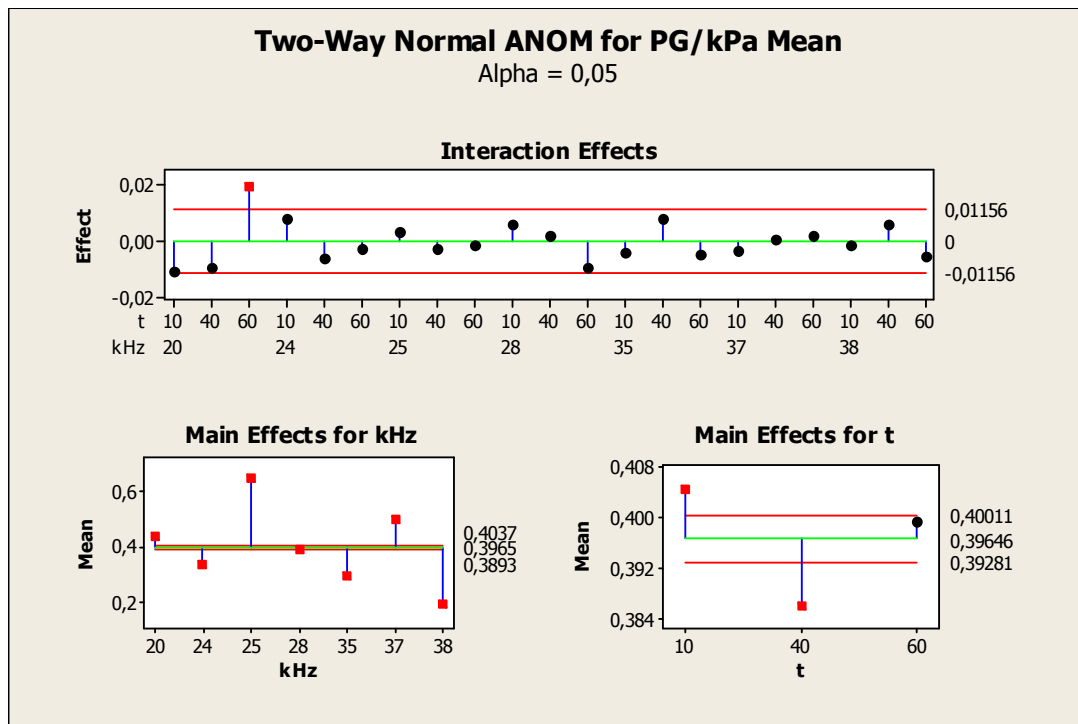

Fig 4.1.2.10. Interaction between frequency and exposure time using as variable PG/kPa mean

Two-way ANOVA: PG/kPa Max versus kHz; t

Source	DF	SS	MS	F	P
kHz	6	3,46549	0,577581	2134,30	0,000
t	2	0,01367	0,006836	25,26	0,000
Interaction	12	0,01237	0,001031	3,81	0,000
Error	483	0,13071	0,000271		
Total	503	3,62223			

S = 0,01645 R-Sq = 96,39% R-Sq(adj) = 96,24%

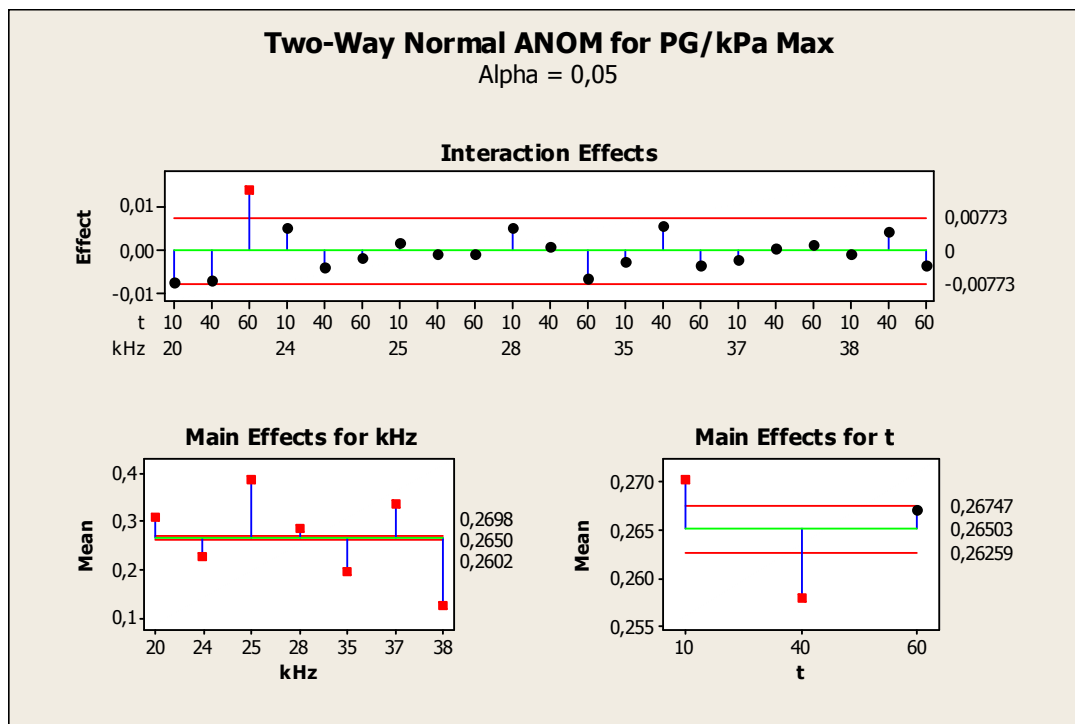

Fig 4.1.2.11. Interaction between frequency and exposure time using as variable PG/kPa max

5. DISCUSSION

This study is born from the intention of understanding how ultrasounds interact with bacterial metabolism in absence of the cavitation effect. Currently the international scientific literature does not provide sufficient data regarding the effects on the microorganisms by the acoustic pressure produced by ultrasound in a system not cavitating. The present work provides a method to assess the influence of low intensity ultrasounds on the metabolism of prokaryotic cells. To develop this study has been applied to an experimental plan, which provided for the division of the experiments in different phases. Each phase was to represent a range of different application with a separate uncertainty analysis such that it was possible to isolate and highlight critical issues. This step by step approach will allow the discussion, as detailed as possible, the possible explanations about the results so as to be able to identify which possible future studies could be designed.

As well as the experimental plan consisted of three phases of analysis, divided into acoustic, biological and mixed, so the discussion is being developed in three parts. In the first part will be treated the inherent aspect of the acoustics and the complications encountered in this phase of the study. The second part covers the biological aspects of work trying to interpret the results in light of the knowledge of the metabolism of prokaryotic cells. The third and final part of the discussion will focus on the implications of this work in the field of metrology, and in particular about the instability of the measurand, typical of biological field, and how this instability can affect the interpretation of the results.

5.1. Acoustics

The analysis of the acoustic wave propagated inside the bath initially come across some complications. Initially, the study included an analysis of the acoustic field throughout the tank by measuring the acoustic pressure through all the fifteen holes of the grid. This approach, however, has encountered the problem that, outside of the central hole, through all other holes, the field was too unstable with huge uncertainty of measurement. At the same time, it was determined that the insertion of the tubes allows, almost for all frequencies studied, to slightly reduce the uncertainty related to the measurement of sound pressure. During the experiments is undoubtedly emerged as, despite the frequency changes, the geometry and the material which forms the tubes have a primary role in influencing the sound pressure and the resulting



uncertainty. At the same time it is evident how the uncertainty of the system should also be closely linked to another factor.

In the first case the positioning hydrophone in the various points of the grid may have exposed the measures to a factor of variability not measured during this study and that the phenomenon of scattering. This phenomenon may also be similarly related to the reduction of uncertainty within the tubes.

The scattering refers to the property of a medium to spread in all directions the power of a wave incident, so subtracting additional power to the coherent component.

During the emission of the acoustic wave, both the walls of the tank and the water surface (the medium), produce echoes that determine the phenomenon of scattering. These echoes could adversely affect the hydrophone when placed in different areas of the grid leading to measures inconsistent and unusable. This phenomenon varies from frequency to frequency and according to the position of the measuring instrument. In the central point of the grid it was then possible to measure acoustic pressures with greater or lesser uncertainty probably also based on how the scattering influenced the hydrophone when the frequency changes. At the same time this phenomenon has probably resulted in a reduction in uncertainty when the tubes are inserted. The presence of the tube has perhaps removed the influence echo coming from the surface of the medium isolated from the tube itself thereby reducing the uncertainty resulting.

5.2. Biology

The development of a biofilm is considered fundamental condition so that the majority of microorganisms demonstrate their pathogenic power. As far as mature biofilm may be resistant and hard to remove, such a state is related to very delicate and highly coordinated phenomena [20]. During biofilm development several factors work together to promote or to interfere with its growth cycle. During this process it could be possible to highlight as critical the first two steps that are related to a condition of reversible attachment. The first phase is characterized by the first contact between microorganism and surface. This step, that can take only seconds, is strictly related to environmental signals as nutrient presence and concentration, pH, temperature, medium chemical characteristic, oxygen concentration and surface characteristic. In *E. coli*, as previously described, this phase is related also to the mobility of the bacterium and it finishes with a first and reversible binding [18]. Recent studies showed how this phase of the biofilm development is also related to the shear forces present in the medium. The analysis described how the presence of a Reynolds numbers of 5.000 performs the ideal condition to increase

planktonic cells capability to start the biofilm formation. Reynolds number is a dimensionless number describing the flow of a liquid; when high, turbulent flow exists; if low, laminar flow conditions prevail [19].

The second critical step is the phase II, in this stage of the biofilm development process it is possible to identify various metabolic process concentrated to realize an irreversible attachment of the microorganism to the surface [20]. In this stage bacteria formed biofilm emitted chemical signals that allows a communication between microorganism with a strong increasing of the adherence to the biofilm. When the thickness of the extracellular matrix becomes greater than 10 μm the process enters the phase III of maturation. *E. coli* biofilm formation in the second stage is strictly related to specific protein structure as type 1 fimbriae, curli, and conjugative pili [93]. The spectrophotometric evaluation of bacterial viability and of biofilm development showed in results chapter values with a complicated interpretation. First of all this work shows how ultrasound at low frequencies and for short exposure time is not able to produce a reducing effect into bacterial viability. Only the frequency of 38 kHz showed some bactericidal or bacteriostatic effect but with a reduction of *E. coli* count only of the 25% respect to the C+. Except for the 38 kHz results (probably related to the high acoustic pressure) other six frequencies showed some tendency (see ANOVA page 78).

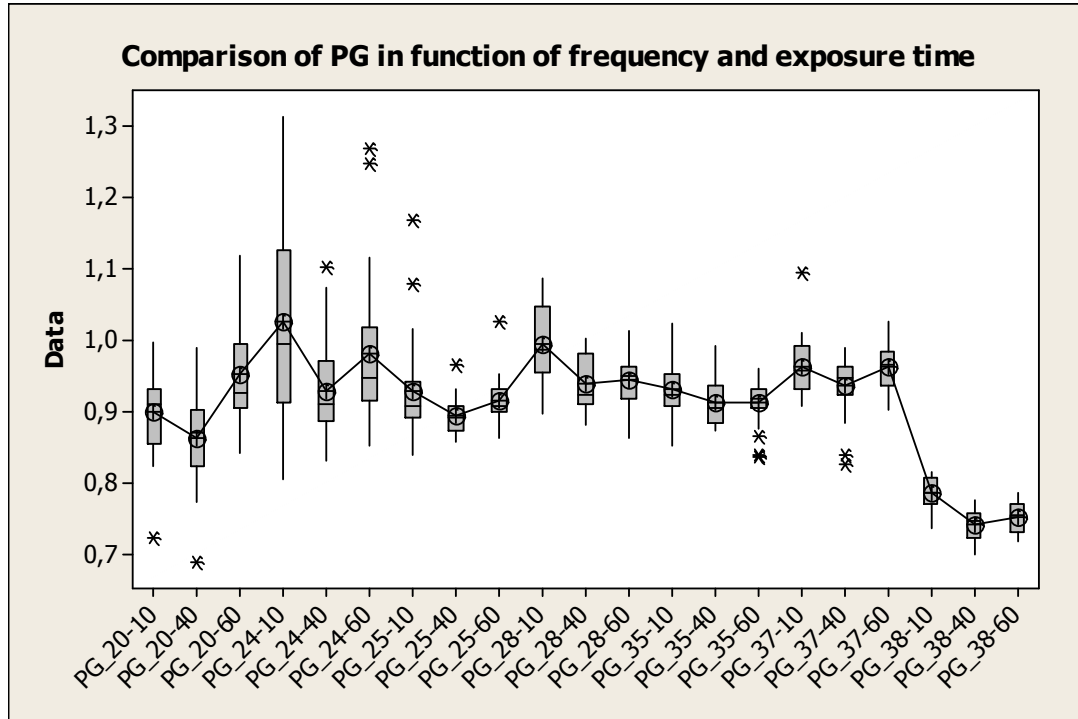

Fig 5.2.1. Distribution of PG values considering the frequency and exposure time factors together

In the end the planktonic growth of *E. coli* showed to be influenced by both frequency and time, the frequency effect shows two different tendencies only if the exposure time factor is not considered (**Fig. 5.2.1**). This result could be explained with a possible antibacterial power of some frequency that could need more time (from 15 to 60 minutes) to work, as described in literature too [121].

Biofilm formation showed in the results, right from the first analysis, a strict correlation with the acoustic pressure with an inhibition power increasing with pressure (between the value of ABS related to the BD and the value in kPa related to the acoustic pressure it was possible to find a Pearson correlation of -0,237 with a p-value lower than 0,0005).

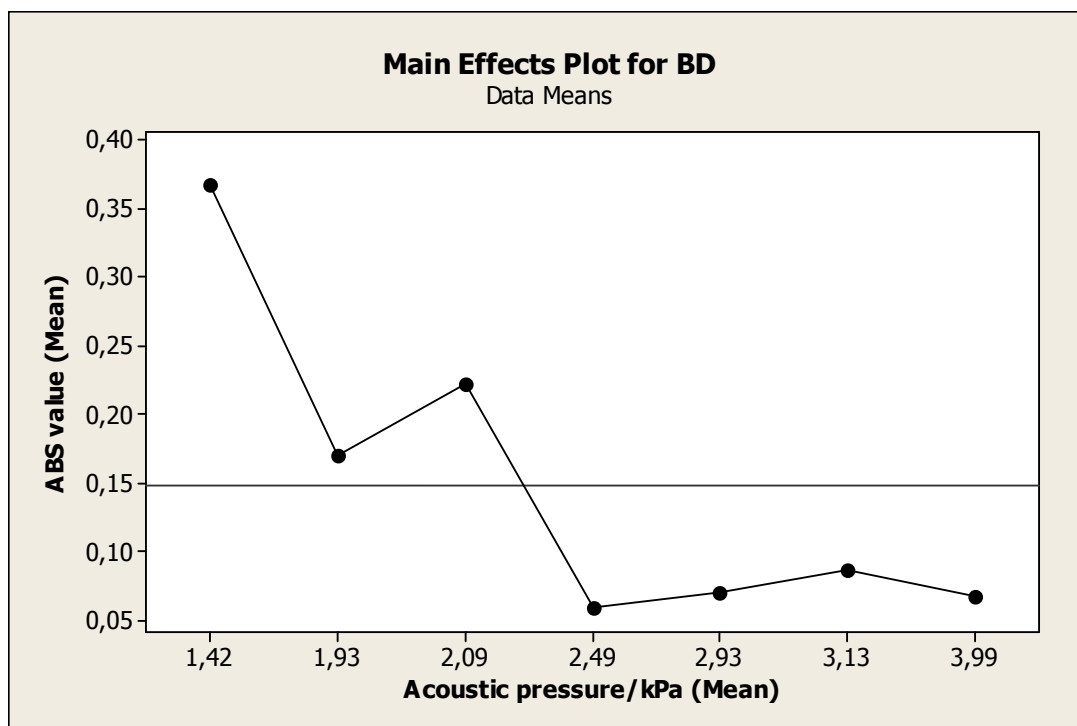

Fig 5.2.2. Evaluation of ABS value of BD in relation with the growth of the acoustic pressure

The difference between the trends of the PG respect to the BD requires to perform a separate analysis, principally to understand which kind of mechanisms work to inhibit the second one.

The Two-Way ANOVA (performed from page 94 to page 96) showed how both frequency and exposure time have some activity against biofilm formation, but it is identifiable only using BD value normalized for the minimum value of acoustic pressure. Another characteristic of the US effect on the BD is that with a time exposure exceeding 10 seconds the ABS values are all close to 0 losing previous trends shown in fig 5.2.2. This result allows to determine how *E. coli* is able

to resist to US exposure (at least at low pressure) for a few seconds before detecting a complete biofilm inhibition (Fig 5.2.3-5.2.5).

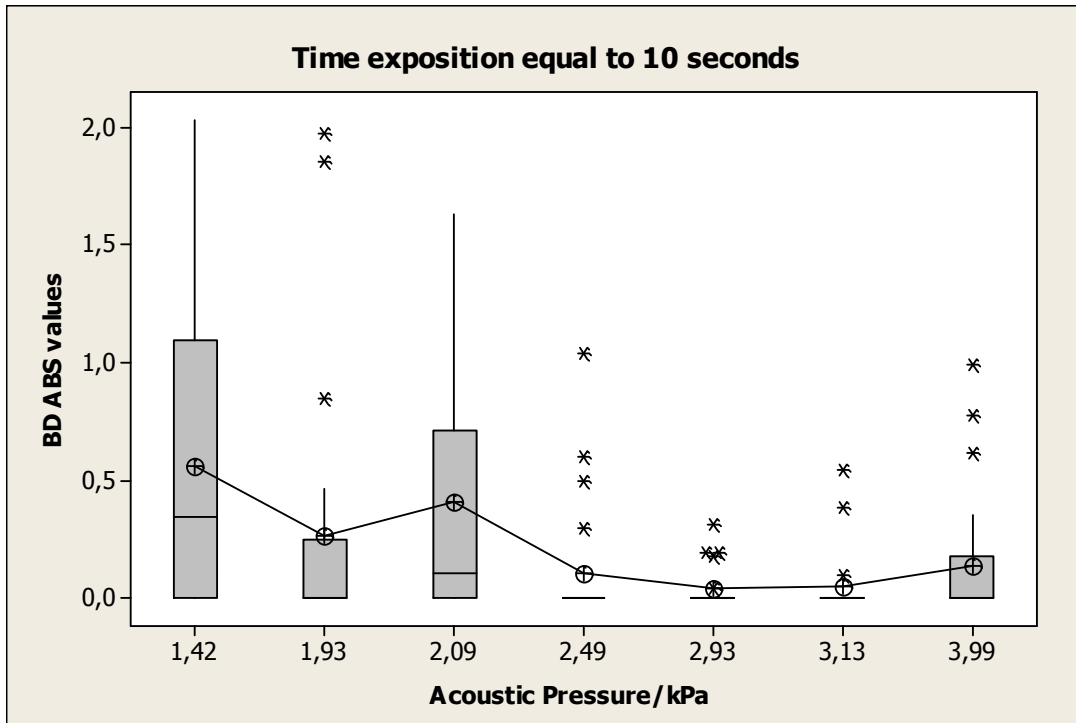

Fig 5.2.3. BD ABS trend after 10 second of exposure to the ultrasonic field. The behavior of the biofilm is similar to that described in Figure 5.2.2.

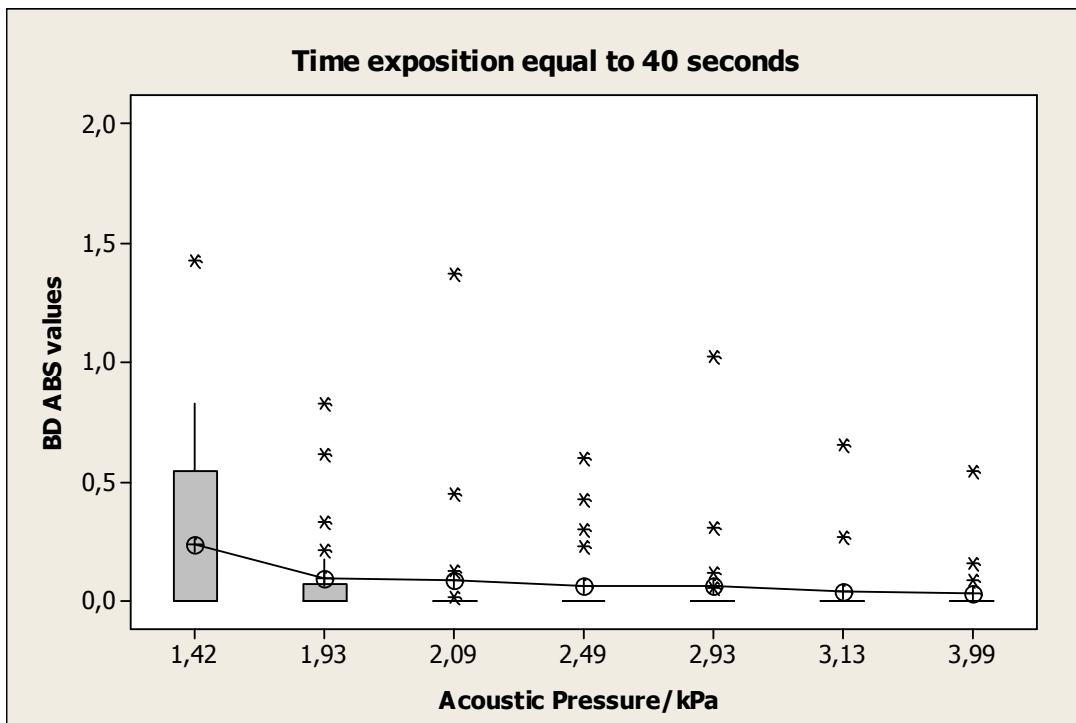

Fig 5.2.4. ABS trend after 10 second of exposure to the ultrasonic field. Most values tends to 0.

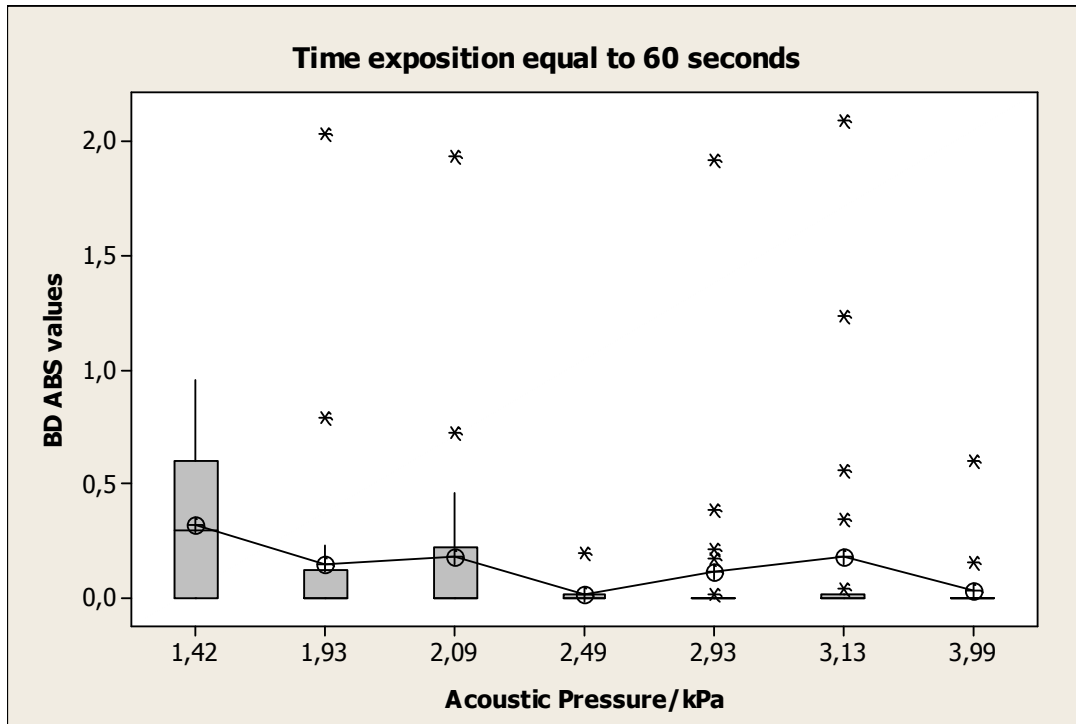
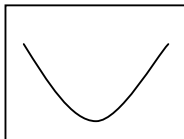
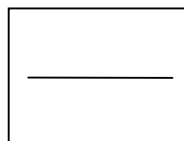

Fig 5.2.5. BD ABS trend after 60 second of exposure to the ultrasonic field. It is possible to identify a greater development of the biofilm compared with that relating to the 40 seconds of exposure, in correspondence with certain pressures/frequencies.

Analyzing frequency by frequency the effect of the US on *E. coli* it was possible to identify three patterns of development (as described at page 97). These patterns are closely associated with the activity that the individual frequencies have in favor or in conflict with the effect of acoustic pressure and exposure time.



Parabolic pattern is probably related to frequency with a stimulating activity on bacterial metabolism. In fact, for frequencies of 20 kHz, 25 kHz and 37 kHz is detected the trend in the absorbance values of drop to almost 0 after 40 seconds of exposure and then grow in the measurements carried out after 60 seconds of exposure. This trend could be explained by a stimulation by these frequencies of the metabolism of *E. coli*.



Constant pattern, identified for the 24 kHz and 35 kHz, could be explained as the presence of balance between stimulating and inhibitory power in these frequencies. At the same time a tendency towards the inhibition of biofilm development, but minor, it would be equally valid to understand this trend.

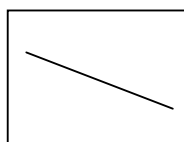

Descending pattern is probably related to a synergy between acoustic pressure, exposure time and frequency in bringing a final inhibitory effect on the biofilm development. In this case the frequencies, such as 28 kHz and 38 kHz, work with other factors leading to a continuous reduction of the absorbance values that, in the measures after 60 seconds of exposure, were reduced to almost 0.



The biological explanation for these results is not straightforward. On the one hand it is clear that the effect of ultrasounds on the microorganism tested is necessarily related to interference with its intimate biological mechanisms. On the other hand it is not immediately identifiable how metabolic mechanism is inhibited by exposure to frequencies tested. Anyhow, starting from the knowledge that were described previously about the phases of development of a biofilm, three possible mechanisms may be assumed that could explain the results obtained. The first hypothesis is that the ultrasounds could affect directly the ability of bacterial mobility. As described in previous chapters, the capacity for mobility given by the flagellar apparatus is essential for the initial adhesion of *E. coli* to a surface. An irreversible alteration of the bacterial mobility would explain the subsequent inability of *E. coli* to adhere to surfaces. The second hypothesis is the effect that the ultrasounds could have on genetic regulation of protein structure related to the development of an irreversible attachment. The expression of specific genes and the self-regulation between them are fundamental to produce the biological adhesion between bacteria and surfaces. If the environmental changes, performed by the ultrasounds, generate some mutations so that to break this delicate process, it could explain the observed results.

A final possible explanation of the results obtained may then be the presence of an interaction between the exposure to ultrasound and the production, by *E. coli*, of the quorum sensing (QS). QS is primarily a means of intercommunication between bacteria developed through some extracellular molecules. These molecules allow the microorganisms to stimulate each other their metabolism so as to respond more quickly and effectively to environmental changes. In the case of biofilm for example, bacteria that are already part of it, through the QS can stimulate transcription of the necessary adhesion proteins in the microorganisms still in planktonic form [20]. In the case of *E. coli* QS also has a key role in the development of bacterial motility by stimulating the production of flagella as well as in stimulating the production of surface proteins necessary for the development of the irreversible adhesion [93]. As in the two previous hypotheses also in this case a mutation, induced by the ultrasonic field, in the genes deputies to the development of QS would explain the inability of the bacteria exposed to a acoustic pressure to produce a biofilm.

5.3. Metrology

The metrological point of view in this work has highlighted, for the spectrophotometric measurement, the presence of huge uncertainty values, especially those relating to the biofilm after exposure to ultrasounds (see page 71).

These high values of uncertainty are related to the values of absorbance relative to the development of biofilms for all frequencies studied. The values of expanded uncertainty, which in the case of the formation of biofilm in the absence of ultrasonic exposure presents values between 12% and 16%, arrives, after exposure to ultrasound, to values that often exceed 200% (**Table 5.3.1**).

Frequency (kHz)	Uncertainty values			
	BD			
	10 s	40 s	60 s	C+
20	60%	300%	130%	15%
24	310%	3030%	330%	12%
25	55%	95%	53%	16%
28	250%	800%	80%	14%
35	480%	400%	180%	12%
37	120%	310%	210%	13%
38	160%	340%	330%	16%

Table 5.3.1. Uncertainty of biofilm development (BD) for each exposure time to US

It was tried to identify a correlation that would allow to explain, statistically, the development of the values of uncertainty. For this purpose, these values were correlated with both the absorbance values corresponding with the trend of these values in relation to frequency but not statistically significant correlation (p-value higher than 0,05) has emerged (**Table 5.3.2**).

Frequency (kHz)	ABS Mean (Uncertainty values)		
	10 s	40 s	60 s
20	0,41 (60%)	0,08 (300%)	0,18 (130%)
24	0,04 (310%)	0,06 (3030%)	0,39 (330%)
25	0,55 (55%)	0,38 (95%)	0,31 (53%)
28	0,10 (250%)	0,06 (800%)	0,01 (80%)
35	0,04 (480%)	0,04 (400%)	0,18 (180%)
37	0,26 (120%)	0,09 (310%)	0,15 (210%)
38	0,14 (160%)	0,03 (340%)	0,03 (330%)

Table 5.3.2. Comparison between the mean values of ABS with the values of uncertainty.

In trying to explain the presence of these values of uncertainty there is a further evaluation to make, the uncertainty values were analyzed on the basis of the presence of outliers. Looking at

the trend of the values of ABS biofilm were described only the values that were contained in the interquartile range box (Fig 5.3.1). Nevertheless the values considered outliers were not eliminated but instead kept in statistical calculations (Fig 5.3.2). This is because these values do not correspond to the common definition of outliers.

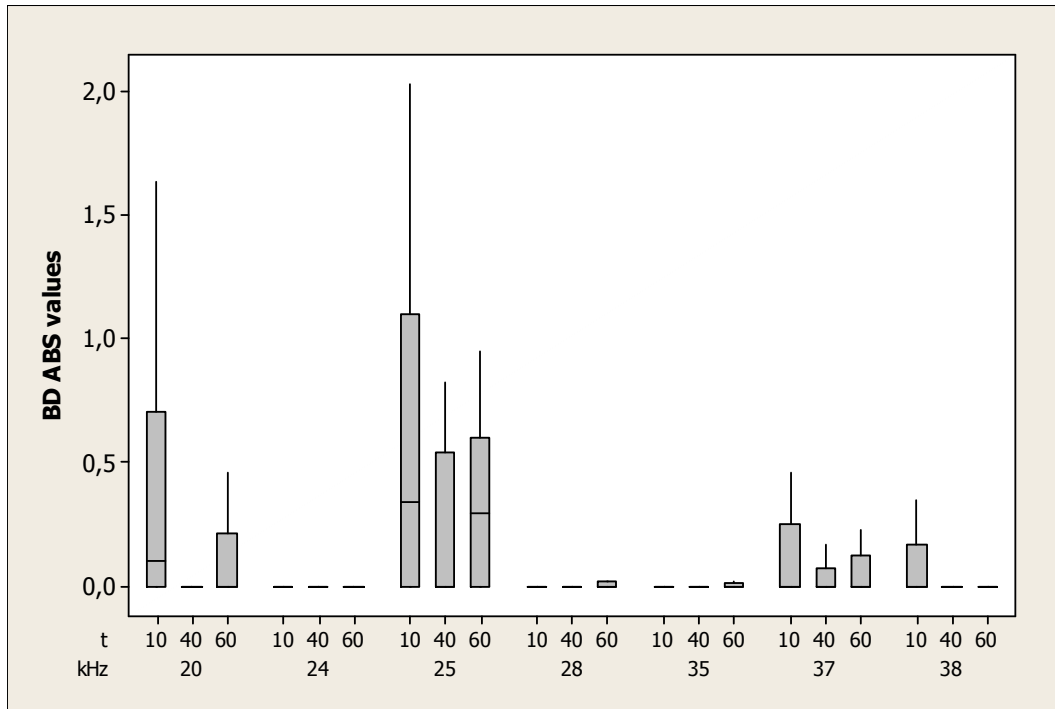

Fig 5.3.1. Interquartile range box related to BD ABS values without the values of outlier divided for frequency and exposure time

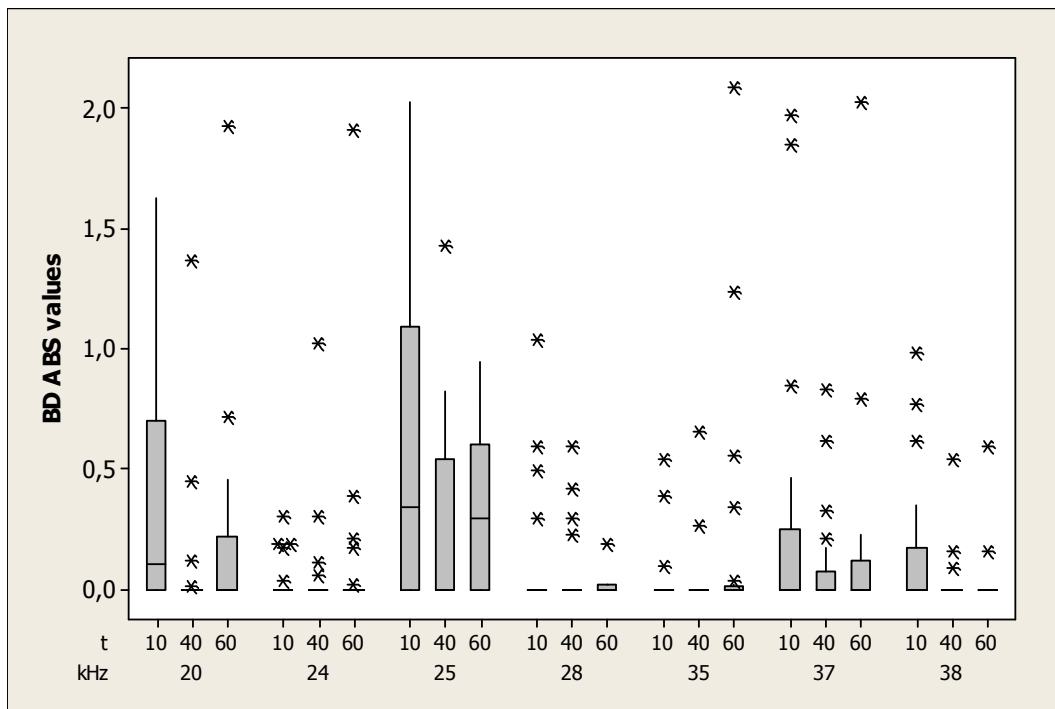

Fig 5.3.1. Interquartile range box related to BD ABS values with the values of outlier divided for frequency and exposure time



Usually the term outliers is used to indicate one or more values that are derived from a measurement error, often related to the operator, to the instrument or to an incorrect planning of the experiment. In the case of measurements in biology, outliers are the manifestation of the enormous instability of the measurand. From this point of view, the outlier is an integral part of the usual behavior of biological measurand and not a wrong measurement or a random event.

In this study, outliers are probably correlated to the response of bacteria to the stress induced by ultrasound. A 1998 study investigated the effects produced on *E. coli*, by an ultrasonic wave high-frequency (1 MHz) together with the shock waves produced by the cavitation effect [122]. During that study the effect of the acoustic wave, but especially of bubbles arising from cavitation, has been identified as a cause of damage at the level of the bacterial membrane. At the same time were evaluated also a possible involvement of DNA and protein repair systems. Simultaneously to the antibacterial effect, this study highlighted the presence of a portion of the bacterial population that was able to resist and to survive to the exposure to ultrasound. In conclusion it was assumed that the cells in stationary phase were more resistant to the action of ultrasound even managing to respond to the stress induced by the ultrasound with a greater growth. The work presented in this thesis, using just bacteria in the stationary phase, confirmed these results and bacterial resistance is represented by the outliers.

6. CONCLUSIONS

In conclusion, this work has allowed to highlight the innovative aspects concerning the action of ultrasound on microorganisms. Every aspect shown in the discussion helps to program future developments of this work.

In the field of acoustics a careful study of the phenomena of scattering inside the bath and tubes will be needed. It will also be essential to carry out the measurements of acoustic pressure in the various points of the grid by varying power and intensity of the acoustic wave. Finally, a further analysis concerning materials and shapes of the tubes could obtain an even higher degree of sonic transparency with a decisive reduction in uncertainty.

In the field of metrology this study shows once again how some aspects of bioscience need greater attention. The study of measurands with such high instability and variability will require new approaches in order to obtain reproducible and repeatable measurements. From this point of view, a search for reference points that allow to perform measurement sessions comparable with each other even after a long time and under varying environmental conditions is required. In particular, the future development of this study will be the opportunity to repeat the measurements by varying the factors taken into consideration in order to try to highlight more clearly the trends identified and the role of each factor.

In the biological field, it is possible to highlight the most interesting prospects. The analysis of the biological reasons that led to the results obtained will require an assessment of different aspects. Future studies therefore may focus on an assessment of the bacterial metabolism before and after exposure to ultrasound, with the measurement of:

- bacterial motility,
- the expression of surface proteins,
- quorum sensing,
- genetic mutations.

A recent article showed results similar to those identified in this work. That study showed a bacteriostatic effect of ultrasound without a loss of viability of the bacterial population treated. In the article, they analyzed the integrity of the bacterial membrane using fluorescent microscopy and a reporter strain containing lux genes fused with membrane damage stress response promoter. Although the inhibiting effect on the formation of biofilms has been showed by these authors that have suspected, as well as damage to membrane observed, the possible involvement of DNA and protein repair systems [123].



Further progress can be made on these issues, and the fact that other groups in the world are parallel conducting similar studies, it shows that this field of research still has many unclear aspects that need to be studied in-depth (**Table 6.1**).

Field	Observation	Hypothesis	Further Studies
Acoustic	High uncertainty in relation to different frequencies, tubes and hydrophone position	Specific material interaction with specific frequencies	Analysis of the diffusion of the ultrasound with other kind of materials
		Influence of the scattering	Analysis and study of the scattering effect and measure in more point of the grid
Biology	High uncertainty in relation with the biofilm state	Effect of the ultrasounds on the bacterial motility	Analysis of the bacterial motility
		Ultrasound effect on the bacterial metabolism and, more specifically, on type 1 fimbriae, curli, and conjugative pili activity	Molecular analysis of the genic expression for the transcription of the adhesive proteins
Metrology	High uncertainty in relation with biological variability and with the correlation between several factors	Bacterial adaptability to a hostile environment	Searching for a constant that allows to identify the degree of variability
		Needs to isolate each factor alone to identify more clearly its role in the uncertainty calculation	Repeat the experiment by varying more the various factors

Table 6.1. Summary of the results and of the future developments



7. REFERENCES

- [1] Evaluation of measurement data - Guide to the expression of uncertainty in measurement (GUM), in: JCGM (Joint Committee for Guides in Metrology), 2008.
- [2] T. Quinn, J. Kovalevsky, The development of modern metrology and its role today, *Philos Transact A Math Phys Eng Sci*, 363 (2005) 2307-2327.
- [3] BIPM, The International System of Units (SI), (8th edition 2006).
- [4] CR, Resolution 1, in: 17th CGPM, 1983, pp. 97.
- [5] *Metrologia*, 20 (1984) 25.
- [6] CR, in: 3rd CGPM, 1901, pp. 70.
- [7] CR, Resolution 1, in: 13th CGPM, 1967/68, pp. 103.
- [8] CIPM, Resolution 2, 20 (1946) 129-137.
- [9] CR, Resolution 3, in: 13th CGPM, 1967/68, pp. 104.
- [10] CR, Resolution 4, in: 13th CGPM, 1967/68, pp. 104.
- [11] CR, Resolution 3, in: 14th CGPM, 1971, pp. 78.
- [12] CR, Resolution 3, in: 16th CGPM, 1979, pp. 100.
- [13] G. Genta, *Methods for Uncertainty Evaluation in Measurement*, Saarbrücken, VDM Verlag, (2010).
- [14] J. Marriot, G. O'Conner, H. Parkes, Final Report: Study on Measurement Services and Comparison Needs for an International Measurement Infrastructure for the Biosciences and Biotechnology : Input for the BIPM Work Programm, Rapport BIPM-2011/02, Reprot Number: LGC/R2011/123 Number, BIPM, (2011).
- [15] P. Sang-Ryoul, C. Jun-Hyuk, J. Ji-Seon, Development of metrology for modern biology, in: L. Cocco (Ed.) *Modern Metrology Concerns*, InTech, 2012, pp. 419-446.
- [16] W.D. O'Brien, Jr., Ultrasound-biophysics mechanisms, *Prog Biophys Mol Biol*, 93 (2007) 212-255.
- [17] J.W. Costerton, G.G. Geesey, K.J. Cheng, How bacteria stick, *Sci Am*, 238 (1978) 86-95.
- [18] R.M. Donlan, Biofilms: microbial life on surfaces, *Emerg Infect Dis*, 8 (2002) 881-890.
- [19] R.M. Donlan, J.W. Costerton, Biofilms: survival mechanisms of clinically relevant microorganisms, *Clin Microbiol Rev*, 15 (2002) 167-193.
- [20] M.S. Aparna, S. Yadav, Biofilms: microbes and disease, *Braz J Infect Dis*, 12 (2008) 526-530.
- [21] H.J. Busscher, H.C. van der Mei, Physico-chemical interactions in initial microbial adhesion and relevance for biofilm formation, *Adv Dent Res*, 11 (1997) 24-32.



- [22] J.A. Hornemann, A.A. Lysova, S.L. Codd, J.D. Seymour, S.C. Busse, P.S. Stewart, J.R. Brown, Biopolymer and water dynamics in microbial biofilm extracellular polymeric substance, *Biomacromolecules*, 9 (2008) 2322-2328.
- [23] T. Tolker-Nielsen, S. Molin, Spatial Organization of Microbial Biofilm Communities, *Microb Ecol*, 40 (2000) 75-84.
- [24] D. de Beer, P. Stoodley, Z. Lewandowski, Liquid flow in heterogeneous biofilms, *Biotechnol Bioeng*, 44 (1994) 636-641.
- [25] O. Karatuna, A. Yagci, Analysis of quorum sensing-dependent virulence factor production and its relationship with antimicrobial susceptibility in *Pseudomonas aeruginosa* respiratory isolates, *Clin Microbiol Infect*, (2010).
- [26] N. Hoiby, T. Bjarnsholt, M. Givskov, S. Molin, O. Ciofu, Antibiotic resistance of bacterial biofilms, *Int J Antimicrob Agents*, 35 (2010) 322-332.
- [27] T. Bjarnsholt, P.O. Jensen, T.H. Jakobsen, R. Phipps, A.K. Nielsen, M.T. Rybtke, T. Tolker-Nielsen, M. Givskov, N. Hoiby, O. Ciofu, Quorum sensing and virulence of *Pseudomonas aeruginosa* during lung infection of cystic fibrosis patients, *PLoS One*, 5 (2010) e10115.
- [28] M.E. Olson, H. Ceri, D.W. Morck, A.G. Buret, R.R. Read, Biofilm bacteria: formation and comparative susceptibility to antibiotics, *Can J Vet Res*, 66 (2002) 86-92.
- [29] G. Denotti, R. Piga, C. Montaldo, M. Erriu, F. Pilia, A. Piras, M.D. Luca, G. Orru, In Vitro Evaluation of *Enterococcus faecalis* Adhesion on Various Endodontic Medicaments, *Open Dent J*, 3 (2009) 120-124.
- [30] T. Monsen, E. Lovgren, M. Widerstrom, L. Wallinder, In vitro effect of ultrasound on bacteria and suggested protocol for sonication and diagnosis of prosthetic infections, *J Clin Microbiol*, 47 (2009) 2496-2501.
- [31] T.A. Bigelow, T. Northagen, T.M. Hill, F.C. Sailer, The destruction of *Escherichia coli* biofilms using high-intensity focused ultrasound, *Ultrasound Med Biol*, 35 (2009) 1026-1031.
- [32] I. Ioannou, N. Dimitriadis, K. Papadimitriou, D. Sakellari, I. Vouros, A. Konstantinidis, Hand instrumentation versus ultrasonic debridement in the treatment of chronic periodontitis: a randomized clinical and microbiological trial, *J Clin Periodontol*, 36 (2009) 132-141.
- [33] F. Kirzhner, Y. Zimmels, A. Malkovskaja, J. Starosvetsky, Removal of microbial biofilm on Water Hyacinth plants roots by ultrasonic treatment, *Ultrasonics*, 49 (2009) 153-158.
- [34] P. Piyasena, E. Mohareb, R.C. McKellar, Inactivation of microbes using ultrasound: a review, *Int J Food Microbiol*, 87 (2003) 207-216.



- [35] G. Plotino, C.H. Pameijer, N.M. Grande, F. Somma, Ultrasonics in endodontics: a review of the literature, *J Endod*, 33 (2007) 81-95.
- [36] G. ter Haar, Therapeutic ultrasound, *Eur J Ultrasound*, 9 (1999) 3-9.
- [37] S. Oda, H. Nitta, T. Setoguchi, Y. Izumi, I. Ishikawa, Current concepts and advances in manual and power-driven instrumentation, *Periodontol* 2000, 36 (2004) 45-58.
- [38] G. Greenstein, Nonsurgical periodontal therapy in 2000: a literature review, *J Am Dent Assoc*, 131 (2000) 1580-1592.
- [39] F.V. Ribeiro, R.C. Casarin, F.H. Nociti Junior, E.A. Sallum, A.W. Sallum, M.Z. Casati, Comparative in vitro study of root roughness after instrumentation with ultrasonic and diamond tip sonic scaler, *J Appl Oral Sci*, 14 (2006) 124-129.
- [40] C.L. Drisko, D.L. Cochran, T. Blieden, O.J. Bouwsma, R.E. Cohen, P. Damoulis, J.B. Fine, G. Greenstein, J. Hinrichs, M.J. Somerman, V. Iacono, R.J. Genco, Position paper: sonic and ultrasonic scalers in periodontics. Research, Science and Therapy Committee of the American Academy of Periodontology, *J Periodontol*, 71 (2000) 1792-1801.
- [41] R. O'Leary, A.M. Sved, E.H. Davies, T.G. Leighton, M. Wilson, J.B. Kieser, The bactericidal effects of dental ultrasound on *Actinobacillus actinomycetemcomitans* and *Porphyromonas gingivalis*. An in vitro investigation, *J Clin Periodontol*, 24 (1997) 432-439.
- [42] G. Zucchelli, I. Mounssif, M. Stefanini, M. Mele, L. Montebugnoli, N.M. Sforza, Hand and ultrasonic instrumentation in combination with root-coverage surgery: a comparative controlled randomized clinical trial, *J Periodontol*, 80 (2009) 577-585.
- [43] S.C. Trenter, A.D. Walmsley, Ultrasonic dental scaler: associated hazards, *J Clin Periodontol*, 30 (2003) 95-101.
- [44] G. Scherba, R.M. Weigel, W.D. O'Brien, Jr., Quantitative assessment of the germicidal efficacy of ultrasonic energy, *Appl Environ Microbiol*, 57 (1991) 2079-2084.
- [45] K.G. Baker, V.J. Robertson, F.A. Duck, A review of therapeutic ultrasound: biophysical effects, *Phys Ther*, 81 (2001) 1351-1358.
- [46] V.J. Robertson, K.G. Baker, A review of therapeutic ultrasound: effectiveness studies, *Phys Ther*, 81 (2001) 1339-1350.
- [47] H.R. Guzman, A.J. McNamara, D.X. Nguyen, M.R. Prausnitz, Bioeffects caused by changes in acoustic cavitation bubble density and cell concentration: a unified explanation based on cell-to-bubble ratio and blast radius, *Ultrasound Med Biol*, 29 (2003) 1211-1222.
- [48] G. ter Haar, Biological effects of ultrasound in clinical applications., in: K.S. Suslick (Ed.) *Ultrasound: Its Chemical, Physical, and Biological Effects.*, VCH Publishers Inc, New York, 1988, pp. 305-320.



- [49] W.L. Nyborg, Ultrasonic microstreaming and related phenomena, *Br J Cancer Suppl*, 5 (1982) 156-160.
- [50] W.G. Pitt, S.A. Ross, Ultrasound increases the rate of bacterial cell growth, *Biotechnol Prog*, 19 (2003) 1038-1044.
- [51] T. Kodama, Y. Tomita, K. Koshiyama, M.J. Blomley, Transfection effect of microbubbles on cells in superposed ultrasound waves and behavior of cavitation bubble, *Ultrasound Med Biol*, 32 (2006) 905-914.
- [52] E. Joyce, S.S. Phull, J.P. Lorimer, T.J. Mason, The development and evaluation of ultrasound for the treatment of bacterial suspensions. A study of frequency, power and sonication time on cultured *Bacillus* species, *Ultrason Sonochem*, 10 (2003) 315-318.
- [53] C.M. Runyan, J.C. Carmen, B.L. Beckstead, J.L. Nelson, R.A. Robison, W.G. Pitt, Low-frequency ultrasound increases outer membrane permeability of *Pseudomonas aeruginosa*, *J Gen Appl Microbiol*, 52 (2006) 295-301.
- [54] S.M. Gracewski, H. Miao, D. Dalecki, Ultrasonic excitation of a bubble near a rigid or deformable sphere: implications for ultrasonically induced hemolysis, *J Acoust Soc Am*, 117 (2005) 1440-1447.
- [55] H. Miao, S.M. Gracewski, D. Dalecki, Ultrasonic excitation of a bubble inside a deformable tube: implications for ultrasonically induced hemorrhage, *J Acoust Soc Am*, 124 (2008) 2374-2384.
- [56] W.G. Pitt, M.O. McBride, J.K. Lunceford, R.J. Roper, R.D. Sagers, Ultrasonic enhancement of antibiotic action on gram-negative bacteria, *Antimicrob Agents Chemother*, 38 (1994) 2577-2582.
- [57] S.S. Phull, A.P. Newman, J.P. Lorimer, B. Pollet, T.J. Mason, The development and evaluation of ultrasound in the biocidal treatment of water, *Ultrason Sonochem*, 4 (1997) 157-164.
- [58] A.M. Rediske, W.C. Hymas, R. Wilkinson, W.G. Pitt, Ultrasonic enhancement of antibiotic action on several species of bacteria, *J Gen Appl Microbiol*, 44 (1998) 283-288.
- [59] A.M. Rediske, N. Rapoport, W.G. Pitt, Reducing bacterial resistance to antibiotics with ultrasound, *Lett Appl Microbiol*, 28 (1999) 81-84.
- [60] R.V. Peterson, W.G. Pitt, The effect of frequency and power density on the ultrasonically-enhanced killing of biofilm-sequestered *Escherichia coli*, *Colloids and Surfaces B: Biointerfaces*, 17 (2000) 219-227.
- [61] H. Duckhouse, T.J. Mason, S.S. Phull, J.P. Lorimer, The effect of sonication on microbial disinfection using hypochlorite, *Ultrason Sonochem*, 11 (2004) 173-176.



- [62] K.D. Stanley, D.A. Golden, R.C. Williams, J. Weiss, Inactivation of *Escherichia coli* O157:H7 by high-intensity ultrasonication in the presence of salts, *Foodborne Pathog Dis*, 1 (2004) 267-280.
- [63] R.W. Wood, A.L. Loomis, The physical and biological effects of high frequency sound waves of great intensity., *Phil Mag*, 4 (1927) 417-436.
- [64] T.A. Bigelow, T. Northagen, T.M. Hill, F.C. Sailer, Ultrasound histotripsy and the destruction of *Escherichia coli* biofilms, *Conf Proc IEEE Eng Med Biol Soc*, 2008 (2008) 4467-4470.
- [65] L. Gerdesmeyer, C. von Eiff, C. Horn, M. Henne, M. Roessner, P. Diehl, H. Gollwitzer, Antibacterial effects of extracorporeal shock waves, *Ultrasound Med Biol*, 31 (2005) 115-119.
- [66] G.T. Ensing, D. Neut, J.R. van Horn, H.C. van der Mei, H.J. Busscher, The combination of ultrasound with antibiotics released from bone cement decreases the viability of planktonic and biofilm bacteria: an in vitro study with clinical strains, *J Antimicrob Chemother*, 58 (2006) 1287-1290.
- [67] G.T. Ensing, B.L. Roeder, J.L. Nelson, J.R. van Horn, H.C. van der Mei, H.J. Busscher, W.G. Pitt, Effect of pulsed ultrasound in combination with gentamicin on bacterial viability in biofilms on bone cements in vivo, *J Appl Microbiol*, 99 (2005) 443-448.
- [68] P.J. Sanderson, Infection in orthopaedic implants, *J Hosp Infect*, 18 Suppl A (1991) 367-375.
- [69] J.C. Carmen, B.L. Roeder, J.L. Nelson, B.L. Beckstead, C.M. Runyan, G.B. Schaalje, R.A. Robison, W.G. Pitt, Ultrasonically enhanced vancomycin activity against *Staphylococcus epidermidis* biofilms in vivo, *J Biomater Appl*, 18 (2004) 237-245.
- [70] J.C. Carmen, B.L. Roeder, J.L. Nelson, R.L. Ogilvie, R.A. Robison, G.B. Schaalje, W.G. Pitt, Treatment of biofilm infections on implants with low-frequency ultrasound and antibiotics, *Am J Infect Control*, 33 (2005) 78-82.
- [71] K.D. Xu, G.A. McFeters, P.S. Stewart, Biofilm resistance to antimicrobial agents, *Microbiology*, 146 (Pt 3) (2000) 547-549.
- [72] P.S. Stewart, L. Grab, J.A. Diemer, Analysis of biocide transport limitation in an artificial biofilm system, *J Appl Microbiol*, 85 (1998) 495-500.
- [73] S.L. Bardy, S.Y. Ng, K.F. Jarrell, Prokaryotic motility structures, *Microbiology*, 149 (2003) 295-304.
- [74] J.G. Mitchell, K. Kogure, Bacterial motility: links to the environment and a driving force for microbial physics, *FEMS Microbiol Ecol*, 55 (2006) 3-16.



- [75] N. Oulahal-Lagsir, A. Martial-Gros, E. Boistier, L.J. Blum, M. Bonneau, The development of an ultrasonic apparatus for the noninvasive and repeatable removal of fouling in food processing equipment, *Lett Appl Microbiol*, 30 (2000) 47-52.
- [76] A.D. Walmsley, W.R. Laird, A.R. Williams, Dental plaque removal by cavitation activity during ultrasonic scaling, *J Clin Periodontol*, 15 (1988) 539-543.
- [77] A.J. Singer, C.T. Coby, A.H. Singer, H.C. Thode, Jr., G.T. Tortora, The effects of low-frequency ultrasound on *Staphylococcus epidermidis*, *Curr Microbiol*, 38 (1999) 194-196.
- [78] I. Sutherland, Biofilm exopolysaccharides: a strong and sticky framework, *Microbiology*, 147 (2001) 3-9.
- [79] Z. Qian, P. Stoodley, W.G. Pitt, Effect of low-intensity ultrasound upon biofilm structure from confocal scanning laser microscopy observation, *Biomaterials*, 17 (1996) 1975-1980.
- [80] A.M. Rediske, B.L. Roeder, M.K. Brown, J.L. Nelson, R.L. Robison, D.O. Draper, G.B. Schaalje, R.A. Robison, W.G. Pitt, Ultrasonic enhancement of antibiotic action on *Escherichia coli* biofilms: an in vivo model, *Antimicrob Agents Chemother*, 43 (1999) 1211-1214.
- [81] P.A. Lambert, Mechanisms of antibiotic resistance in *Pseudomonas aeruginosa*, *J R Soc Med*, 95 Suppl 41 (2002) 22-26.
- [82] J.D. Cavallo, P. Plesiat, G. Couetdic, F. Leblanc, R. Fabre, Mechanisms of beta-lactam resistance in *Pseudomonas aeruginosa*: prevalence of OprM-overproducing strains in a French multicentre study (1997), *J Antimicrob Chemother*, 50 (2002) 1039-1043.
- [83] A.S. Andersen, B. Joergensen, T. Bjarnsholt, H. Johansen, T. Karlsmark, M. Givskov, K.A. Kroghfelt, Quorum-sensing-regulated virulence factors in *Pseudomonas aeruginosa* are toxic to *Lucilia sericata* maggots, *Microbiology*, 156 (2010) 400-407.
- [84] L.C. Antunes, R.B. Ferreira, M.M. Buckner, B.B. Finlay, Quorum sensing in bacterial virulence, *Microbiology*, 156 (2010) 2271-2282.
- [85] R.P. Ryan, J.M. Dow, Diffusible signals and interspecies communication in bacteria, *Microbiology*, 154 (2008) 1845-1858.
- [86] M.M. Tavio, V.D. Aquili, J.B. Poveda, N.T. Antunes, J. Sanchez-Cespedes, J. Vila, Quorum-sensing regulator *sdiA* and *marA* overexpression is involved in in vitro-selected multidrug resistance of *Escherichia coli*, *J Antimicrob Chemother*, 65 (2010) 1178-1186.
- [87] C. Ryder, M. Byrd, D.J. Wozniak, Role of polysaccharides in *Pseudomonas aeruginosa* biofilm development, *Curr Opin Microbiol*, 10 (2007) 644-648.
- [88] G. Ramage, S.P. Saville, D.P. Thomas, J.L. Lopez-Ribot, *Candida* biofilms: an update, *Eukaryot Cell*, 4 (2005) 633-638.



- [89] J.C. Davies, D. Bilton, Bugs, biofilms, and resistance in cystic fibrosis, *Respir Care*, 54 (2009) 628-640.
- [90] K.P. Lemon, A.M. Earl, H.C. Vlamakis, C. Aguilar, R. Kolter, Biofilm development with an emphasis on *Bacillus subtilis*, *Curr Top Microbiol Immunol*, 322 (2008) 1-16.
- [91] R. Podschun, U. Ullmann, *Klebsiella* spp. as nosocomial pathogens: epidemiology, taxonomy, typing methods, and pathogenicity factors, *Clin Microbiol Rev*, 11 (1998) 589-603.
- [92] E.M. Kojic, R.O. Darouiche, *Candida* infections of medical devices, *Clin Microbiol Rev*, 17 (2004) 255-267.
- [93] C. Beloin, A. Roux, J.M. Ghigo, *Escherichia coli* biofilms, *Curr Top Microbiol Immunol*, 322 (2008) 249-289.
- [94] K. O'Riordan, J.C. Lee, *Staphylococcus aureus* capsular polysaccharides, *Clin Microbiol Rev*, 17 (2004) 218-234.
- [95] B. Henderson, M. Wilson, L. Sharp, J.M. Ward, *Actinobacillus actinomycetemcomitans*, *J Med Microbiol*, 51 (2002) 1013-1020.
- [96] A.M. Earl, R. Losick, R. Kolter, Ecology and genomics of *Bacillus subtilis*, *Trends Microbiol*, 16 (2008) 269-275.
- [97] M. Otto, *Staphylococcal* biofilms, *Curr Top Microbiol Immunol*, 322 (2008) 207-228.
- [98] D. Djordjevic, M. Wiedmann, L.A. McLandsborough, Microtiter plate assay for assessment of *Listeria monocytogenes* biofilm formation, *Appl Environ Microbiol*, 68 (2002) 2950-2958.
- [99] H. Anwar, J.L. Strap, J.W. Costerton, Eradication of biofilm cells of *Staphylococcus aureus* with tobramycin and cephalexin, *Can J Microbiol*, 38 (1992) 618-625.
- [100] D. Lindsay, A. von Holy, Evaluation of dislodging methods for laboratory-grown bacterial biofilms, *Food Microbiol.*, 14 (1997) 383-390.
- [101] M. Fletcher, The effects of culture concentration and age, time, and temperature on bacterial attachment to polystyrene, *Can. J. Microbiol.*, 23 (1977) 1-6.
- [102] G.A. O'Toole, R. Kolter, Initiation of biofilm formation in *Pseudomonas fluorescens* WCS365 proceeds via multiple, convergent signalling pathways: a genetic analysis, *Mol Microbiol*, 28 (1998) 449-461.
- [103] D.W. Jackson, K. Suzuki, L. Oakford, J.W. Simecka, M.E. Hart, T. Romeo, Biofilm formation and dispersal under the influence of the global regulator CsrA of *Escherichia coli*, *J Bacteriol*, 184 (2002) 290-301.
- [104] E. Burton, N. Yakandawala, K. LoVetri, M.S. Madhyastha, A microplate spectrofluorometric assay for bacterial biofilms, *J Ind Microbiol Biotechnol*, 34 (2007) 1-4.



- [105] B.A. Perez, P.J. Planet, S.C. Kachlany, M. Tomich, D.H. Fine, D.H. Figurski, Genetic analysis of the requirement for *flp-2*, *tadV*, and *rcpB* in *Actinobacillus actinomycetemcomitans* biofilm formation, *J Bacteriol*, 188 (2006) 6361-6375.
- [106] J.J. Amarasinghe, F.A. Scannapieco, E.M. Haase, Transcriptional and translational analysis of biofilm determinants of *Aggregatibacter actinomycetemcomitans* in response to environmental perturbation, *Infect Immun*, 77 (2009) 2896-2907.
- [107] G. Orru, S. Del Nero, E. Tuveri, M. Laura Ciusa, F. Pilia, M. Erriu, M. Liciardi, V. Piras, G. Denotti, Evaluation of antimicrobial-antibiofilm activity of a hydrogen peroxide decontaminating system used in dental unit water lines, *Open Dent J*, 4 (2010) 140-146.
- [108] C. Schroll, K.B. Barken, K.A. Krogfelt, C. Struve, Role of type 1 and type 3 fimbriae in *Klebsiella pneumoniae* biofilm formation, *BMC Microbiol*, 10 (2010) 179.
- [109] G. Orru, M.F. Marini, M.L. Ciusa, D. Isola, M. Cotti, M. Baldoni, V. Piras, E. Pisano, C. Montaldo, Usefulness of real time PCR for the differentiation and quantification of 652 and JP2 *Actinobacillus actinomycetemcomitans* genotypes in dental plaque and saliva, *BMC Infect Dis*, 6 (2006) 98.
- [110] EA-4/02, Expression of the Uncertainty of Measurement in Calibration, European co-operation for Accreditation, (1999).
- [111] G. Barbato, A. Germak, D. D'Agostino, *Misurare per Decidere*, Progetto Leonardo, Bologna, 2005.
- [112] R.A. Fisher, *Statistical methods for research workers*, Oliver and Boyd, Edinburgh, London, 1925.
- [113] M. Erriu, Genta, G., Tuveri, E., Orrù, G., Barbato, G., Levi, R., Microtiter spectrophotometric biofilm production assay analysed with metrological methods and uncertainty evaluation, *Measurement*, 45 (2012) 1083-1088.
- [114] G.D. Christensen, W.A. Simpson, J.J. Younger, L.M. Baddour, F.F. Barrett, D.M. Melton, E.H. Beachey, Adherence of coagulase-negative staphylococci to plastic tissue culture plates: a quantitative model for the adherence of staphylococci to medical devices, *J Clin Microbiol*, 22 (1985) 996-1006.
- [115] J.G. Szabo, E.W. Rice, P.L. Bishop, Persistence of *Klebsiella pneumoniae* on simulated biofilm in a model drinking water system, *Environ Sci Technol*, 40 (2006) 4996-5002.
- [116] J.A. Crump, P.J. Collignon, Intravascular catheter-associated infections, *Eur J Clin Microbiol Infect Dis*, 19 (2000) 1-8.
- [117] J.A. Mohamed, D.B. Huang, Biofilm formation by enterococci, *J Med Microbiol*, 56 (2007) 1581-1588.



- [118] M. Hufnagel, S. Koch, R. Creti, L. Baldassarri, J. Huebner, A putative sugar-binding transcriptional regulator in a novel gene locus in *Enterococcus faecalis* contributes to production of biofilm and prolonged bacteremia in mice, *J Infect Dis*, 189 (2004) 420-430.
- [119] T.R. De Kievit, Quorum sensing in *Pseudomonas aeruginosa* biofilms, *Environmental Microbiology*, 11 (2009) 279-288.
- [120] T.K. Wood, A.F. Gonzalez Barrios, M. Herzberg, J. Lee, Motility influences biofilm architecture in *Escherichia coli*, *Appl Microbiol Biotechnol*, 72 (2006) 361-367.
- [121] S. Drakopoulou, S. Terzakis, M.S. Fountoulakis, D. Mantzavinos, T. Manios, Ultrasound-induced inactivation of gram-negative and gram-positive bacteria in secondary treated municipal wastewater, *Ultrason Sonochem*, 16 (2009) 629-634.
- [122] A.C. Vollmer, S. Kwakye, M. Halpern, E.C. Everbach, Bacterial stress responses to 1-megahertz pulsed ultrasound in the presence of microbubbles, *Appl Environ Microbiol*, 64 (1998) 3927-3931.
- [123] J.S. Chapman, R. Ferguson, C. Consalo, T. Bliss, Bacteriostatic Effect of Sequential Hydrodynamic and Ultrasound-induced Stress, *J Appl Microbiol*, (2013).

8. ACKNOWLEDGMENTS

- Prof Giulio Barbato, Politecnico di Torino
- Dr Germano Orrù and all the Oral Biotechnology Laboratory (OBL), Università degli Studi di Cagliari
- Prof Vincenzo Piras, Università degli Studi di Cagliari
- Dr Cornelio Blus
- Dr Serge Szmukler-Moncler
- Dr Alessandro Germak, INRIM, Turin
- Dr Gianfranco Genta, Politecnico di Torino
- Dr Daniele Madonnaripa and all the Acoustic Department, INRIM, Turin
- Dr Silvano Buogo, CNR of Rome
- Prof Guido Pegna, Università degli Studi di Cagliari
- Dr Francesca MG Pili, Università degli Studi di Cagliari
- DIGEP Workshop, Politecnico di Torino
- Dr Luca Licheri and all the Oral Surgery Department of the King's College Hospital of London

