

6-27-2015

Police Integrity Lost: Police Crime in the United States

Philip M. Stinson

Bowling Green State University, stinspm@bgsu.edu

Follow this and additional works at: https://scholarworks.bgsu.edu/crim_just_pub



Part of the [Criminology Commons](#), and the [Criminology and Criminal Justice Commons](#)

Repository Citation

Stinson, Philip M., "Police Integrity Lost: Police Crime in the United States" (2015). *Criminal Justice Faculty Publications*. 52.

https://scholarworks.bgsu.edu/crim_just_pub/52

This Presentation is brought to you for free and open access by the Human Services at ScholarWorks@BGSU. It has been accepted for inclusion in Criminal Justice Faculty Publications by an authorized administrator of ScholarWorks@BGSU.

Police Integrity Lost: Police Crime in the United States

Philip Stinson, J.D., Ph.D.

Bowling Green State University

Presented at Porcfest XII
Lancaster, New Hampshire
June 27, 2015

This project was supported by Award No. 2011-IJ-CX-0024, awarded by the National Institute of Justice, Office of Justice Programs, U.S. Department of Justice. The opinions, findings, and conclusions or recommendations expressed in this research presentation are those of the author(s) and do not necessarily reflect those of the Department of Justice.

Police Crime – Literature Review

- Independent Commission Reports:
 - Knapp Commission (1972)
 - Pennsylvania Crime Commission (1974)
 - Mollen Commission (1994)
- Newspaper Investigative Reporting:
 - *New York Times* (1970s)
 - *Boston Globe* (1980s)
 - *Philadelphia Inquirer* (1990s and 2006)
- Research in Criminology / Social Sciences:
 - *The Police and the Public* (Reiss, 1971)
 - *Scandal and Reform* (Sherman, 1978)
 - *Forces of Deviance* (Kappeler, et al., 1998)
 - *Driving while Female* (Walker, 2002, 2003)
 - *Bad Cops: A Study of Career-Ending Misconduct Among New NYPD Officers* (Fyfe & Kane, 2006)
 - *Police Integrity Lost* (Stinson, et al., 2014)

Method

- Multiyear study on police crime.
- Content analysis of news articles.
- Use Google News search engine and Google Alerts email update service.
- The unit of analysis is *criminal arrest case*.
- This presentation summarizes the criminal arrest cases of nonfederal sworn law enforcement officers across the United States during the years 2005-2011.
- Intercoder reliability overall simple agreement between two coders exceeded 97.7% across all variables. Krippendorff's Alpha coefficients are strong ($\alpha=.9153$).

Strengths & Limitations

- Google News is a preferred method to conduct news-based content analysis research.
- The research is limited by the content and quality of information provided on each case.
- The data are limited to cases that involved an official arrest.
- These data are the result of a filtering process that includes the exercise of discretion by media sources in terms of types of stories covered and the nature of the content devoted to particular stories.



Document Imaging

Scan Queues:

- Criminal Justice
- Awaiting Index (36)
- Index in Progress (0)
- Awaiting Full-Page OCR (0)
- Awaiting Commit (9)
- Committed
- Scheduled Processes

Scan Format: Multiple(One-Sided)

Scan Mode: No Index Pre-Index Full Index

Document Type: _____

Document Date: 06/12/2012

Keywords

Index Append Clear Keys Scan

Batches in Criminal Justice

Offender Name (Last, First) _____

Offender's Employer / Agency DeKalb CO Sheriff

Decatur (DeKalb Co.) GA FIPS: 13089

City (County) & State

Case # 141414

Case Ref: _____
(i.e., Victim #, Arrest #)

Date of Arrest 05/10/2012
(mm/dd/yyyy)

N-Number NO5140

NEW CASE LOGGED IN BY: gcu

TODAY'S DATE: 06/05/2012

APPROVED BY: PS

DATA ENTERED INTO ONBASE BY: gcu

CASE FILES SCANNED INTO ONBASE BY: _____

NEW CASE LOG-IN SHEET

MEETS CASE ELIGIBILITY CRITERIA (SEE BELOW CRITERIA)

CHECKED NAME/ARREST AGAINST EXISTING BOOKING SHEET DATABASE

THIS IS A "NEW" OFFICER NOT FOUND IN OUR DATA BASE OR

THIS IS AN OFFICER WHO IS ALREADY IN OUR DATASET FOR A DIFFERENT ARREST/CASE AND HIS/HER EXISTING N-NUMBER IS INDICATED IN THE BOX ABOVE

VERIFIED AGENCY, COUNTY, STATE & FIPS ON CSLLIA 2008 DATA SET

- Case Eligibility Criteria:**
- The person was employed as a sworn non-sworn law enforcement officer:
 - at the time of their arrest.
 - at the time of apprehension of the criminal for which they were arrested.
 - The term "officer" includes sworn law enforcement officers with general powers of arrest and includes officers, troopers, deputies, constables, etc. An "officer" includes all ranks (e.g., officers, detectives, investigators, corporals, sergeants, lieutenants, captains, majors, colonels, inspectors, deputy chiefs, chief deputies, chiefs, sheriffs, commissioners, etc.).
 - The officer was arrested on or after January 1, 2005.
 - The officer's employing non-sworn law enforcement agency must be located within the United States (limited to those areas within and/or outside of the 50 states and the District of Columbia).
 - "Officer" includes those who are employed full-time and/or part-time, as well as officers who are auxiliary or reserve officers.
 - "Arrests" include arrests, indictments, charge by criminal information, charge by summons, etc. for criminal offenses. Traffic tickets alone do not meet the criteria for inclusion as a "case" in this research study.
 - Use FIPS code for the county where the arrested officer's employing agency is located. For officers employed by a state or multi-county agency, use the FIPS code for the county where the officer regularly works (eg where the agency HQ is located).

OnBase Client (onbase)

File Document User Processing Window Help

Document Imaging

Scan Queues:

- Criminal Justice
- Awaiting Index (36)
- Index in Progress (0)
- Awaiting Full-Page OCR (0)
- Awaiting Commit (9)
- Committed
- Scheduled Processes

Scan Format: Multiple(One-Sided)

Scan Mode: No Index Pre-index Full Index

Document Type: []

Document Date: 06/12/2012

Keywords: []

Index Append Clear Keys Scan

Batches in Criminal Justice

Batch #	Batch Name	Scan Date - Time	Status	Total Documents	# not Indexed
94971	2012-05-30 - STINSPM Coding Sheets - New Case LogIn S...	2012-05-30 - 12:35:25	Awaiting Commit	85	0
94974	2012-05-30 - STINSPM Case Articles	2012-05-30 - 12:46:58	Awaiting Index	262	262
94977	2012-05-30 - STINSPM Supp Case Articles	2012-05-30 - 12:56:06	Awaiting Index	80	80
94978	2012-05-30 - STINSPM Case Articles	2012-05-30 - 12:58:45	Awaiting Index	98	98
95041	2012-05-30 - STINSPM Supp Case Articles	2012-05-30 - 20:02:31	Awaiting Index	148	148
95042	2012-05-30 - STINSPM Case Articles	2012-05-30 - 20:07:53	Awaiting Commit	7	0
95418	2012-06-01 - STINSPM Case Articles	2012-06-01 - 12:31:31	Awaiting Index	23	23
95419	2012-06-01 - STINSPM Supp Case Articles	2012-06-01 - 12:35:37	Awaiting Index	28	28
95420	2012-06-01 - STINSPM Coding Sheets: New Case LogIn S...	2012-06-01 - 12:41:37	Awaiting Commit	12	0
95421	2012-06-01 - STINSPM Coding Sheets: New Case LogIn S...	2012-06-01 - 12:43:59	Awaiting Commit	25	0
95422	2012-06-01 - STINSPM Case Articles	2012-06-01 - 12:46:03	Awaiting Index	121	121
95425	2012-06-01 - STINSPM Case Articles	2012-06-01 - 13:29:54	Awaiting Index	113	113
95427	2012-06-01 - STINSPM Coding Sheets: New Case LogIn S...	2012-06-01 - 13:35:49	Awaiting Commit	36	0
95460	2012-06-01 - STINSPM Case Articles	2012-06-01 - 15:06:44	Awaiting Commit	10	0
95478	2012-06-02 - STINSPM Case Articles - Case # 6491	2012-06-02 - 19:32:48	Awaiting Index	43	43
95479	2012-06-02 - STINSPM Case Articles	2012-06-02 - 20:16:07	Awaiting Index	38	38
95480	2012-06-02 - STINSPM Case Articles #6498 - Culpeper VA	2012-06-02 - 20:38:16	Awaiting Index	36	36
95481	2012-06-02 - STINSPM Coding Sheets: New Case LogIn S...	2012-06-02 - 20:41:56	Awaiting Commit	9	0
95605	2012-06-04 - STINSPM Case Articles	2012-06-04 - 12:05:20	Awaiting Index	96	96
95772	2012-06-04 - STINSPM Supp & New Case Articles	2012-06-04 - 15:51:40	Awaiting Index	87	87
95855	2012-06-04 - STINSPM Coding Sheets: New Case LogIn S...	2012-06-04 - 17:04:31	Awaiting Index	63	63
95856	2012-06-04 - STINSPM Case Articles for Case # 6549	2012-06-04 - 17:08:48	Awaiting Index	54	54
95857	2012-06-04 - STINSPM Case Articles	2012-06-04 - 17:11:21	Awaiting Index	57	57
96005	2012-06-05 - STINSPM Supp Coding Sheets	2012-06-05 - 14:52:10	Awaiting Index	47	47
96007	2012-06-05 - STINSPM Case Articles	2012-06-05 - 14:57:41	Awaiting Index	70	70
96012	2012-06-05 - STINSPM Coding Sheets: New Case LogIn S...	2012-06-05 - 15:10:34	Awaiting Index	19	19
96405	2012-06-06 - STINSPM Case Articles	2012-06-06 - 12:55:36	Awaiting Index	110	110
96406	2012-06-06 - STINSPM Coding Sheets: New Case LogIn S...	2012-06-06 - 12:58:32	Awaiting Index	25	25
96407	2012-06-06 - STINSPM Case Articles	2012-06-06 - 13:08:19	Awaiting Index	32	32
96481	2012-06-06 - STINSPM Supp Case Articles	2012-06-06 - 17:11:27	Awaiting Index	29	29
96623	2012-06-07 - STINSPM Case Articles	2012-06-07 - 17:37:01	Awaiting Index	30	30
96624	2012-06-07 - STINSPM Coding Sheets: New Case LogIn S...	2012-06-07 - 17:39:10	Awaiting Index	11	11
96878	2012-06-08 - STINSPM Coding Sheets: New Case LogIn S...	2012-06-08 - 16:06:50	Awaiting Index	51	51
96880	2012-06-08 - STINSPM Case Articles	2012-06-08 - 16:09:52	Awaiting Index	73	73
96895	2012-06-08 - STINSPM Case Articles	2012-06-08 - 16:20:12	Awaiting Index	144	144
96901	2012-06-08 - STINSPM Case Articles - Case #6632	2012-06-08 - 16:24:25	Awaiting Index	57	57
96905	2012-06-08 - STINSPM Case Articles - Case #6634	2012-06-08 - 16:26:59	Awaiting Index	53	53
96909	2012-06-08 - STINSPM Case Articles - Case #6635	2012-06-08 - 16:29:43	Awaiting Index	46	46
96912	2012-06-08 - STINSPM Case Articles - Case #6636	2012-06-08 - 16:32:13	Awaiting Index	31	31
96915	2012-06-08 - STINSPM Case Articles - Case #6637	2012-06-08 - 16:34:44	Awaiting Index	65	65
96916	2012-06-08 - STINSPM Supp Case Articles - Case #4388	2012-06-08 - 16:37:33	Awaiting Index	30	30
96935	2012-06-09 - STINSPM Coding Sheets: New Case LogIn S...	2012-06-09 - 12:22:38	Awaiting Commit	2	0
96936	2012-06-09 - STINSPM Case Articles - Cases #6657 and th...	2012-06-09 - 12:24:56	Awaiting Commit	3	0

0 Documents Selected

Start OnBase Client (onbase) 6:51 PM

Offender List - Windows Internet Explorer
 http://onbase.bgsu.edu/PopNet/WorkView/viewObject.aspx

Offender List: History Documents

Offender List Created By: BGSUCHAD
2/13/2012 11:25:17 PM

CRIMINAL JUSTICE - POLICE CRIME RESEARCH PROJECT
 Booking Sheet - New Case Entry

N-number

Last First Middle Suffix

Alias

Notes

Case Data + Add - Delete Edit

Case Number	Employing Agency	County	State	Date of Arrest	Case Ref
2241	Schenectady PD	Schenectady County	NY	12/27/2008	Arrest #4 (DWI)
2547	Schenectady PD	Schenectady County	NY	01/23/2010	Arrest #7 (DWI in hospital parking lot)
4462	Schenectady PD	Schenectady County	NY	01/11/2009	Arrest #5 (Criminal Mischief)
4706	Schenectady PD	Schenectady County	NY	03/27/2010	Arrest #6 (broke his jail cell window)
6407	Schenectady PD	Schenectady County	NY	04/29/2008	Arrest #1 (Domestic Violence / Harassment)
6488	Schenectady PD	Schenectady County	NY	06/13/2008	Arrest #2 (Violation of Order of Protection)
6489	Schenectady PD	Schenectady County	NY	11/10/2008	Arrest #3 (Stalking & Aggravated Harassment of ex-wife)
6490	Schenectady PD	Schenectady County	NY	12/16/2009	Arrest #6 (Eavedropping, Stalking, Computer Trespass, Witness tampering, etc.)

Created By: BGSUCHAD
 Date Created: 2/13/2012 11:25:17 PM

Done Internet 100% 5:22 PM

Start Onbase Client (onbase) Onbase [Production] : W... Offender List - Windo...

OnBase [Production] : WorkView - Windows Internet Explorer
 https://onbase.bgsu.edu/Applet/ViewPanel.aspx?FrontExternal=true

OnBase

WorkView

Create Applications

Criminal Justice - Police Crime

Criminal Justice

- Booking Sheet (6602)
- Booking Sheet (Search)
- Case Data (6602)
- Case Data (Search)
- County (3142)
- County (Search)
- Employing Agency OLD (2395)
- Employing Agency - CSLEA08 (Search)
- Offender List (5671)
- Offender List (Search)

Booking Sheet (Search) Last Name =
WorkView

Last Name	First Name	Middle Name	Suffix	Alias	Employing Agency	County	State	Date of Arrest	Case Number	N-number	FIPS
Aranda	Jeffrey				San Diego PD	San Diego County	CA	03/11/2011	2902	N02412	06073
Aranda	Jeffrey				San Diego PD	San Diego County	CA	03/11/2011	2899	N02412	06073
Aranda	Jeffrey				San Diego PD	San Diego County	CA	03/11/2011	2898	N02412	06073
Ross	David				San Diego PD	San Diego County	CA	05/11/2011	3047	N02535	06073
Ross	Michael				San Diego PD	San Diego County	CA	02/00/2011	3062	N02550	06073
Aranda	Michael	San			San Diego PD	San Diego County	CA	05/20/2011	3274	N02737	06073
Frederick	Ross	S			San Diego PD	San Diego County	CA	01/27/2012	4367	N03742	06073
Ross	David				San Diego PD	San Diego County	CA	05/16/2006	536	N00774	06073
Lee	David				San Diego PD	San Diego County	CA	05/02/2011	3034	N02523	06073
Lee	David				San Diego PD	San Diego County	CA	08/15/2008	4791	N04081	06073
Aranda	Jeffrey				San Diego PD	San Diego County	CA	05/07/2011	3060	N02548	06073
Ross	Michael	Ross			San Diego PD	San Diego County	CA	07/24/2005	190	N01460	06073
Ross	Michael	Ross			San Diego PD	San Diego County	CA	07/24/2005	748	N01460	06073
Ross	San	Aranda		Aranda	San Diego PD	San Diego County	CA	09/02/2008	5608	N04757	06073
Frederick	Ross	Aranda			San Diego PD	San Diego County	CA	03/24/2011	3061	N02549	06073
Lee	David	Aranda		Aranda	San Diego PD	San Diego County	CA	07/26/2008	5758	N04870	06073
						San					

20 Row(s)

Done

Start | OnBase Client (onbase) | OnBase [Production] | Internet | 300% | 6:18 PM

OnBase Client (onbase)

File Document User Processing Workflow Window Help

Document Retrieval

Document Type Groups

Criminal Justice

Document Types

CRJ Case Files - Police Crime
 CRJ Case Files - Video Files
 CRJ Coding Sheet - Police Crime
 CRJ PACER Documents - Police Crime

Dates

From / / To / /

Today Today

Keywords

CRJCaseFiles And

CRJCaseNumber = And

Number = And

Full Text

"ice cream cake"

Find Text Search Note Search

Clear Keywords Clear All

Document Search Results

Full text: "ice cream cake" - CRJ Case Files - Police Crime

Score: 89.61 - Name: Case Files: Case # 155 (N00531) - Revision: 0 - Rendition: Text Report Format

Case Files: Case # 155 (N00531)

Cop holds wife hostage over cake | New York | CrimeNe.ws <http://crimene.ws/2005/11/23/cop-holds-wife-hostage-over-cake/>

« [Guilty plea in Ohio baby death](#) | [Red Lake families file motion to attend trial](#) »

Cop holds wife hostage over cake

By [Trench Reynolds](#) • Nov 23rd, 2005 • Category: [New York](#)

New York

[Cop accused of threatening wife at his birthday bash: Reason to Blow Up the World:...](#)

cop who once headed a domestic violence unit held an ax to his wife's head and twice threatened to shoot her - all because he didn't like the birthday cake she bought him, sources said yesterday. "He was not a satisfied customer," a law enforcement source said. "He wanted ice cream cake."

Lt. William Doyle was released yesterday on \$1,000 bond after being charged in the alleged five-hour barrage of threats at his 47th birthday party in the couple's Staten Island home Monday.

CEE Volume 3 Copy 1 | Checked Out [Rev 1 of 1] | 0 Note(s) | 0 Highlight(s) | Page 4



Document Type Groups
Criminal Justice

Document Types
CRJ Case Files - Police Crime
CRJ Coding Sheet - Police Crime
CRJ PACER Documents - Police Crim

Dates
From / /
Today

Keywords
Number = N000
LastName =
FirstName =
EmployingAge... =

Full Text
Find Text Search
Clear Keywords

Case 1:08-cv-01170-SLT-JO Document 43 Filed 07/20/10 Page 1 of 5 PageID #: 185

Case 1:08-cv-01170-SLT-JO Document 42-1 Filed 07/14/10 Page 1 of 5

UNITED STATES DISTRICT COURT
EASTERN DISTRICT OF NEW YORK

----- x
GABRIEL ALLANDE,

Plaintiff,

-against-

THE CITY OF NEW YORK, ET. AL.,

Defendants.
----- x

CV 08-1170(SLT)(JO)

**STIPULATION OF
SETTLEMENT AND
ORDER OF DISMISSAL**

FILED
IN CLERK'S OFFICE
U.S. DISTRICT COURT E.D.N.Y.

★ JUL 20 2010 ★

BROOKLYN OFFICE



OnBase 2011 CRM Case Files - Video Files - 04/26/2011 - Case#002 POLYMER - 40804 - Windows Internet Explorer

https://onbase.bgsu.edu/Viewer/ViewContainer.aspx

OneDrive

WorkItem

Details

Released

- Building
- Building
- Case De
- Case De
- County
- County
- Employer
- Employer (Search)
- Offense
- Offense

CAIRBOM



Mary Hernandez
MILWAUKEE, WISCONSIN COUNTY

0:00

Internet | Protected Mode: Off 100%

State	Date of Arrest	Case Number	Arrest Number	FISC#	Arrest
WA	01/26/2007	1428	000488	28028	
WA	04/27/2007	1189	000654	42060	
NY	04/22/2006	640	000400	28001	

Internet | Protected Mode: Off 100%

- CRJ Coding Sheet - Police Crime - CRJCaseNumber: 2100
- CRJ Coding Sheet - Police Crime - CRJCaseNumber: 411

- [1] Coding Sheet - Case # 2100: ML
- [1] Coding Sheet - Case # 2100: ML
- [1] Coding Sheet - Case # 2100: ML
- [1] Coding Sheet - Case # 2100: ML
- [1] Coding Sheet - Case # 2100: ML

Coding Sheet - Case # 2100: *MISSOURI, MISSOURI (NO1322)*

SEX OFFENSES, FORCIBLE:

- V53 FORCIBLE RAPE (11A)
- V54 FORCIBLE SODOMY (11B)
- V55 SEXUAL ASSAULT WITH AN OBJECT (11C)
- V56 FORCIBLE FONDLING (11D)

SEX OFFENSES, NONFORCIBLE:

- V57 INCEST (36A)
- V58 STATUTORY RAPE (36B)
- V59 INDECENT EXPOSURE
- V60 ON-LINE SOLICITATION OF A CHILD
- V61 OTHER SEX CRIME
- V62 STOLEN PROPERTY OFFENSES (RECEIVING, ETC.) (280)
- V63 WEAPONS LAW VIOLATIONS (520)

- V64 BAD CHECKS (90A)
- V65 CIVIL RIGHTS VIOLATIONS
- V66 DISORDERLY CONDUCT (90C)
- V67 DRIVING UNDER THE INFLUENCE (90D)
- V68 DRUNKENNESS (90E)
- V69 EVIDENCE: DESTROYING / TAMPERING
- V70 FALSE REPORT / STATEMENT
- V71 FAMILY OFFENSES, NONVIOLENT (90F)
- V72 HIT & RUN
- V73 LIQUOR LAW VIOLATIONS (90G)
- V74 OBSTRUCTING JUSTICE
- V75 OFFICIAL MISCONDUCT / OFFICIAL OPRESSION / VIOLATION OF OATH
- V76 PEEPING TOM (90H)
- V77 RESTRAINING ORDER VIOLATIONS
- V78 TRESPASS OF REAL PROPERTY (90J)
- V79 WIRETAPPING, ILLEGAL
- V80 ALL OTHER OFFENSES (90Z)

1 Documents Selected

Suffix And

EmployingAge... And

County And

State And

Full Text

Find Text Search Note Search

Clear Keywords Clear All



Prefilled by OnBase

N-Number:

N00632

FIPS County:

710

County:

Lee County

State:

NC

Agency:

Lee Co. Sheriff

Middle Name:

A.

Suffix:

Last Name:

IBM® SPSS®
Data Collection



Family Violence

Weapon: Gun-dept-issued

- No
- Yes

Weapon: Gun-personal

- No
- Yes

Weapon: Chemical Spray

- No
- Yes

Weapon: CED / TASER

- No
- Yes

Weapon: Nightstick / Baton

- No
- Yes

Weapon: Flashlight

- No
- Yes

Weapon: Other police weapon

- No
- Yes

Weapon: Knife

IBM® SPSS®
Data Collection



IBM SPSS Data Colle...

Police Crime Arrest Cases, 2005-2011

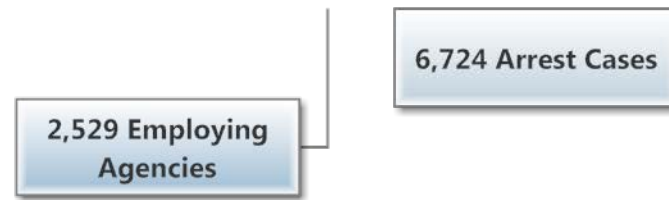

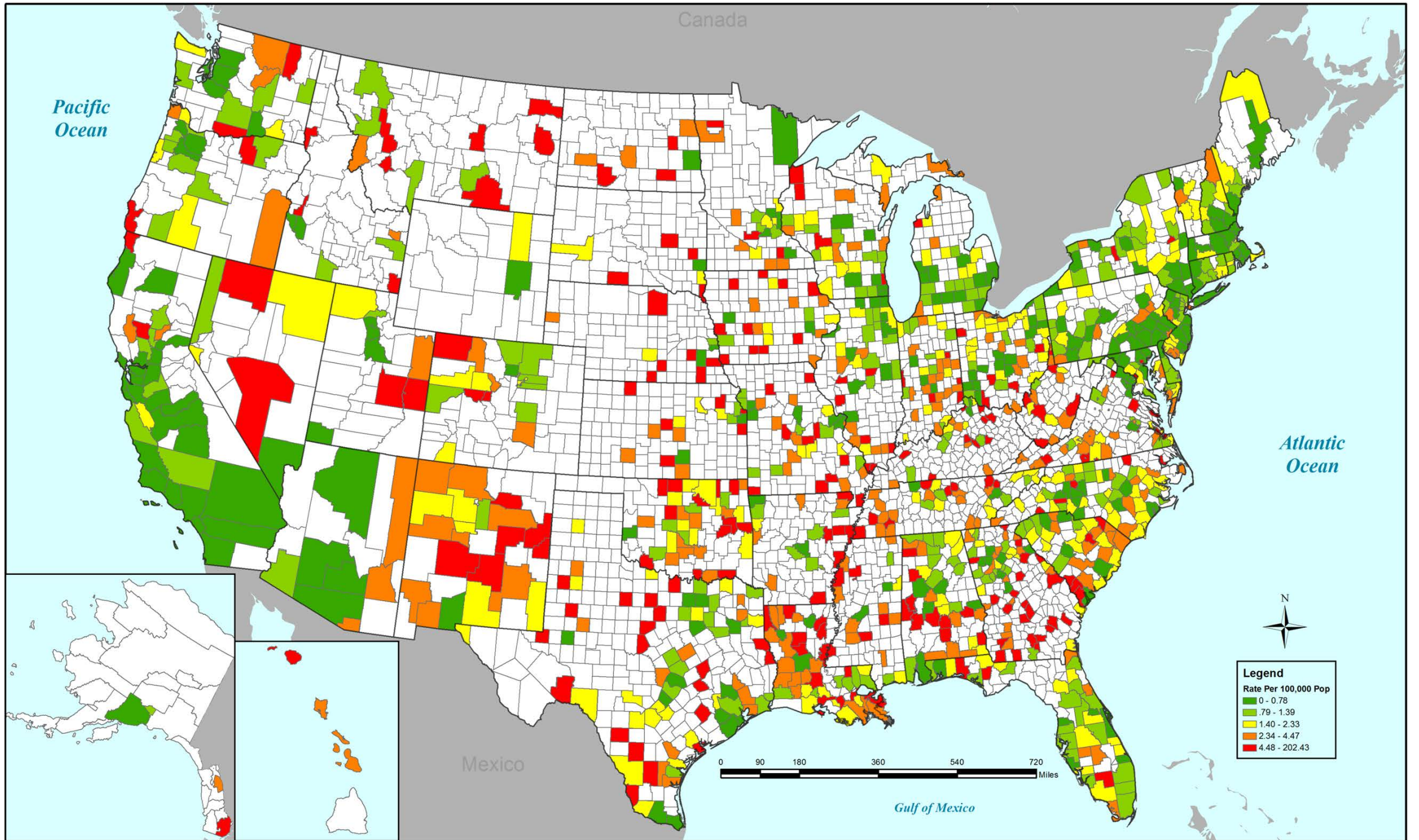

Stinson's Typology of Police Crime

- Alcohol-related Police Crime
- Drug-related Police Crime
- Sex-related Police Crime
- Violence-related Police Crime
- Profit-Motivated Police Crime

Officers Arrested for DUI, 2005-2010

DUI with Accident: 410 (54%)

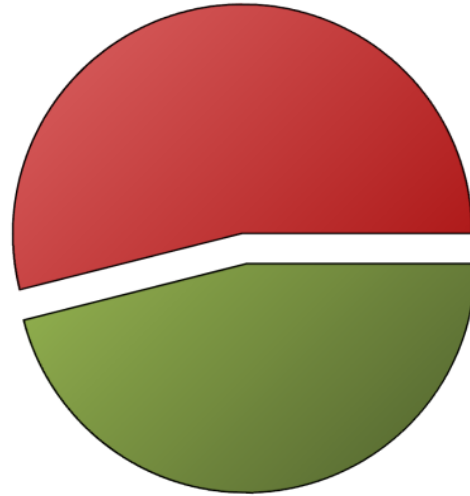

DUI - No Accident: 350 (46%)

Selling / Dealing / Trafficking Drugs

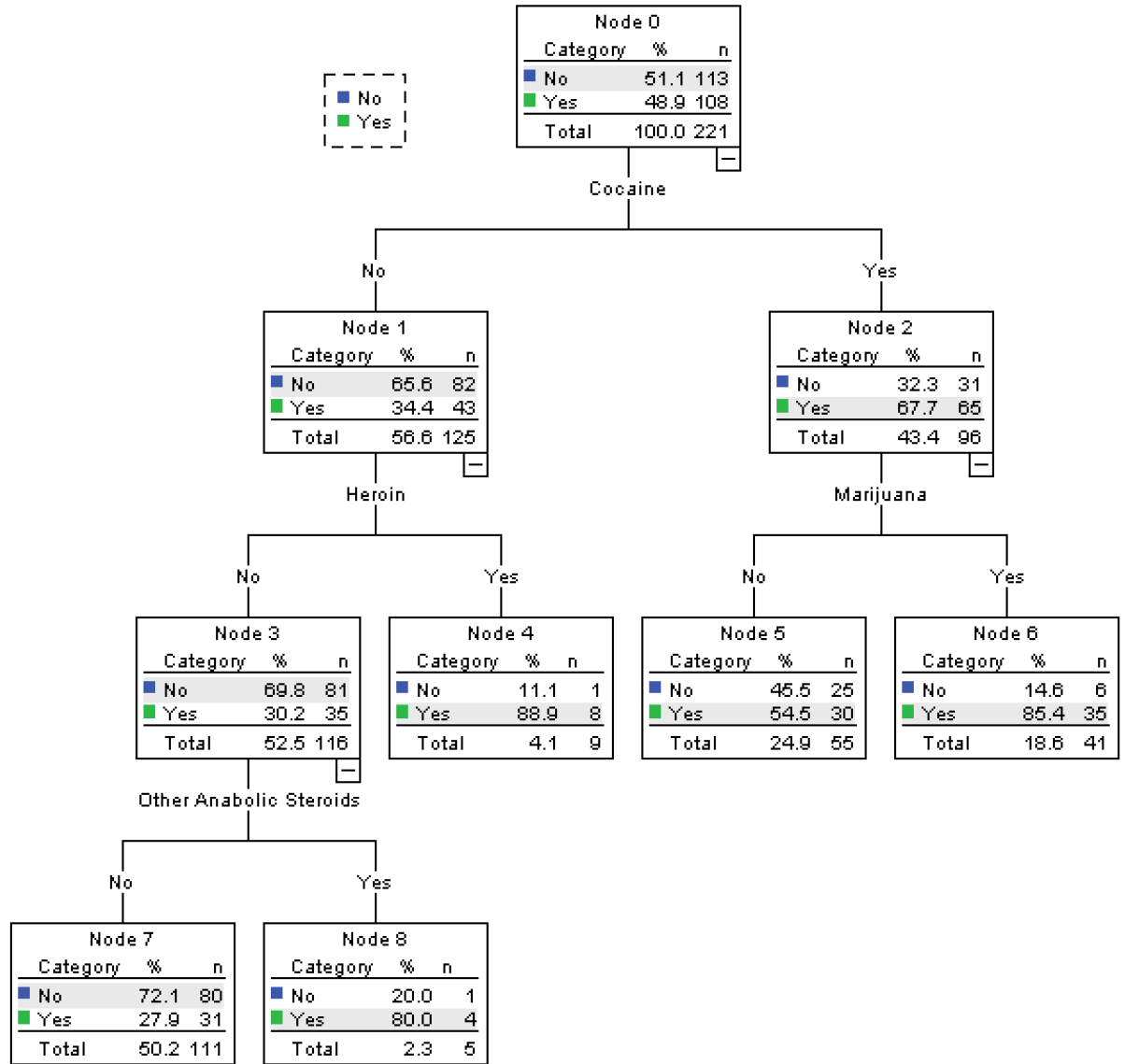

Shakedowns/Thefts from Car Stops
& Drug Couriers

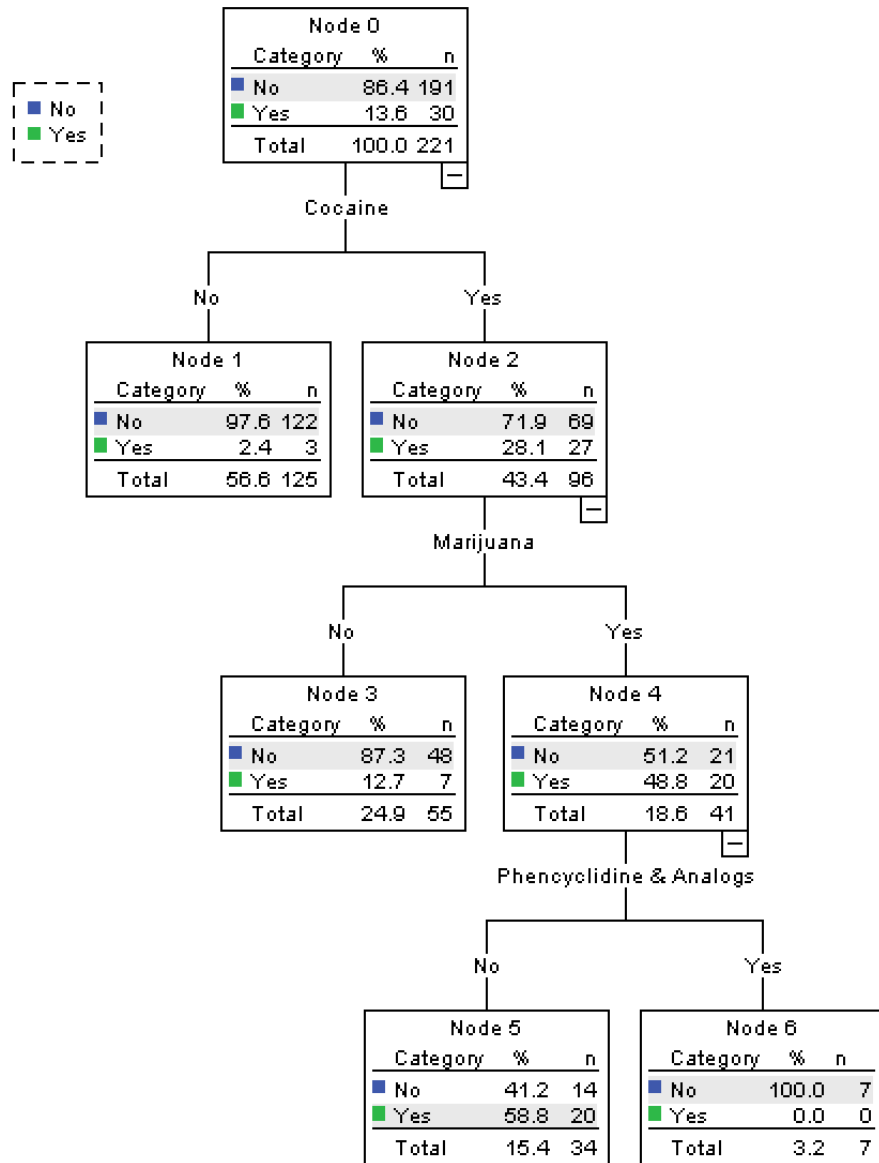

Police Officers Arrested for Sex Crimes

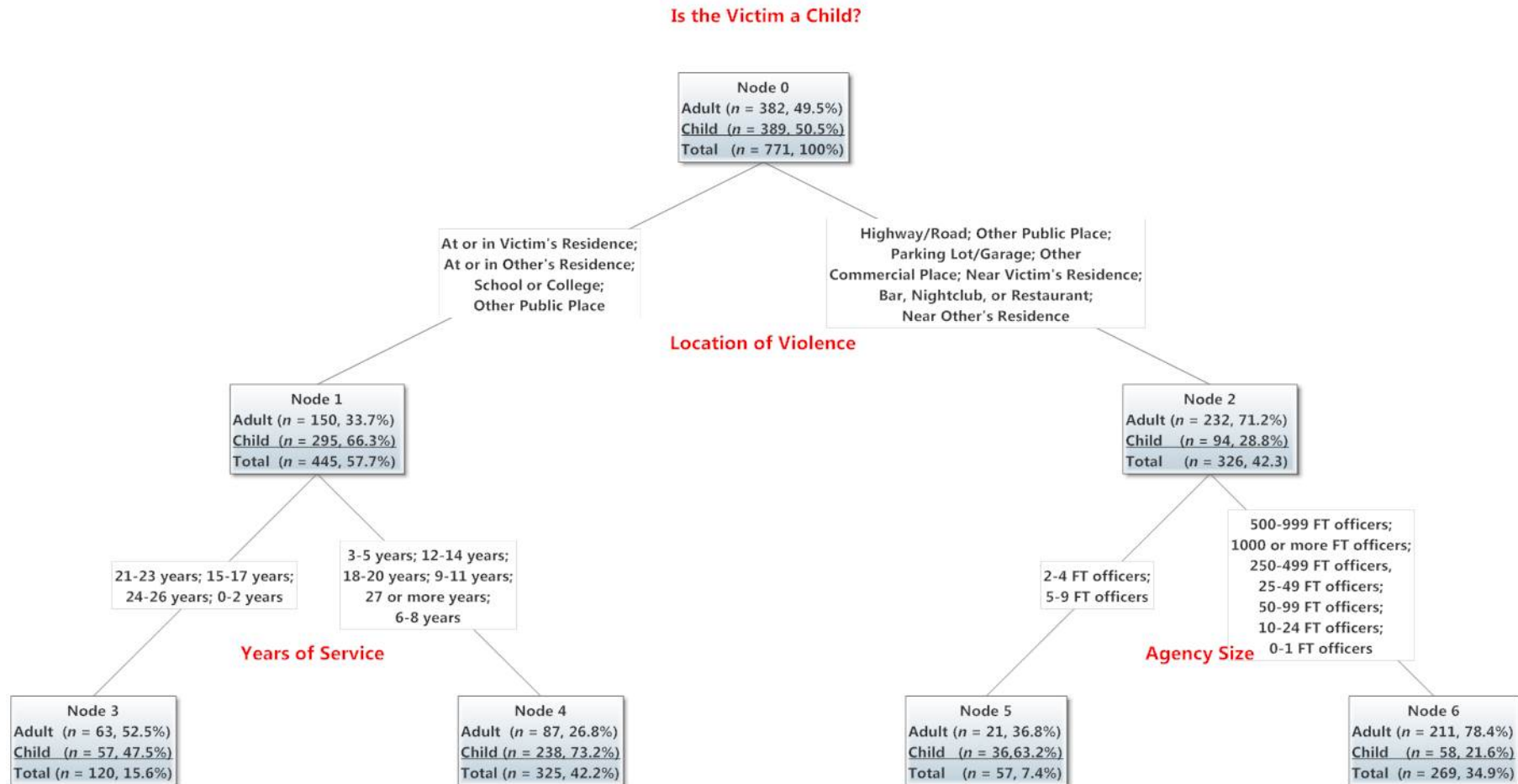

Violence-related Police Crime

- Stinson -w- The Washington Post study of on-duty shootings
- Bizarre Violence – off-duty gun-involved criminal events
- Criminal Misuse of Conductive Energy Devices (e.g., Tasers)
- Officer-involved Domestic Violence (OIDV) – Lautenberg Amendment

OIDV Criminal Case Dispositions by Weapon

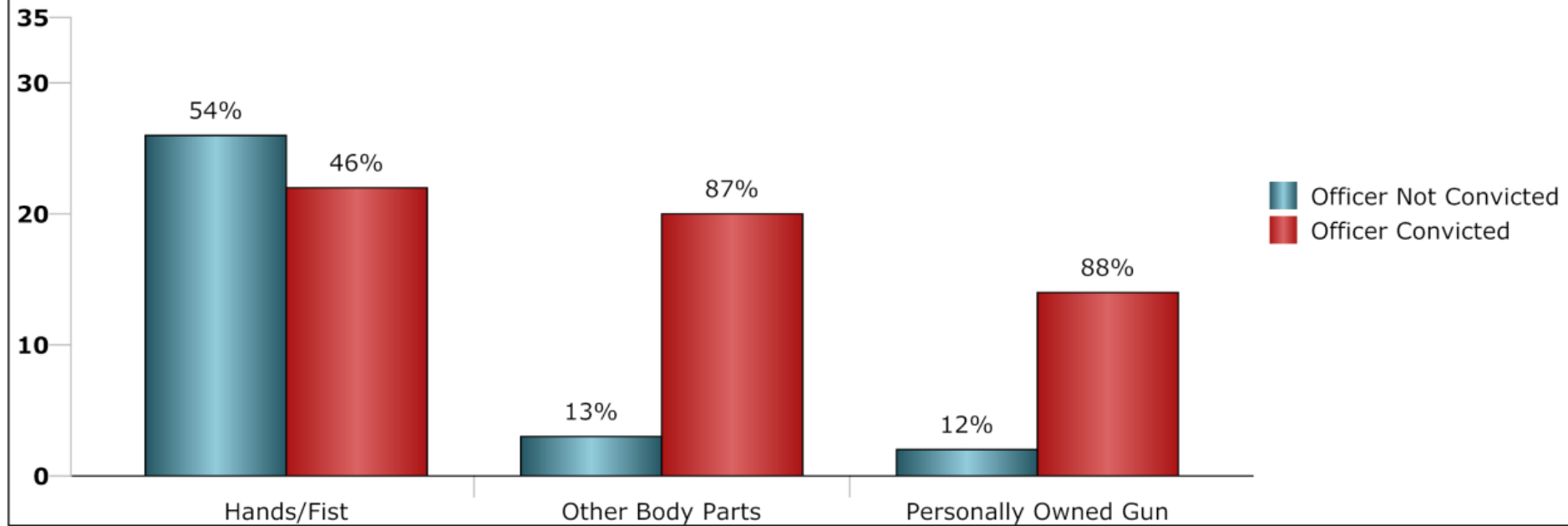

OIDV Criminal Case Dispositions by Offense

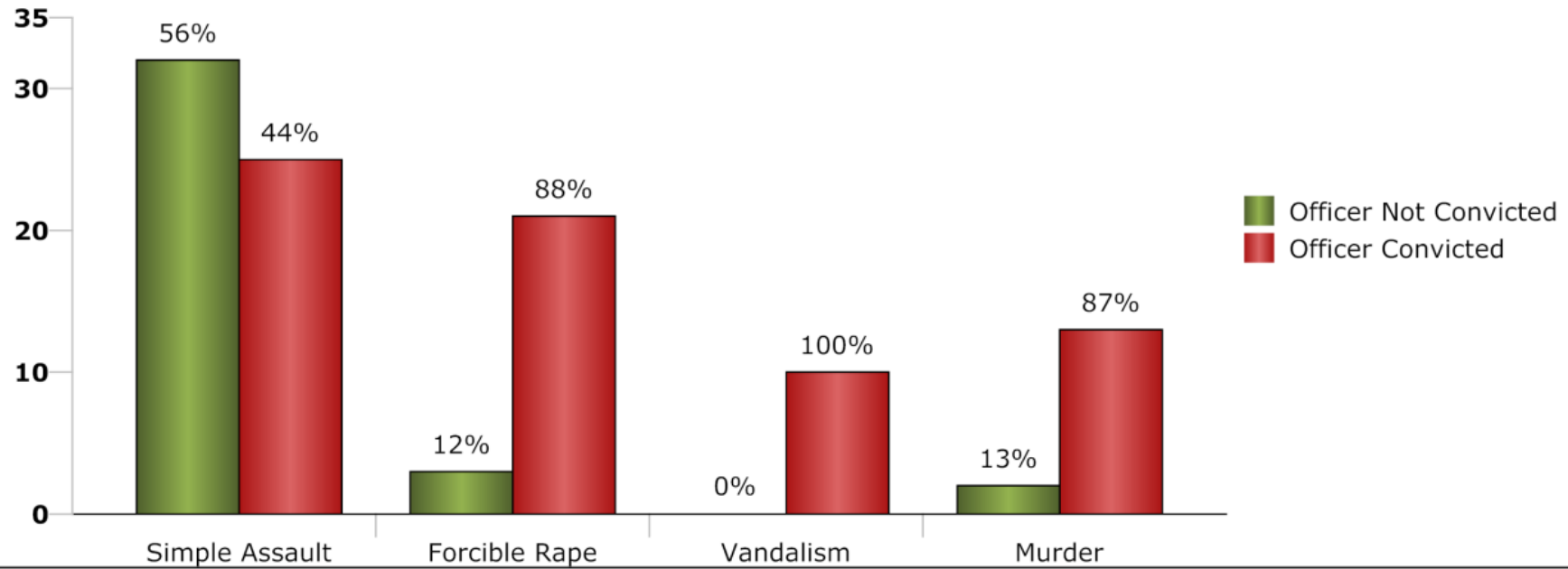

Officers Arrested and 42 U.S.C. §1983

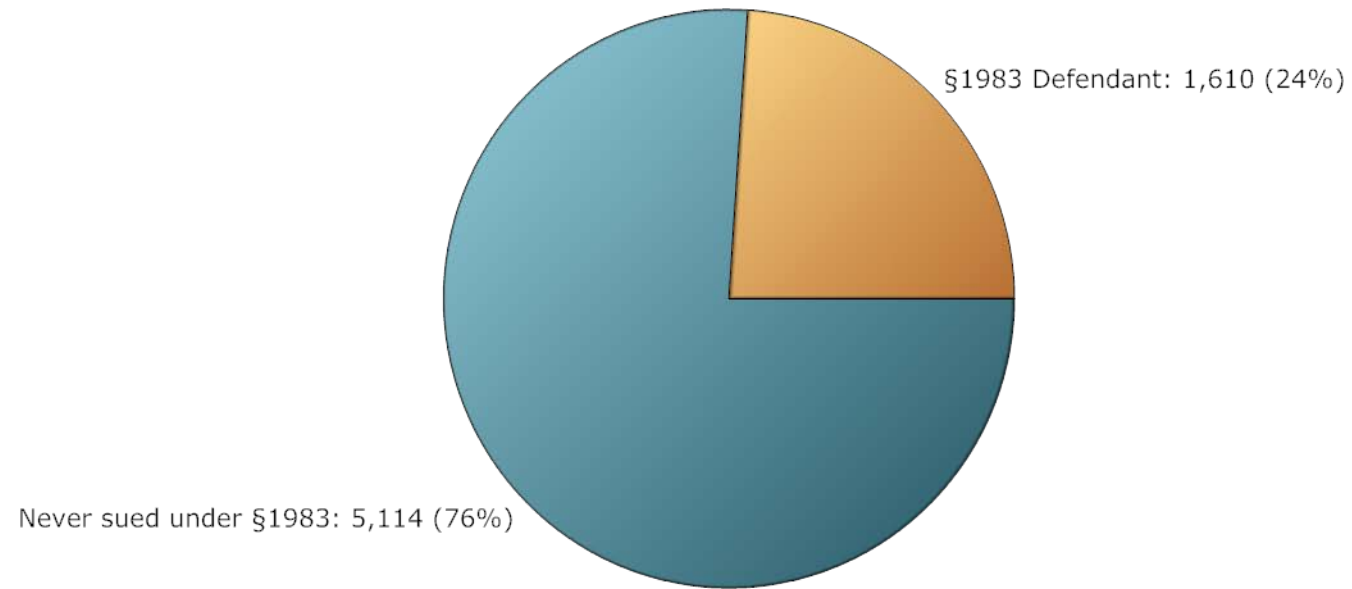

Late-Stage Police Crime

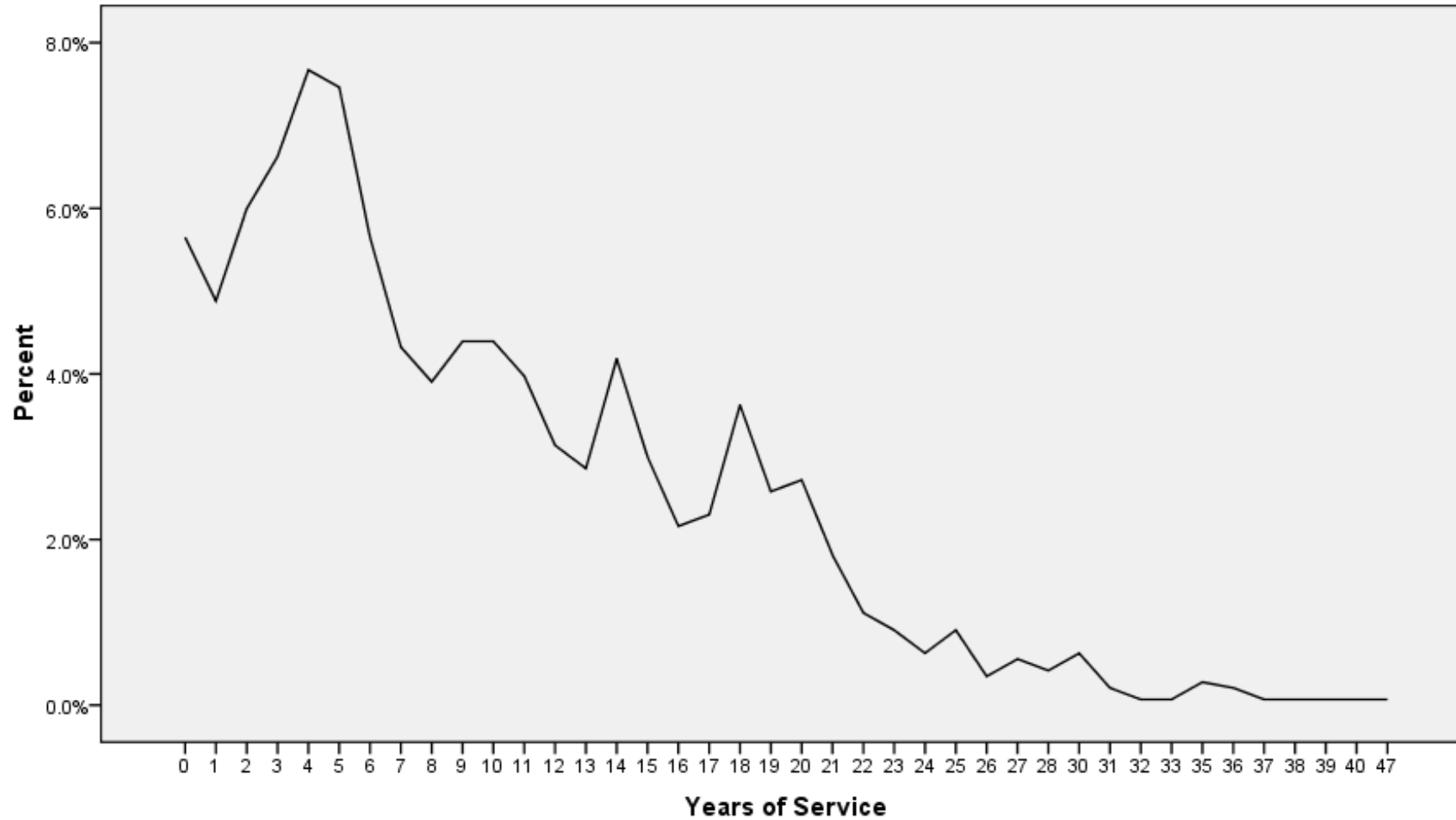

Monthly Podcast Episodes are Available on iTunes



For more information on this research project,
go to: www.bgsu.edu/policeintegritylost