

## Dissolution of Gypseous Rocks under Different Circumstances

*Orabi Al-Rawi<sup>1)</sup>, Shehdeh Ghannam<sup>2)</sup> and Hamid R. Al-Ani<sup>3)</sup>*

<sup>1)</sup> Assistant Professor (Corresponding Author)

<sup>2)</sup> Assistant Professor

<sup>3)</sup> Associate Professor

Civil Engineering Dept., Faculty of Engineering, Al-Isra University, Jordan, E-mail: orabialrawi@yahoo.com

### ABSTRACT

The influence of temperature, flow velocity, gypsum content, salinity of solvent and hole diameter on the amount and rate of dissolution of gypseous rock samples was investigated. The rock samples were obtained from the proposed Al-Fat'ha dam site located approximately 280km to the north of Baghdad city. The gypsum content for these samples ranged from 16% to 90%. Dissolution tests were carried out with the aid of a special system that was modified and manufactured to allow passing water at different speeds through a drilled hole along the center of the rock samples. The amount of dissolution of gypsum was determined under different conditions.

The results showed that the amount and rate of gypsum dissolution increased with increasing the temperature of the test. The effect was more pronounced on rock samples with low gypsum content. Increasing the flow velocity also increases the amount and rate of gypsum dissolution. With this parameter, the effect of gypsum content was marginal. Increasing the salinity of the solvent (using low percentages of NaCl additives) has a great influence on the amount and rate of gypsum dissolution, and further increase in the salinity exhibited a marginal increase in the amount of dissolution when compared with the lower salinity concentration. The Tigris river water (as a natural solvent) exhibited a negligible effect on the amount and rate of gypsum dissolution. Increasing the diameter of the hole along the center of the sample increases the inside area exposed to water and hence generates more dissolution.

**KEYWORDS:** Gypsum dissolution, Gypseous rocks, Lower fars formation, Temperature, Salinity of solvent, Flow velocity, Gypsum content.

### INTRODUCTION

Severe problems face geotechnical engineers when constructing hydraulic structures such as dams on gypseous soils or rocks. The presence of joints and fissures encourages the seepage of water and hence tends to dissolve the gypsum in the underlying rock layers. Excessive leakage may lead to defects in the structural performance of the rock layer supporting the

hydraulic structure. Several researchers agreed that the dissolution of gypsum or anhydrite can manifest itself in different ways causing the development and generation of leakage paths (i.e., enlarging fissures and accelerating seepage flows resulting in gaps and caverns), increasing permeability of granular zones, deterioration of foundations (attacking concrete grouts) and finally the progressive and intolerable settlements (Calcano and Aizura, 1967; James and Lupton, 1978; James and Kirkpatrick, 1980).

Numerous investigators studied the process of

---

Accepted for Publication on 15/7/2011.

dissolution and solubility of gypsum material using various techniques proposed for this purpose (Al-Rawi, 1998). Some techniques were used with soil samples and others with rock material. However, the basic literature comments concerning dissolution of gypsum in rock are summarized as follows:

- The flow velocity of water through the joints and crack patterns influences the amount and rate of dissolution of gypsum. This parameter is affected by the type of gypsum that influences the concentration rates and gradients.
- The tendency of dissolution of gypsum by exposure to flowing water depends on the type of gypsum present in the parent rock.
- The salinity of the solvent plays a major role in the dissolution, although this point was not fully fulfilled in the literature.
- The surface area in contact with water (or exposed to water) plays a major part in the amount and rate of dissolution. Yet, this point needs further investigation for more precise evaluation depending on the type and slope of joints present in the rock.
- The amount and rate of dissolution show an increasing trend with increasing temperature. This point still requires more investigation throughout the practical range.
- The mathematical representation for gypsum dissolution can be expressed by the following equation:

$$\frac{dM}{dt} = K A (C_s - C)$$

where:

$M$ : Mass of the dissolved gypsum, (kg).

$t$ : Time, (sec).

$A$ : Area exposed to solution, ( $m^2$ ).

$C_s$ : Saturated concentration of gypsum, ( $kg/m^3$ ).

$C$ : Concentration of gypsum at time  $t$ , ( $kg/m^3$ ).

$K$ : Solution rate constant, (m/sec).

## STUDY AREA GENERAL INFORMATION

As stated before, the gypseous rock samples used in performing laboratory tests for this study were obtained from the proposed Al-Fat'ha dam site. In general, the proposed Al-Fat'ha dam project is one of the Iraqi huge earth embankment dams proposed to be constructed to control the flood of Tigris river, and then to provide safety for Baghdad city. Figure 1 shows the location map for the proposed project site.

According to several previous site investigations, it was concluded that the proposed dam site consists of Lower and Upper Fars Formations (Swiss Consultants, 1980; Technoprom Export Company, 1962). However, the problem of the dam site suitability arises mainly on the area where the Lower Fars Formation exists consisting of gypseous rocks, limestone and marl. This type of rock (gypseous rocks) has the potential to dissolve under water flow and may create hazardous problems concerning the safety of the dam. Accordingly, it was found that it may be interesting to study the dissolution of gypsum in rock through conducting several test procedures using rock core samples obtained from the proposed Al-Fat'ha site.

The recent site investigation study for Al-Fat'ha area was carried out using five boreholes performed along the proposed dam site to a depth of 100m (each below the existing ground surface). The layout for these boreholes is shown in Figures (2-6), respectively. Based on the results of the above investigation, the following points are summarized (Euphrate Center for Studies and Designs of Irrigation Projects, 1993; Oil Exploration Company, 1993):

- 1- The right side of the river (represented by borehole 1) is composed of rock synthesizes related to the Lower Fars Formation represented by layers of limestone and gypseous rocks overlaid by thin to medium thick layers of recent deposits. The thickness of the gypseous layers sometimes exceeds 20m alone; whereas the overall formation thickness exceeds 100m. In general, the gypseous layers at this side are characterized by:

- Extending to long depths reaching about 100m.
  - The permeability of gypseous rocks is low in spite of their high ability to be dissolved.
  - The rocks have a moderately degree of cracking.
- 2- The left side of the river (represented by boreholes 2, 3, 4 and 5) is composed of rock synthesizes related to the Upper Fars Formation in which clayey, silty and sandy rocks are overlaid by thick layers of recent deposits. The rock layers at this side are characterized as strong rocks and have lower permeability.
- 3- The boundary separating the Upper and Lower Fars Formations coincides with the middle axis of flow path of Tigris River (as shown in Figure 1).

**Table 1. Some basic geotechnical characteristics for borehole 1**

Description	Remarks
Rock Quality Designation	From 91% to 100% (the average value is 98.8%).
Fracture Parameters	- Few fractures are encountered at this borehole. - The openings are with rough surfaces. - Fracture dips are sub-horizontal, 10 to 20, oblique 30 to 14 and sub-vertical of about 90.
Leakage	- The permeability for the overburden soil is $>10^{-4}$ cm/sec. - The leakage at the lower Fars rocks is classified as very low to low. - The leakage is very low to negligible below 52m to the total depth.
Rock Strength	7.74 MPa to 45.7 MPa.

**Table 2. Record for laboratory test results (for samples obtained from borehole 1)**

Sample Type	Sample Depth (m)	Description of Soil (or Rock)	Moisture Content (%)	Dry Density (gm/cm <sup>3</sup> )
UDS	2.70-3.10	Calcareous Sand	-	-
UDS	9.30-9.60	Brown Clay	18.0	1.66
DS	9.80-10.00	Calcareous Sand	-	-
RS	13.00-13.30	White Limestone	7.7	2.08
DS	32.70-33.10	Gypsum	0.8	-
RS	47.50-47.90	Marly Limestone	6.4	1.98
RS	60.74-61.06	Limestone	1.4	2.26
RS	71.55-71.88	Gypsum	1.6	2.25
RS	81.22-81.50	Gypsum	0.3	-
RS	94.32-94.67	Gypsum	0.9	2.32

UDS: Undisturbed Sample. DS: Disturbed Sample. RS: Remolded Sample.

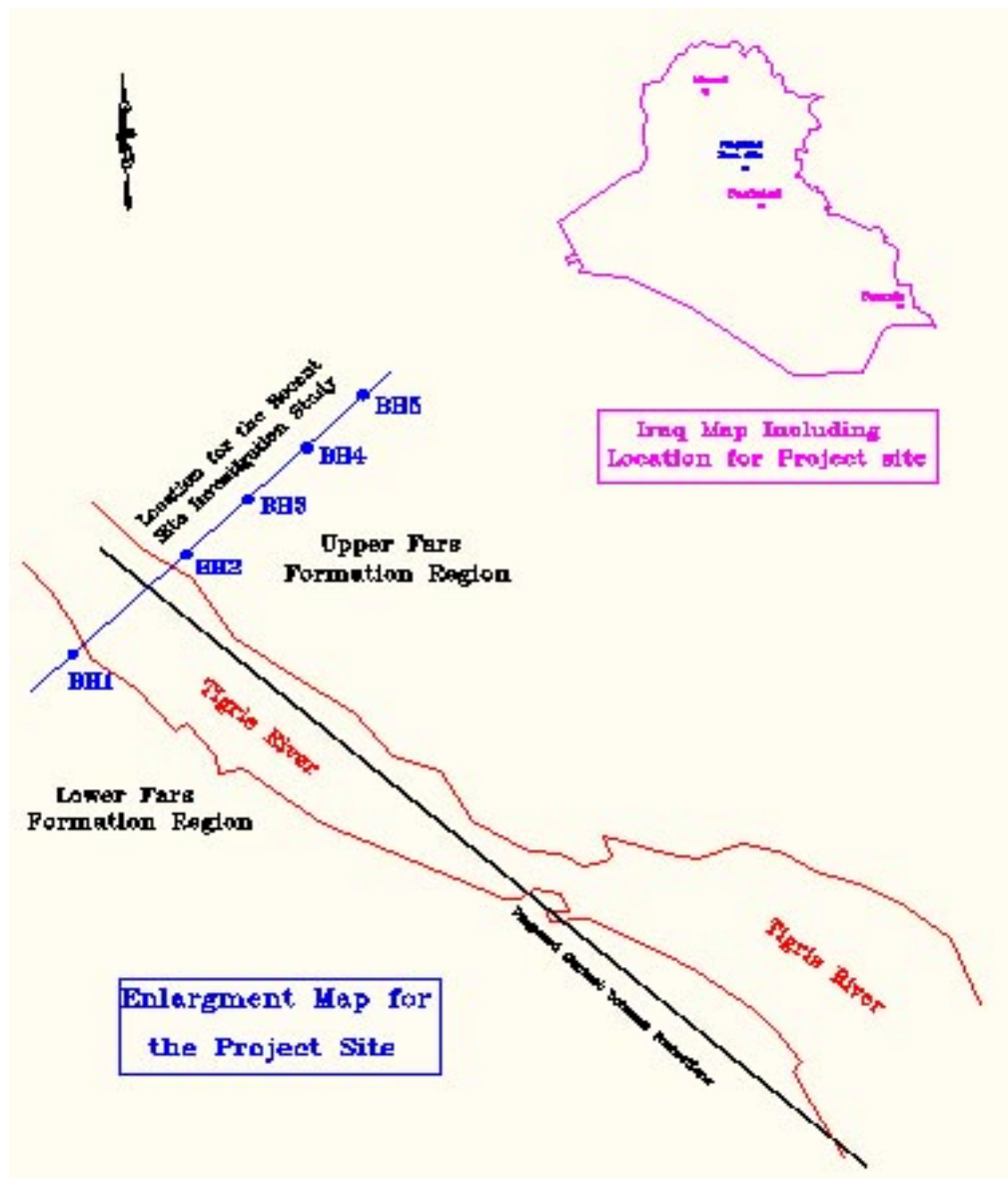

Figure 1. Location map for Al-Fat'ha dam project

## EXPERIMENTAL WORK

### Material Used

The material used in this study was gypseous rock samples mixed with limestone, obtained from borehole 1 at Al-Fat'ha site, Figure 2. Some geotechnical characteristics for this borehole are summarized in Tables 1 and 2 (Euphrate Center for Studies and Designs of Irrigation Projects, 1993).

### Experimental Setup

The idea of the proposed setup was in accordance with the testing technique suggested by James and Lupton (1978). The process basically involves the dissolution of gypsum material in rock due to the flow of water through a longitudinal hole made in the rock sample. The same approach was used but modified to fit the available experimental equipment and accessories.

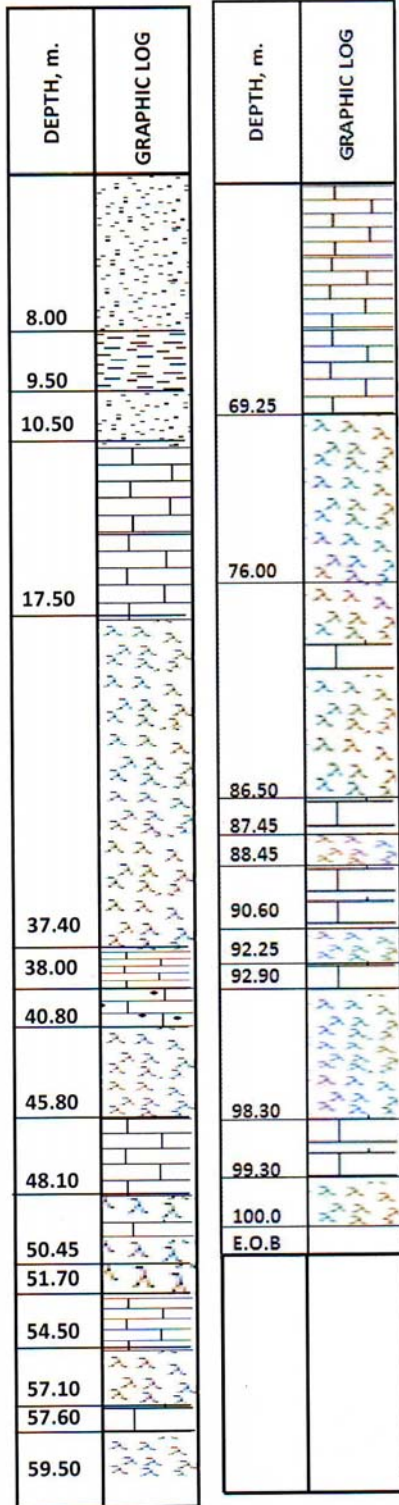

Figure 2: Layout for borehole 1

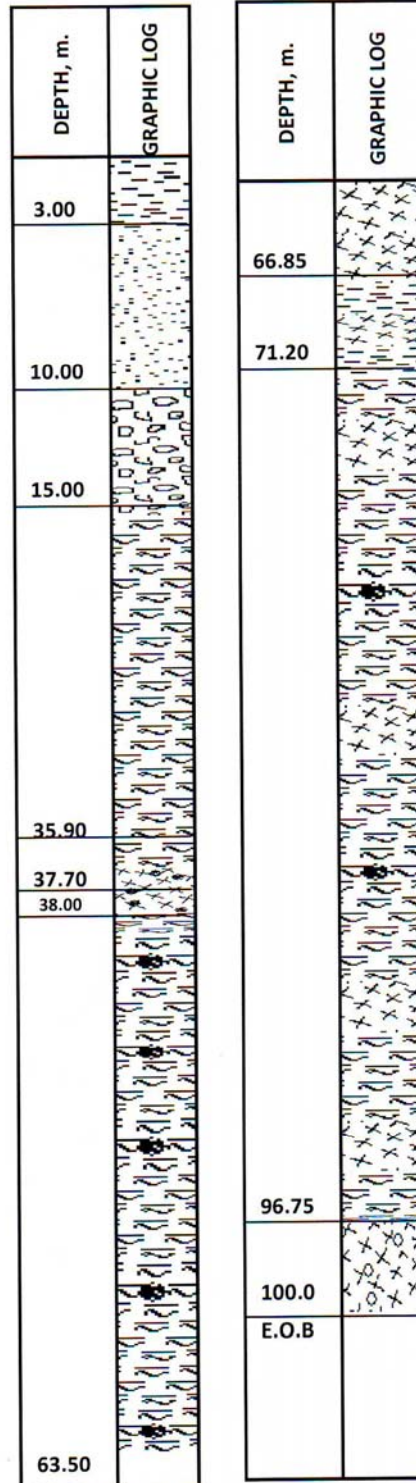

Figure 3: Layout for borehole 2

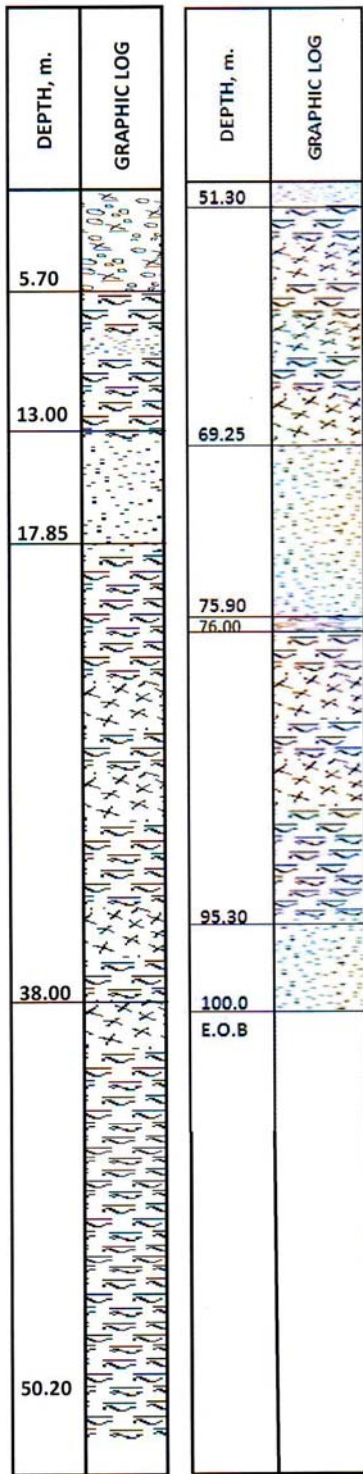

Figure 4: Layout for borehole 3

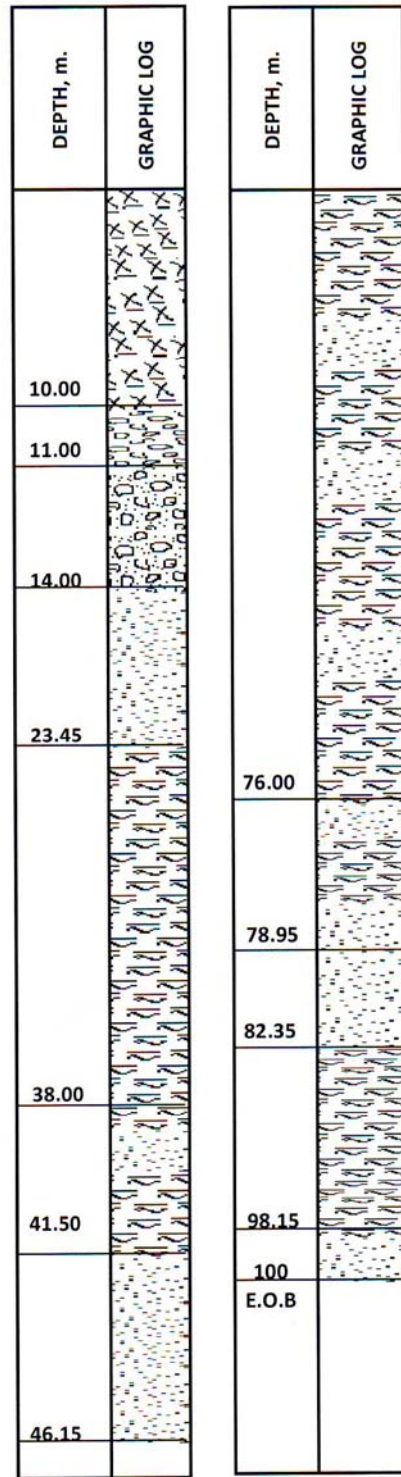

Figure 5: Layout for borehole 4

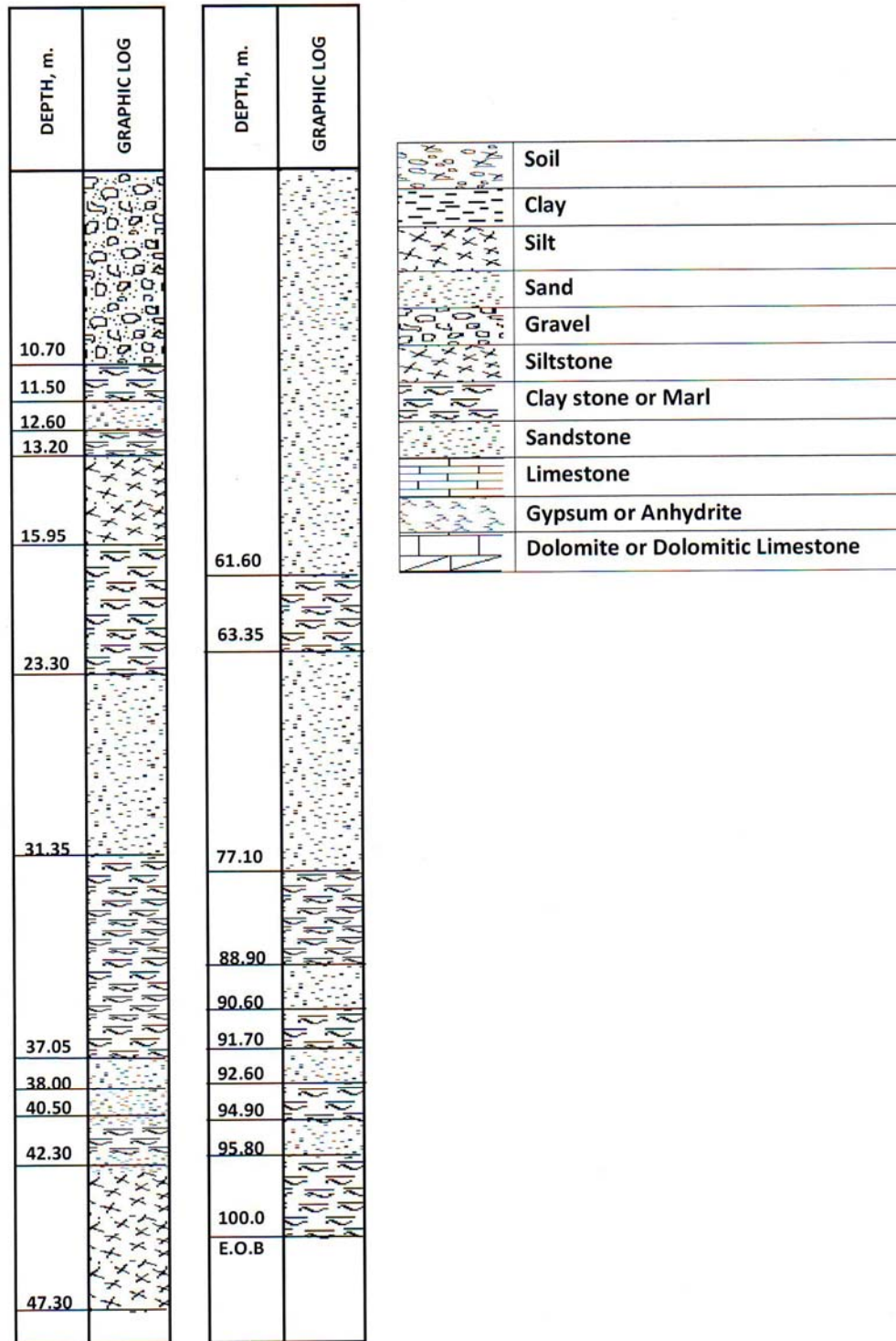
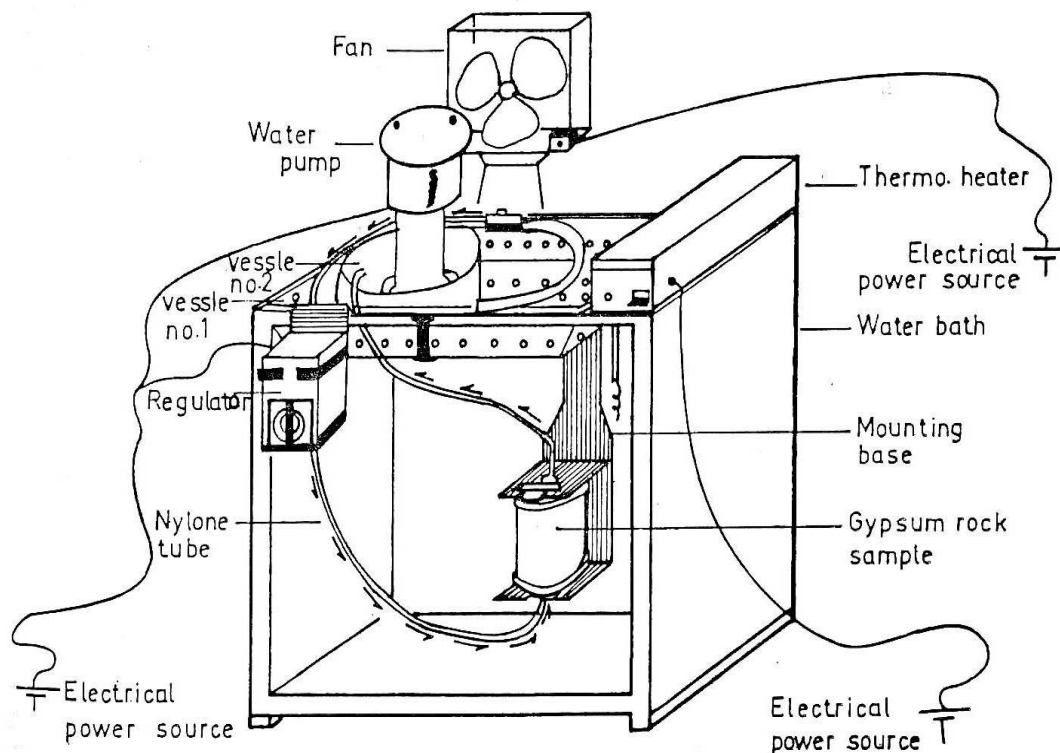

Figure 6: Layout for borehole 5



**Figure 7: Layout of the setup**

The main constituents for the experimental setup are: water bath, water pump, regulator, vessels and tubes. The overall apparatus regarding the testing assembly is shown in Figures 7 and 8, respectively, and also briefly explained below.

- **Water Bath**

An aluminium bath with dimensions of (48cm x 24cm x 40cm), attached to a thermal heater (including temperature control ranging from 0°C to 80°C), was used containing all other fittings. Figure 8a shows a typical layout for the bath.

- **Water Pump**

The circulating solution is delivered using a water pump indicated in Figure 8b.

- **Vessels**

Two plastic vessels were used in the setup, as shown

in Figure 8c. The large vessel (with dimensions of 30cm x 22cm x 10cm) was designed to contain several openings in order to allow a direct attachment between the bath water and the surrounding surface for the small vessel. However, the small vessel (with a diameter of 15cm and a height of 10cm) contained the water pump, the small glass balls and the distilled water.

- **Tubes**

A 12mm plastic tube was connected to the water pump at one end *via* a hole drilled through the small vessel; whereas the other end was attached to a control valve. This valve was joined to a nylon tube passing through the lower end of the rock sample (i.e., the bottom face of the plastic plate); whereas, the top end of the rock sample (i.e., the top face of the other plastic plate) was joined to another nylon tube (of the same diameter) in a manner that its outlet discharges the solution inside the small vessel.



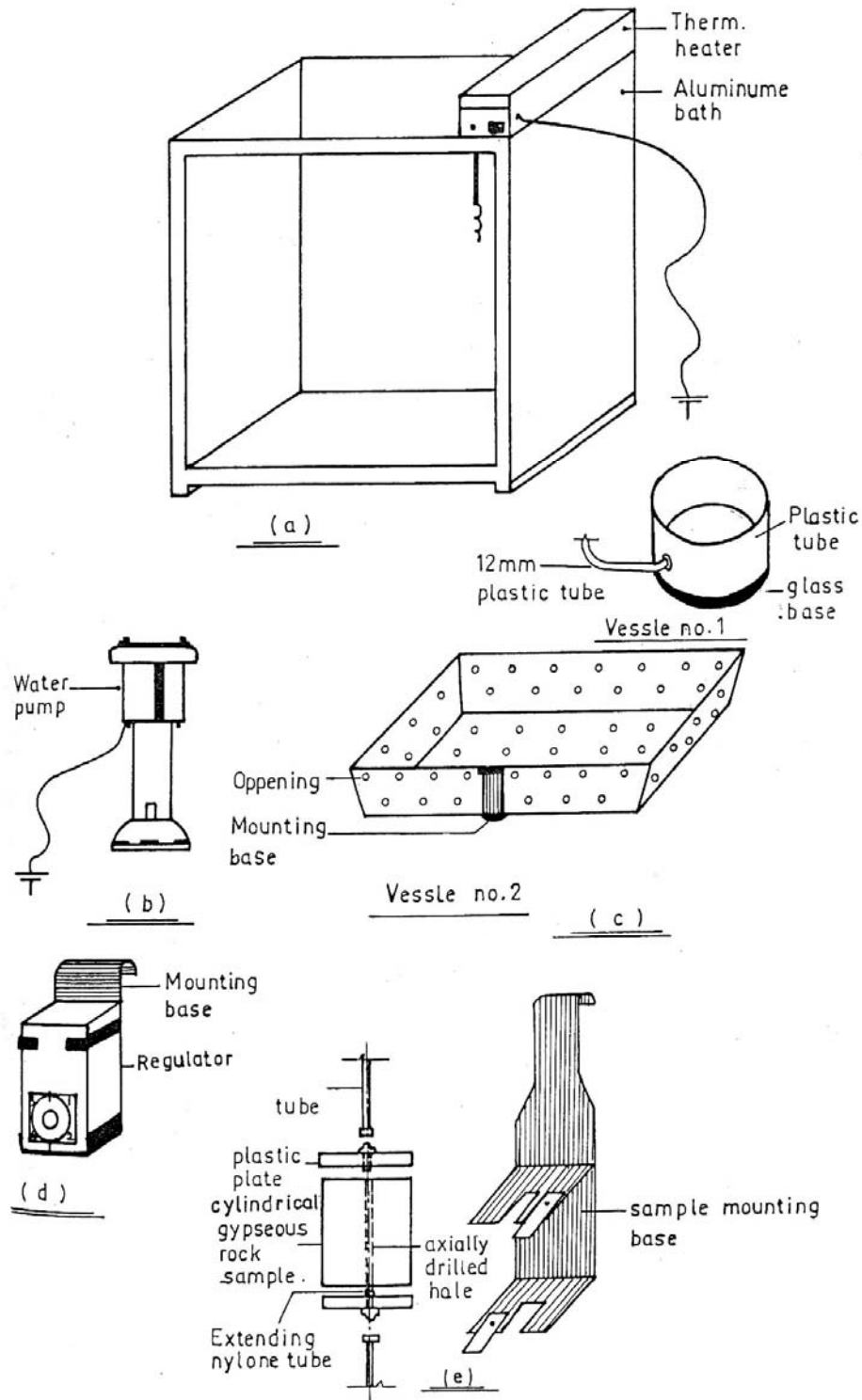

Figure 8: Details of the experimental setup

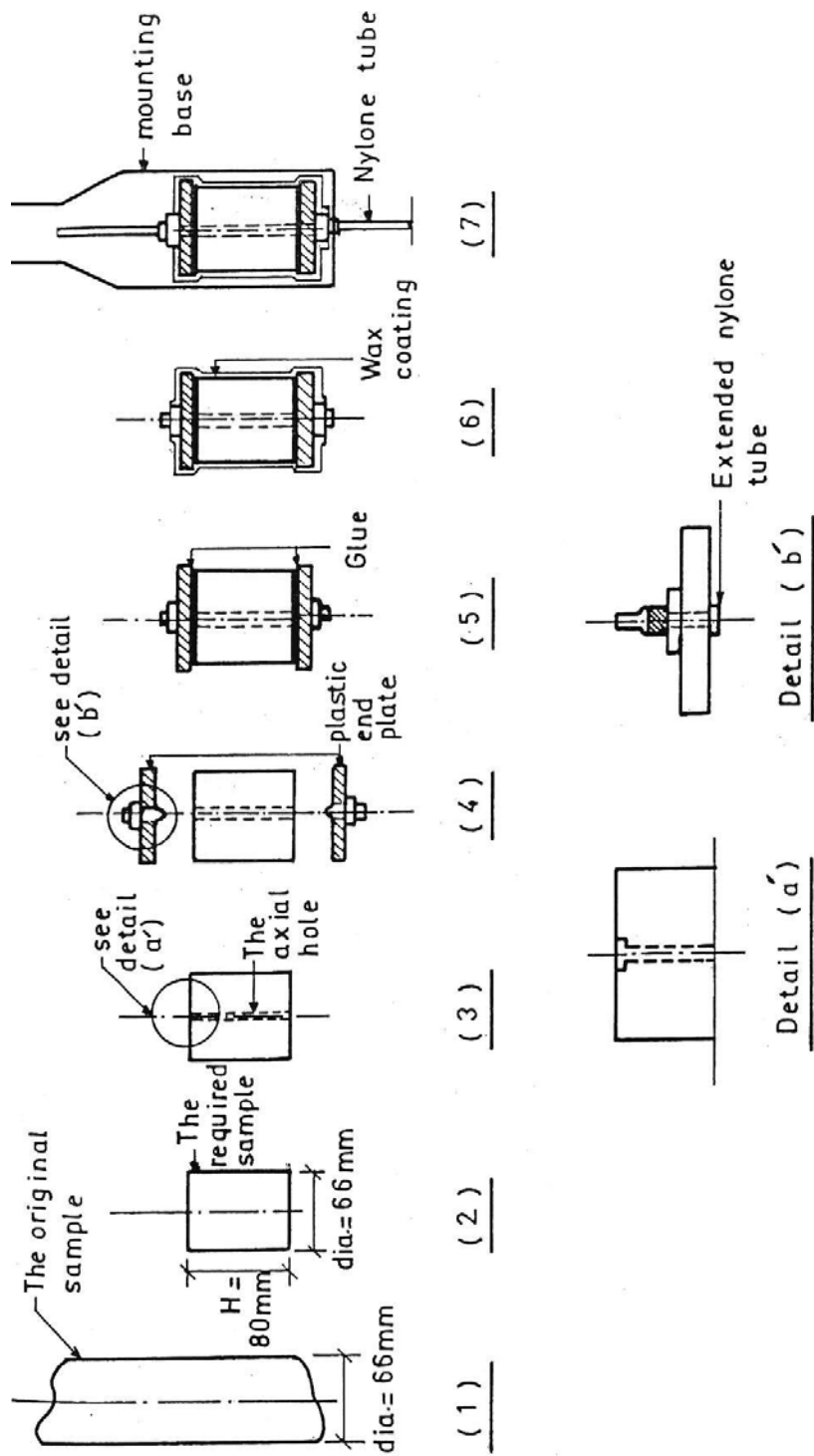

Figure 8f: The gradual stages for preparing the sample for testing

• **Glass Balls**

Due to some restrictions in the performance of the used water pump and to verify its work during the period of each test, small glass balls were used to rise up the water inside the small vessel in a manner that the opening located in the lower part of the pump must be submerged with the circulating solution without increasing the initial (fixed) volume of the distilled water used in the testing program.

**Table 3. Flow velocities provided by the regulator**

Speed no.	Discharge $\times 10^{-6}$ (m <sup>3</sup> /sec)	Flow Velocity (m/sec)
2	7.99	0.64
3	11.44	0.91
4	12.66	1.00
5	14.78	1.18

• **Regulator**

A five speed regulator was electrically connected to the water pump to control the velocity of the discharged water throughout the tested sample, Figure 8d. The elevation of the pump with the controlling regulator provided a set of velocities shown in Table 3.

• **Fan**

A small fan was connected to the setup to provide the water pump with a cooling device during the designed period for each test.

**SAMPLE PREPARATION AND APPARATUS ASSEMBLY**

An 80mm long gypseous rock sample with a diameter of 66mm was prepared using a mechanical cutter. The ends of the sample were trimmed parallel to each other. A small hole was drilled as axial as possible through the sample, then previously drilled plastic end plates with 70mm in diameter and 10mm in thickness

(shown in Figure 8e) were glued to the ends of the sample with silicon. The end plates were tapped to accept 2mm of nylon tube to extend through the hole of the sample to assure a flowing solution without leakage. Finally, the rock sample and its attached end plates were coated with wax and then located inside a mounting base (Figure 8f) after determining the initial volume of the axially drilled hole through the sample by filling the hole with mercury and weighing the mercury separately.

After preparing the cylindrical gypseous rock sample and locating it with its mounting base inside the bath, the bath was filled with water in a manner that its upper level exceeded the level of distilled water inside the small vessel. In order to clean the surface of the axial hole through the sample before each run, an amount of 40 ml of distilled water was pumped through the sample.

After assembling all fittings described before, the heater inside the bath was adjusted to the required temperature, then an amount of 475 ml of distilled water was poured inside the small vessel to circulate throughout the system afterwards. Specimens of the circulating leachate were taken for the analysis throughout the time period of testing (about 7 hours).

**DETERMINATION OF GYPSUM DISSOLUTION RATES**

To analyze the dissolved calcium sulphate in water and to illustrate a relationship between gypsum dissolution and time, a method (gypsum by precipitation with acetone “quantitative”) was used for such purpose. The method is in accordance to (Diagnosis and improvement of saline and alkali soils), (U. S. D. A., 1954). To calculate the milliequivalent of (CaSO<sub>4</sub>.2H<sub>2</sub>O) in aliquot, the following equation was applied:

$$\text{Milliequivalent of CaSO}_4.2\text{H}_2\text{O in aliquot} = (\text{meq./l of CaSO}_4.2\text{H}_2\text{O from conductivity reading}) \times (\text{ml of water used to dissolve the precipitate}) / 1000.$$

**TEST PROCEDURES**

Five test procedures were proposed for this study.

Each test procedure included considering one parameter as a variable, whereas the other parameters were kept

constant throughout the test. A summary for each test is explained.

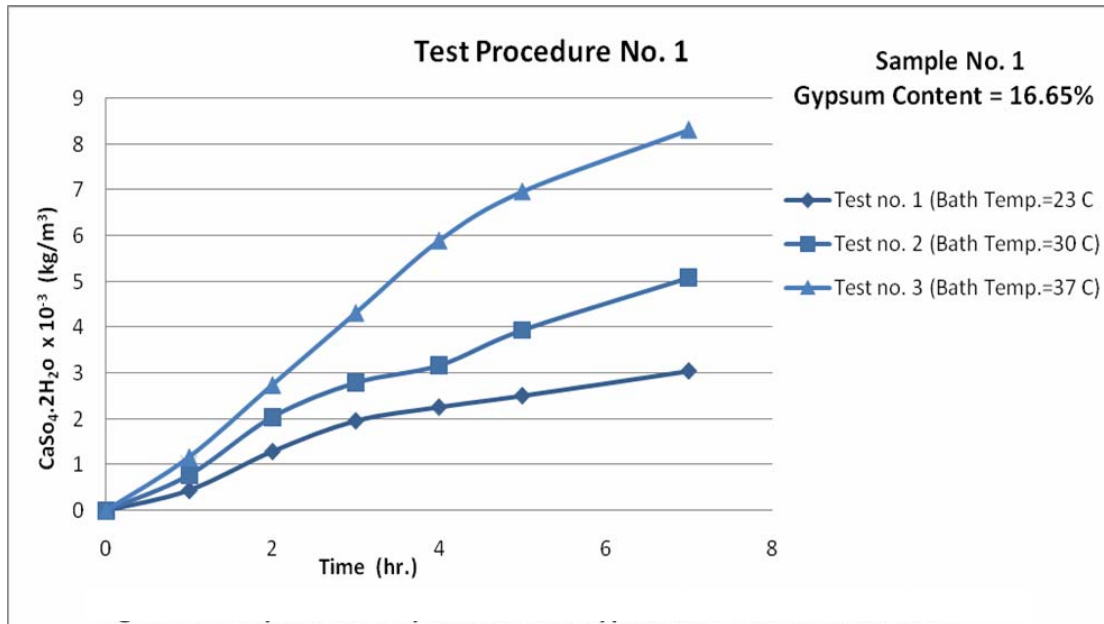

Figure 9: Temperature dependence on gypsum dissolution with time

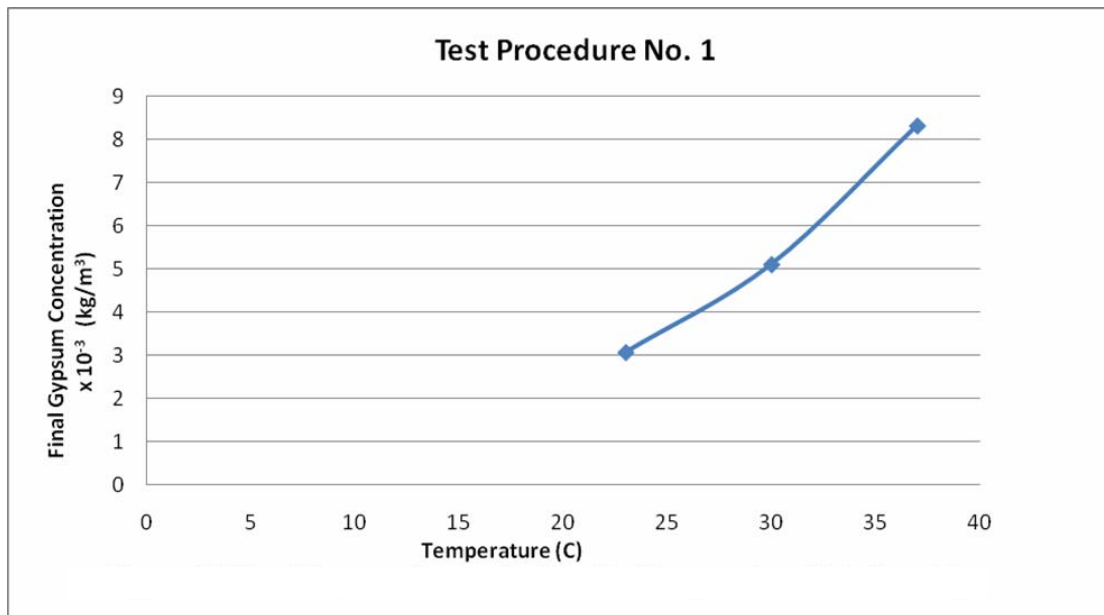

Figure 10: Final gypsum concentration vs. temperature relationship

### Test Procedure No. 1

In order to investigate the temperature effect on the dissolution of gypsum material, this test procedure regarded the temperature as a variable parameter, keeping the flow velocity, the diameter of the axially drilled hole, the gypsum content and the type of circulating solution constant throughout the testing period.

### Test Procedure No. 2

The effect of varying flow velocity for a solution through a gypseous rock sample had been measured throughout this type of testing. The set of constants involved during this test procedure were: temperature, gypsum content, the diameter of the axially drilled hole and the type of circulating solution.

### Test Procedure No. 3

Using the same testing technique, the behavior of four rock samples with different gypsum contents has been monitored to study the effect of varying gypsum content on the dissolution ratio. In addition, this type of test included the measurement of the increasing ratio in the volume of the drilled hole inside the sample after each run.

### Test Procedure No. 4

In this test, the salinity of the circulating water was regarded as a variable parameter, whereas other parameters such as temperature, flow velocity, gypsum content and the diameter of the drilled hole were kept constants. Accordingly, the effect of four percentages of salinity was investigated on a gypseous rock sample using the same testing technique explained before.

### Test Procedure No. 5

To understand the effect of the surface area for the fissures that may exist in a gypseous rock sample in contact with water, three sizes of drilled holes were studied for such purpose.

## PROBLEMS ENCOUNTERED

Different problems were observed during the preparation and testing of the system. These problems are briefly summarized below:

- The higher bath temperatures (more than 40°C) may cause damage to the wax covering the gypseous rock sample followed by a possibility of destroying the sample by the attached bath water. Therefore, an investigation to the behavior of the sample against higher temperatures has not been involved in this study.
- A case of lower bath temperatures (low than 23°C) couldn't be obtained as soon as the environmental temperature (i.e., room temp.) was higher than the required one. Accordingly, the difficulty in controlling such temperatures didn't enable measuring their influences on the dissolution ratios.
- The time required to reach stabilization in the overall temperature for the system (i.e., the existence of a state of balanced condition between the temperature of the distilled water inside the small vessel and the bath water temperature) demands a long period of time (not less than 3 hours).
- Unexpected cases of leakage in the glue between the tested sample and the plastic end plates cause a continuous decrease in the circulating solution followed by accumulative errors in the required calculations concerned with such test.
- Considering the regulator type used in the setup, five velocities could be obtained for the system; four of these (no. 2, no. 3, no. 4 and no. 5) were performed; whereas speed no. 1 was cancelled due to its bad effect on the working of the used pump. Therefore, the influence of higher or lower velocities (i.e., > speed no. 5 or < speed no. 2) has not been examined in this study.
- In order to check the volume of the hole inside the tested sample (after and before testing), difficulties were observed in the point of entrance of mercury through the axial hole, due to the confinement of air

inside the hole. In addition, in case of wet hole, small particles of mercury may be stocked on the sides of the hole that could affect the accurate measurement of the net weight of mercury filling the hole (i.e., decreasing it).

- The maximum period of testing for all the tested samples couldn't exceed (7-9) hours, due to:
- The procedure of analyzing the specimens demands a quantity of (20 ml) of the leachate, in addition to the evaporated water and the sample absorbed water

during testing. All these quantities cause a gradual decrease in the remaining quantity of water to circulate afterwards, then affecting the work of the water pump because of the restrictions mentioned before concerned with such type of pumps.

- As well as a ventilation means (the fan connected to the manufactured system), the type of the water pump used in the apparatus required more cooling to assure a long period of working hours without any damage.

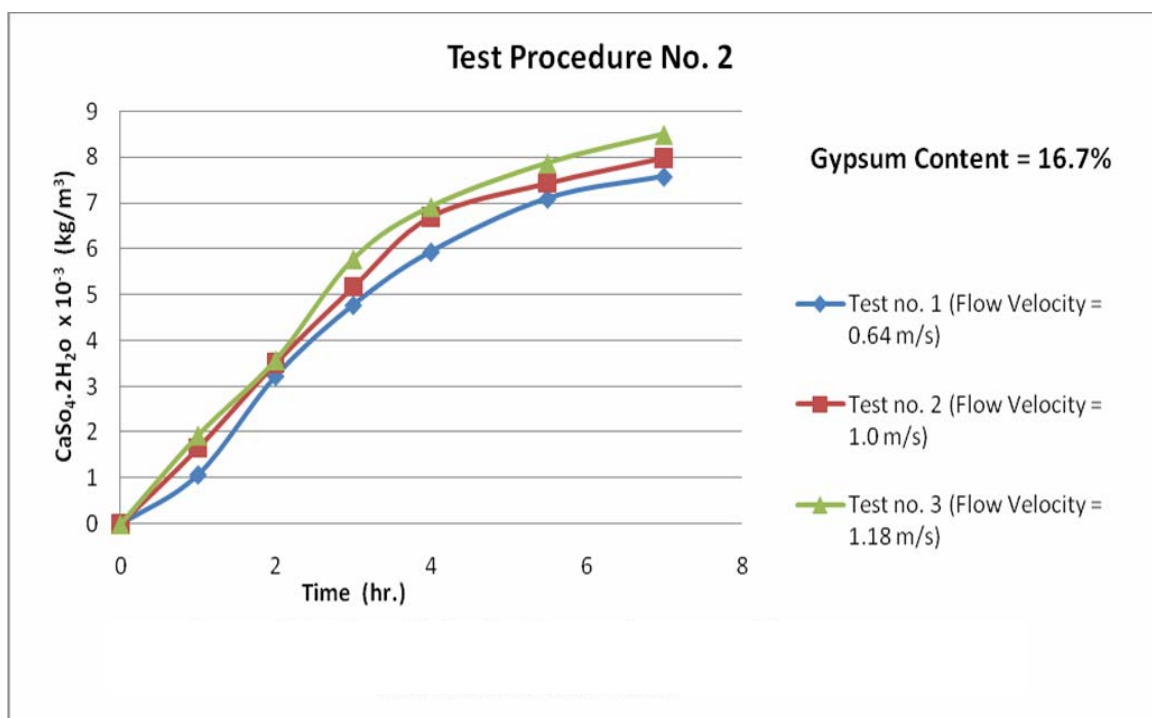

Figure 11: Flow velocity dependence on gypsum dissolution with time

### DISSOLUTION TEST RESULTS

In accordance with the test procedures mentioned before, the dissolution test results are presented as a relationship between “CaSO<sub>4</sub>.2H<sub>2</sub>O” in kg/m<sup>3</sup> versus “Time” in hours.

The parameters involved are temperature, flow velocity, gypsum content, salinity of water and area of calcium sulphate exposed to flow of water. The results

of each parameter are investigated (separately) with other parameters kept constant throughout the test.

### Temperature Dependence

In this set, three temperatures were selected (i.e., 23°C, 30°C and 37°C). In each test, the temperatures of the rock sample and the circulating water were controlled by the water bath. The dissolution of the gypsum was measured after a specific period of

circulating water. Figure 9 illustrates the variation of gypsum concentration *versus* time. It was observed that the amount and rate of gypsum dissolution increase with increasing temperature. Similar observations were reported by (Hanna, 1985; James and Lupton, 1978; Liu and Nancollas, 1971; Nafie, 1989; Subhi, 1987). This Figure also shows that the sample tested at higher temperature (37°C) exhibits a significant increase in the

dissolution amount and rate, and also requires less time to reach the equilibrium dissolution concentration when compared with the other two tests at lower temperatures. This indicates that the dissolution amount and rate does not follow a consistent variation as shown in Figure 10 when the final concentration was plotted against the temperature.

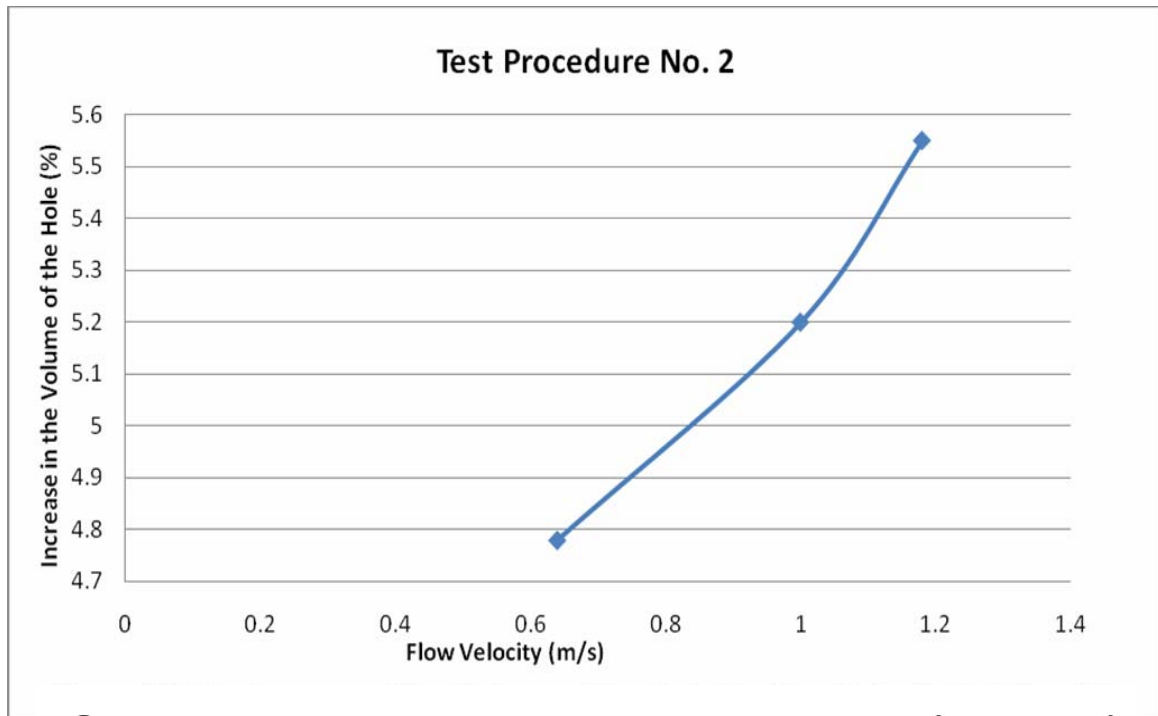

Figure 12: The increase in the volume of the hole vs. flow velocity relationship

### Flow Velocity Dependence

In this set, three flow velocities were selected: 0.64 m/sec 1.0 m/sec and 1.18 m/sec. These velocities were selected according to the restrictions of the testing setup and mainly of the regulator that controls the flow velocity. The tests were performed at 30°C. Figure 11 shows the variation of gypsum concentration *versus* time. For this specific sample with an initial gypsum content of 16.7%, the effect of flow velocity is not significant. This may be explained in terms of the type of flow that is occurring in the drilled hole. The three

velocities lie approximately in the turbulent zone (according to Reynold's number for flow in pipes). Previous literature reported a turbulent flow onset at a flow velocity > 0.8 m/sec with a hole diameter of 2.4 mm (James and Kirkpatrick, 1980).

The range of the selected velocities (0.64 to 1.18 m/sec) with a hole diameter of 4mm, definitely shifts towards turbulent zone. Under these conditions, the thickness of the boundary layer is reduced probably reaching a finite value and hence the mechanical effect of flow velocity is eliminated. This explanation is

encouraged by the fact that the initial gypsum content of this particular sample is low. Another support for this discussion is given in Figure 12 that shows the increase in the volume of the hole *versus* the flow velocity.

Another sample with a gypsum content of 78.2% was investigated to show the effect of flow velocity on the gypsum dissolution, as shown in Figure 13. The test with the higher flow velocity (1.18 m/sec) resulted in a

higher amount of gypsum dissolution compared with the other two velocities.

It is worth mentioning that the effect of temperature in the range 23°C - 37°C on the amount and rate of dissolution of these particular rock samples was more influential than the effect of flow velocity within the selected range.

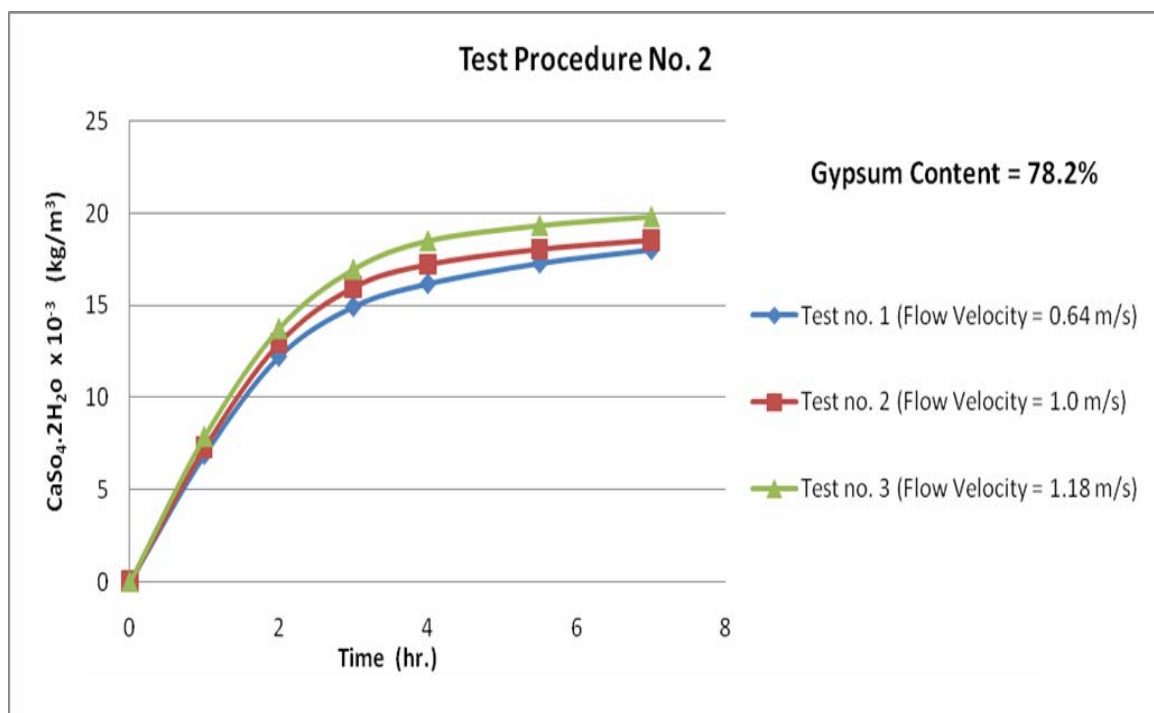

Figure 13: Flow velocity dependence on gypsum dissolution with time

#### Gypsum Content Dependence

Four rock samples with gypsum contents ranging from 16.1% to 89.9% were tested at a flow velocity of 1.0 m/sec and at a temperature of 30°C.

Similar to the previous sets, the gypsum concentration *versus* time relationship (shown in Figure 14) clearly indicates a higher increase in the dissolution amount and rate with increasing time. To explore the effect of gypsum content on the amount and rate of gypsum dissolution, the results are cross plotted in Figure 15 for periods of 1 hour and 7 hours. For the sample with a gypsum content of 16.1%, the dissolved

gypsum concentration increased from  $1.19 \times 10^{-3} \text{ kg/m}^3$  to  $7.48 \times 10^{-3} \text{ kg/m}^3$ . The corresponding results for the sample with a gypsum content of 89.9% increased from  $11.43 \times 10^{-3} \text{ kg/m}^3$  to  $25.48 \times 10^{-3} \text{ kg/m}^3$  indicating a highly increase in the amount of gypsum dissolution for the later test. The results also indicate that the 7 hours of flowing water exhibited a higher increase in the dissolved gypsum concentration with increasing gypsum content compared to the 1 hour flowing water. This point was not indicated in the previous literature, and no comparison between samples at different gypsum contents was made. The main reason may be



due to the gradual increase in the volume of the hole that creates some sort of rough surface inside the hole as shown in Figure 16. This point is further investigated for the sample with a gypsum content of 78.2%. The increase in the volume of the hole was measured after each time interval as shown in Figure 17. The major part of the dissolution occurs in the first four hours, and

this agrees well with the relationship between gypsum content *versus* time for the same sample. This close agreement may be due to the fact that most of the dissolved salts are mainly gypsum for this particular sample, since the total soluble salts were 89.5% compared to 78.2% gypsum content.

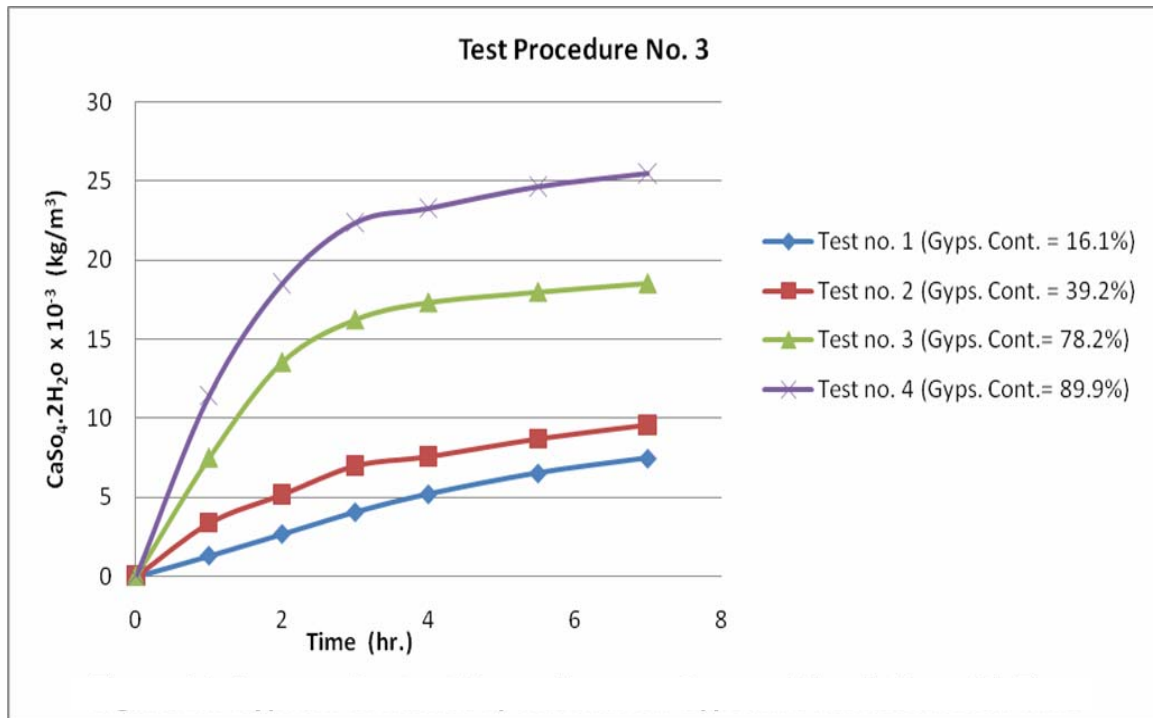

Figure 14: Gypsum content dependence on gypsum dissolution with time

### Salinity of the Solvent Dependence

All of the previous tests were carried out using distilled water. Since such condition is not available in nature, the effect of salinity of water and a comparison with distilled water and river water obtained from the site of the dam were investigated.

Two identical rock samples of the same gypsum content (84.7%) were tested. The first sample was tested using a solution of 1%, 3% and 5% NaCl concentrations; whereas the second sample was tested using river water of 0.0027% NaCl and distilled water (0% NaCl).

The results are represented in Figure 18. These

results show that the effect of NaCl in the tested range (1-5%) did not show a significant difference in the amount and rate of gypsum dissolution (the three samples were very close to each other); however, they exhibited a higher amount and rate of gypsum dissolution. As concluded in the literature, the salinity of the solvent increases the gypsum dissolution due to several reasons. The Na-Ca exchange may be the most important adsorption reaction that occurs (Al-Mufti, 1997). Also, the increase in the ionic strength may be a second effect that increases the rate of gypsum dissolution since it tends to compress the boundary layer and hence increase the solubility rate constant (Al-

Mufty, 1997; James and Lupton, 1978). Since the salinity of the Tigris River water is very low, its effect on the amount and rate of gypsum dissolution would be minimal. Although some other salts with higher ionic

strength are also present in the river water (such as potassium and magnesium with percentages of 0.0002% and 0.0015%, respectively), and hence their effect is negligible.

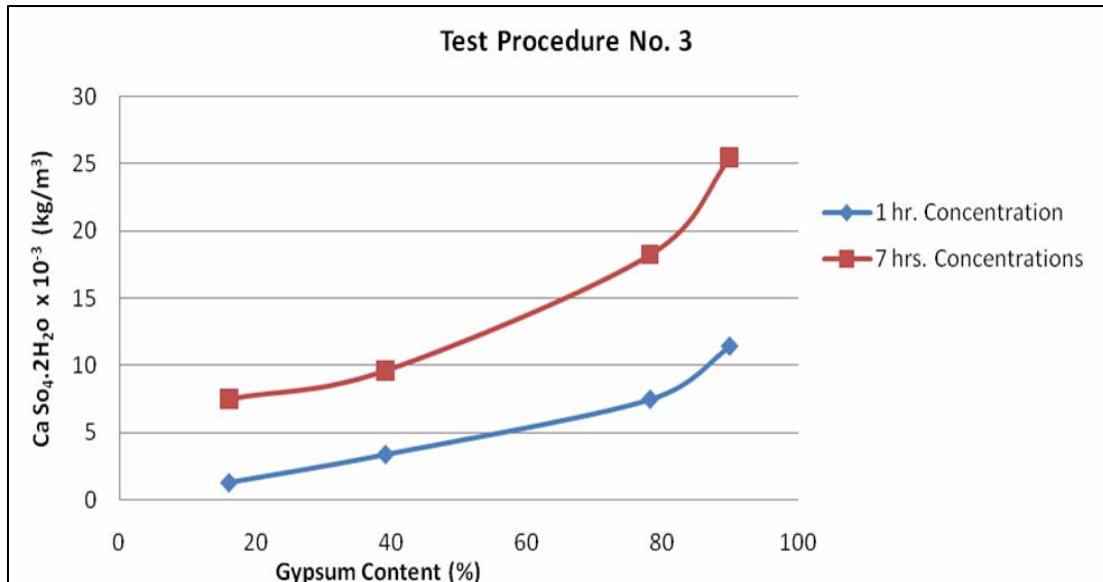

Figure 15: Effect of gypsum content on the amount and rate of gypsum dissolution

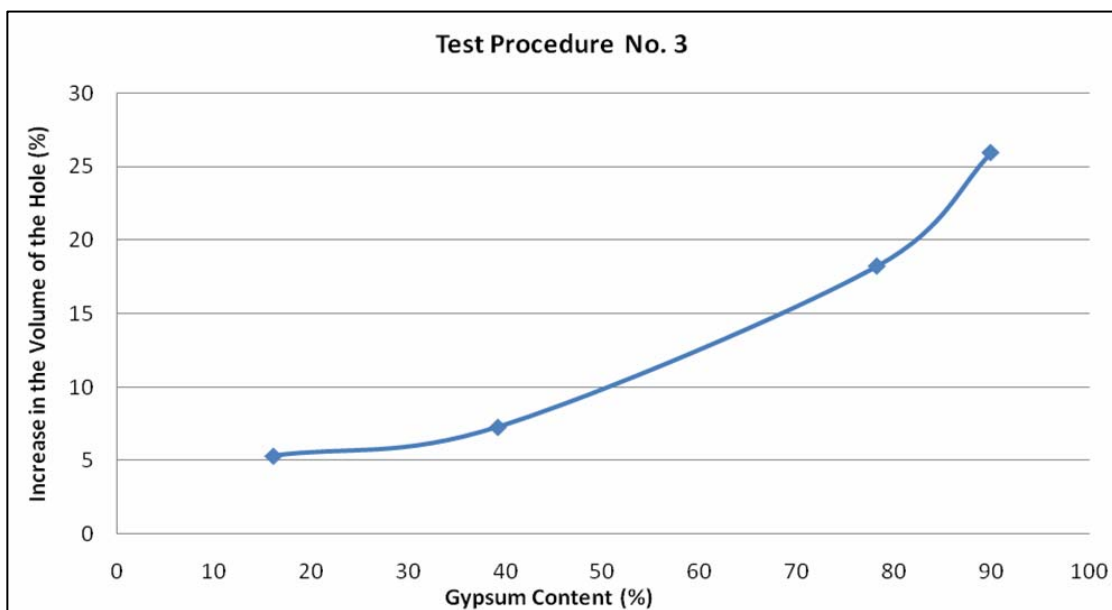

Figure 16: Increase in the volume of the hole vs. gypsum content relationship

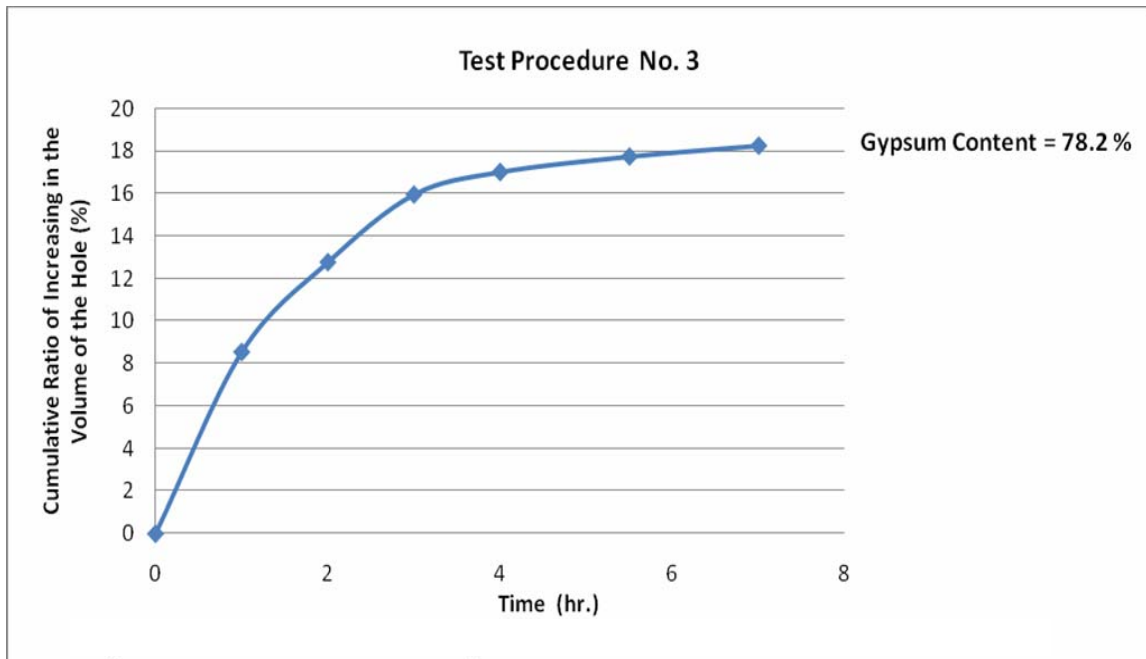

Figure 17: Ratio of increase in the volume of the axial hole vs. time

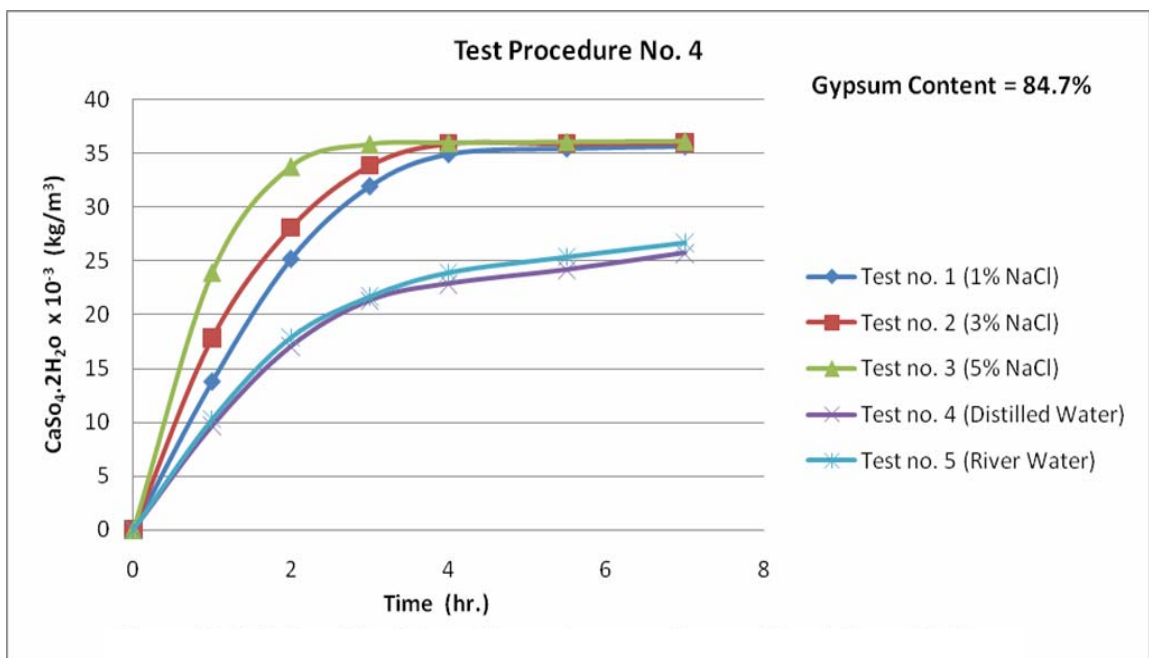

Figure 18: Salinity of the solvent dependence on gypsum dissolution with time

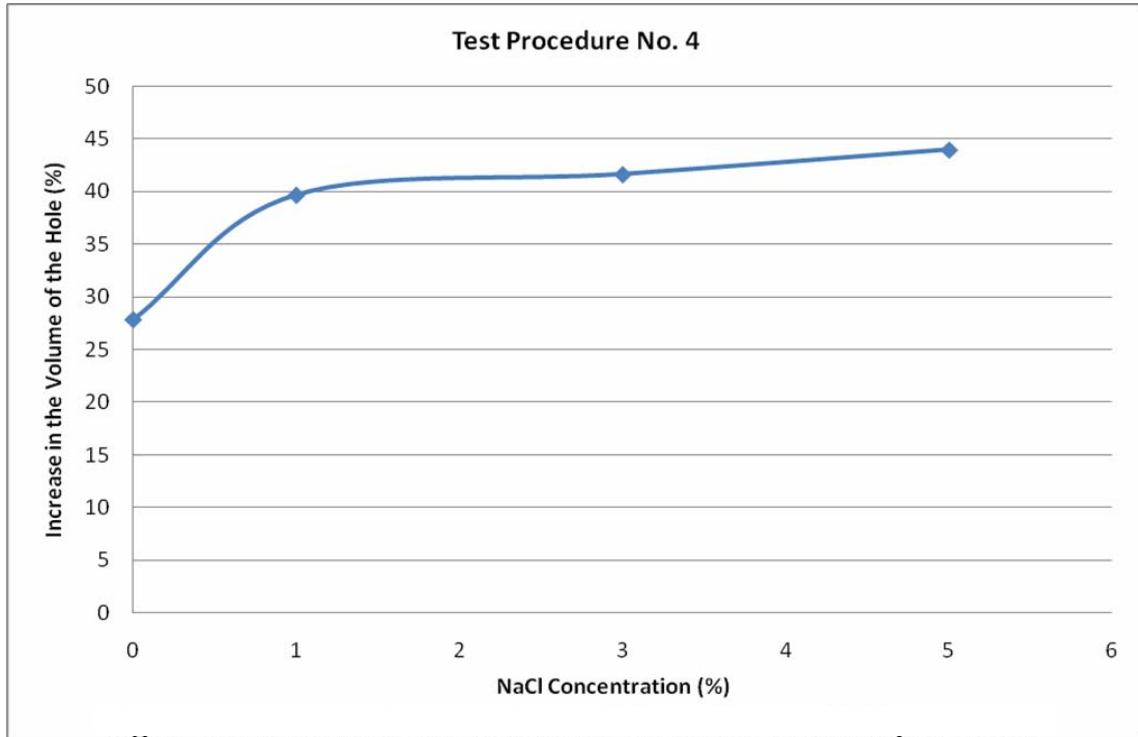

Figure 19: Increase in the volume of the hole vs. water salinity

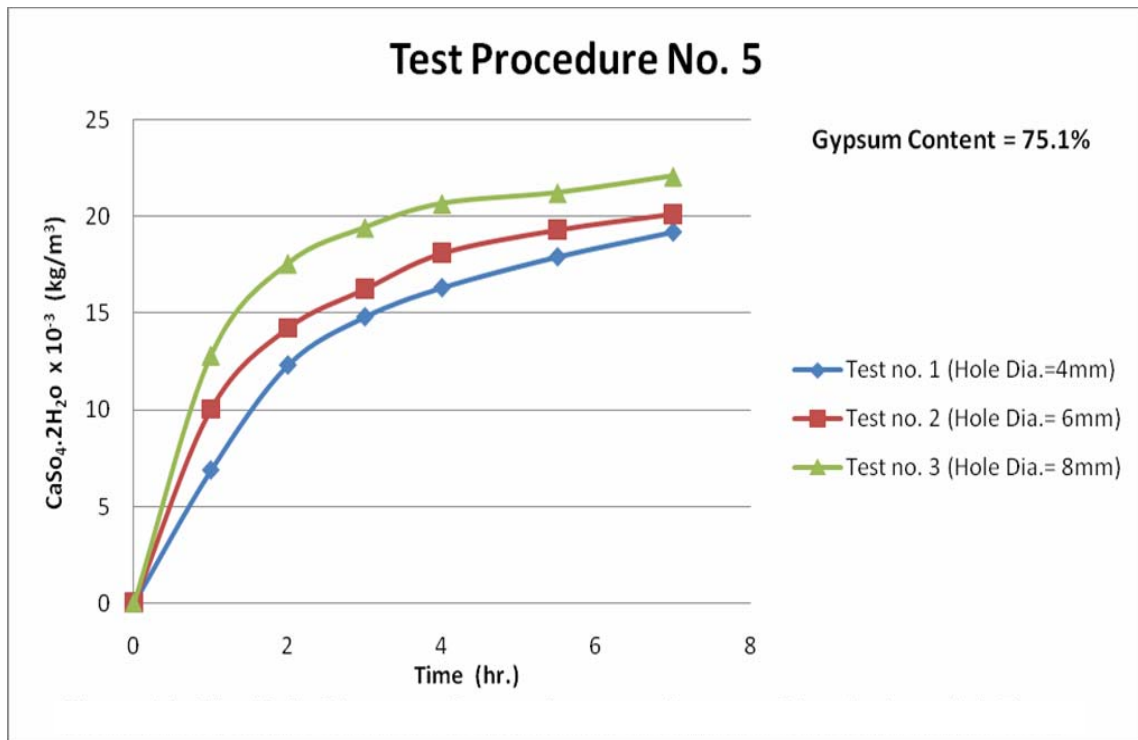

Figure 20: The hole diameter dependence on gypsum dissolution with time

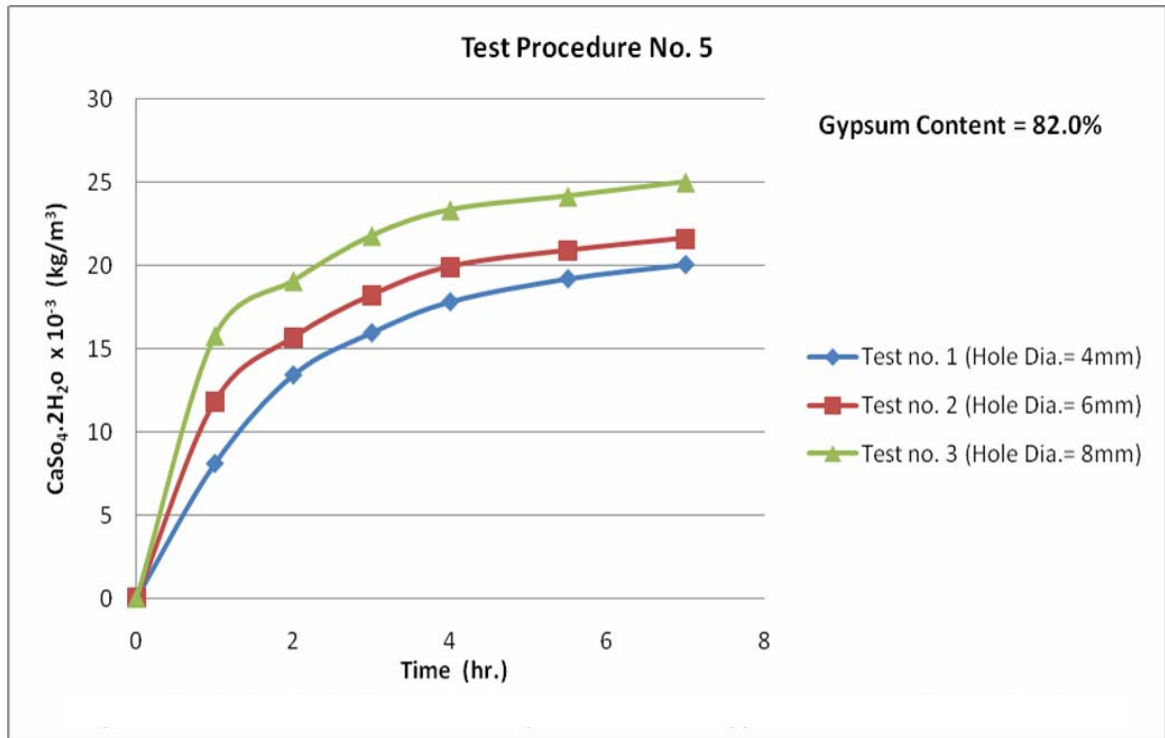

Figure 21: Axial hole diameter dependence on gypsum dissolution with time

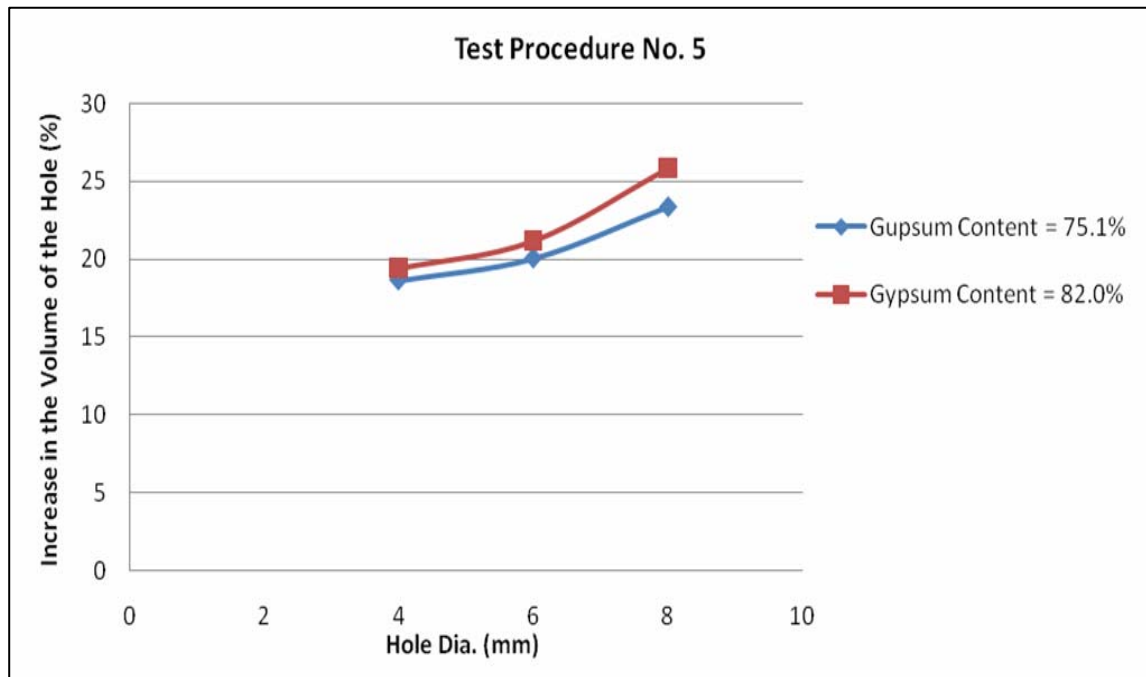

Figure 22: Increase in the volume of the hole vs. hole diameter

The above arguments are supported by the evidences observed from the percentage increase in the volume of the hole. Figure 19 illustrates the percentage increase in the volume of the hole *versus* the salinity of the solvent. This Figure shows no significant difference between the distilled water and the river water as solvents, and the big jump occurred when the NaCl concentration was increased to 1%. Above this percentage (i.e., for 3% and 5%), the increase in the volume of the hole was less significant.

It is worth mentioning that the dissolution caused by NaCl present in the solvent creates different shapes of irregularities along the inside surface of the hole. These irregularities were observed along the holes after inspection at the end of each test. The concentration of the dissolution for this particular sample is mainly due to the gypsum salts since from chemical analysis, the total soluble salts and gypsum contents are 87.9% and 84.7%, respectively, indicating that the adverse effect of the presence of NaCl in the solvent encourages the dissolution of gypsum.

#### **Diameter of the Hole Dependence**

The previous literature indicated that the amount of dissolution may be controlled primarily by the surface area exposed to water (Calcano and Aizura, 1967). To clarify this argument, two samples were tested with gypsum contents of 75.1% and 82.0%. The initial diameters for the holes were: 4 mm, 6 mm and 8 mm. The velocity of the discharged water was kept constant (about 0.64 m/sec) throughout the test. The dissolution concentrations *versus* time for the two samples are shown in Figures 20 and 21, respectively.

The results show a higher increase in the gypsum dissolution with increasing diameter of the hole (i.e., with increasing the area exposed to water). This observation may probably lead to the point that large fissures present in the rock in nature will generate more dissolution throughout the action of flowing water.

The above statement is supported by the increase in the volume of holes for each test as shown in Figure 22.

## **CONCLUSIONS**

The thorough discussion presented before regarding the dissolution of gypseous rocks sheds light on several points:

- 1- The influence of temperature on the amount and rate of gypsum dissolution was evaluated between temperatures ranging from 23°C to 37°C. In general, high temperatures generate high amounts and rates of gypsum dissolution.
- 2- The flow velocity ranging from 0.64 m/sec to 1.18 m/sec exhibited turbulent flow through the holes of the samples. At low gypsum content, the influence of flow velocity was marginal; whereas at higher gypsum contents the influence of flow velocity was substantial at the latter stage of the test. In general, the final concentrations of gypsum dissolution increase with increasing flow velocity from 0.64 m/sec to 1.18 m/sec.
- 3- Samples of high gypsum content exhibited higher amounts and rates of gypsum dissolution. This statement is true irrespective of the flow velocity and temperature.
- 4- For the salinity of the solvent, the main points observed were the marginal effect of the salinity for the river water and the drastic change in the gypsum dissolution for a 1% NaCl solution.
- 5- The diameter of the hole (representing the size of the fissures present in the rock) has an influential effect on the amount of gypsum dissolution due to the increase in the area exposed to water. Accordingly, the amount of the gypsum concentration increases with increasing the diameter of the hole.
- 6- The measurements of the increase in the volume of the hole show a good indication for the amount of dissolution which occurred through the test. These measurements support the results obtained from the tests.
- 7- The above points clarify the importance of parameters influencing the dissolution of gypseous rocks. These points should be considered in the

design and performance of the long-term stability

and safety for the proposed dam project.

### REFERENCES

- Al-Muftay, A. A. 1997. Effect of Gypsum Dissolution on the Mechanical Behavior of Gypseous Soils, Ph.D. Thesis, Civil Engineering Department, University of Baghdad.
- Al-Rawi, O. 1998. The Dissolution of Gypseous Rocks in the Proposed Site of Al-Fat'ha Dam, Ph.D. Thesis, Building and Construction Department, University of Technology.
- Berner, R. A. 1980. Early Diagnosis: A Theoretical Approach, Princeton University Press, Princeton, New Jersey.
- Calcagno, C. E. and Aizura, P. R. 1967. Problems of Dissolution of Gypsum in Some Dam Sites, *Bull. Venezuelan Soc. of Soil Mechanics and Foundation Engineering*.
- Euphrate Center for Studies and Designs of Irrigation Projects. 1993. Evaluation of the Geological Investigations, Geophysical Surveys and Laboratory Tests for Al-Fat'ha Dam Project.
- Hanna, T. H. 1985. Solution of Soluble Minerals in Dam Foundation Rocks, Mosul Dam Project, Report No. RKMJS -132.
- James, A. N. and Lupton, A. R. R. 1978. Gypsum and Anhydrite in Foundations of Hydraulic Structures, *Geotechnique*, 28 (3): 249-272.
- James, A. N. and Kirkpatrick, I. M. 1980. Design of Foundations of Dams Containing Soluble Rocks and Soils, *Q. J. Engineering Geology*, 13: 189-198.
- Liu, S. T. and Nancollas, G. H. 1971. The Kinetics of Dissolution of Calcium Sulphate Dehydrate, *J. Inorg. Nucl. Chem.*, 33: 2311-2316.
- Nafie, F. A. 1989. The Properties of Highly Gypseous Soils and Their Significance for Land Management, Ph.D. Thesis, University of London.
- Oil Exploration Company. 1993. Site Investigations, Geophysical Survey and Geotechnical Laboratory Testing Report.
- Subhi, F.T. M. 1987. The Properties of Salt Contaminated Soils and Their Influence on the Performance of Roads in Iraq, Ph.D. Thesis, Queen Marry College, University of London.
- Swiss Consultants. 1980. Al-Fat'ha Dam Project, Analysis Report.
- Technoprom Export Company. 1962. Technical and Economic Report on Regulation of Middle Course of Tigris River, Moscow.
- U. S. D. A. 1954. Diagnosis and Improvement of Saline and Alkali Soils, Agricultural Handbook, No. 60, Washington 160.