

# Effect of Flange Width on Flexural Behavior of Reinforced Concrete T-Beam

Ofonime A. Harry

Institute for Infrastructure and Environment, University of Edinburgh, UK

Ndifreke E. Udoh

Department of Civil Engineering University of Uyo, Uyo, Nigeria

## Abstract

Reinforced concrete T-section beam is widely used in building and bridge construction. In most cases, the reinforced concrete T-section may be monolithic which implies that part of the slab close to the beam section help in resisting the flexural load. Understanding the effect of flange width of beam in such monolithic section is very crucial in designing effective and efficient structure. This study presents a numerical study of the effect of flange width on the flexural behavior of reinforced concrete T-section beam. Three different flange width which include 200, 400 and 600mm were considered in this study. The result shows that stiffness of the beam increases with increase in flange width. The initial cracking load is influence by the flange width. The wider the flange width, the higher the cracking load. The result in terms of mid-span deflection and cracking shows no appreciable difference in the different flange width considered in this study. Finally, the findings show that behavior of reinforced concrete T-section beam in terms of cracking and failure load, deflection, reinforcement strain and crack pattern can be accurately simulated using LS DYNA.

**Keywords:** Reinforced Concrete T-section beam, Flange width, Cracking load, LS DYNA

## 1.0 INTRODUCTION

In reinforced concrete building construction, structural elements such as slab, beam and column are used to transfer load to the foundation. These elements may be precast or cast in-situ. In the former, the structural elements are cast in a reusable mold either within or outside the construction site before being lifted into its place while in the later slab, beam and column are cast in place to form a monolithic reinforced concrete structure. In in-situ concrete slab-beam system, part of the slab may help resist flexural load and the beam is no longer considered as rectangular but a T or L-section depending on the location of the beam. For reinforced concrete T-section beam subjected to tension (sagging moment), part of the slab will help resist compression forces to balance the positive bending moment acting in the beam web. Design codes set out guidelines to determine effective width of flange to be used in design. For instance, in BS 8110 the effective flange width is taken as the lesser of  $b_w + 0.2l_z$  and actual flange width, where  $l_z$  is the distance between point of zero bending moment. In a continuous reinforced concrete beam,  $l_z$  may be taken as 0.7times the effective span length. Similar requirement is also outlined in Eurocode 2, ACI 318, Canadian code and other design codes. Using this flange width, the flexural capacity for a given T-section may be determined through sectional analysis. However, the problem become complex when slab reinforcement is placed in both directions for example in a two-way slab which is very common in a typical reinforced concrete construction.

To understand the effective flange width contribution to flexural load resistance and the crack pattern in such complex scenario, a full scale testing involving consideration of key parameters such as flange width is necessary. Sleiman (1984) tested three reduced scale reinforced concrete T-section beams with different flange width. His result indicated that all tested beams had ductile behavior and failed in flexure. This experimental tests are not only expensive, but time consuming. Recently, finite element method has proved to be an effective tool which can complement the experiment, thanks to the high speed computers available. With finite element method, a high fidelity physics based model of reinforced concrete structural elements can be created thereby allowing the behavior of reinforced concrete T-beam to be holistically studied. A number of commercial finite element codes (ABAQUS, ANSYS, LS DYNA, ADINA, ATENA, etc.) are available to analyze the behavior of reinforced concrete elements. These finite element codes have extensive material library with material models

which can accurately capture the complex behavior of reinforced concrete.

A number of research on the flexural behavior of reinforced concrete rectangular and T-section beam have been investigated using these codes. Badiger & Malipatil (2014) carried out parametric study on the flexural behavior of reinforced concrete beam using ANSYS. The parameters investigated in their study included depth of beam, percentage of longitudinal reinforcement, steel cushion and shear reinforcement. Their result showed that load carrying capacity of beam increased with increase in beam depth. They concluded that varying reinforcement ratio only had effect on the failure load but not the initial cracking load. In another study, Sinaei *et al.* (2012) compared the experimental and numerical simulation of the behavior of reinforced concrete beam using ABAQUS finite element code. Their result in terms of mid-span displacement, reinforcement strain and crack pattern were consistent with that of the experiment. Ren *et al.* (2015) performed a test and numerical study on T-beam strengthened with bonded steel plates. The result of both numerical and test result matched reasonably well and the T-beam with no strengthening had a ductile behavior which resulted in flexural failure. Most of the numerical investigation on reinforced concrete beam have been focused on rectangular section whereas the behavior of reinforced concrete T-beam have seldom been studied. This paper presents a numerical study on the effect of flange width on the flexural behavior of reinforced concrete T-section beam using an explicit finite element software (LS DYNA).

## 2.0 DETAIL OF EXPERIMENTAL TEST CONSIDERED IN THIS STUDY

Simply supported reinforced concrete T-section beam with no strengthening tested by Hussain *et al.* (2013) is adopted to develop and validate the finite element model used for this analysis. The reinforced concrete T-section beam was 4m with a clear span of 3.75m. The beam had a height of 375mm with flange width of 400mm. Two longitudinal reinforcement of diameter 16mm were used in the bottom section of the beam while six bars of diameter 8mm were placed in the flange section. Shear resistance was provided by 6mm diameter bar with 100mm spacing. The compressive and tensile strength of concrete were 30.7 and 2.52MPa respectively while the modulus of elasticity for concrete was 25742MPa. Longitudinal reinforcement in the bottom section had a yield strength of 420MPa, top longitudinal reinforcement and stirrup had yield strength of 265 and 240MPa respectively. The geometry and reinforcement detail of the beam is shown in figure 1.

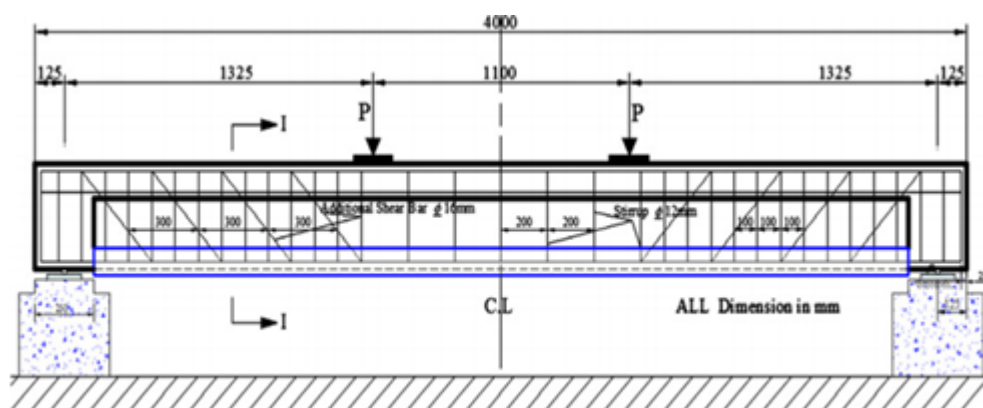

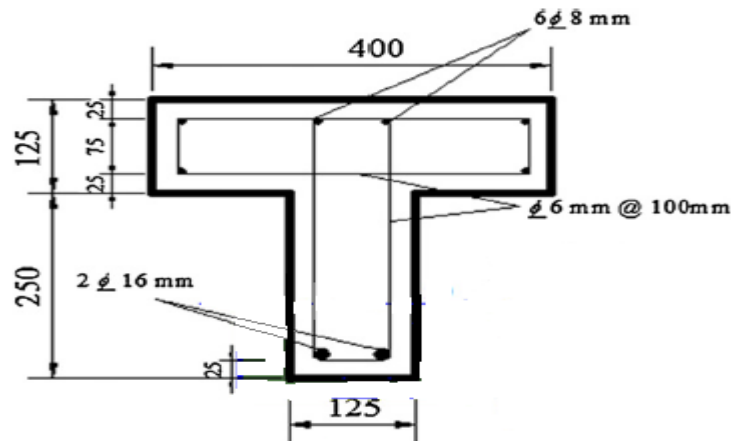

Figure 1: Longitudinal and sectional beam detail (Hussain *et al.* 2013)

### 3.0 FINITE ELEMENT MODEL

#### 3.1 Description of model

The numerical simulation is carried out using LS DYNA. 8-node solid elements with reduced integration are used for concrete whilst 2-node beam element are used for reinforcement. Concrete nodes and beam element nodes are meshed together such that under loading they have the same displacement. This result in perfect bond between concrete and rebar.

Concrete behavior is modelled with a continuous surface cap model (MAT\_CSCM\_CONCRETE or MAT\_159 in LS DYNA). This model has an isotropic constitutive equation with a yield surface which is formulated based on three stress invariant. It also has the ability to capture damage-based softening with erosion and modulus reduction. In addition, the model can capture confinement, tensile and compressive behavior of concrete using a refined mesh. Longitudinal and transverse reinforcement is modelled with piecewise linear plasticity (MAT\_24 in LS DYNA) using Hughes-Liu beam with cross-section integration. A mesh convergence study was performed after which a mesh size of 12.5mm was selected for beam and solid elements. After validating the FE model with experiment, the flange width of the beam was varied. To achieve the aim of the present study, all other parameters were kept constant while varying the flange width of the beam. Three different flange widths were selected for this investigation. Table 1 shows the size of flange width and the number of solid and beam elements in each case.

Table 1: Summary of element in the finite element models

| Model name | Flange width (mm) | Number of solid element | Number of beam element |
|------------|-------------------|-------------------------|------------------------|
| A          | 200               | 30072                   | 1552                   |
| B          | 400               | 46144                   | 1872                   |
| C          | 600               | 62236                   | 2192                   |

#### 3.2 Load and boundary condition

Taking advantage of symmetry, only one-quarter of the beam is modelled. Appropriate boundary condition is applied. This is achieved by restraining the displacement in the direction perpendicular to the plane of symmetry. To avoid localized damaged at the load application point and the support, a steel plate with elastic properties is used. The interaction between these steel plates and concrete is defined by AUTOMATIC SURFACE TO SURFACE contact in LS DYNA. In the contact definition, concrete is specified as the master surface while the steel plate is the slave surface. All top nodes of the steel plate at the loading point are pushed down following a prescribed time-displacement curve while ensuring that dynamic effect is negligible, to mimic a quasi-static

loading. Figure 2 shows the one-quarter finite element model of the reinforced concrete T-beam.

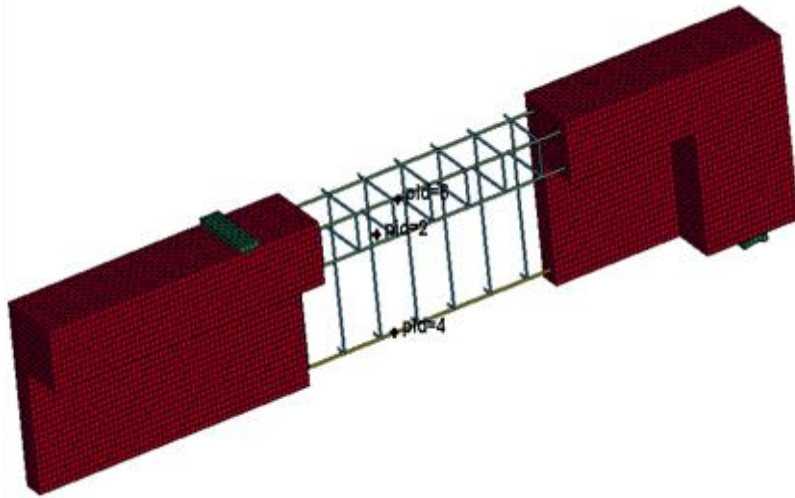

Figure 2. Finite element model of RC T-section beam

#### 4.0 RESULT AND DISCUSSION

##### 4.1 Comparison of test and FE result

Figure 3 shows the load vs mid-span displacement response of the test and finite element model. As can be seen from this figure, the finite element model prediction agrees well with the experiment. It should be mentioned that the applied load herein is the total load acting on the beam. The slight difference between the test beam and the FE model occur at the point of initiation of cracks. Comparison in terms of bottom longitudinal reinforcement strain shown in figure 4 match well with experiment. Therefore, the developed model is suitable to be used in investigating the flange width effect on the flexural behavior of RC beam.

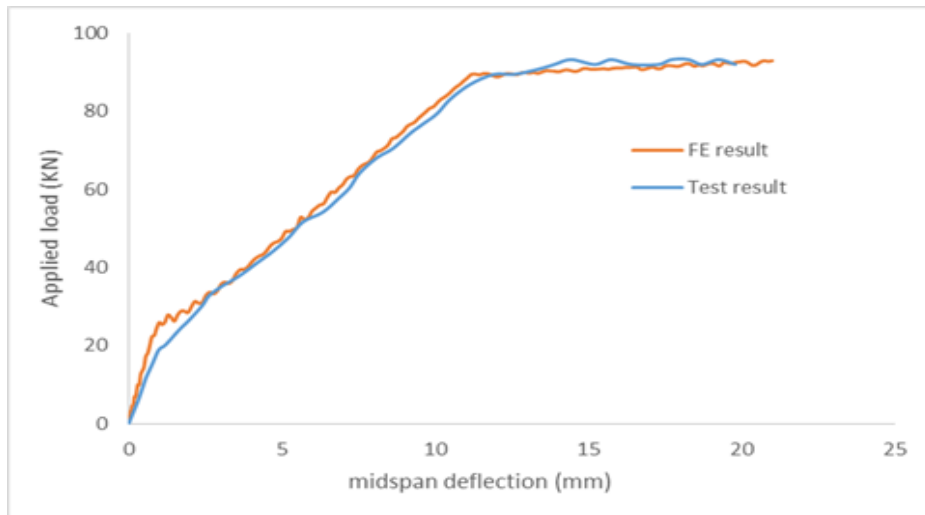

Figure 3. Experimental and Finite element load-deflection curve

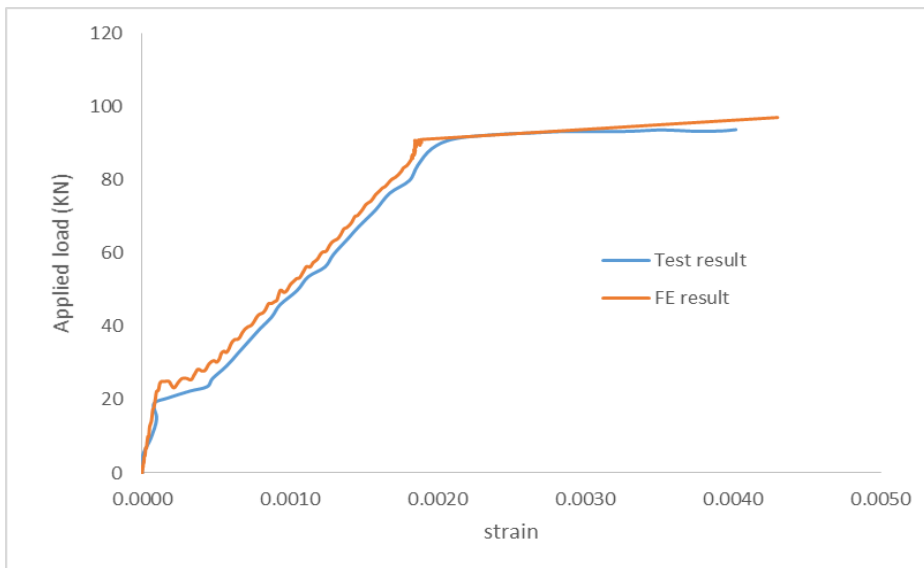

Figure 4. Experimental and Finite element load-strain curve

#### 4.2 Comparison of FE models with different flange width

Figure 5 shows the load displacement response of the three models considered in this study. It can be seen that cracking load increases with increase in flange width and yielding occur at slightly smaller mid-span displacement in the model with larger flange width. This difference is small compared to the difference in the yield load. For instance, the difference between yield load in beam with flange width of 200 and 600mm is about 7%. Concrete damage distribution at failure is shown in figure 6 with 0 representing no damage and 1 representing complete damage. In all the beams, damage develops as bending cracks starting from the loading point and propagate to the support. The crack also penetrate into the flange. As would be expected, flexural crack occurs between the load and the mid-span due to the constant moment without any shear in the middle section of the beam. The crack between the point load and support is due to combine effect of flexure and shear. This result is in line with the test carried out by Sleiman (1984) in terms of the crack pattern and the load displacement response.

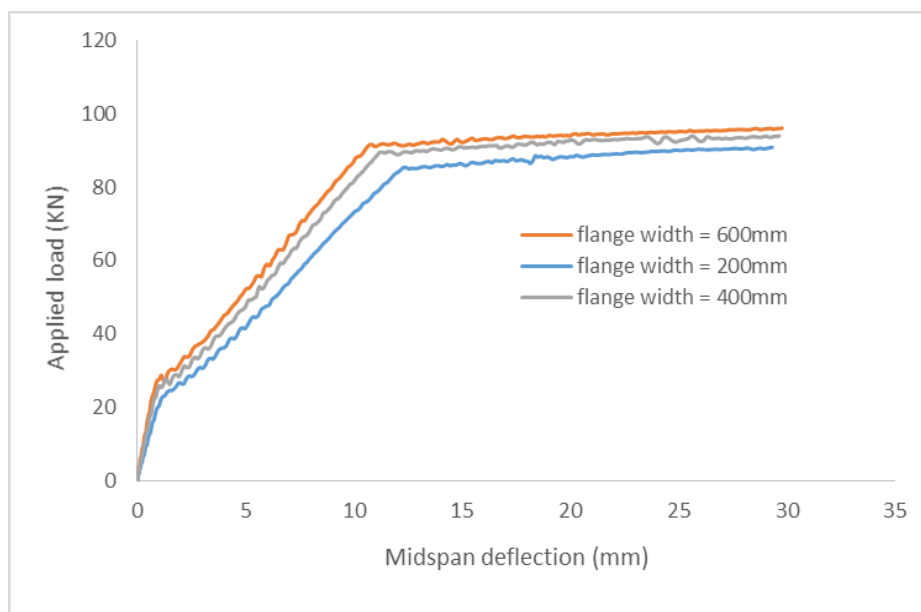

Figure 5. Load displacement curve of beams with different flange width

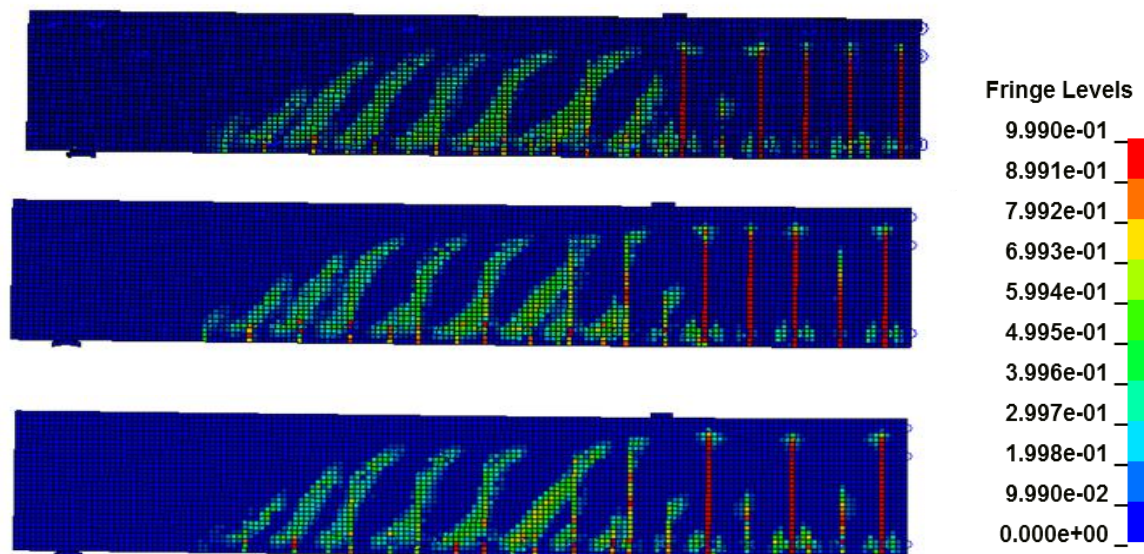

Figure 6. Concrete damage index contours showing the crack patterns at a displacement of 28mm for FE models of RC beam with flange width of (a) 200mm (b) 400mm (c) 600mm (contour represent damage index: 0 = no damage, 1=complete damage)

## 5.0 SUMMARY AND CONCLUSIONS

In this study, the effect of flange width on the flexural behavior of reinforced concrete T-section beam under four points loading is presented. Experimental test of T-section RC beam in the literature was used to validate the models. Based on the three different flange widths investigated in this study, the following conclusions can be drawn:

1. Reinforced concrete T-section beam can be accurately modelled using LS DYNA.
2. The deflection, load and strain of the finite element model compare favorably well with that of the test result.
3. Stiffness of the reinforced concrete T-section beam increases with increase in flange width.
4. The crack pattern of reinforced concrete beam with different flange width is the same.
5. Cracking of concrete and yielding of reinforcement is affected by the flange width.
6. The result of this research shows that flange width affect the stiffness, initial crack and yield load. The scope of the present study was limited to three different flange widths which were 200, 400 and 600mm. Further research is needed in order to determine the effect of much larger flange width on the behavior of T-beam.

## References

- Badiger, N.S. & Malipatil, K.M., 2014. Parametric Study on Reinforced Concrete Beam using ANSYS. Civil and Environmental Research, Vol. 6(8), pp.88–95.
- British Standards Institution, 1985, Code of Practice and Design and Construction (BS 8110: Part 1:1985), British Standards Institution, London.
- British Standards Institution, 2004. Eurocode 2: Design of Concrete Structures: Part 1-1: General Rules and Rules for Buildings. British Standards Institution.
- CSA Committee A23.3 (2004). Design of Concrete Structures, Canadian Standards Association, Mississauga, Ontario, Canada, 214 pp.
- Hussain, H.K., Zhen, L. & Wei, G., 2013. An Experimental Study on Strengthening Reinforced Concrete T-beams using new Material Poly-urethane-cement ( PUC ). Construction and Building Materials Vol. 40, pp.104–117.

- LSTC, 2006. LS-DYNA User Manual. Livermore Software Technology Corporation.
- Ren, Wei, Sneed, Lesley H, Gai, Yiting and Kang, Xin, 2015. Test Results and Nonlinear Analysis of RC T-beams Strengthened by Bonded Steel Plates. *International Journal of Concrete Structures and Materials*, Vol. 9(2), pp.133–143. Available at: <http://dx.doi.org/10.1007/s40069-015-0098-3>.
- Sinaei, H., Shariati, M., Abna, A., Aghaei, M. and Shariati, A., 2012. Evaluation of Reinforced Concrete Beam Behaviour using Finite Element Analysis by ABAQUS. *Scientific Research and Essays*, Vol. 7(21), pp.2002–2009.
- Sleiman, A. I. (1984). A Study of the Effective Flange Width of a Reinforced Concrete T-beam Using Small-scale models, unpublished report for graduate course: Experimental Analysis of Nonlinear Structures, Department of Civil and Architectural Engineering, Drexel University, Philadelphia