

Behavior of Reactive Powder Concrete Columns with or without Steel Ties

Mohammed Mansour Kadhum* Bushra Salman Mankhi
Department of Civil Engineering, College of Engineering, Babylon University, Iraq

Abstract

In this paper, an experimental work was carried out to investigate the behavior of reactive powder concrete (RPC) columns with or without steel ties. The main objective of this work is to investigate experimentally the behavior of RPC columns, to search the effect of the experimental variables, type of concrete (RPC and NSC), percentage of micro steel fibers and spacing between steel ties. Twelve RPC columns and five NSC columns were cast and tested under concentric axial compression load up to failure and the results are reported herein. The experimental results showed that RPC column specimens failed in a controlled manner without observing spalling of concrete cover or buckling of the longitudinal reinforcement to well beyond the peak load due to the inclusion of steel fibers in RPC. Also, the space and amount of steel ties affect the load carrying capacity of columns by increasing the load carrying capacity with decreasing spacing of lateral ties.

Keywords: Reactive powder concrete, Steel ties, Crack width, Load carrying capacity.

1. Introduction

Reactive powder concrete (RPC) is one of the recent advances in concrete technology and it addresses the shortcomings of many concretes today, to be classified as ultra-high performance concrete (UHPC). Unlike conventional and high strength concrete, RPC containing a significant quantity of steel fibers exhibits high ductility and energy absorption characteristics. RPC is a special concept for high performance concretes, whereby ductility is achieved through incorporation of a large content of metallic fibers. The inclusion of fibers delays the dilation of concrete by acting as crack arresters and, thus, helps indirectly in confinement of concrete under compressive loads (Malik and Foster 2008). One of the elementary advantages of RPC is that it can show substantial tensile strength and toughness. Much of properties improvement is mostly given to the reactive powder concrete by adding discontinuous, short steel fibers through the mixing of concrete (Graybeal, B. 2010). In fiber composite, the strength characteristics of the fiber, the bond in the matrix-fiber interface, the ductility of fiber, volume, the dispersion and orientation and their shape and aspect ratio influences on the increase in strength and toughness, the degree of ductility, the extent of post-cracking behavior and simple and multiple cracking (Mahesh, K. and Chetan, D. 2010). The ductile tensile failure mechanism, fiber reinforced reactive powder concrete (FR-RPC) may lead to remove the need for conventional tie reinforcement in columns. Reactive powder concrete may also be used from the stand point of weight reduction or architectural aspects (Maha et al. 2013). A reinforced concrete column is a structural member, which is used primarily to carry compressive loads, composed of concrete with an embedded steel bars to provide reinforcement. RPC exhibited a tensile strength unheard in conventional concrete, allowing for the possibility to build structural members without passive reinforcement (for example, conventional steel ties in columns) and combines innovation, aesthetics and lightness. Column is enlarging of foundation, so using RPC will decrease the weight of column cause reduce settlement of foundation (Prabha et al. 2010). Therefore, the designer can use smaller sections of structural members of RPC, resulting in the use of a smaller amount of material and can give the same capacity. The strength of columns is controlled by the strength of the material (especially the compressive strength of concrete) and the geometry of the cross section (Yaarub G 2014). Malik et al. (2010) conducted an experimental study to evaluate the behavior of ultra-high strength reactive powder concrete (RPC) columns strengthened by carbon fiber-reinforced polymers (CFRPs) and exposed to concentric and eccentric loadings. They casted seventeen columns with the concrete mixture consisting of either no fibers, with a concrete strength of approximately 140 MPa, or 2% by volume of straight steel fibers, with a concrete strength of approximately 165 MPa. The column specimens included no conventional steel reinforcement, either in the longitudinal or transverse direction with the tensile forces carried by the CFRP. Experimental data for strength lateral and axial deformation, and the failure mode were obtained for each specimen. For the concentrically loaded specimens, failure happened at or close to the peak loading with little or no residual capacity. Transverse strains measured at the fracture of the CFRP for confined columns were found to be considerably lower than the ultimate tensile strength described by the manufacturer or obtained from the standard tensile coupon tests. For the eccentrically loaded columns, the final failure was sudden and explosive but only after the peak load was passed and at the point of tearing of the CFRP wrapping. There was no evidence, however, that the use of CFRP in the hoop direction considerably increased the strength for the eccentrically loaded columns.

2. Experimental Program

2.1 Test Specimens

The experimental program included seventeen reinforced concrete column specimens, twelve specimens of RPC columns with reinforcing steel and without reinforcing steel are examined and compared with five NSC column specimens. All the column test specimens used in this study were cast with cross-section 150×150mm and a total length of 900mm. All columns were reinforced longitudinally with four steel bars with diameter of 10mm which were placed at each corner of specimens. These columns contained different transverse reinforcement (steel ties) of deformed bars with 5mm diameter and spaced at 20, 15, 10, 5cm to give good confinement effects but two of them were cast without steel ties. The concrete cover was 15 mm to the face of the tie for all the test specimens. The column specimens were tested in a 2500kN capacity testing machine with electrohydraulic jack. During testing, the main characteristics of the structural behavior of the column specimens were noticed at every stage of loading. At each column specimen test, the loads at first crack as well as the ultimate failure load with their corresponding axial displacement of the column and maximum crack width were all observed.

2.2 RPC Materials

In this study, the constituent materials making up the RPC were as follows: Mass Iraq ordinary Portland cement type (I), 0.175 water cementitious ratio, 3% by weight of cementitious super plasticizer type G54, Basf silica fume used as a replacement of cement and very fine sand with particle size 600 μm. Ordinary clean tap water was used for both mixing and curing of test specimens. Brass-coated micro steel fibers (13 mm long and 0.2 mm in diameter, tensile strength greater than 2500 MPa) were used throughout the experimental program. Additionally, an attempt was made to improve slurry at low water- cement ratios by using a high performance water reducing agent. While the mix design of NSC using local constituent is {1(cement): 1.3 (sand): 1.5(gravel)} according to ACI 211.1-02. Table 1 presents details of all the mix as used in this research.

Table 1. Details of all the Mixes used in the Present Research.

Mix type	Mix Proportion						
	Steel fibers % by vol.	Cement (Kg/m ³)	Sand (Kg/m ³)	Silica fume (Kg/ m ³)	Gravel (Kg/ m ³)	w/cm or w/c ratio	Super plasticizer (by wt. of cementitious)%
RPC1	1	940	940	160	-	0.175	3
RPC2	2	940	940	160	-	0.175	3
NSC	-	543	718	-	792	0.42	-

RPC1: Reactive powder concrete mix with 1% steel fibers.

RPC2: Reactive powder concrete mix with 2% steel fibers.

NSC: Normal strength concrete mix.

2.3 RPC Mixing Procedure

Adequate mixing is necessary to provide desirable concrete performance and homogeneity. In RPC mixes, expanding time of mixing is required to entirely diffuse the silica fume, break up any agglomerated grains, and permit HRWRA to improve its full potential. All the mixes of RPC specimens were performed in a rotary mixer of (0.09m³). All residual concrete from prior batch should be cleaned before using the mixer. The micro silica fume powder was mixed in dry state with the required quantity of cement for 5 minutes to ensure uniform dispersion of the reactive powder particles throughout the cement grains. Then, fine sand was loaded into the mixer and mixed for 5 minutes. The required amount of tap water was added to the rotary mixer within 1 minute. Then all the superplasticizers were added and mixed for an additional 5 minutes. When micro steel fibers were used, they were introduced, and dispersed uniformly. These were slowly added to the concrete by hand spraying through an additional 3 minutes, while the mix was rotating to encourage a uniform distribution of fibers throughout the concrete after the rest of the materials had been properly mixed and the concrete had a wet appearance then mixed for an additional 2 minutes. The mixing procedure of RPC, schematized in Fig.1, was rigorously applied for each batch. The mixing of one batch requires approximately 10 minutes from adding water to the mix. Flow table tests as per ASTM (C1437-05) were undertaken before casting of the specimens to assure that the fiber reinforced concrete mix had achieved a flow about 100 to 115%.

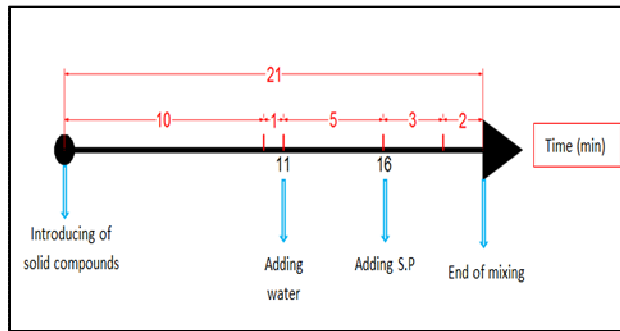

Figure 1. Mixing procedure of RPC.

2.4 Moulds Preparation

All the column test specimens used in this study were cast in steel moulds to obtain column specimens with cross-section 150×150 mm and a total length of 900 mm. Each one of these steel moulds consisted of lateral bracing as shown in Fig.2. These moulds were cleaned and their internal surfaces were greased to prevent adhesion with concrete after hardening. After greasing the moulds of the column specimens, reinforcement bars were held carefully in their position inside these moulds. In order to get a cover, small pieces of plastic termed (spacer) were placed at the sides of the column reinforcement. Also, steel plates, with dimensions $150 \times 150 \times 150$ mm were placed at the ends of the steel mould to strengthen the outside ends though the testing of column specimens. Fig.3 shows the details of the reinforcement of column specimens.



Figure 2. Details of the steel mould of column specimens.

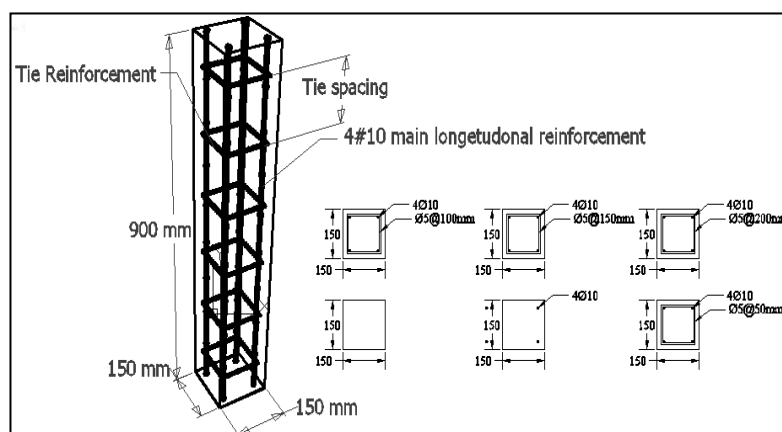

Figure 3. Shows the details of the reinforcement of column specimens.

2.5 Casting and Curing Procedures

The column specimens were cast in reusable steel forms and, due to the limited capacity of the concrete mixer, each column was cast separately. After mixing, the concrete was poured into the steel mould of column specimens. Compaction was provided by using electrical vibrating table for some minutes to ensure removing the entrapped air as much as possible. The specimen was then removed from the vibrating table, and its top surface was well finished using a steel trowel so that the upper surface of the steel block was kept on the same level with the concrete surface. The column specimens were compacted into two layers. After the fresh concrete

has hardened, all samples and column specimens were covered with polyethylene sheets to avoid moisture loss and after 24 hours from casting. The column specimens were submerged completely in water for 2 weeks. Then, the column specimens were left in the open air until the end of 60 days period and then testing.

2.6 Column Specimens Testing Procedure

Usually three days before testing, the column specimen surface was cleaned and painted white before testing to expose the formation of cracks and clearly photographed. Each column was lifted into place using a sling and the lifting device. Care was needed to be taken in the pickup and placement of each column. All the column specimens were placed vertically in testing machine and subjected to concentric loads. Both end supports were designed as hinged connections. The load was applied through a bearing plate for the axially loaded columns, and through a cylindrical roller with diameter ($D=2.5\text{cm}$) to simulate the hinge end of the column. Three dial gauges having accuracy of (0.001mm/div.) sensitivity dial gauge of 30mm capacity were used to measure the lateral deflection at the midheight and axial deformation. The readings of deformation versus loads were recorded simultaneously for each load increment. From testing all the column specimens, it can be clearly seen that there was no lateral deflection for all column specimens. The portable microscope was used to record the crack width of column specimens. Loading was applied slowly in small increments; this amount of incremental loading was allowed sufficient number of loads and corresponding displacements to be taken during the test which gave a good picture for the structural behavior of the column specimens. Testing continued until the column specimens showed a drop in load capacity with an increase in deformation.

3. Results and Discussion

3.1 General Behavior

The load carrying capacity reflected the ultimate applied load that can be subjected to the tested column specimens, after that a drop in machine reading appeared with a rapid deformation on column, which termed as failure. During the test of RPC reinforced column specimens, the sound of popping of steel fibers pulling out of concrete could be heard. However, loud noises were heard during the failure of RPC columns without reinforcement. The experimental test results are given in Table 2.

From experimental results, it can be concluded that the values of load carrying capacity increase with the use of micro steel fibers. Also load carrying capacity was increased by increasing the compressive strength of concrete and lateral steel reinforcement (steel ties) amount. At early stages of loading, the column deformations were initially within the elastic ranges, then the applied load was increased until the first crack occurred at approximately (60-70)% of the failure load. The cracks width increased before the peak load reached. By comparing among the two types of concrete, it can be noticed that the RPC columns are the strongest group according to the ultimate carrying load and then comes the NSC group. As a result, the load carrying capacity improved in each type of concrete, but with RPC column where the compressive strength was the greatest, the load carrying capacity of these columns magnified. This may be due to that the composition of RPC and the presence of steel fibers in concrete improve its properties, especially the compressive strength. The percentage of increase was dependent on the steel fibers content and lateral steel reinforcement amount as shown in Fig.4.

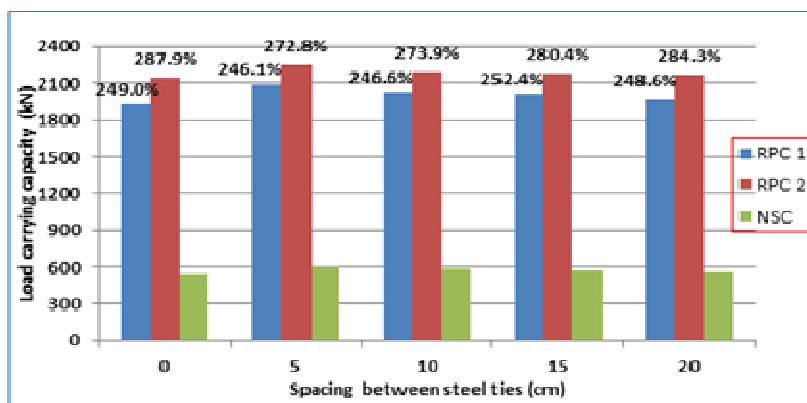

Figure 4. Development of the load carrying capacity in RPC and NSC column specimens.

Fig. 4 exhibits that the space and amount of ties affect the load carrying capacity of column specimens by increasing the load carrying capacity with decreasing spacing of lateral ties. In comparison with normal concrete column specimens (with the same steel reinforcement), the results of using 150mm tie spacing showed an increase in the load carrying capacity by 252.4% and 280.4% for RPC columns contained 1% and 2% steel fibers respectively. While for 100mm tie spacing, the increase was 246.6% and 273.9% for RPC columns contained 1% and 2% steel fibers respectively. At 50mm tie spacing, the increase was 246.1% and 272.8% for

RPC columns contained 1% and 2% steel fibers respectively. Moreover, the load carrying capacity of RPC2 (RPC contained 2% steel fibers) increased by 7.93%, 7.89% and 7.69% when using 150, 100 and 50mm tie spacing, in comparison with RPC1 (RPC contained 1% steel fibers). On the other hand, the results showed that increasing tie spacing from 150mm to 200mm, reduced the load carrying capacity by 2.67% to 0.53% for RPC columns contained 1% and 2% steel fibers respectively and 1.56% for normal concrete column specimens.

Table 2. The Experimental Results of the Tested Column Specimens.

Columns identification	fcu (MPa) at 28 days	Steel fibers %	Main reinforcement	Lateral reinforcement	First crack load (kN)	Load carrying capacity (kN)	Axial deformation (mm)	Crack width (mm)
RC1	130.6	1	without	without	1326.5	1895.0	5.1	0.720
RC2	138.2	2	without	without	1407.6	2070.0	6.2	0.672
RC3-S ₂₀	130.5	1	4Ø10	Ø5@20cm	1276.1	1963.2	6.1	0.612
RC4-S ₂₀	141.6	2	4Ø10	Ø5@20cm	1374.1	2164.0	6.9	0.576
RC5-S ₁₅	131.1	1	4Ø10	Ø5@15cm	1290.0	2015.6	5.8	0.582
RC6-S ₁₅	137.6	2	4Ø10	Ø5@15cm	1348.7	2175.4	6.7	0.552
RC7-S ₁₀	128.7	1	4Ø10	Ø5@10cm	1258.8	2030.3	5.6	0.564
RC8-S ₁₀	138.9	2	4Ø10	Ø5@10cm	1336.3	2190.6	6.5	0.528
RC9-S ₅	129.9	1	4Ø10	Ø5@5cm	1282.3	2085.0	5.5	0.546
RC10-S ₅	135.4	2	4Ø10	Ø5@5cm	1347.3	2245.5	6.4	0.510
RC11-S ₀	130.2	1	4Ø10	without	1272.0	1927.2	6.2	0.648
RC12-S ₀	136.8	2	4Ø10	without	1370.9	2142.0	7.1	0.618
NC1-S ₂₀	36.3	-	4Ø10	Ø5@20cm	90.4	563.1	3.5	1.176
NC2-S ₁₅	39.6	-	4Ø10	Ø5@15cm	87.3	571.9	3.3	1.164
NC3-S ₁₀	35.5	-	4Ø10	Ø5@10cm	89.6	585.8	3.1	1.152
NC4-S ₅	40.8	-	4Ø10	Ø5@5cm	92.5	602.4	2.9	1.146
NC5-S ₀	37.5	-	4Ø10	without	90.6	552.2	3.8	1.260

3.2 Failure Modes and Cracking Pattern

During the column specimens test, it can be observed that most of column specimens show very similar behavior at early loading stages. For all RPC column specimens the cracks initiated near the supports or the middle third of these columns during subsequent increase in the applied load. Photographs of the typical crack pattern and failure modes of the RPC and NSC column specimens at the completion of the test are shown in photographs in Fig.5 to Fig.7. It was observed that a sudden explosive type of failure occurred for all RPC column specimens without steel bars reinforcement. While RPC column specimens with steel reinforcement (minimum longitudinal and different lateral reinforcement) failed gradually in a ductile manner with high ultimate load bearing capacity, unlike conventional concrete column specimens which showed lesser ductility at failure. The behavior of RPC columns (with fibers) was more deformable than NSC (without fibers) columns. It was found that the cover in NSC columns exhibits early cover spalling followed by concrete crushing. This indicated the increase of ductility and ultimate strength of RPC columns. Also, the cracks number of RPC column specimens was more and its distribution was uniform and extended along the member length, which indicated the benefit of using the steel fibers in distributing the stresses along the column due to the increased ductility provided by these fibers. The strength gain and ductility of the concrete core decreased as the tie spacing increased. Tie spacing also controlled the buckling of longitudinal reinforcement. A possible cause may be due to large number of ties that were able to be placed along the height of the specimen. The closely spacing between steel ties provided excellent confinement for the concrete core and restricted the extension and widening of the cracks. Therefore, small crack width and the cover did not spall away from the section throughout the test of RPC column specimens and there was no evidence of buckling the longitudinal reinforcement. But NSC columns with closer spacing of ties, the transverse reinforcement controls buckling of longitudinal reinforcement after spalling of the concrete cover and yielded at a later stage of loading.

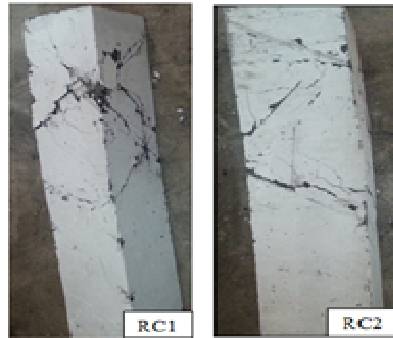

Figure 5. Modes of failure and crack patterns of RPC column specimens with 1% and 2% steel fibers and without steel reinforcement.

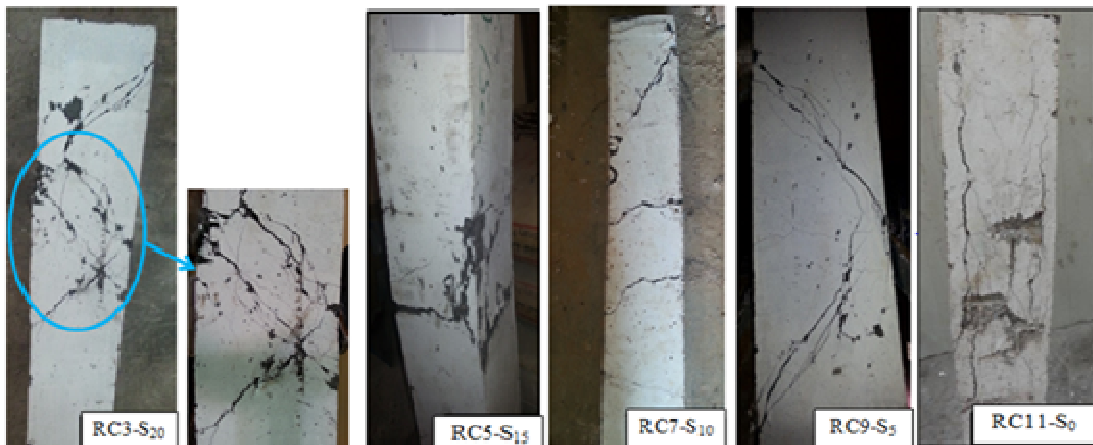

Figure 6. Modes of failure and crack patterns of RPC column specimens reinforced with 20, 15, 10, 5cm tie spacing and without steel ties.

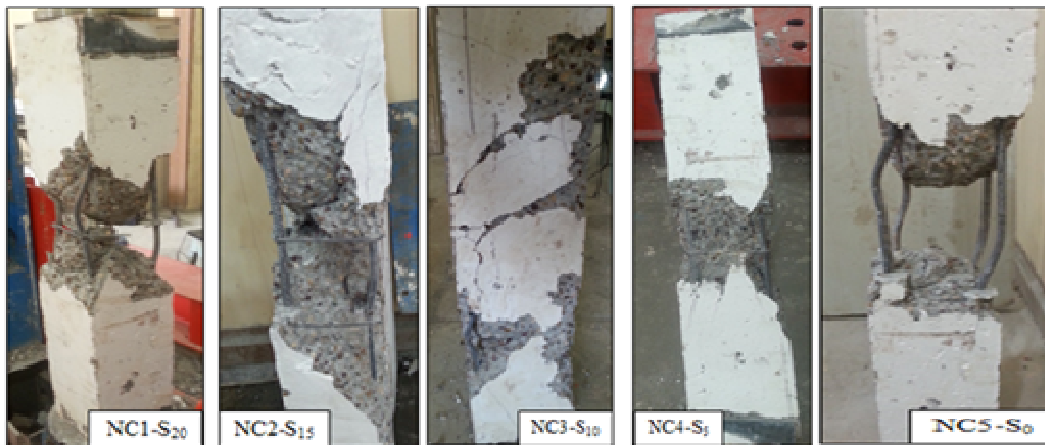

Figure 7. Modes of failure and crack patterns of NSC column specimens.

3.3 Load-Displacement Relationship of the Column Specimens

In all column specimens, the deformations were recorded immediately after the application of the load. At ultimate load, the rate of increase in deformation was so fast that no reliable deformation value could be measured. Therefore, the data of axial deformation was recorded approximately up to 93% of the ultimate load, because the final axial deformation at ultimate load cannot be measured due to the immediate type of failure of concrete column specimens. The load-displacement relationship of RPC and NSC column specimens is presented in Fig.8 to Fig.10. These curves showed that there is a linear relationship between the applied load and the resulted deformation during the elastic stage (i.e. before the first crack load), but lost this linearity afterwards, since the measurement of displacement after the presence of cracks leads to scattered readings due to cracking of concrete. From these Figures, it can be seen that the increase in volume fraction of micro steel fibers and lateral steel reinforcement amount has a significant increase on deformations of RPC column specimens. Also, it can be concluded that the combination between the steel reinforcement and the inclusion of steel fibers as 1% and 2%

by volume, makes the column response ductile, thus its strength increases. The ductility can be clearly seen by the long extension of the curve until the specimen failed. Finally, an increase in displacement values at the peak loads with delaying the propagation of cracks and control their growth in the columns can be noted for all column specimens with higher content of the lateral reinforcement and steel fibers.

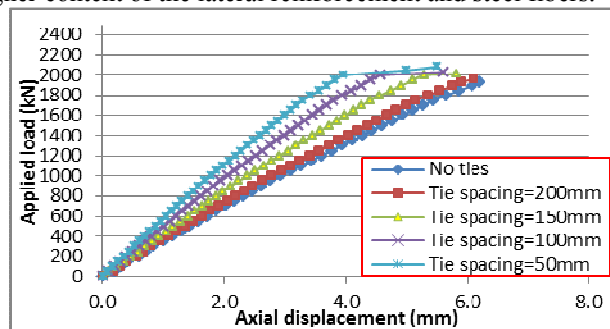

Figure 8. Applied load versus axial displacement of RPC column specimens reinforced with 1% steel fibers.

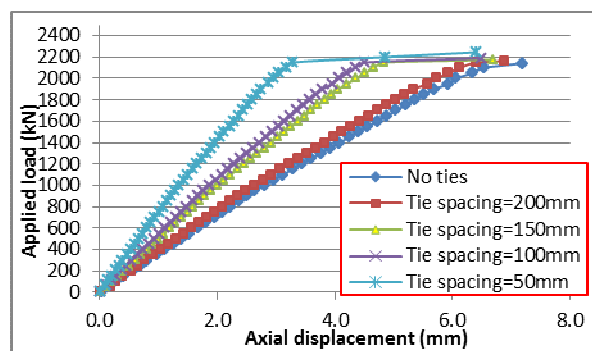

Figure 9. Applied load versus axial displacement of RPC column specimens reinforced with 2% steel fibers

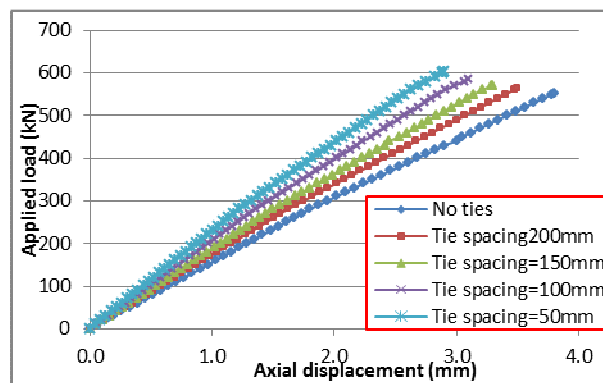

Figure 10. Applied load versus axial displacement of NSC column specimens with different spacing between steel ties.

3.4 Crack Width of the Column Specimens

Crack width was measured to the investigated columns at specific locations. The cracks initiated near the supports and the middle third of the column specimens during subsequent increase in the applied load. The crack width was obtained by the use of a portable dialed microscope. The data of crack width was recorded up to 90% or 93% of the ultimate load, because the final width of crack at ultimate load cannot be measured due to the immediate type of failure of concrete column specimens. These cracks widened progressively until a certain nearly constant width was reached at the end of test. The cracks were developed in the concrete when the tensile stress at the cover-core interface reached its strength limit. Once cover-core interface cracks have developed, the cover concrete was free to spall or buckle away. Generally, the influence of the micro steel fibers content on the development of the cracks was really good, where cracking was more diffuse and the opening of the crack was less compared to normal strength concrete column specimens. The possible reason due to that contribution of steel fibers to improve the properties of RPC as well as these fibers with different content usually lead to an increase in the ultimate load and ultimate deformation with delaying the development and propagation of cracks. Furthermore, controls their growth in the column specimens due to the fact that fibers bridging the cracks and,

thus, helped indirectly in confinement of concrete under compressive loads. It is well known that concrete confined with ties and well distributed longitudinal steel shows a significant strength gain and improved ductility. The effect of the spacing between steel ties on maximum crack width for different types of concrete (RPC and NSC) column specimens is shown in Fig.11. From this curve, it can be concluded that the maximum crack width increases with decreasing amount of transverse (tie) steel reinforcement for all column specimens and decreasing amount of steel fibers. So that the closely spacing between steel ties and presence of steel fibers provided excellent confinement for the concrete core and restrained the width of cracks.

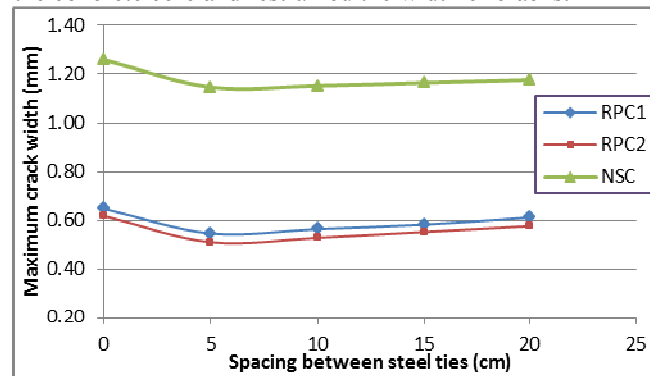

Figure 11. Maximum crack width versus spacing between steel ties for different types of concrete (RPC and NSC) column specimens.

4. CONCLUSIONS

The results from tests showed that the micro steel fiber additional results in more closely spaced cracks, reduced the crack width, bridged cracks and thus improved resistance to deformation in engineering applications. The cracks number of RPC column specimens was more and its distribution was uniform and extended along the member length, which indicated the benefit of using the steel fibers in distributing the stresses along the column due to the increased ductility provided by these fibers. This made the RPC column specimens failed gradually in a ductile manner, unlike conventional concrete column specimens which showed lesser ductility at failure. The results showed that the load-displacement curve extended beyond the peak load of RPC column specimens have different volume fraction of steel fiber 1% and 2%, which means that the ductility of these columns significantly improved compared to normal strength concrete column specimens. In this study, it can be indicated the ability of steel fibers to replace a portion of the steel ties by acting as small bars closely spaced and randomly oriented. This led to a conclusion that there is no need to use high amount of lateral steel reinforcement (steel ties) in RPC columns. So that, the benefit of using micro steel fibers in RPC column specimens instead of high amount of lateral steel reinforcement was satisfied for being economical in design and simple in construction.

References

- Malik, Adnan R., Foster Stephen J., (2008) "Behavior of Reactive Powder Concrete Columns Without Steel Ties", *Journal of advanced concrete technology*, Vol. 6, No. 2, PP.377-386.
- Graybeal, B. (2010) "Design, Fabrication, and Testing of a 2nd Generation Ultra-High Performance Concrete Pi-Girder," *Proceedings, 3rd International fib Congress*, Washington, DC.
- Mahesh, K. and Chetan, D., (2010) "Comparative Study of Reactive Powder Concrete Containing Steel Fibers and Recron 3S Fibers". *Journal of Engineering Research and Studies*, Gujarat, India, Vol. I, Issue I, July-Sept., PP.83-89.
- Maha, M.S., Taghreed, K., and Zeena, W., (2013) "Behavior of Axially Loaded Reactive Powder Concrete Columns" *Journal of Engineering and Development*, Vol.17, No.2, 2013, ISSN 1813-7822.
- prabha S. L., Dattatreya J. K., Neelamegam M., Seshagirirao M. V., (2010) "study on stress-strain properties of Reactive Powder Concrete Under uniaxial Compression", *International Journal of Engineering Science and Technology*, Vol. 2, No.1 , PP. 6408-6416.
- Yaarub G. Abtan (2014) "Behavior of Reactive Powder Concrete Columns Under Eccentric Compression Loading" *Diyala Journal of Engineering sciences*, Vol. 07, No. 03, pp. 54 - 46.
- Malik, Adnan R., Foster and Stephen J., (2010) "Carbon Fiber Reinforced Polymer Confined Reactive Powder Concrete Columns Experimental Investigation", *ACI Structural Journal*.
- ACI Committee 211.1-2002, "Standard Practice for Selecting Proportions for Normal, Heavyweight, and Mass Concrete (ACI211.1-02)", American Concrete Institute, Michigan, U.S.A.
- ASTM C 1437, (2005) "Standard Test Method for Flow of Hydraulic Cement Mortar", Vol. 04.01, PP. 1-3.