

# Development of a Power Flow Model for Optimal Location of Distributed Generators in Electrical Distribution Systems

Ganiyu Adedayo Ajenikoko    Adebayo Wasiu Eboda    Sanusi Bolaji Femi

Department of Electronic and Electrical Engineering, Ladoke Akintola University of Technology, P.M.B 4000, Ogbomoso, Nigeria

## Abstract

Distributed generation (DG) is any small scale electrical power generation technology that provides electric power at the load site. An increase in the number of DG units in commercial and domestic electrical power output has brought concerns over improvement of distribution network. Installing these generator units at no optimal places usually result in an increase in system losses and an undesired effect on the system. It is therefore important to develop a power flow model for optimal location of DG in the distribution system. This paper develops a power flow model for distribution system to determine the optimal placement of DG units in distribution network in order to reduce power losses. The feasibility and effectiveness of the developed model are demonstrated on the 33kV distribution network of EKO Electricity Distribution Company Plc (EKEDP) using computer simulations. The result revealed that the system loss is reduced by 1.1952p.u (that is 67% reduction) after introduction of DG which indicates a reduction in power losses with installation of DG at various feeders of the distribution system. The model confirmed that, with integration of DG in distribution network, the power losses are reduced and optimal DG placement is achieved. The analysis of the model will help to reduce the cost of electric power production and increase the capacity and efficiency of the electrical distribution systems.

**Keywords:** Distributed Generation, Distribution System, Power Flow, Power Loss, EKEDP, Optimal location, Power losses.

## 1. Introduction

Electrical energy is one of the yardsticks that determine the growth of the developed countries. Electrical energy has been used in all engineering, agricultural, education, domestic and research areas (Abbagana, Bakere, Mustapha. 2012). The process of making electricity available to the user starts from the power generating station, where energy is being generated from available sources like gas, oil, hydro, coal, thermal and bio-waste at a reasonable voltage level and is further stepped up for onward transmission. It is eventually transformed into power at a voltage level compatible with consumer requirements via the distribution substations that receive the energy from transmission stations (Ajenikoko, Olaomi. 2014).

Distribution system is the final stage in the delivery of electric power. It consists of the primary distribution lines (33 kV/11 kV) and secondary distribution lines (415 volts line voltage). It carries electricity from transmission system to individual consumers. Generally, distribution networks are built as interconnected networks while in operation they are arranged in a radial tree structure. The high tension consumers and distribution transformers are fed by the primary distribution lines. The distribution transformers feed the low voltage distribution networks which are the secondary distribution lines. The distribution system includes: the receiving station, the sub-transmission lines, distribution substation located closer to the load centre, secondary circuits on the low voltage side of the distribution transformer and service mains with metering arrangement (Ajenikoko, Olaomi. 2014; Ajenikoko, Eboda. 2016).

The existing distribution networks are actually growing in complexity due to the gradual increase of power demand and the existence of customers with more sensitive loads which has posed a challenging task to power system engineers in maintaining a reliable system economically. A load on an electrical distribution system can be classified as reactive, inductive or capacitive. The inductive load is the most common of these loads in most industries, shops and offices. Examples of these loads are transformers and florescent lights. An inductive load uses energy in order to do its work and also requires a certain amount of energy supply to function properly (Adesina, Ademola. 2016).

In the heavily loaded network, the load current drawn from the source would increase and this may lead to an increase in system losses. The performance of distribution system becomes inefficient due to the increase in distribution losses. However, changing environment of power systems design and operation has necessitated the need to consider active distribution network by incorporating distributed generation (DG) unit. DG is grid connected or stands-alone electric generation units located within the electric distribution system near the end user. The integration of DG in distribution system would lead to improving the voltage profile and reduce active power loss in distribution network (Subramanian, Jaisiva, Wathana, Neelan. 2015).

Electricity is one of the major driving forces behind modern machines and it is the backbone of a progressive economy. A nation with erratic supply of electricity will definitely be a nation with unstable economic growth (Varilane, Carpineli, Abur. 2002). Nigerian electric power utilities face epileptic power supply due to poor

generation level. The available power is characterized with high losses of total network losses. These losses have serious effects on the quality of power delivered to customers and adverse effect in meeting the expected revenue targets. Technical losses are caused by network impedance due to current flowing in the network and auxiliary supplies. Non-technical losses are caused by several factors which include, energy theft, unbilled accounts, non-payment of customers and estimated customer accounts (Adesina, Ademola. 2016).

Presently, the dimension topology of power distribution network has got larger due to increased scale of demand for the energy and this has contributed to the power losses significantly. Several mathematical approaches have been used for finding solution to distribution system loss with incorporation of DG. However, most of the methods fail to calculate the system losses due to low impedance and unbalanced load operation of distribution system.

The objective of the work is to develop a power flow model for distribution network for power loss reduction. Simulate the results using computer simulation and validate the simulation results by carried out the performance evaluation on the 33kV distribution network of EKO Electricity Distribution Company Plc (EKEDP) using active power, reactive power, apparent power and current measurements as input parameters.

### 1.1 Power Loss Minimization in Distribution Network

Power losses are considered when designing and planning electrical power network systems. Losses in the distribution network are largely caused by low power factor, poor voltage profile, high network impedance, poor joints, terminations and load imbalance among other incipient factors. The losses are the results of current flowing through the lines of distribution systems and its magnitude depends on the quantity of the current flow and the line impedance. Power losses in distribution system can be divided into two categories: real power loss and reactive power loss. The resistance of lines causes the real power loss while reactive power loss is produced due to the reactive elements. Real power loss reduces the efficiency of transmitting energy to customers due to the fact that reactive power flow in the system needs to be maintained at a certain amount for sufficient voltage level. Reactive power makes it possible to transfer real power through transmission and distribution lines to customers. The total real and reactive power losses in a distribution system can be calculated using equations (1) and (2). Different types of loads connected to distribution feeders also affect the level of power losses (Venkuta, Rama. 2014).

$$P_{Loss} = \sum_{i=1}^{n_{br}} |I_i|^2 r_i \quad (1)$$

$$Q_{Loss} = \sum_{i=1}^{n_{br}} |I_i|^2 x_i \quad (2)$$

Where

$n_{br}$  is total number of branches in the distribution radial network,

$|I_i|^2$  is the magnitude of current flow in branch  $i$

$r_i$  and  $x_i$  are the resistance and reactance of branch  $i$  respectively.

### 1.2 EKO Electricity Distribution Company PLC (EKEDP)

EKEDP is one of the leading Electricity Distribution Companies (Disco) in Nigeria. The Company covers the southern part of Lagos and Agbara in Ogun State, serving about 10 million people, in an area of 1200 sq. km. The corporate headquarter is situated at 24/25 Marina, Lagos, Nigeria. The company has TATA Power International PTE LTD as her technical partner. EKEDP owns and maintains a distribution network and supporting equipment, manages meter installation, servicing and billing, co-ordinates customer credit services, collects revenue and handles all customer related issues ensuring utmost customers' satisfactions. The distribution comprises of six feeders namely: Ademola, Alagbon, Alagbon Local, Anifowose, Banana Island and Flower. The network layout of EKO distribution network is depicted in Figure 1 (Ambafi, Nwohu, Ohize, Tola. 2012).

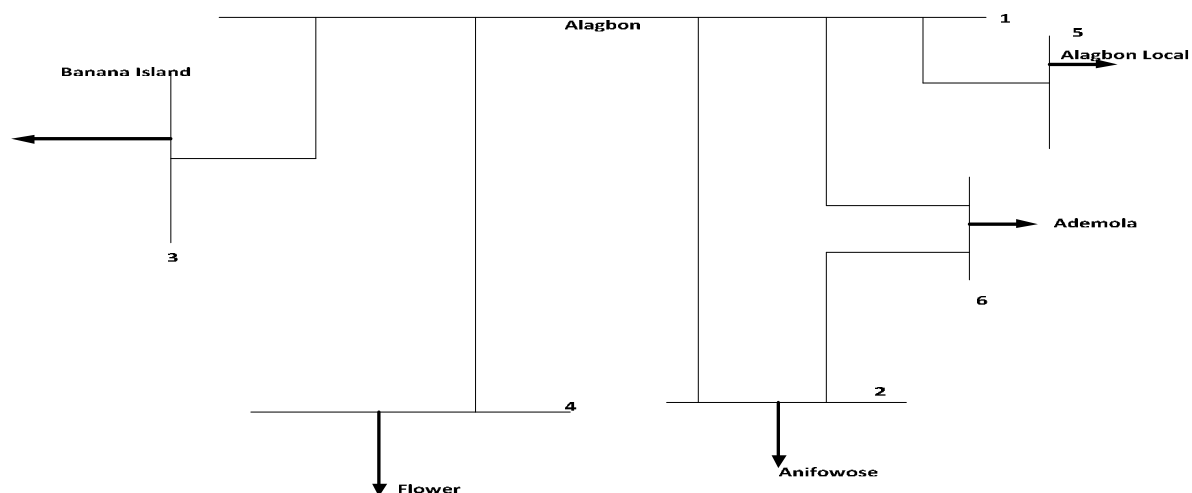


Figure 1: 33kV distribution network of EKO electrical distribution system

### 1.3 Distributed Generation

The utilities invested in Distributed Generation (DG) in order to address the power quality and reliability problems in distribution network and electricity supply to end users. In many instances, it is either the voltage profile is poor to the extent that equipment rated name plate voltage is hardly reached, hence creating serious operational problem and increased loss level. Challenges of establishing more power stations to ensure maintenance of grid integrity and extension to remote locations is necessary in developing economies like Nigeria. DG therefore becomes very handy in addressing power supply reliability and loss reduction in distribution networks (Muhammadi, Adinehvand, azadbakht. 2014).

DG is any small scale electrical power generation technology that provides electric power at the load site. It is either interconnected to the distribution system, directly to the customer's facilities, or both. DG causes a significant positive impact in electric power loss reduction due to its proximity to the load centers when it is optimally located. DG allocation is similar to capacitor allocation in loss minimization. The main difference is that the DG units cause positive impact on both the active and reactive power need of the distribution network, while the capacitor banks only have impact in the reactive power flow (Kenechi, Daniel, Edet, diarah. 2014).

In feeders with high losses, a small amount of DG of capacity (10-20% of the feeder load) strategically allocated could cause a significant reduction of losses. Optimal location of distributed generation entails positioning of the DG where its impact on loss reduction and system reliability is maximum. However, huge capital investment is required to implement distributed generation but may present a viable alternative when other factors as reliability and expansion schemes other than loss reduction are considered (Maju, Leena, saxena. 2016).

### 1.4 Power Flow for Distribution Network

The power flow solution is an important tool involving numerical studies applied to a power system. Power flow solution uses simplified notation such as a one-line diagram and per unit system, and focuses on various forms of AC power rather than voltage and current. It analyses the power system in normal steady operation. The power flow study of distribution network is of prime importance for effective planning of load transfer. It can be described by a set of recursive equations called distribution flow branch equations that uses the real and reactive power and voltage at the sending end of a branch to express the same quantities at the receiving end of the branch. This is used to determine voltage magnitude and phase angle at each bus, power flow in each branch, and power consumption at each power generation source and system losses (Indu, Sharma, anil. 2015).

In power flow solution, investigation is required in regard to bus voltages and amount of power flow through the distribution lines. It aims at reaching the steady state solution of complete power system networks. The solution to the power flow problem begins with identifying the known and unknown variables in the system [13]. The known and unknown variables are dependent on the type of Bus. A Bus without any generator connected to it is called a load Bus. While a Bus with at least a generator connected to it is called a Generator Bus. However, one of the generator buses is often selected as slack bus on generator bus, while the source of supply bus is normally used as slack bus on Load Bus. It is assumed that the real power (P) and reactive power (Q) at each load bus are known. Hence, load buses are referred to as PQ Buses (Emmanuel, Theopilus. 2016).

For Generator Buses, it is assumed that the real power (P) generated and the voltage magnitude  $|V|$  are known. For the slack Bus, the voltage magnitude  $|V|$  and phase angle  $\theta$  are specified. This implies that for the load bus, the voltage magnitude and angle are unknown and need to be calculated in the process. For the generator Bus, the

voltage angle is the unknown and need to be calculated in the process. For the Slack Bus, there are no variables to be calculated in the process. But where technical losses in the system are required, overall power from the Slack Bus may be determined in the power flow process (Kenechi, Daniel, Edet, diarah. 2014).

## 2. Materials and Methods

This work develops power flow model for distribution network using existing distribution load flow to determine the optimum placement of DG units for power loss reduction. In order to study the effects of the model developed, computer simulations were carried out taking the 33kV distribution network of EKO Electricity Distribution Company Plc (EKEDP) as a case study with a total DG penetration level of 36 MW decentralized DGs of 5 MW which are placed in each feeder with a base voltage of 13.8 kV, shunt capacitor of 200 kVar, base value of 40 and unity power factor. Power factor, active power, reactive power, apparent power and current measurements were taken before and after installation of DG in the network. These were used as input parameters for the development of the model. In the development of this model, distributed generation are considered as active power sources at a particular voltage, which is at unity power factor. The load flow result will identify weak buses (buses with voltage magnitude less than 1.0p.u) and these buses will be considered as the possible locations for placement of DG unit with a view of reducing power losses in the buses.

### Problem Formulation

The problem formulation for the optimal location of the distribution generation in the distribution network to minimize the power loss includes the load flow with and without distributed generation in the distribution network. Conventional load flow such as Gauss-Seidel and Newton-Raphson methods give unreliable solutions in distribution network due to radial structure of the network. Therefore distribution load flow of backward forward solution method of a balanced 3-phase system is used in this paper. The losses of real power, reactive power and voltage drop of each bus in the network are calculated and investigations are carried out on the power system as depicted in Figure 2.

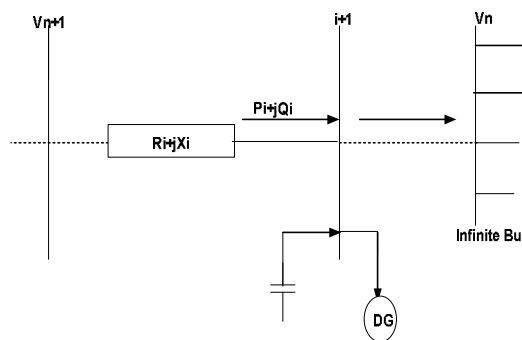


Figure 2: Simple distribution system main feeder with DG Source

From Figure 2, the load flow equations are:

$$S_{i+1} = V_n I_{i+1}^* = P_{i+1} + jQ_{i+1} \quad (3)$$

$$I_{i+1} = \left( \frac{S_{i+1}}{V_n} \right)^* = \frac{P_{i+1} - jQ_{i+1}}{V_n^*} \quad (4)$$

$$|I_{i+1}| = \frac{(P_{i+1}^2 + Q_{i+1}^2)^{\frac{1}{2}}}{|V_n|} \quad (5)$$

The e.m.f voltage of the system is given as:

$$V_{i+1} = V_n (\cos \delta_{i+1} + j \sin \delta_{i+1}) \quad (6)$$

The real and reactive power before DG installation is given as:

$$P_{i+1} = \left( \frac{V_n V_{i+1}}{X_{i+1}} \right) \sin(\theta_n - \delta_{i+1}) \quad (7)$$

$$Q_{i+1} = \left( \frac{V_n V_{i+1}}{X_{i+1}} \right) (V_n - V_{i+1}) \quad (8)$$

The active and reactive power after DG incorporation is given as:

$$P_{G(i+1)} = \sum_{i=1}^n |V_n| |V_{i+1}| |Y_{i+1}| \cos(\delta_n - \delta_{i+1} + \theta_{i+1}) - P_{i+1} + P_G \quad (9)$$

$$Q_{G(i+1)} = \sum_{i=1}^n |V_n| |V_{i+1}| |Y_{i+1}| \sin(\delta_n - \delta_{i+1} + \theta_{i+1}) - Q_G + Q_{CG} \quad (10)$$

Where,

$X_{i+1}$ : Reactance of  $(i + 1)^{th}$  branch  
 $S_{i+1}$ : Apparent power of bus  $i + 1$   
 $P_{i+1}, Q_{i+1}$ : Real and Reactive power flowing out of bus  $i + 1$   
 $|I_{i+1}|$ : Current magnitude at  $(i + 1)^{th}$  branch  
 N: Total number of branches with respect to x  
 $|V_{i+1}|$ : Voltage magnitude at  $(i + 1)^{th}$  bus  
 $P_{G(i+1)}, Q_{G(i+1)}$ : Real and Reactive power flow of distributed generation at bus  $i + 1$ .  
 $V_n, V_{n+1}$ : Voltage magnitudes at receiving and end bus.  
 N: total number of buses.  
 $\delta_n, \delta_{i+1}$ : Voltage angles of bus and k.  
 $Y_{i+1}$ : Magnitude of the  $(i + 1)^{th}$  element in bus admittance matrix.  
 $\theta_{i+1}$ : Angle of the  $(i + 1)^{th}$  element in bus admittance matrix.

### 3. Simulation

Distributed Generation were placed on the six (6) selected feeders of EKO Electricity Distribution Company Plc (EKEDP) comprising of Ademola, Alagbon, Alagbon Local, Anifowose, Banana Island and Flower and computer simulations were carried out using loads record before and after incorporation of the DG unit for power loss calculation. The input parameters for the model are shown in Tables 1 and 2.

**Table 1** Model input parameters for EKO electricity distribution company Plc (EKEDP) without distribution generation.

S/N	Name of Bus	Bus-Bar P(MW)	Loading Q(MVAR)	Susceptance ( $\Omega$ /km)	Current
1	Ademola	10.6	6.6	0.093	0.057
2	Alagbon	0	0	0.370	0.011
3	Alagbon Local	3.6	2.3	0.098	0.007
4	Anifowoshe	11.7	7.3	0.135	0.195
5	Banana Island	3	1.9	0.125	0.235
6	Flower	9.6	6.2	0.085	0.015

**Table 2** Model input parameters for EKO electricity distribution company Plc (EKEDP) with distribution generation.

S/N	Name of Bus	Bus-Bar P(MW)	Loading Q(MVAR)	Susceptance ( $\Omega$ /km)	Current
1	Ademola	15.6	9.2	0.093	0.057
2	Alagbon	5	2.6	0.370	0.011
3	Alagbon Local	8.6	4.9	0.098	0.007
4	Anifowoshe	16.7	9.9	0.135	0.195
5	Banana Island	8	4.5	0.125	0.235
6	Flower	14.6	8.8	0.085	0.015

The power loss of the system becomes:

$$P_{Loss}(i, i + 1) = R_{i+1} + \frac{(P_{G(i+1)}^2 + Q_{G(i+1)}^2)}{|V_{i+1}|^2} \quad (11)$$

$$P_{T, Loss} = \sum_{i=1}^N P_{Loss}(i, i + 1) \quad (12)$$

Where,

$P_{T, Loss}$ : Total real power loss of the system

$R_{i+1}, X_{i+1}$ : Resistance and Reactance of  $(i + 1)^{th}$  branch

Equation (12) is the developed Power flow model.

The developed model is tested using EKO Electricity Distribution Company PLC (EKEDP) with a total DG penetration level of 36 MW, decentralized DGs of 5 MW which were placed in each feeder with a base voltage of 13.8 KV, shunt capacitor of 200 Kvar, base value of 40 and a unity power factor.

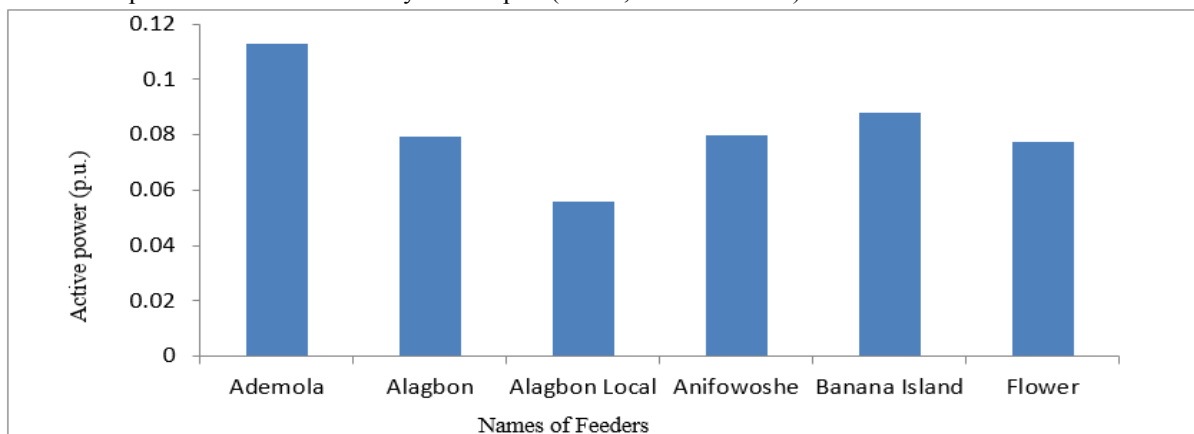
### 4. Discussion of Results

The computed simulation results are presented in Figures 3 to 10. Figure 3 shows how the active power varies with the feeder names without DG. The active power for Ademola, Alagbon, Alagbon Local, Anifowose, Banana Island and Flower feeders are 0.1131, 0.0792, 0.0560, 0.0799, 0.0879 and 0.0773p.u. respectively which indicates a reduction in the active power due to the active loadings of the feeder. Figure 4 illustrates the correspondence between the reactive power without DG and the feeder names. Ademola, Alagbon, Alagbon Local, Anifowose, Banana Island and Flower feeders recorded reactive power values of 0.0653, 0.0462, 0.0345, 0.0462, 0.0517 and

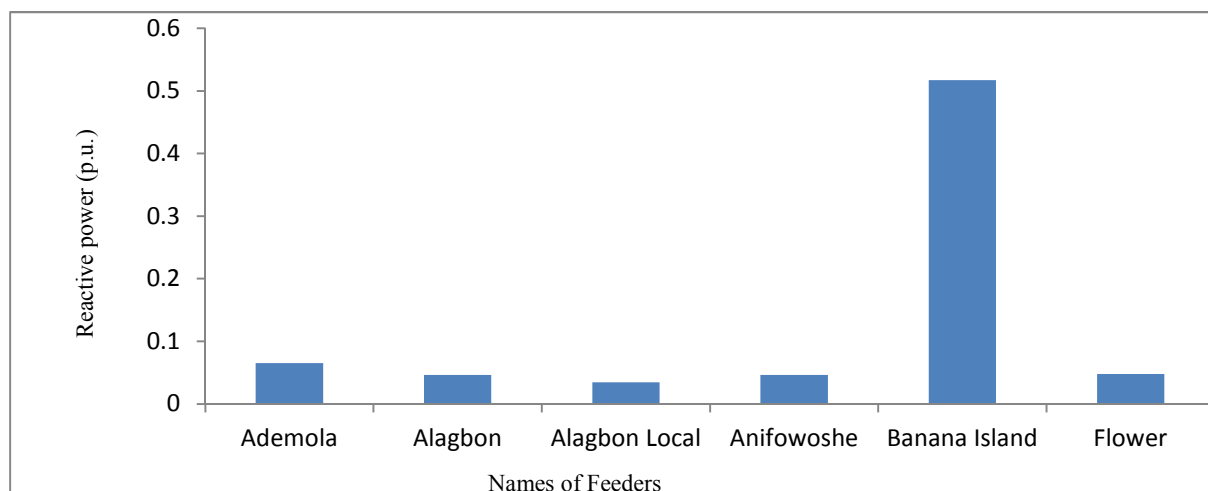
0.0478p.u. respectively which indicates a reduction in the reactive power. Figure 5 shows the variation of power loss without DG with feeder names. Ademola, Alagbon, Alagbon Local, Anifowose, Banana Island and Flower feeders recorded power loss values of 0.101, 0.1467, 0.14, 0.1412, 0.1410 and 0.1418p.u. respectively indicating an increase in the power losses. The variation of the active power with feeder names with introduction of DG is illustrated in Figure 6. Ademola, Alagbon, Alagbon Local, Anifowose, Banana Island and Flower feeders have active powers of 0.3217, 0.3015, 0.0799, 0.0879, 0.4103 and 0.3009 p.u. respectively which indicate an increased in active power when compared with active power of 0.1131, 0.0792, 0.0560, 0.0799, 0.0879 and 0.0773 p.u. respectively without DG. This due to the resistance and reactance at each feeder.

Figure 7 shows how the reactive power varies with the feeder names with incorporation of DG. The reactive power with introduction of DG for Ademola, Alagbon, Alagbon Local, Anifowose, Banana Island and Flower feeders are 0.1495, 0.1607, 0.1089, 0.1417, 0.1414 and 0.1425p.u. respectively which indicate an increase in reactive power when compared with the results of reactive power of 0.0653, 0.0462, 0.0345, 0.0462, 0.0517 and 0.0478 p.u. respectively without DG. This is due to the reactive load and reactance at each feeder. Figure 8 illustrates the correspondence between power loss and feeder names with incorporation of DG. The power loss with incorporation of DG for Ademola, Alagbon, Alagbon Local, Anifowose, Banana Island and Flower are 0.0687, 0.0489, 0.0376, 0.0489, 0.0508 and 0.0232p.u. respectively.

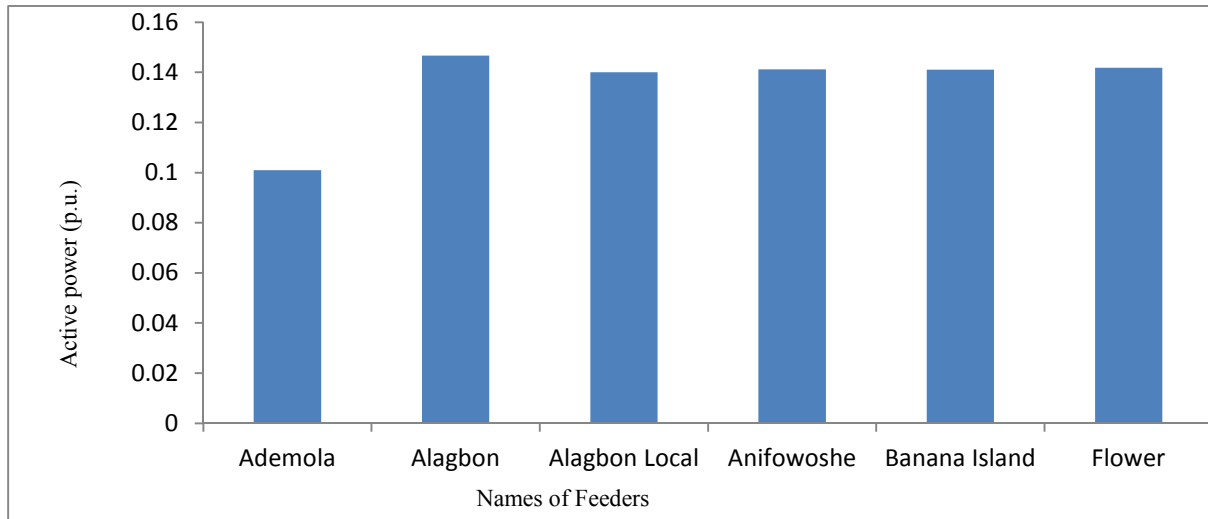
Figure 9 shows the relationship between the power loss without incorporation of DG and the power loss with DG incorporated. The power loss with incorporation of DG for Ademola, Alagbon, Alagbon Local, Anifowose, Banana Island and Flower are 0.0687, 0.0489, 0.0376, 0.0489, 0.0508 and 0.0232 p.u. respectively which correspond to power loss values of 0.101, 0.1467, 0.14, 0.1412, 0.1410 and 0.1418 p.u. respectively without the incorporation of DG. Lines 4, 5 and 6 have values of power loss of 0.0489, 0.0508 and 0.0232 with DG which correspond to power loss of 0.1468, 0.1601 and 0.1035 p.u. respectively without incorporation of DG. Figure 10 shows the relationship between the total power loss without and with incorporation of DG. The total power losses with incorporation of DG is 0.6165 p.u. compared to total power losses of 1.8117 p.u. without incorporation of DG. The power loss was reduced by 1.1952 p.u. (that is, 67% reduction).



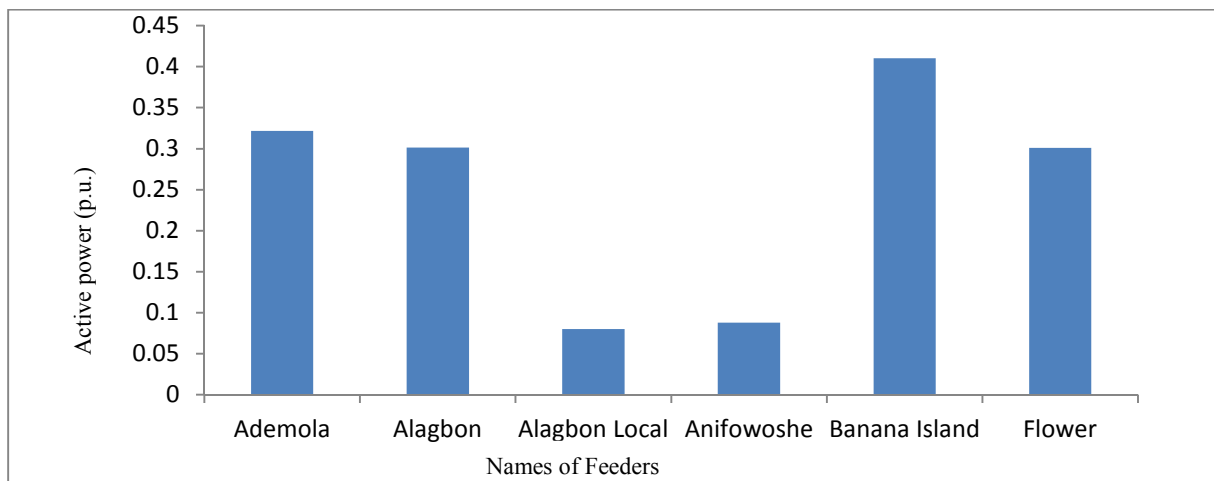
**Figure 3** Active power without DG versus feeders' names



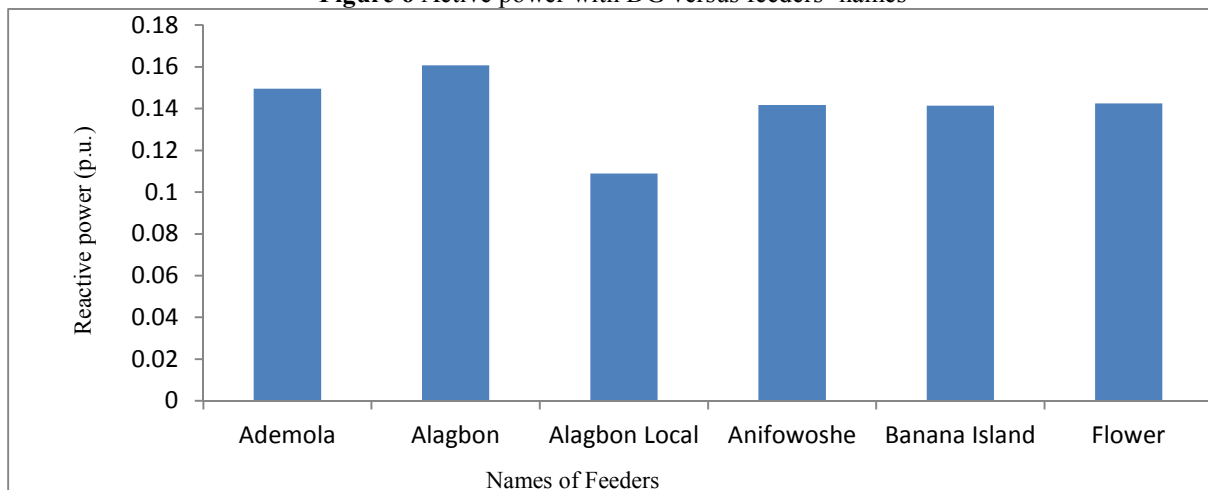
**Figure 4** Reactive power without DG versus feeders' names



**Figure 5** Power losses without DG versus feeders' names

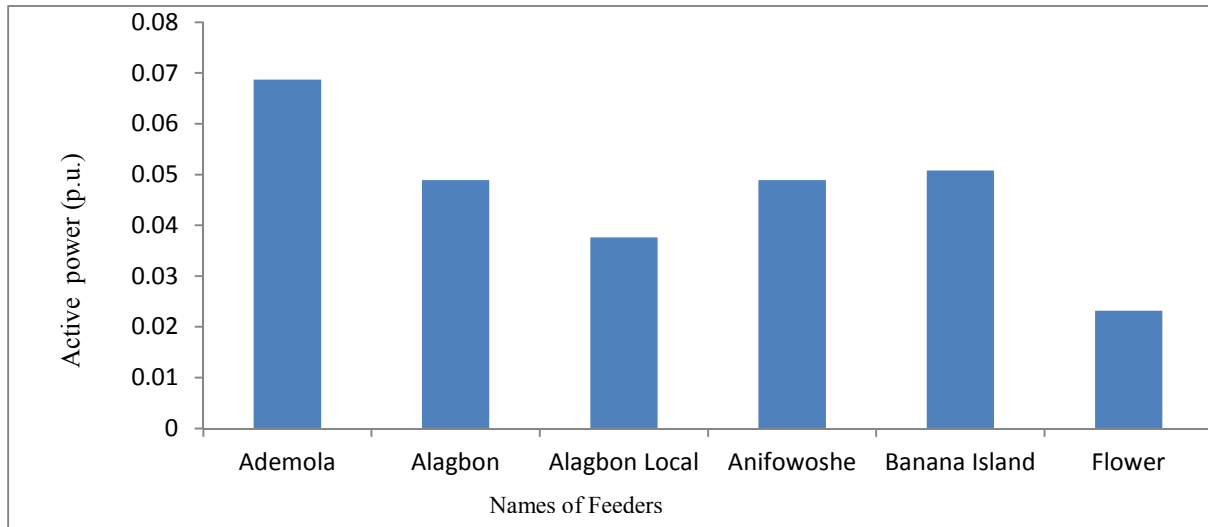


**Figure 6** Active power with DG versus feeders' names

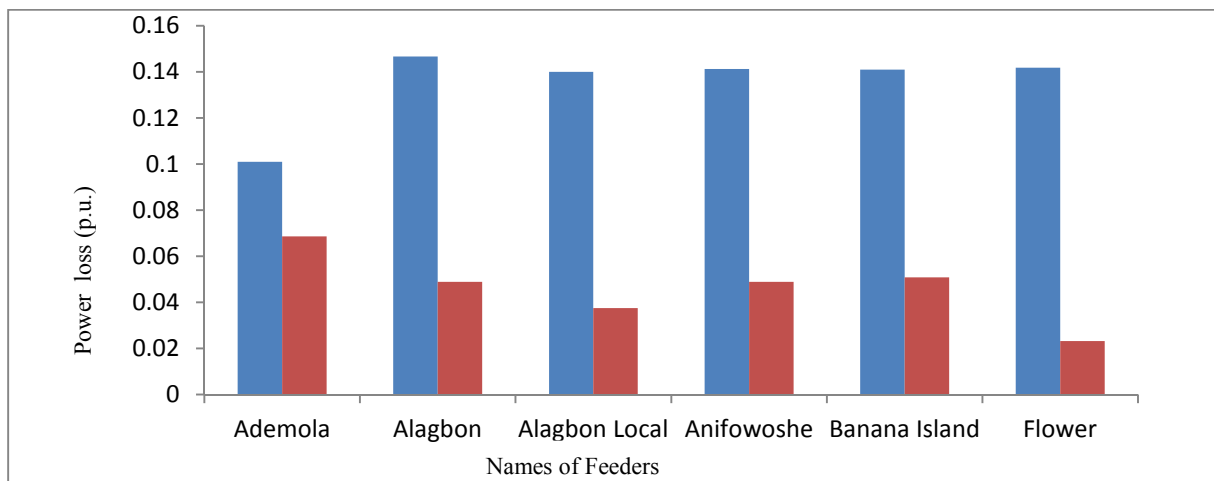


**Figure 7** Reactive power with DG versus feeders' names

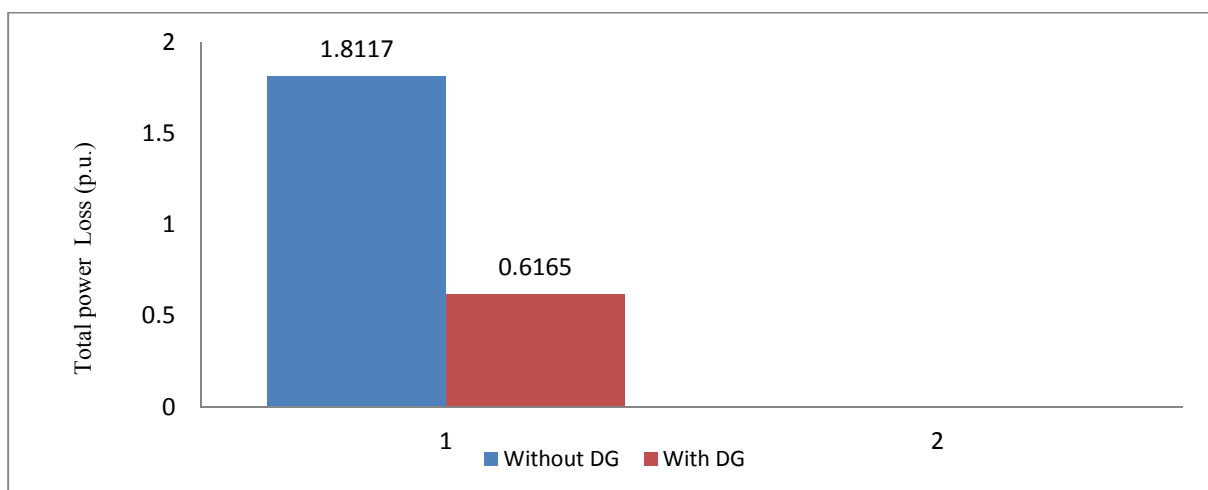




**Figure 8** Power loss with DG versus feeders' names



**Figure 9** Power losses without and with DG versus feeders' names



**Figure 10** Computer simulation of total power loss without and with DG

## 5. Conclusion

The results clarify the efficiency of the developed model for the reduction of power losses of the network and also for voltage stability margin and maximum loading. The result of the power flow before introduction of DG shows



that Alagbon, Alagbon Local, Anifowose, Banana Island and Flower feeders have highest power loss values of 0.101, 0.1467, 0.14, 0.1412, 0.1410 and 0.1418 p.u. respectively. These feeders were considered as the possible locations for placement of DG unit with a view of reducing power losses in the feeder. Therefore the results reveal that the system loss is significantly reduced by placing DG in Distribution network of EKO Electricity Distribution Company Plc (EKEDP). Active power losses have been reduced by 67%. The positive impacts of reducing system loss in distribution networks has been established.

### Conflicts of interest

The authors have no conflicts of interest to declare.

### References

- [1] Abbagana M, Bakare G.A, Mustapha I. Optimal placement and sizing of a distributed generator in a power distribution system using differential evolution. *International Journal of Research in Engineering, IT and Social Sciences*. 2012; 2(4):26-42.
- [2] Ajenikoko G.A and Olaomi A.A. A model for power losses reduction in low voltage distribution network of residential sectors. *The International Journal of Engineering and Science*. 2014; 3(10): 67-74.
- [3] Ajenikoko, G.A, Olaomi, A.A. Development of a Power Factor Model for Power System Loads. *The International Journal of Engineering and Science*. 2014; 3(10):61-66.
- [4] Ajenikoko G.A, Eboda A.W. Improvement of power quality in distribution system with incorporation of distributed generation using ladder load flow method. *International Journal of Scientific Engineering and Technology*. 2016; 5(9):444-451.
- [5] Adesina L. M, Ademola A. Determination of power system losses in Nigerian electricity distribution networks. *International Journal of Engineering and Technology*. 2016; 6(9):322-326.
- [6] Subramanian A, Jaisiva S, Wathana R.S, Neelan S. Optimal allocation of facts device for voltage profile enhancement. *International Journal of Enhanced Research in Science, Technology and Engineering*. 2015; 4(8):187-92.
- [7] Varilane P, Carpinelli G, Abur A. Capacitor placement in unbalanced power system. 14<sup>th</sup> PSCC, Sevilla. 2002; 3(2):1-6.
- [8] Venkata K.P, Rama R.S. Compensation of reactive power using D-STATCOM. *IOSR Journal of Electrical and Electronics Engineering*. 2014; 9(1):17-27.
- [9] Ambafi J.G, Nwohu M.N, Ohize H.O, Tola O.J. Performance evaluation of PSS and STATCOM on oscillation damping of a North-Central power network of Nigeria grid system. *International Journal of Engineering and Technology*. 2012; 2(2):209-219.
- [10] Mohammadi R.A, Adinehvand K, Azadbakht B. Voltage and power stability analysis of power system using GA-fuzzy based controller of svc during connection of doubly fed induction generator to network", *Indian Journal of Fundamental and Applied Life Sciences*. 2014; 4(3):236-242.
- [11] Kenechi V.A, Daniel O.A, Edet D.K, Diarah R.S. Analysis of load test, transformation, turns ratio, efficiency and voltage regulation of single phase transformer. *International Journal of Science, Environment and Technology*. 2014; 3(5):1657 – 1667.
- [12] Manju M, Leena G, Saxena N.S. Distribution network reconfiguration for power loss minimization using bacterial foraging optimization algorithm. *International Journal of Engineering and Manufacturing*. 2016; 2(3):18-32.
- [13] Indu D, Sharma A.K, Anil P. Optimal Location and Sizing of Distributed Generation (DG) To Minimize Power Loss Using Particle Swarm Optimization (PSO). *International Journal of Advanced Research in Electrical, Electronics and Instrumentation Engineering*. 2015; 4(4):2529-2537.
- [14] Emmanuel N.E, Theophilus C.M. A frame work for power loss minimization by an optimization technique. *International Journal of Engineering Trends and Technology (IJETT)*. 2016; 40(3):121-132.