

Optimization of Loaded Meshed Face Gears Design using Genetic Algorithm

Ram Gopal

Department of Production Engineering, G.B. Pant University of Agriculture and Technology
Pantnagar - 263145, U.S.Nagar (Uttarakhand)
E-mail: rgv39340@rediffmail.com

Dr. Ajay Agarwal

Department of Production Engineering, G.B. Pant University of Agriculture and Technology
Pantnagar - 263145, U.S.Nagar (Uttarakhand)

Rajiv Suman (Corresponding author)

Department of Mechanical Engineering, G.B. Pant University of Agriculture and Technology
Pantnagar - 263145, U.S.Nagar (Uttarakhand)
E-mail: raje.suman@gmail.com

Abstract

This paper presents the design strategy for optimization of loaded meshed face gear set. Genetic algorithms are being widely used for optimization, search and neural network synthesis. A lot of work has been conducted using genetic algorithm for different engineering problems related to scheduling and process planning in industrial engineering, network optimization in computer engineering. The work dissertation deals with the optimization of loaded meshed face gear sets using genetic algorithm. Attention is focused on reducing the pressure of gear set subjected to constraints on the maximum pressure, contact location, pressure at slice 1 and pressure at slice 11. The optimum gear set using Genetic Algorithm calculate the pressure.

Keywords: Genetic algorithm, loaded meshed face gear, optimization.

1. INTRODUCTION

Face gear is a pseudo bevel gear that is limited to 90° intersecting axes. The face gear is a circular disc with a ring of teeth cut in its face; hence the name face gear as shown in fig 1 and 2. Tooth elements are tapered towards its center. The mate (pinion) is an ordinary spur gear. The use of face gears and their ability to operate successfully at the speeds are required for an unknown environment as in aerospace.

Gunigand [4] optimized the crowing of pinion of face gear by the simple statistical. For steady Gunigand divided the teeth in to slices 1 to 11 and consider as pressure at slice 1 as pressure 1 similarly at slice 11 as pressure 11. Optimizing the crowing of pinion in loaded meshed with face gear provides benefits such as higher contact ratio, lower maximum load, and lower contact pressure. Gear design must satisfy constants including maximum pressure, contact location, pressure1, and pressure 11. Different approaches for improved gear design have been proposed in literatures. Among those the use of optimization techniques has received much attention. There are several techniques available for the solution of optimization problems, satisfying certain constraints, the aim is basically to minimize or maximize a design objective and satisfying the constraints. The constraints can be either inequalities or equalities. These techniques usually use the previous solution as a key to get the closer solution, but do not really incorporate the earlier solutions into the search for the new closer solution. Genetic algorithms for the optimization problem fulfill the above requirement. Genetic algorithms are search algorithms based on the mechanics of natural selection and natural genetics. The combine survival of the fittest among string structures with a structured yet randomized information exchange to form a search algorithm with some of the innovative flairs of human search.

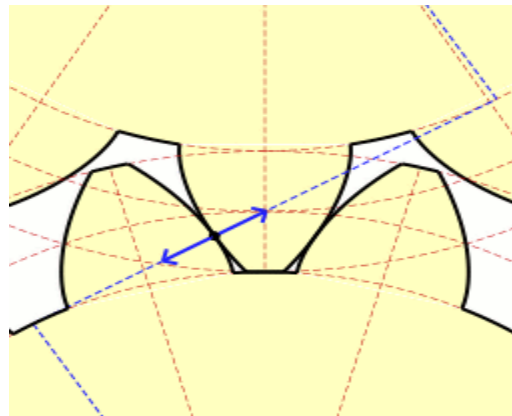

Fig. 1 Face meshed gear [8]

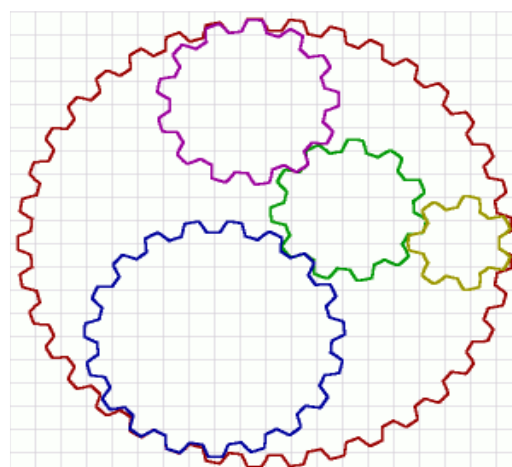

Fig.2 External and internal Face meshed gear [8]

2. OBJECTIVE FUNCTION

With the advancement in electronic computer the optimization theory also observed a significant growth (the mathematics of achieving the best) specifically in application of design problems. Optimization theory requires formulation of objective function that precisely measures cost or profit. And the expression of all side condition as mathematical equation or inequalities. The combination of design variables, giving the best possible value of the objective, which is consistent with constraints, is then sought by certain optimization procedures [7].

2.1 THE OBJECTIVES OF PRESENT WORK

Objective of the work is optimization of crowing parameters with the help of Genetic Algorithm, taking minimization of maximum pressure of meshing as objective function. The gears design must satisfy operational constraints including location, pressure at slice 1, pressure at slice 11. The required maximum pressure is to be optimized. The mathematical relation for the maximum pressure is given by Gunigand et al:

$$\text{Maximum Pressure} = 1042 - 9.27L_1 + 15.67L_2 - 1.73D_1$$

Table - 2.1: Crowing parameters and these ran

S. No.	Variables	Range
1	Length L1 (mm)	6-14
2	Length L2 (mm)	14-22
3	Depth D1(μmm)	10-30
4	Depth d2 (μmm)	10-30

3. DESIGN CONSTRAINTS

3.1 Maximum pressure

The maximum pressure should be equal to or less than the pressure without crowing. And pressure without crowing is 1210Mpa (1)

3.2 Contact location

The tooth is divided into slice 1 to 11. The location should be between slice 4 to 6. The mathematical relation for the location is given by Gunigand et al [4]

$$\text{Contact location} = -1.25 + 0.25L_1 + 0.125L_2$$

3.3 Pressure at slice 1

When meshing start first of all come in the contact with slice one so the contact pressure at slice 1 is known as the pressure at slice 1. And that should be less than the half of maximum pressure without crowing. The mathematical relation for the pressure at slice 1 is given by Gunigand et al [4]:

$$\text{Pressure1} = 1448 + 57.49 L_1 - 65.82 L_2 - 2.6 L_1 L_2$$

3.4 Pressure 11

The pressure at slice 11 is the contact pressure at the tooth bottom. And that should be also less than the half of maximum pressure without crowing. The mathematical relation of the pressure 11 is given by Gunigand et al [4]:

$$\text{Pressure 11} = 173.72 + 23.67 L_2 - 5.79 D_2 - 0.72 L_2 D_2$$

4. GENETIC ALGORITHMS

Genetic Algorithms have been developed by John Holland, his colleagues, and his students at the University of Michigan. The goals of their research have been twofold. (1) To abstract and rigorously explain the adaptive processes of natural systems, and (2) To design artificial systems software that retains the important mechanisms of natural systems. This approach has led to important discoveries in both natural & artificial systems science. Idea of evolutionary computing was first introduced by Rechenberg in 1960 in his work evolutionary strategies. Prof. Holland of University of Michigan, Ann Arbor envisaged the concept in the mid-sixties and published his seminal work (Holland 1975). There after a number of students and others researchers have contributed to the development of this field. This approach has led to important discoveries in both natural and artificial systems science [6].

The basic purpose of genetic algorithms (GAs) is optimization. Since optimization problems arise frequently, this makes GAs quite useful for a great variety of tasks. As in all optimization problems, we are faced with the problem of maximizing or minimizing an objective function $f(x)$ over a given space X of arbitrary dimension. A brute force which would consist in examining every possible x in X in order to determine the element for which f is optimal is clearly infeasible. GAs give a heuristic way of searching the input space for optimal that approximates brute force without enumerating all the elements and therefore bypasses performance issues specific to exhaustive search [5]. Genetic algorithms are search algorithms based on the mechanics of natural selection and natural genetics, including the Darwin's principle of survival of fittest. The Darwin Project has been designed to assist genetic algorithms programmers by providing a facility to generate most of the code and thus giving a chance to concentrate only on genome representation, operators and GA parameters. Darwin is thus capable of properly identifying genome representation, generating most of the operators accordingly and providing all the necessary statistics and bookkeeping functionality. In its most general, the Darwin Project is a language and its compiler.

The Darwin language is designed to clearly distinguish genetic algorithm constructs - the genome and its operator set. A detailed presentation of the Darwin language will be presented in the next section. The Darwin language compiler has been designed to be a C cross-compiler. The target language is chosen to be C, since C is the most commonly used language with compilers present on the widest range of platforms. By generating standard C code, portability is ensured on the largest scale possible [9].

4.1 Basics of Genetic Algorithms

The most common type of genetic algorithm works like this: a population is created with a group of individuals created randomly. The individuals in the population are then evaluated. The evaluation function is provided by the programmer and gives the individuals a score based on how well they perform at the given task. Two individuals are then selected based on their fitness, the higher the fitness, the higher and the chance of being selected.

These individuals then "reproduce" to create one or more offspring, after which the offspring are mutated randomly. This continues until a suitable solution has been found or a certain number of generations have passed, depending on the needs of the programmer.

4.2 GAs can serve different purpose as follows

1. GAs as constraint and unconstraint problem solvers
2. GAs as challenging technical puzzle
3. GAs as basis for competent machine learning
4. GAs as computational model of innovation and creativity

5. GAs as computational model of other innovating systems

The working principle of a simple genetic algorithm [10]

```

/*Algorithm GA */
formulate initial population
randomly initialize population
repeat
    evaluate objective function
    find fitness function
    apply genetic operators
        reproduction
        crossover
        mutation
until stopping criteria.
    
```

4.3 The basic GA operations

One generation is broken down into a selection phase and recombination phase. Strings are assigned into adjacent slots during selection.

Strings are assigned into adjacent slots during selection.

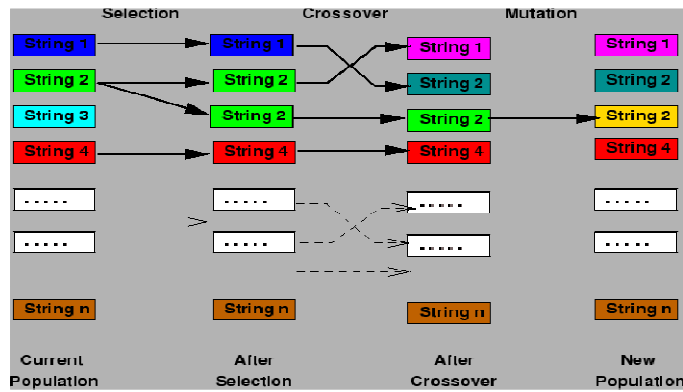

Fig.4.1 The basics of GA operations and procedure [10]

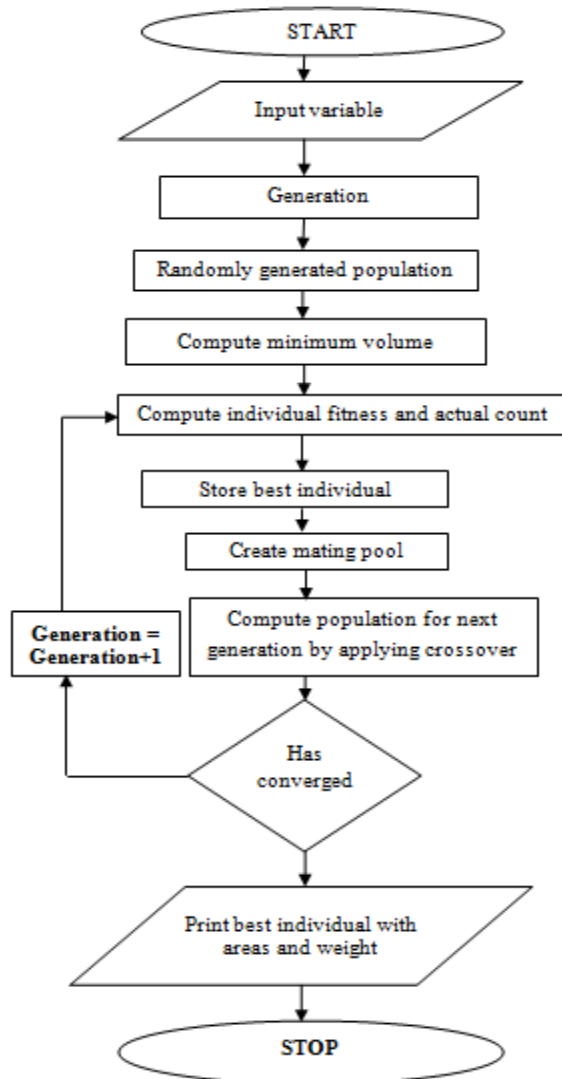

Fig. 4.2 Flow chart for the genetic algorithm to solve [1]

6.RESULTS AND DISCUSSION

Based on genetic algorithm presented in previous article, a complete program in C language has been written for optimization of maximum pressure of face gear set, problem as discussed in previous. The problem of face gear set was also by Gunigand et al. in this chapter results obtained by GA are discussed and compared with the results of Gunigand et al. in tabular as well as in graphical form.

In meshing two type of contact are developed, one is points contact other one is line contact. In this study optimum crowing parameters of the pinion are determined satisfying the constraints such as maximum pressure, contact location, pressure at slice 1 and pressure at slice 11. These optimum parameters are used to determine the optimum pressure value under the loaded meshed condition.

In the program, input design parameters L_1 , L_2 , D_1 and D_2 are taken as shown table 1 and the design constraints are taken as previous article. GA program gives the values of parameters for highest fitness value after every, hundred iteration.

Table - 5.1: The optimization results of GA and Gunigand's of pinion crowing parameter for face gear.

S. No.	Variables	Gunigand	Gas
1	Length L_1 (mm)	13.00	13.35
2	Length L_2 (mm)	16.00	16.00
3	Depth D_1 (μ mm)	15.00	29.00
4	Depth D_2 (μ mm)	11.00	16.00

The table 5.1 shows results of Gunigand and Ga. The Gas result is better than the results obtained by Gunigand,

because crowing parameters obtained by GA gives compact gear.
 Below table 5.2 compares the values of contact location, maximum pressure at slice 1 and pressure at slice 11 obtained by different techniques.

Table - 5.2: Comparison of GA, Gunigand and without crowing results

S. No.	Parameters	GA	Gunigand's	Without crowing
1	Contact location	4	4	1
2	Maximum pressure (Mpa)	1118.78	1146.26	1210
3	Pressure 1 (Mpa)	604.88	599.70	1210
4	Pressure 11 (Mpa)	257.56	349.71	696

The minimum maximum pressure of 1118.78 Mpa is obtained by GA when $L_1 = 13.35$, $L_2 = 16.00$ mm and $D_1 = 29$ μ m and $D_2 = 16$ μ m.

Gunigand's relations for contact location and maximum pressure are used to determine contact location and maximum pressure by GA for the optimum parameters obtained by GA. The genetic algorithm technique which uses the continuous, discrete and binary coded variable is applied to the face gear design optimization problem. GA is used in the study for the analysis and not to investigate their characteristics (robustness, convergence etc.) the population size is chosen to be 100 which help to quickly converge to the optimal solution. The results of optimization are shown in table 4. **The minimum maximum pressure of 1118.78 Mpa is obtained when $L_1 = 13.35$, $L_2 = 16.00$, and $D_1 = 29$ μ m and $D_2 = 16$ μ m. Which are better optimized design results as compared to that obtained by earlier techniques.**

For the optimum parameters obtained by GA contact location, pressure 1, and pressure 11 are respectively 4, 604.88 Mpa, and 257.58 Mpa which are with in the given limit. So our constraints are satisfied.

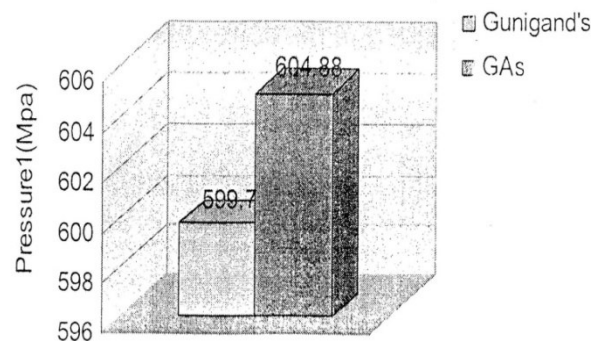

Fig. 5 (a) Comparison of pressure 1 between Gunigand and GA

In Fig. 5 (a) series 1 shows the results of Gunigand and series 2 shows the results of GA. In comparison at slice 1 pressure obtained by GA is 604.88 Mpa which is greater than the pressure obtain by Gunigand by 5.187 Mpa, which is very less, can be said that they are approximately equal. In both case GA and Gunigand pressure 1 follow the constraint i.e. pressure 1 should be less then half of maximum pressure without crowing.

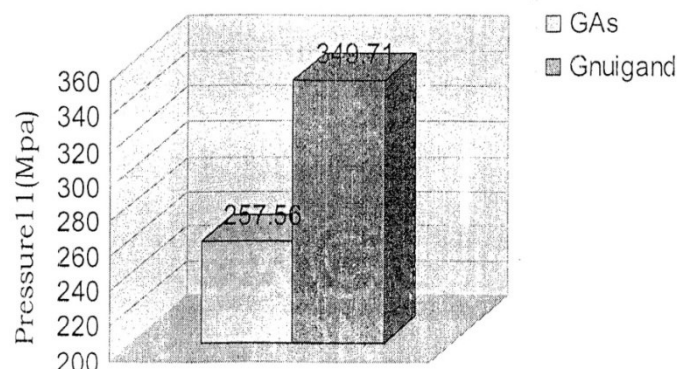

Fig. 5 (b) Comparison of pressure 11 between Gunigand and GA

In Fig. 5 (b) series one shows the results of GA and series 2 shows the results of Gunigand. In comparison at slice 11 pressure obtain by GA 257.85 Mpa is less than the pressure obtain by Gunigand 349.71 Mpa. In both case GA and Gunigand pressure 11 follow the constraint i.e. pressure 11 should be less then half of maximum pressure without crowing. Conclusively pressure at slice 11 is reduced by 91.13 Mpa.

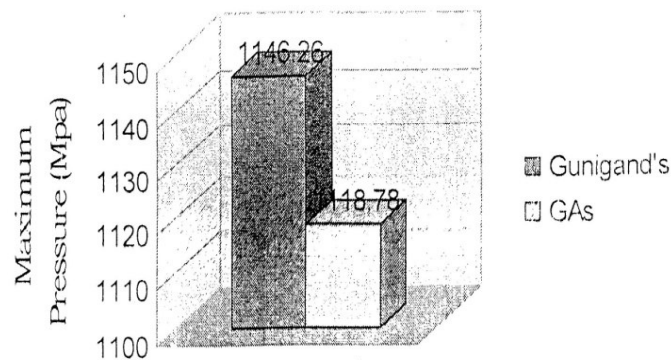

Fig. 5 (c) Comparison of maximum pressure between Gunigand and GA

In Fig. 5 (c) series 2 shows the results of GA and series 1 shows the results of Gunigand. In comparison maximum pressure obtain by GA 1118.78 Mpa is less than the pressure obtain by Gunigand 1146.26 Mpa. Our objective was to minimize the maximum pressure and we have achieved this successfully by using Genetic Algorithm. The advantage of the minimum maximum pressure is lower maximal load, lower contact pressure and higher contact ratio. This is advantageous because we can transfer more load from the same size of gear.

5. CONCLUSIONS

In the face gear design optimization problem maximum pressure of face gear in loaded meshed condition is prime consideration; it depends largely upon pinion crowing parameters for loaded meshed face gear.

In the genetic algorithm problem following parameters are used population size is 100, single point crossover is used with a probability of mutation is 0.016 and stopping criteria is given as 100 number of generation. On running program for crowing parameters following conclusion can be drawn.

1. By using GA the pinion crowing parameters is obtained as $L1 = 13.35$ mm, $L2 = 16$ mm, $D1 = 29$ μ mm and $D2 = 16$ μ mm. Previous researcher Gunigand's [4] optimum crowing parameters where $L1 = 13$ mm, $L2 = 16$ mm, $D1 = 15$ μ mm and $D2 = 11$ μ mm this shows pinion crowing parameters obtained by GA are reduced. This means the size of pinion has reduced, in other words compact and economical gear has been designed.
2. Previous researcher Gunigand [4] studied the sample gear set he found optimum maximum pressure 1146.26 Mpa, and without crowing maximum pressure was 1210 Mpa. The optimum gear set using GA has maximum pressure of 1118.78. in other words, pinion whose crowing parameters are designed by GA can transfer more load as compared to pinion whose crowing parameters are designed by Gunigand.
3. For the optimized crowing parameters by GA maximum pressure is minimized, and all the constraints are satisfied. The GA results show that contact location is 4, pressure at slice 1 is 604.88 Mpa and pressure at slice 11 is 257.56 Mpa i.e. contact location, pressure at slice 1, and pressure at slice 11 are with in the specified limits.
4. Compared to Gunigand's result (table 3) contact location is same i.e. 4, pressure at slice 1 has increased from 599.7 Mpa to 604.88 Mpa and there is a decrease in pressure at slice 11 from 349.71 Mpa to 257.56 Mpa, but still all these values are with in given specified limits.
5. Simple Genetic Algorithm quickly converges to the global optimal solution.

7.SCOPE OF FUTURE WORK

The study of the problem addressed in this work can be further extended in the following directions.

1. In the present work optimization of pinion crowing parameters is done, face gear parameters can also be optimized.
2. Misalignment's sensitivity can be determined
3. By modifying GA's operators i.e. reproduction and crossover advanced Genetic Algorithm can be developed with the intention of getting better optimization.

LITERATURE CITED

- [1] Derail, T., and Filize, I.H., 1999, " Optimization of Process Planning by Genetic Algorithm" www.elsevier.com.
- [2] Rattan S.S., 1989, "Theory of machines," 5th Ed., McGraw-Hill.
- [3] Trabia, B.M., 2004, "A hybrid Fuzzy Simplex Genetic Algorithm." *J. Mech. Trans. ASME*, 126(6), pp. 969-974.

- [4] Gunigand, M., Vaujany, J. P. De, and Icard, Y., 2005, “Analysis and optimization of the Loaded Meshed of Face Gears,” *J. Mech. Des., Trans. ASME*, 127(2), pp. 135-143.
- [5] Ackley, D.H. (1985).A connectionist Algorithm for Genetic search. Proceeding of an International Conference on Gas, 121 Hill T, Lundgren A, Fredriksson R, Schiöth “Genetic algorithm for Large-scale maximum parsimony phylogenetic analysis of proteins”. *Biochimica et Biophysical Acta* 1725 (1): 19–29.
- [6] Mitchell, and Melanie, (1996), *An Introduction to Genetic Algorithms*. MIT Press.
- [7] Shigley, J.E. & Mitchell, L.D. (1983), “*Mechanical Engineering Design*,”4th Ed.McGraw- Hill, New York, pp.632-646.
- [8] Savage, M. Copy, J.J.and Townsend, D.P. (1982), Optimal Tooth Numbers for Compact Standard Spur Gear Sets *ASME J.Mech.Des.*, 104:749-75.
- [9] Caruso, A., and Gorla, C., “FACET' - Face gears in aerospace transmissions,” *Proceedings of the 25th European RotorcraftForum*, vol. 2, Rome, Italy, Sep. 14–16, 1999.
- [10] Faydor L. Litvin. *Integrated Computer Program for Simulation of Meshing and Contact of Gear Drives*[J]. *Computer Methods in Applied Mechanics and Engineering*,2000,181(1-3):71-85.

The IISTE is a pioneer in the Open-Access hosting service and academic event management. The aim of the firm is Accelerating Global Knowledge Sharing.

More information about the firm can be found on the homepage:

<http://www.iiste.org>

CALL FOR JOURNAL PAPERS

There are more than 30 peer-reviewed academic journals hosted under the hosting platform.

Prospective authors of journals can find the submission instruction on the following page: <http://www.iiste.org/journals/> All the journals articles are available online to the readers all over the world without financial, legal, or technical barriers other than those inseparable from gaining access to the internet itself. Paper version of the journals is also available upon request of readers and authors.

MORE RESOURCES

Book publication information: <http://www.iiste.org/book/>

Academic conference: <http://www.iiste.org/conference/upcoming-conferences-call-for-paper/>

IISTE Knowledge Sharing Partners

EBSCO, Index Copernicus, Ulrich's Periodicals Directory, JournalTOCS, PKP Open Archives Harvester, Bielefeld Academic Search Engine, Elektronische Zeitschriftenbibliothek EZB, Open J-Gate, OCLC WorldCat, Universe Digital Library, NewJour, Google Scholar

