

Journal of Energy Technologies and Policy
ISSN 2224-3232 (Paper) ISSN 2225-0573 (Online)
Vol.1, No.2, 2011

www.iiste.org



Fuzzy Intelligent Controller for the Maximum Power Point Tracking of a Photovoltaic Module at Varying Atmospheric Conditions

Aurobinda Panda^{*}, M.K.Pathak, S.P.Srivastava

Department Of Electrical Engineering, IIT Roorkee, PO box 247667, Roorkee, India

^{*} E-mail of the corresponding author: aurobind.panda@gmail.com

Abstract

This paper presents the modeling of a photovoltaic (PV) module at varying atmospheric conditions such as irradiation and temperature. It also includes the maximum power point tracking (MPPT) of the PV module using conventional perturb and observe (P&O) method and fuzzy logic controller. For the performance analysis, the simulation of the PV module along with MPPT controller is done by using MATLAB/Simulink software. The voltage, current and power transitions at varying irradiation and temperature conditions is observed using conventional P&O and fuzzy logic based MPPT controllers. Finally the percentage improvement in power tracking time by fuzzy logic controller against the P&O controller has been evaluated

Keywords: Photovoltaic Module, MPPT, P&O method, Fuzzy logic Controller, Irradiation

1. Introduction

The recent change in the environmental conditions such as global warming and the rapid increase in the demand for electricity led to a need for a new source of energy that is cheaper and sustainable with less carbon emissions. Solar energy has offered promising results in the quest of finding the solution to the problem. If used in a proper way then it has the capacity to fulfil numerous energy needs of the world. That is why researchers are more inclined towards this area. A photovoltaic system converts sunlight into electricity by photovoltaic effect. Photovoltaic (PV) electrical energy generation provides several advantages with respect to other energy sources like it uses the inexhaustible world-wide available sunlight as a source of energy, it does not generate environmental pollutants and also the PV panels used requires minimum maintenance. However, the major challenges in such type of system includes the high cost of PV panel and also the solar energy is a dilute source of energy and its availability varies widely with time and with different atmospheric condition. So, it is very necessary to make a complete utilization of solar energy in such available conditions and for this maximum power point tracking controller is essential for the PV system to extract maximum power at given atmospheric condition.

A MPPT is used for extracting the maximum power from the solar PV module and transferring that power to the load [1, 4]. A dc/dc converter (step up/ step down) serves the purpose of transferring maximum power from the solar PV module to the load. A dc/dc converter acts as an interface between the load and the PV module as shown in Figure 2. By changing the duty cycle the load impedance as seen by the source is varied and matched at the point of the peak power with the source so as to transfer the maximum power [5]. Therefore MPPT techniques are needed to maintain the PV array's operating at its MPP [6]. Many MPPT techniques have been proposed in the literature such as Perturb and Observe (P&O) methods [4, 6-9], Incremental Conductance (IC) methods [1, 4, and 10], etc.

The main aim of this paper is to present the mathematical modelling and simulation of PV module and also to assemble an efficient MPPT controller with the PV module to extract maximum power from it. Here basically conventional MPPT algorithm is compared with a fuzzy intelligent controller based on simulation results.

2. Modeling of PV Module

The solar cell is the basic unit of a photovoltaic module and it is the element in charge of transforming the sun rays or photons directly into electric power. The solar cell used is the PN junction, whose electrical characteristics differ very little from a diode.

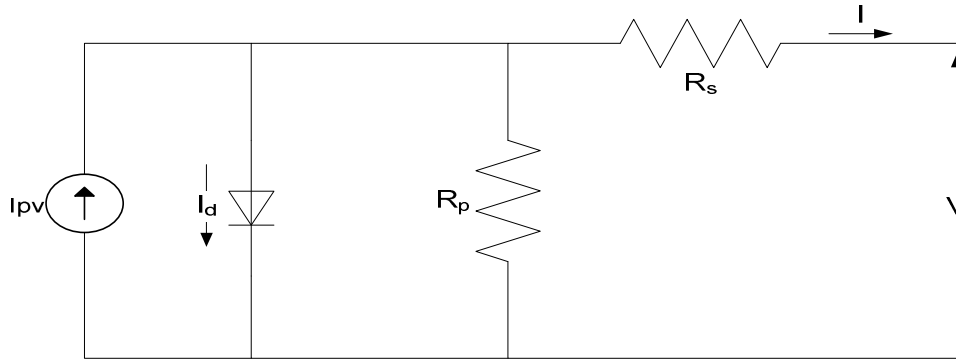

Figure 1. Equivalent circuit of a PV Cell

The equivalent circuit of a practical PV cell is shown in fig.1. The characteristic equation of a PV cell is the output current produced by it and is expressed as [3]-[4],

$$I = I_{PV} - I_0 \left[e^{\left(\frac{V + R_S I}{V_T a} \right)} - 1 \right] - \frac{V + R_S I}{R_P} \quad (1)$$

Where I_{PV} = Current generated by the incident solar radiation

I_0 = Reverse saturation or leakage current of the diode

V_T = Thermal voltage of PV module with N_s PV cell connected in series

$$= N_s K T / Q$$

K = Boltzmann constant = $1.3806503 \times 10^{-23}$ J/K

Q = Electron Charge = $1.60217646 \times 10^{-19}$ C

T = Temperature in Kelvin

a = Diode ideality constant ($1 < a < 1.5$)

PV cells connected in parallel increases the total output current of the PV module whereas cells connected in series increases the total output voltage of the module.

For simulation purpose all information can be found on the manufacturer PV module datasheet like, open circuit voltage, short circuit current, the voltage at the MPP, the current at the MPP, the open circuit voltage/temperature coefficient (K_V), the short circuit current/temperature coefficient (K_I), and the maximum experimental peak output power ($P_{max, e}$). These information are always given at standard test condition i.e. at 1000 W/m^2 irradiation and 25°C temperature. The other information like the light generated current, diode saturation current, diode ideality constant, series and parallel resistance which are not mentioned in manufacturer datasheet but required for the simulation purpose can be evaluated as follows[5].

The current generated by the incident solar radiation is depends linearly on the solar irradiation and is also influenced by the temperature according to the following equation [3], [11].

$$I_{PV} = (I_{PV,n} + K_1 \Delta T) \frac{G}{G_n} \quad (2)$$

Where,

$I_{PV,n}$ is the light generated current at the nominal condition i.e. at 25°C and 1000W/m²

ΔT = Actual temperature - Nominal temperature in Kelvin

G = Irradiation on the device surface

G_n = Irradiation at nominal irradiation

The diode saturation current I_0 and its dependence on the temperature may be expressed as [11],

$$I_0 = I_{0,n} \left(\frac{T_n}{T} \right)^3 \exp \left[\frac{qE_g}{aK} \left(\frac{1}{T_n} - \frac{1}{T} \right) \right] \quad (3)$$

Where E_g is the band gap energy of the semiconductor and $I_{0,n}$ is the nominal saturation current and is expressed as [3], [11],

$$I_{0,n} = \frac{I_{sc,n}}{\exp \left(\frac{V_{oc,n}}{aV_{t,n}} \right) - 1} \quad (4)$$

Where $V_{oc,n}$ = Nominal open circuit voltage of the PV module

Finally the series and parallel resistance of the PV cell can be calculated by any iteration method. Here Newton-Raphson method has been used for solving the characteristics equation (Equation 1) to find R_s and R_p values [5]. R_s basically depends on the contact resistance of the metal base, the resistance of the p and n bodies, and the contact resistance of the n layer with the top metal grid. The R_p resistance exists mainly due to the leakage current of the p-n junction [3]. The value of R_p is generally too high whereas the value of R_s is very low.

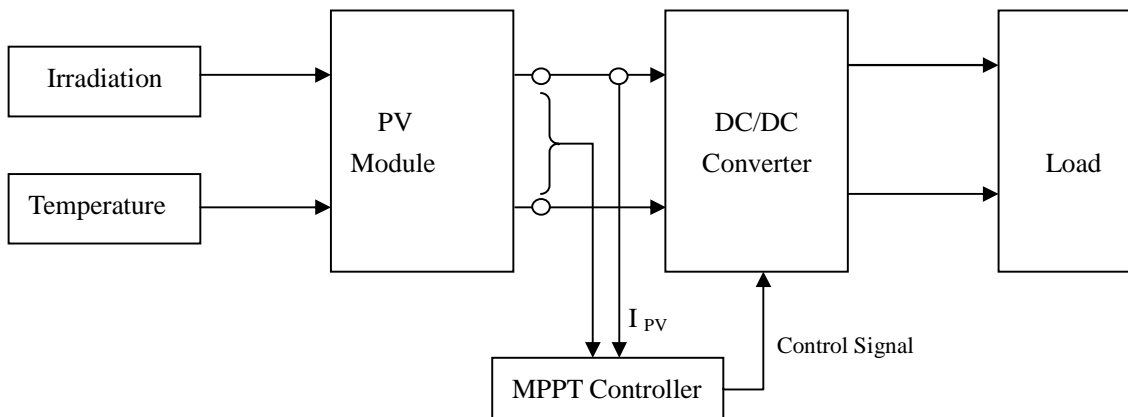

Figure 2. Complete block diagram of PV Module with MPPT Controller

Figure 2. shows the complete block diagram of a PV module with a MPPT controller and feed power to the load through a dc/dc converter. Here MPPT controller takes the output voltage and current of the PV module as its input and based on the control algorithm it gives appropriate command to the converter to interface the load with the PV module.

3. Maximum Power Point Tracking

Maximum Power Point tracking controller is basically used to operates the Photovoltaic modules in a

manner that allows the load connected with the PV module to extract the maximum power which the PV module capable to produce at a given atmospheric conditions. PV cells have a single operating point where the values of the current and voltage of the cell result in a maximum power output. With the varying atmospheric condition and because of the rotation of the earth [4], the irradiation and temperature keeps on changing throughout the day. So it is a big challenge to operate a PV module consistently on the maximum power point and for which many MPPT algorithms have been developed [1]. The most popular among the available MPPT techniques is Perturb and Observe (P&O) method. This method is having its own merits and demerits. The aim of the present work is to develop the simulink model of P&O MPPT controller and then the fuzzy intelligent control has introduced on it to improve its overall performance.

3.1 Perturb & Observe technique for Maximum power point tracking

Currently the most popular MPPT algorithm is perturb and observe (P&O), where the current/voltage is repeatedly perturbed by a fixed amount in a given direction, and the direction is changed only if the algorithm [2] detects a drop in power between steps [1]. For the present work the algorithm used has been present in figure 3. Here if there is an increase in power, the subsequent perturbation should be kept in the same direction to reach the MPP and if there is a decrease in power then the perturbation should be reversed.

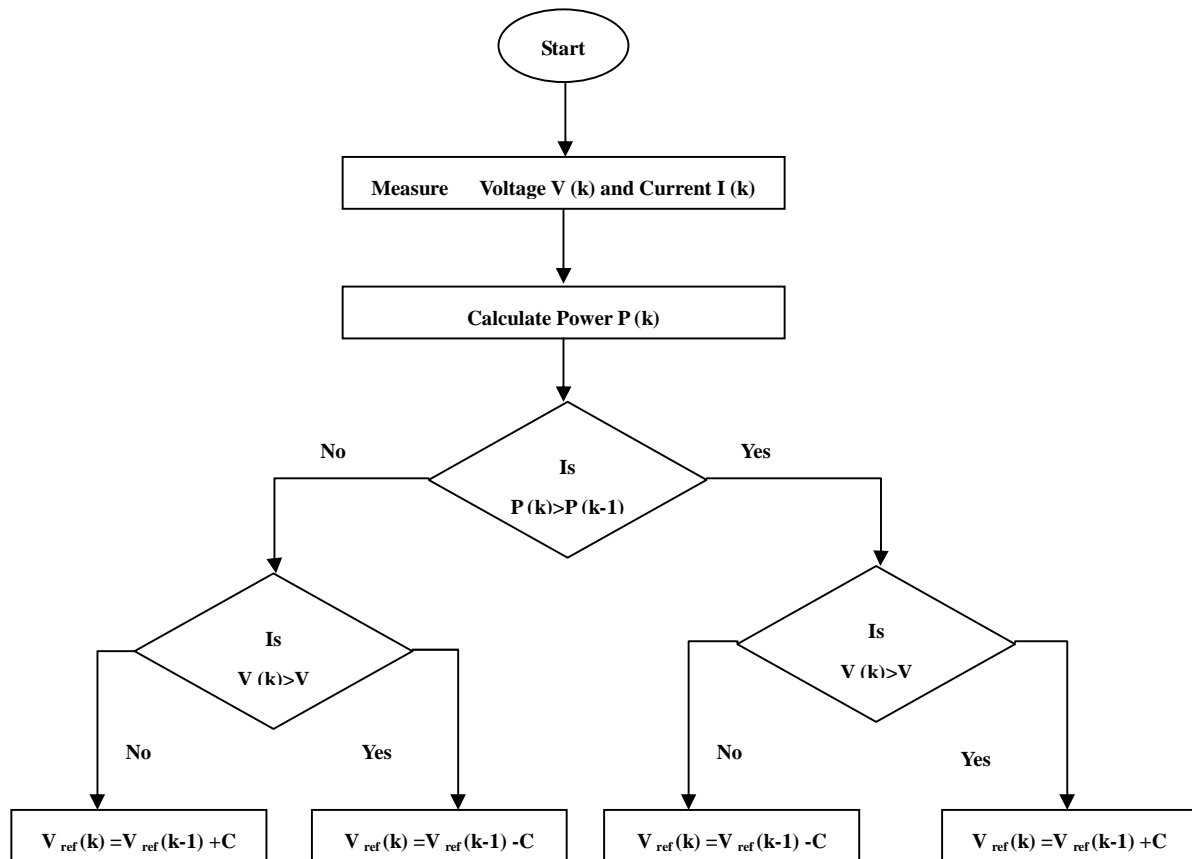

Figure 3. Algorithm for Maximum Power Point tracking by Perturb and Observe method

In the proposed work each perturbation of the controller gives a reference voltage which is compared with the instantaneous PV module output voltage and the error is fed to a PI controller which in turns decides the duty cycle of the DC/DC converter as shown in Figure 2. The process of perturbation is repeated

periodically until the MPP is reached. The system is then oscillates about the maximum power point. So the perturbation step size has to be chosen accordingly in order to minimize the oscillation around the MPP and also it shouldn't reduce the convergence speed much. Although this algorithm benefits from simplicity, it lacks the speed and adaptability necessary for tracking fast transients in weather variations.

3.2 Fuzzy logic Controller for Maximum Power Point Tracking

Fuzzy logic control generally consists of three stages: fuzzification, rule base and defuzzification. During fuzzification, numerical input variables are converted into linguistic variable based on a membership function. For this MPPT, the inputs to fuzzy logic controller are taken as a change in power w.r.t change in current E and change in voltage error CE. Once E and CE are calculated and converted to the linguistic variables, the fuzzy logic controller output, which is duty ratio D of the power converter, can be looked up in a rule base table. The linguistic variables assigned to D for the different combinations of E and CE is based on the knowledge of the user. Here the rule base is prepared based on P&O algorithm. In the defuzzification stage, the fuzzy logic controller output is converted from a linguistic variable to a numerical variable still using a membership function. MPPT fuzzy logic controllers have been shown to perform well under varying atmospheric conditions. However, their effectiveness depends a lot on the knowledge of the user or control engineer in choosing the right error computation and coming up with the rule base table. The equations for error E and change in error CE are given as follows:

$$E = \frac{P(k) - P(k-1)}{I(k) - I(k-1)} \quad (5)$$

$$CE = V(k) - V(k-1) \quad (6)$$

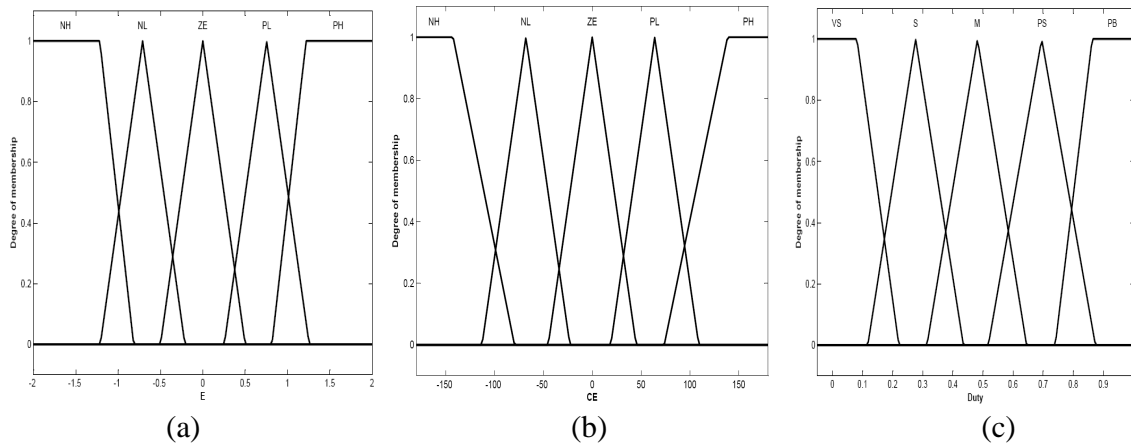

Figure 4. Membership functions for inputs (E, CE) and output (D) in Fuzzy logic controller based MPPT

Table 1: Rules for the proposed FLC

| | | | | | |
|--------|----|----|----|----|----|
| E \ CE | NH | NL | ZE | PL | PH |
| NH | PS | PB | PB | PS | M |
| NL | S | PS | PB | PB | PB |
| ZE | PB | M | M | M | S |
| PL | VS | S | S | PB | PB |
| PH | VS | VS | PB | PB | PB |

Table 2: Specification of PV module used in the simulation at standard test condition i.e. 25⁰C and 1000Watt/m²

| | |
|------------------------------------|------------------------------|
| Open Circuit Voltage (V_{oc}) | 32.9 Volt |
| Short Circuit Current (I_{sc}) | 8.21 Amp |
| Voltage at MPP(V_{mpp}) | 26.3 Volt |
| Current at MPP(I_{mpp}) | 7.6 Amp |
| Maximum Power(P_{mpp}) | 200.143 Watt |
| Voltage/Temp Coefficient(K_V) | -0.1230 Volt/ ⁰ C |
| Current/Temp Coefficient(K_I) | 0.0032 Amp/ ⁰ C |

5. Results and Discussion

Simulation model for the PV module has been developed in MATLAB simulink software. For this simulation work the solar panel datasheet used has been presented in Table.2.

Figures 5(a) And 5 (b) shows the results of the V-I and P-V characteristic curves of the PV module with varying irradiation and constant temperature at 25⁰C. As seen in these figures, the V-I curves and the maximum points in the P-V curves are changed under the variations of operating condition. Similarly Figures 6(a) and 6(b) show the results of the V-I and P-V characteristic curves of the PV module with the varying temperature and constant irradiation at 1000 Watt/m².As seen in these figures, the V-I curves and the maximum points in the P-V curves are changed slightly under the variations of the operating condition. Figure 7(a) shows the voltage, current and power at maximum power point which is being tracked by P&O MPPT controller at different irradiation and constant temperature conditons.Similarly figure 7 (b) shows the voltage, current and power at maximum power point which is being tracked by P&O MPPT controller at different temperature and constant irradiation conditions.

Figure 8(a) shows the voltage, current and power at maximum power point which is being tracked by fuzzy MPPT controller at different irradiation and constant temperature conditons.Similarly figure 8(b) shows the voltage, current and power at maximum power point which is being tracked by fuzzy MPPT controller at different temperature and constant irradiation conditions.

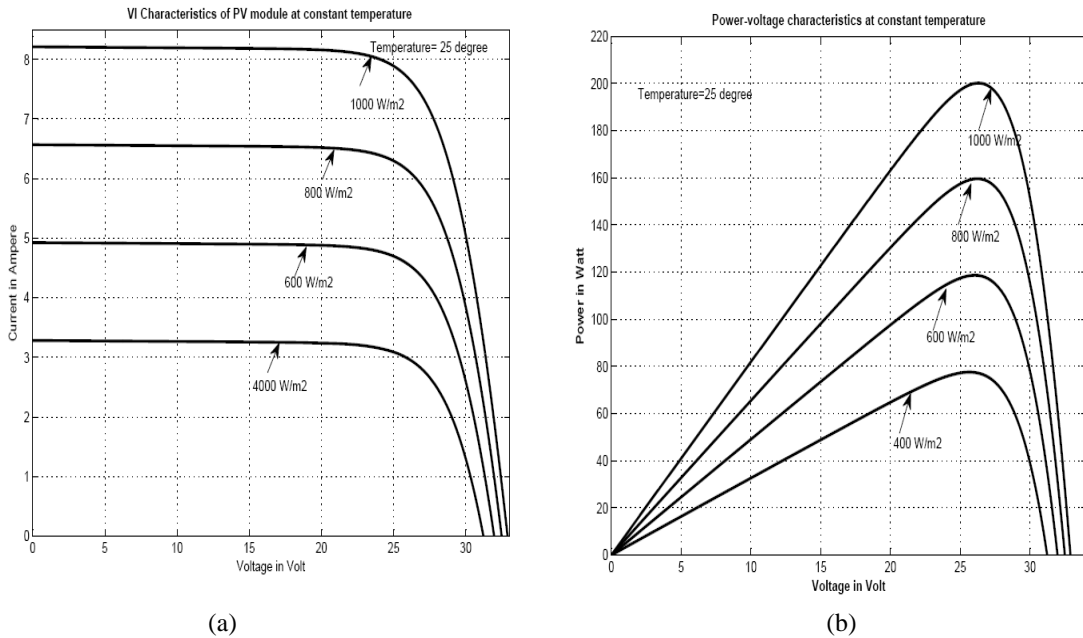

Figure 5. (a) V-I Characteristics (b) P-V Characteristics of PV module at constant temperature and varying irradiation

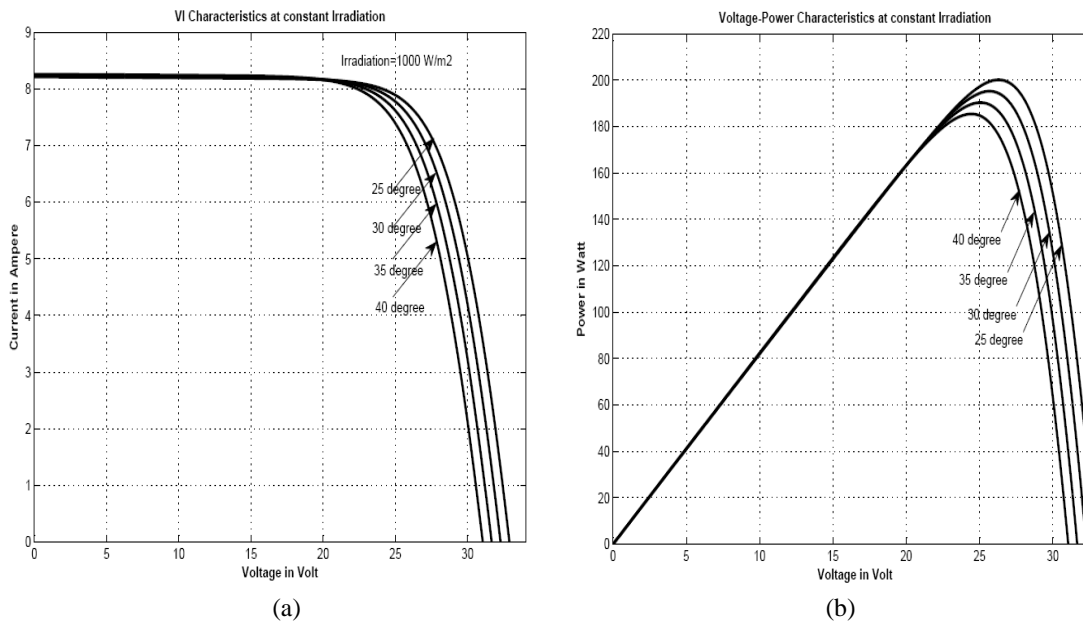

Figure 6. (a) V-I Characteristics (b) P-V Characteristics of PV module at constant irradiation and varying temperature

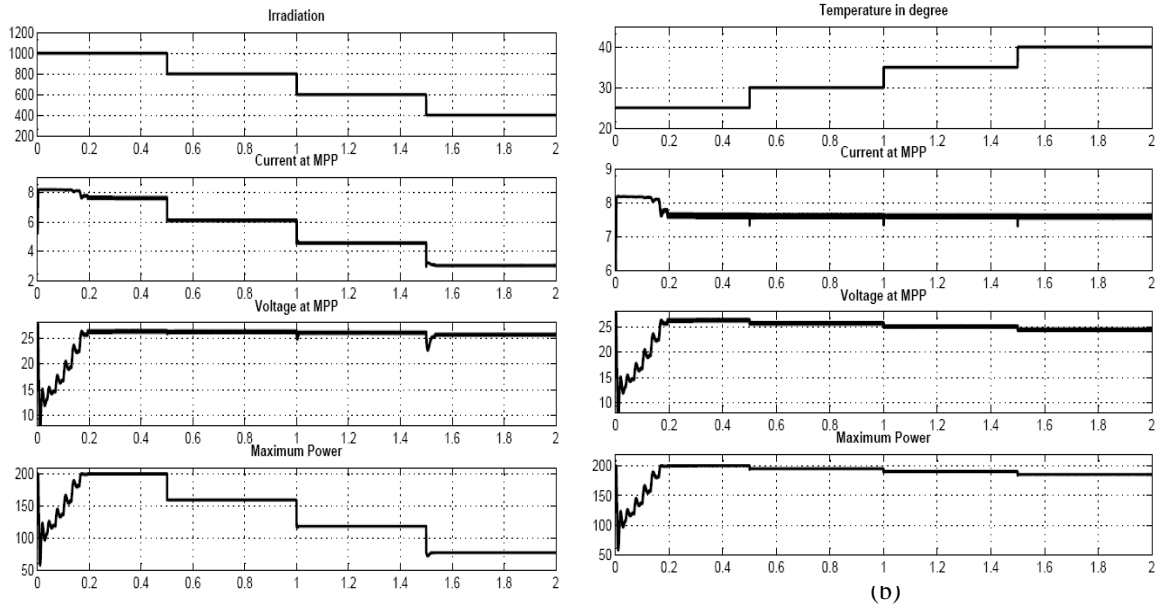

Figure 7. Simulation result of maximum current, maximum voltage and maximum power with (a) Varying irradiation and constant temperature i.e. at 25°C by P&O MPPT controller (b) Varying temperature and constant irradiation i.e. at 1000W/m² by P&O MPPT controller

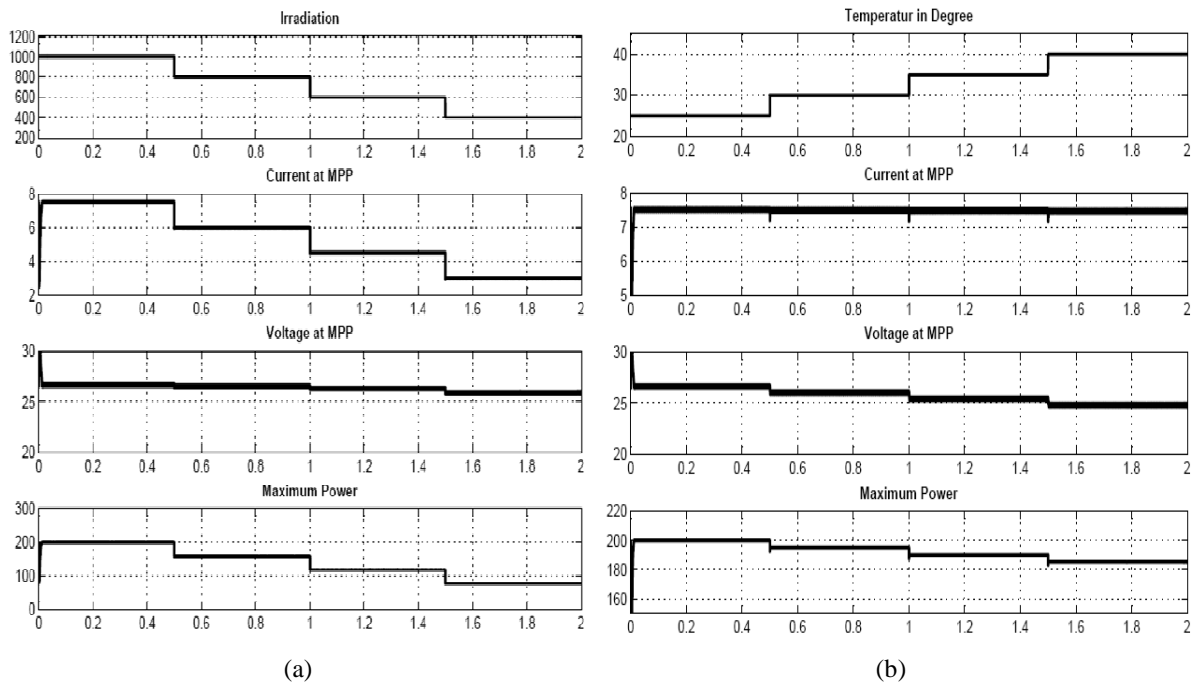

Figure 8. Simulation result of maximum current, maximum voltage and maximum power with (a) Varying

irradiation and constant temperature i.e. at 25°C by fuzzy MPPT controller (b) Varying temperature and constant irradiation i.e. at 1000W/m² by fuzzy MPPT controller

Figure.9 shows the response time of two MPPT controllers. At standard test condition i.e. at irradiation of 1000 Watt/m² and temperature of 25°C the P&O MPPT controller is taking 0.1676 seconds to track the maximum power point whereas the fuzzy MPPT controller is taking only 0.0122 seconds to track the maximum power point. It concludes that the fuzzy based MPPT controller can reduce the maximum power tracking time by 88.18% as compared to conventional perturb and observe based MPPT controller.

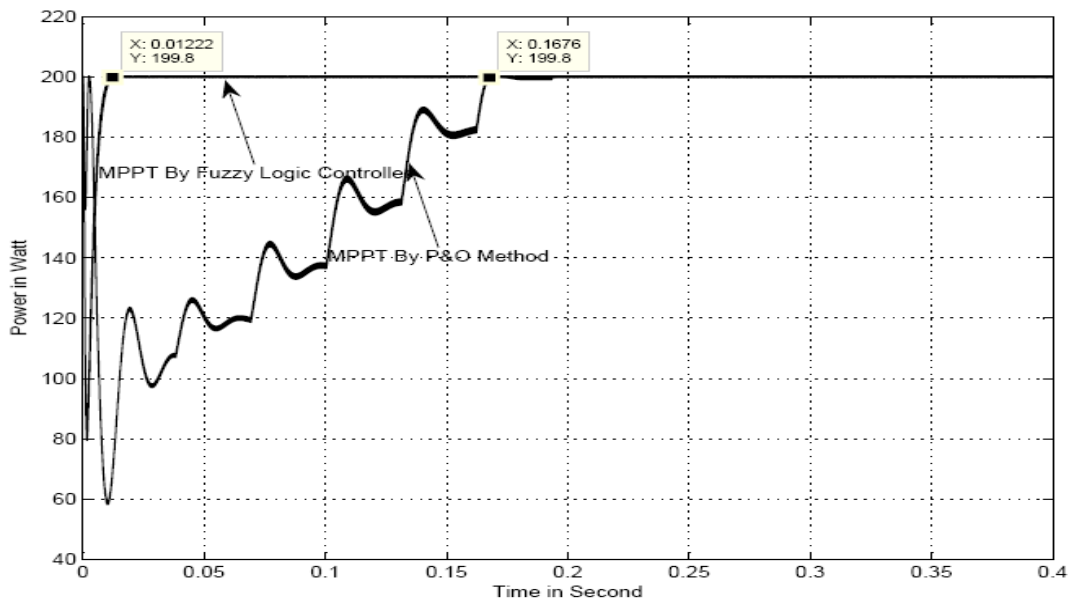

Figure 9. Maximum Power Point Tracking by P&O Method and Fuzzy Logic Controller

6. Conclusion

This paper presented a mathematical modelling of a PV module. It also included the maximum power point tracking of PV module at varying irradiation and temperature conditions. The methods which were used for the MPPT are conventional P&O MPPT controller and a Fuzzy logic controller by considering varying atmospheric conditions. Simulation results demonstrated the peak power tracking capability of the proposed fuzzy logic scheme. It was also demonstrated that the fuzzy control improves the tracking performance compared to the conventional PI controller used in perturb and observe method and, thus, avoids the tuning of controller parameters. Finally the percentage of improvement in power tracking time for fuzzy logic based MPPT controller had been evaluated over conventional P&O MPPT controller.

References

- [1] Esham, T.; Chapman, P.L.; "Comparison of Photovoltaic Array Maximum Power Point Tracking Techniques," *IEEE Transactions on Energy Conversion*, vol.22, no.2, pp.439-449, June 2007.
- [2] Seul-Ki Kim; Eung-Sang Kim; Jong-Bo Ahn, "Modeling and Control of a Grid-connected Wind/PV Hybrid Generation System," *Transmission and Distribution Conference and Exhibition, 2005/2006 IEEE PES*, pp.1202-1207, 21-24 May 2006.
- [3] Villalva, M.G.; Gazoli, J.R.; Filho, E.R.; "Comprehensive Approach to Modeling and Simulation of Photovoltaic Arrays," *IEEE Transactions on Power Electronics*, vol.24, no.5, pp.1198-1208, May 2009.
- [4] Revankar, P.S.; Gandhare, W.Z.; Thosar, A.G.; "Maximum Power Point Tracking for PV Systems Using MATLAB/SIMULINK," *Second International Conference on Machine Learning and Computing (ICMLC)*, pp.8-11, 9-11 Feb. 2010.
- [5] Ulapane, N.N.B.; Dhanapala, C.H.; Wickramasinghe, S.M.; Abeyratne, S.G.; Rathnayake, N.; Binduhewa, P.J.; , "Extraction of parameters for simulating photovoltaic panels," *6th IEEE International Conference on Industrial and Information Systems (ICIIS)*, pp.539-544, 16-19 Aug. 2011.
- [6] Femia, N.; Petrone, G.; Spagnuolo, G.; Vitelli, M.; , "Perturb and observe MPPT technique robustness improved," *IEEE International Symposium on Industrial Electronics*, vol.2, pp. 845- 850, May 2004
- [7] Kottas, T.L.; Boutalis, Y.S.; Karlis, A.D.; "New maximum power point tracker for PV arrays using fuzzy controller in close cooperation with fuzzy cognitive networks," *IEEE Transactions on Energy Conversion*, , vol.21, no.3, pp.793-803, Sept. 2006.
- [8] Ying-Tung Hsiao; China-Hong Chen; "Maximum power tracking for photovoltaic power system," *Industry Applications Conference*, vol.2, pp. 1035- 1040, 2002.
- [9] Femia, N.; Petrone, G.; Spagnuolo, G.; Vitelli, M., "Optimization of perturb and observe maximum power point tracking method," *IEEE Transactions on Power Electronics*, ,vol.20, no.4, pp. 963- 973, July 2005.
- [10] Jain, S.; Agarwal, V.; "A new algorithm for rapid tracking of approximate maximum power point in photovoltaic systems," *Power Electronics Letters, IEEE*, vol.2, no.1, pp. 16- 19, March 2004.
- [11] W. De Soto, S.A. Klein, W.A. Beckman, "Improvement and validation of a model for photovoltaic array performance," *Solar Energy*, Volume 80, Issue 1, January 2006, Pages 78-88.

This academic article was published by The International Institute for Science, Technology and Education (IISTE). The IISTE is a pioneer in the Open Access Publishing service based in the U.S. and Europe. The aim of the institute is Accelerating Global Knowledge Sharing.

More information about the publisher can be found in the IISTE's homepage:

<http://www.iiste.org>

The IISTE is currently hosting more than 30 peer-reviewed academic journals and collaborating with academic institutions around the world. **Prospective authors of IISTE journals can find the submission instruction on the following page:**

<http://www.iiste.org/Journals/>

The IISTE editorial team promises to review and publish all the qualified submissions in a fast manner. All the journals articles are available online to the readers all over the world without financial, legal, or technical barriers other than those inseparable from gaining access to the internet itself. Printed version of the journals is also available upon request of readers and authors.

IISTE Knowledge Sharing Partners

EBSCO, Index Copernicus, Ulrich's Periodicals Directory, JournalTOCS, PKP Open Archives Harvester, Bielefeld Academic Search Engine, Elektronische Zeitschriftenbibliothek EZB, Open J-Gate, OCLC WorldCat, Universe Digital Library, NewJour, Google Scholar

