

Evaluation of Specific Humidity over Nigeria using Artificial Neural Network

Adeyemi Babatunde Ogidan Raphael
Department of Physics, Federal University of Technology, Akure, Ondo State, Nigeria

Abstract

Weather forecasting is the application of science and technology to predict the state of the weather for a future time at a given location using quantitative data of past or present experiences. In this paper neural network–based autoregressive moving average with exogenous inputs (NNARMAX) and autoregressive moving average with exogenous inputs (ARMAX) models were used to obtain specific humidity (q) from the meteorological parameters obtained from the archives of Nigeria Meteorological Agency NIMET, Oshodi Lagos, Nigeria. The data which covers a ten year period (1999-2008) were the daily temperature and relative humidity data taken at 09:00 hour and 15:00 hour over sixteen stations evenly distributed across Nigeria. The results showed that the two models could be applied to predict specific humidity (q) at all the selected stations. The performance evaluation mean square error (MSE) for training and validation error (MSTE & MSVE) that were obtained at most of the stations showed that the NNARMAX model yielded better performances than the ARMAX model for instance, at Lagos, the mean square validation error (MVE) for training at 09:00 hour are 0.0007 and 0.2396 for NNARMAX and ARMAX respectively.

Keywords: Weather Forecasting, Artificial Neural Networks, ARMAX model, time series.

1. INTRODUCTION

Water vapour is the link between the surface and the atmosphere in the hydrological cycle. At current concentration, water vapour is the most important greenhouse gas in the atmosphere being the gas that absorbs most solar radiation (Adeyemi, 2009, Kiehl and Trenbert, 1997). Almost all water vapour in the atmosphere originated from the surface of the Earth where water evaporates from the ocean and the continents owing to the sun's radiation, and is transpired by plants into the atmosphere through evapotranspiration. Once in the atmosphere, water vapour can be transported horizontally and vertically by the three-dimensional circulation of the atmosphere and may condense to form liquid water or ice crystals in clouds (Adeyemi, 2009). The cycle is completed when water returns to the Earth's surface in various forms of precipitation such as rain or snow. This cycle is closely tied to atmospheric circulation and temperature patterns. Water vapour causes about two third of the natural greenhouse effect of the Earth's atmosphere. Several climate models show that an increase in atmospheric humidity by 12-25% will have the same global mean radiative effect than doubling the CO₂ concentration (Harries, 1997). Specific humidity (q), which is the amount of water vapour at the surface is expected to increase with rising surface temperature, where the presence of liquid water is not a limiting factor (Held and Soden, 2000).

Weather forecasting basically entails predicting how the present state of the atmosphere will change (Donald, 2012). This may be achieved with the use of state-of-the-art method in science and technology. Since ancient times, weather prediction has been one of the most interesting and fascinating field. Scientists have tried to forecast meteorological characteristics using a number of methods, some of these methods being more accurate than others (Elia, 2009). The chaotic nature of the atmosphere requires tools with high computational power to solve the equations that describe the atmospheric conditions. Artificial Neural Network (ANN) has that capacity to solve problems whose solutions require knowledge that is difficult to specify but for which there are enough data. This tool has been widely used to solve problems that are too difficult to solve by conventional mathematical methods. It is a computer-based problem solving tool inspired by the original biological neural network (the brain). This makes ANNs to be treated like the multivariate nonlinear nonparametric statistical methods (White, 1989; Ripley, 1993). They have been found to be useful and efficient in describing processes that are difficult to describe using complex physical or conceptual models (Hsu et al. 1995). ANN is a modelling and prediction tool widely accepted as a technique offering an alternative way to tackle complex and ill-defined problems (Kalogirou, 2001). Vandergrift et al. (2005), have studied Forecasting space weather with ANN and they found that an ANN can be trained to predict the shock arrival with better accuracy than linear techniques. Ozgur (2005) has selected three simple neural network (NN) architectures, i.e. ANN, Auto-Regressive Models and sum of square errors, for comparison of forecasting probabilities and he found that ANNs were able to produce better results than AR models when given the same data inputs. Lee (2004) predicted long-term tidal level using back propagation neural network, he concluded that back-propagation neural network model also efficiently predicts the long-term tidal levels than conventional harmonic method. Artificial neural network (ANN) modelling technique offers a better solution for developing a more generalized model for prediction of solar radiation data using climatological parameters. ANN with different topologies have been developed for

spatial prediction of wind speed in different parts of the world and they discovered that ANN has good predictability than empirical approach (Fadare, 2010). In this research, we have developed Artificial Neural Network-based Autoregressive Moving Average with external inputs (NNARMAX) model and compared it with the Autoregressive Moving Average with external input (ARMAX). In most of the past studies, the results obtained from complex ANN models were compared with those from more standard linear techniques such as regression (e.g. Schoof and Pryor, 2001; Bryant and Shreeve, 2002; Alp and Cigizoglu, 2007; Zhigang et al., 2005 Ustaoglu et al., 2008).

The objective of this research is to evaluate specific humidity (q) over four regions of Nigeria using Artificial Neural Network (ANN) method and compared the Neural Network Based Autoregressive Moving Average with Exogenous Input (NNARMAX) model with a pure mathematical model known as Autoregressive Moving Average with Exogenous Input (ARMAX) model. For the purpose of comparison using the NNARMAX and the ARMAX models, the performance of the models have been evaluated in terms of the selected performance criteria: mean training error (MTE) and mean validation error (MVE). The selected performance criteria were chosen as the statistical criteria for measuring the developed models performance according to (Ljung, 1999). The purpose of the validation is to get an estimate of the accuracy (or error rate) so that the best model can be picked out of the two models for future study (James 2013).

2 MATERIALS AND PROCEDURES

2.1 Source of Data

Ten years weather data (1999-2008) were collected from the archives of Nigerian Meteorological Agency NIMET, Oshodi Lagos, Nigeria. The data are daily values of maximum temperature and relative humidity at 09:00 hour and 15:00 hour of the day for sixteen (16) stations evenly distributed across Nigeria (See Figure 1). The stations are further grouped into four climatic regions which include Sahel (Kano, Kaduna, Maiduguri and Sokoto), Mid-Land (Bida, Abuja, Minna and Jos), Guinea Savannah (Abeokuta, Ibadan, Oshogbo and Ilorin) and Coastal (Port-Harcourt, Warri, Benin and Lagos) according to (Olaniran and Summer, 2001) (See Figure 1).. The specific humidity (q) for morning and evening times were calculated for each station.

2.2 Meteorology of the Study Area

Nigeria lies wholly within the tropical zone, there are wide climatic variations in different areas of the country. Near the coast, the seasons are not sharply defined. Temperatures rarely exceed 32°C (90°F), but humidity is very high and nights are hot. Inland, there are two distinct season: wet season from March to October characterized with generally lower temperature, and a dry season from November to February with midday temperatures that surpasses 38 °C (100 °F) but relatively cool nights. Nigeria can be divided into four climatic zones namely Sahel, Midland, Guinea savannah and Coastal zones (Olaniran and Summer, 2001).

Sahel region is a tropical hot steppe and certainly represents the best example of a semi-arid area. The rainy season last for only three to four months (June-September), the rest of the year is hot and dry with temperatures climbing as high as 40 °C (104.0°F). Mid-Land region exhibits a well-marked rainy season and dry season with a single peak known as the summer maximum due to its distance from the equator. Temperatures are above 38 °C (98.4 °F) throughout the year and an annual rainfall of about 1,500mm (59.1in) with a single rainfall maxima in September. Guinea Savannah region is extensive in area and covers most of Western Nigeria to central Nigeria beginning from the coastal region. Coastal region covers the southern part of Nigeria. Its warmth and high humidity gives it a strong tendency to ascend and produce copious rainfall, which is a result of the condensation of water vapour in the rapid rising air. The temperature is very small compared to other regions of the country, it records of maximum 28 °C (82.4 °F) for its hottest month while its lowest temperature is 26 °C (78.8 °F) in its coldest month. (www.en.wikipedia.org/wiki/geography_og_nigeria.com; Adeyemi and Ogolo, 2004; Ogolo and Falodun, 2007).

2.3 Calculation of specific humidity (q)

Specific humidity is the ratio of water vapour to dry air in a particular mass, and is sometimes referred to as humidity ratio. According to Balogun and Adedokun (1989) it can be obtained using Clausius Clapeyron equation given as

$$q = \varepsilon \frac{e}{p} \quad (1)$$

where: $\varepsilon = 0.6213$ = ratio of the molar masses of dry air and water vapour, p = atmospheric pressure (1013 hpa) and e = water vapour pressure.

The water vapour pressure e , can be calculated using to (Adediji and Ajewole, 2008)

$$e = \frac{RH \times 6.1121 \exp\left(\frac{17.50 \times T}{T + 240.97}\right)}{100} \quad (2)$$

where: e = water vapour pressure, RH = relative humidity in % and t = temperature in °C.

2.4 Artificial Neural Network Technique

From the general system mathematical models and mathematical notations, one very common method used in modelling the behaviour of a p -input q -output multivariable plant in the discrete time space is by the family of the general mathematical relationship defined by Ljung, (1999) as shown in Neural Network Structure (See Figure 2 & 3). The neural network structure is made up of three layer learning network of an input layer, hidden layer and an output layer (See Figure 4). The input quantities are fed to the input nodes which in turn pass them on to the hidden layer nodes after multiplying by a weight. The hidden layer node is to intervene between the external input and network output, add up the weighted input received from each input node, associates it with a bias and passes the results on to the nodes of the next hidden layer or the output. The process is through a non-linear transfer function. This learning process works in small iterative steps, the output is compared to the known-good $\{y(k)\}$ output, and a mean square error signal is calculated. The error value is then propagated backwards through the network, and small changes are made to the weights in each layer. The weight changes is to reduce the error signal. This cycle is repeated and stopped as soon as the overall error values drops below some expected value. The modified Levenberg-Marquardt optimization technique was used in training the feedforward back-propagation (FFBP) for (NARMAX) model. This optimization technique is more powerful than the conventionally used gradient descent techniques (Cigizoglu and Kisi, 2006). The weights and biases were adjusted based on the modified Levenberg - Marquardt Algorithm (MLMA) (Dennis and Schnabel, 1996). Figure 2 shows the system identification structure of ARMAX linear model and the flow chart of the input $u(k)$ to output $y(k)$ with delay $e(k)$ (Box and Jenkins, 1989) used in atmospheric science in time series analyses. It is usually less complicated than its non-linear counterparts with lower demands regarding computational power, and unlike non-linear models, with less parameters to be determined prior to their application. Figure 3 is the dynamic system identification. The adjustment of weights (w_1 & w_2) and biases ($\theta(k) = [-A_1, \dots, -A_{n_a}, B_0, \dots, B_{n_b}, C_1, \dots, C_{n_c}]^T$) is done by using input data ($n_b = m$) taken at time instant [$n_c = \text{delay}$]. The ANNs are adjusted to make the predictions of the network outputs ($\hat{y}(k)$) close to the actual outputs ($y(k)$) (Gupta et al., 2003).

$$A(Z^{-1}) Y(k) = Z^{-d} \frac{B(Z^{-1})}{F(Z^{-1})} U(k) + \frac{C(Z^{-1})}{D(Z^{-1})} e(k) \quad (3)$$

where $Y(k)$ = vector of order n of the q outputs at timing instant k responding to the vector input $u(k)$; d = delay, $e(k)$ = the noise disturbance vector; $[A(Z^{-1}), B(Z^{-1}), C(Z^{-1}), D(Z^{-1})]$ and $F(Z^{-1})$ are polynomial matrices.

The auto-regressive moving average with exogenous input (ARMAX) linear model structure was derived from the combination of the three parameters A , B and C which gives (see Figure 3)

$$Y(k) A(Z^{-1}) = Z^{-d} B(Z^{-1}) U(k) + C(Z^{-1}) e(k) \quad (4)$$

and if $D = F = 1$ in equation (3), equation (5) gives us the one-step ahead prediction.

$$\hat{Y}(k, \theta(k)) = \varphi(k, \theta(k))\theta(k) \quad (5)$$

The neural network-based auto-regressive moving average with exogenous input (NNARMAX) nonlinear model structures was formulated from the linear model (ARMAX) by changing the internal architecture of ARMAX to be Feed Forward Dynamic Neural Network (FDNN). The one-step ahead nonlinear predictor is expressed as (Ljung, 1999 and Norgarrd et. al., 2000)

$$\hat{Y}(k, \theta(k)) = J(Z^N, \varphi(k), \theta(k)) \quad (6)$$

where $J(Z^N, \varphi(k), \theta(k))$ = a nonlinear cost function of its arguments that can be realized by a neural network and it is assumed to have a feed forward structure, Z^N = the input-output data pair obtained from prior plant operation over period of time as (Ljung, 1999) (see Figure 2).

$$Z^N = [U(1), Y(1), \dots, U(N), Y(N)], \quad N = 1, 2, \dots, z. \quad (7)$$

Where N = number of input output data pair, T = the sampling period of the system z is the total number of samples. The validation error is (Ljung, 1999)

$$\theta(k) = [-A_1, \dots, -A_{n_a}, B_0, \dots, B_{n_b}, C_1, \dots, C_{n_c}]^T \quad (8)$$

The mean square error (MSE) is calculated using the formula below:

$$MSE = \frac{1}{N} (Y - \hat{Y})^2 \quad (9)$$

where N = total number of data, y = actual values and \hat{Y} = predicted values. The mean squared error gives the error value the same dimensionality as the actual and predicted values.

3. RESULTS AND DISCUSSION

Training and validation results for the NNARMAX and ARMAX models

Here, one-year-ahead forecast has been carried out using nine years daily specific humidity data. The specific

humidity (q) time series forecast were carried out for the morning and the evening times using the neural network model Modified Levenberg Marquardt Algorithm (MLMA) i.e. Neural Network –based autoregressive moving average with exogenous input (NNARMAX) and the autoregressive moving average with exogenous input (ARMAX) model. For each specific humidity forecasted case, the training and validation results and their mean square errors were presented, that is, the mean square training error (MSTE) and the mean square validation error (MSVE) were calculated and presented in Tables 2 – 5. Figures 6 and 7 show the NNARMAX model training and validation results at 09:00 Hour and 15:00 Hour respectively over Lagos. Figures 8 and 9 show the NNARMAX model training and validation results at 09:00 Hour and 15:00 Hour respectively over Ibadan. Figures 10 and 11 show the NNARMAX model training and validation results at 09:00 Hour and 15:00 Hour respectively over Abuja. Figures 12 and 13 show the NNARMAX model training and validation results at 09:00 Hour and 15:00 Hour respectively over Kaduna. Figures 14 and 15 show the ARMAX model training and validation results at 09:00 Hour and 15:00 Hour respectively over Lagos. Figures 16 and 17 show the ARMAX model training and validation results at 09:00 Hour and 15:00 Hour respectively over Ibadan. Figures 18 and 19 show the ARMAX model training and validation results at 09:00 Hour and 15:00 Hour respectively over Abuja. Figures 20 and 21 show the ARMAX model training and validation results at 09:00 Hour and 15:00 Hour respectively over Kaduna.

From Figures 5 (a-d) where comparison between specific humidity at 09:00 Hour and 15:00 Hour was done. It was observed that specific humidity q at 09:00 Hour is generally higher than at 15:00 Hour at all the stations and regions. This observation may be explained using the austauch phenomenon (i.e. lifting of the boundary layer) (Adeyemi, 2004). Late morning local surface heating of the atmosphere (Roger and Richard, 1982) cause's environmental lapse rate near the surface to exceed dry adiabatic lapse rate causing conditional instability. Air then rises. The adiabatic cooling of the connective rising air allows it to remain warmer and less dense than the surrounding air so that it continues to rise through buoyancy. Water vapour is then transported upwards resulting in humidity depletion at the bottom level of the atmosphere.

Also at all the stations and regions, the fact that the network prediction of the training data and the validation data of both the NNARMAX and ARMAX models correlate is easily discernible. This is an indication that both the trained and the validation networks adequately captures and approximate the system for the two models. This fact can also be easily seen in the values of the mean square training error (MSTE) and that of the mean square validation error (MSVE) which are generally low.

Comparing the two techniques the is, NNARMAX and ARMAX models and, at all the stations and regions, the NNARMAX model puts up a better performance than the ARMAX model as can be seen in the values of the MSTE and MSVE. MSTE and MSVE for NNARMAX being generally lower than those for ARMAX at all the stations and regions (See Tables 2 – 5).

4 CONCLUSION

Time – Series Forecast of specific humidity ' q ' at sixteen (16) meteorological stations in Nigeria was carried out using artificial neural network Modified Marquardt Algorithm (MLMA) and Autoregressive Moving Average with Exogenous input (ARMAX). The forecast q values at all the stations show that q is higher in the morning hour (i.e. at 09:00 hour) than in the evening hour of 15:00 hour. This has been explained using austauch phenomenon, that is, lifting of the boundary layer (Adeyemi, 2004) causing water vapour to be transported upward resulting in its depletion at the bottom level of the atmosphere (Roger and Richard, 1982). Also, at all the stations and regions, both NNARMAX and ARMAX gave good prediction of both training and validation data. Comparing than using MSTE and MSVE values at all the stations and regions, NNARMAX gave a better prediction of q than ARMAX.

REFERENCES

- Adediji A.T and Ajewole M.O, (2008): "Vertical profile of radio refractivity gradient in Akure, south-west, Nigeria", Progress in Electromagnetics Research C, Vol. 4, 157–168.
- Adeyemi B., (2009): "Use of CM-SAF data for climate variability analysis over Nigeria" EUMETSAT Satellite Application Facility on Climate Monitoring, 14-15.
- Adeyemi B., (2009): "Empirical Formulations for Inter-Layer Presipitable Water Vpor in Nigeria", The Pacific Journal of Science and Technology, Vol. 10, 35.
- Adeyemi, B. (2004): "Tropospheric Radio Refractivity over three Radiosonde Stations in Nigeria", Ife Journal of Science. OAU Ile-Ife Nigeria 6(2) 37.
- Adeyemi, B. (2004): "Modelling of ITD over Nigeria using Radio Meteorological Parameters of the Troposphere." A PhD. Dissertation presented to the Department of Physics, University of Ilorin, Ilorin Nigeria. P 53.
- Adeyemi, B and Ogolo, E. O. 92014): "Diurnal and Seasonal Variations of Surface Water Vapour Density over some Meteorological Stations in Nigeria" Ife Journal of Science 16(2), 181 –189.

- Alp M, Cigizoglu HK. (2007): "Suspended sediment load simulation by two artificial neural network methods using hydro meteorological data". *Environmental Modelling & Software* 22(1): 2-13.
- Aro, T.O. (1975): "Analysis of Data on Surface and Tropospheric Water Vapour". *Journal of Atoms and Terrestrial Physics*. 38:571.
- Bryant, S. and Shreeve, T.G. (2002): "The use of artificial neural networks in ecological analysis": estimating microhabitat temperature. *Ecological Entomology* 27: 424-428.
- Cigizoglu H.K. 2003a. Estimation, forecasting and extrapolation of river flows by artificial neural networks. *Hydrological Sciences Journal-Journal Des Sciences Hydrologiques* 48 (3): 349-361.
- Cigizoglu HK. 2003b. Incorporation of ARMA models into flow forecasting by artificial neural networks. *Environmentrics* 14: 417-420.
- Elsner JB, Tsonis AA. 1992. Nonlinear prediction, chaos, and noise. *Bulletin of the American Meteorological Society* 73: 49-50.
- Freiwan M, Cigizoglu HK. 2005. Prediction of total monthly rainfall in Jordan using feed forward back propagation method. *Fresenius Environmental Bulletin* 14(2): 142-151.
- Elia G. P., (2009): "A Decision Tree for Weather Prediction", *Universitatea Petrol-Gaze din Ploiesti, Bd. Bucuresti 39, Ploiesti, Catedra de Informatica, vol. LXI, No. 1*
- Fadare D.A. (2010): "The Application of artificial neural networks to mapping of wind speed profile for energy application in Nigeria" *Applied Energy* 87: 934-942.
- Harries J. E., (1997): "Atmospheric radiation and atmospheric humidity", *Quarterly Journal of the Royal Meteorological Society*, Vol. 123, ISSN:0035-9009, 2175
- Held I.M. and Soden B.J. (2000): "Water Vapour Feedback and Global Warming", *Annu. Rev. Energy Env.* 25:444
- Hsu, K., Gupta, H. V., and Sorooshian, S. (1995): "Artificial neural network modelling of the rainfall-runoff process" *Water Resource. Res.*, 31(10), 2517-2530.
- James D.M., <http://jamesmccaffrey.wordpress.com/2013/05/27/cross-validation-neural-networks-and-over-fitting>.
- Jiya, J.D. and Alfa, B. (2002): "Parametization of solar radiation using neural network" *Nigerian J. Renew. Energy* 10(1&2): 6-10.
- Jyosthna et al. (2012): "ANN approach for weather prediction using back propagation" *International Journal of Engineering trends and Technology* Vol. 3. 19-21.
- Kalogirou S. A. (2001): "Artificial neural networks in renewable energy systems application": a review. *Renewable Sustainable Energy Rev.*, 5: 373-401.
- Kiel, J.T. and Trenberth, K.E. (1997): "Earth's Annual Global Mean Energy Budget". *Bull Am Meteorol Soc.* 78:197-208.
- Lai I.I. et al. "Intelligent weather forecast" *Third international conference on machine learning and cybernetics, shanghai, 2004*.
- Lee Tsong-Lin, (2004): "Back-propagation neural network for long-term tidal predictions", *Elsevier*, 31, pp. 225-238.
- Ljung, (1999) "System Identification, Theory for the user". *Prentice-Hall Information and System Sciences Service. Second Edition*, 39-99.
- Ogolo, E. O. and Falodun, S. E. (2007): "Variation and Trends in Long Term Annual Mean Air Temperatures over Some Selected Cities in Nigeria." *Journal of Physical Sciences, International Research and Development* 3(2), 40 - 44.
- Omotosho, J. B., Balogun, A. A. and Ogunjobi K. (2000): "Predicting monthly and Seasonal Rainfall, Onset and Cessation of the rainy season in West Africa using only surface data". *International Journal of Climatology* 20:865.
- Ripley, B. D. (1994): "Neural Networks and Related Methods for Classification (with discussion)". *J. Roy. Statist. Soc. Ser. B* 56.
- Roger, G. B. and Richard, J. C. (1982): "Atmospheric Weather and Climate." *Methuen, London*, 1 - 85. Roger, R. H. and Richard, R. P., (1987): "Atmosphere, Weather and Climate, *Methuen and Co.* 305, 349.
- Schoof, J. T. and Pryor, S. C. (2001): "Downscaling Temperature and Precipitation: a Comparison of Regression-based Methods and Artificial Neural Networks". *International Journal of Climatology* 21: 773-779.
- Trenberth, K. E. (1999): "Conceptual Framework for Changes of Extremes of the Hydrological Tropospheric Moisture" *Journal of Climate*, 4, 989-1008.
- White, H., (1989): *Learning in artificial neural networks: "A statistical perspective"*. *Neural Computation* 1, 425-464.

Table 1: The geographical locations and samples of specific humidity q (g/kg) data.

S/N	STATIONS	LATITUDE ($^{\circ}$ N)	LONGITUDE ($^{\circ}$ E)	ELEVATION ABOVE SEA LEVEL (m)	USED DATA
1	LAGOS	6.45	3.39	35	3654
2	BENIN	6.31	5.62	80	3654
3	WARRI	5.52	5.75	21	3654
4	PORT HARCOURT	4.78	7.00	468	3654
5	ABEOUKTA	7.13	3.34	67	3654
6	IBADAN	7.40	3.92	239	3654
7	OSOGBO	7.76	4.56	317	3654
8	ILORIN	8.49	4.55	290	3654
9	BIDA	9.08	6.00	151	3654
10	ABUJA	9.06	7.48	536	3654
11	MINNA	9.61	6.55	299	3654
12	JOS	9.93	8.88	1208	3654
13	KADUNA	10.52	7.43	614	3654
14	KANO	12.00	8.52	479	3654
15	MAIDUGURI	11.83	13.15	300	3654
16	SOKOTO	13.06	5.25	265	3654

Table 2: Training Result for the NNARMAX and ARMAX models at 09:00 Hour for all stations selected.

S/N	STATIONS	ARMAX (MSTE)	NNARMAX (MSTE)
1	LAGOS	0.2396	0.0007
2	BENIN	0.0269	0.0002
3	WARRI	0.0877	0.0002
4	PORT HARCOURT	0.0241	0.0008
5	ABEOKUTA	0.3500	0.0029
6	IBADAN	0.3478	0.0219
7	OSOGBO	0.3749	0.0045
8	ILORIN	0.3501	0.0005
9	ABUJA	0.3465	0.0021
10	BIDA	0.3027	0.0006
11	MINNA	0.2292	0.0008
12	JOS	0.0168	0.0006
13	KANO	0.2679	0.0004
14	KADUNA	0.2944	0.0001
15	MAIDUGURI	0.1779	0.0001
16	SOKOTO	0.0430	0.0002

Table 3: Training Result for the NNARMAX and ARMAX models at 15:00 Hour for all stations selected.

S/N	STATIONS	ARMAX (MSTE)	NNARMAX (MSTE)
1	LAGOS	0.0242	0.0001
2	BENIN	0.0238	0.0007
3	WARRI	0.0294	0.0008
4	PORT HARCOURT	0.0192	0.0017
5	ABEOKUTA	0.0252	0.0006
6	IBADAN	0.0154	0.0008
7	OSOGBO	0.0193	0.0002
8	ILORIN	0.0218	0.0003
9	ABUJA	0.0183	0.0011
10	BIDA	0.0209	0.0003
11	MINNA	0.2846	0.0019
12	JOS	0.0158	0.0002
13	KANO	0.0189	0.0006
14	KADUNA	0.0859	0.0001
15	MAIDUGURI	0.0192	0.0003
16	SOKOTO	0.0250	0.0002

Table 4: Validation Result for the NNARMAX and ARMAX models at 09:00 Hour for all stations selected.

S/N	STATIONS	ARMAX (MSVE)	NNARMAX (MSVE)
1	LAGOS	0.2492	0.0004
2	BENIN	0.0219	0.0008
3	WARRI	2.1055	0.0002
4	PORT HARCOURT	0.0188	0.0003
5	ABEOKUTA	0.3986	0.0031
6	IBADAN	0.4188	0.0001
7	OSOGBO	0.3648	0.0001
8	ILORIN	0.2643	0.0009
9	ABUJA	0.3502	0.0008
10	BIDA	0.5112	0.0003
11	MINNA	0.2240	0.0003
12	JOS	0.0220	0.0004
13	KANO	0.1969	0.0009
14	KADUNA	0.3164	0.0003
15	MAIDUGURI	0.1610	0.0005
16	SOKOTO	0.0271	0.0007

Table 5: Validation Result for the NNARMAX and ARMAX Algorithm at 15:00 Hour for all stations selected.

S/N	STATIONS	ARMAX (MSVE)	NNARMAX (MSVE)
1	LAGOS	0.0136	0.0003
2	BENIN	0.0158	0.0001
3	WARRI	1.0652	0.0001
4	PORT HARCOURT	0.0253	0.0009
5	ABEOKUTA	0.0154	0.0002
6	IBADAN	0.0198	0.0005
7	OSOGBO	0.0231	0.0001
8	ILORIN	0.0175	0.0005
9	ABUJA	0.0205	0.0001
10	BIDA	0.0249	0.0003
11	MINNA	0.4106	0.0015
12	JOS	0.0199	0.0002
13	KANO	0.0217	0.0003
14	KADUNA	0.0907	0.0003
15	MAIDUGURI	0.0221	0.0004
16	SOKOTO	0.0179	0.0002

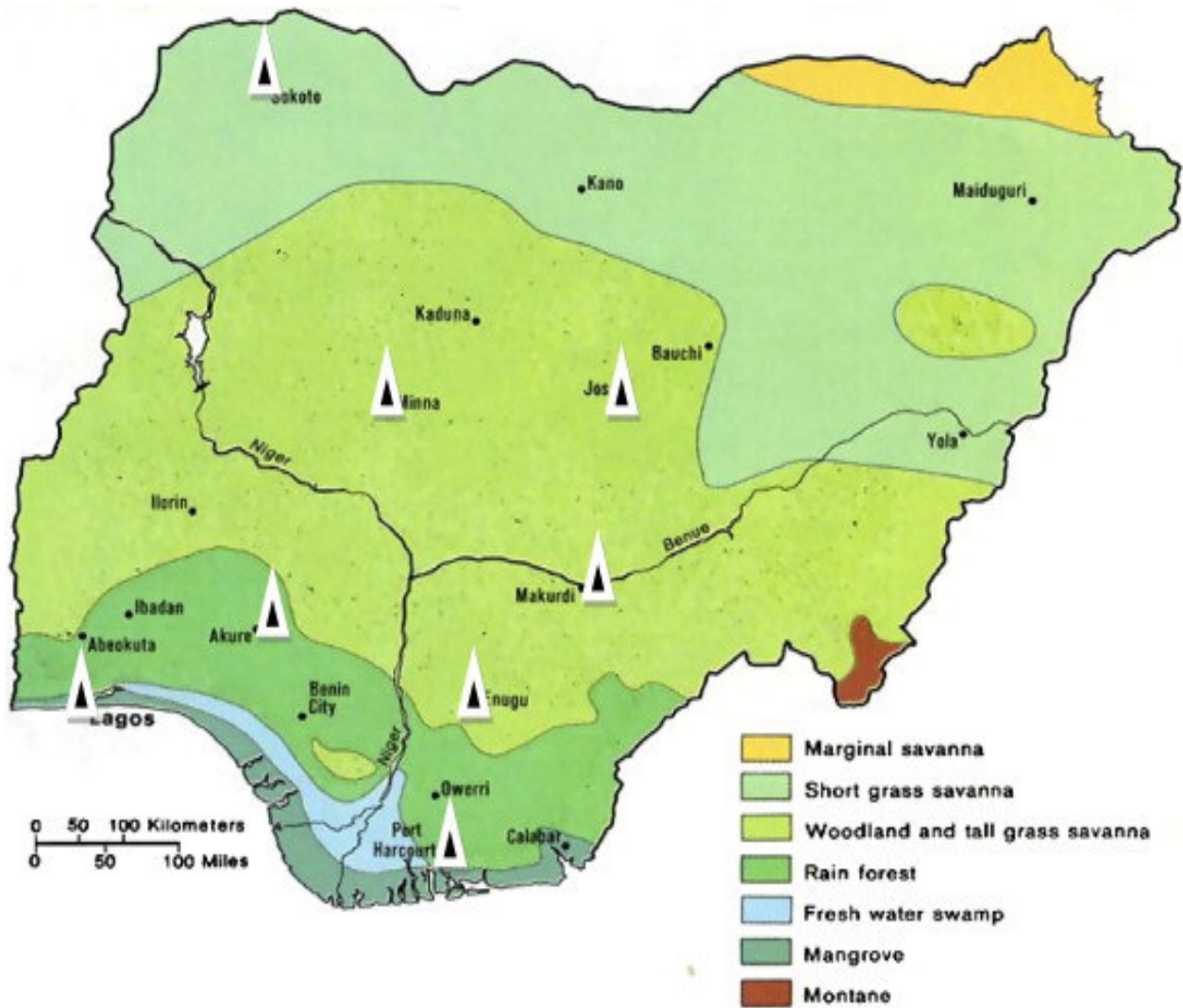

Figure 1: Map of Nigeria (<http://www.climate-zone.com/climate/nigeria>).

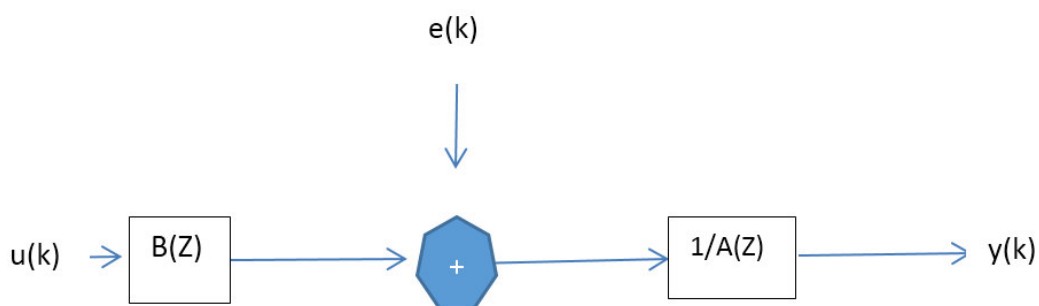

Figure 2: The ARMAX model predictor structure. (www.ni.com)

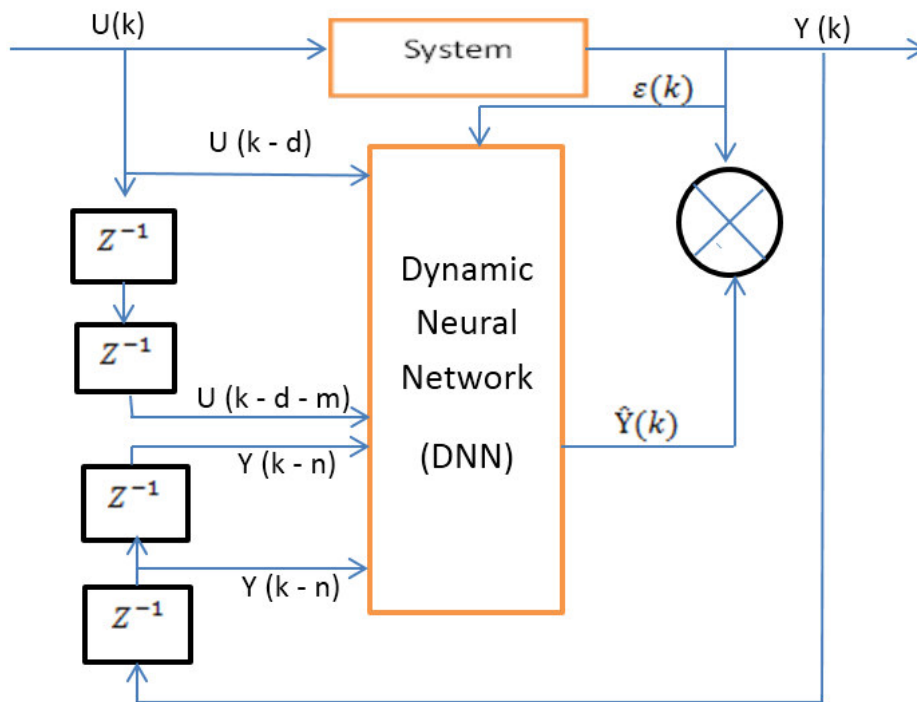

Figure 3: The NNARMAX series-parallel model identification structure. [Gupta et al., 1999]

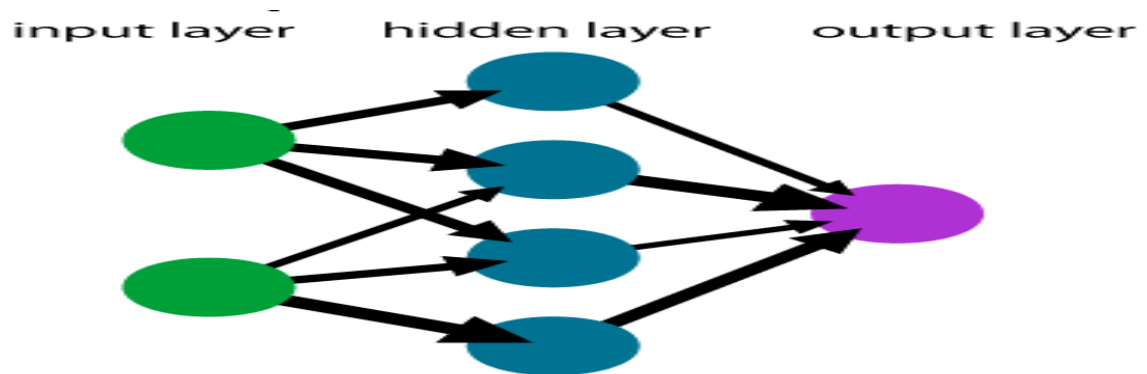

Figure 4: The structure of the feed-forward back-propagation neural network (FFBP).

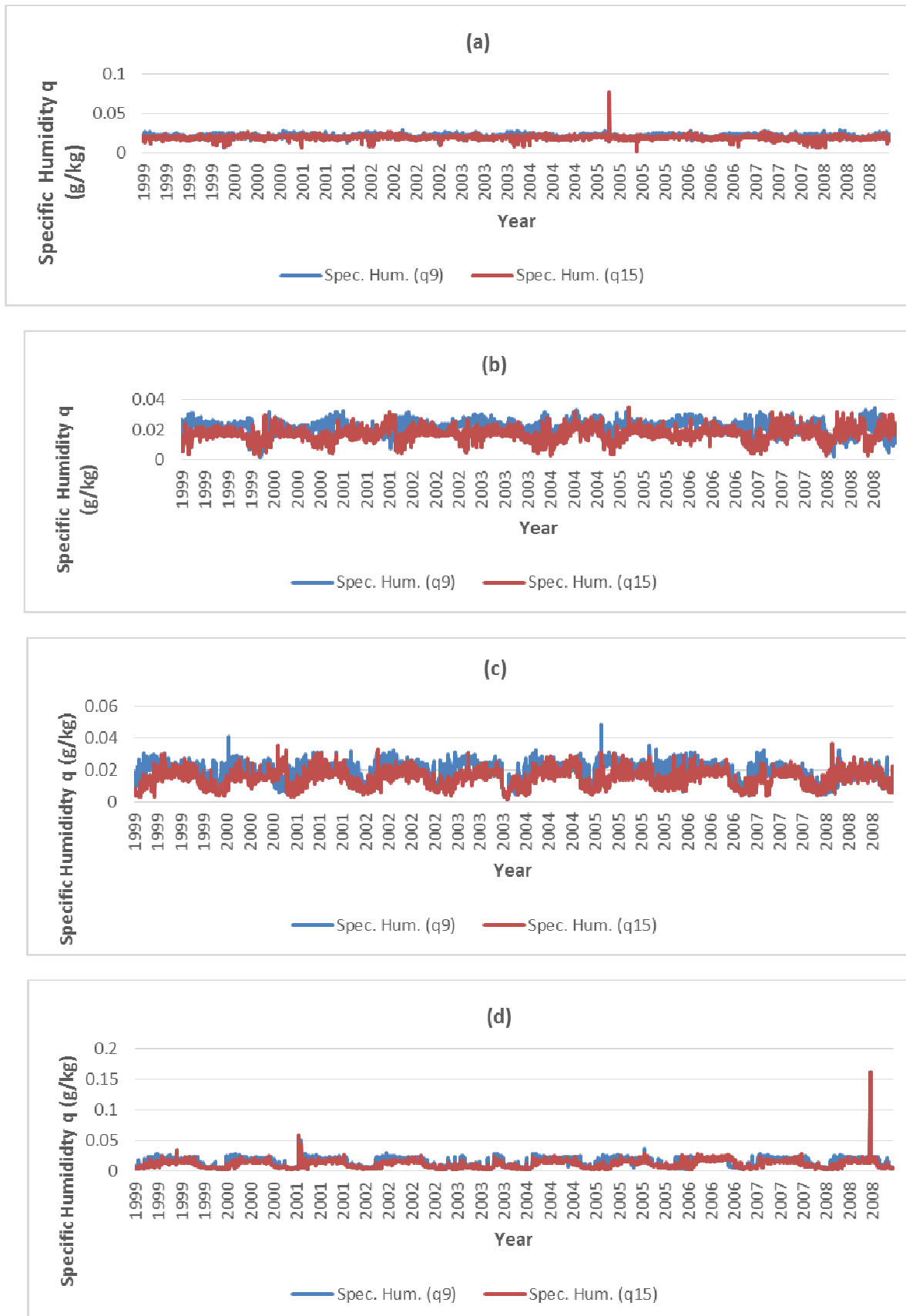

Figure 5: Distribution of specific humidity over (a) Lagos (b) Ibadan (c) Abuja and (d) Kaduna at 09:00 Hour and 15:00 Hour respectively.

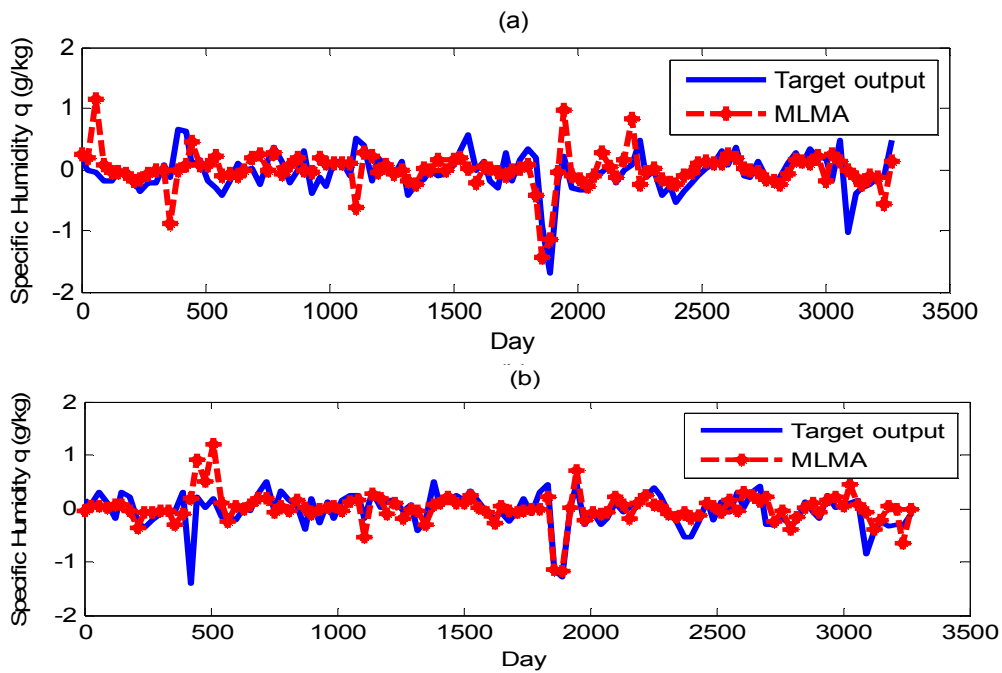

Figure 6: NNARMAX model training result for the specific humidity data at (a) 09:00 Hour (b) 15:00 Hour for Lagos , a Coastal station.

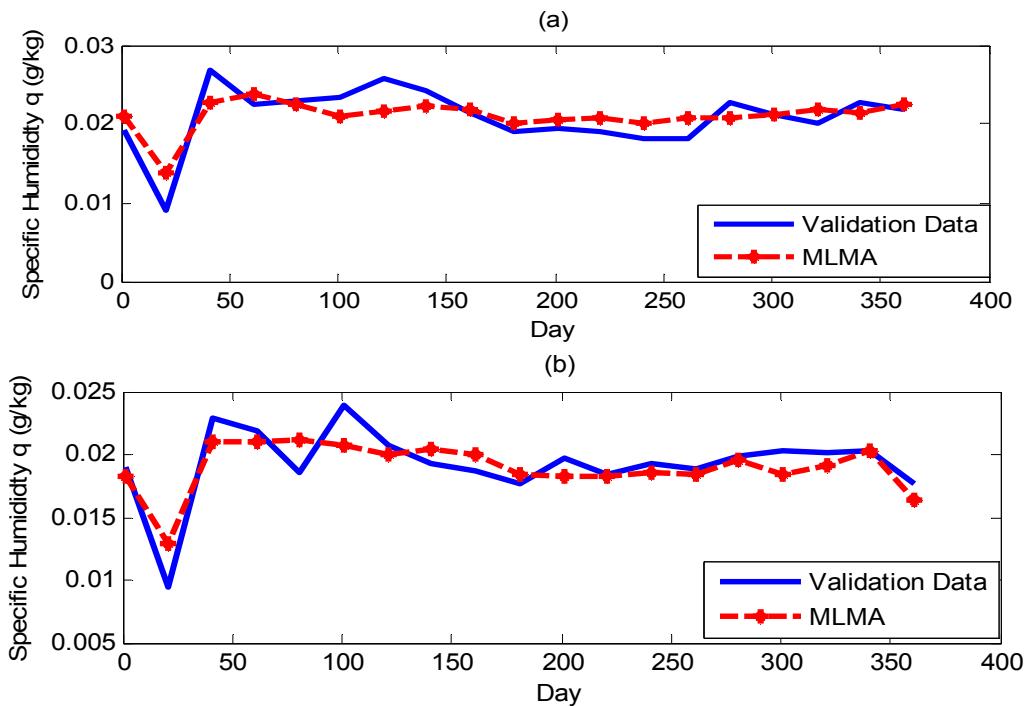

Figure 7: NNARMAX model validation result for the specific humidity data at (a) 09:00 Hour (b) 15:00 Hour for Lagos , a Coastal station.

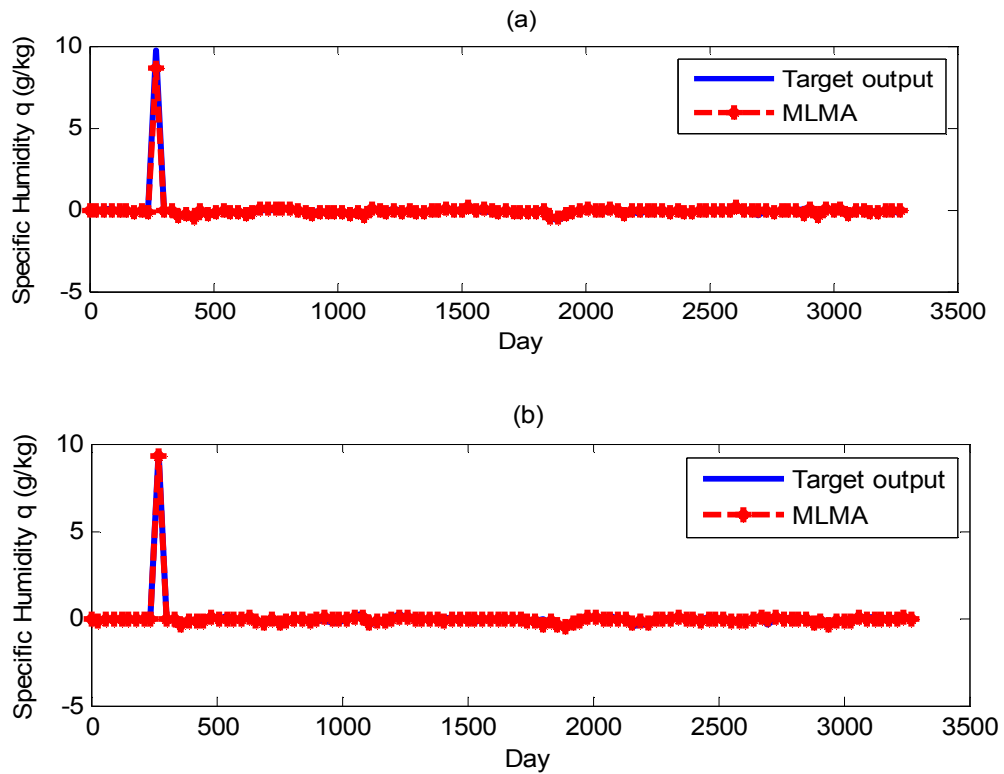

Figure 8: NNARMAX model training result for the specific humidity data at (a) 09:00 Hour (b) 15:00 Hour for Ibadan, a Guinea Savannah station.

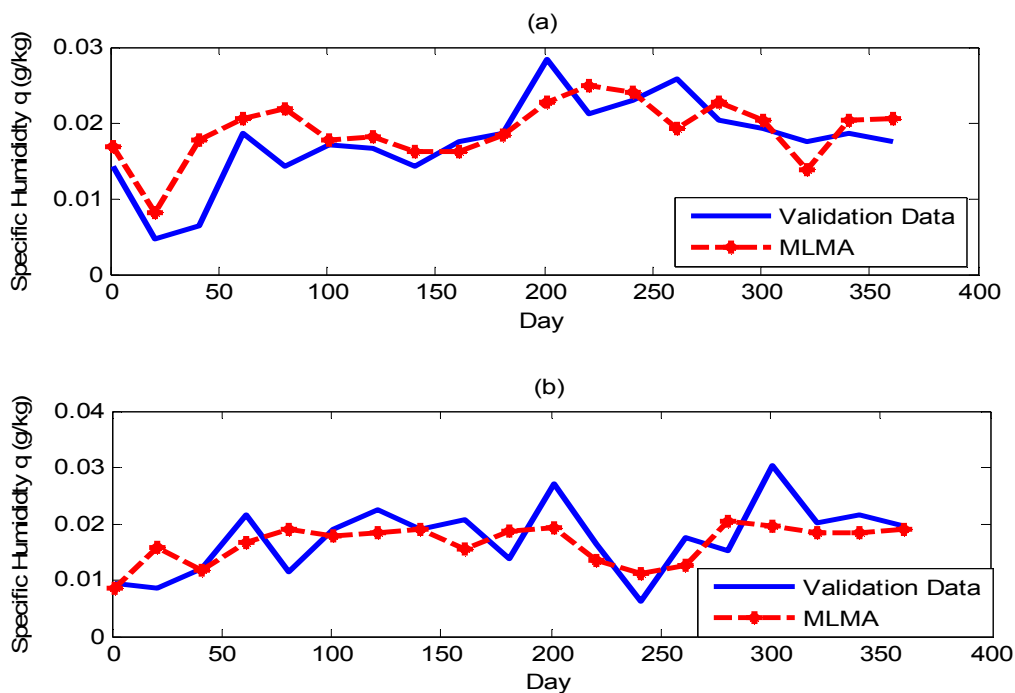

Figure 9: NNARMAX model validation result for the specific humidity data at (a) 09:00 Hour (b) 15:00 Hour for Ibadan, a Guinea Savannah station.

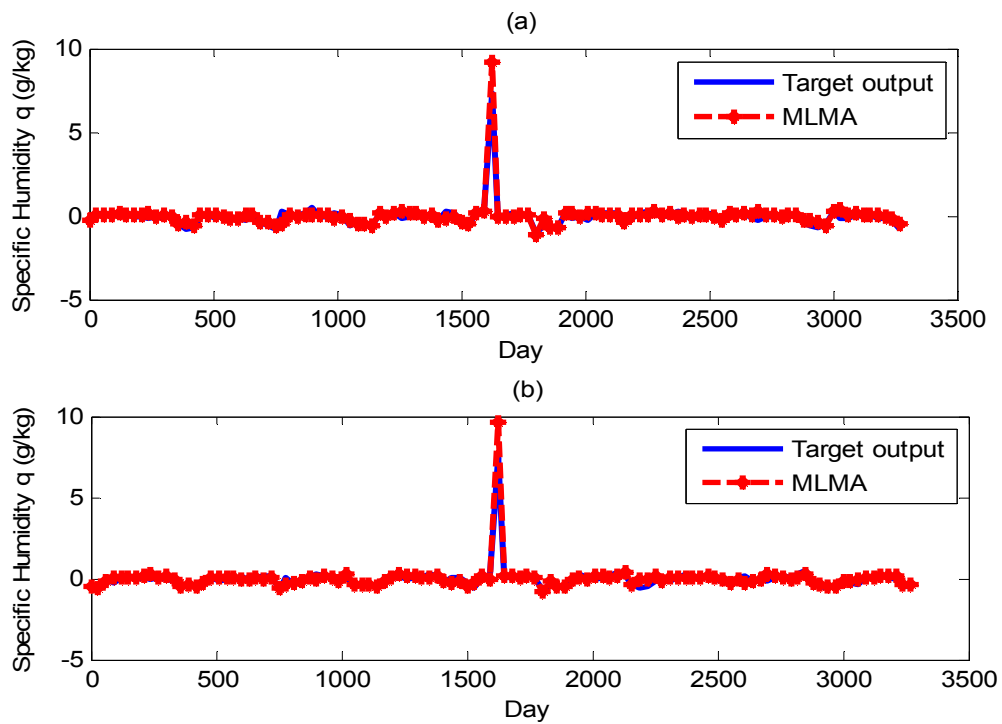

Figure 10: NNARMAX model training result for the specific humidity data at (a) 09:00 Hour (b) 15:00 Hour for Abuja , a Mid-land station.

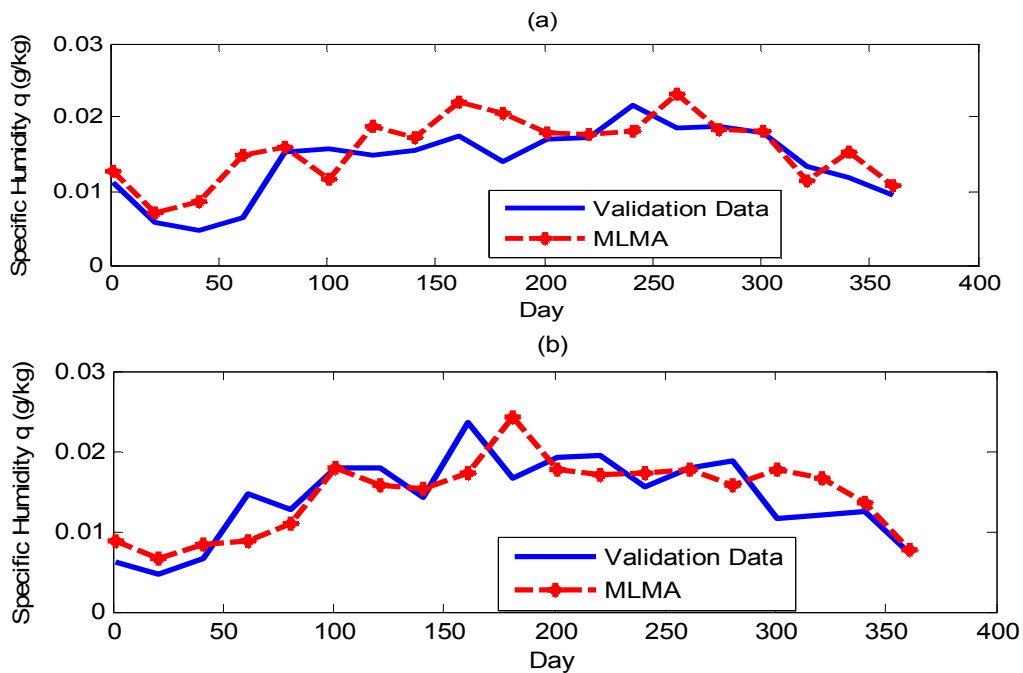

Figure 11: NNARMAX model validation result for the specific humidity data at (a) 09:00 Hour (b) 15:00 Hour for Abuja , a Mid-land station.

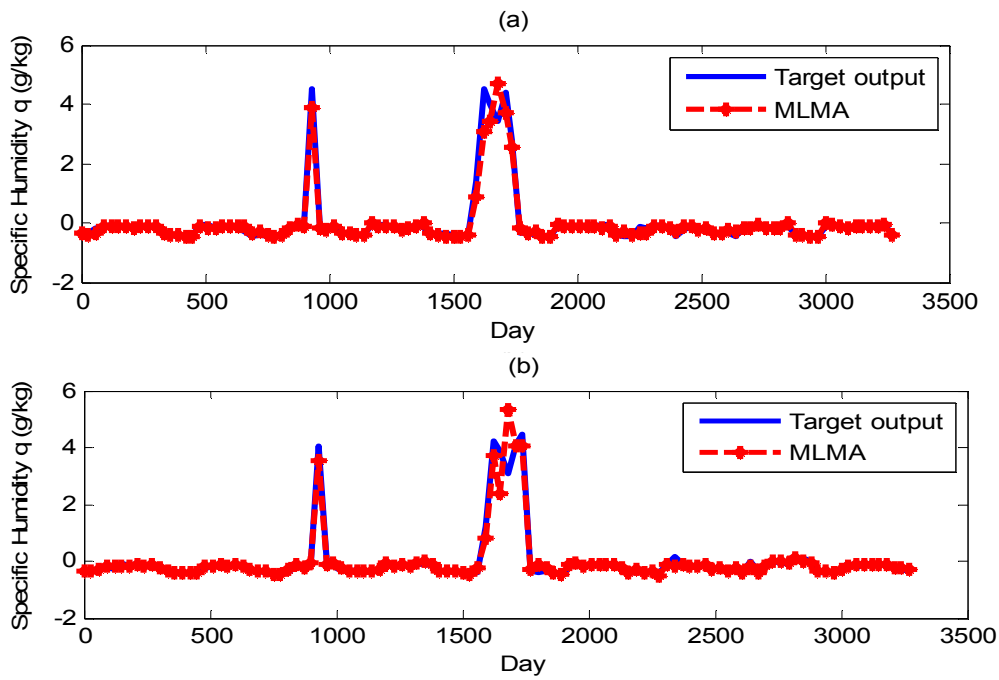

Figure 12: NNARMAX model training result for the specific humidity data at (a) 09:00 Hour (b) 15:00 Hour for Kaduna, a Sahel station.

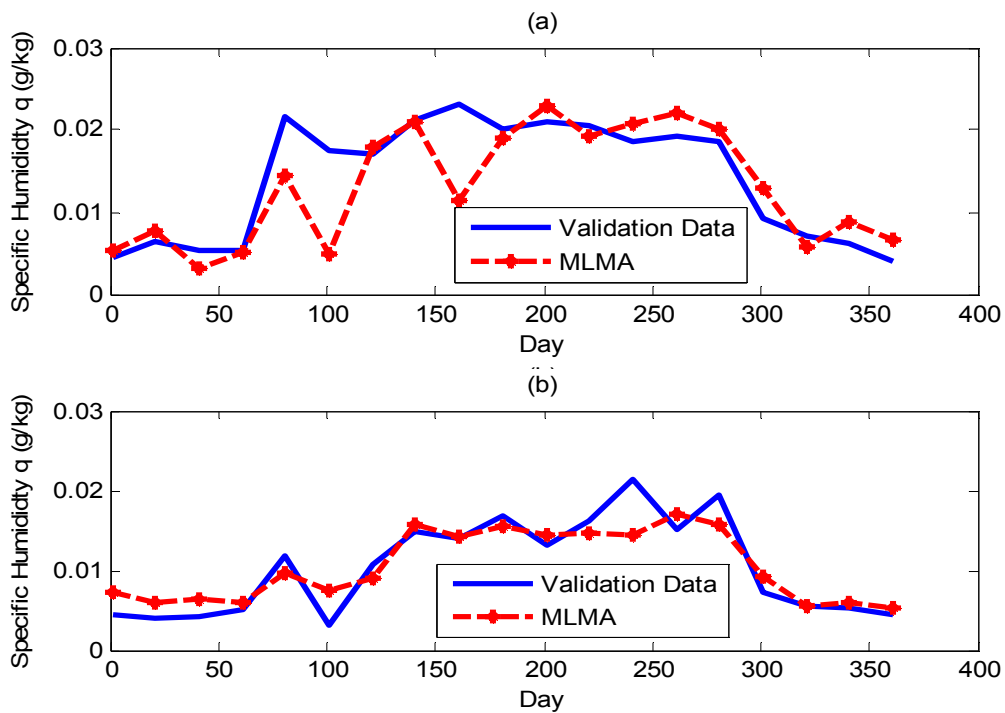

Figure 13: NNARMAX model validation result for the specific humidity data at (a) 09:00 Hour (b) 15:00 Hour for Kaduna, a Sahel station.

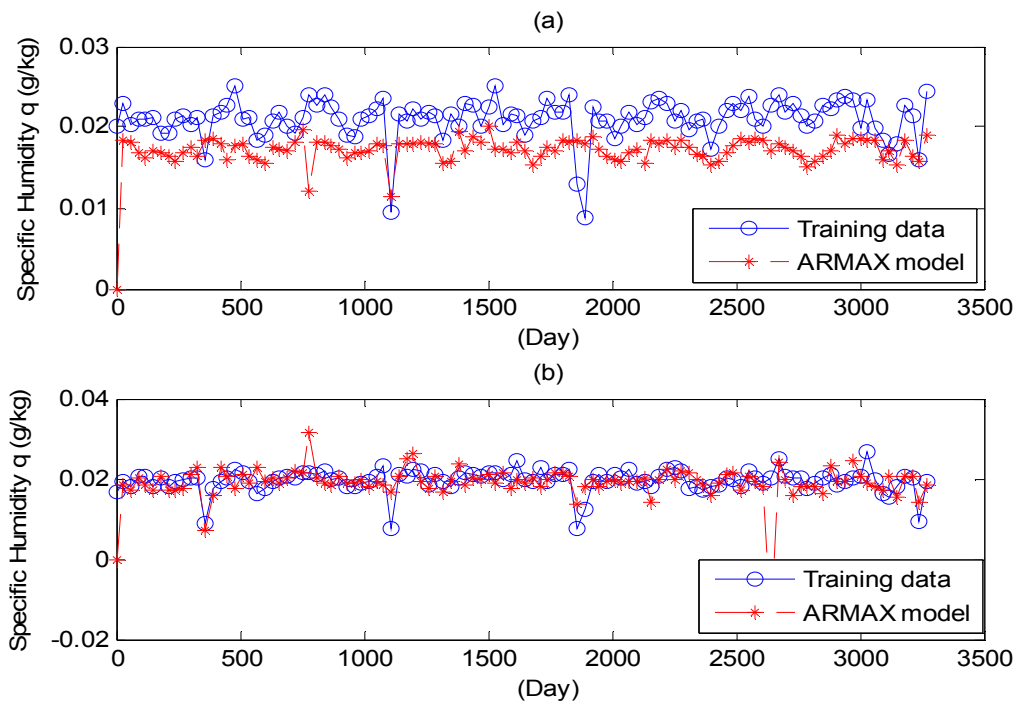

Figure 14: ARMAX model training result for the specific humidity data at (a) 09:00 Hour (b) 15:00 Hour for Lagos , a Coastal station.

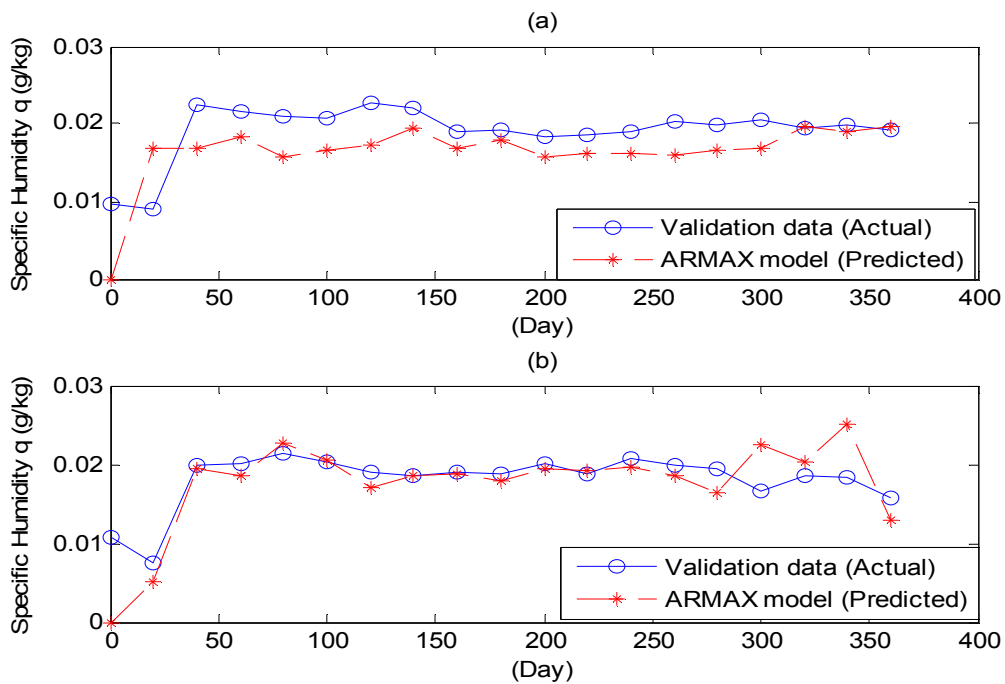

Figure 15: ARMAX model validation result for the specific humidity data at (a) 09:00 Hour (b) 15:00 Hour for Lagos , a Coastal station.

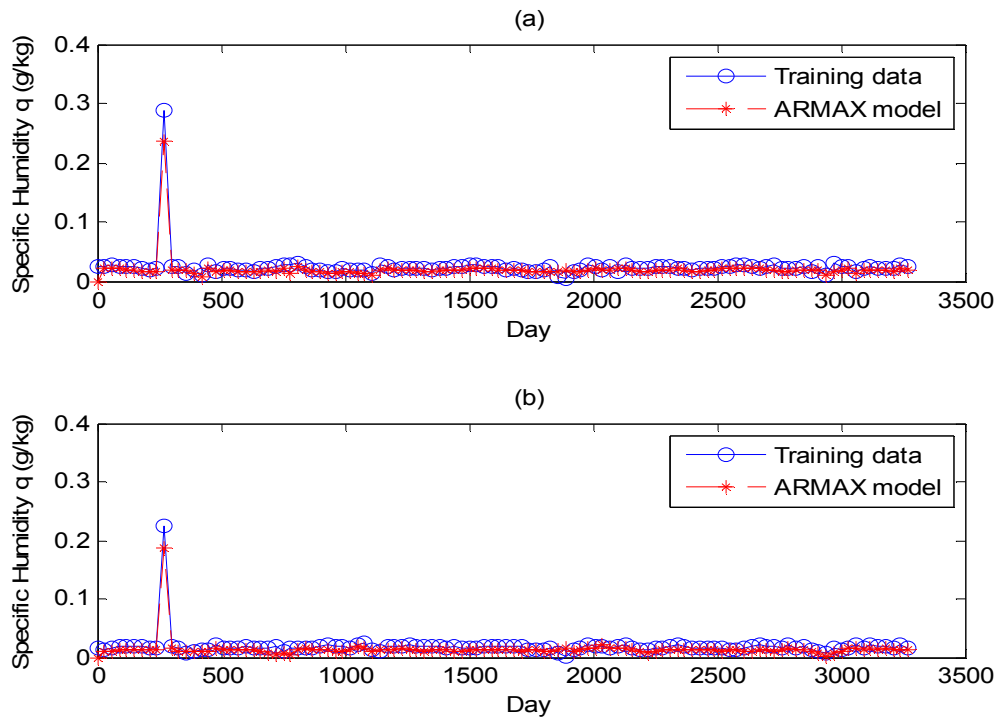

Figure 16: ARMAX model training result for the specific humidity data at (a) 09:00 Hour (b) 15:00 Hour for Ibadan , a Guinea Savannah station.

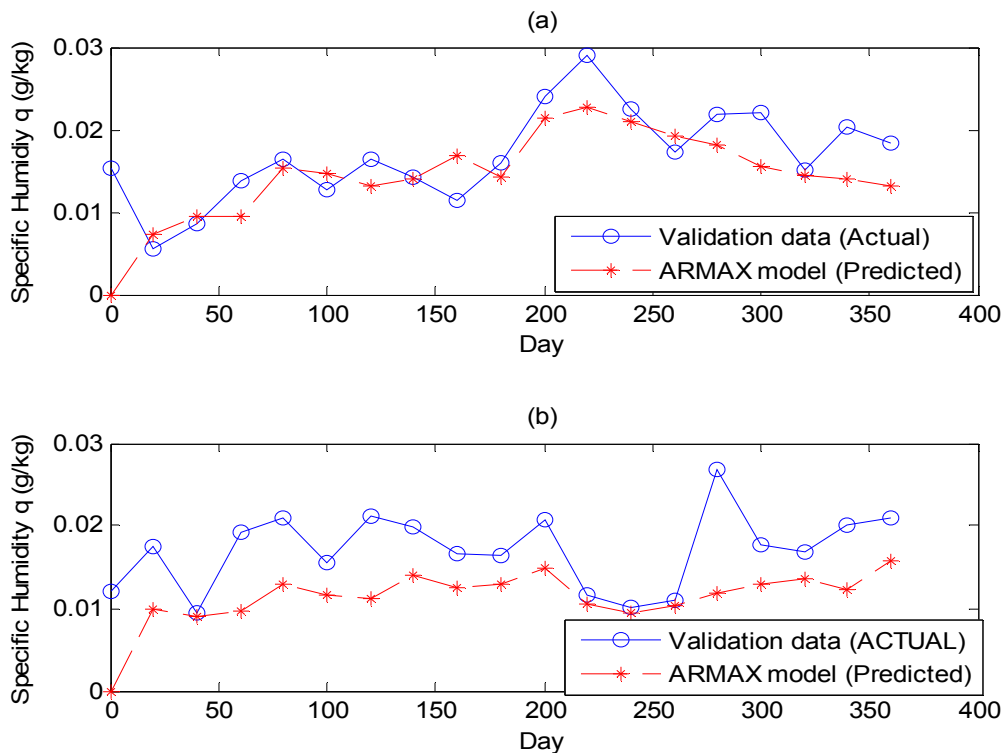

Figure 17: ARMAX model validation result for the specific humidity data at (a) 09:00 Hour (b) 15:00 Hour for Ibadan , a Guinea Savannah station.

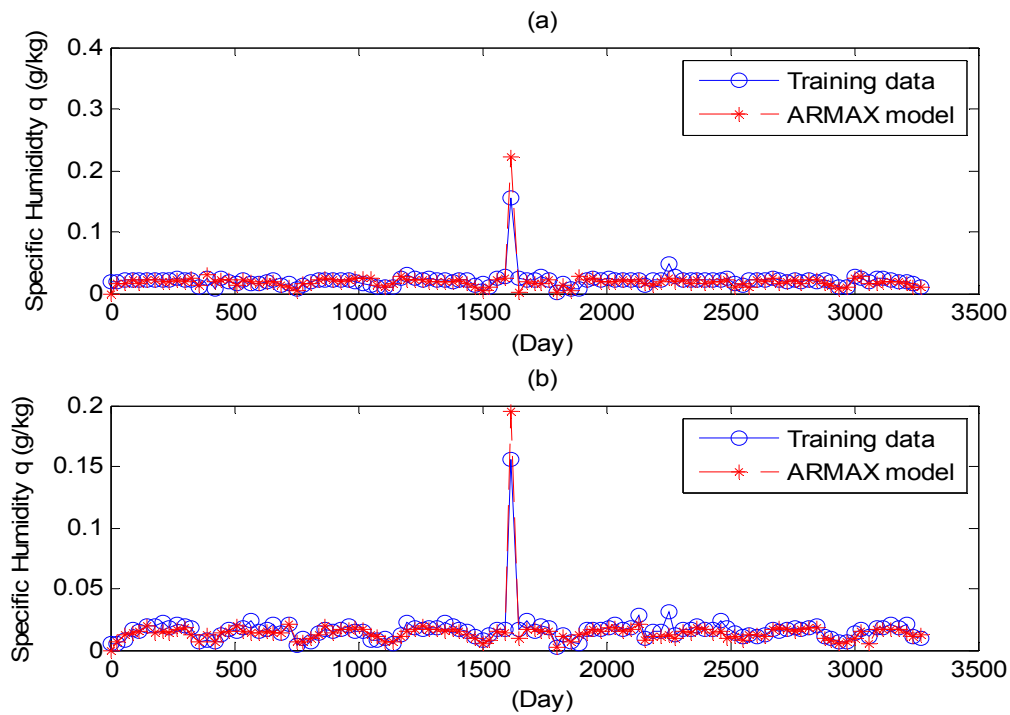

Figure 18: ARMAX model training result for the specific humidity data at (a) 09:00 Hour (b) 15:00 Hour for Abuja, a Mid-land station.

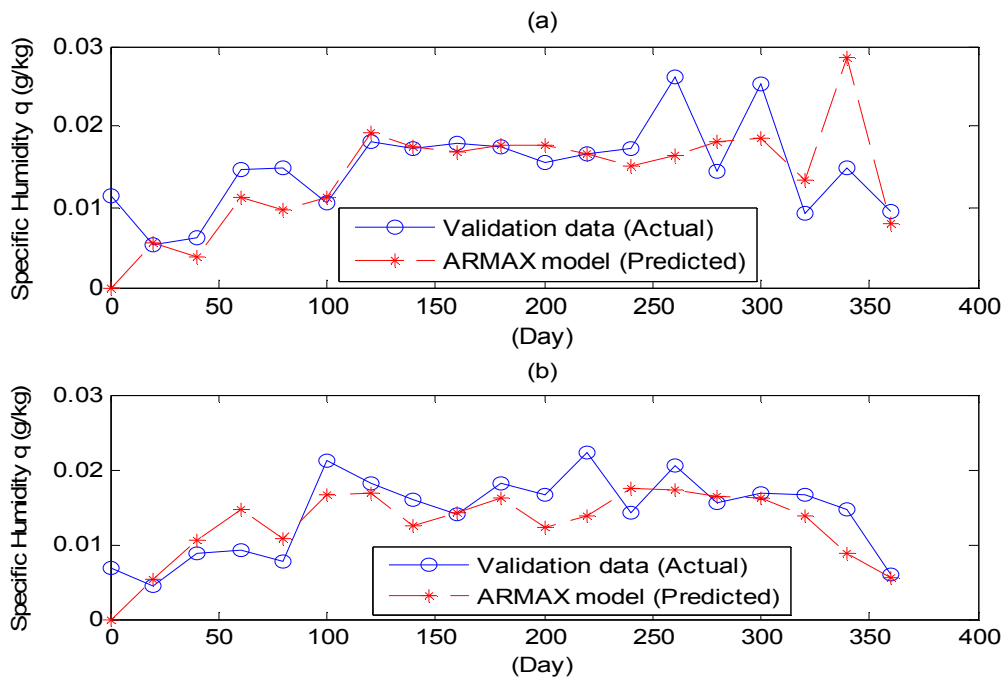

Figure 19: ARMAX model validation result for the specific humidity data at (a) 09:00 Hour (b) 15:00 Hour for Abuja, a Mid-land station.

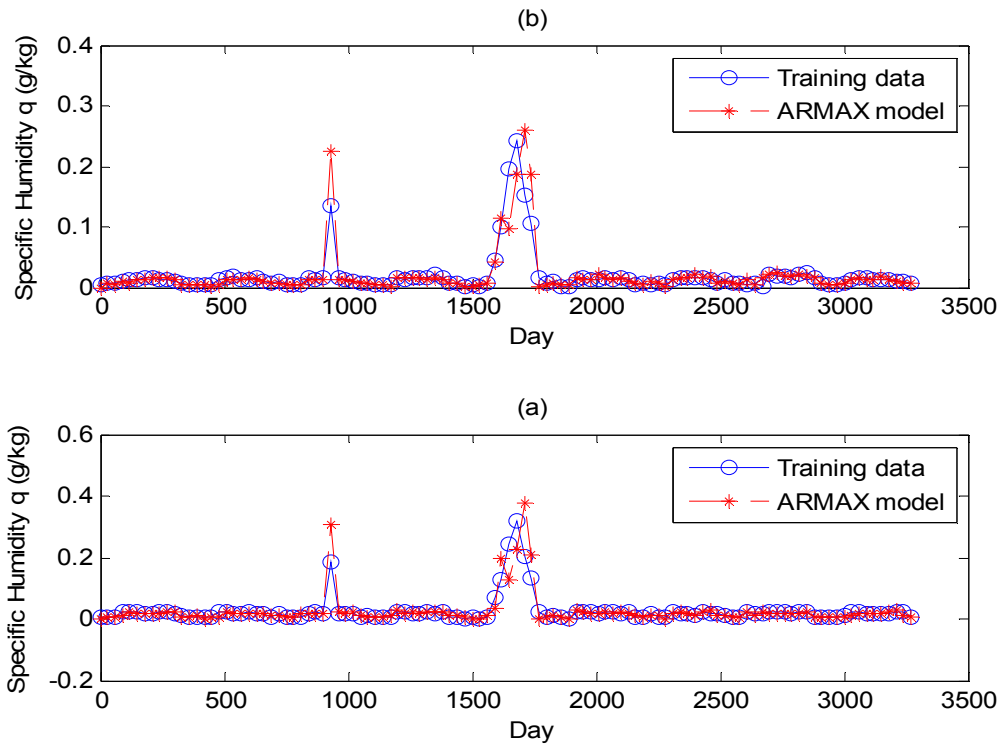

Figure 20: ARMAX model training result for the specific humidity data at (a) 09:00 Hour (b) 15:00 Hour for Kaduna , a Sahel station.

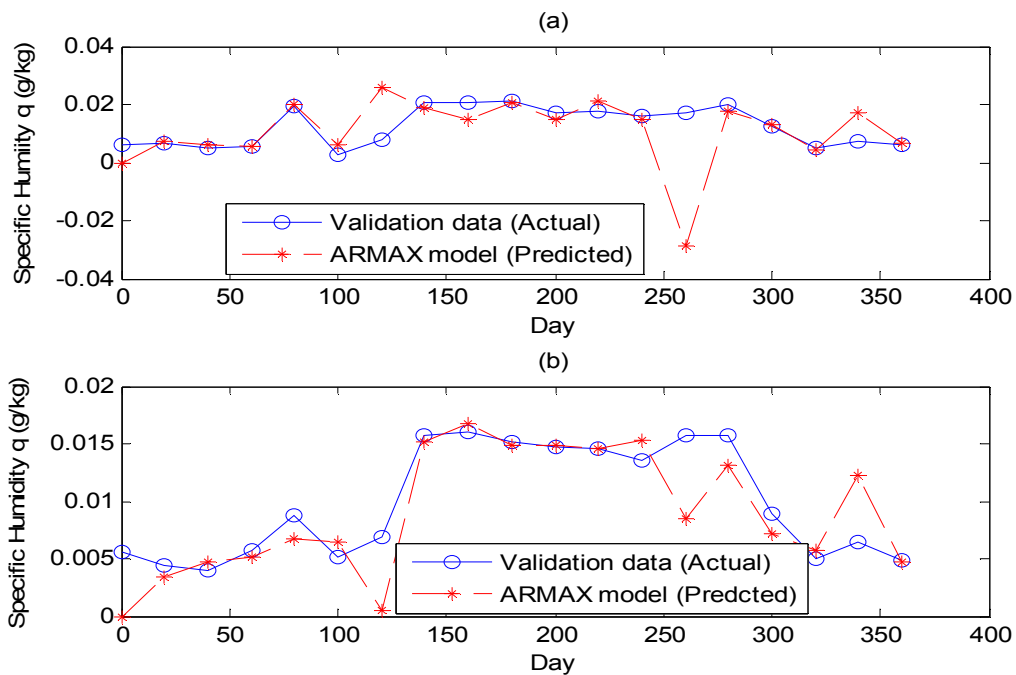

Figure 21: ARMAX model validation result for the specific humidity data at (a) 09:00 Hour (b) 15:00 Hour for Kaduna , a Sahel station.