

A Review on Development of RFID and Mobile Application Based Attendance Management System.

Joseph Sospeter, Ramadhan S Sinde, Shubi Kaijage
 School of Computational and Communication Science and Engineering,
 Nelson Mandela African Institute of Science and Technology, P.O Box 447, Arusha, Tanzania

Abstract

Mobile application development and RFID technologies are becoming popular in different applications. Mobile phone technology has continued to evolve in terms of computation power, speed, memory capacity and screen size. Many mobile applications for different activities especially on the Android platform as the free software are being developed. On the other hand, RFID technology is becoming the popular technology in tracking and detecting objects for the purpose of locating and ensuring security of movable equipments. This paper discusses different systems proposed for attendance management using different technologies. Based on this discussion a new approach for attendance management is proposed to be used specifically for ordinary level schools

Keywords: RFID, Radio Frequency Identification, Attendance management system, Android Mobile application, Secondary Schools.

1. INTRODUCTION

Attendance management of students or employees is one of the functions performed by the management. In respect to Education, students and teachers class attendance is the key factor for academic performance of students. Successful schools begin by make sure their students come to school regularly. The consequences of low attendance are serious and not just affect the students who miss school but also affect the community[1]. Academic performance of students in ordinary level schools in Tanzania is highly affected by persistent truancy of students. Figure 1 below shows that, about 80% of students' dropout is due to Truancy.

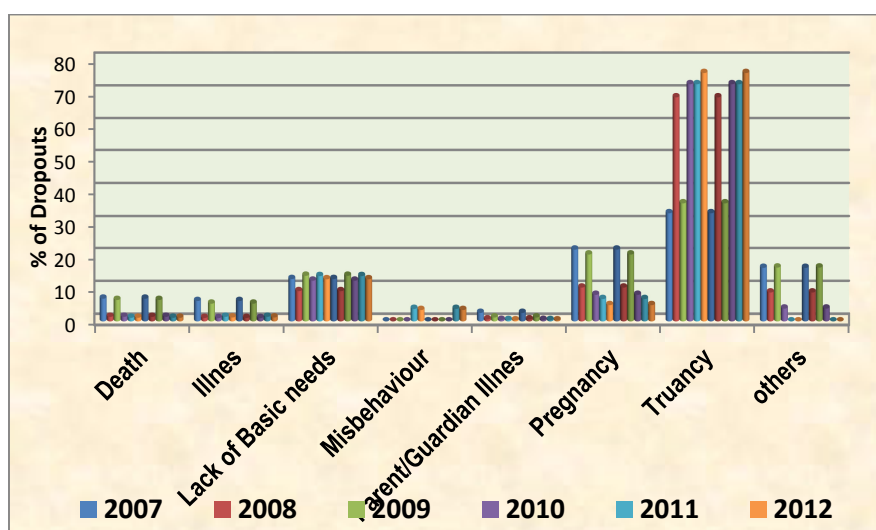

Figure 1: Percentage Dropout in Government and Non-Government Secondary Schools by 2012 in Tanzania[2]

Currently, the attendance of both students and employees is being recorded manually using attendance registers. Manual way of taking students and employees' attendance using attendance registers suffers many problems in spite of being slow and error prone, it is prone to misplacement of registers which may lead to high search time and sometimes loss of attendance information.

2. REVIEW OF DIFFERENT ATTENDANCE MANAGEMENT SYSTEMS

Student is the largest union in the study environment so it is hard for managing student things especially in the respect of student class attendance, the original named style is hard to response the really situation of student attendance[3]. Many researchers have tried to find the optimal solution on counteracting attendance recording challenges in Education systems and companies. A fair review of different technologies proposed for attendance management is presented below.

2.1. Web Based Systems

Apandi S.H et al[1] proposed the development of the web based attendance management system (AMS) in which the class teachers records students attendance to the server online. The server generates attendance related SMS and send to the student’s parents or guardians. Figure 2 below shows the flow chart of the web based attendance management system proposed by Apandi S.H et al.

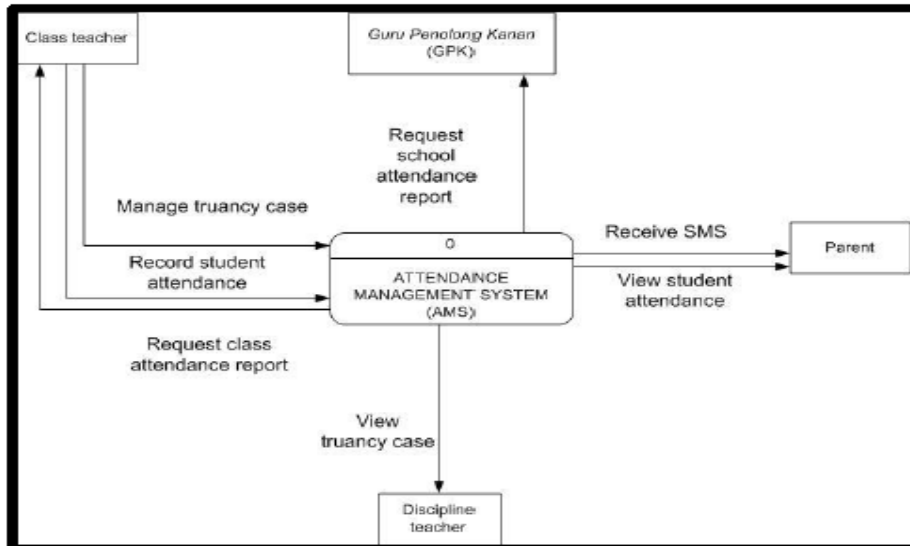

Figure 2: Flow chart for the web based attendance management system[1]

However, the major limitation of the system is to get the data from the customer / client[1]. Also the system is limited to the place with internet connectivity which is not the case for most of ordinary level schools in Tanzania.

Another research conducted by Patel R et al [4] proposed the development of Online Students’ Attendance Monitoring System in Classroom Using Radio Frequency Identification. In this system, RFID readers are to be installed per each classroom and then connected to the institutional Local Area Network (LAN). Student identity cards are embedded with RFID tags for identification. Figure 3 below shows the web based attendance management system proposed by Patel R et al.

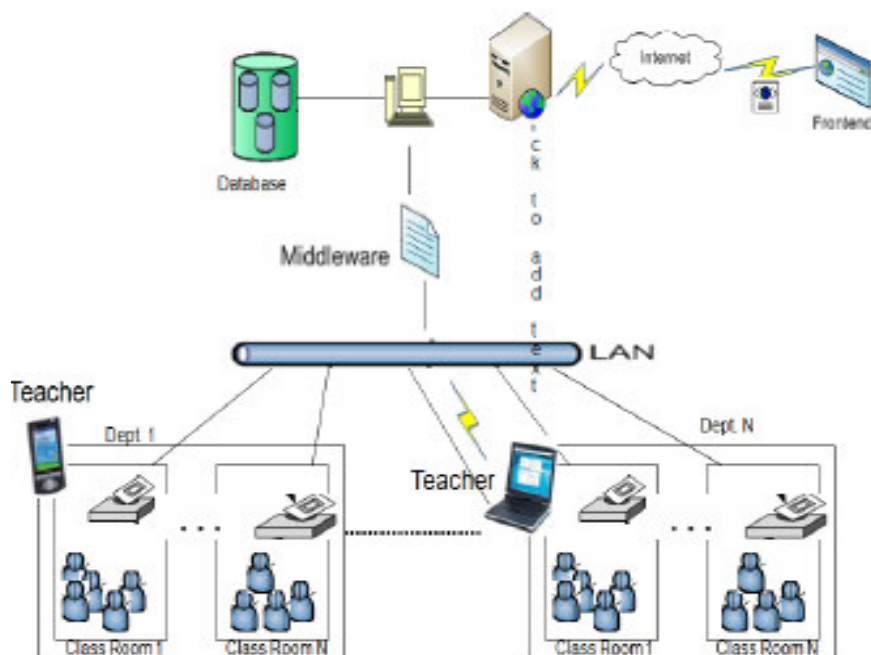

Figure 3: Web based attendance management system[4]

Another system proposed by Mohamed A. A et al [5] in which a Web-Server based Student Attendance System

using RFID Technology was developed. In this system also the attendance is recorded using RFID technology and stored to the online database. Another system proposed by Agrawal A [6] where an Online Attendance Management System Using RFID with Object Counter was developed.

The major limitation of web based system is the requirement of internet connectivity for storing attendance information in the database. For ordinary schools in Tanzania, it is not practical to implement web based system due lack of reliable Electricity and internet connectivity.

2.2. RFID Based Systems

Chiagozie O.G et al [7] proposed the development of Radio Frequency identification (RFID) based attendance system with automatic door unit in which the student attendance is captured using RFID technology. The student is required to show up the Tagged ID to the RFID reader, when the legitimacy of the student is verified, the system open the door and record the attendance.

Another related work was done by Unnati A. Patel in which a Student Management System based on RFID Technology was proposed [8]. In this system, student attendance is captured using RFID technology and stored to the back end database connected to the RFID readers. Figure 4 below shows the component diagram of the RFID based attendance management system proposed by Unnati A.P et al.

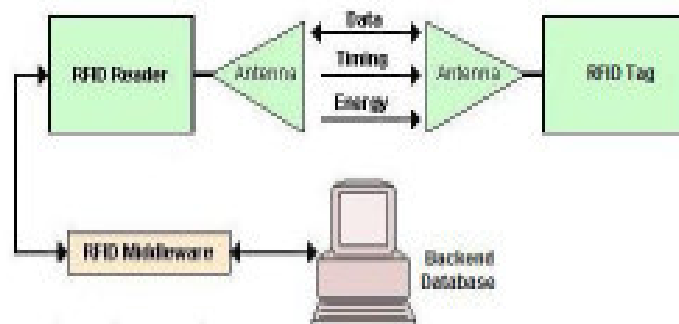

Figure 4: RFID based attendance management system [8]

Another related work was done by Nainan. S et al where an RFID Technology Based Attendance Management System[9] was proposed. In this system also the student attendance is captured using RFID technology and stored in the back end database for further processing.

Another similar work was done by Arulogun O. T et al where the RFID-Based Students Attendance Management System[10] was developed. In this system, in addition to recording student's attendance to the database using RFID system, the system has an added functionality of generating and sending an SMS to different stakeholders such as parents via SMS gateway or E-mail gateway. Figure 5 below the block diagram of the RFID based attendance management system proposed by Arulogun O.T et al.

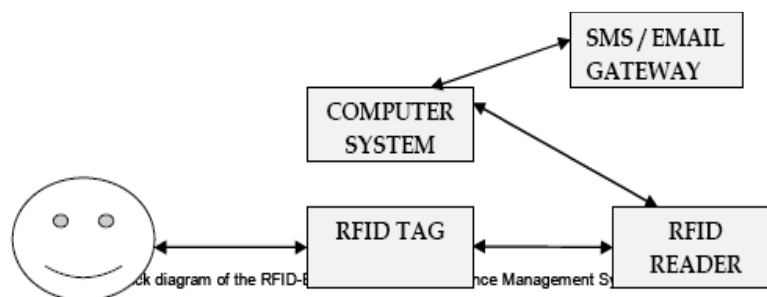

Figure 5: RFID based attendance management system[10]

The major shortcoming of is this system is that the systems requires full availability of electricity which is not the case in Tanzania ordinary level schools, No alternative for attendance recording for the case of electricity outage, nevertheless the system does allows cheating as students may exchange identity cards or one student may carry more than one cards of his/her friends. Also initial cost of implementation my hinder the deployment of the systems in ordinary schools.

Another related work was done by Aditi S.T et al where an Optimized Design of Student Attendance System Using RFID[11] was designed. In the system, RFID reader and tags are used to detect presence of the student with a valid tagged identity card. The detected attendance information is then transmitted by the aid of microcontroller and GPRS to the far end database where it is recorded. Figure 6 below shows the circuit diagram of the optimized attendance system using RFID.

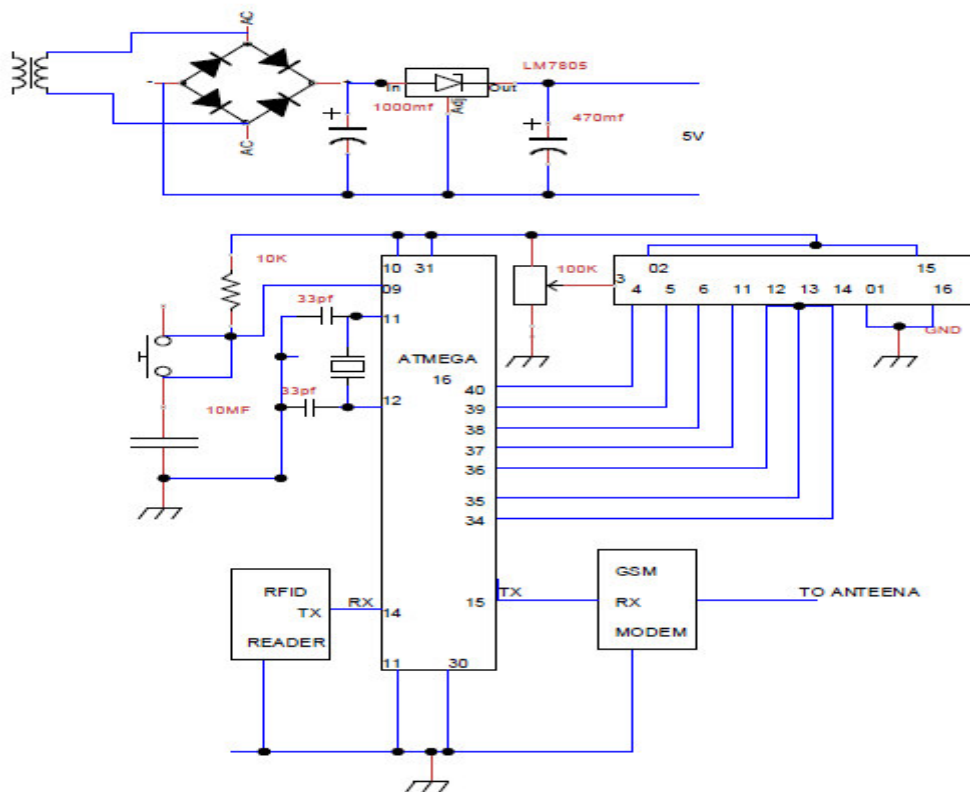

Figure 6: Circuit diagram of the optimized attendance system using RFID [11].

2.3. Biometric Based Systems

Biometric systems include those of fingerprint recognition, face recognition, iris based, voice recognition[12] etc. Shoewu .O et al as shown in figure 7 below, proposed the development of Attendance Management System using Biometrics[13]. In this system, fingerprint recognition technology was used where the system takes attendance electronically with the help of a finger print device and the records of the attendance are stored in a database [13]

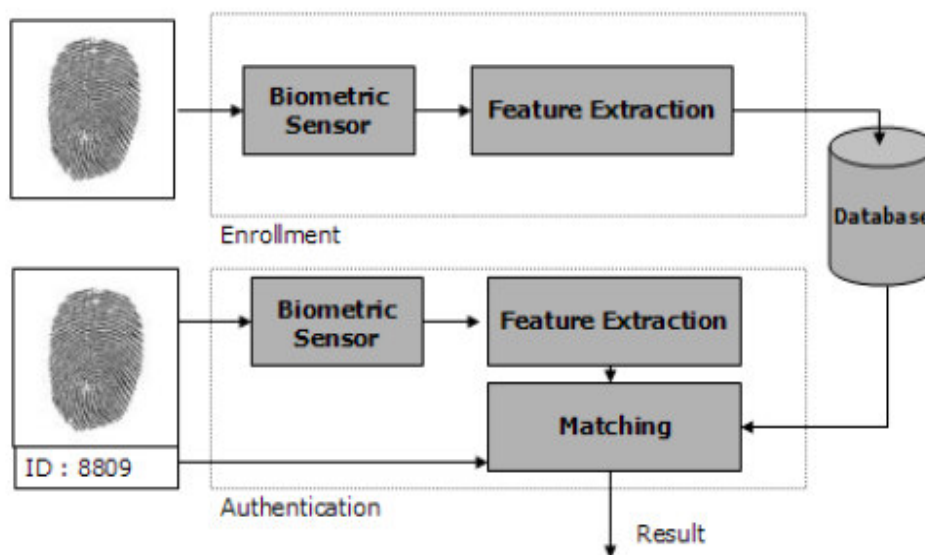

Figure 7: Biometric based attendance management system[13]

Another related work done by Akinduyite C.O et al in which Fingerprint-Based Attendance Management System was developed [14]. The problem with biometric based systems is the large execution time of average of 4.29 seconds[14]. These systems may be not suitable for places with large number of participants like schools. Suppose you have a lecture class of 1000 students, using this system, it takes 4290 seconds which is equivalent to 72 minutes (one hour and 12 minutes). Each student will need to spend some minutes in a queue for attendance registration.

Other related system includes those of barcode technology that requires every employee or student to be issued a badge/card coded with barcode. In order to check into or out of the company or school, the badge/card is swapped on the time clock, and the data is captured by the clock [14]. Table 1 below show the comparison between different auto-ID technologies

<i>System Parameters</i>	<i>Barcode</i>	<i>Voice recording</i>	<i>Biometry</i>	<i>Smart card</i>	<i>RFID</i>
<i>Data quantity</i>	<i>1-100 k</i>	-	-	<i>16-64 k</i>	<i>16-64 k</i>
<i>Data density</i>	<i>Low</i>	<i>High</i>	<i>High</i>	<i>Very High</i>	<i>Very High</i>
<i>Machine readability</i>	<i>Good</i>	<i>Expensive</i>	<i>Expensive</i>	<i>Good</i>	<i>Good</i>
<i>Readability by people</i>	<i>Limited</i>	<i>Simple</i>	<i>Difficult</i>	<i>Impossible</i>	<i>Impossible</i>
<i>Influence of dirt/damp</i>	<i>Very high</i>	-	-	<i>Possible</i>	<i>No influence</i>
<i>Influence of (opt.) covering</i>	<i>Total failure</i>	-	<i>Possible</i>	-	<i>No influence</i>
<i>Influence of direction and position</i>	<i>Low</i>	-	-	<i>Uni-directional</i>	<i>No influence</i>
<i>Degradation/wear</i>	<i>Limited</i>	-	-	<i>Contacts</i>	<i>No influence</i>
<i>Purchase cost/reading electronics</i>	<i>Very low</i>	<i>Very high</i>	<i>Very high</i>	<i>Low</i>	<i>Medium</i>
<i>Operating costs</i>	<i>Low</i>	<i>None</i>	<i>None</i>	<i>Medium</i>	<i>None</i>
	<i>Slight</i>	<i>Possible (audio tape)</i>	<i>Impossible</i>	<i>Impossible</i>	<i>Impossible</i>
<i>Reading speed (including handling of data carrier)</i>	<i>Low ~4 s</i>	<i>Very low > 5s</i>	<i>Very low > 5-10 s</i>	<i>Low ~4 s</i>	<i>Very fast ~0.5s</i>
<i>Maximum distance between data carrier and reader</i>	<i>0-50 cm</i>	<i>0-50 cm</i>	<i>Direct contact</i>	<i>Direct contact</i>	<i>0-5-m, microwave</i>

Table 1: Comparison of different auto-ID Technologies[11]

3. PROPOSED SYSTEM

Most of the attendance management systems developed are developed with the aim of targeting high learning institutions and companies as many of them assume the full availability of internet connectivity, electricity and enough funds for deployment. In most of the Ordinary Schools especially in Africa, Electricity parse is the problem to most of ordinary schools. The proposed system consists of RFID part and Mobile application part as can be seen from figure 7. The RFID part is intended for capturing student attendance and recording in the back end database. The mobile application part is intended for communicating student attendance information to parents/guardians. The mobile application part is also intended to be used as a backup for attendance recording in case there is no electricity or no enough funds to deploy the RFID part.

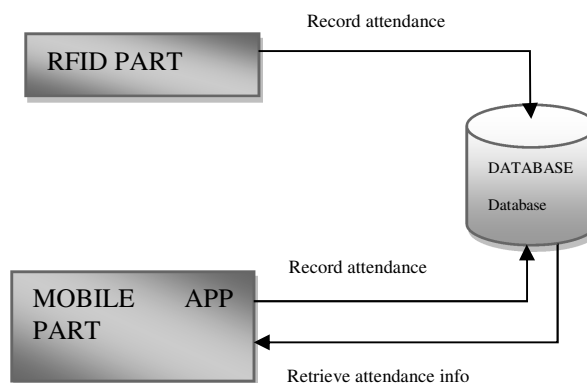

Figure 7: Topology of the proposed system.

4. CONCLUSION

We have presented a review of different technologies which are used for attendance recording and management. Currently in ordinary schools in Tanzania, student attendance is taken manually by class masters using attendance register. This process costs much of time and is error prone. Too much proxy attendance can be recorded in manual system. However, computerized system and RFID will be used to take auto attendance for all

the students entered in the class and therefore eliminate the time loss of class teachers. On the other hand mobile application will communicate attendance information to parents/guardians and can be used for attendance recording in case there is no electricity or RFID part not installed or not working.

5. REFERENCES

- [1] S. H. Apandi, "Development of Attendance Management System: An Experience," 2012.
- [2] D. S. Kawambwa, "BEST 2012 NATIONAL DATA," Education, Ed., ed: Ministry of Education Tanzania, 2012.
- [3] Z. Yuru, "The Design and Research of Student Attendance System Nodes Based on RFID," *International Journal of Control and Automation*, vol. 6, p. 9, 2013.
- [4] R. Patel, "Online Students' Attendance Monitoring System in Classroom Using Radio Frequency Identification," *International Journal of Emerging Technology and Advanced Engineering*, pp. 61-66, 2012.
- [5] A. A. Mohammed, "Web-Server based Student Attendance System using RFID Technology," *International Journal of Engineering Trends and Technology (IJETT)*, vol. 4, p. 4, 2013.
- [6] A. Agrawal, "Online Attendance Management System Using RFID with Object Counter," *International Journal of Information and Computation Technology*, pp. 131-138, 2013.
- [7] O. G. Chiagozie, "RADIO FREQUENCY IDENTIFICATION (RFID) BASED ATTENDANCE SYSTEM WITH AUTOMATIC DOOR UNIT," *Academic Research International*, vol. 2, p. 15, 2012.
- [8] U. A. Patel, "Student Management System based on RFID Technology," *International Journal of Emerging Trends & Technology in Computer Science (IJETTCS)*, vol. 2, p. 6, 2013.
- [9] S. Nainan, "RFID Technology Based Attendance Management System.," *IJCSI International Journal of Computer Science Issues.*, vol. 10, p. 6, 2013.
- [10] O. Arulogun O. T., A, "RFID-Based Students Attendance Management System," *International Journal of Scientific & Engineering Research* vol. 4, p. 9, 2013.
- [11] A. S. Tiwari, "Optimized Design of Student Attendance System Using RFID," *International Conference on Machine Learning, Electrical and Mechanical Engineering (ICMLEME'2014) Jan. 8-9, 2014 Dubai (UAE)*, p. 6, 8 2014.
- [12] U. A. Patel, "Development of a Student Attendance Management System Using RFID and Face Recognition: A Review," *International Journal of Advance Research in Computer Science and Management Studies*, vol. 2, p. 11, 2014.
- [13] O. Shoewu, "Development of Attendance Management System using Biometrics," *The Pacific Journal of Science and Technology*, vol. 13, p. 8, 2012.
- [14] A. C.O, "Fingerprint-Based Attendance Management System," *Journal of Computer Sciences and Applications, 2013, Vol. 1, No. 5, 100-105*, vol. 1, p. 6, 2013.

The IISTE is a pioneer in the Open-Access hosting service and academic event management. The aim of the firm is Accelerating Global Knowledge Sharing.

More information about the firm can be found on the homepage:

<http://www.iiste.org>

CALL FOR JOURNAL PAPERS

There are more than 30 peer-reviewed academic journals hosted under the hosting platform.

Prospective authors of journals can find the submission instruction on the following page: <http://www.iiste.org/journals/> All the journals articles are available online to the readers all over the world without financial, legal, or technical barriers other than those inseparable from gaining access to the internet itself. Paper version of the journals is also available upon request of readers and authors.

MORE RESOURCES

Book publication information: <http://www.iiste.org/book/>

Academic conference: <http://www.iiste.org/conference/upcoming-conferences-call-for-paper/>

IISTE Knowledge Sharing Partners

EBSCO, Index Copernicus, Ulrich's Periodicals Directory, JournalTOCS, PKP Open Archives Harvester, Bielefeld Academic Search Engine, Elektronische Zeitschriftenbibliothek EZB, Open J-Gate, OCLC WorldCat, Universe Digital Library, NewJour, Google Scholar

