

# Application of Optimal Control to the Epidemiology of Dengue Fever Transmission

Okey Oseloka Onyejekwe\* Ayalnesh Tigabie Shiferaw

Computational Science Program, Addis Ababa University, Arat Kilo Campass, Addis Ababa, Ethiopia

## Abstract

In this paper, we build an epidemiological model to investigate the dynamics of spread of dengue fever in human population. We apply optimal control theory to a simple SEIRS disease model of dengue fever transmission dynamics. Controls representing education and drug therapy treatment are incorporated to reduce the latently infected and actively infected individual populations, via application of the Pontryagins Minimum Principle of optimal control theory. Our overall aim is to minimize the spread of the disease in the population, and at the same time control the efforts required for education and treatment roll-out. Based on these, we carry out optimization using an SEIRS model, and in the process demonstrate how optimal strategies can be implemented towards minimizing the damage caused by the dengue fever disease.

**Keywords:** epidemiological model, SEIRS, dengue fever, optimal control, Pontryagins Minimum Principle, fourth-order Runge-Kutta

## 1. Introduction

Dengue fever is a painful, debilitating mosquito-borne disease caused by one of the four closely related dengue viruses (Noorani & et al 2012). It is transmitted by the bite of an infected *Aedes* mosquito. Until now, more than 100 million cases of dengue fever occur worldwide in the Indian subcontinent, Southeast Asia, Southern China, Taiwan, The Pacific Islands, The Caribbean, Mexico, Africa, Central and South America, Southern United States, and Southern Australia. In Indonesia, dengue cases increase yearly in almost all regions (WHO 2009). The virus can be spread partly due to an increase in urbanization and also by climate change. As a result of serious damage resulting from the effects of dengue fever spread, all over the world, an effective control strategy is vital. A very important aspect of the strategy related to dengue fever spreading is quick and effective action (WHO2009).

Dengue hemorrhagic fever (DHF) is a more severe form of dengue infection. It can be fatal if unrecognized and not properly treated in a timely manner. However it has been shown that with good medical management, mortality due to DHF can be less than 1% (Buletin2010). The virus circulates in the blood of an infected person for 2-7 days, at approximately the same time that the person develops a fever. Patients who are already infected with the dengue virus can transmit the infection via the *Aedes* mosquito just after the first symptoms appear (during 4-5 days; maximum 12). Hence, in order to devise effective means of control, it is important to understand the epidemiology of dengue fever transmission. The disease can be transmitted more than once because of four different but related strains of dengue virus. As a result, if a person has suffered from one virus, there can be a repeat occurrence if a different strain is subsequently involved. It has been observed that, many who suffer repeat infections have it worse. They come down with dengue hemorrhagic fever and suffer massive internal bleeding and possible liver damage. As previously noted, the virus causing dengue fever comes in four strains, and immunity to one seems to make infection by a second strain more dangerous

When the incidence of a dengue disease starts to increase in any population, people start to look for methods that are best to combat the outbreak or at least control the number of infections (Laurencia & et al. 2015). Experiments for producing and testing those control measures, such as education, antiviral drugs, are costly and time consuming, so any tool that will enable us to predict the outcome is highly valuable. Mathematical models are a powerful tool for investigating dengue fever diseases (Lungu et al 2007). They provide useful predictions about the potential transmission of a disease and the effectiveness of possible control measures. Many infectious diseases are spread by biting insects and ticks or other organisms, collectively known as vectors, which transfer pathogens between humans or other animals. The emergence or reemergence of such vector-borne diseases seems especially to have stimulated recent interest. Epidemiology has become an important issue for modern society. The relationship between mathematics and epidemiology has been increasing. For the mathematician, epidemiology provides new and exciting branches, while for the epidemiologist; mathematical modeling offers an important research tool in the study of the evolution of diseases. In 1760, a smallpox model was proposed (Daniel Bernoulli 1760) and is considered by many authors the first epidemiological mathematical model. Theoretical papers by (Kermack and McKendrick, 1911) between 1927 and 1933 about infectious disease models, have had a great influence in the development of mathematical epidemiology models (James 2002). Most of the basic theory had been developed during that time. Mathematical models are being increasingly used to elucidate the transmission of several diseases. These models, usually based on compartment models, may be rather simple, but studying them is crucial in gaining

important knowledge of the underlying aspects of the dengue fever diseases spread out (Hindmarsh & et al. 2005), and to evaluate the potential impact of control programs in reducing morbidity and mortality. After the Second World War, the strategy of public health has been focusing on the control and elimination of the organisms that cause the diseases. The appearance of new antibiotics and vaccines brought a positive perspective of the disease eradication. However, factors such as resistance to the medicine by the micro organisms, demographic evolution, accelerated urbanization, increased travelling and climate change, led to new diseases and the resurgence of old ones. In 1981, the human immune deficiency virus (HIV) appeared and since then, became as important sexually transmitted disease throughout the world. Furthermore, malaria, tuberculosis, dengue and yellow fever have re-emerged and, as a result of climate changes, have been spreading into new regions (Helena & Teresa 2012). Recent years have seen an increasing trend in the representation of mathematical models in publications in the epidemiological literature, from specialist journals of medicine, biology and mathematics to the highest impact generalist journals, showing the importance of interdisciplinary approaches in the study of diseases. Their role in comparing, planning, implementing and evaluating various control programs is of major importance for public health decision makers. The optimal control definition and its possible formulations are introduced, followed by SEIRS epidemiological models. The Pontryagin Minimum Principle is presented with the aim of finding the best control policy. The system of equations consists of human population compartments. The numerical method used to solve the system is the fourth-order Runge-Kutta method.

## 2. Dengue Fever Transmission Model with Education

Quantitative methods are often applied to achieve optimization of investments in the control of disease. This is necessary in order to obtain maximum benefits from a fixed amount of financial resources. In this case, our efforts will be directed towards the dynamics of the aedes mosquito vector as well as some management protocols aimed at controlling or alleviating the spread of dengue fever. Such management principles involving the termination of the reproduction cycle of mosquitoes by avoiding the accumulation of still water in open-air recipients and spraying potential zones of reproduction are of vital importance as well as educating the local population on issues related to basic hygiene through the television (TV) and radio.

### 2.1. Model Assumptions and mathematical formulation

1. The population is uniform and mixes homogeneously. The total population size,  $N(t) = S(t) + E(t) + I(t) + R(t)$  at any time  $t > 0$ , where  $N$  stands for the total population,  $E$  for exposed,  $I$  for infected,  $S$  for susceptible and  $R$  for recovered.
2. The natural birth rate  $b$  and death rates  $\mu_n$  are assumed to be different.
3. Each individual in the population is considered as having an equal probability of contacting the disease with a contact rate  $\beta$ .
4. An infected individual makes contact and is able to transmit the disease with  $\beta N$  per unit time, that is, the contact rate is proportional to the total population size.
5. The fraction of contacts by an infected with a susceptible is  $S/N$ . Therefore the number of new infections in unit time per infective becomes  $(\beta N)(S/N)$ . This rate is called an infection rate. This gives the rate of new infections or those leaving the susceptible category as  $(\beta N)(S/N)I = \beta SI$ , which is called an incidence of the disease. This type of incidence is called bilinear incidence i.e., proportional to the product of the number of infective individuals and the number of susceptible individuals.
6. The number of infected individuals move from the exposed compartment per unit time is  $\delta E$  at time  $t$ .
7. The exposed  $E$  move from their compartment to  $I$ -compartment at a constant rate  $\delta$ , so that  $1/\delta$  is the mean latent period.
8. The infectious  $I$  move from their compartment to  $R$ -compartment at a constant rate  $\gamma$ , so that  $1/\gamma$  is the mean infectious period.
9. The rate of susceptible, exposed, infected and recovered individual removed from each compartments through natural death and disease induced death are  $\mu_n S$ ,  $\mu_n E$ ,  $\mu_n I$ ,  $\mu_n R$  and  $\mu_d I$  respectively.
10. The recovered individual  $R$  move from their compartment to susceptible( $S$ )-compartment at a constant rate  $\alpha$ ,

An optimal control problem is formulated by incorporating one of the intervention strategies into our basic mathematical model (equation(1)).

- $u(t)$  is the control which represents the education ratio of susceptible individuals being educated per unit of time with bounds between 0 and 1.
- The inflow of population to the susceptible class is obtained, by combining assumptions 2, 5, 9, 10 and control (education).
- A number of individuals leaves  $S$  and enter  $E$ , at the same time, a fraction of exposed  $E$  moves to infectious group  $I$  with a latent rate  $\delta$ .  $\delta E$  represents an individual's move from exposed to infectious. Some of the exposed group die through natural death rate  $\mu_n$ ,  $\mu_n E$  represents movement from exposed

- to death.
- Some individuals leave E and enter into the infected individuals I with latent rate  $\delta$ .
- A part of the population leaves I and enter the recovered group with recovery rate  $\gamma$ . Combination of assumptions 2, 5, 9, 10 in addition to the control  $u$ , gives the rate of recovered.

The differential equation from the assumptions and Fig. 1 for  $t \geq 0$  can be represented by a system of ordinary differential equation :

$$\begin{aligned} \frac{dS}{dt} &= b - \beta IS - \mu_n S - uS + \alpha R \\ \frac{dE}{dt} &= \beta IS - \mu_n E - \delta E \\ \frac{dI}{dt} &= \delta E - (\mu_n + \mu_d + \gamma)I \\ \frac{dR}{dt} &= \gamma I - (\mu_n + \alpha)R + uS \end{aligned} \tag{1}$$

An optimal control strategy aimed at minimizing the objective (cost) functional  $J$  of the cost of education for a susceptible population is given as:

$$\text{Min } J(u) = \int_0^T (AI + \frac{1}{2}Bu^2)dt$$

Subject to:

$$\begin{aligned} \frac{dS}{dt} &= b - \beta IS - \mu_n S - uS + \alpha R \\ \frac{dE}{dt} &= \beta IS - \mu_n E - \delta E \\ \frac{dI}{dt} &= \delta E - (\mu_n + \mu_d + \gamma)I \\ \frac{dR}{dt} &= \gamma I - (\mu_n + \alpha)R + uS \end{aligned} \tag{2}$$

$$S(0) = S_0 \geq 0, E(0) = E_0 \geq 0, I(0) = I_0 \geq 0, R(0) = R_0 \geq 0$$

where,  $A$  is balancing cost factor due to the infective and  $B$  is the weight on the cost of education. Fig. 1 is a compartmentalized representation of the mathematical formulation and optimization strategy for education.

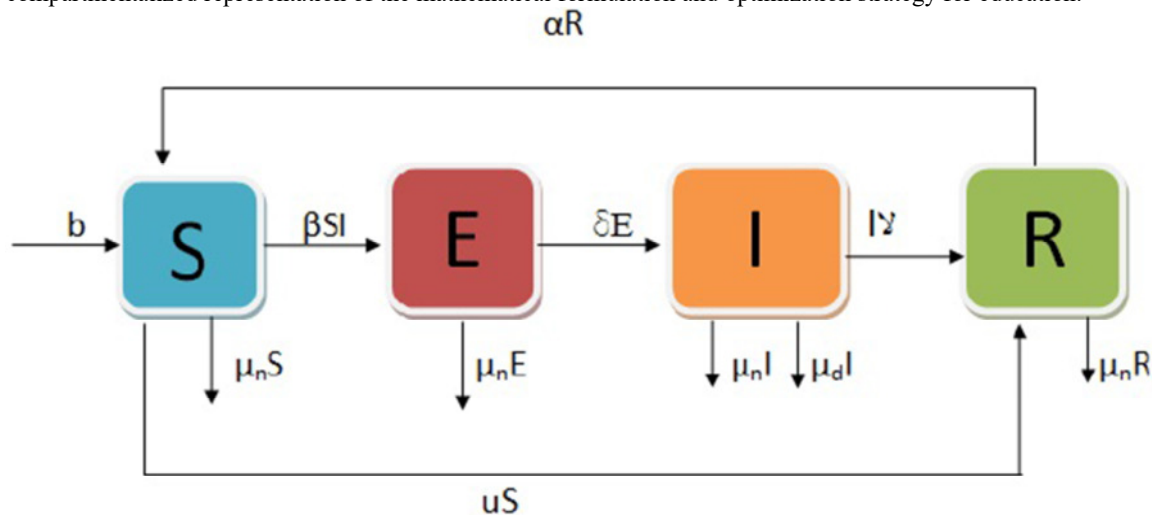

Figure 1: SEIRS model with Education

### 3. Combination of Education and Treatment by Drug therapy

Antiviral drugs are known to be very helpful in decreasing or preventing disease symptoms at the first sign of a dengue outbreak even when there is no evidence of fever. Before we incorporate drug therapy as part of our

treatment protocol and control measures. We will now deal with how the application of drug therapy affects some of the model compartments.

- Consider control variables  $u_1$ ,  $u_1E$  as representing an individual's move from exposed to recovered. The exposed populations change per unit of time becomes,

$$\frac{dE}{dt} = \beta IS - \mu_n E - \delta E - u_1 E \quad (3)$$

- In addition, a number of individuals leaves the infected group I and enter the recovered group with recovery rate  $\gamma$ . A number of individuals also leave the susceptible and exposed groups S and E to enter the recovered group with controls u and  $u_1$  respectively. This gives rate of recovered as :

$$\frac{dR}{dt} = \gamma I - (\mu_n + \alpha)R + uS + u_1 E \quad (4)$$

The differential equation of the diagram for  $t \geq 0$  is given in a system of ordinary differential equation. Introducing the controls representing the education and drug therapy treatment the model of eq(1) becomes

$$\begin{aligned} \frac{dS}{dt} &= b - \beta IS - \mu_n S + \alpha R - uS \\ \frac{dE}{dt} &= \beta IS - \mu_n E - \delta E - u_1 E \\ \frac{dI}{dt} &= \delta E - (\mu_n + \mu_d + \gamma)I \\ \frac{dR}{dt} &= \gamma I - (\mu_n + \alpha)R + uS + u_1 E \end{aligned} \quad (5)$$

Where,  $S(0)$ ,  $E(0)$ ,  $I(0)$ ,  $R(0)$  are the initial conditions. The definitions of above model parameters are listed in Table 1. The control functions,  $u(t)$  and  $u_1(t)$  are bounded, Lebesgue integrable functions (Lebesgue 2015). The control,  $u_1(t)$ , represents the effort on drug therapy treatment of latently infected individuals to reduce the number of individuals that may be infectious. While the control  $u(t)$  is the effort on education of susceptible individuals to increase the number of recovered individuals.

A is balancing cost factor due to the infective, B and  $B_1$  are the weight on the cost of education and drug respectively. Fig. 2 is the overall representation of the model formulation.

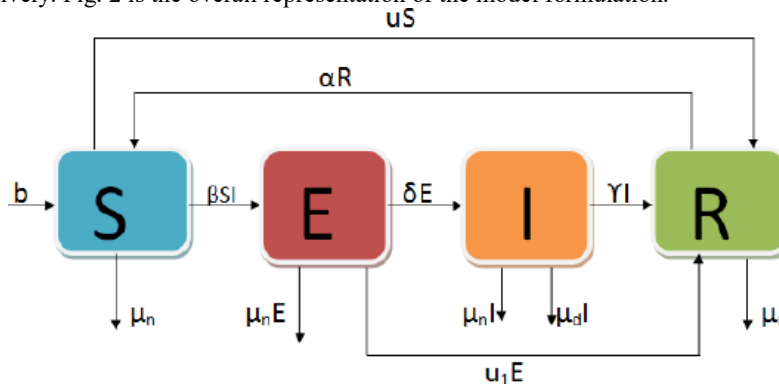

Figure 2: SEIRS model with control

Table 1: Value of variables and parameters

Symbols	Description	Value	reference
$\mu_n$	Natural death rate	1/(71*365) per year	(Helena 2012)
$\beta$	Contact rate	0.375 per year	
b	Average birth rate	1/(71*365) per year	
$\mu_d$	Disease related death rate	1/11 per year	Assumption
$\delta$	Exposed rate	1/4 per year	(Helena 2012)
$\gamma$	Recovery rate	1/3 per year	
$\alpha$	Recovering rate of remove disease to Susceptible	0.00008 per year	Assumption
A	Balancing cost factor due to the infective	100	(Esayas 2015)
B	The weight on the cost of education	0.04	
$B_1$	The weight on the cost of treatment	0.06	Assumption

The control problem involves that in which the number of individuals with latent and active dengue fever infections and the cost of applying education and drug therapy treatment controls  $u(t)$  and  $u_1(t)$  are minimized subject to the differential equations (6). This performance specification involves the numbers of individuals with latent and susceptible respectively, as well as the cost for applying education control ( $u$ ) and drug therapy treatment control ( $u_1$ ), in individuals with dengue fever. The objective functional is defined as:

$$J(u, u_1) = \min[u, u_1] \int_0^T (AI + \frac{1}{2}(Bu^2 + B_1u_1^2))dt \quad (6)$$

Where T is the final time and the coefficients, A, B, B<sub>1</sub> are balancing cost factors due to scales and importance of the three parts of the objective function. To find an optimal control pair, u and u<sub>1</sub>, such that

$$J(u, u_1) = \min J(u, u_1) | u, u_1 \in U \quad (7)$$

Where,  $U = \{(u(t), u_1(t)) | (u(t), u_1(t)) \text{ measurable, } a_i \leq (u(t), u_1(t)) \leq b_i, i = 1, 2, t \in [0, T]\}$  is the control set.

#### 4. Analysis of optimal Control

The necessary conditions that an optimal pair must satisfy come from the Pontryagin's Maximum Principle (Helena 2012). This principle converts (5) and (6) into a problem of minimizing point-wise a Hamiltonian H, with respect to  $(u, u_1)$ . First we formulate the Hamiltonian from the cost functional (6) and the governing dynamics (5) to obtain the optimality conditions. Pontryagin introduced the adjoint function to affix to the differential equation to the objective functional. The necessary conditions needed to solve the basic problem, the calculus of this OC problem can be followed stepwise:

**Step 1:** Formulate the Hamiltonian for the problem and by applying Pontryagin's principle to the Hamiltonian, we obtain the following results. Find optimal control  $u^*$ ,  $u_1^*$  and the corresponding solution  $S^*$ ,  $E^*$ ,  $I^*$  and  $R^*$  of equation (5).

**Step 2:** Write the adjoint differential equation, the optimality condition and transversality boundary condition (if necessary). Using the Hamiltonian to find the differential equation of the adjoint  $\lambda$ , we obtained There exist adjoint variable  $\lambda_1, \lambda_2, \lambda_3$  and  $\lambda_4$  that satisfy adjoint condition.

$$\lambda'_i(t) = -\frac{\partial H}{\partial x_i}, \text{ where } i = 1, 2, \dots, 4$$

##### 4.1. Adjoint functions

$$\lambda'(t) = -\frac{\partial H}{\partial x} \Rightarrow \lambda' = -(F_x + \lambda g_x) \text{ adjoint condition} \quad (8)$$

$$\lambda'_1 = -\frac{\partial H}{\partial S} \Rightarrow \lambda'_1 = \lambda_1(\beta I + \mu_n + u) - \lambda_2\beta I - \lambda_4 u$$

$$\lambda'_2 = -\frac{\partial H}{\partial E} \Rightarrow \lambda'_2 = \lambda_2(\mu_n + \delta) - \lambda_3\delta$$

$$\lambda'_3 = -\frac{\partial H}{\partial I} \Rightarrow \lambda'_3 = -A + \lambda_1(\beta S) - \lambda_2\beta S + \lambda_3(\mu_n + mu_d + \gamma) - \lambda_4\gamma$$

$$\lambda'_4 = -\frac{\partial H}{\partial E} \Rightarrow \lambda'_4 = -\lambda_1\alpha + \lambda_4(\mu_n + \alpha)$$

with transversality conditions  $\lambda_i(T) = 0, i=1, \dots, 4$ .

The optimality condition is given by,

$$\frac{\partial H}{\partial u} = 0 \text{ at } u = u^* \Rightarrow F_u + \lambda g_u = 0$$

$$\frac{\partial H}{\partial u_1} = 0 \text{ at } u_1 = u_1^* \Rightarrow F_{u_1} + \lambda g_{u_1} = 0$$

Step 3: Solve for  $u^*$  and  $u_1^*$  in terms of  $S^*$ ,  $E^*$ ,  $I^*$ ,  $R^*$  and  $\lambda$

$$\frac{\partial H}{\partial u} = Bu + S(\lambda_4 - \lambda_1) = 0 \quad (9)$$

In this way we obtain an expression for the OC:

$$u^* = \frac{S(\lambda_1 - \lambda_4)}{B}$$

$$\frac{\partial H}{\partial u_1} = B_1 u_1 + E(\lambda_4 - \lambda_2) = 0 \quad (10)$$

Next, we obtain an expression for the OC:

$$u_1^* = \frac{E(\lambda_2 - \lambda_4)}{B_1}$$

**Step 4:** Solve the four differential equations for  $S^*$ ,  $E^*$ ,  $I^*$ ,  $R^*$  and  $\lambda$  with boundary conditions, substituting  $u^*$  and  $u_1^*$  in the differential equations with the expression for the optimal control from the previous step.

**Step 5:** After finding the optimal state and adjoint, solve for the optimal control.

We solve that system of differential equations for the optimal state and adjoint and then obtain the so called optimal control. Solution of the optimal control in problem terms of  $S^*$ ,  $E^*$ ,  $I^*$ ,  $R^*$  and  $\lambda$ , represents the characterization of the optimal control ( $u^*$ ). The state equations and the adjoint equations together with the characterization of the optimal control and the boundary conditions constitute the optimality system.

**Remark 1:** If the Hamiltonian is linear in the control variable  $u$ , it can be difficult to calculate  $u^*$  from the

optimality equation, since  $\frac{\partial H}{\partial u}$  would not contain  $u$ . Specific ways of solving these kind of problems can be found in (Suzanne & John 2007).

#### Backward-forward Sweep Method

From the model the optimal control problem becomes,

$$\text{Min } J(\mathbf{u}) = \int_0^T (AI + \frac{1}{2}Bu^2)dt$$

Subject to:

$$\frac{dS}{dt} = b - \beta IS - \mu_n S - uS + \alpha R$$

$$\frac{dE}{dt} = \beta IS - \mu_n E - \delta E$$

$$\frac{dI}{dt} = \delta E - (\mu_n + \mu_d + \gamma)I \quad (11)$$

$$\frac{dR}{dt} = \gamma I - (\mu_n + \alpha)R + uS$$

With initial value,

$S(0) = S_0 \geq 0$ ,  $E(0) = E_0 \geq 0$ ,  $I(0) = I_0 \geq 0$ ,  $R(0) = R_0 \geq 0$  And

$$\text{Min } J(\mathbf{u}) = \int_0^T (AI + \frac{1}{2}(Bu^2 + B_1 u_1^2))dt$$

Subject to

$$\frac{dS}{dt} = b - \beta IS - \mu_n S - uS + \alpha R$$

$$\frac{dE}{dt} = \beta IS - \mu_n E - \delta E - u_1 E$$

$$\frac{dI}{dt} = \delta E - (\mu_n + \mu_d + \gamma)I \quad (12)$$

$$\frac{dR}{dt} = \gamma I - (\mu_n + \alpha)R + uS + u_1 E$$

As previously indicated,, any solution to the above optimal control problem must also satisfy

$$\lambda'_i(t) = -\frac{\partial H}{\partial x_i} \quad (13)$$

Where,  $i=1,2,\dots,4$ ,  $x_1 = S$ ,  $x_2 = E$ ,  $x_3 = I$ ,  $x_4 = R$

$$\frac{\partial H}{\partial u} = 0 \text{ at } u^* \quad (14)$$

$$\frac{\partial H}{\partial u_1} = 0 \text{ at } u_1^* \quad (15)$$

The optimal controls are,

$$u^* = \begin{cases} 0 & \text{if } \frac{\partial H}{\partial u} < 0 \\ \frac{S(\lambda_1 - \lambda_4)}{B} & \text{if } \frac{\partial H}{\partial u} = 0 \\ 0.9 & \text{if } \frac{\partial H}{\partial u} > 0 \end{cases} \quad (16)$$

$$u_1^* = \begin{cases} 0 & \text{if } \frac{\partial H}{\partial u_1} < 0 \\ \frac{E(\lambda_2 - \lambda_4)}{B_1} & \text{if } \frac{\partial H}{\partial u_1} = 0 \\ 0.9 & \text{if } \frac{\partial H}{\partial u_1} > 0 \end{cases} \quad (17)$$

The optimality condition can usually be manipulated to find a representation of  $u^*$  in terms of  $t$ , state variables and  $\lambda$ . If this representation is substituted back into the ODEs for the state variables and  $\lambda$  then the equations (11) and (12) form a two-point boundary value problem. The Runge-Kutta method is then applied to solve initial value problems, and resolve the optimality system of the optimal control problem. This approach is generally referred to as the Forward-Backward Sweep method. Information about convergence and stability of this method can be found in (Suzanne & John 2007). The process begins with an initial guess on the control variable. Then, the state equations are simultaneously solved forward in time and adjoint equations are solved backward in time. The control is updated by inserting the new values of states and adjoints into its characterization, and the process is repeated until convergence occurs.

## 5. Numerical illustrations and conclusions

Numerical solutions to the optimality system comprising of the state equations (5) and adjoint equations are carried out using MATLAB and using parameters in Table 1 and the following weight factors and initial conditions:  $A = 100$ ,  $B = 0.04$ ,  $B_1 = 0.06$ ,  $S(0) = 86.46\%$ ,  $E(0) = 4.5\%$ ,  $I(0) = 9.042\%$ ,  $R(0) = 0\%$ . The algorithm is the forward-backward scheme; starting with an initial guess for the optimal controls  $u$  and  $u_1$ , the state variables are then solved forward in time from the dynamics (5) using a Runge-Kutta method of the fourth order. Then those state variables and initial guess  $u$  and  $u_1$  are used to solve the adjoint equations backward in time with given final conditions (16) and (17), again employing a fourth order Runge-Kutta method. The controls  $u$  and  $u_1$  are updated and used to solve the state and then the adjoint system. This iterative process terminates when current state, adjoint, and control values converge sufficiently (Helena & Teresa 2012).

### 5.1. Results for Optimal education only

With this strategy, education ( $u$ ) is utilized in the disease control while the control on drug therapy treatment ( $u_1$ ) is set to zero, with weight factors  $B_1 = 0$ ,  $A = 100$ ,  $B = 0.04$ . For this strategy, we observed that the number of susceptible individuals is higher when education and drug therapy treatment are absent (Fig. 3). For the latently exposed ( $E$ ) individuals in Figure 4, it can be seen that with the presence of education the percentage rate of the exposed is lower than when there is no education. The same trend is followed in Fig. 5, where the percentage of the infected group ( $I$ ) is lower when exposed to education. However the percentage of the recovered individuals ( $R$ ) with education is higher than when there is no exposure to education. Figures 5 and 6 are respectively lesser and greater respectively than the percentage of infected individuals and recovered individuals in the absence of education and drug therapy treatment.

### 5.2. Optimal drug therapy treatment only

The control ( $u_1$ ) on drug therapy treatment is utilized while the control on education ( $u$ ) is set to zero, with weight factors  $A = 100$ ,  $B = 0.04$ ,  $B_1 = 0.06$ . For this strategy, it can be observed in Figure 7, that controls with education and drug therapy treatment lowers the percentage of susceptible individuals (hardly perceptible in the diagram) than with education alone. This is because the recovered individuals go back to susceptible group and increase the susceptible group at higher rate. For the latently infected individuals in Figure 8, it can be seen that

in the absence of education, and with an initially exposed population of 4.5%; during the first 5 weeks there is hardly any change in the percentage of the individuals exposed both with education and with education and treatment. It is obvious that the impact of education takes time to be felt or manifested in the dynamics. However there is a dramatic change in the dynamics after this period as the percentage of the exposed with education and treatment becomes significantly lower than for those with education alone. For the infected individuals in Figure 9, with an initially infected population of 9.04%, it can be seen that using both intervention mechanisms is better than using education as only control mechanism. As earlier observed, there is a time lag of about ten weeks for the impact of education to be reflected in the dynamics. The same trend is observed in Fig. 10 for the percentage of the recovered where the time lag for education is about five weeks before influence of education with treatment shows a higher percentage than with education alone.

### 5.3. Optimal education and drug therapy treatment

With this strategy, the controls on education ( $u$ ) and drug therapy treatment ( $u_1$ ) are utilized, with weight factors  $A=100$ ,  $B=0.04$ ,  $B_1=0.06$ . Figure 11 shows that the percentage of susceptible individuals with education and treatment is lower than the susceptible population in the absence of education and drug therapy treatment. Figure 12, shows that without control the percentage of exposed individuals is higher than would be the case with education and treatment options. The positive effect of treatment and education is further confirmed in Fig. 13 where there is a higher percentage of individuals recorded without any control measures. Fig. 14 shows that as more people get exposed to treatment and education there the more they are likely not to get infected.

## 6. Concluding remarks

The results displayed herein not only confirm the validity of the mathematical formulation derived herein but also illustrate how to optimally apply control measures involving treatment and education for the control of dengue fever. Utilizing education and drug therapy treatment lead to better disease control in the population than utilizing drug therapy treatment only. In addition, the application of only one form of control measure although though it results in a delayed peak in the percentage of exposed and infected, is not as effective as using both controls. Thus control programs that specialize in an optimal application of multi-control measures can effectively reduce or alleviate the effects of dengue fever spread.

Further work should include other control variables like the effect of bio-immunology on the spread of dengue fever, the use of medicated mosquito nets, development and application of vaccines, creation sterile mosquito males for the control of mosquito population etc.

## References

- Bernouli, D. (1760) "Reeflexions sur les avantages de linoculation", *Mercure de paris*. P. 173.
- Buletin, J.E.(2010), Vol.2, "tahun, <http://www.depkes.go.id/downloads/publikasi/buletin/buletin20DBD.pdf>".
- Esayas, Z. K., (2015) "Epidemiological Modeling of Measles Disease with Optimal Control of Vaccination Strategy", *Master thesis*, Addis Ababa University.
- Helena, S. F. R.(2012), "Optimal Control and Numerical Optimization Applied to Epidemiological Models", *Ph.D.thesis*, University of Aveiro.
- Helena, S. R. and Teresa, M. T.(2012), "Monteiro, Sensitivity Analysis in a Dengue Epidemiological Model", *School of Business, Polytechnic Institute of Viana do Castelo, Valenca, Portugal R & D Centre Algoritmi, Department of Production and Systems, University of Minho, Braga, Portugal R&D Centre CIDMA, Department of Mathematics, University of Aveiro, Aveiro, Portugal*.
- Hindmarsh, A.C. and et al. Sundials(2005), "Suite of nonlinear and differential/algebraic equation solvers", *ACM Transactions on Mathematical Software*, **31**(3):363-396.
- James, D.M.(2002), "Mathematical Biology", *Springer-Verlag*.
- Kermack, W; Mcckendricck, A.(1991). "Contributions to the mathematical theory of epidemics \_II. The problem of endemicity", *Bulletin of Mathematical Biology*. **53**(1-2):57-87.
- Laurencia, N. M., Estomih, S.M., Oluwole, D.M.(2015), "Temporal Model for Dengue Disease with Treatment", *Mathematics Department, University of Dares Salaam, Dares Salaam, Tanzania and Faculty of Military Science, Stellenbosch University, Saldanha, South Africa*.
- Lebesgue (2015), "Lebesgue Integral", *mathphys15.tex; 11:03; p. 59*
- Lungu, E.M., Kgosimore, M. and Nyabadza, F.(2007), "Mathematical epidemiology", *Department of Mathematics, University of Botswana, P/Bag UB 00704, Gaborone*.
- Noorani, M. S. M.(2012), "SEIR model for transmission of dengue fever in Selangor Malaysia", *Department of Mathematics, Universiti Kebangsaan Malaysia, 43600 Bangi, Selangor, Malaysia*.
- Suzanne, L. and John, T. W.(2007), "Optimal control applied to biological models", *Mathematical and Computational Biology Series, Chapman and Hall/CRC, Boca Raton, FL, Chapman and Hall/CRC*.
- WHO.(2009), "Dengue: Guidelines for Diagnosis, Treatment, Prevention and Control", *Geneva: World Health*



*Organization and the Special Program for Research and Training in Tropical Diseases.,*

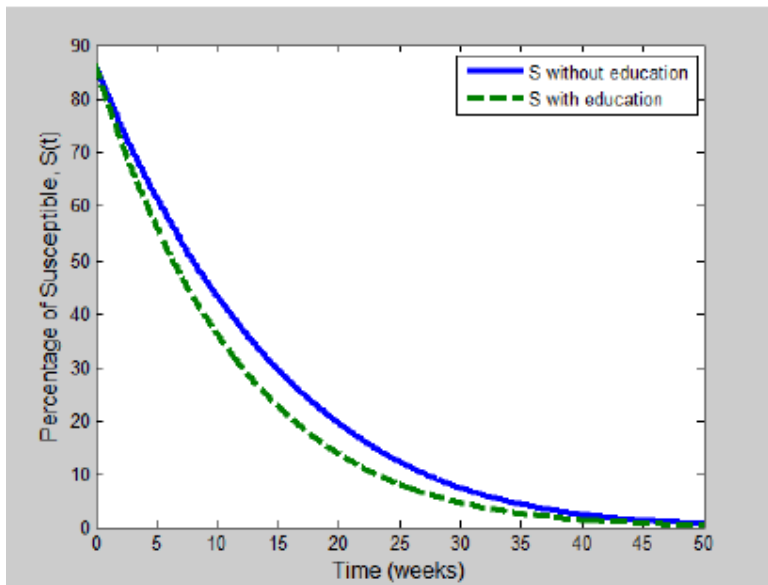

Figure 3: Susceptibles with education Vs without education

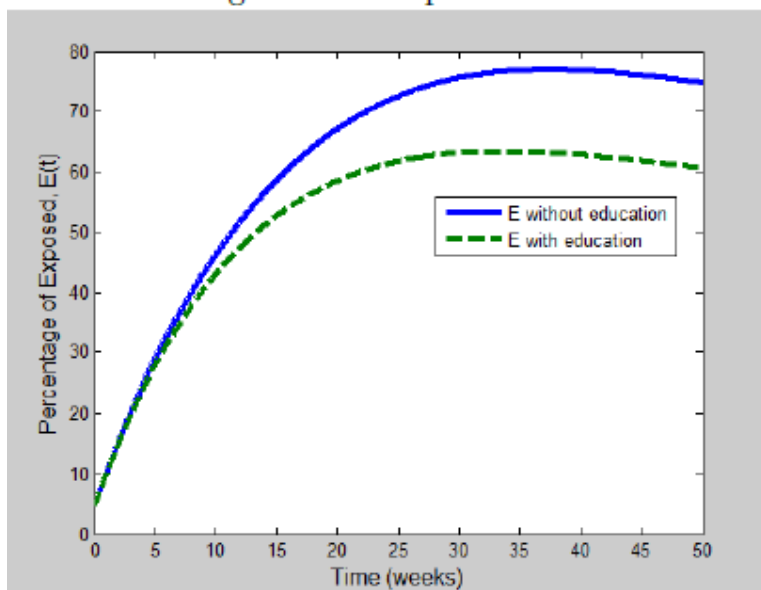

Figure 4: Exposed with education Vs without education

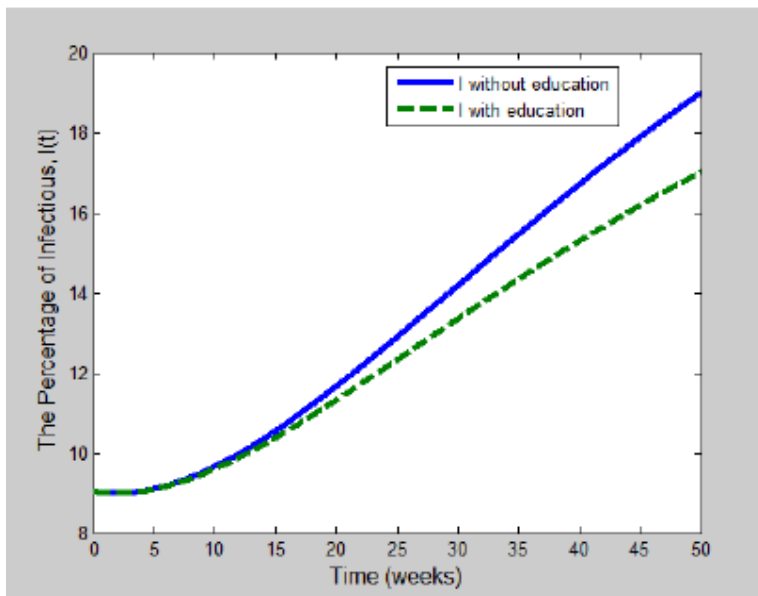

Figure 5: Infectives with education Vs without education

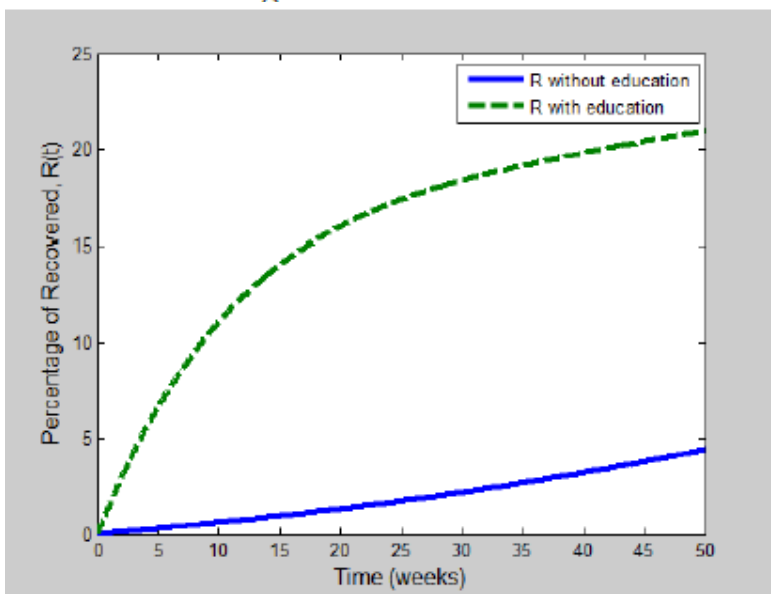

Figure 6: Recovered with education Vs without education

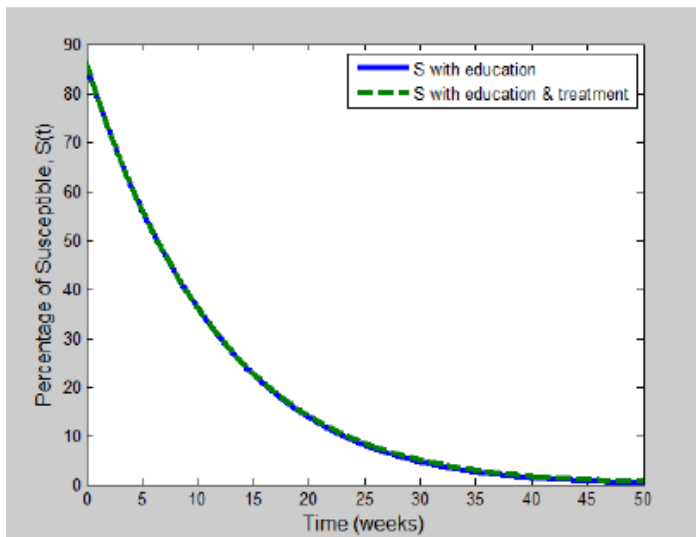

Figure 7: Susceptibles with education Vs with education and drug therapy treatment

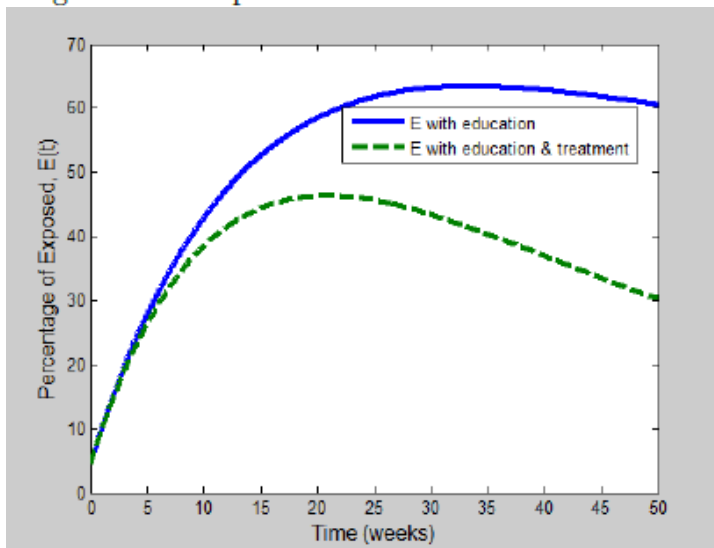

Figure 8: Exposed with education Vs with education and drug therapy treatment

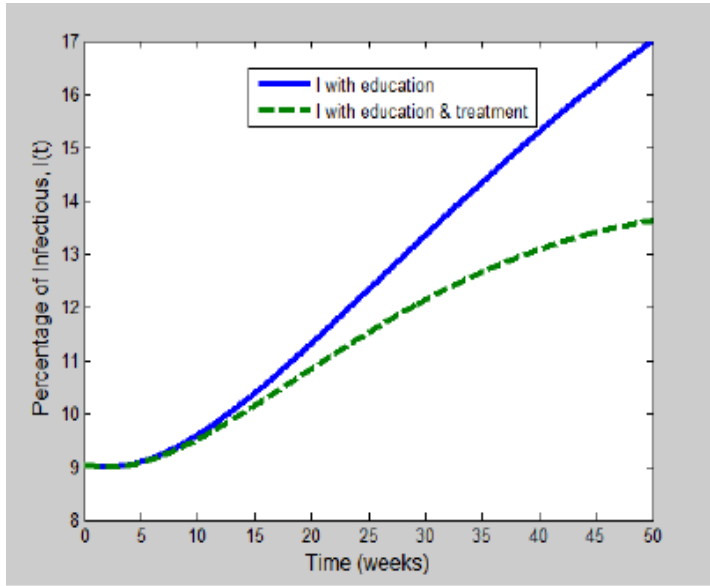

Figure 9: Infectives with education Vs with education and drug therapy treatment

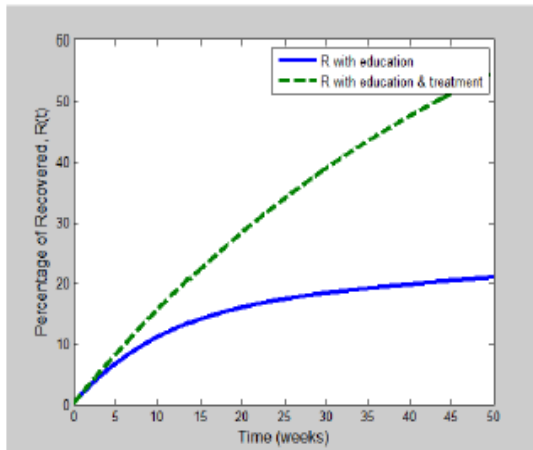

Figure 10: Recovered with education Vs with with education and drug therapy treatment

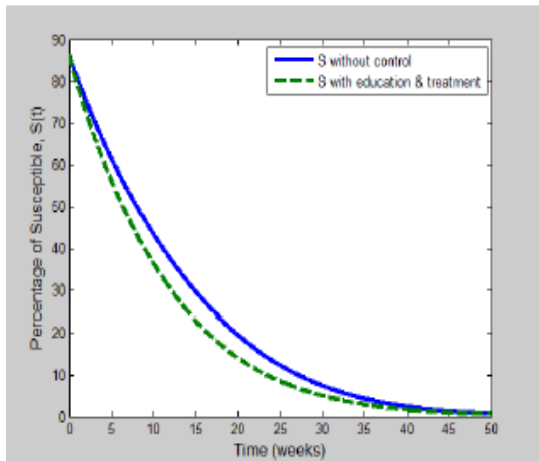

Figure 11: Susceptibles without education and drug therapy treatment Vs with education and drug therapy treatment

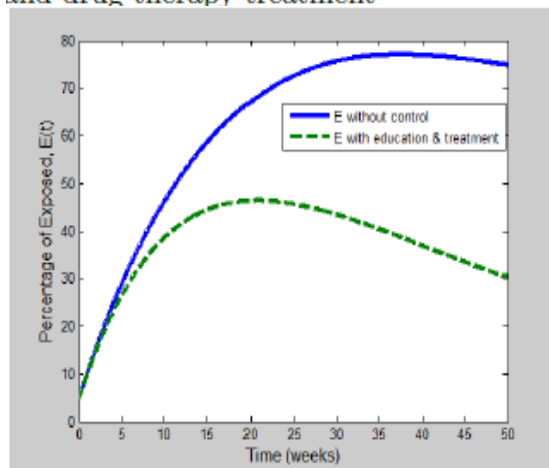

Figure 12: Exposed without education and drug therapy treatment Vs with education and drug therapy treatment

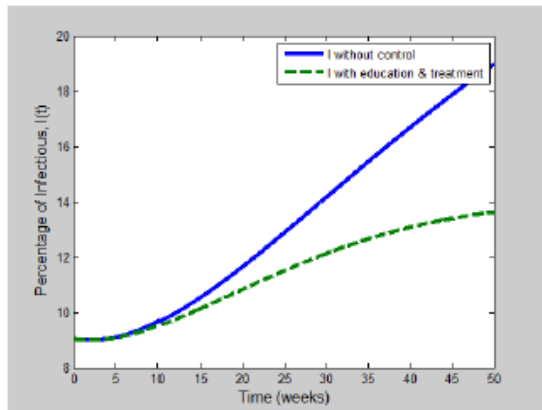

Figure 13: Infectives without education and drug therapy treatment Vs with education and drug therapy treatment

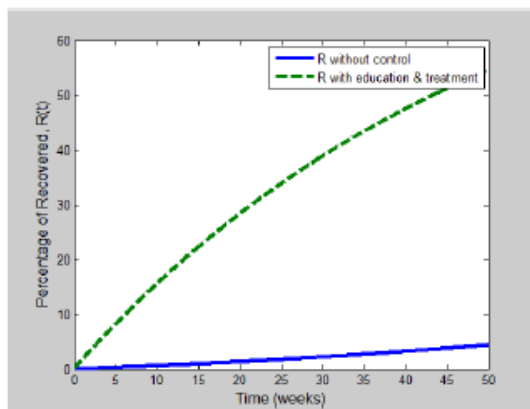

Figure 14: Recovered without education and drug therapy treatment Vs with with education and drug therapy treatment