

# A Single-Phase Doubly-Excited DC-AC Buck-Boost Converter Suitable for Feeding AC Loads from PV Systems

M. Ezzat (corresponding author)  
Department (Electrical Engineering)  
University (Menofia University)  
Address (Shebin EL\_Kom)  
COUNTRY (EGYPT)  
[en.ezzat@yahoo.com](mailto:en.ezzat@yahoo.com)

## Abstract

This paper presents a new topology for converting a DC voltage to an AC one. The proposed converter is excited from two separate DC supplies so the term "Doubly-Excited". The most important features of the proposed converter are the output voltage (AC Voltage) is lower or higher than the input one (DC Voltage), controllable voltage and frequency, and the output voltage and current are approximately sinusoidal which means low harmonics content. Also, the paper presents the simulation of the proposed converter in different modes of operation under control to show the effectiveness of the proposed control.

**Keywords:** Boost, Control, DC-AC Converter, Design, Simulation.

## 1. Introduction

DC-AC converters are extensively used in electrical power applications. They can be used to convert the photovoltaic output voltage (DC voltage) to an AC one. They can be used in uninterruptable power supplies to convert batteries DC voltage to an AC one. They can be also used in electrical drives and other power applications. Different topologies for DC-AC converters are reported in several publications (Akhter 2007, Sanchis 2005, Chang 2004, Zheng Peng 2003, Ertl 2002 & Ca'ceres 1999). This paper presents a new technique for a DC-AC buck-boost converter that can be used in several applications. The main important feature of the proposed converter is the output voltage and current are purely sinusoidal without the need for filters at the load terminals in addition to the ability to buck and boost the input voltage.

## 2. Proposed DC-AC Converter

Fig. 1 shows the circuit diagram of the proposed DC-AC buck-boost converter. As shown from the figure, the proposed converter is supplied from two separate DC supplies and it consists of two simple choppers feeding a half bridge inverter. The chopper switches are controlled so as to make the capacitor voltage vary in a half-wave sinusoidal manner (The control technique will be described in the next sections). As seen from the figure, the converter contains four switches. This number will be increased with the increase of the number of output phases as will be described in the next sections.

### 3. Principle of Operation

The principle of operation of the proposed converter can be discussed as follows:

The DC-DC choppers provide DC output voltages lower or higher than the supplies voltage. The principle of operation of each chopper circuit can be discussed as follows:

Figs. 2a & 2b show the modes of operation of the DC-DC chopper. From these figures, the principle of operation of this converter can be discussed as follows:

- When the switch S1 is turned on, the current rises through the inductor and the inductor voltage polarity will be in a direction that opposes the supply polarity.
- When the switch S1 is opened, the inductor reverses its polarity and a current passes through the diode to charge the capacitor C. The capacitor voltage depends on the duty ratio at which the semiconductor switch is switched.

The function of the DC-AC converter (Half Bridge Inverter) is to convert the output voltage from the DC-DC converter to AC voltage. Figs. 3a & 3b show the modes of operation of this converter.

### 4. Principle of Converter Control

To make the output voltage to be very near to the sinusoidal waveform without the need for filters at the load terminals, the capacitor C voltage shouldn't be a smooth voltage. If the capacitor voltages are controlled to be as in Figs. 4a & 4b, the output voltage will be near to the sinusoidal waveform if the switches of the DC-AC converter are controlled as shown in Figs. 5a & 5b. Fig. 6 shows the predicted output voltage with this control scheme.

### 5. Simulation of the Proposed Converter under Closed Loop Control as a Single-Phase Converter

This section presents the performance of the proposed converter under closed loop control condition as a DC to 1-phase AC converter. The control strategy in this paper has been done as described before in section 4. Fig. 7 shows the schematic diagram of the proposed control. In this paper a simple PD (Proportional Differential) controller has been used. Any type of controllers can be used but the PD is chosen here for simplicity and as it gives a satisfactory performance. Figs. 8a to 8c show the output voltage, load current and supply current for a desired output of 50 Hz and 100 volt (Max.). From these figures, one can see that the load voltage and current waveforms are sinusoidal waveforms which mean low harmonic content. Figs. 9a to 9c show the output voltage, load current and supply current for a desired output of 50 Hz and 50 volt (Max.). Figs. 10a to 10c show the output voltage, load current and supply current for a desired output of 20 Hz and 200 volt (Max.).

### 6. Simulation of the Proposed Converter under Closed Loop Control at Supply Voltage and Load Variations

This section presents the performance of the proposed converter under supply voltage variations. Figs. 11a to 11c show the output voltage, load current and supply current for a desired output of 50 Hz and 50 volt (Max.) with step change in left hand side supply voltage from 100 volt to 80 volt. Figs. 13a &

13b show the output voltage and load current for a desired output of 50 Hz and 100 volt (Max.) with a sudden switching of a resistive load of 40 Ohm. Also, it can be seen that the output voltage is sinusoidal and has a constant value.

## 7. Conclusion

A new topology for a DC-AC buck-boost converter has been presented. Control of the proposed converter has been presented in different modes of operation. The proposed control strategy has been found to give a satisfactory performance which supports the use of this converter in several applications.

## References

- Rafia Akhter (2007), A New Technique of PWM Boost Inverter for Solar Home Applications, BRAC University Journal, Vol. 4, No. 1, PP. 39-45.
- Pablo Sanchis et al (2005), Boost DC-AC Inverter: A New Control Strategy, IEEE Transactions on Power Electronics, Vol. 20, No. 2, PP. 343-353.
- Liuchen Chang et al (2004), A Novel Buck-Boost Inverter for Photovoltaic Systems, Canadian Solar Buildings Conference, Montreal, PP. 1-8.
- Fang Zheng Peng (2003), Z-Source Inverter, IEEE Transactions on Industry Applications, Vol. 39, No. 2, PP. 504-510.
- Hans Ertl et al (2002), A Novel Multicell DC-AC Converter for Applications in Renewable Energy Systems, IEEE Transactions on Industrial Electronics, Vol. 49, No. 5, PP. 1048-1057.
- Ramo'n O. Ca'ceres, Ivo Barbi (1999), A Boost DC-AC Converter: Analysis, Design, and Experimentation, IEEE Transactions on Power Electronics, Vol. 14, No. 1, PP. 134-141.

## Appendix

Circuit Parameters:

Capacitance  $C=50$  micro Farad.

Inductance = 1 milli Henry.

Resistance of the Inductor = 1 Ohm.

P Controller Gain= 15.

Differentiator Time Constant = 0.003 Sec.

Load Resistance= 35 Ohm.

Load Inductance= 0.09 H.

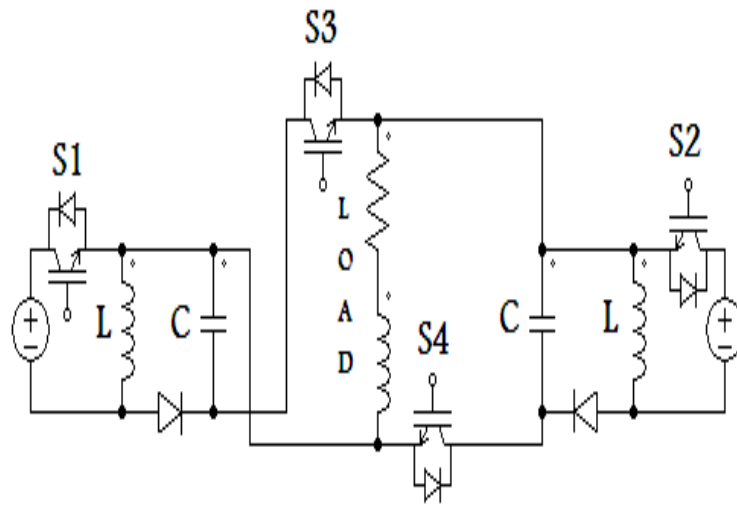

Figure 1. Block Diagram of the Proposed DC-AC Boost Converter

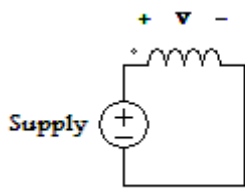

Figure 2a. Equivalent Circuit for S1 is Closed

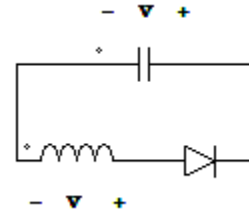

Figure 2b. Equivalent Circuit for S1 is Opened

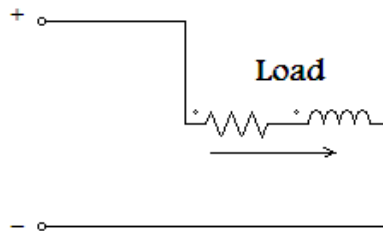

Figure 3a. Equivalent Circuit for S3 is Closed & S4 is Opened

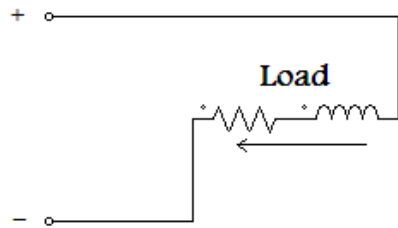

Figure 3b. Equivalent Circuit for S3 is Opened & S4 is Closed

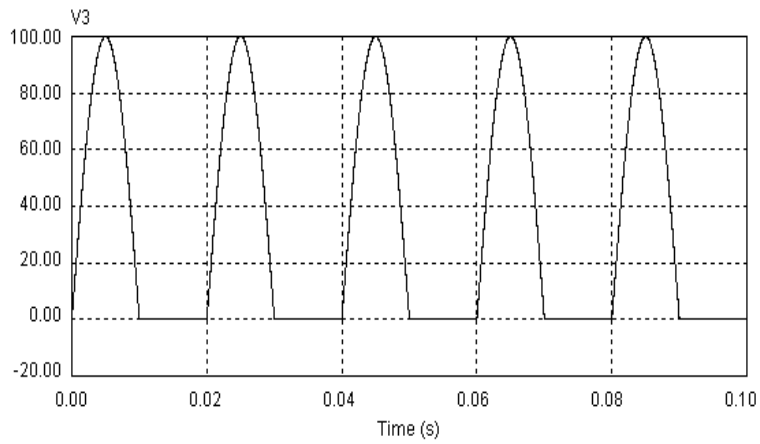

Figure 4a. Left Hand Side Capacitor Desired Voltage

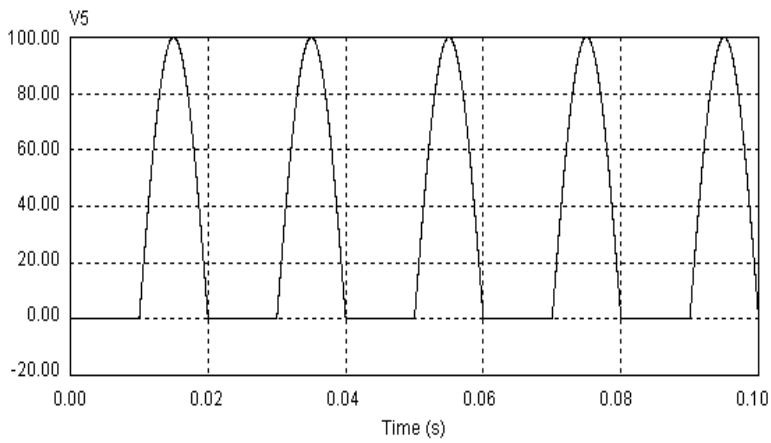

Figure 5b. Right Hand Side Capacitor Desired Voltage

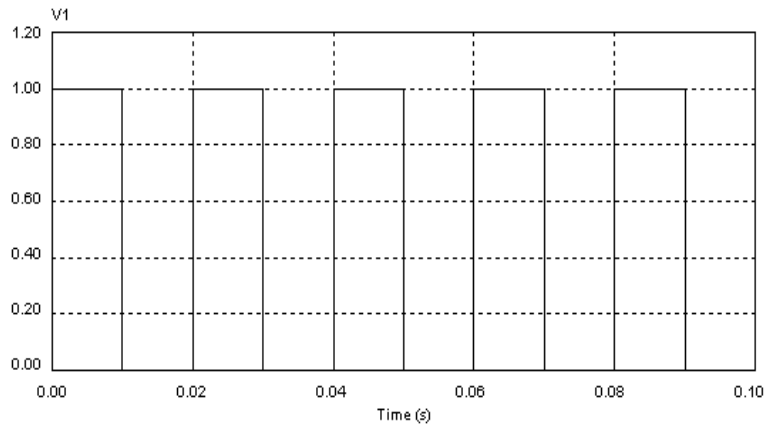

Figure 5a. Control Signal to S3

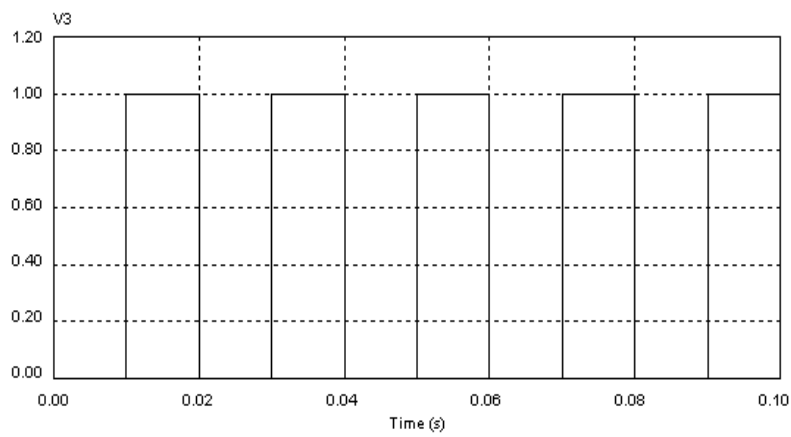

Figure 5b. Control Signal to S4

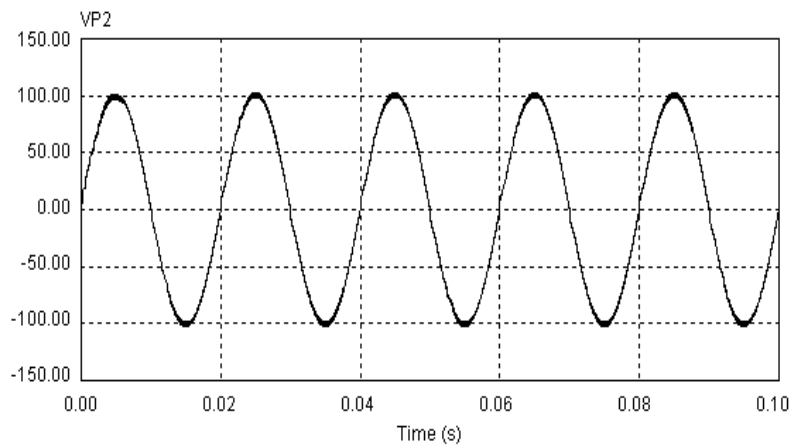

Figure 6. Predicted Output Voltage with the Proposed Control Scheme

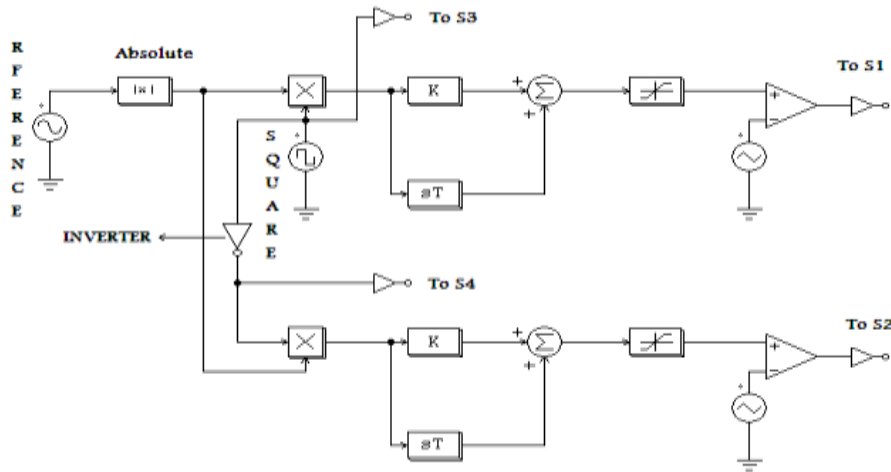

Figure 7. Schematic Diagram of the Proposed Controller

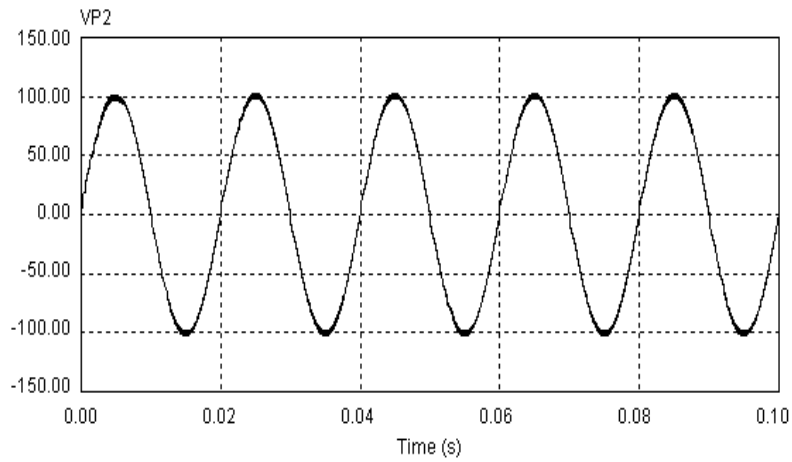

Figure 8a. Output Voltage (50Hz, Supply Voltage=100 Volt (DC), RL-Load, Closed Loop)

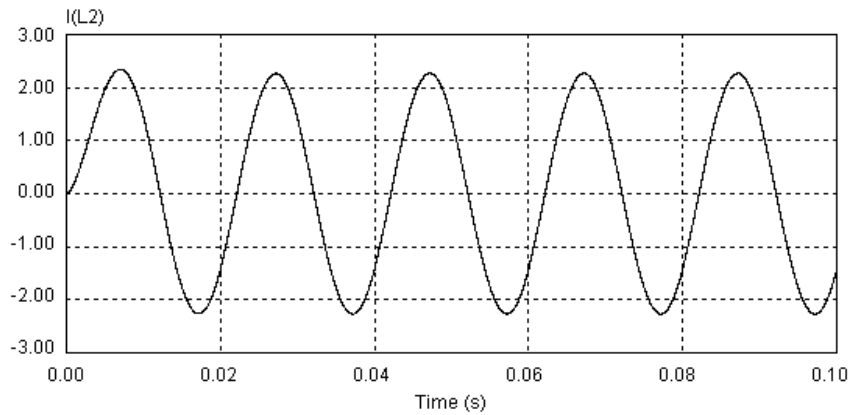

Figure 8b. Load Current (50Hz, Supply Voltage=100 Volt (DC), RL-Load, Closed Loop)

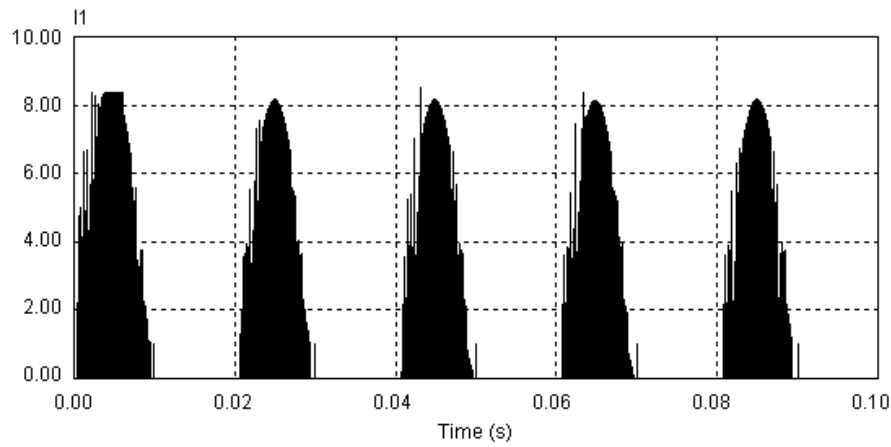

Figure 8c. Left Hand Supply Current (50Hz, Supply Voltage=100 Volt (DC), RL-Load, Closed Loop)

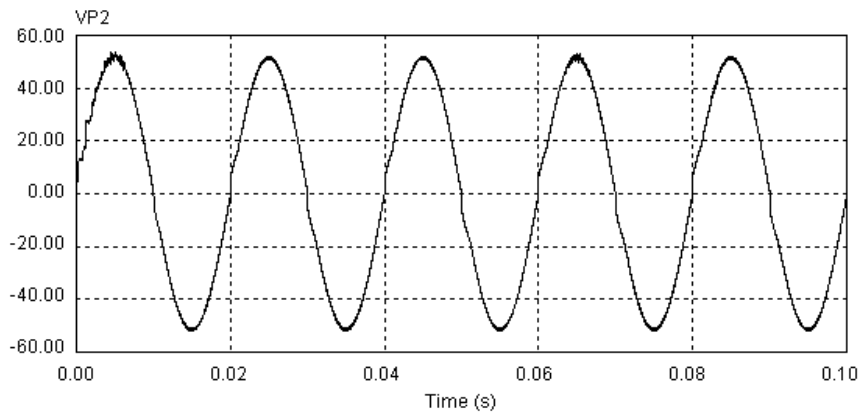

Figure 9a. Output Voltage (50Hz, Supply Voltage=100 Volt (DC), RL-Load, Closed Loop)

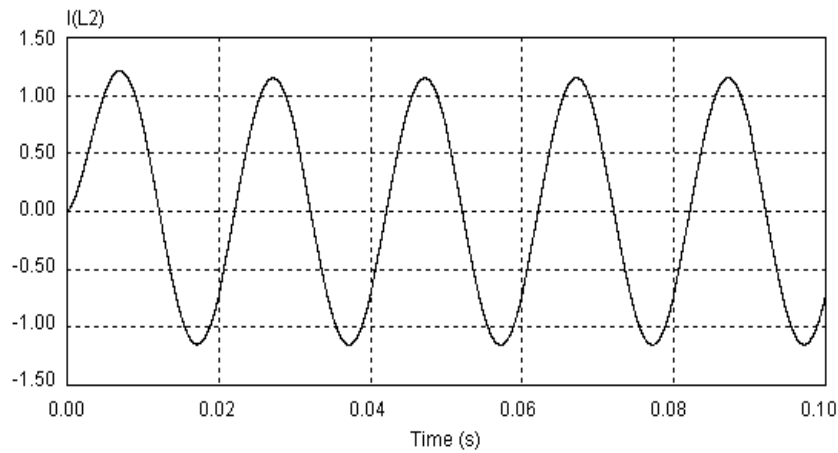

Figure 9b. Load Current (50Hz, Supply Voltage=100 Volt (DC), RL-Load, Closed Loop)



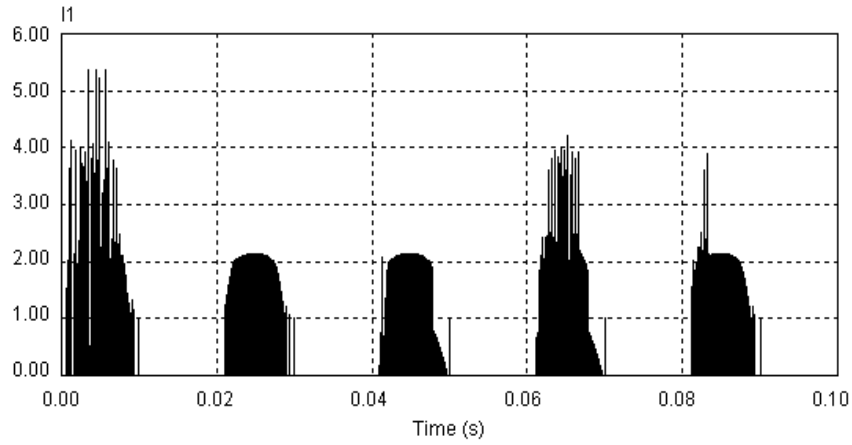

Figure 9c. Left Hand Supply Current (50Hz, Supply Voltage=100 Volt (DC), RL-Load, Closed Loop)

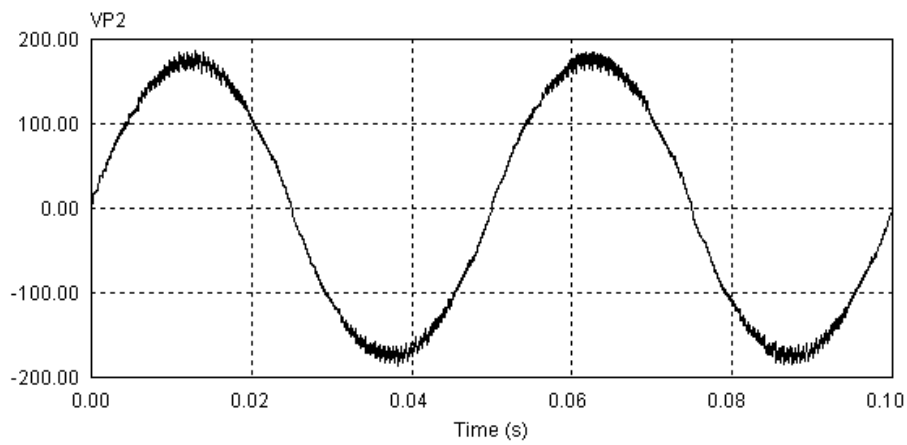

Figure 10a. Output Voltage (20Hz, Supply Voltage=100 Volt (DC), RL-Load, Closed Loop)

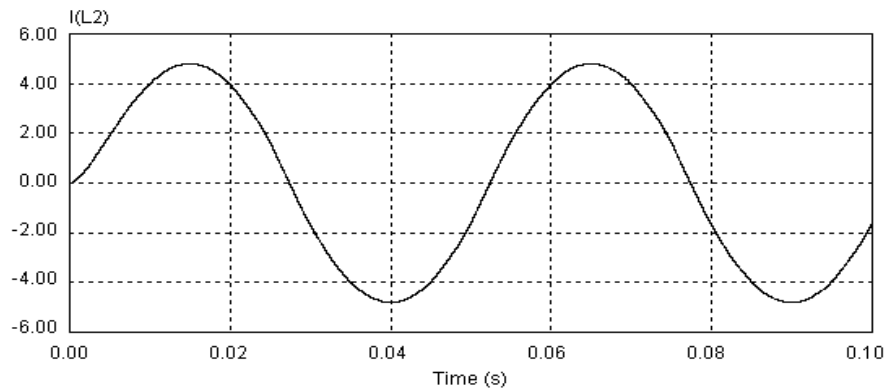

Figure 10b. Load Current (20Hz, Supply Voltage=100 Volt (DC), RL-Load, Closed Loop)

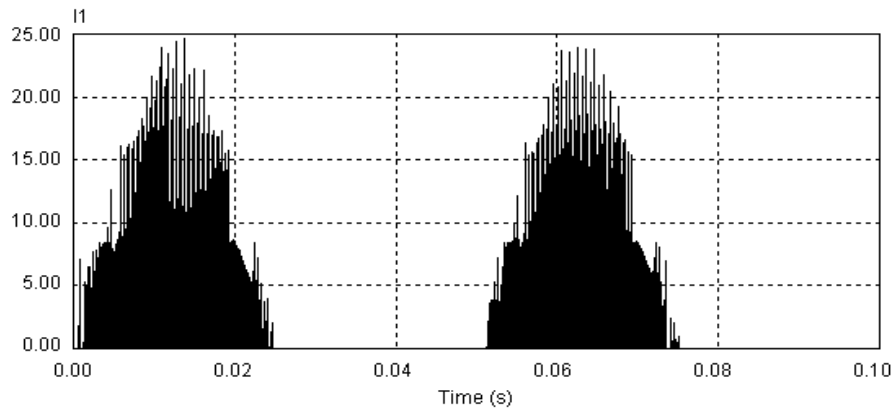

Figure 10c. Left Hand Supply Current (20Hz, Supply Voltage=100 Volt (DC), RL-Load, Closed Loop)

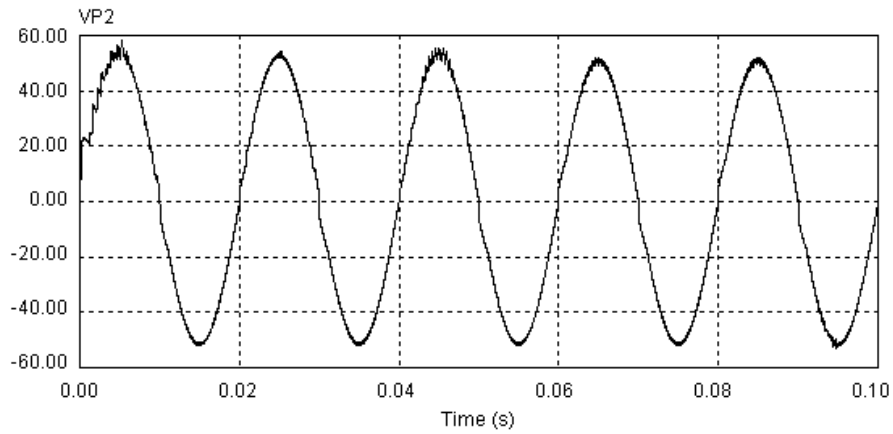

Figure 11a. Output Voltage (50Hz, Step Change in supply voltage from 100-80 volt, RL-Load, Closed Loop)

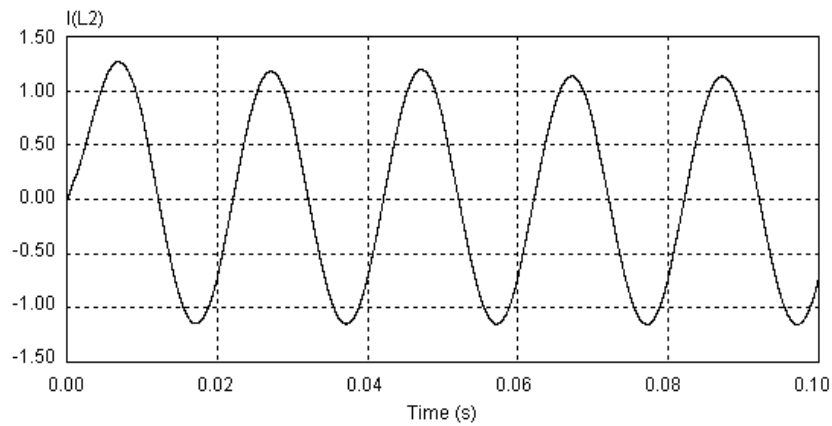

Figure 11b. Load Current (50Hz, Step Change in supply voltage from 100-80 volt, RL-Load, Closed Loop)

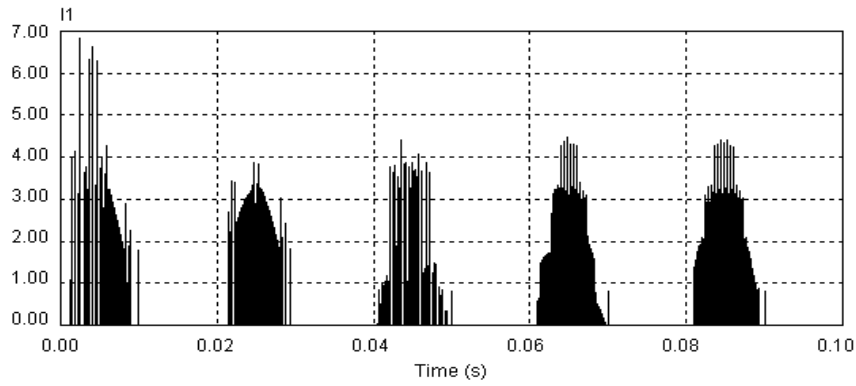

Figure 11c. Supply Current (50Hz, Step Change in supply voltage from 100-80 volt, RL-Load, Closed Loop)

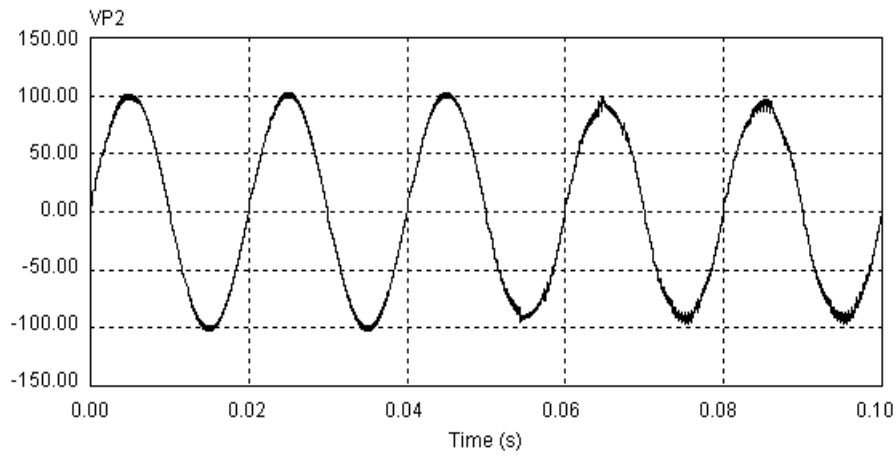

Figure 13a. Output Voltage (50Hz, Sudden Switching of R-Load, RL-Load, Closed Loop)

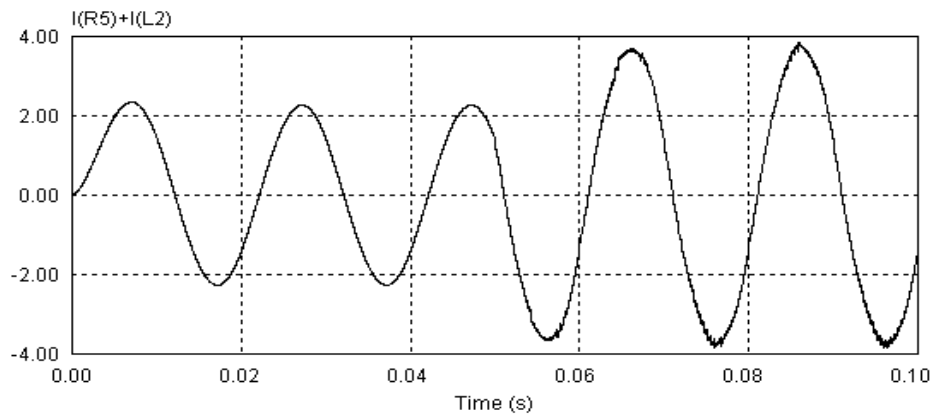

Figure 13b. Load Current (50Hz, Sudden Switching of R-Load, RL-Load, Closed Loop)

This academic article was published by The International Institute for Science, Technology and Education (IISTE). The IISTE is a pioneer in the Open Access Publishing service based in the U.S. and Europe. The aim of the institute is Accelerating Global Knowledge Sharing.

More information about the publisher can be found in the IISTE's homepage:

<http://www.iiste.org>

The IISTE is currently hosting more than 30 peer-reviewed academic journals and collaborating with academic institutions around the world. **Prospective authors of IISTE journals can find the submission instruction on the following page:**

<http://www.iiste.org/Journals/>

The IISTE editorial team promises to review and publish all the qualified submissions in a fast manner. All the journals articles are available online to the readers all over the world without financial, legal, or technical barriers other than those inseparable from gaining access to the internet itself. Printed version of the journals is also available upon request of readers and authors.

### **IISTE Knowledge Sharing Partners**

EBSCO, Index Copernicus, Ulrich's Periodicals Directory, JournalTOCS, PKP Open Archives Harvester, Bielefeld Academic Search Engine, Elektronische Zeitschriftenbibliothek EZB, Open J-Gate, OCLC WorldCat, Universe Digital Library, NewJour, Google Scholar

