

Innovative Systems Design and Engineering
ISSN 2222-1727 (Paper) ISSN 2222-2871 (Online)
Vol 2, No 4, 2011

www.iiste.org

Laboratory Validation of Calculations of Magnetic Field Mitigation Underneath Transmission Lines Using Passive and Active Shield Wires

Roshdy Radwan

Department of Electrical Power and Machines, Faculty of Engineering, Cairo University, Giza, Egypt
Email: roshdyradwan@yahoo.com

Mazen Abdel-Salam (Corresponding author)

Electrical Engineering Department, Faculty of Engineering, Assuit University, Assuit, Egypt
Email: mazen2000as@yahoo.com

Abdel-Bary Mahdy

Department of Electrical Power and Machines, Faculty of Engineering, Cairo University, Giza, Egypt
Email: abomohdy@yahoo.co.uk

Mohamed Samy

Electrical Engineering Department, Faculty of Industrial Education, Beni Suef University, Beni Suef, Egypt
Email: mohamed_samy227@yahoo.com

Abstract

This paper is aimed at reporting experimental measurements and calculations of how the magnetic field underneath overhead transmission lines is mitigated using passive and active shield wires. The magnetic field values were compared to those calculated using the current simulation technique (CST). A laboratory transmission line model representing the Egyptian 500 kV EHV line was built with dimensions scaled down in the ratio 10:1. The flat single circuit of the line was modeled in the laboratory by phase separation of 1.2 m and conductor diameter of 2.76 mm at height of 1.9 m. The shield wires were spaced 4.3 m at a height of 1.45 m. Magnetic field measurements were carried out for load currents of 5.7 and 10 A. The field was measured at 0.3 m above ground level with and without passive and active shield wires for several different lateral positions. The measured and calculated field values generally agreed reasonably with an error ranging between 2.5 and 20 % within the ROW. The maximum reduction of magnetic field from the passive shield wires is 10% at the edge of right of way. With active shield wires carrying a current of 5 A (one half of the conductor current), the reduction of magnetic field reached 17% at the edge of ROW.

Keywords: Current Simulation Technique, Magnetic Field Measurements, Magnetic Field Mitigation, Shield Wires, Transmission Lines, Health Effects.

1. Introduction

Prior to about 1982, electric fields were the main concern. With the publication of two papers by (Wertheimer & Leeper 1979 and 1982) and the subsequent appearance of papers from other sources, serious concerns have developed about magnetic field exposure. Therefore, calculation and measurement of the magnetic field distribution underneath transmission lines is of great importance (Abdel-Salam 1999, Swanson 1995, Caola 1983, Cruz 2002, Nicolaou 2011, Bakhawain 2003, and Filippopoulos 2005) and should be elaborated on.

Several studies have reported that children living near high voltage transmission and distribution lines had a higher cancer and leukemia incidence than other children (Chung 2007). However, limited studies have been reported regarding adults who live near high voltage transmission and distribution lines. In addition, various research work have suggested that exposure to electromagnetic fields could lead to DNA damages in cells under certain conditions (Kim 2010).

These effects depend on factors such as mode of exposure, type of cell and intensity and duration of exposure. For the above reasons, magnetic fields should be mitigated to overcome their harmful effects on the people living or work adjacent to the transmission lines. There are many strategies and approaches to cancel and mitigate magnetic fields underneath the power transmission lines (Stewart 1993, Jonsson 1994, Memari 1996, Lindberg 1998, Pettersson 1996, Rashkes 1998, Yamazaki 2000, Cruz 2003, Ippolito 2004, Kalhor 2005, Faria 2007 and Romero 2007). One of the approaches is to use active or passive shield wires underneath the line conductors.

The main purpose of this work is to validate experimental and calculation of magnetic field under transmission lines with passive and active shield wires to assess how effective are these wires in mitigating the magnetic field. The measurements were made underneath a laboratory model of 500 kV transmission line. The calculations are based on the current simulation technique.

2. Calculation method

The idea of current simulation technique is very simple and is similar to the charge simulation method applied for calculating electric fields (Abdel-Salam & Radwan 1999 and 2010). For a three phase transmission line of m subconductors per phase, the total number of subconductors is $3m$ as shown in Fig. 1. Each subconductor current is simulated by a finite number n of filamentary line currents distributed on a fictitious cylindrical surface of radius R_s which is a fraction of the subconductor radius R . The simulation currents i_k , $k = 1, 2, \dots, 3nm$ must satisfy the following conditions:

- 1- Zero normal component of the magnetic field strength on the subconductors' surfaces, following Biot-Savart law.
- 2- The sum of the filamentary line currents simulating the subconductor current must be equal to the subconductor current.

A set of equations are formulated at a number of boundary points chosen on the subconductors' surfaces to satisfy the boundary conditions as follows:

$$\sum_{k=1}^{3nm} p_{kj} i_k = 0, j = 1, 2, 3, \dots, 3m(n-1) \quad (1)$$

$$\sum_{k=(q-1)n+1}^{nq} i_k = I_{cq}, q = 1, 2, 3, \dots, 3m \quad (2)$$

Where P_{kj} is the magnetic normal field coefficient determined by the coordinates of the j^{th} boundary point and the k^{th} filamentary line current and is given by:

$$P_{kj} = \frac{1}{2\pi l_{kj}} \sin \theta_{kj} \quad (3)$$

with $\theta_{kj} = \alpha_{kj} - \phi_j$ (Fig. 2).

The set of equations 1 and 2 are to be solved simultaneously for determining the $3nm$ unknown filamentary line currents. Once the set of equations 1 and 2 are solved for the unknown filamentary line currents, the deviation of the normal component of the magnetic field strength from the zero value is calculated at a set of check-points arbitrary chosen on the subconductors' surfaces and considered as a measure of simulation accuracy. When the simulation currents satisfy the boundary conditions at the check-points with a considerable accuracy, the magnetic field could be calculated at any point in space is given by:

$$\bar{H} = \frac{1}{2\pi} \sum_{k=1}^{nm} i_k \left[\frac{-(y-y_k)\bar{a}_x + (x-x_k)\bar{a}_y}{(x-x_k)^2 + (y-y_k)^2} - \frac{(y-y_k)\bar{a}_x + (x+x_k)\bar{a}_y}{(x-x_k)^2 + (y-y_k)^2} \right] \quad (4)$$

Where (x, y) and (x_k, y_k) are the calculation point and the location of the kth simulation line current respectively.

To calculate the magnetic field from the transmission line and shield wires the following simplifying assumptions are considered:

1. Phase and shield conductors are straight and infinitely long, located at a height equal to the lowest point of the conductor sag [two-dimensional (2-D) problem] (Cruz 2003).
2. Investigated transmission line configurations are without ground wires.
3. Induced current effect on phase current is negligible.
4. Passive shield wires carry zero current.
5. Each two shield wires constitute a single loop and each three wires constitute two loops with a common wire.
6. Cross-sectional area of the shield wires is half that of the phase conductor. This is because the maximum shield current is variable up to half the phase current.

3. Experimental model

An experimental laboratory model was built to validate the calculation of the magnetic field obtained by the current simulation technique. The model was constructed at the high voltage laboratory of the faculty of Engineering Cairo University as a scale model of the actual of the 500 kV Egyptian transmission line as shown in Fig. 3 (a).

A horizontally arranged three phase power transmission line was built and fed from a three-phase star supply. Each phase has one conductor with cross section of 6 mm². One loop consisting of two shield wires, each of area 3 mm², is positioned underneath line conductors. The phase currents were 5.7 and 10 A and the shield current varied in the range 10 to 50% of the phase current. Fig. 3 (b, c) shows the arrangement of the phase conductors, control and measuring instruments for the model experiment.

The line conductors were supported by a wooden frame. The ends of the three phase conductors were connected together as a star connection at one end. The parameters which affect the measured magnetic field are the values of the phase and loop currents, the height H_s of the shield wires above the ground surface and the spacing S between shield wires. Three digital multi-meters were used to measure the phase currents in the range 0 to 10 A with accuracy of ±0.5%.

Two types of variable resistors were used to control the phase currents and the loop current in case of active shielding as shown in Fig 3 (c). The first one was used to control the phase currents up to a maximum value of 15 A, at a voltage ranging from 200 to 250 V. The second one was used in controlling shield wire current up to 30 A at 200 V.

An AC ammeter model 2013 with accuracy of ±0.5% was used to measure the current in the shield wires. Two miniature circuit breakers were used for the phase and loop circuits with maximum current of 20 A at 380 V. A power frequency field meter model 113 manufactured by the Electric Field Measurements Company was used to measure the magnetic field.

4. Results and discussions

The current simulation technique is applied to the experimental model shown in Fig. 3. Measurements of the magnetic field under the laboratory model were carried out. Figures 4 to 11 show the calculated and measured results of the magnetic fields at load current 10 A.

Figure 4 shows the measured and calculated magnetic field values with passive shield wires at a height of one meter from ground level. The error between the measured and calculated values did not exceed 12%

within the ROW as shown in Fig. 5. When the shield wire height was changed from 1 to 1.45 m, the results obtained followed the same trend as before with field reduction of about 10%, Figs. 6 and 7.

Figure 8 plots the measured and calculated magnetic field values with active shield wires at a height of 1 m from ground surface for different wire currents. The error between the measured and calculated values ranged between 5 and 20% when the active shield wire current is one half of the conductor current, see Fig. 9. When the height of the shield wire was changed to 1.45 m, the results obtained for the magnetic field, Figs. 10 and 11, followed the same trend as those shown in Figs. 8 and 9.

When the load current was changed from 10 – 5.7 A the results obtained, Figs. 12 to 15, followed the same trend as those shown in Figs. 4 – 5 and Figs. 10 – 11.

5. Conclusions

Passive shield wires have an appreciable effect on magnetic field reduction at ground level (0.3 m) underneath the line; the maximum reduction may reach 10%.

Active shield wires have considerable effect on the measured magnetic field underneath the transmission line model; this reduction of the field may reach 17% at the edge of the ROW. The reduction in the magnetic field increases with the increase of the current in the shield wires.

For the laboratory model, the dependency of the measured magnetic field values on the phase current and shield wires' current is the same as the calculated one. The error between the measured magnetic field values and those calculated reached up to 20%.

References

- Wertheimer, N. and Leeper, E. (1979), "Electrical wiring configurations and childhood cancer", *Am. J. Epidemiol.* (109) 273–284.
- Wertheimer, N. and Leeper, E. (1982), "Adult cancer related to electrical wires near the home", *Int. J. Epidemiol.* (11) 345 – 455.
- Abdel-Salam, M., Abdullah, H., El-Mohandes, M.Th. and El-Kishky, H. (1999), "Calculation of magnetic fields from electric power transmission lines", *Electric Power Systems Research*, vol. 49, pp 99–105.
- Swanson, J. (1995), "Magnetic Fields from Transmission Lines: Comparison of Calculation and measurements", *IEEE Proc. -Generation Transmission. Distribution*, vol. 142, no. 5, pp 481 – 486.
- Caola, R.J., Deno, D.W. and Dymek, V.S.W. (1983), "Measurements of Electric and Magnetic Fields in and Around Homes near a 500 kV Transmission Line", *IEEE Transactions on Power Apparatus and Systems*, vol. PAS-102, no. 10, October.
- Cruz P., Izquierdo, C., Burgos, M., Ferrer, L.F., Soto, F., Llanos, C. and Pacheco, J.D. (2002), "Magnetic field mitigation in power lines with passive and active loops" *Proceeding of Cigré Session*, Paper No. 36-107, Paris.
- Nicolaou, C.P., Papadakis, A.P., Razis, P.A., Kyriacou, G.A. and Sahalos, J.N. (2011), "Measurements and predictions of electric and magnetic fields from power lines" ", *Electric Power Systems Research*, vol. 81, pp 1107–1116.
- Bakhashwain, J.M., Shwehdi, M.H., Johar, U.M. and AL-Naim, A.A. (2003), "Magnetic Fields Measurement and Evaluation of EHV Transmission Lines in Saudi Arabia", *Proceedings of the International Conference on Non-Ionizing Radiation at UNITEN (ICNIR 2003) Electromagnetic Fields and Our Health 20th –22nd October*.
- Filippopoulos, G. and Tsanakas, D. (2005) "Analytical calculation of the magnetic field produced by electric power lines", *IEEE Transaction on Power Delivery*, vol. 20, no. 2, pp. 1474 –1482.
- Chung, Yi-Li., Sung, F.-C., Chen, F.-L., Lee, P.-C., Silva, M. and Mezei, G. (2007), "Extremely-low-frequency magnetic field exposure of children at schools near high voltage transmission lines", *Science of the Total Environment*, Vol. 376, pp 151– 159.

- Kim, J., Ha, C.S., Lee, H.J. and Song, K. (2010), "Repetitive exposure to a 60 Hz time-varying magnetic field induces DNA double-strand breaks and apoptosis in human cells", *Biochemical and Biophysical Research Communications* vol.400, pp 739–744.
- Stewart, J.R., Dale, S.J. and Klein, K.W. (1993), "Magnetic field reduction using high phase order lines", *IEEE Transaction on Power Delivery*, vol. 8, no. 2, pp 628 – 636.
- Jonsson, U., Larsson, A. and Sjödin, J.O. (1994), "Optimized reduction of the magnetic field near Swedish 400 kV lines by advanced control of shield wire currents. Test results and economic evaluation", *IEEE Transaction on Power Delivery*., vol. 9, no. 2, 961– 969.
- Memari A.R. and Janischewskyj, W. (1996), "Mitigation of magnetic field near power line" ,*IEEE Transaction on Power Delivery*, vol. 11, no. 3, pp 1577– 1586.
- Lindberg, L. (1998), "Reduction of magnetic fields from electric power and installation lines", *IEE Proceedings on Science, Measurement and Technology*, vol. 145, no. 5, pp 215 – 221.
- Pettersson, P. (1996), "Principles in transmission line magnetic field reduction", *IEEE Transaction on Power Delivery*, vol. 11, no. 3, pp 1587–1592.
- Rashkes, V.S. and Lordan, R. (1998), "Magnetic field reduction methods: efficiency and cost", *IEEE Transaction on Power Delivery*, vol. 13, no. 2. pp. 5521–559.
- Yamazaki, K., Kawamoto, T. and Fujinami, H. (2000), "Requirements for Power Line Magnetic Field Mitigation Using a Passive Loop Conductor", *IEEE Transactions on Power Delivery*, vol. 15, no. 2, pp 646– 651.
- Cruz, P., Izquierdo, C. and Burgos, M. (2003), "Optimum Passive Shields for Mitigation of Power Lines Magnetic Field", *IEEE Transaction on Power Delivery*, vol. 18, no. 4, pp 1357 – 1362.
- Ippolito, L. and Siano, P. (2004), "Using multi-objective optimal power flow for reducing magnetic fields from power lines", *Electric Power Systems Research*, vol. 68, pp 93 – 101.
- Kalhor, H.A. and Zunoubi, M. R. (2005), "Mitigation of power frequency fields by proper choice of line configuration and shielding", *journal of Electromagnetics*, vol. 25, no. 3, pp 231–243.
- Faria, J.A.B. and Almeida, M.E. (2007), "accurate calculation of magnetic field intensity due to overhead power lines with or without mitigation loops with or without capacitor compensation", *IEEE Transaction on Power Delivery*, vol. 22, no. 2, pp 951– 959.
- Romero, P.C., Santos, J.R., López, J.C.D., Jaén, A.V. and Ramos, J.L.M. (2007), "A Comparative Analysis of Passive Loop-Based Magnetic Field Mitigation of Overhead Lines", *IEEE Transaction on Power Delivery*, vol. 22, no. 3, pp 1773 - 1781.
- Radwan, R. M., Abdel-Salam, M., Mahdy, A.M. and Samy, M.M. (2010), "Mitigation of Electric Fields Underneath EHV Transmission Lines Using Active and Passive Shield Wires," *Proceedings of the 8th Regional Conference for National Committee of CIGRE in the Arab Countries*, October 18-20, Doha, Qatar.

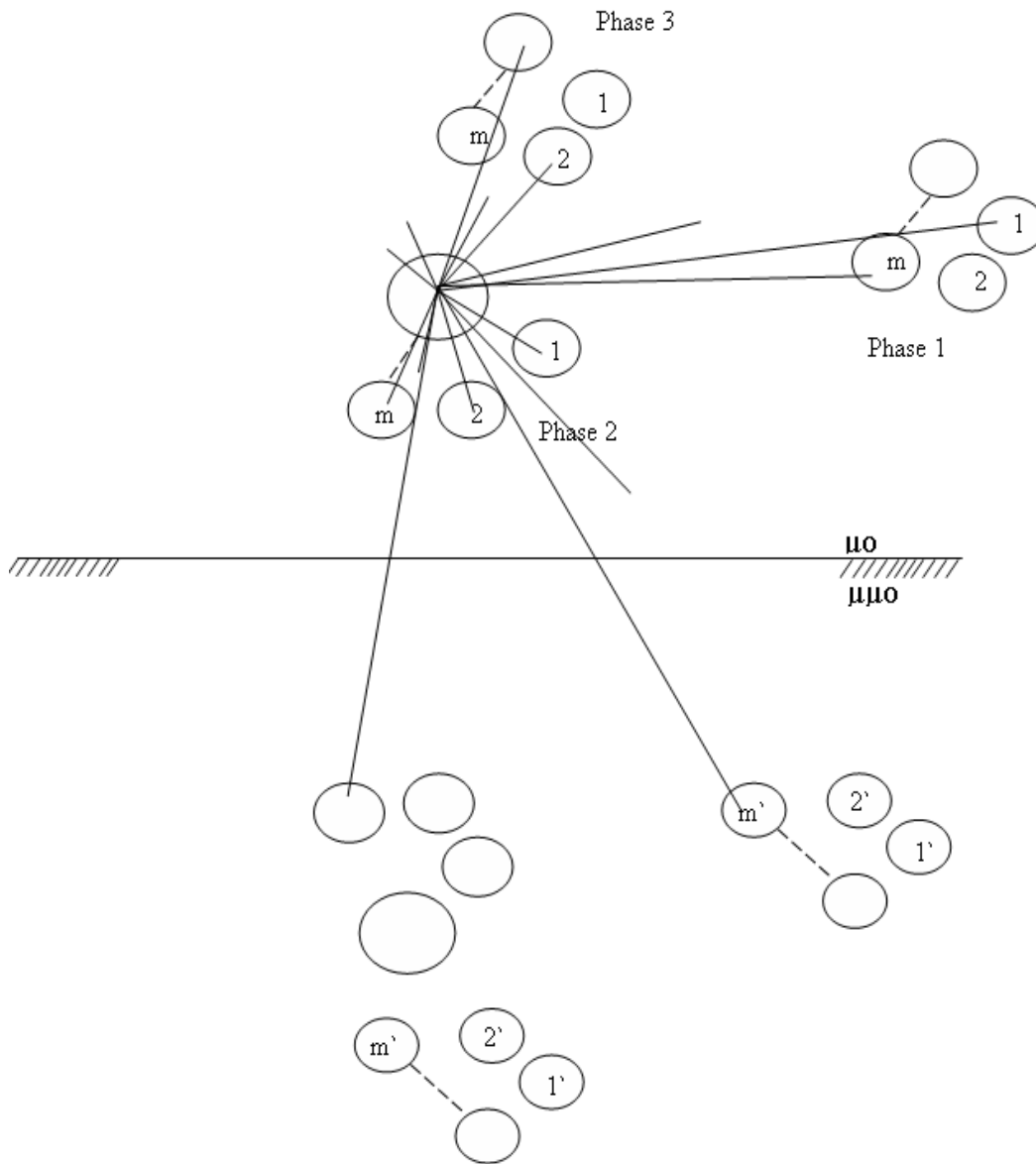

Fig. 1: Three phase transmission line above ground with the images of line conductors.

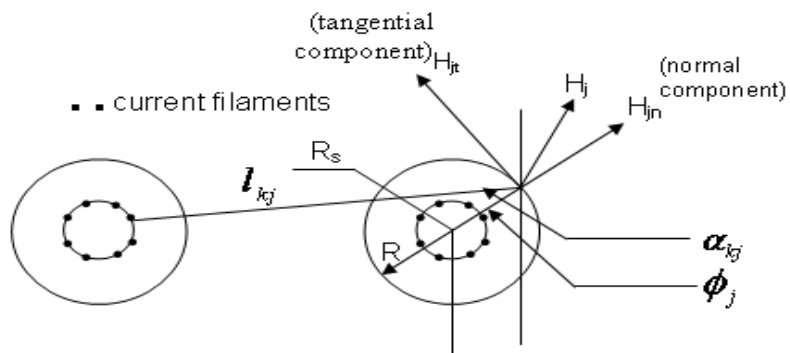
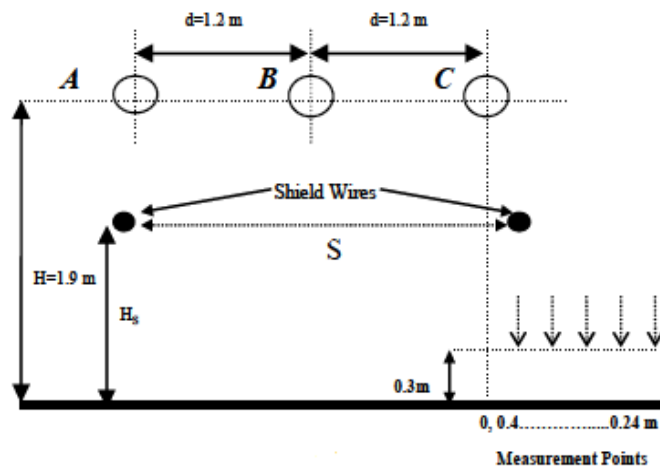
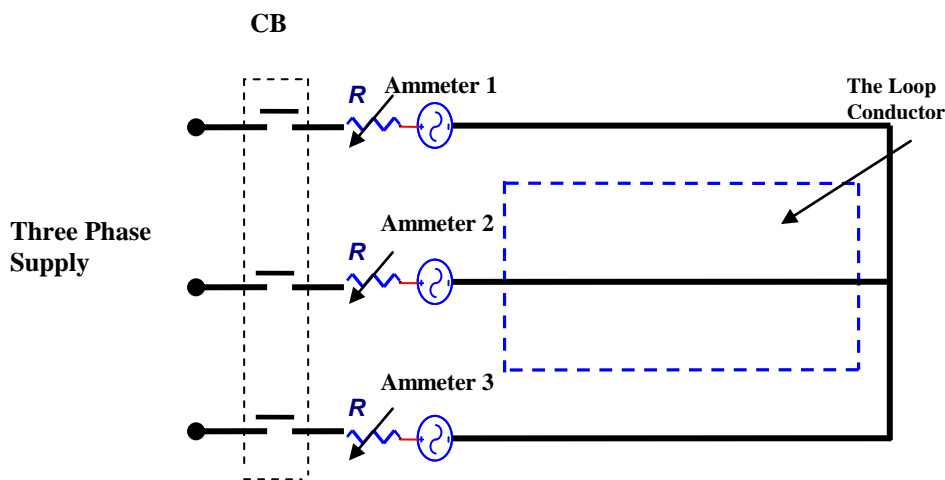

Fig. 2: Normal and tangential field components at a point on the subconductor surface.



(a)



(b)

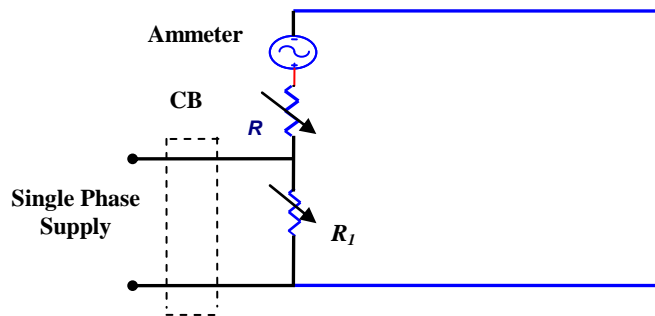

(c)

Fig. 3 Arrangement of phase conductors and shield wires of an experimental circuit for the model

(a) Transmission line model configuration (b) experimental model and (c) Active circuit to drive current in the loop.

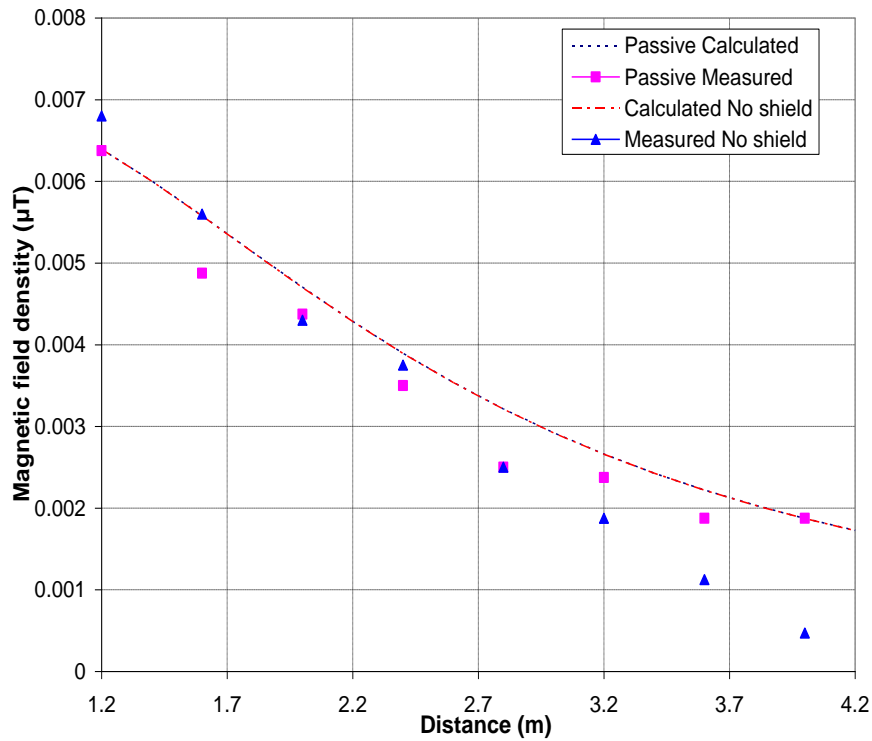

Fig. 4: Comparison of the calculated and measured values of magnetic field distribution at 0.3 m height above the ground surface with and without passive shield wires, $H_s=1$ m, $S=4.3$ m. Phase current = 10 A.

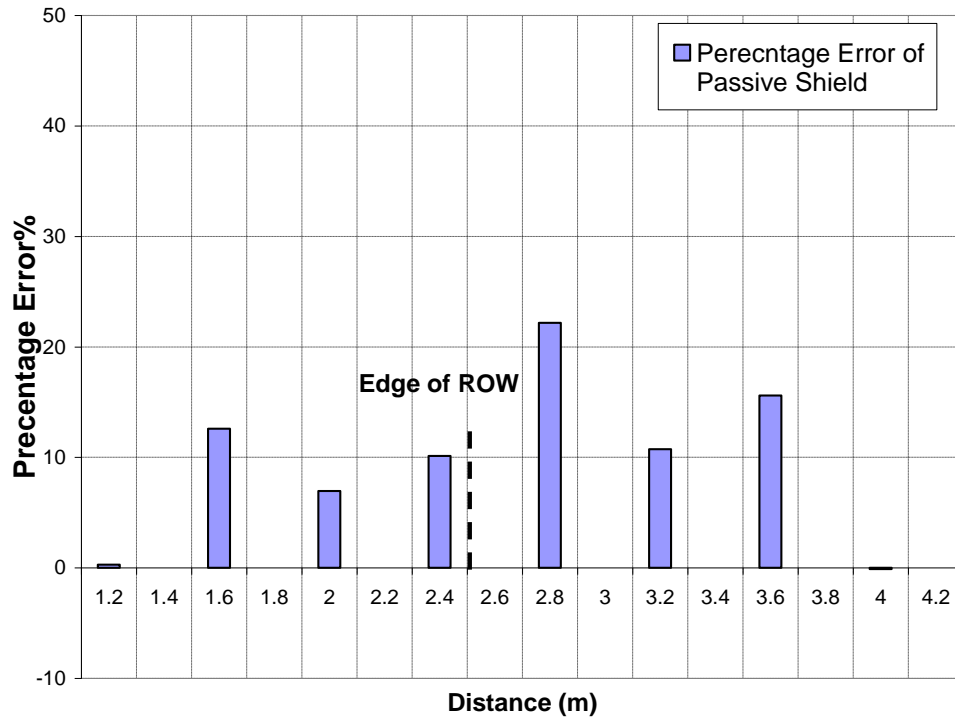

Fig. 5: Percentage error of the magnetic field distribution at 0.3 m height above the ground surface using passive shield wires with $H_s=1$ m, $S=4.3$ m. Phase current = 10 A.

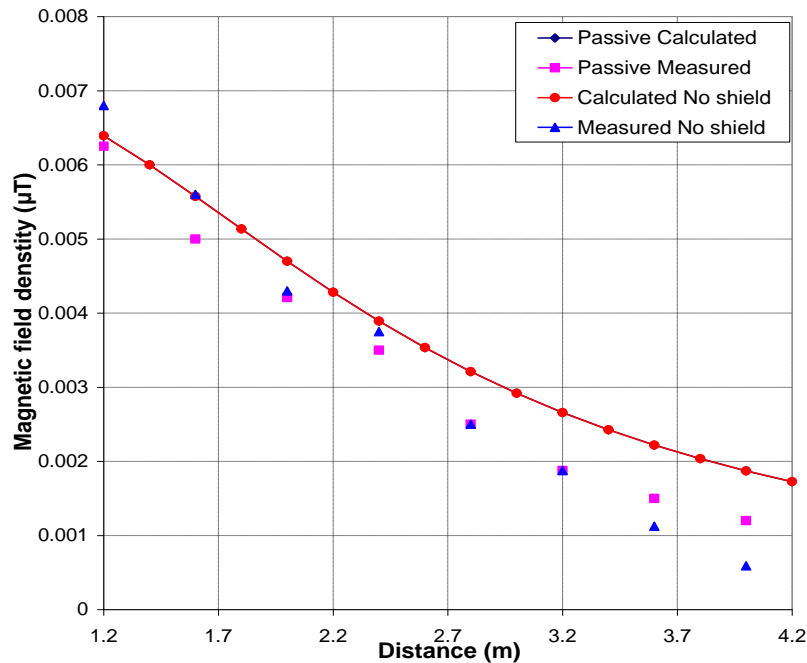

Fig. 6: Comparison of the calculated and measured values of magnetic field distribution at 0.3 m height above the ground level with and without passive shield wires, $H_s=1.45$ m, $S=4.3$ m. Phase current = 10 A.

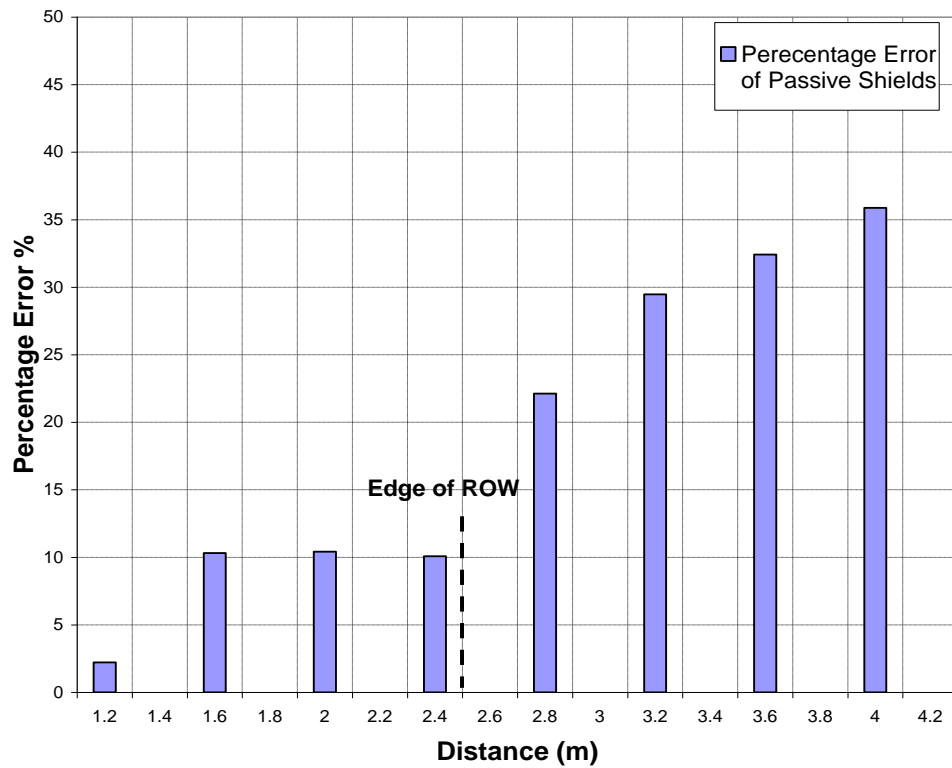

Fig. 7: Percentage error of the magnetic field distribution at 0.3 m height above the ground surface using passive shield wires with $H_s=1.45$ m, $S=4.3$ m. Phase current = 10 A.

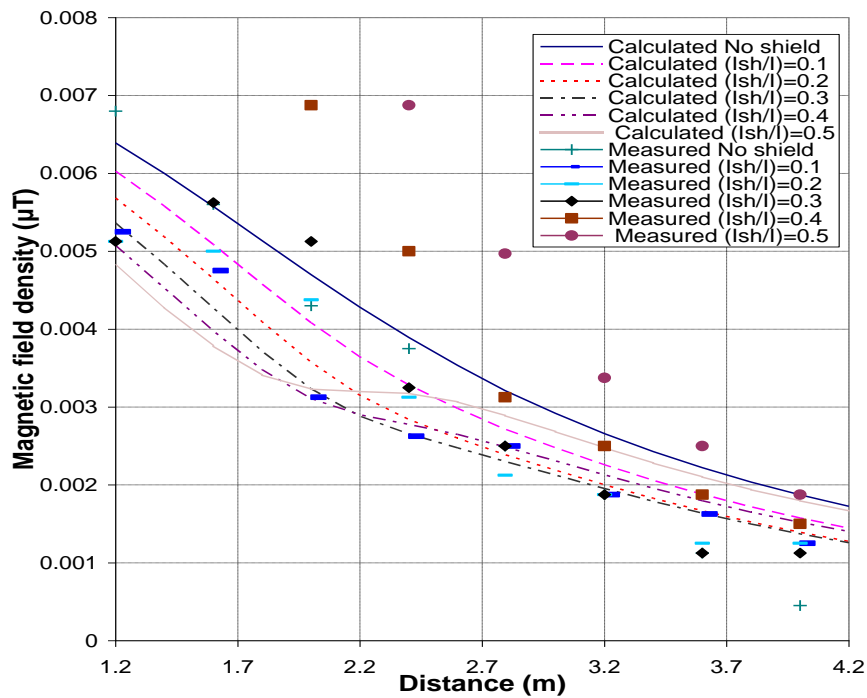

Fig. 8: Comparison of the calculated and measured values of magnetic field distribution at 0.3 m height above the ground surface with and without active shield wires, $H_s=1$ m, $S=4.3$ m, variable shield wires' current. Phase current = 10 A.

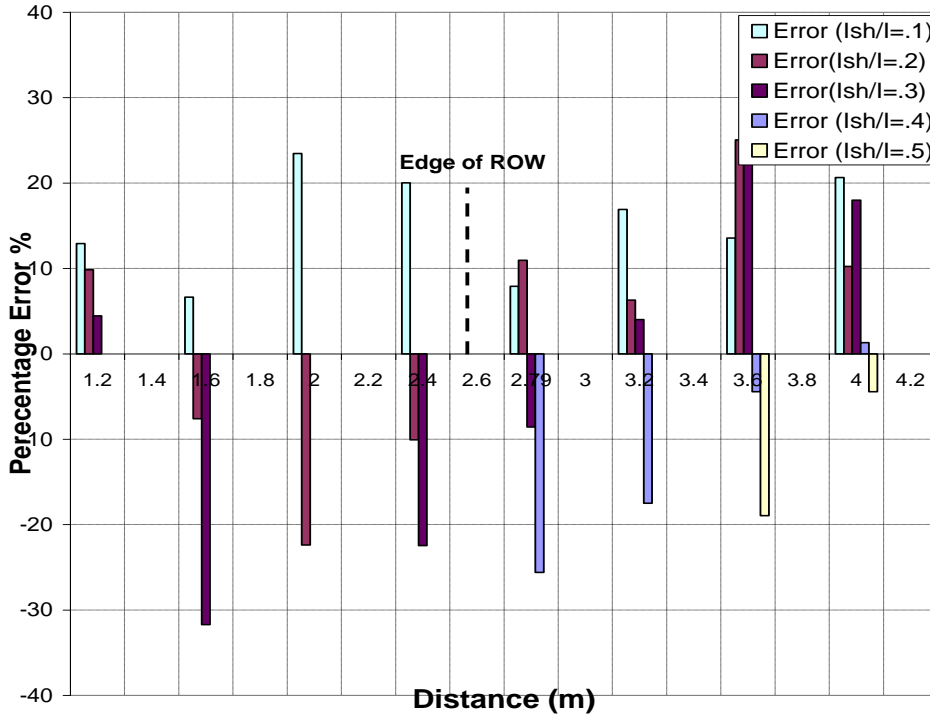

Fig. 9: Percentage error of the magnetic field distribution at 0.3 m height above the ground surface with variable shield wires' current with $H_s=1$ m, $S=4.3$ m. Phase current = 10 A.

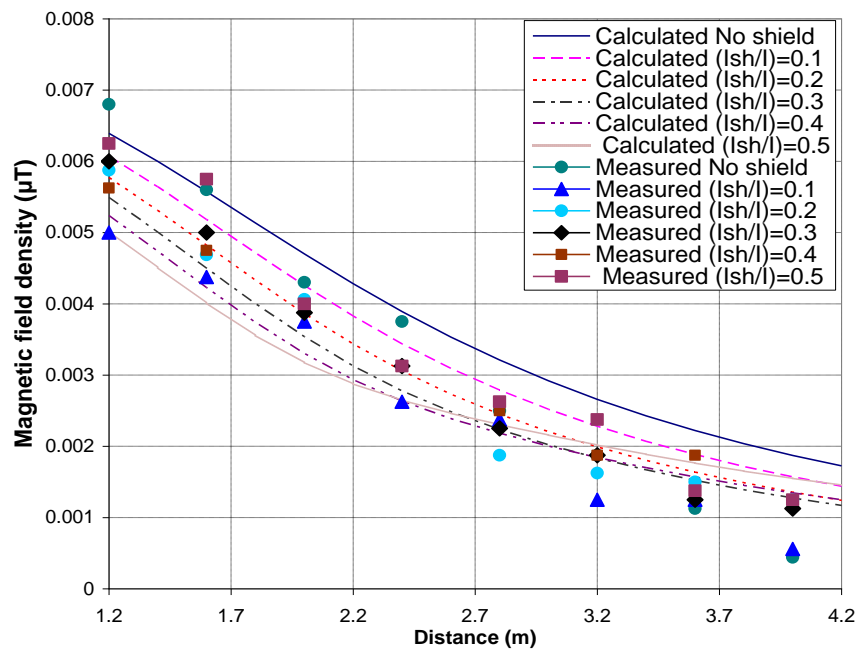

Fig. 10: Comparison of the calculated and measured values of magnetic field distribution at 0.3 m height above the ground surface with and without active shield wires, $H_s=1.45$ m, $S=4.3$ m, variable shield wires' current. Phase current = 10 A.

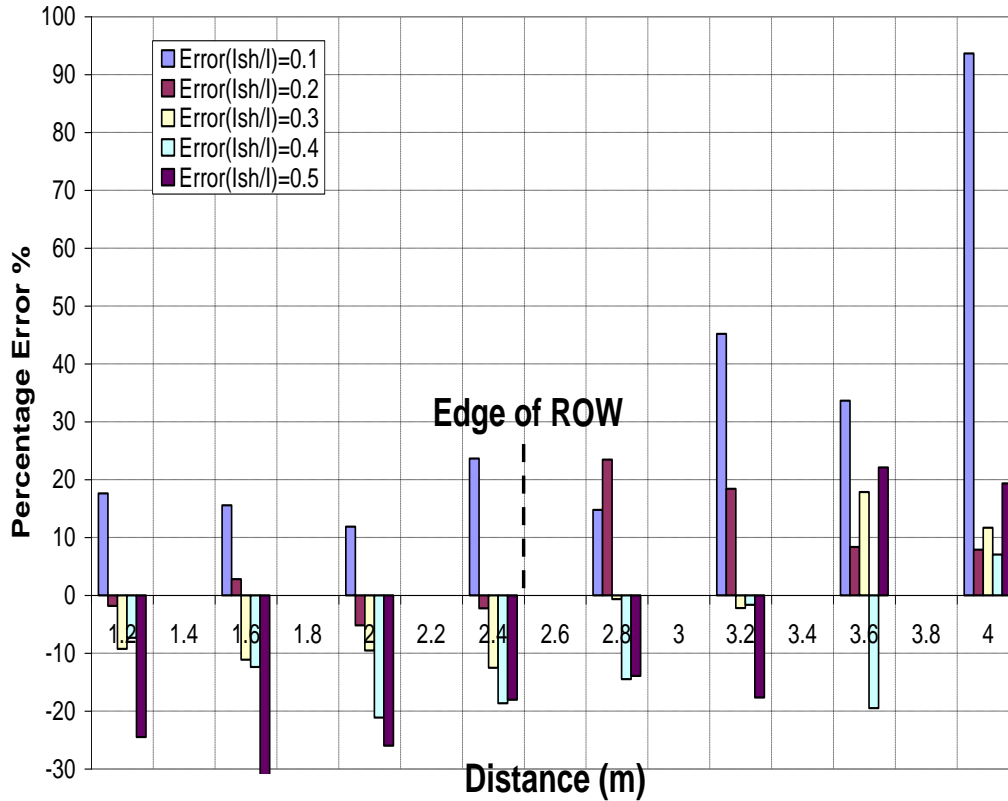

Fig. 11: Percentage error of the magnetic field distribution at 0.3 m height above the ground surface at variable shield wires' current with $H_s=1.45$ m, $S=4.3$ m. Phase current = 10 A.

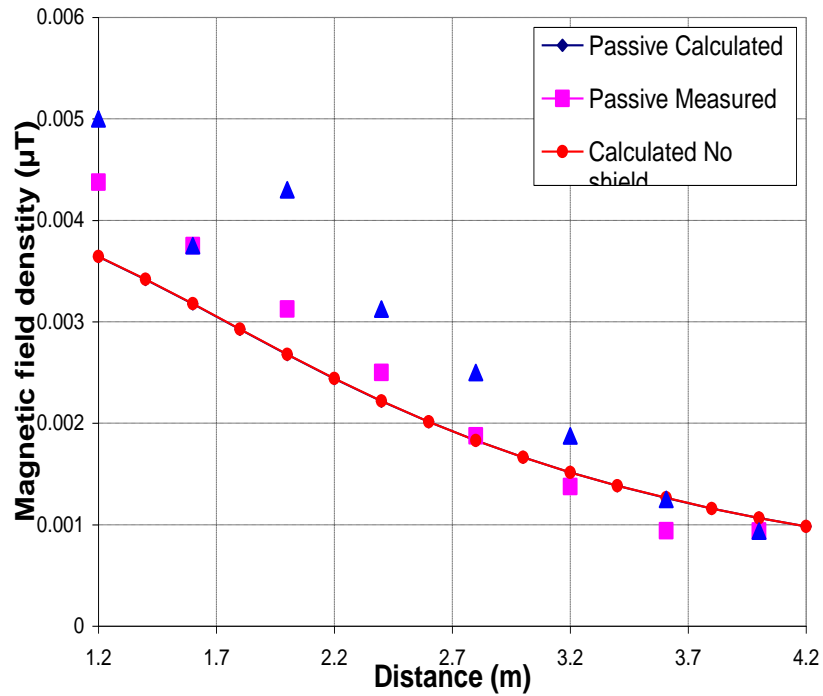

Fig. 12: Comparison of the calculated and measured values of magnetic field distribution at 0.3 m height above the ground surface with and without passive shield wires, $H_s=1$ m, $S=4.3$ m. Phase current = 5.7 A.

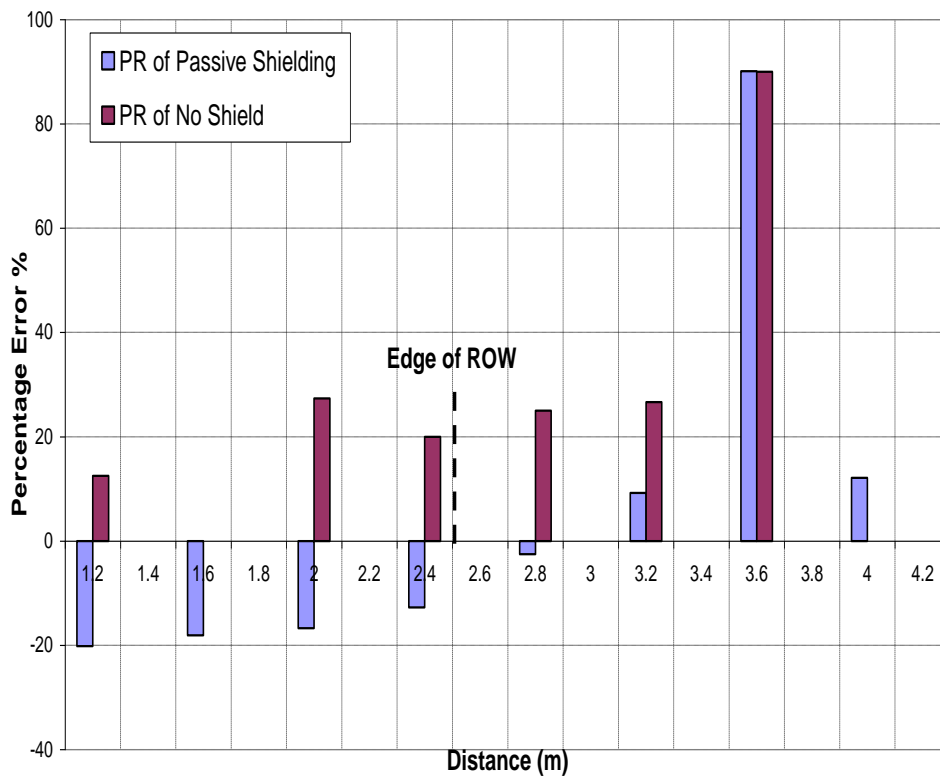

Fig. 13: Percentage error of the magnetic field distribution at 0.3 m height above the ground surface using passive shield wires with $H_s=1$ m, $S=4.3$ m. Phase current = 5.7 A.

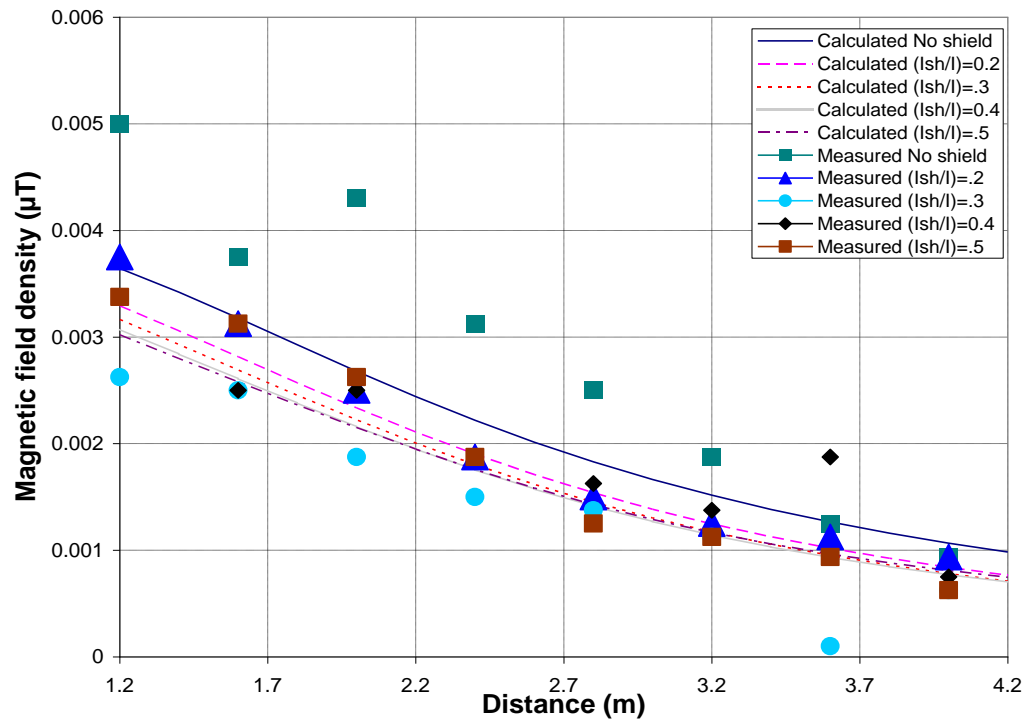

Fig. 14: Comparison of the calculated and measured values of magnetic field distribution at 0.3 m height above the ground surface with and without active shield wires, $H_s=1.45$ m, $S=4.3$ m, variable shield wires' current. Phase current = 5.7 A.

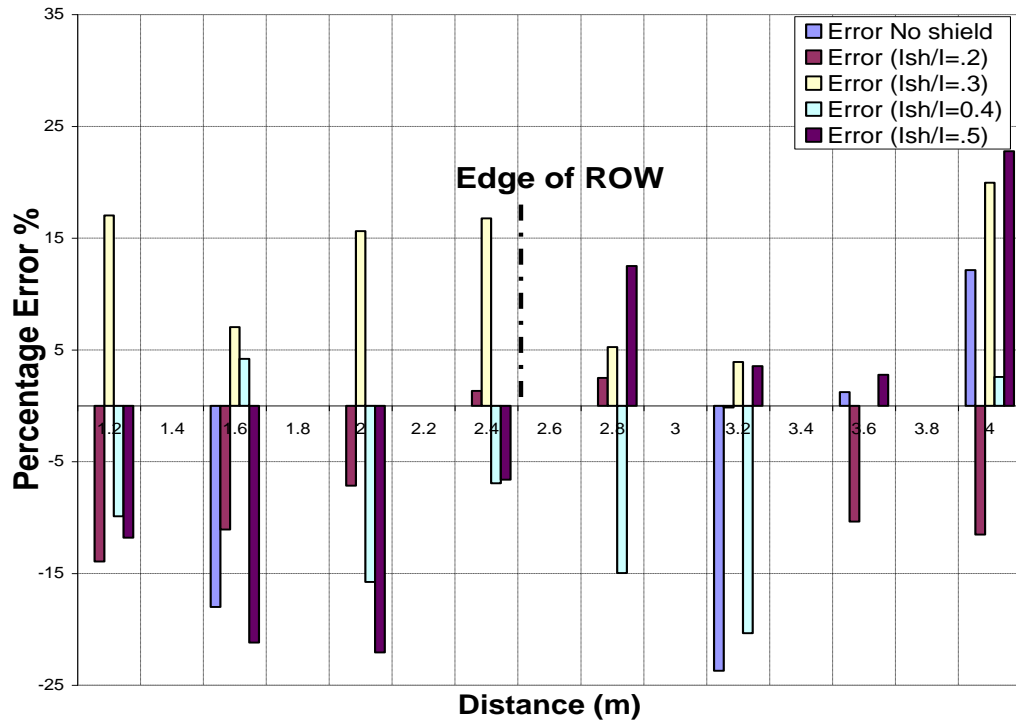

Fig. 15: Percentage error of the magnetic field distribution at 0.3 m height above the ground surface at variable shield wires' current with $H_s=1.45$ m, $S=4.3$ m. Phase current = 5.7 A.

This academic article was published by The International Institute for Science, Technology and Education (IISTE). The IISTE is a pioneer in the Open Access Publishing service based in the U.S. and Europe. The aim of the institute is Accelerating Global Knowledge Sharing.

More information about the publisher can be found in the IISTE's homepage:

<http://www.iiste.org>

The IISTE is currently hosting more than 30 peer-reviewed academic journals and collaborating with academic institutions around the world. **Prospective authors of IISTE journals can find the submission instruction on the following page:**

<http://www.iiste.org/Journals/>

The IISTE editorial team promises to review and publish all the qualified submissions in a fast manner. All the journals articles are available online to the readers all over the world without financial, legal, or technical barriers other than those inseparable from gaining access to the internet itself. Printed version of the journals is also available upon request of readers and authors.

IISTE Knowledge Sharing Partners

EBSCO, Index Copernicus, Ulrich's Periodicals Directory, JournalTOCS, PKP Open Archives Harvester, Bielefeld Academic Search Engine, Elektronische Zeitschriftenbibliothek EZB, Open J-Gate, OCLC WorldCat, Universe Digital Library, NewJour, Google Scholar

