

The University of Chicago Law Review

Volume 84

Fall 2017

Number 4

© 2017 by The University of Chicago

ARTICLES

Patent Law's Authorship Screen

Kevin Emerson Collins[†]

Intellectual property regimes frequently employ boundary screens. Boundary screens protect the different balances of competition and protection that Congress has struck in the different regimes by preventing the goods whose protectability should be determined by one regime from infiltrating into and receiving protection under another regime.

Prior scholarship on boundary screens offers in-depth analyses of the functionality screens in nonpatent intellectual property that avoid upsetting patent law's competition-protection balance for functional innovation. This Article turns the table, asking a previously unasked question about how patent's authorship screen—that is, its boundary screen that prevents infiltration by the authorial innovation that is the proper domain of copyright—does and should work. Shortcomings in patent's authorship screen upset copyright's competition-protection balance, allowing patents to function as abnormally thick backdoor copyrights, just as shortcomings in copyright's functionality screen allow copyrights to function as abnormally long and easy-to-obtain backdoor patents.

In addition to its normative assessment of the authorship screen's importance as a barrier to backdoor copyrights and its descriptive analysis of the statutorily diffuse set of patent doctrines that collectively enforce the

[†] Professor of Law, Washington University School of Law. I thank Scott Baker, Chris Buccafusco, T.J. Chiang, Mark Lemley, Mark McKenna, Sean Pager, Pam Samuelson, Chris Sprigman, Felix Wu, and attendees of the 2017 WIPIP Conference at Boston University for their helpful comments.

authorship screen, this Article presents case studies focusing on architectural innovation, an unstudied zone of overlap on the copyright–patent boundary that illustrates the authorship screen in action.

INTRODUCTION.....	1604
I. POLICY: PATENTS AS BACKDOOR COPYRIGHTS.....	1613
II. DOCTRINE: SCREENING OUT AUTHORIAL INNOVATION	1624
A. Identifying Authorial Innovation.....	1624
B. The Aesthetic Authorship Screen.....	1632
C. The Informative Authorship Screen	1640
D. The Parallels and Divergences.....	1642
III. CASE STUDIES: ARCHITECTURAL DISPOSITIONS OF SPACE	1644
A. Dispositions of Space and What They Do	1646
B. The Authorship Screen Is	1651
1. Permissive for mixed innovation.....	1651
2. Flawed for look-like innovation.....	1657
3. Error prone for multifunctional innovation.....	1664
CONCLUSION	1672

INTRODUCTION

Intellectual property is not a homogeneous body of law. There are several distinct intellectual property regimes—copyright, trademark, utility patent, and design patent, most prominently—and Congress has struck a different balance of competition and protection within each regime. Different regimes have different procedural and substantive requirements for acquiring rights and different rules for determining the scope of rights. Given this diversity, each intellectual property regime must have boundary screens. Boundary screens prevent costly infiltration: they keep the goods that should be protected by a first regime from infiltrating a second regime and upsetting the competition–protection balance for those goods that Congress struck in the first regime.

When the topic of intellectual property boundary screens arises in the law reviews and courts, the usual question is how copyright, trademark, and design patent should deploy functionality screens, that is, the boundary screens that prevent the functional innovation that should be governed by utility patent law (or just patent law, for short) from receiving nonpatent

intellectual property protection.¹ The idea–expression dichotomy of *Baker v Selden*² and the “useful articles” doctrine³ implement copyright’s functionality screen, trademark employs the eponymous functionality doctrine,⁴ and design patent screens out functional innovation by protecting only the ornamental features of manufactures.⁵ All of these doctrines prevent nonpatent intellectual property regimes from sanctioning “backdoor patents” on functional innovation and upsetting the competition–protection balance for functional innovation established in

¹ See generally, for example, Christopher Buccafusco and Mark A. Lemley, *Screening Functionality*, 103 Va L Rev (forthcoming 2017), archived at <http://perma.cc/67KF-BWQ8> (discussing the imperfect functionality screens for copyright, trade dress, and design patent regimes); Mark P. McKenna and Christopher Jon Sprigman, *What's In, and What's Out: How IP's Boundary Rules Shape Innovation*, 30 Harv J L & Tech 431 (2017) (discussing the formation of functionality screens in response to the utility patent's historically preferred place in intellectual property jurisprudence, as well as their inconsistent operation in maintaining these boundaries). See also generally Mark P. McKenna and Katherine J. Strandburg, *Progress and Competition in Design*, 17 Stan Tech L Rev 1 (2013) (discussing the supremacy of utility patent law); Mark P. McKenna, *(Dys)Functionality*, 48 Houston L Rev 823 (2011) (discussing mechanical and aesthetic functionality screens); Viva R. Moffat, *The Copyright/Patent Boundary*, 48 U Richmond L Rev 611 (2014) (discussing the role of copyright's “useful articles” doctrine that excludes “useful things” from the realm of copyright); Viva R. Moffat, *Mutant Copyrights and Backdoor Patents: The Problem of Overlapping Intellectual Property Protection*, 19 Berkeley Tech L J 1473 (2004) (discussing the expansion of intellectual property protections, the more recent overlap between these areas of protection, and the resulting gaps in the doctrine); J.H. Reichman, *Charting the Collapse of the Patent–Copyright Dichotomy: Premises for a Restructured International Intellectual Property System*, 13 Cardozo Arts & Enter L J 475 (1995) (discussing the lines between copyright and patent law for international intellectual property law, as well as hybrid intellectual property regimes that blur these lines); Pamela Samuelson, *Strategies for Discerning the Proper Boundaries of Copyright and Patent Protections*, 92 Notre Dame L Rev 1493 (2017) (presenting various strategies from the literature for distinguishing between patent and copyright law). The reach of copyright protection into computer software raises a thorny boundary-screen issue, but this issue is sui generis due to Congress's decision to extend copyright into an inherently functional subject matter. See note 174. Some scholarship also addresses exclusionary screens at the boundaries of other non-utility patent regimes. See generally, for example, Laura A. Heymann, *The Trademark/Copyright Divide*, 60 SMU L Rev 55 (2007); Richard W. Pogue, *Borderland—Where Copyright and Design Patent Meet*, 52 Mich L Rev 33 (1953).

² 101 US 99 (1879).

³ See 17 USC § 101. See also Richard P. Sybert and Lindsay J. Hulley, *Copyright Protection for “Useful Articles,”* 54 J Copyright Society USA 419, 420–25 (2007) (discussing the genesis of the “useful articles” doctrine and its more modern applications).

⁴ See *Traffix Devices, Inc v Marketing Displays, Inc*, 532 US 23, 29 (2001) (noting the “well-established rule that trade dress protection may not be claimed for product features that are functional”).

⁵ See 35 USC § 171 (“Whoever invents any new, original and ornamental design for an article of manufacture may obtain a patent therefor, subject to the conditions and requirements of this title.”).

patent law.⁶ Recognizing that backdoor patents would generate social costs, scholars have investigated the nature of the functionality that should lead to exclusion from a nonpatent regime,⁷ compiled lists of doctrinal strategies for excluding functional innovation from nonpatent regimes,⁸ and offered normative frameworks for evaluating which of these strategies are appropriate along which boundaries.⁹

Despite this voluminous scholarship on boundary screens, the inverse question has received no attention at all: How does and should patent law screen out the goods that, if they are to be protected, ought to be protected as nonpatent intellectual property?¹⁰ The oversight is puzzling because this question raises similar concerns about social costs that its oft-studied mirror image raises. Contrary to conventional wisdom, patent protection for the goods that should be protected by the nonpatent regimes is not costless. It upsets the competition–protection balances of the nonpatent regimes by overriding nonpatent law’s limitations on scope, mirroring how nonpatent protection for the goods that should be protected by the patent regime upsets the competition–protection balances of the patent regime by overriding patent law’s limitations on duration and protectability. The principal difference between the two questions is a flip in identity of the infiltrating good and the infiltrated regime.

To begin the enterprise of understanding and evaluating patent’s boundary screens, this Article examines patent’s boundary with copyright.¹¹ Copyright’s subject matter is works of

⁶ Moffat, 19 Berkeley Tech L J at 1523–25 (cited in note 1) (describing the “backdoor patent” and the Supreme Court’s failure to address this issue).

⁷ McKenna and Sprigman, 30 Harv J L & Tech at 516–40 (cited in note 1).

⁸ Samuelson, 92 Notre Dame L Rev at 1517–35 (cited in note 1).

⁹ Buccafusco and Lemley, 103 Va L Rev at *48–65 (cited in note 1).

¹⁰ But see Shubha Ghosh, *Patenting Games: Baker v. Selden Revisited*, 11 Vand J Enter & Tech L 871, 894–95 (2009) (arguing that patents should not encompass some expressive gaming innovation); Pamela Samuelson, *Benson Revisited: The Case against Patent Protection for Algorithms and Other Computer Program-Related Inventions*, 39 Emory L J 1025, 1037 n 36 (1990) (arguing that the “printed matter” doctrine prevents patents from upsetting copyright’s balance of protection and nonprotection for texts). Professors Mark McKenna and Christopher Sprigman examine the reach of patent law at its boundary with nonpatent regimes, but they do this in order to determine how the nonpatent regimes should enforce their functionality screens. McKenna and Sprigman, 30 Harv J L & Tech at 516–39 (cited in note 1).

¹¹ This Article also implicitly addresses the boundary screen that prevents the ornamental features of manufactures that are supposed to be protected by design patent from obtaining protection under the utility patent regime because copyright also governs these features.

authorship,¹² so this Article coins the phrase *authorship screen* to describe patent's mirror image of copyright's functionality screen, and it employs the term *authorial innovation* to describe the goods for which copyright should have the authority to establish intellectual property's competition–protection balance.¹³ Patent's authorship screen (hopefully) prevents patents from protecting authorial innovation and serving as backdoor copyrights, just as copyright's functionality screen prevents copyrights from protecting functional innovation and serving as backdoor patents. The argument unfolds in three steps: it articulates a normative framework for identifying the to-date-overlooked costs of patents that function as backdoor copyrights, provides a descriptive analysis of the statutorily diffuse patent doctrine that constitutes the authorship screen, and details case studies of how the authorship screen does and should work in an unstudied zone of overlap on the copyright–patent boundary—namely, architectural innovation.

Patents that serve as backdoor copyrights are problematic because they override the competition–protection balance that Congress has established for authorial innovation via the copyright regime. Roughly speaking, copyright protection is long in duration, thin in scope, and easy to obtain, whereas patent protection is short, thick, and difficult to obtain. The well-recognized concern of copyrights serving as backdoor patents is that protecting functional innovation with copyright makes protection long and easy to obtain when it should be short and difficult to obtain.¹⁴ Inversely, the to-date-unrecognized concern of patents serving as backdoor copyrights is that protection for authorial innovation becomes thick when it should be thin. More specifically, sanctioning patent protection for authorial innovation overrides copyright's requirement to demonstrate copying as part of infringement,¹⁵ its idea–expression dichotomy as

¹² 17 USC § 102(a).

¹³ This Article employs “innovation” in a regime-neutral sense. Functional innovation refers to nonobvious, patentable subject matter, and authorial innovation refers to original, copyrightable subject matter.

¹⁴ See Robert P. Merges, Peter S. Menell, and Mark A. Lemley, *Intellectual Property in the New Technological Age* 491 (Aspen 6th ed 2012); Buccafusco and Lemley, 103 Va L Rev at *6–8 (cited in note 1); Moffat, 48 U Richmond L Rev at 612 (cited in note 1); Reichman, 13 Cardozo Arts & Enter L J at 482 (cited in note 1); Samuelson, 92 Notre Dame L Rev at 1516–17 (cited in note 1).

¹⁵ See *Arnstein v Porter*, 154 F2d 464, 468–69 (2d Cir 1946).

applied in *Nichols v Universal Pictures Corp*,¹⁶ and its fair use doctrine.¹⁷

Recognizing the policy that underpins the authorship screen leads to a more comprehensive cost-benefit accounting of patent protection than is prevalent today. Conventional patent policy is strictly inward looking: it tallies costs and benefits only for the functional innovation that it is supposed to govern, ignoring the costs generated by protecting authorial innovation and tilting copyright's competition-protection balance further toward protection.¹⁸ At the margin, these additional costs may tip the scales and suggest that patent protection ought not to extend as far as it should under the conventional inward-looking policy analysis.¹⁹

As a doctrinal matter, there is no authorship screen in black-letter patent law that announces itself as such. Patent treatises and hornbooks do not mention it. Yet there is clearly law, somewhere, that, somehow, keeps most authorial innovation from infiltrating the patent regime. (Contemporary patent law is not *that* broken.) In gross, the authorship screen resides in patent law's insistence that a good must "do" something innovative to be protected. In its various rhetorical guises, it requires that innovation be "useful,"²⁰ "produce some new effect, or . . . produce an old effect in a new way,"²¹ or have changed "functions" or "method[s] of performing them."²²

The initial challenge, of course, for describing the authorship screen is to identify what properties count as functional and what events constitute doing something in the patent sense. Given the doctrinal requirement for utility, effects, or functions, one might expect patent law to cough up a coherent, positive definition of functionality. The assumption baked into the

¹⁶ 45 F2d 119, 121–22 (2d Cir 1930). The idea-expression dichotomy is usually conceptualized as a single limitation on copyrightable subject matter. However, the dichotomy's two leading cases—*Nichols* and *Baker*—have different normative goals and announce different doctrinal rules. Understanding the difference between these two strains of copyright's idea-expression dichotomy is crucial for understanding patent law's authorship screen. See notes 57–60, 63–64 and accompanying text.

¹⁷ See 17 USC § 107.

¹⁸ See notes 78–82 and accompanying text.

¹⁹ Look-like innovation provides a concrete example of when the outward-looking policy analysis of the authorship screen may tip the scales against patentability. See Part III.B.2.

²⁰ 17 USC § 101.

²¹ *Woodcock v Parker*, 30 F Cases 491, 492 (CC D Mass 1813).

²² William C. Robinson, 1 *Treatise on the Law of Patents for Useful Inventions* § 238 at 322 (Little, Brown 1890).

functionality screens of the nonpatent intellectual property regimes—that functionality has a coherent, positive definition—reinforces this expectation.²³ This Article inverts this conventional wisdom, arguing that the best way to capture what patent law's authorship screen does is to recognize a positive definition of the authorial innovation that it screens out. More specifically, this Article posits that authorial innovation is the sum of *informative innovation* that represents informational content to a human audience and *aesthetic innovation* that allows a human audience to enjoy pleasurable, form-centered experiences. Although copyright does not expressly recognize a distinction between informative and aesthetic works of authorship, patent's definition of unprotectable authorial innovation is incomprehensible without it.

Even with a rough definition of authorial innovation in hand, the descriptive task of documenting patent law's authorship screen is a bit of an adventure. The authorship screen is divided into two parts on two intersecting dimensions.²⁴ First, as foreshadowed above, patent law has two distinct doctrinal screens. An *informative authorship screen* enforced by the printed matter doctrine screens out informative innovation, and an *aesthetic authorship screen* enforced by a combination of the utility and nonobviousness doctrines screens aesthetic innovation. Second, within each of these screens, two different statutory provisions perform two different roles. The first provides a coarse screen. It does the easy work of excluding authorial goods, that is, goods that lack any functional features at all, such as loose-leaf textbooks and sculptures. The facet of the printed matter doctrine that is lodged in the doctrine of patent eligibility of 35 USC § 101 does this work for the informative authorship screen, whereas the utility doctrine, also grounded in § 101, does it for the aesthetic authorship screen.²⁵ The second provides a finer screen. It excludes functional goods that embody authorial innovation—that is, goods with functional properties that are not the locus of the innovation, such as hammers with

²³ McKenna and Sprigman, 30 Harv J L & Tech at 493 (cited in note 1) (arguing that the functionality screens in nonpatent intellectual property work only if there is “a reasonably clear and stable sense of what belongs to utility patent law”).

²⁴ For an overview of the resulting two-by-two matrix, see Part II.D.

²⁵ See 35 USC § 101 (requiring an invention to be a “new and useful process, machine, manufacture, or composition of matter” to be patentable).

new sculptural handles and machines with new labels.²⁶ The facet of the printed matter doctrine that is lodged in the doctrines of novelty and nonobviousness of §§ 102 and 103, respectively, does this work for the informative authorship screen, whereas the nonobviousness doctrine alone today does it for the aesthetic authorship screen.²⁷

The principle of nonobviousness that this descriptive account tasks with administering the finer of the aesthetic authorship screens—termed here the *functionality mandate* of nonobviousness—is worth highlighting. The functionality mandate dates back to Thomas Jefferson’s administration of the Patent Act of 1790²⁸ and the express text of the Patent Act of 1793.²⁹ Yet, today, it has devolved into an advisory—perhaps even obsolete according to some accounts—rule of thumb in contemporary codifications of patent law.³⁰ Without a functionality mandate in nonobviousness, patent law lacks an effective aesthetic authorship screen, so what we currently call an advisory rule of thumb may in fact be more binding, given that patent law must not generate backdoor copyrights.

Patent law’s authorship screens limit patent protection in a wide array of different technologies. The informative innovation screen rebuffs not only applicants who attempt to patent literary

²⁶ Patent doctrine often denies that a claim’s point of novelty is relevant to the determination of patent validity, but it regularly pays attention to it behind the curtain. See Kevin Emerson Collins, *Getting into the “Spirit” of Innovative Things: Looking to Complementary and Substitute Properties to Shape Patent Protection for Improvements*, 26 Berkeley Tech L J 1217, 1238–42 (2011) (arguing for a “spirit” of innovation approach in patent improvement cases that pays attention to the innovative “properties” of improvement inventions, an approach that is conceptually similar to the point-of-novelty approach); Mark A. Lemley, *Point of Novelty*, 105 Nw U L Rev 1253, 1266–74 (2011) (arguing that the “point of novelty” approach should be explicitly adopted by courts so as to better promote innovation). The finer authorship screen tracks the features that make claimed goods innovative, so it is another example of how identifying a claim’s point(s) of novelty is essential for assessing patent validity.

²⁷ See 35 USC §§ 102–03 (requiring that an invention be both novel and nonobvious in light of the prior art). Given that the authorship screen is spread out across the distinct statutory provisions for utility and patent eligibility (35 USC § 101), novelty (35 USC § 102), and nonobviousness (35 USC § 103), identifying the authorship screen requires breaking through the rigid statutory silos that structure most patent discourse. The isolation of these silos helps to explain the black-letter silence on the authorship screen in treatises and hornbooks.

²⁸ 1 Stat 109.

²⁹ 1 Stat 318. For a discussion of how the functionality mandate emerged, see notes 130–34 and accompanying text.

³⁰ For a discussion of the functionality mandate’s diminishment, see notes 142–46 and accompanying text.

storylines,³¹ but also, for example, applicants in the pharmaceutical industry who attempt to use the content of written or oral instructions about how to take a drug to differentiate a claimed invention from the prior art.³² Similarly, the aesthetic innovation screen prevents the visually compelling effect of consumer and industrial goods—ranging from footwear and furniture to graphical user interfaces on the web—from supporting applicants' arguments that their innovations embody patentable departures from the prior art,³³ or at least it does so when an innovative functional feature, such as bioluminescence or the refraction of light, is not generating the visually compelling effect.³⁴

Despite the breadth of the authorship screen's general applicability, this Article examines tightly focused case studies, sacrificing some breadth in order to achieve the depth needed for a fruitful examination of the authorship screen in action. The case studies focus on patents on a particular type of architectural innovation: *dispositions of space*, or the arrangement of spaces that constitutes a building's programmatic layout, as are commonly represented in floor plans and their three-dimensional equivalents.³⁵ Dispositions of space inseparably embody both functional and aesthetic qualities, and they exist in an awkward zone of copyright–patent overlap. They therefore offer excellent terrain for observing and evaluating the authorship screen.

More specifically, the case studies offer three lessons concerning patent law's authorship screen. First, they illustrate that the authorship screen is permissive. Unlike copyright's

³¹ See *Ex parte Knight*, 2014 WL 6984090, *16 (PTAB).

³² See *King Pharmaceuticals, Inc v Eon Labs, Inc*, 616 F3d 1267, 1277–80 (Fed Cir 2010).

³³ The aesthetic authorship screen in utility patent law is the reason why recent fraught discussions over the patentability of product designs and graphical user interfaces have focused on design patents rather than utility patents. See McKenna and Strandburg, 17 *Stan Tech L Rev* at 38–44 (cited in note 1). See also generally Michael Risch, *Functionality and Graphical User Interface Design Patents*, 17 *Stan Tech L Rev* 53 (2013).

³⁴ See notes 236–42 and accompanying text (illustrating the irrelevance of “reverse merger” in the patentability requirements).

³⁵ No previous legal or architectural scholarship considers the patentability of architectural dispositions of space, so this Article opens up a whole new area of copyright–patent overlap to scholarly inquiry. The case studies are enabled by a unique patent dataset that I collected through a citation-snowballing process. For a description of the collection methodology, see note 171.

strict functionality screen, the authorship screen grants protection when functionality and authorship are inseparably fused. This permissiveness sanctions patents that can be leveraged into market power based on consumers' aesthetic preferences, even when the screen is rigorously enforced. Second, the case studies show that the authorship screen systematically mislabels look-like innovation—that is, innovation in which the only functional advance is giving one thing a shape that makes it look like something else—as functional when it should be authorial. Look-like innovation falls into an unplanned gap in between the aesthetic and informative authorship screens, and patents on look-like innovation are backdoor copyrights that upset copyright's competition-protection balance. Third, the case studies show that the US Patent and Trademark Office (PTO) seems to issue patents on what is plainly authorial innovation in dispositions of space on an unusually frequent basis.³⁶ The problem here is not poorly calibrated doctrine but rather PTO errors in the application of the doctrine. One possible explanation for this high frequency of erroneously issued patents is that the authorship screen is too costly to rigorously administer when the claimed technology is highly multifunctional, as dispositions of space are. As the number of different things that an innovation “does” in the patent sense multiplies, the complexity of the argument (and examiner's workload) required to demonstrate a failure to satisfy the functionality mandate increases at something in between a geometric and an exponential rate.³⁷ At some point, the examiner's burden grows too large, the authorship screen tears open, and authorial innovation pours into the patent regime.

Part I identifies the overlooked costs of patents protecting authorial innovation and serving as backdoor copyrights. Part II defines authorial innovation and identifies the doctrine that enforces the authorship screen. Part III examines the authorship screen in action, using patents on architectural dispositions of space as case studies.

³⁶ Some scholars label this error a “false positive” because an intellectual property right that should be invalidated is upheld. Joseph Scott Miller, *Error Costs & IP Law*, 2014 U Ill L Rev 175, 181. Other scholars call it a “false negative” because a boundary screen should invalidate an intellectual property right but does not. Buccafusco and Lemley, 103 Va L Rev at *51–52 (cited in note 1).

³⁷ See note 293 and accompanying text.

I. POLICY: PATENTS AS BACKDOOR COPYRIGHTS

The policy consequences of failures in copyright's functionality screen are well known, but neither commentators nor courts raise red flags about mirror-image failures in patent's authorship screen. For example, Professor Jerome Reichman initially frames the boundary problem and its normative implications in a direction-neutral manner, but he immediately reduces the problem to copyrights serving as backdoor patents:

Because the domestic patent and copyright regimes afford fundamentally different types of protection, the line of demarcation between [patent and copyright] becomes of paramount importance. A line that appears unclear or poorly defended will tempt entrepreneurs to circumvent the strict prerequisites of patent law, with its basic requirements of novelty, utility, and nonobviousness, in order to shelter industrial creations within the more receptive and generous embrace of copyright law, which applies without regard to artistic merit.³⁸

The analysis is insightful as far as it goes, but, like all commentary on the subject, it fails to register the costs of allowing entrepreneurs with authorial creations to circumvent the limitations of copyright law and seek shelter in the patent regime. These costs are just as real as their oft-discussed mirror-image costs.³⁹ Patent's authorship screen preserves copyright's competition-protection balance within its proper domain of authorial innovation,⁴⁰ just as copyright's functionality screen preserves patent's competition-protection balance within its proper

³⁸ Reichman, 13 *Cardozo Arts & Enter L J* at 482 (cited in note 1).

³⁹ Whether they are of the same magnitude is a different question. See notes 82–84 and accompanying text.

⁴⁰ See *Mazer v Stein*, 347 US 201, 217 (1954) (“Unlike a patent, a copyright gives no exclusive right to the art disclosed; protection is given only to the expression of the idea—not the idea itself.”); *Baker*, 101 US at 103 (“The copyright of a book on perspective, no matter how many drawings and illustrations it may contain, gives no exclusive right to the modes of drawing described, though they may never have been known or used before.”). The notion that copyright should be supreme vis-à-vis patent only within its proper domain loosely parallels the notion that copyright has preemptive effects on state law only when the state law impacts an area in which Congress has legislated (absent the federalism issues, of course). Compare *Sears, Roebuck & Co v Stiffel Co*, 376 US 225, 332–33 (1964) (invalidating a state law that upset copyright's competition-protection balance), with *Goldstein v California*, 412 US 546, 558–60 (1973) (upholding a state law that penalized the copying of audio recordings because the Copyright Act did not establish the competition-protection balance for that subject matter).

domain of functional innovation. The Patent Act, like the Lanham Act,⁴¹ must be interpreted narrowly so as to avoid creating a “species of mutant copyright law.”⁴²

To be clear, the notion of intellectual property regimes having proper domains does not mean that copyright actually protects all authorial innovation or that patent actually protects all functional innovation.⁴³ Rather, the point is that copyright and patent should determine the conditions under which authorial and functional innovation, respectively, can and cannot be protected.⁴⁴ In both regimes, Congress, with routine assistance from the courts, has balanced incentive-creating protection with limitations on that protection that enable competition.⁴⁵ These competition–protection balances should not be lightly upset. The purpose of boundary screens is not solely to prevent one regime from protecting that which another regime already protects. It is also to ensure that one regime does not protect that which another regime has the authority to opt not to protect.⁴⁶

⁴¹ 60 Stat 427 (1946), codified as amended at 15 USC § 1051 et seq.

⁴² *Dastar Corp v Twentieth Century Fox Film Corp*, 539 US 23, 33–34 (2003).

⁴³ Nor should an intellectual property regime’s proper domain be confused with its unprotected public domain.

⁴⁴ It is for this reason that this Article does not adopt the perhaps more intuitive term “expressive innovation” to refer to copyright’s proper domain. Expression is what copyright protects. Copyright’s proper domain encompasses both expression and ideas, at least as *Nichols* defines ideas. 45 F2d at 121 (“[B]ut there is a point . . . where [a playwright’s creations] are no longer protected, since otherwise the playwright could prevent the use of his ‘ideas,’ to which, apart from their expression, his property is never extended.”). Copyright’s decision not to protect *Nichols* ideas is part of the competition–protection balance that other intellectual property regimes should respect. Consider note 59 and accompanying text (arguing that ideas as defined by *Baker* are functional entities that lie beyond copyright’s proper domain).

⁴⁵ See 17 USC §§ 107–22 (codifying limitations on copyright’s exclusive rights); 35 USC §§ 101–03, 112 (codifying limitations on patent’s exclusive rights).

⁴⁶ More fundamentally, the notion of intellectual property regimes having proper domains means that the same innovative feature should not be protected by both copyright and patent. See Samuelson, 92 Notre Dame L Rev at 1512–16 (cited in note 1). In contrast, it is common for different features of the same product to be protected by copyright and patent. *Id.* at 1517–21 (“Numerous cases decided after *Baker* have . . . signal[led] that [] copyright protection was available for certain aspects of [a] work . . . but not other aspects . . . that might qualify for exclusive rights if utility-patented.”). In addition, the notion of intellectual property regimes having proper domains also undermines the possibility of allowing innovators to elect the intellectual property regime that they want to govern their innovation. *Id.* at 1521–24 (discussing a case in which a patent holder’s election to obtain a patent on his creation precluded his later attempts to procure a copyright), citing *Korzybski v Underwood & Underwood, Inc*, 36 F2d 727, 728–29 (2d Cir 1929). Allowing innovators to elect their intellectual property regime would always lead

The strength of intellectual property rights can be measured on several distinct dimensions, and copyright and patent are each stronger on some of them. In gross, copyright protection is long, thin, and easy to obtain, whereas patent protection is short, thick, and difficult to obtain. When the functional innovation that is supposed to be protected by patent law infiltrates the copyright regime, the well-known concern is that protection becomes long and easy to obtain when it should be short and difficult to obtain.⁴⁷ Inversely, when the authorial innovation that is supposed to be protected by copyright law infiltrates the patent regime, the overlooked concern is that protection becomes thick when it should be thin.

When functional innovation infiltrates the copyright regime, copyright can override patent's limitations on both the ability to obtain rights and the length of protection. Patent law requires protectable innovation to be novel and nonobvious,⁴⁸ whereas copyright imposes only the more easily satisfied originality standard.⁴⁹ Only inventors who file a patent application with the

to the protection with the greatest private benefits and, relatedly, the greatest social costs.

⁴⁷ For a discussion of those costs, see note 14 and accompanying text. In addition, copyright offers innovators more-powerful remedies than patent does once infringement has been proven. Copyright permits disgorgement of an infringer's profits and significant statutory damages. See 17 USC § 504(a)–(b) (permitting disgorgement); 17 USC § 504(c) (permitting statutory damages). Patent permits neither, restricting damages to a reasonable royalty or the patentee's profits. See 35 USC § 284. Patent damages can, however, be trebled when an infringer's conduct is egregious. See *Halo Electronics, Inc v Pulse Electronics, Inc*, 136 S Ct 1923, 1932–36 (2016) (clarifying the conditions under which patent damages can be enhanced). Copyright also grants attorneys' fees far more often than patent does. Patent's fee-shifting provision requires "exceptional cases." 35 USC § 285. See also *Octane Fitness, LLC v ICON Health & Fitness, Inc*, 134 S Ct 1749, 1751 (2014) (holding that an "exceptional" case "is simply one that stands out from others with respect to the substantive strength of a party's litigating position (considering both the governing law and the facts of the case) or the unreasonable manner in which the case was litigated"). On the other hand, copyright's fee-shifting provision does not. 17 USC § 505. See also *Kirtsaeng v John Wiley & Sons, Inc*, 136 S Ct 1979, 1988 (2016) ("§ 505 confers broad discretion on district courts and, in deciding whether to fee-shift, they must take into account a range of considerations beyond the reasonableness of litigating positions.").

⁴⁸ See 35 USC §§ 102–03. For further discussion, see notes 123–26 and accompanying text.

⁴⁹ See 17 USC § 102 ("Copyright protection subsists . . . in original works of authorship . . ."). Originality requires both that an author independently create, rather than copy, expression, *Sheldon v Metro-Goldwyn Pictures Corp*, 81 F2d 49, 54 (2d Cir 1936), and that the expression embody a modicum of creativity, *Feist Publications, Inc v Rural Telephone Service Co*, 499 US 340, 348, 358 (1991). Copyright does not require any showing of a significant or meritorious advance over existing expressive works.

PTO and take on the costs of patent prosecution can obtain a patent, meaning that many inventors who are legally eligible for patents will not actually acquire them.⁵⁰ In contrast, copyright vests automatically upon the fixation of expression in a tangible medium, so authors acquire copyrights whether or not they value them at the time of creation.⁵¹ In addition, patent's term of protection is relatively short. Today, patent rights usually terminate twenty years from the date on which a patent is filed,⁵² whereas copyrights usually last the life of the author plus another seventy years.⁵³ Given these dimensions on which patents are systematically weaker than copyrights, allowing functional innovation to infiltrate the copyright regime would undermine patent's competition-promoting limitations on rights.

To avoid this costly infiltration, copyright employs both the useful articles doctrine and the idea-expression dichotomy of *Baker* to enforce a functionality screen. Originally articulated by the Supreme Court in *Mazer v Stein*,⁵⁴ the useful articles doctrine prevents copyright from protecting functional aspects of three-dimensional sculptural works, which are most commonly artifacts of industrial design.⁵⁵ The useful articles doctrine is strict in a way that makes copyright deferential to patent: it denies protection to the functional features of useful articles that cannot "be identified separately from, and are [in]capable of existing independently of, the utilitarian aspects of the article."⁵⁶ When the same innovative feature is both expressive and functional and the feature's two attributes cannot be separated

See *Bleistein v Donaldson Lithographing Co*, 188 US 239, 251–52 (1903) (warning against "persons trained only to the law to constitute themselves final judges of the worth of pictorial illustrations").

⁵⁰ That is, patent examination provides not only a substantive screen but a costly one as well. See generally Jonathan S. Masur, *Costly Screens and Patent Examination*, 2 J Legal Analysis 687 (2010) (arguing that the high costs associated with obtaining and prosecuting patents are valuable for screening out low-value patents).

⁵¹ See 17 USC § 102(a) ("Copyright protection subsists . . . in original works of authorship fixed in any tangible medium of expression . . ."). See also 17 USC § 101 (defining "fixed").

⁵² See 35 USC § 154.

⁵³ See 17 USC § 302(a). This general rule assumes an individual author, no work for hire, and a recently created work. For the full rules of copyright duration, see 17 USC §§ 302–05.

⁵⁴ 347 US 201 (1954).

⁵⁵ *Id.* at 217–19 (distinguishing between copyright law's and patent law's protections).

⁵⁶ 17 USC § 101 (defining a "useful article" as a species of "pictorial, graphic, and sculptural works").

either physically or conceptually, the functionality screen excludes the innovation from the copyright regime, ceding jurisdiction over the innovation to patent.⁵⁷ The idea-expression dichotomy of *Baker* similarly prevents copyright from protecting the functional—and possibly, but not necessarily, patentable—methods represented in literary works.⁵⁸ Drawing a distinction between the actual practice of the functional method (an uncopyrightable idea) and the manner in which the method is represented in a text (possibly copyrightable expression), *Baker* keeps functional innovation from receiving copyright protection.⁵⁹ Here, too, copyright's functionality screen is strict, making copyright deferential to patent. If expression that would under other circumstances be protected is integral to the practice of a functional method, copyright does not allow protection for the expression to be leveraged into protection for the functional method.⁶⁰ The idea and expression are said to have merged when the expression is only one of a few expressions that allow performance of the functional method, and the merged idea-and-expression is not

⁵⁷ See, for example, *Brandir International, Inc v Cascade Pacific Lumber Co*, 834 F2d 1142, 1147–48 (2d Cir 1987) (rejecting copyright protection for a bike rack); *Carol Barnhart Inc v Economy Cover Corp*, 773 F2d 411, 419 (2d Cir 1985) (rejecting copyright protection for a model of a human torso for displaying clothes); *Kiesselstein-Cord v Accessories by Pearl, Inc*, 632 F2d 989, 993–94 (2d Cir 1980) (allowing copyright protection for a belt buckle).

⁵⁸ See *Baker*, 101 US at 103–04; *Mazer*, 347 US at 217–19. *Baker* is now codified in the Copyright Act. See 17 USC § 102(b) (“In no case does copyright protection . . . extend to any idea, procedure, process, system, method of operation, concept, principle, or discovery.”).

⁵⁹ Pamela Samuelson, *The Story of Baker v. Selden: Sharpening the Distinction between Authorship and Invention*, in Jane C. Ginsburg and Rochelle Cooper Dreyfuss, eds, *Intellectual Property Stories* 159, 181–82, 186–88 (Foundation 2006) (noting that *Baker* established that “innovative useful arts are not copyrightable subject matter” and that some functional innovations are better suited for patent protection rather than copyright). *Baker* might be more accurately captured as a method–representation distinction. See id at 183–85 (interpreting one of *Baker*'s legacies to be a “system/description distinction”). *Baker* draws a line between actual uses of functional subject matter (unprotectable ideas) and representations of that subject matter (which may or may not be protectable, depending, among other things, on *Nichols* and thus the level of generality at which the representation operates). See notes 65–66 and accompanying text. The idea-expression dichotomy of *Baker* therefore serves entirely different normative goals than the idea-expression dichotomy of *Nichols* serves. *Baker* enforces part of copyright's functionality screen to prevent copyright protection for functional innovation, whereas *Nichols* limits copyright's reach into highly general, nonfunctional innovation.

⁶⁰ *Morrissey v Proctor & Gamble Co*, 379 F2d 675, 678–79 (1st Cir 1967). The merger doctrine has its roots in *Baker*'s discussion of the limitations on copyright in blank accounting forms. *Baker*, 101 US at 103–04.

protectable.⁶¹ In merger, copyright's goal of screening out functional innovation trumps its goal of incenting the production of original expression.

Inversely, when authorial innovation infiltrates the patent regime, patent rights can undermine copyright's limitations and generate protection that upsets copyright's competition-protection balance within its proper domain. At first glance, this may not seem to be a worrisome scenario, especially if one considers only the ease of acquiring rights and the duration of rights that are commonly addressed in connection with copyright's functionality screen. Reichman's "entrepreneurs" may seem to have little to gain, and the public may seem to have little to lose, when they seek patents for authorial innovation.⁶² Why worry that an author who is entitled to an easy-to-obtain, long-lived copyright can also obtain a difficult-to-obtain, short-lived patent? The reason for concern becomes clear, however, when one recognizes that patents provide thicker protection than copyrights do. On this scope dimension of the strength of rights, patents offer a backdoor way of getting strong protection for authorial innovation when authors should be entitled only to weak protection under copyright.

Copyright places three significant limitations on the scope of authors' rights that patent does not place on inventors' rights. First, copyright infringement requires a showing of actual copying,⁶³ whereas independent invention is not a defense to patent infringement.⁶⁴ Copying can be difficult to prove, so obtaining a patent in addition to a copyright has significant benefits for a rights holder. Second, the idea-expression dichotomy of *Nichols*

⁶¹ *Baker*, 101 US at 103-04; *Morrissey*, 379 F2d at 678-79.

⁶² See Reichman, 13 *Cardozo Arts & Enter L J* at 482 (cited in note 1) (arguing that entrepreneurs will exploit defects in the line between intellectual property regimes so as to circumvent the strict requirements for patents for the more generous embrace of copyrights).

⁶³ Actual copying is often shown through access plus probative similarity. See *Arnstein*, 154 F2d at 468-69 (discussing the evidence used to establish actual copying); *Bright Tunes Music Corp v Harrisongs Music, Ltd*, 420 F Supp 177, 180-81 (SDNY 1976) (recognizing access to a work and similarity to be sufficient to establish actual copying).

⁶⁴ See *Kewanee Oil Co v Bicon Corp*, 416 US 470, 477 (1974) ("If an invention meets the rigorous statutory tests for the issuance of a patent, the patent is granted, for a period of 17 years, giving what has been described as the 'right of exclusion.' . . . This protection goes . . . to copying the subject matter [and] . . . to independent creation.") (citation omitted). Consider Christopher A. Cotropia and Mark A. Lemley, *Copying in Patent Law*, 87 *NC L Rev* 1421, 1454 (2009) (arguing that most litigated patent infringement suits do not involve actual copying).

narrows the scope of authors' rights,⁶⁵ and patent law does not have any doctrine that does the same work that the dichotomy does to limit the scope of inventors' rights. The idea-expression dichotomy of *Nichols* caps the level of generality at which a work can be protected by labeling general descriptions of an innovative work as unprotectable ideas.⁶⁶ Paralleling copyright, patent does cap the permissible generality at which its exclusive rights can be drawn with its disclosure doctrines of enablement and written description,⁶⁷ as well as its rules of means-plus-function claiming.⁶⁸ However, assuming that the authorship screen were to fail and that patents could encompass authorial innovation, these doctrines would allow claims drafted at levels of generality that copyright treats as unprotectable ideas.⁶⁹ Third, copyright has a robust fair use defense.⁷⁰ Patent law has no equivalent. The common-law experimental-use exception is the closest patent analog, and it is so narrow and rigid that it barely limits patent rights at all.⁷¹ The absence of any equivalent to fair use in patent has given rise to a number of proposals for amending the patent laws, but these proposals have not gained any traction.⁷²

⁶⁵ *Nichols*, 45 F2d at 121. The idea-expression dichotomies of *Nichols* and *Baker* are distinct doctrines that further distinct policies. See note 59 (contrasting *Baker* and *Nichols*).

⁶⁶ In Judge Learned Hand's famous formulation:

Upon any work . . . a great number of patterns of increasing generality will fit equally well, as more and more of the incident is left out. The last may perhaps be no more than the most general statement of what the [work] is about, and at times might consist only of its title; but there is a point in this series of abstractions where they are no longer protected, since otherwise the [author] could prevent the use of his "ideas," to which, apart from their expression, his property is never extended.

Nichols, 45 F2d at 121.

⁶⁷ 35 USC § 112(a).

⁶⁸ 35 USC § 112(f).

⁶⁹ Each of the case studies of architectural innovation provides examples of how patents can provide thick protection by protecting innovation at levels of generality that *Nichols* deems to be unprotectable ideas. See Part III.B.

⁷⁰ 17 USC § 107. Fair use is only the most prominent example of a host of statutory limitations placed on a copyright owner's rights that have no parallel in patent law. See 17 USC §§ 102–22 (listing limitations on a copyright owner's exclusive rights).

⁷¹ See *Madey v Duke University*, 307 F3d 1351, 1361–62 (Fed Cir 2002).

⁷² See generally Katherine J. Strandburg, *Patent Fair Use 2.0*, 1 UC Irvine L Rev 265 (2011) (discussing various fair use proposals for patent law and their justifications); Maureen A. O'Rourke, *Toward a Doctrine of Fair Use in Patent Law*, 100 Colum L Rev 1177 (2000) (arguing that a fair use defense should be available for patent law as it is for copyright law).

Given these limitations on the scope of rights that exist in copyright but not patent, a faulty authorship screen that allows authorial innovation to infiltrate the patent regime generates costs. It tilts copyright's competition-protection balance for authorial innovation toward protection. Contemporary patent policy ignores these costs. It does this by adopting a worldview that looks only inward to the innovation within its own proper domain: it assesses only the costs of protection with respect to the functional innovation for which it is supposed to establish the competition-protection balance.⁷³ This worldview creates a narrow frame for patent policy discussions that leaves some of the costs of expansive patent protection out of the picture. At the margin, these additional costs may tip the scales and suggest that patent protection ought not to be as expansive as it is.

The policy argument commonly deployed to justify patent's lax utility requirement⁷⁴ illustrates patent's inward-looking policy and its flaws. Patent law's utility requirement arises from the statutory provision that a patentable invention must be "useful."⁷⁵ Absent a statutory utility, the "quid" of the quid pro quo that underpins the patent bargain has not been satisfied, and the applicant has not provided society with enough of a benefit to justify the costs of exclusive rights.⁷⁶ Outside the chemical arts, courts have defined "useful" only in vague generalities; for example, applicants must disclose "some identifiable benefit" of the technology encompassed within a patent claim,⁷⁷ and utility

⁷³ But see note 156 (citing authors who tasked the printed matter doctrine with keeping patent rights from reaching into the subject matter that should be governed by copyright).

⁷⁴ The utility requirement is lax only outside of the chemical arts. See note 79.

⁷⁵ 35 USC § 101. The Constitution limits congressional power to enact patent laws to provisions that promote progress in the "useful Arts." US Const Art I, § 8, cl 8.

⁷⁶ *Brenner v Manson*, 383 US 519, 534-35 (1966) ("Unless and until a process is refined and developed to this point—where specific benefit exists in currently available form—there is insufficient justification for permitting an applicant to engross what may prove to be a broad field."); Robinson, 1 *Law of Patents* § 338 at 462-63 (cited in note 22).

⁷⁷ *Juicy Whip, Inc v Orange Bang, Inc*, 185 F3d 1364, 1366 (Fed Cir 1999). See also *Seymour v Osborne*, 78 US 516, 548-49 (1870) ("Improvements . . . must be . . . capable of being beneficially used for the purpose for which [they were] designed."). Utility is also easily satisfied because a useful invention need not work better than the prior art. *Lowell v Lewis*, 15 F Cases 1018, 1019 (CC D Mass 1817). Historically, the utility doctrine screened out inventions that were detrimental to society. *Id* ("[T]he law will not allow the plaintiff to recover if the invention be of a mischievous or injurious tendency."). Today, the utility doctrine is morally agnostic, even finding utility in innovation that deceives consumers. See, for example, *Juicy Whip*, 185 F3d at 1366-68 (recognizing that

is widely viewed as a token requirement that demands only a nominal utility.⁷⁸ This lax standard, in turn, is commonly justified by the assumption that consumers are not interested in purchasing innovation with only trivial utility, even absent a patent premium, and that the price-increasing and consumption-decreasing effects of patents on such innovation can be disregarded. As one hornbook puts the idea:

If an invention does not offer much in the way of usefulness to society, the costs temporarily borne by the public because that invention is protected by a patent will not be excessive. Inventions that are only minimally useful will most likely be made or sold in very small quantities, either by the patentee or copyists. The patentee's right to exclude all others from making, using, selling, offering to sell, and importing the claimed invention represents a minimal burden on society in this scenario.⁷⁹

“[t]he fact that one product can be altered to make it look like another is in itself a specific benefit sufficient to satisfy” the utility requirement).

⁷⁸ See Rebecca S. Eisenberg, *Analyze This: A Law and Economics Agenda for the Patent System*, 53 Vand L Rev 2081, 2085 (2000) (“[T]he utility requirement has played little role in evaluating the patentability of mechanical inventions.”); Nathan Machin, Comment, *Prospective Utility: A New Interpretation of the Utility Requirement of Section 101 of the Patent Act*, 87 Cal L Rev 421, 436 (1999) (noting that “the utility doctrine usually has been a low hurdle for patent applicants to clear”); Janice M. Mueller, *Patent Law* 322–25 (Aspen 4th ed 2013) (“Utility is rarely at issue for mechanical or electrical inventions.”); Michael Risch, *A Surprisingly Useful Requirement*, 19 Geo Mason L Rev 57, 58 (2011) (“[T]he requirement that an invention be useful has been nearly nonexistent—essentially ignored.”); Sean B. Seymore, *Making Patents Useful*, 98 Minn L Rev 1046, 1049–50 (2014) (noting the lack of academic literature on the utility requirement given its perceived requirement as a “low bar”). If an invention is inoperable because it fails to do what an inventor says it does, then utility is not satisfied, even outside of the chemical arts. See, for example, *Newman v Quigg*, 877 F2d 1575, 1581–82 (Fed Cir 1989).

⁷⁹ Mueller, *Patent Law* at 324 (cited in note 78). See also Machin, Comment, 87 Cal L Rev at 436 (cited in note 78) (“[T]he marketplace is the ultimate arbiter of an invention's utility.”). The doctrine and policy analyses are different in the chemical arts in which simply being useful as the object of further testing in the laboratory to identify a use is not a patentable utility. Applicants must disclose a practical, real-world use for their inventions. *Brenner*, 383 US at 528–36; *In re Fisher*, 421 F3d 1365, 1374 (Fed Cir 2005). The policy underlying this heightened utility requirement follows from the uncertainty of extrapolating from structure to function in the chemical arts. If an applicant creates a structurally new chemical but cannot figure out how it is useful at the time of filing, costly follow-on innovation may eventually demonstrate that the chemical is extremely useful. If the utility doctrine were not heightened and patent protection were granted too far upstream in the innovation process, there might be too little incentive for the follow-on innovation that is needed to determine the chemical's use. See *Brenner*, 383 US at 536 (recognizing that a “patent is not a hunting license,” nor “a reward for the search, but compensation for its successful conclusion”); Eisenberg, 53 Vand L Rev at

Or, in the oft-quoted words of Justice Joseph Story from two hundred years earlier, if an innovation's "practical utility be very limited, it will follow, that it will be of little or no profit to the inventor; and if it be trifling, it will sink into utter neglect."⁸⁰

This justification of a lax utility requirement employs classic inward-looking patent policy. The statement "[i]nventions that are only minimally useful will most likely be made or sold in very small quantities" examines only markets for the functional innovation that lies within patent's proper domain. It ignores the existence of markets for the authorial innovation that lies within copyright's proper domain and the impact of patents thereon. (If there were no market for any inventions that are "minimally useful" in the patent sense, then all of copyright law would be economically trivial, which it clearly is not.) This restricted tallying of costs, in turn, ensures that the policy concerns of copyright law, and thus the authorship screen, remain invisible in patent law. In contrast, patent policy that is also outward looking would recognize the impact of patent rights on markets for authorial innovation and on copyright's competition-protection balance that structures those markets. As the hornbook quoted above proceeds to note after the quoted passage, an innovation that serves as "an attention-getting item in connection with promotional activities at trade shows, conventions and the like' [] is more than sufficient to satisfy the utility requirement."⁸¹ This stance is sound policy only if one simply

2085–88 (cited in note 78) (offering various ways of understanding the utility requirement). The statutory utilities in the chemical arts include neither highly general uses (for example, use as a medicine) nor throwaway uses (for example, use as landfill or a paper weight). See US Patent and Trademark Office, *Manual of Patent Examining Procedure* § 2107 (9th ed 2014) ("MPEP"). In contrast, the function of a given structure is much more predictable outside of the chemical arts. What you see (structurally) usually allows you to understand what you get (functionally), even years in the future. There is no need to preserve patent incentives for follow-on research directed to finding uses for today's useless, nonchemical technology.

⁸⁰ *Bedford v Hunt*, 3 F Cases 37, 37 (CC D Mass 1817). A distinct argument used to support a lax utility requirement is the avoidance of significant administrative costs. Distinguishing trivial and nontrivial uses would require an examination of the market demand for a patented technology. Mueller, *Patent Law* at 324 (cited in note 78). The validity doctrines are usually structured so that they do not require this examination. Not only are there self-evident line-drawing problems, but the needed data is often unavailable at the time of prosecution. But see *Graham v John Deere Co*, 383 US 1, 17–18 (1966) (noting that commercial success is one of the "secondary considerations" for nonobviousness).

⁸¹ Mueller, *Patent Law* at 322–24 (cited in note 78), quoting Raymond D. Kiefer, *Hat Simulating a Fried Egg*, US Patent No 5,457,821 (filed Feb 22, 1994).

ignores the possibility of patents being able to serve as backdoor copyrights. Many such attention-getting items fall within copyright's proper domain, and subjecting them to patents would upset copyright's competition-protection balance by layering patent's thick rights on top of copyright's thin rights.

Infiltrations in both directions across the copyright-patent boundary generate costs, so the lack of any attention to patent law's authorship screen is a significant oversight. However, this is not to say that flaws in copyright's functionality screen and patent's authorship screen are equally costly. Layering copyright protection that is easy to obtain, long, and thin on top of patent protection that is difficult to obtain, short, and thick is likely more costly than the inverse layering. This cost differential is in large part an artifact of the combination of the greater cost of obtaining patents and the need to elect to obtain patents, but not copyrights, at an early stage, often before the value of the intellectual property is clear.⁸² Public disclosure starts a one-year window within which an innovator must file for a patent.⁸³ Given the cost of a patent application, only innovators who recognize the value of a patent at the time of disclosure will file for one. Innovators who recognize the value of a patent at a later point in time are out of luck. In contrast, copyright vests automatically upon the fixation of a work,⁸⁴ so there is little reason why functional innovators would not take advantage of copyright's long protection when they eventually recognize its value.

In turn, if patents that upset the competition-protection balance of the copyright regime are less costly than copyrights that interfere with patent's competition-protection balance, then patent could reasonably adopt an authorship screen that is less deferential to copyright than copyright's functionality screen is to patent. This reduced deference could manifest itself in two ways. First, the authorship screen could be more permissive. Copyright's functionality screen filters out mixed innovation that is inseparably authorial and functional,⁸⁵ but patent's authorship screen could allow it entry. Second, patent's

⁸² In addition, upsetting the competition-protection balance for functional innovation may be more costly than upsetting the same balance for authorial innovation. This is ultimately an empirical question about the relative social value of functional and authorial innovation.

⁸³ 35 USC § 102(b)(1)(A).

⁸⁴ 17 USC § 102(a).

⁸⁵ See notes 55-61 and accompanying text.

authorship screen could tolerate more erroneously issued patents than copyright's functionality screen tolerates. Interestingly, both attributes of patent's authorship screen surface in the case studies examining architectural innovation in Part III.⁸⁶

II. DOCTRINE: SCREENING OUT AUTHORIAL INNOVATION

No descriptive account of what constitutes authorial innovation or how patent doctrine excludes it exists today.⁸⁷ This Part fills these gaps. The first Section fleshes out what constitutes authorial innovation, and the remaining sections describe the doctrinal mechanics of how patent law screens it out.⁸⁸

A. Identifying Authorial Innovation

Patent law's authorship screen prevents authorial innovation—in other words, innovation that resides in the proper domain of copyright—from infiltrating the patent regime. To achieve this goal, patent law could either offer a positive definition of what is in (functional innovation) or what is out (authorial innovation).⁸⁹ Of the two approaches, identifying what is in may initially seem more promising, and it is in fact the

⁸⁶ See Part III.B.1 (illustrating the authorship screen's permissive nature); Part III.B.3 (identifying conditions under which the authorship screen is error prone). If boundary screens were costless to apply, then strict screens would make sense for both copyright and patent. However, screens that are stricter and that lead to fewer errors entail more administrative costs.

⁸⁷ US law differs from EU law on the latter point. The European Patent Convention explicitly excludes aesthetic creations and presentations of information. European Patent Convention Art 52(2)(b), (d) (2016), archived at <http://perma.cc/GE87-3QJG>.

⁸⁸ This exercise is predominantly descriptive in that the goal is to bring to light the doctrinal mechanics that enforce a boundary of substantive patent protection that already exists. However, it inevitably has two distinct normative aspects. First, in the absence of a well-established explanation for how patent law stays out of copyright's way and some confusion in the case law, it chooses one set of doctrinal mechanics over other possibilities, implicitly arguing that these doctrines should be recognized as the doctrines that do the needed patent-limiting work. Here, the "should" is based on theories about conceptual simplicity and best fit with what we already know about patent doctrine. Second, any proposal that fixes previously unidentified doctrine for enforcing the authorship screen will impact how some controversial cases at the margin of patent's substantive reach are resolved. See Part III.B.2 (arguing that the definition of authorial innovation articulated in Part II.A suggests that look-like innovation should not satisfy patent law's functionality mandate).

⁸⁹ I borrow the what-is-in/what-is-out terminology from Professors McKenna and Sprigman, although I place more meaning on the difference between the two phrases than McKenna and Sprigman do. See generally McKenna and Sprigman, 30 *Harv J L & Tech* (cited in note 1).

approach that examiners and judges likely use when dealing with core categories of patentable functionalities. However, when the functionality at issue moves beyond this core to a diverse periphery, identifying what is out is far easier to articulate and map onto how patent law works.⁹⁰

Identifying what is in may initially seem like the more promising approach for administering the authorship screen because at least there is patent doctrine that is clearly relevant to the problem at hand.⁹¹ A group of statutory provisions—namely, utility, nonobviousness, and statutory subject matter—articulate what can be conceptualized as a single requirement that only functional innovation can be patented.⁹² In its various rhetorical guises, this functionality requirement mandates that patentable innovation be “useful,”⁹³ “produce some new effect, or . . . produce an old effect in a new way,”⁹⁴ or have changed “functions” or “method[s] of performing them.”⁹⁵ For most patent applications, the promise of the what-is-in approach holds up. There are core categories of doing something that count as functional in the patent sense that examiners and judges can identify with little effort. For example, innovation that does something new in a physical or mechanical sense is clearly functional.⁹⁶ Because it does something physical, a new Rube Goldberg machine for rotating a matchstick is a functional innovation, even if there is no good reason for a matchstick to be pointing in one direction rather than another.⁹⁷ In a similar

⁹⁰ The what-is-out approach also has a conceptual bonus: it highlights the need for outward-looking patent policy in addition to the inward-looking policy that predominates today. See note 116 and accompanying text.

⁹¹ In addition, nonpatent doctrines treat functionality as a concept with a positive definition when they administer their functionality screens. See note 23 and accompanying text.

⁹² See Parts II.B–D (analyzing these statutory provisions).

⁹³ 17 USC § 101.

⁹⁴ *Woodcock v Parker*, 30 F Cases 491, 492 (CC D Mass 1813).

⁹⁵ Robinson, 1 *Law of Patents* § 238 at 322 (cited in note 22).

⁹⁶ See Dennis S. Karjala, *The Relative Roles of Patent and Copyright in the Protection of Computer Programs*, 17 *John Marshall J Computer & Info L* 41, 41–42 (1998) (capturing patent's core utility as “doing work in the physical world”). Another core functionality is information processing. The functionality of computer software and human reasoning follows not from the physicality of electrons being moved about but rather from software's ability to process information. Some algorithms and mental processes are not patentable, but it is not the authorship screen or their status as nonfunctional, authorial innovation that is responsible for the exclusion.

⁹⁷ The machine's greatest commercial value may come from being displayed in an art gallery as kinetic art, but it still passes through the authorship screen.

vein, a mechanical amusement device does something in this core, physical sense, even if its commercial value resides entirely in providing entertainment.⁹⁸

However, the what-is-in approach loses its traction when the alleged functionality moves beyond this core into a diverse periphery that includes, among many others, the functionality of games,⁹⁹ legal arguments,¹⁰⁰ and novelty items.¹⁰¹ If we were to identify what is in by articulating a comprehensive, affirmative definition of patentable functionality, we would need to identify the commonalities among these peripheral, functional innovations that authorial innovations do not share. No scholar or court has offered such a definition, and the heterogeneity of the peripheral functions that count as doing something in the patent sense make crafting such a definition a tall order.¹⁰²

⁹⁸ See *Callison v Dean*, 70 F2d 55, 58 (10th Cir 1934).

⁹⁹ See Ghosh, 11 Vand J Enter & Tech L at 881–86 (cited in note 10); Risch, 19 Geo Mason L Rev at 83–84 (cited in note 78).

¹⁰⁰ Illustrating patent's proper domain of functional innovation with the example of legal argument frames a tricky issue. After the Supreme Court's opinion in *Bilski v Kappos*, 561 US 593 (2010), innovative legal arguments are likely nontechnological, abstract ideas and thus patent ineligible. This limit on patent protection can be interpreted in either one of two ways. On the one hand, the authorship screen could incorporate the prohibition on patenting nontechnological innovation. Innovative legal arguments could be placed beyond patent's proper domain. On the other hand, they could be functional innovations that lie within patent's proper domain but that patent law opts not to protect. See notes 43–45 and accompanying text (noting that the proper domain of an intellectual property regime is the innovation governed by that regime's rules about what should and should not be protected). I define functionality to include some of what nontechnological innovation does, meaning that legal methods and the like lie within patent's proper domain and that it is not the authorship screen that denies them patent protection. In part, this choice reflects a debatable, intuitive understanding of what constitutes functionality in the patent sense. In part, it also reflects a belief in the limited reach of authorial innovation and thus copyright's proper domain. If legal methods and the like were to lie beyond patent's proper domain, then explaining why they are not authorial innovation within copyright's proper domain becomes more difficult. *Baker* supports my position: the Supreme Court held that methods of accounting are not copyrightable because they are functional innovations within patent's proper domain, and accounting is, or at least was at the time, a nontechnological art. *Baker*, 101 US at 103–04.

¹⁰¹ Mueller, *Patent Law* at 322–24 (cited in note 78) (discussing the invention of a “hat in the shape of a fried egg”). But see Part III.B.2 (arguing that some novelty-item innovation should be recognized as authorial innovation).

¹⁰² The difficulty of developing a comprehensive what-is-in definition of the authorship screen leads McKenna and Sprigman to argue that patent law's concept of functionality is undertheorized and incoherent. See McKenna and Sprigman, 30 Harv J L & Tech at 494, 540–42 (cited in note 1). It is certainly true that the functionality that defines patent's proper domain is undertheorized. One of the purposes of this Article is to articulate a theory where none existed before. It is also true that there are zones on the periphery of what constitutes doing something in the patent sense that are difficult to

Switching tacks, identifying the authorial innovation that is out under the authorship screen initially appears to have bleak prospects. Patent doctrine never even invokes, let alone defines, terms like “authorship” or “authorial.”¹⁰³ In fact, it never expressly refers to the screened-out innovation as a positive figure in any manner at all. Yet a simple two-pronged definition of what constitutes authorial innovation surprisingly maps cleanly onto the innovation that patent law deems to be nonfunctional: neither *informative* nor *aesthetic* innovation counts as innovation that does something in the patent sense.

Informative innovation involves innovative signs in a semi-otic sense: the departure from the prior art at issue resides in the representation of ideas and facts for human readers.¹⁰⁴

explain. See, for example, note 114 and accompanying text. Perhaps the difference between incoherence and difficult-to-explain zones on the periphery is in the eye of the beholder, but I believe McKenna and Sprigman overstate the conceptual disarray. The enumerable list of core functionalities (specifying what is in) together with the two-pronged definition of authorial innovation that this Article provides (specifying what is out) do most of the work needed to coherently administer the authorship screen. Some of what McKenna and Sprigman label as incoherence is simply the authorship screen's permissive nature that allows the owner of a mixed-innovation patent to exercise market power based on consumers' aesthetic preferences. See notes 236–38 and accompanying text (discussing a jewelry patent). Some of what they label as incoherence also follows from their premise that patent's proper domain is limited to *technological* functionality in particular. McKenna and Sprigman, 30 Harv J L & Tech, at 497–500 (cited in note 1). I believe that the better approach is to embrace nontechnological functionalities within patent's proper domain and recognize that the patent regime opts not to protect many of them when setting its competition–protection balance. See note 100.

¹⁰³ Even the Copyright Act does not attempt an express definition of a work of authorship. *Copyright Law Revision*, HR Rep No 94-1476, 94th Cong, 2d Sess 51 (1976) (“The phrase ‘original works of authorship[.]’ . . . is purposely left undefined.”). A number of scholars have labored to develop theories of authorship that would, if adopted, limit the reach of Congress's power to expand copyrightable subject matter. See generally Christopher Buccafusco, *A Theory of Copyright Authorship*, 102 Va L Rev 1229 (2016) (articulating a constitutional definition of “authors” that would limit copyright to those who create any subject matter that is capable of producing a mental effect in an audience). See also David Nimmer, *Copyright in the Dead Sea Scrolls: Authorship and Originality*, 38 Houston L Rev 1, 158–212 (2001). However, none of these scholars incorporate functionality as a limit into the definition of a work of authorship. Rather, they treat functionality as a distinct limit on copyright protection. But see note 117 (discussing scholarly commentary that has developed a positive definition of what is nonfunctional in the context of copyright's useful articles doctrine).

¹⁰⁴ See Charles W. Morris, *Foundations of the Theory of Signs* 3 (Chicago 1938) (“[A] sign refers to something for someone.”); Charles Sanders Peirce, 2 *Collected Papers* § 2 at ¶ 228 (Harvard 1932) (“A sign . . . is something which stands to somebody for something in some respect or capacity.”). The presence of a human reader at the end of the chain is critical. Philosophy of mind posits two types of representational capacity: the original or intrinsic representational capacity in a human mental state and the derived representational capacity of worldly things, such as books and diagrams, that exists only because

Informative innovation can be innovative in one of two ways (or a combination of them). It may represent new propositional content—that is, newly discovered facts or newly created fictions or ideas—or it may represent old propositional content in a new manner by using a new syntax or semiotic code. Texts written in natural languages like English, including novels, nonfiction books, instruction manuals, plays, and song lyrics, are the most common type of informative innovation. But, informative innovation is not limited to such natural-language texts. Anything that functions as a sign and represents informational content to a human reader is informative in the required sense. For example, images represent informational content, too, whether they are paintings, diagrams, photographs, or silent motion pictures.¹⁰⁵

Aesthetic innovation is not communicative, or at least it is not communicative in the same way that informative innovation is communicative. Rather, aesthetics are concerned with the perception of beauty¹⁰⁶ or, if beauty is too loaded a term,¹⁰⁷ the

minds, with their original representational capacity, imbue the things with meaning. See John Searle, *Intentionality: An Essay in the Philosophy of Mind* 27 (Cambridge 1983); John Haugeland, *The Intentionality All-Stars*, in *Having Thought: Essays in the Metaphysics of the Mind* 127, 129 (Harvard 1998). In these terms, informative innovation must have derived representational capacity. In contrast, innovation that provides information to organic, mechanical, or electrical machines and that triggers deterministic processes in those machines may have informational content, but it does not have derived representational capacity. It is not informative innovation because there is no human mind at the end of the chain. See Kevin Emerson Collins, *Semiotics 101: Taking the Printed Matter Doctrine Seriously*, 85 *Ind L J* 1379, 1413–17 (2010) (distinguishing information that carries its content because it causes effects and information that represents its content to a human mind).

¹⁰⁵ The difference between natural-language texts and images boils down to a difference between two types of signs: symbols and icons, respectively. A symbol is a sign in which the relationship between the perceived form and the thing or concept that it represents is arbitrary in that it is based on a social convention. See Peirce, 2 *The Collected Papers* § 2 at ¶ 230 (cited in note 104). There is nothing tree-like about the letters that constitute the word “tree.” See Daniel Chandler, *Semiotics: The Basics* 22 (Routledge 2002). An icon is a sign in which there is similarity between the perceived form and its meaning. See Peirce, 2 *The Collected Papers* § 2 at ¶ 230 (cited in note 104). The perceived form of a diagrammatic icon of a tree has tree-like formal properties.

¹⁰⁶ 1 *Shorter Oxford English Dictionary on Historical Principles* 35 (Oxford 5th ed 2002) (defining “aesthetic” as “[t]he philosophy of the beautiful or of art; a system of principles for the appreciation of the beautiful”); *The Random House College Dictionary* 22 (Random House revised ed 1982) (defining aesthetic as “pertaining to a sense of the beautiful”).

¹⁰⁷ See Nick Zangwill, *Beauty*, in Jerrold Levinson, ed, *The Oxford Handbook of Aesthetics* 325, 325–43 (Oxford 2003) (discussing philosophical controversies surrounding the use of beauty to anchor the definition of aesthetic properties).

disinterested, form-focused experience of an object or event.¹⁰⁸ Aesthetic innovation affects viewers, often deeply, but it does so in nonlinguistic, nonsemiotic ways, as viewers do not read an aesthetic innovation to cognitively understand its propositional content.¹⁰⁹ Abstract painting (think Jackson Pollack), the visual look of industrial design, classical music, and contemporary dance are exemplars of aesthetic innovation.

Clearly, informative innovation and aesthetic innovation are functional in a broad, plain-meaning sense of the word. Informative innovation informs, distracts, amuses, and entertains us; aesthetic innovation gives rise to pleasurable feelings that satisfy consumers' utility functions and that consumers are willing to pay for. The barrier to patenting either type of authorial innovation is not that it does nothing at all but rather that it does not do anything in the patent sense of "do." Concerning informative authorial innovation, patent law erases what texts do when they represent information by locating all of the action in the mind of a reader: "Quite simply, books . . . do not *do* anything that provides a practical benefit—they just provide inert information."¹¹⁰ (In contrast, a catalyst in a chemical reaction that does not change molecular structure *does* something.) Similarly, concerning aesthetic authorial innovation, patent law erases the role that the formally pleasing features play in generating an aesthetic experience: a dichotomy between what an innovation does (within patent's proper domain) and how an observer perceives it (beyond patent's proper domain) is commonly evoked to

¹⁰⁸ Jerrold Levinson, 3 *Philosophical Aesthetics: An Overview*, in Levinson, ed, *Handbook of Aesthetics* 9–10 (cited in note 107) (placing "the Kantian conception of aesthetic perception as *disinterested* perception, or perception of something without regard for its real existence or connection to one's interests, but just for the appearances it affords" at the historical core of aesthetics). See also *id.* at 10 (discussing a definition of "aesthetic perception as focused exclusively on *form*, or the arrangement of elements in a sensuous medium, independent of all knowledge of the world"). The emphasis on a form-focused experience in the aesthetic authorship screen should arguably be expanded to include a wider array of sensory experiences. See generally Christopher Buccafusco, *Making Sense of Intellectual Property Law*, 97 *Cornell L Rev* 501 (2012).

¹⁰⁹ But see notes 266–67 and accompanying text (discussing theories of the aesthetic that encompass representation and symbol systems).

¹¹⁰ Risch, 19 *Geo Mason L Rev* at 81 (cited in note 78). See also Robert Patrick Merges and John Fitzgerald Duffy, *Patent Law and Policy: Cases and Materials* 209 (LexisNexis 6th ed 2013) (noting that text does not "do something" in the patent sense); Robinson, 1 *Law of Patents* § 339 at 463–64 (cited in note 22) (stating that a patentable invention must be more than "a scientific process exciting wonder yet not producing physical results").

delimit the reach of patent protection.¹¹¹ Functionality in patent law is thus a term of art, implicitly driven by the outward-looking policy concern of preventing innovation that resides within copyright's proper domain from infiltrating the patent regime.¹¹² The equation of authorial innovation with nonfunctional innovation involves a legal fiction of sorts.¹¹³

¹¹¹ Craig Allen Nard, *The Law of Patents* 227 (Aspen 3d ed 2014). This dichotomy underpins explanations of the difference between the subject matters of utility patents and design patents. See MPEP § 1502.01 (cited in note 79) (distinguishing between design and utility patents). See also note 11 (noting that the authorship screen also excludes innovation within the proper domain of design patents from the utility patent regime). However, the doing–appearance dichotomy is likely a misleading and overly exclusive formulation of the aesthetic authorship screen because it does not account for any visual functionality. See note 263 and accompanying text.

¹¹² Administrative costs, which are part of classic inward-looking patent policy, also support the exclusion of aesthetic authorial innovation from patent law's proper domain. Patent law's nonobviousness requirement entails an objective assessment of the importance of the advance over the prior art as measured by the person having ordinary skill in the relevant (technological) art. See notes 124–26 and accompanying text. Aesthetic experiences are dependent on taste and thus inherently subjective (unless proper taste is codified). See generally Frank Sibley, *Aesthetic Concepts*, 68 *Philosophical Rev* 421 (1959). Aesthetic innovation therefore is not readily amenable to an objective assessment by a person having ordinary skill in the relevant (artistic) art form. See Dennis S. Karjala, *Distinguishing Patent and Copyright Subject Matter*, 35 *Conn L Rev* 439, 453–58 (2003). See also *Bleistein v Donaldson Lithographing Co*, 188 US 239, 251–52 (1903) (refusing to rest copyright validity on the distinction between high and low art). Note that this administrative-cost explanation does not fully explain the exclusion of informative authorial innovation from patent's proper domain. The newly discovered facts that are the content of informative innovation can often be objectively assessed as small or large advances over prior knowledge.

¹¹³ As between informative and aesthetic innovation, aesthetic innovation has the stronger claim to being truly nonfunctional in a plain-meaning sense. One of the defining features—if not the defining feature—of the concept of aesthetic experience when it developed in the eighteenth century was that it must be a “disinterested” experience (that is, an experience that does not provide its experiencer with any utilitarian or instrumental benefit). See note 108 and accompanying text. To the same end, philosophers argue that when we adopt an aesthetic attitude toward art objects, “we do not look at the object out of concern for any ulterior purpose which it may serve” and that “[t]here is no purpose governing the experience other than the purpose of just having the experience.” Jerome Stolnitz, *Aesthetics and Philosophy of Art Criticism: A Critical Introduction* 35 (Riverside 1960) (emphasis omitted). However, this definition of aesthetic experiences as disinterested openly defines a utilitarian or instrumental benefit so as to exclude the satisfaction of consumers' utility functions. Furthermore, a number of modern scholars have challenged whether aesthetic experiences are ever truly disinterested. See, for example, Paul Guyer, *History of Modern Aesthetics*, in Levinson, ed, *Handbook of Aesthetics* 25, 37 (cited in note 107) (recounting Eagleton's argument that the aesthetic “afforded new instruments for the reason employed by the dominant economic and political forces of emerging bourgeois society to exercise control over individuals”). See also *id* at 30–31 (recounting an argument characterizing aesthetics not as “freedom for the simple contemplation of beauty with no further concerns or implications” but rather as “freedom to develop our imaginative and cognitive capacities, to gain knowledge of ourselves and

To be clear, the identification of informative and aesthetic innovation as hard limits on patent's proper domain does not magically resolve all questions about the reach of that domain. Disputes at the margin about what does and should constitute informative and aesthetic innovation remain to be resolved.¹¹⁴ Nonetheless, a positive definition of authorial innovation that aggregates the informative and the aesthetic offers the best foundation for articulating the sorting criteria required to administer the authorship screen. This what-is-out definition gets more traction than any what-is-in definition can get.¹¹⁵ It also has not only the virtue of prompting consideration of outward-looking policy,¹¹⁶ but also the virtue of accurately capturing how patent doctrine implements the authorship screen. The two-pronged definition of the authorial innovation may appear suspect to copyright initiates. After all, it is copyright's proper domain that is being delineated, and yet copyright's definition of a work of authorship does not reference either informative or aesthetic works.¹¹⁷ However, as explored in the following sections,

others, and to imagine new ways of life, a freedom that is valued not simply for its own sake but also because of the benefits the development of these capacities can bring to the rest of our lives").

¹¹⁴ See note 113 (discussing the modern critique of aesthetics as disinterested perception and listing some practical ends that one may achieve through engaging in aesthetic appreciation); note 161 (discussing syntax innovation that creates efficiencies in the production and reception of informational content by a human audience); note 265 (discussing visual functionality). See also Part III.B.2 (addressing look-like innovation).

¹¹⁵ More specifically, it gets more traction when operating beyond patent's core concepts of functionality, such as physical functionality. See notes 96–98 and accompanying text.

¹¹⁶ Defining what is out necessarily raises the issue of copyright's proper domain, emphasizing that a faulty authorship screen generates costs by upsetting copyright's competition–protection balance. See notes 73–81 and accompanying text (distinguishing inward-looking and outward-looking patent policy).

¹¹⁷ Copyright divides works of authorship into eight categories, but the categories do not track the informative–aesthetic distinction. See 17 USC § 102(a). In articles focused on the appropriate reach of copyright law into computer software, Professors Pamela Samuelson and Dennis S. Karjala extrapolate from copyright's useful articles doctrine to suggest a similar, two-pronged definition of the limit of patent law's proper domain. See Karjala, 35 Conn L Rev at 448–50 (cited in note 112); Dennis S. Karjala, *A Coherent Theory for the Copyright Protection of Computer Software and Recent Judicial Interpretations*, 66 U Cin L Rev 53, 56–58 (1997); Pamela Samuelson, *CONTU Revisited: The Case against Copyright Protection for Computer Programs in Machine-Readable Form*, 1984 Duke L J 663, 749. The useful articles doctrine identifies two tasks that a copyrightable feature of a work can perform without being labeled functional. If the task that a work performs is “merely to portray the appearance of the article or to convey information,” performing the task does not constitute being functional. 17 USC § 101. Merely portraying the appearance of an article roughly suggests having the function of

patent's authorship screen is doctrinally bifurcated along precisely the line that divides the two prongs of the definition: two different sets of statutory provisions are responsible for screening aesthetic and informative innovation out of the patent regime.

B. The Aesthetic Authorship Screen

An authorship screen of some kind that prevents aesthetic innovation from infiltrating the patent regime is part of our bedrock understanding of patent protection: neither a new sculpture nor an old hammer with a new, sculptural handle embodies patentable innovation. This certainty as to the outcome, however, coexists with uncertainty as to the means for achieving the outcome. Neither patent commentary nor patent opinions have explored the aesthetic authorship screen's doctrinal mechanics. The argument here posits that the aesthetic authorship screen resides in small part in the utility doctrine of § 101 and in large part in the nonobviousness doctrine of § 103. Utility provides a coarse screen that, at best, excludes nonfunctional goods from patentability. Nonobviousness provides a finer screen that pays attention to a claim's point of novelty and excludes aesthetic innovation in functional goods.

Given the close relationship between the concepts of utility and functionality¹¹⁸ and the common assertion that utility is central to defining the nature of a patentable invention,¹¹⁹ one might reasonably expect the utility doctrine to be the primary enforcer of patent law's aesthetic authorship screen. However, utility is only a bit player, at best.

If confronted with the question, courts might well say that a sculpture or modern dance does not do anything in the sense that the utility doctrine requires, at least when it is used for aesthetic appreciation. But, to do this, they would have to stretch the utility doctrine in a way that, to date, they have not sanctioned. The utility doctrine outside of the chemical arts is commonly described as a token requirement that allows any

satisfying consumers' aesthetic preferences, and merely conveying information more directly invokes representing information to human readers.

¹¹⁸ Some commentators use them almost interchangeably. See, for example, Kenneth W. Dam, *Some Economic Considerations in the Intellectual Property Protection of Software*, 24 *J Legal Stud* 321, 323-24 (1995); McKenna and Strandburg, 17 *Stan Tech L Rev* at 18-19 (cited in note 1).

¹¹⁹ See, for example, *Fujikawa v Wattanasin*, 93 F3d 1559, 1563 (Fed Cir 1996); *Stiftung v Renishaw PLC*, 945 F2d 1173, 1180 (Fed Cir 1991).

assertion of a function to qualify as a statutory utility.¹²⁰ Applicants seeking to patent sculptures or modern dance could easily allege utilities that fall within the core of physical functionality: sculptures are passable paperweights or hammers, and modern dance provides an aerobic workout. If utility is to play any role at all in the aesthetic authorship screen, it must develop a variant of the prohibition on throwaway utilities that today is found only in the heightened utility requirement in the chemical arts.¹²¹

Even assuming that it plays some role in the aesthetic authorship screen, utility still cannot do the brunt of the required work. Utility examines only whether a claimed good, viewed as a whole, does something; it does not inquire into whether the particular feature or features of the claimed good that differentiates it from the prior art is functional.¹²² In other words, utility can (perhaps) screen out nonfunctional goods, but it cannot screen out aesthetic innovation in functional goods because it does not track a claim's point of novelty. While an innovative, wavy metal sculpture might lack a statutory utility, a hammer that uses the same sculpture as its handle has statutory utility because its primary purpose is to pound nails.

The aesthetic authorship screen relies on nonobviousness to do this more difficult work, closer to the copyright–patent boundary, of sorting innovation based on whether its departure from the prior art is functional or aesthetic. Nonobviousness is the stricter of two patent validity rules that measure patent claims against the prior art. Novelty requires only that a valid claim be different from the prior art in some way, meaning that even trivial differences create novelty.¹²³ Nonobviousness is the more demanding requirement that insists that a valid claim embody a significant or important advance over the prior art.¹²⁴ The nonobviousness analysis proceeds in two steps. First, examiners, judges, or jurors undertake some preliminary factual inquiries,

¹²⁰ See notes 77–78 and accompanying text.

¹²¹ See note 79. Professor Michael Risch has suggested that throwaway utilities are not statutory utilities in any art. See Risch, 19 *Geo Mason L Rev* at 71–72 (cited in note 78). If the utility doctrine does not reject throwaway utilities, the functionality mandate of nonobviousness must enforce the entire aesthetic authorship screen.

¹²² But see Risch, 19 *Geo Mason L Rev* at 71–73 (cited in note 78) (arguing that utility is not satisfied when “the proposed uses have nothing to do with what separates the invention from the prior art”).

¹²³ See 35 USC § 102.

¹²⁴ See 35 USC § 103.

one of which involves identifying the differences between the claimed invention and the prior art.¹²⁵ Second, they stand in the shoes of the fictional person having ordinary skill in the art of the invention (PHOSITA) and ask whether these differences support the legal conclusion of nonobviousness.¹²⁶

The second, ultimate question of nonobviousness is a notoriously fact-intensive inquiry; it requires a case-by-case examination that is not usually amenable to bright-line rules.¹²⁷ Nonetheless, there are many rules of thumb that examiners, judges, and jurors can use to identify the kind of departures from the prior art that are more or less likely to be nonobvious to the PHOSITA.¹²⁸ It is one of these rules of thumb that enforces the finer aesthetic authorship screen: a mere change in form is obvious; the change in form must lead to a change in function in order to weigh in favor of nonobviousness. This rule is what this Article calls the *functionality mandate* of nonobviousness: patentability demands functional innovation or functional changes from the prior art.¹²⁹ The functionality mandate has been a part of US patent law ever since the early years of the patent regime. However, its path through the centuries is a bit tortured, as it evolved from a practice to a statutory requirement to a judicially enforced, hard-and-fast rule to the purportedly advisory rule of thumb that exists today.

Thomas Jefferson articulated the functionality mandate in the course of explaining how he and other government officials who were part of the board charged with examining patents under the Patent Act of 1790, the first patent law in the United States, interpreted the novelty requirement.¹³⁰ Jefferson noted

¹²⁵ See *Graham v John Deere Co*, 383 US 1, 14, 17 (1996).

¹²⁶ See *id.*

¹²⁷ The Court has long warned against the crystallization of nonobviousness into clear-cut subrules, see *McClain v Ortmyer*, 141 US 419, 427 (1891) (“[T]he word cannot be defined in such manner as to afford any substantial aid in determining whether a particular device involves an exercise of the inventive faculty.”), and it recently reiterated this warning, see *KSR International Co v Teleflex Inc*, 550 US 398, 415 (2007) (“Throughout this Court’s engagement with the question of obviousness, our cases have set forth an expansive and flexible approach.”).

¹²⁸ See MPEP § 2144.04 (cited in note 79) (listing exemplary rationales derived from legal precedents that can support or refute obviousness).

¹²⁹ The term “mandate” is deliberately provocative, given the official status of the principle as an advisory rule of thumb.

¹³⁰ See Letter from Thomas Jefferson to Isaac McPherson (Aug 13, 1813), in H.A. Washington, ed, 6 *The Writings of Thomas Jefferson* 175, 181–82 (1854) (“Jefferson Letter to McPherson”). Jefferson’s writings on the patent regime are often treated as

that “a mere change of form should give no right to a patent,” and offered “a high-quartered shoe instead of a low one; a round hat instead of a three-square; or a square bucket instead of a round one” as unpatentable examples of mere changes of form.¹³¹ “But for this rule,” Jefferson continued, “all the changes of fashion in dress would have been under the tax of patentees.”¹³² Section 2 of the Patent Act of 1793 expressly codified Jefferson’s view of novelty, prohibiting the grant of a patent for “simply changing the form or the proportions of any machine.”¹³³ Although the statute included only this prohibition without an explanation of what could be patented, the courts interpreted the statute to codify the functionality mandate, with “principle” and “effect” as stand-ins for function:

In construing this provision, the word “simply,” has, we think, great influence. It is not every change of form and proportion which is declared to be no discovery, but that which is simply a change of form or proportion, and nothing more. If, by changing the form and proportion, a new effect is produced, there is not simply a change of form and proportion, but a change of principle also. In every case, therefore, the question must be submitted to the jury, whether the change of form and proportion, has produced a different effect.¹³⁴

weighty authority. See, for example, *Bonito Boats, Inc v Thunder Craft Boats, Inc*, 489 US 141, 147–48 (1989) (relying on Jefferson’s writings to support a narrative regarding patent law’s balance of innovation and imitation); *Graham*, 383 US at 7–10 (noting that Jefferson’s writings support an incentive-based view of patent law rather than a natural-rights view).

The functionality mandate originated in the novelty requirement because the non-obviousness requirement did not exist during the early years of the US patent regime. Nonobviousness made its first appearance in judicial reasoning in *Hotchkiss v Greenwood*, 52 US 248, 257 (1850), and in statute in the Patent Act of 1953 § 103, 66 Stat 792, 798, codified at 35 USC § 103. However, the pre-nonobviousness novelty requirement was more difficult to satisfy than the contemporary novelty requirement, demanding “substantial” novelty that infused novelty with the spirit of nonobviousness. See Edmund W. Kitch, *Graham v. John Deere Co.: New Standards for Patents*, 1966 S Ct Rev 293, 298–300, 303–27.

¹³¹ Jefferson Letter to McPherson at 181–82 (cited in note 130).

¹³² *Id* at 182.

¹³³ Patent Act of 1793 § 2, 1 Stat at 321. Jefferson was an author of the Patent Act of 1793. *Graham*, 383 US at 7.

¹³⁴ *Davis v Palmer*, 7 F Cases 154, 159 (CC D Va 1827). A change in “principle” referred to something more than a mere change in form. See Willard Phillips, *The Law of Patents for Inventions* 127 (Boston 1837). For other early formulations of the functionality mandate, see *Woodcock*, 30 F Cases at 492 (requiring that a patent on a new machine

The functionality mandate was not carried into the text of the Patent Act of 1836,¹³⁵ but it persisted as a clear rule in the courts. In *Winans v Denmead*,¹³⁶ the Supreme Court could not imagine a viable patent regime without the functionality mandate: it was “a principle which necessarily makes part of every system of law granting patents for new inventions.”¹³⁷ By the late nineteenth century, Professor William C. Robinson’s *Treatise on the Law of Patents for Useful Inventions* proclaimed that “[d]iversities of shape in a machine, or in its subordinate parts, are merely formal variations” that do not create novelty, “unless they indicate a change in its principle or mode of operation; and similar alterations in a manufacture do not disturb its identity, unless its functions, or its method of performing them, are also changed.”¹³⁸ In the same passage, Robinson used the functionality mandate to distinguish the type of departure from the prior art that merits design patent protection from the type that merits utility patent protection. “In [] design [patent law,] the shape is the invention; and hence any diversity of shape which makes a different impression on the eye changes the substance of the invention, and creates a new

show some “new mode, method, or application of mechanism, to produce some new effect, or to produce an old effect in a new way”); Phillips, *The Law of Patents* at 125–35 (cited in note 134).

¹³⁵ 5 Stat 117.

¹³⁶ 56 US 330 (1853).

¹³⁷ *Id* at 341.

¹³⁸ Robinson, 1 *Law of Patents* § 238 at 321–22 (cited in note 22). See also *id* § 242 at 329 (“[W]hen . . . the function and the mode of operation are in all respects the same, the diversity [of arrangement] is only formal, and the character of the invention is not changed.”). Functional departures from the prior art come in a number of different forms. Some are self-evident. For example, Robinson highlights that functional changes exist both when the “functions . . . are . . . changed,” meaning the innovation does something different for a consumer, and when the “method of performing” an already-existing function is changed. *Id* § 238 at 322. But, for policy reasons (that is, in order to encourage the creation of functional technologies that might not get produced absent patent incentives), the aesthetic authorship screen also recognizes other ways in which claims can be functional at their points of novelty. The method of making an object may contribute to the functionality of a departure from the prior art: an object may embody functional innovation if the PHOSITA couldn’t figure out how to make it beforehand. See *Forest Laboratories, Inc v Ivax Pharmaceuticals, Inc*, 501 F3d 1263, 1269 (Fed Cir 2007) (recognizing the difficulty in isolating a chemical species as evidence of nonobviousness). A combination of old, functional features from nonanalogous arts into a single object can embody functional innovation, even if the combination of features works exactly like the PHOSITA would expect it to work (once the PHOSITA conceived of the combination, that is). See *In re Bigio*, 381 F3d 1320, 1325–26 (Fed Cir 2004) (describing the “field of endeavor” test for analogous arts).

design. But in [utility patent law,] this attribute is usually of little consequence."¹³⁹

It should be clear by now that the functionality mandate of nonobviousness can do the work of screening out aesthetic innovation in functional goods that utility cannot.¹⁴⁰ Nonobviousness pays attention to whether a claim's point of novelty is functional, so the functionality mandate can focus specifically on whether the innovative features of the claimed good are functional. A functional good that departs from the prior art only in its aesthetics, such as a hammer with a wavy handle, is not functional innovation but rather aesthetic innovation in a functional good, and it is obvious under nonobviousness's functionality mandate. In contrast, a hammer whose innovative design makes it better at pounding nails may be nonobvious.¹⁴¹

Despite its excellent pedigree, the functionality mandate exists in contemporary patent law only as an advisory rule of thumb, at best. For example, *Chisum on Patents*, a leading patent treatise, refers to it in passing as one of several "negative rules of invention" and places a prominent caveat on the continuing validity of any of the negative rules.¹⁴² The PTO's Manual of Patent and Examination Procedures (MPEP) never directly articulates the functionality mandate. It identifies a range of judicial precedents that examiners can use to support obviousness rejections, several of which illustrate the functionality mandate in action, but it does not chain them together into a larger principle.¹⁴³ Similarly, the Supreme Court's most recent

¹³⁹ Robinson, 1 *Law of Patents* § 238 at 321 (cited in note 22).

¹⁴⁰ See note 122 and accompanying text.

¹⁴¹ The "may" is important. The functionality mandate is not a bright-line rule that labels all functional departures from the prior art as nonobvious. There is sometimes functionality at the point of novelty but not enough innovation as a quantitative matter for patentability. Hammers with thicker handles and heavier heads are functionally different from hammers without them. They break less easily and allow more forceful pounding, respectively. But the PHOSITA would expect these minor changes in functionality to accompany the changes in form, so such hammers are obvious. See text accompanying notes 149–50.

¹⁴² See Donald S. Chisum, 1 *Chisum on Patents* § 5.04B[5] at 5-699 (Matthew Bender 2017). Professor Donald S. Chisum draws the list of negative rules from Albert H. Walker, *Text-Book of the Patent Laws of the United States of America* 22–37 (L.K. Stpouse & Co 2d ed 1889).

¹⁴³ MPEP § 2144.04 (cited in note 79). The precedents support obviousness rejections when the difference between the prior art and the claimed invention resides in changes in aesthetics. See, for example, *Application of Seid*, 161 F2d 229, 230–31 (CCPA 1947). Rejections also result when there are differences only in dimensional proportions. See, for example, *Gardner v TEC Systems, Inc*, 725 F2d 1338, 1346 (Fed Cir 1984).

nonobviousness opinion, *KSR International Co v Teleflex Inc*,¹⁴⁴ repeatedly makes statements that are consistent with the functionality mandate, but it never actually articulates the mandate.¹⁴⁵ *KSR* also expressly disapproves of categorical subrules of nonobviousness.¹⁴⁶

These contemporary formulations of the functionality mandate are curious in their understatement. Given that the utility requirement does not track a claim's point of novelty,¹⁴⁷ the functionality mandate is far and away the most important rule enforcing the authorship screen and preventing aesthetic innovation from infiltrating the patent regime. Yet, if it exists in contemporary black-letter patent law at all, it exists only as background cautionary advice—one possible factor to consider among many—in a nonobviousness analysis that remains a fact-intensive, case-by-case undertaking. In fact, its contemporary footprint is light enough that a skeptic might disagree as a descriptive matter that nonobviousness even has a functionality mandate. The daunting challenge facing any such skeptic, however, is to identify a different statutory home for patent law's authorship screen. Presuming that patent law has an aesthetic authorship screen and that aesthetic innovation is not flooding the patent regime, nonobviousness is the screen's only viable statutory grounding.¹⁴⁸

Differences in shape alone do not qualify for patent protection, either. See, for example, *Application of Dailey*, 357 F2d 669, 672–73 (CCPA 1966).

¹⁴⁴ 550 US 398 (2007).

¹⁴⁵ The Court repeatedly highlighted the connection between functional innovation and nonobviousness in its own precedent. A claim that “only unites old elements with no change in their respective functions” is obvious. *Id.* at 416, quoting *Great Atlantic & Pacific Tea Co v Supermarket Equipment Corp*, 340 US 147, 152–53 (1950). A claim that “‘simply arranges old elements with each performing the same function it had been known to perform’ and yields no more than one would expect from such an arrangement . . . is obvious.” *KSR*, 550 US at 417, quoting *Sakraida v Ag Pro, Inc*, 425 US 273, 282 (1976).

¹⁴⁶ *KSR*, 550 US at 415.

¹⁴⁷ See note 122 and accompanying text.

¹⁴⁸ The indefiniteness doctrine of § 112(b) screens out some aesthetic innovation, but it can only do this work if the aesthetic innovation is claimed in a particular manner. 35 USC § 112(b). Indefiniteness “require[s] that a patent's claims, viewed in light of the specification and prosecution history, inform those skilled in the art about the scope of the invention with reasonable certainty.” *Nautilus, Inc v Biosig Instruments, Inc*, 134 S Ct 2120, 2129 (2014). When claiming aesthetic innovations, indefiniteness prevents applicants from employing limitations, such as “aesthetically pleasing,” that refer to “the unrestrained, subjective opinion of a particular individual.” *Datamize, LLC v Plumtree Software, Inc*, 417 F3d 1342, 1350 (Fed Cir 2005). See also *Interval Licensing LLC v AOL, Inc*, 766 F3d 1364, 1369–78 (Fed Cir 2014) (invalidating a claim with a limitation to displaying an image “in an unobtrusive manner”). However, indefiniteness permits

One reason why the role that the functionality mandate plays in enforcing the aesthetic authorship screen has not received more attention is perhaps that the mandate deals with two types of cases and that each involves a different policy calculus. On the one hand, the functionality mandate holds that minor, expected functional departures from the prior art are “the domain of mere construction,” not invention.¹⁴⁹ Here, there is not enough functional innovation as a quantitative matter. Here, the policy behind the functionality mandate is the standard inward-looking policy of nonobviousness, and the authorship screen is irrelevant. There is no reason to suffer the costs of patents if the innovation would be produced with acceptable speed by the average workman absent patent incentives.¹⁵⁰ On the other hand, as Jefferson’s reference to fashion demonstrates,¹⁵¹ the functionality mandate also applies in situations in which the departure from the prior art is a revolutionary alteration of only formal, aesthetic features without a concomitant functional departure from the prior art. Here, there is the wrong type of innovation as a qualitative matter, and the outward-looking policy rationale behind the authorship screen emerges. It cannot be that every workman is capable of effectuating such changes or that the PHOSITA is so aesthetically gifted that all innovative, aesthetic designs lie within his imagination.¹⁵² To the contrary,

applicants to claim aesthetic innovation if they use limitations that objectively define the properties that an individual purportedly finds aesthetically pleasing. Indefiniteness thus permits a claim to aesthetically pleasing sculptures so long as the claim’s limitations refer only to the geometry of the sculpture’s angles and curves. Defining an object by its geometry need not even involve terms of approximation; it can provide far more certainty than the “reasonable certainty” demanded by indefiniteness. *Nautilus*, 134 S Ct at 2129.

¹⁴⁹ Walker, *Text-Book of the Patent Laws* at 38 (cited in note 142).

¹⁵⁰ See *Graham*, 383 US at 10–12; *United States Bung Manufacturing Co v Independent Bung & Bushing Co*, 31 F 76, 79–80 (CC SDNY 1887). See also generally Michael Abramowicz and John F. Duffy, *The Inducement Standard of Patentability*, 120 Yale L J 1590 (2011) (arguing that patent rights should not be granted when the innovation would have occurred without patent protection). In addition, allowing patents on small steps yields a dense pattern of patenting that, in turn, creates higher transaction costs for someone trying to acquire the rights needed to practice a technology. See generally Carl Shapiro, *Navigating the Patent Thicket: Cross Licenses, Patent Pools, and Standard Setting*, 1 Innovation Pol & Economy 119 (2000). This also leads to smaller slices of the patent reward for important innovators. See Merges and Duffy, *Patent Law and Policy* at 609 (cited in note 110).

¹⁵¹ See notes 131–32 and accompanying text.

¹⁵² Technically, the PHOSITA is a judicial construct, so he can have whatever talents the courts say he should have. A PHOSITA with unbounded aesthetic creativity is, however, counterintuitive.

the rationale must be that the PHOSITA simply doesn't care about mere changes in form without functional ramifications, regardless of how revolutionary and aesthetically pleasing they are. Mere changes in form are simply not variables in the calculus that the PHOSITA employs to identify nonobviousness. Satisfying consumer preferences for visual beauty does not count as doing something under the authorship screen because, if it did, patent would upset the competition-protection balance for aesthetic innovation that should be set by copyright law.¹⁵³

C. The Informative Authorship Screen

Like the aesthetic authorship screen, the informative authorship screen has two statutory components. The doctrine of patent eligibility provides the coarse screen, excluding purely informative goods from patentability, and the joint effort of novelty and nonobviousness provides the finer screen, excluding functional goods that are innovative only because of the informational content that they provide to a human reader. However, unlike in the aesthetic authorship screen, the two distinct statutory components both travel under the same name: the printed matter doctrine. The printed matter doctrine is a facet of the § 101 doctrine of patent eligibility when it enforces the coarse screen, but it is a facet of the § 102 and § 103 doctrines of novelty and nonobviousness, respectively, when it enforces the fine screen.

The doctrine of patent eligibility arises from the Patent Act's provision stating that only a "process, machine, manufacture, or composition of matter" is eligible for patent protection.¹⁵⁴ Although courts have construed these categories expansively, the printed matter doctrine holds that human-readable information, standing alone, is not a patent-eligible "manufacture," even when it is recorded on a tangible substrate.¹⁵⁵ A book may be a "manufacture" under the plain meaning of the word, but it is not the type of manufacture that Congress meant to make patentable. Much of copyrightable subject matter involves the representation of information—including books, diagrams, and

¹⁵³ And design patent law, too. See note 11.

¹⁵⁴ 35 USC § 101.

¹⁵⁵ See, for example, *In re Sterling*, 70 F2d 910, 912 (CCPA 1934); *In re Russell*, 48 F2d 668, 669 (CCPA 1931). The clarification that the printed matter doctrine applies only to human-readable information came later. See *In re Lowry*, 32 F3d 1579, 1583 (Fed Cir 1994).

photographs—and it is the printed matter doctrine, operating as part of patent eligibility, that keeps innovation in these subject matters from infiltrating the patent regime and upsetting copyright's competition–protection balance.¹⁵⁶

However, if a claim describes an informational innovation in a functional good, such as an advertising banner sporting a new slogan that can be dragged behind a plane, the printed matter doctrine shifts over to the novelty and nonobviousness doctrines. Unlike patent eligibility, these doctrines can track a claim's point of novelty and screen out aesthetic innovation in functional goods.¹⁵⁷ The printed matter doctrine's default rule becomes a prohibition on any informational content represented to a human audience being what distinguishes a patent claim from the prior art.¹⁵⁸ A kit of chemicals with new, printed instructions¹⁵⁹ or a method of treating a patient with an old drug in an old dose that is accompanied by new, verbal instructions from a doctor¹⁶⁰ are invalid claims to informative innovation in functional goods and methods under the printed matter doctrine because they are not different from the prior art in the right way.¹⁶¹

¹⁵⁶ See Collins, 85 Ind L J at 1404–05 n 148 (cited in note 104) (suggesting that the printed matter doctrine can be justified for its channeling function for different intellectual property regimes); Andrew F. Knight, *A Potentially New IP: Storyline Patents*, 86 J PTO Society 859, 860 (2004); Samuelson, 39 Emory L J at 1037 n 36 (cited in note 10).

¹⁵⁷ See, for example, *In re Ngai*, 367 F3d 1336, 1338–39 (Fed Cir 2004); *In re Gu-lack*, 703 F2d 1381, 1385 (Fed Cir 1983). The Supreme Court recently revived the “inventive application” approach to patent eligibility. See generally *Alice Corp v CLS Bank International*, 134 S Ct 2347 (2014); *Mayo Collaborative Services v Prometheus Laboratories, Inc.*, 566 US 66 (2012). This approach strongly resembles a point-of-novelty approach, so the printed matter doctrine may in the future be able to invalidate claims to informational innovation in functional goods when it is classified as part of patent eligibility. See generally Kevin Emerson Collins, *Prometheus Laboratories, Mental Steps, and Printed Matter*, 50 Houston L Rev 391 (2012) (examining the parallels between the inventive application approach in *Prometheus* and the point-of-novelty approach of the printed matter and mental steps doctrines).

¹⁵⁸ Chisum, 1 *Chisum on Patents* § 1.02[4] at 1-25 to 1-26 (cited in note 142).

¹⁵⁹ *Ngai*, 367 F3d at 1339.

¹⁶⁰ *King Pharmaceuticals*, 616 F3d at 1279–80.

¹⁶¹ Most litigated printed matter cases involve informational content that is innovative because it conveys newly discovered factual information and theories. However, informational content may also be innovative because it employs new, sometimes more efficient, ways of expressing known facts and ideas. For example, consider a claim to a kit of chemicals with textual instructions for use in which the innovation lies in the syntax of the text that more clearly communicates already-known facts and ideas to a human reader. If one adopts purely inward-looking patent policy, as I have in earlier work, the printed matter doctrine might allow patents on this later type of informative innovation. Collins, 85 Ind L J at 1423–27 (cited in note 104) (arguing that the production and reception efficiencies in informational syntax might be patentable under the printed matter

The printed matter doctrine has a long-standing cooperative-relation exception that tailors it yet more closely to the informative authorship screen.¹⁶² This exception holds that the content of printed matter can be considered when determining whether a claimed technology embodies a patent-eligible advance over the prior art if the printed matter has a cooperative relationship with the underlying substrate. Older cases focused on a "cooperative relationship between the printed indicia and the structural features" of the substrate, such as the relationship between a paper ticket that is meant to be torn and the location of the writing on the ticket.¹⁶³ The new spatial arrangements of the printed matter on these paper tickets enabled the tickets to be torn or punched in ways that were not previously possible, allowing ticket takers to divide up or obliterate the bits of printed matter on the tickets more easily than was previously possible. In more recent cases, the cooperative-relation exception has expanded to include functional relationships between the content of the printed matter and the underlying substrate. For example, a claim to a circular band with a series of printed numbers that had no beginning or end could rely on the content of the printed matter to demonstrate a distinction from the prior art because the looping nature of the substrate (the band) and the looping content of the printed matter (the numbers) had a functional relationship.¹⁶⁴ The cooperative-relationship exception demonstrates that the authorship screen does not categorically exclude goods with informational content. The patent regime embraces functional innovation, but not informational innovation, in goods that have informational content.

D. The Parallels and Divergences

The aesthetic and informative authorship screens exclude different types of innovation, but they have parallel structures. Within each screen, a coarse filter grounded in one statutory provision, namely § 101, keeps out goods that are entirely

doctrine). However, if one considers outward-looking patent policy, the printed matter doctrine should invalidate these patents because they upset copyright's competition-protection balance for informative authorial innovation.

¹⁶² *Id.* at 1392-96.

¹⁶³ *Flood v. Coe*, 31 F. Supp. 348, 349 (D.D.C. 1940).

¹⁶⁴ *Gulack*, 703 F.2d at 1386-87. See also *Application of Miller*, 418 F.2d 1392, 1393-96 (CCPA 1969) (upholding claims for measuring spoons with false textual indications of the spoons' sizes to facilitate reducing or enlarging recipes).

nonfunctional, and a finer filter grounded in a different statutory provision, namely one or both of §§ 102 and 103, takes care of the more difficult task of excluding nonfunctional innovation in functional goods.¹⁶⁵

TABLE 1. THE AUTHORSHIP SCREENS AND THEIR FILTERS

	Nonfunctional Goods	Nonfunctional Innovation in Functional Goods
Aesthetic Authorship Screen	Utility (§ 101)	Nonobviousness (§ 103: functionality mandate)
Informative Authorship Screen	Patent Eligibility (§ 101: printed matter doctrine)	Novelty and Nonobviousness (§§ 102–03: printed matter doctrine)

However, as a policy matter, the two screens differ in one important respect—both prevent the authorial innovation that is copyright's proper domain from infiltrating the patent regime, but they have different relationships to the innovation that copyright actually protects.¹⁶⁶ Under the aesthetic authorship screen, what is not protected by patent generally is protected by copyright. The nonfunctional innovation excluded by the aesthetic authorship screen is usually copyrightable expression, provided that it is original to the author. In contrast, the informative authorship screen excludes not only the informative innovation that copyright does protect but also the informative innovation that copyright deliberately places in the public domain. For example, consider the copyright in a nonfiction science textbook or research paper. Facts lack originality, so copyright

¹⁶⁵ Patent opinions, especially in the district courts, do not always follow this clean two-by-two matrix. See, for example, *Levi Strauss & Co v Golden Trade*, 1995 WL 710822, *9 (SDNY) (holding that faded jeans lack utility). When aesthetic innovation takes the form of innovative information recorded on a substrate, such as a recorded concerto on a CD, the printed matter doctrine may be called on to screen out aesthetic innovation. MPEP § 2111.05 (cited in note 79) (stating that the printed matter doctrine would prevent the patenting of tracks of recorded music on a memory stick).

¹⁶⁶ See notes 43–46 and accompanying text (defining copyright's proper domain to encompass both subject matter that copyright protects and subject matter that it elects not to protect).

does not extend to the text's representation of facts.¹⁶⁷ However, a second comer cannot copy the original expression in which the facts are couched without permission.¹⁶⁸ Under the printed matter doctrine, this distinction is moot: patents cannot protect innovation in facts or the expression in which those facts are couched. In fact, the brunt of the printed matter doctrine is targeted at preventing patents on what copyright policy places in the public domain (facts and *Nichols* ideas) rather than on what it does protect (expression).¹⁶⁹

III. CASE STUDIES: ARCHITECTURAL DISPOSITIONS OF SPACE

Architectural innovation offers an excellent vehicle for illustrating and evaluating patent law's aesthetic authorship screen in action. Architectural innovation occupies a contested zone on the copyright–patent boundary: it is widely recognized as copyrightable subject matter,¹⁷⁰ and, as the arguments below demonstrate for the first time, it is also routinely patentable.¹⁷¹ Furthermore, the same features of architectural designs embody

¹⁶⁷ *Feist*, 499 US at 344–45.

¹⁶⁸ See *Hoehling v Universal City Studios, Inc.*, 618 F2d 972, 979–80 (2d Cir 1980).

¹⁶⁹ Kevin Emerson Collins, *The Knowledge/Embodiment Dichotomy*, 47 UC Davis L Rev 1279, 1325–29 (2014) (arguing that the printed matter doctrine's principal function is to ensure that innovation in technological knowledge cannot be patented).

¹⁷⁰ 17 USC § 102(a)(8) (listing architectural works as copyrightable subject matter).

¹⁷¹ By revealing the reach of architectural patents, these case studies open up a whole new area of overlap between copyright and patent to scholarly inquiry. Intellectual property scholars have largely overlooked the patentability of architectural design. But see John F. Duffy, *Rules and Standards on the Forefront of Patentability*, 51 Wm & Mary L Rev 609, 637–38 n 121 (2009) (discussing nineteenth- and early-twentieth-century controversies over whether architecture was patent-eligible subject matter). The oversight is especially glaring in a report that the Copyright Office published before Congress expanded copyright protection for architecture in 1990. The report expressly surveyed extant, noncopyright protection for architecture, addressing design patent, trade dress, unfair competition, and conversion without ever mentioning utility patents. See US Copyright Office, *The Report of the Register of Copyrights on Works of Architecture* 13–69 (Library of Congress 1989).

The case studies draw from a unique dataset of patents that I collected through a citation-snowballing process. Google Patents tracks both backward citations (citations by a patent to the prior art) and forward citations (citations to a patent as prior art by future patents). Starting with a handful of architectural disposition-of-space patents, I examined all of the backward and forward citations to identify additional disposition-of-space patents. I then checked the forward and backward citations of those patents, continuing the snowballing process until the citations did not reveal any new disposition-of-space patents. As a robustness check, I then examined all of the patents within the most relevant technology classifications. When I discovered new disposition-of-space patents through the classification search, I launched new rounds of snowballing.

both aesthetic and functional innovation, making it impossible to tease the aesthetic and the functional apart.¹⁷²

The first Section provides an overview of architectural patents. Most importantly, it introduces a distinction between innovation in construction technologies and dispositions of space, and it identifies the diversity of ways in which the latter can do things in the core, physical sense that patent law recognizes as functional. The second Section then uses issued patents on innovative dispositions of space to illustrate and evaluate three features of the authorship screen: the authorship screen is intentionally permissive for mixed-use innovation, systematically flawed for look-like innovation, and unusually error prone for multifunctional innovation. Importantly, the case studies' import is not limited to architecture. Many of the points made generalize to other technologies in which the aesthetic and the functional merge,¹⁷³ including industrial design,¹⁷⁴ and even the arguments that demonstrate how architecture is unique teach us something about how the authorship screen works in other technologies by negative implication.¹⁷⁵

¹⁷² See Cornelis Van de Ven, *The Theory of Space in Architecture*, in Ben Farmer and Hentie Louw, eds, *Companion to Contemporary Architectural Thought* 357, 357–60 (Routledge 1993) (discussing the competing functional and aesthetic conceptions of space that arose around the turn of the twentieth century). The history of copyright protection for architecture reflects this inseparable aesthetic-and-functional mixture. Architecture's functionality severely cramped the copyright protection that was available under the useful articles doctrine for architecture's aesthetic features during most of the twentieth century. See Kevin Emerson Collins, *The Hidden Wisdom of Architectural Copyright before the AWCPA: Defeasible Intellectual Property* *10–13 (Washington University in St. Louis Legal Studies Research Paper No 15-09-01, Feb 26, 2017), archived at <http://perma.cc/4H6E-5JZA> (discussing limits on copyright protection before 1990). Copyright protection for architecture became more substantial only in 1990 when Congress created a more permissive, sui generis functionality screen for architectural works. *Copyright Amendments Act of 1990*, HR Rep No 101-735, 101st Cong, 2d Sess 21 (1990) (noting that functionality renders an architectural feature unprotectable under the Architectural Works Copyright Protection Act (AWCPA) only if the feature is “functionally required”).

¹⁷³ See notes 236–42, 255–58 and accompanying text.

¹⁷⁴ See McKenna and Strandburg, 17 Stan Tech L Rev at 46 (cited in note 1). Computer software also occupies a zone of overlap on the copyright–patent boundary, but it does not make for a good, generalizable case study of the authorship screen. This overlap follows from Congress extending copyright protection in a sui generis manner into what is clearly functional innovation, not from the outer reaches of patent law bumping up against aesthetic authorial innovation. See Pamela Samuelson, et al, *A Manifesto concerning the Legal Protection of Computer Programs*, 94 Colum L Rev 2308, 2317 (1994) (arguing that consumers do not value software for the aesthetics of its code).

¹⁷⁵ See notes 294–304 and accompanying text.

A. Dispositions of Space and What They Do

Issued architectural patents reveal that architecture does many different things in the core, physical sense of functionality in patent law. Many architecture patents are *construction technology* patents. The engineering know-how required to make a building stand up, temper the interior environment, and keep out the elements are all historically patentable mechanical arts.¹⁷⁶ Some construction-technology patents claim building materials,¹⁷⁷ while others claim ways of combining building materials into building systems. Many of the building-system technologies that sparked architectural Modernism—including cast-iron structural systems,¹⁷⁸ curtain-wall cladding systems,¹⁷⁹ and both poured-in-place¹⁸⁰ and precast concrete¹⁸¹—were patented.

While construction-technology patents are comfortably familiar, architectural patents also regularly claim *dispositions of*

¹⁷⁶ Computer-aided design and smart buildings are also giving rise to architectural software patents. See, for example, Clay G. Nesler, et al, *Smart Building Manager*, US Patent No 8,600,556 (filed June 21, 2010).

¹⁷⁷ L.A.B. Pilkington, et al, *Manufacture of Flat Glass*, US Patent No 2,911,759 (filed Dec 6, 1954).

¹⁷⁸ James Bogardus, *Construction of the Frame, Roof, and Floor of Iron Buildings*, US Patent No 7,337 (issued May 7, 1850) (claiming the “flanches” system of cast-iron construction).

¹⁷⁹ Leroy Buffington received an infamous skyscraper patent that, he argued, claimed a metal frame with metal shelves attached thereto for supporting a masonry veneer. See Leroy S. Buffington, *Iron-Building Construction*, US Patent No 383,170 (filed Nov 14, 1887). Buffington’s claims were eventually construed narrowly to encompass only a system of tapering columns and insulation for reducing expansion and contraction in a metal frame due to temperature changes. See *Buffington’s Iron Building Co v Eustis*, 65 F 804, 809 (8th Cir 1895). In addition, it has been questioned whether Buffington actually invented the veneer-supporting steel frame before its first public use by Williams LeBaron Jenney in the Home Insurance Building. See generally Dimitris Tselos, *The Enigma of Buffington’s Skyscraper*, 26 Art Bull 3 (1944) (examining the historical record to raise doubts about Buffington’s claimed date of invention); Muriel B. Christison, *How Buffington Staked His Claim: An Analysis of His Memories and Skyscraper Drawings*, 26 Art Bull 13 (1944) (arguing Buffington’s rush to patent the skyscraper was in response to another individual’s earlier application of the principle); E.M. Upjohn, *Buffington and the Skyscraper*, 17 Art Bull 48 (1935) (relating the historical record regarding the importance of Buffington to the history of the skyscraper).

¹⁸⁰ Claude A.P. Turner patented mushroom-column construction. See Claude A.P. Turner, *Steel-Skeleton Concrete Construction*, US Patent No 985,119 (filed Oct 19, 1910). Thomas Edison patented a less commercially successful method of casting entire buildings—walls, floors, roofs, and even furniture—from a continuous, slow pour of concrete. See Thomas A. Edison, *Process of Constructing Concrete Buildings*, US Patent No 1,219,272 (filed Aug 13, 1908).

¹⁸¹ Grosvenor Atterbury, *Making Constructional Sections*, US Patent No 828,833 (filed Dec 5, 1904).

space—that is, the formal arrangement of spaces that constitutes a building's layout. A floor plan is one common representational convention for illustrating a disposition of space, so disposition-of-space patents are in effect floor-plan patents.¹⁸² Disposition-of-space patents invert the limitations of construction-technology patents. Patents on construction technologies claim materials and ways of assembling materials, and they usually do not have limitations specifying the building's arrangement of interior spaces. Buildings accommodating radically different institutions with radically different dispositions of space (like theaters, libraries, and houses) can all infringe the same construction-technology patent. In contrast, disposition-of-space patents claim the building's arrangement of interior spaces, and they usually do not have limitations specifying any construction technology. Houses made of radically different construction systems (like wood framing, load-bearing brick, and glass hung on a steel frame) can all infringe a patent claiming a domestic distribution of space.¹⁸³

Construction-technology patents are not unusually controversial under the aesthetic authorship screen because they do not implicate aesthetic innovation any more than other patents in the mechanical arts do. In contrast, disposition-of-space patents lie in a zone of overlap on the copyright–patent boundary. Architectural dispositions of space as represented in floor plans are copyrightable subject matter embodying original, protectable expression.¹⁸⁴ Crafting the aesthetics of how interior spaces do and do not flow into one another is a critical component of the architect's art.¹⁸⁵ Yet, those very dispositions of space

¹⁸² Sectional drawings may represent patentable, vertically connected spaces. Patents may claim only the buildings that embody the disposition of space represented in plans and sections. The informative authorship screen prevents them from claiming the plans themselves as drawings or printouts because they are human-readable representations of information. See Part II.C.

¹⁸³ Hybrid claims arise when the use of a particular construction technology has a significant impact on the resulting disposition of space. See, for example, Walter H. Mawby and Britten L. Perkins, *Method for Constructing a Multistory Building*, US Patent No 7,581,363 (filed July 10, 2001) (claiming a building made out of a multilevel pile of parallel, adjacent, poured-in-place concrete tunnels).

¹⁸⁴ Copyright infringement allegations involving copying of stock floor plans for single-family homes are common today. See *Home Design Services, Inc v Turner Heritage Homes Inc*, 825 F3d 1314, 1320–27 (11th Cir 2016).

¹⁸⁵ See Francis K. Ching, *Architecture: Form, Space & Order* 93–182 (Wiley 3d ed 2007) (detailing aesthetic considerations in the crafting of space as opposed to form).

are also patentable innovations when they do the types of things that the authorship screen recognizes as functional.

In what ways are the dispositions of space functional in the patent sense? What do floor plans do that makes the PTO treat them as patentable innovation? Most simply, an enclosure around a disposition of space resists gravity and keeps out the elements.¹⁸⁶ This function, standing alone, satisfies the utility-doctrine component of the aesthetic authorship screen. Utility exists when there is nonfunctional innovation in a functional good, that is, even when the reason why a technology is useful is unrelated to the reason why it is a departure from the prior art.¹⁸⁷ The functionality mandate, however, is more demanding. It requires the features that embody the formal departure from the prior art to do something different.¹⁸⁸ Thus, rephrasing the important question, what can the novel aspects of a floor plan do differently to pass through the aesthetic authorship screen?

Issued disposition-of-space patents suggest that the PTO accepts a wide array of answers to this question.¹⁸⁹ There are many patents on architectural dispositions of space with moving components, but architecture need not be dynamic with moving parts to be patentable. A new arrangement of windows does something: it admits light into an interior space in a new way,¹⁹⁰ and it enables new views out.¹⁹¹ A new site plan does many things, including preserving (or blocking) lines of sight.¹⁹² A new configuration of apartment units within an apartment building

¹⁸⁶ See Paul Oliver, ed, *Shelter and Society* 7–12 (Praeger 1969). Many architectural patents claim shelters. See, for example, William C. Rowe, *Hurricane Resistant Structure*, US Patent No 6,944,996 (filed Mar 25, 2002). Most shelter patents, however, claim innovative construction technologies, not innovative dispositions of space.

¹⁸⁷ See note 122 and accompanying text.

¹⁸⁸ See notes 140–41 and accompanying text.

¹⁸⁹ The following list is exemplary, not exhaustive.

¹⁹⁰ Theodore de Lemos and August W. Cordes, *Construction of Buildings*, US Patent No 334,694 (filed June 5, 1885) (claiming a “building the court-wall of which is made with step-shaped offsets for different stories, the offsets being covered by skylights”).

¹⁹¹ David G. Lewis, *Window Construction*, US Patent No 2,571,731 (filed Oct 12, 1945) (describing the invention as windows “affording vision in two different directions looking outwardly from inside the building”).

¹⁹² Robert E. Jones, *Building Arrangement and Method for View Site*, US Patent No 4,852,313 (filed July 26, 1985) (claiming a building arrangement that maximizes outward views to an exterior landscape); Cornelis van der Lely, *Houses with Inner Courts*, US Patent No 3,254,458 (filed June 18, 1962) (claiming a building arrangement minimizing views into residential courtyards).

does something by either increasing acoustic privacy¹⁹³ or reducing the amount of communal square footage that cannot be rented.¹⁹⁴

Perhaps most importantly, the new dispositions of space represented in floor plans (and their three-dimensional equivalents) do things because they have *programmatically affordances*: they allow some human behaviors and patterns of human activity to occur more easily than others.¹⁹⁵ “Form follows function” is one of architectural Modernism’s credos, suggesting that the shape of a building should reflect the way in which the interior spaces are articulated and used.¹⁹⁶ To recognize the programmatic affordances of a disposition of space, only a weaker and less controversial iteration of this credo that has been stripped of its determinist and aesthetic connotations is needed: space facilitates behavior.¹⁹⁷ A dedicated elevator allows an apartment owner to get to a parking space quickly and privately.¹⁹⁸ A housekeeper can put away laundry more easily if closets open into a laundry facility from the back and into a bedroom from the front.¹⁹⁹ A house with a sunken lower floor and entrance midway between the lower and upper floors does something in that it economizes on the stairs that need to be climbed to get to the upper floor.²⁰⁰ A guest can perform business tasks in a hotel room more effectively if the hotel room has been designed to accommodate such tasks.²⁰¹ A live/work unit can have separate

¹⁹³ Charles H. Sacks, *Building Construction*, US Patent No 2,390,179 (filed May 17, 1944).

¹⁹⁴ Herbert W. Tullgren, *Apartment House*, US Patent No 1,896,734 (filed Feb 11, 1931).

¹⁹⁵ See Bill Hillier, *Space Is the Machine* 183–214 (Cambridge 1996) (discussing the connection between social and spatial organization). A program is the set of behaviors or activities that a building is designed to accommodate. James F. O’Gorman, *ABC of Architecture* 1–2 (Pennsylvania 1998).

¹⁹⁶ Louis Sullivan, *The Tall Office Building Artistically Considered*, in Robert Twombly, ed, *Louis Sullivan: The Public Papers* 103, 103–13 (Chicago 1988).

¹⁹⁷ Sociologists view this facilitation as the second half of a cycle: society structures space, and then space structures social beliefs and behaviors. See generally Thomas F. Gieryn, *A Space for Place in Sociology*, 26 *Ann Rev Sociology* 463 (2000).

¹⁹⁸ Jerry W. Stewart and Bryan Thruston, *Multi-story Multiple Dwelling Complex with Semi-private Garage to Apartment Entry and Exit Pathways*, US Patent No 7,497,055 (filed Mar 1, 2006).

¹⁹⁹ Bonnie C. Martin and James Martin, *Building Structure Having Improved Household Laundry Functions*, US Patent No 9,109,375 (filed Mar 23, 2007).

²⁰⁰ Harry Stanley Clark and Iva G. Clark, *Functional Type House*, US Patent No 2,625,714 (filed July 6, 1948).

²⁰¹ Andrew James McLoughlin, et al, *Business Productivity Room*, US Patent No 9,194,143 B2 (filed Aug 22, 2014).

personal and professional entrances only if a building is designed to accommodate two separate entrances to each unit.²⁰² The revolution in the grocery store business model in the early twentieth century in which customers served themselves from aisles was enabled by a new (and patented) store layout.²⁰³ In gross, because programmatic affordances do things in the patent sense, issued patents on dispositions of space claim novel layouts for airport terminals,²⁰⁴ burial crypts,²⁰⁵ schools,²⁰⁶ factories,²⁰⁷ doctors' offices,²⁰⁸ parking garages,²⁰⁹ pharmacies,²¹⁰ prisons,²¹¹ senior living facilities,²¹² shopping malls,²¹³ restaurants,²¹⁴ theaters,²¹⁵ and server farms.²¹⁶ One disposition-of-space patent from the turn of the twentieth century even claimed a novel layout for a church with a Sunday school or, dressed up in patent jargon, an "Edifice Adapted for Use for Ecclesiastical or Religious and Scholastic Purposes."²¹⁷

To repeat, dispositions of space are not purely functional. They are mixed innovation that is both aesthetic and functional at the same time. Every time an architect crafts a new

²⁰² Dominique Halbitte, *Mixed-Use Building, for Example, for Habitation and for Business Use*, US Patent No 6,155,012 (filed Mar 4, 1997).

²⁰³ Clarence Saunders, *Self-Serving Store*, US Patent No 1,242,872 (filed Oct 21, 1916). See also generally Henry Petroski, *Shopping by Design*, 93 Am Scientist 491 (2005) (discussing the patenting of the self-serving store).

²⁰⁴ Karl Lennart Billgren and Hans Hansson, *Airline Passenger Building*, US Patent No 3,842,553 (filed Mar 15, 1973).

²⁰⁵ William I. Hood, *Burial-Crypt*, US Patent No 858,070 (filed Mar 14, 1907).

²⁰⁶ Algeraus C. Watson, *School-House Construction*, US Patent No 532,253 (filed Jan 2, 1894).

²⁰⁷ Wei Chak Joseph Lam, *Layout of Production Facility*, US Patent No 7,269,925 (filed June 14, 2002).

²⁰⁸ Donald J. Greenspan, *Medical Office Facility with Two or More Examining Rooms Having a Common Equipment Core Area*, US Patent No 3,742,932 (filed July 24, 1970).

²⁰⁹ Eugene Higgins, *Garage or Storage-Building*, US Patent No 1,321,100 (filed July 1, 1918).

²¹⁰ Nimesh S. Jhaveri, et al, *Pharmacist Workstation*, US Patent No 8,776,446 (filed Nov 1, 2011).

²¹¹ George H. Maetzel, *Jail or Prison*, US Patent No 229,540 (filed Feb 27, 1880).

²¹² Dennis L. Raynor and Dennis J. Hoth, *Integrated Residential Dwelling Units*, US Patent No 5,469,673 (filed Apr 6, 1994).

²¹³ Kenneth C. Miller Jr, *Shopping Mall*, US Patent No 3,992,824 (filed Mar 22, 1973).

²¹⁴ Seymour C. Yuter, *Restaurant Dining System*, US Patent No 4,074,793 (filed July 9, 1976).

²¹⁵ Oscar Hammerstein, *Exhibition-Building*, US Patent No 469,472 (filed Apr 17, 1891).

²¹⁶ Ankit Somani and Christopher Gregory Malone, *Alternative Data Center Building Designs*, US Patent No 9,167,724 B1 (filed Jan 12, 2015).

²¹⁷ Laurence Bolton Valk, *Combination Building*, US Patent No 723,426 (filed Nov 4, 1901).

disposition of space, she has both sculpted an aesthetic experience (whether pleasurable or not) and enabled human activity to play out in a different manner (whether conveniently or not).²¹⁸ For this reason, disposition-of-space patents offer an interesting lens through which to examine and analyze patent law's aesthetic authorship screen.

B. The Authorship Screen Is . . .

Issued patents on innovative dispositions of space provide three case studies that are well positioned to illustrate and evaluate distinct features of the authorship screen. The first case study examines how the authorship screen is intentionally permissive for mixed-use innovation. The second one demonstrates that the authorship screen is systematically flawed for look-like innovation. The third one argues that the authorship screen is unusually error prone for multifunctional innovation.

1. Permissive for mixed innovation.

The authorship screen sometimes allows innovators to leverage patent rights on functional innovation into control over innovative aesthetics. Copyright's functionality screen may not be permeable to mixed innovation—that is, innovation with inseparable functionality and aesthetics—but patent's authorship screen is. In other words, whereas copyright's functionality screen is strict with respect to mixed innovation, patent's authorship screen is permissive.²¹⁹

To see this permissiveness in action, consider the disposition-of-space patent granted to developer William Zeckendorf and architect I.M. Pei for a high-rise apartment building.²²⁰ The patent claims “[a] multi-story building structure . . . [with] vertical dividing walls sectionalizing the structure, . . . the floors of one section being located substantially midway between those in

²¹⁸ See note 185.

²¹⁹ The architectural case study addresses only the aesthetic authorship screen, but the informative authorship screen is also permissive for mixed innovation. See Kevin Emerson Collins, *The Structural Implications of Inventors' Disclosure Obligations*, 69 Vand L Rev 1785, 1809–13 (2016) (discussing the patentability under the printed matter doctrine of representational texts that are also machines).

²²⁰ William Zeckendorf and Ieoh Ming Pei, *Multistory Building Structure*, US Patent No 2,698,973 (filed Dec 22, 1949).

each contiguous section [and the] dividing walls having . . . openings and stairways . . . directly connecting the floors of the contiguous sections.”²²¹ In gross, the patent claims a three-dimensional architectural layout for a multistory structure with vertical walls creating sections, floor levels in each section located halfway between the floor levels in adjacent sections, and, in some spots at least, openings in the sectional walls connecting the floors of adjacent sections with stairs.

What does this architectural design do that satisfies non-obviousness’s functionality mandate and thus the aesthetic authorship screen? The disclosure touts the functional benefit of the design’s greater flexibility in allowing owners to acquire multiple contiguous units over time and combine them into larger units.²²² The staggered levels and openings in the dividing walls give each section of floor plate four horizontal adjacencies—up-left, down-left, up-right, and down-right—not merely the left and right adjacencies of conventional buildings.

Yet, the claimed design is also an aesthetic innovation.²²³ As illustrated in the specification, the claimed design yields an aesthetically interesting spiral effect in the balconies on the building exterior:²²⁴

FIGURE 1. THE HELIX

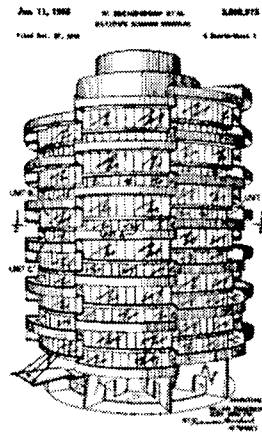

²²¹ Id at col 6, ll 78–85.

²²² Id at col 1, ll 34–62.

²²³ I.M. Pei, its principal designer, is a master of late Modernism. See generally Philip Jodidio and Janet Adams Strong, *I.M. Pei: Complete Works* (Rizzoli 2008).

²²⁴ In fact, the design’s name is simply “the Helix.” Id at 21–24.

In fact, the patented interior layout is likely the only viable way, or perhaps one of only a few ways, of creating the spiraling balconies on the outside.²²⁵ Playing off of copyright terminology, the functional interior layout and the spiraling exterior appearance have “reverse merged.” Merger in copyright’s functionality screen asks whether the expression is the only way, or one of only a few ways, of achieving a functional end.²²⁶ Reverse merger under patent’s authorship screen exists when the patented function is the only way, or one of only a few ways, of achieving an aesthetic end. The difference between copyright’s strict functionality screen and patent’s permissive authorship screen resides in the different legal implications of merger and reverse merger. Under copyright law, merger limits protection, rendering unprotectable expression that would otherwise be protected. Under patent law, reverse merger has no impact on patentability at all. Innovators who generate mixed innovation can leverage a patent into control over innovative aesthetics.

To continue the spiral theme with a more fanciful, but nonetheless still patented, example, consider a patent claiming a “tower having a spiral structure continuous from bottom to top, having its lower end supported on a suitable foundation, and being unsupported above the foundation by supplemental supports.”²²⁷ Figure 2 discloses the following embodiment:

FIGURE 2. TOWER

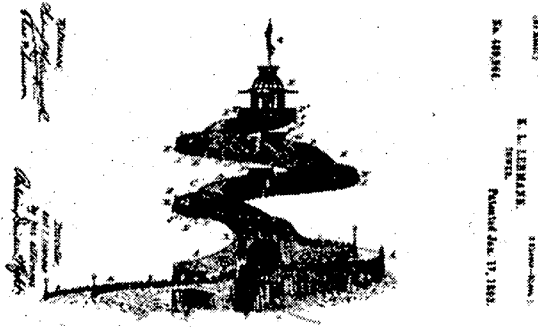

²²⁵ A noninfringing sectionalized building with staggered floor levels without any connecting stairs is not possible because of the difficulty of accessing the half levels from the elevators in the core. Spiraling brise-soleil could be attached to the exterior of a conventional building, but the half-level increments would block the views from many windows.

²²⁶ See notes 60–61 and accompanying text.

²²⁷ Karl L. Lehmann, *Tower*, US Patent No 489,964 (filed Oct 31, 1892). No claim limitations recite any of the structure needed to create the spiral ramp, aside from the generic foundation.

The disclosure highlights that the tower does something in the core, physical sense of functionality: it is “adapted to support and display ornamental terraces, flower gardens and the like in a most pleasing and artistic manner,” and it is “so constructed that foot passengers, cars, carriages or other vehicles may readily travel up and down to view the terraces and gardens and the surrounding landscapes.”²²⁸ Yet, much of the market value of the spiral tower likely lies not in its function but in its visual, aesthetic appeal as a landmark. As the disclosure notes, “[t]he tower is designed especially to ornament and embellish parks, squares or public gardens.”²²⁹ The permissive authorship screen again allows an architect who generates mixed innovation to leverage a patent into control over innovative aesthetics.

In much mixed innovation, including the spiral-tower examples above, the innovator may obtain a copyright, as well. Layering a patent on top of this copyright tilts copyright’s competition–protection balance further toward protection because it replaces thin protection for a building feature with thick protection. With a patent, the innovator need not demonstrate copying to prove infringement as he would with only a copyright.²³⁰ In addition, the patent rights are broader in scope: the claims to both spiraling towers describe their innovations at a level of generality that the *Nichols* test classifies as an unprotectable idea under copyright’s idea–expression dichotomy.²³¹ Under copyright law, the innovator could obtain protection for only the particular way in which the balconies or the car ramp create a spiraling effect. In contrast, the issued claims encompass all, or almost all, spiraling apartment balconies and car ramps.²³²

Numerous additional architectural patents illustrate the permissive nature of patent’s authorship screen and the control over aesthetic aspects of mixed innovation that a patent owner may exercise. A one-and-a-half-story house with the roof peak on a diagonal is a functional innovation because it creates more usable square footage on the second floor than does a similar house with the roof peak parallel to the sides, but it also sports

²²⁸ *Id.* at 1, ll 9–16.

²²⁹ *Id.* at 1, ll 17–19.

²³⁰ See notes 63–64 and accompanying text.

²³¹ See notes 65–69 and accompanying text.

²³² Patent also lacks a fair use defense. See notes 70–72 and accompanying text. However, fair use is not today prominent in architectural copyright infringement cases.

an aesthetically intriguing look.²³³ A habitable building in the shape of a cooling tower, that is, a concavely distorted cylinder, is a functional innovation in that it resists wind and earthquakes better than a cylindrical building, but erecting such a building is clearly an aesthetic statement.²³⁴ A building having an obtuse-angled outer circumference overcomes the problem in prior-art, rectilinear houses that “the windows and outer doors are distributed very irregularly over the various rooms,” that is, that noncorner rooms have fewer windows than corner rooms.²³⁵ Yet, polygonal houses stand out from the crowd primarily for their aesthetics. In all of these examples, patents not only encompass aesthetic innovation, but they grant thicker rights than the innovators could obtain under copyright.

Nor is the permissive nature of patent's authorship screen unique to architectural innovation. Patents can create thicker protection than copyrights do for any artistic undertaking in which a good's properties that do something in the patent sense are what make the good aesthetically appealing. For example, consider a patent on a new cut for a diamond.²³⁶ The new cut has commercial value because of how it looks to a consumer.²³⁷ If the argument were simply that the new geometric shape is more appealing to some consumers, then a patent on a diamond cut should fail the aesthetic authorship screen for the same reason that a sculpture does. However, the new cut passes the authorship screen because the cut causes a diamond to behave or perform differently in terms of how it reflects and refracts light.²³⁸ The fact that consumers value what the diamond does because of its aesthetic appeal is not relevant under patent law's authorship screen. Similarly, consider a patent on a dip tube in a

²³³ See Robert William Ferguson, *Residential Building Construction*, US Patent No 2,858,578 (filed Jan 24, 1957).

²³⁴ Floyd S. Stancliffe, *Building Structure*, US Patent No 3,468,087 (filed Sept 29, 1967).

²³⁵ Jan van Hulst, *Building Having an Obtuse-Angled Outer Circumference*, US Patent No 2,566,099, col 1, ll 18–35 (filed Dec 26, 1947).

²³⁶ Joseph Mardkha, *Mixed Cut Gemstone*, US Patent No 7,146,827 B2 (filed Sept 10, 2001). Professors McKenna and Sprigman use this patent to illustrate the incoherence of functionality as a limit on patent protection. See McKenna and Sprigman, 30 *Harv J L & Tech* at 518–19 (cited in note 1).

²³⁷ Mardkha, *Mixed Cut Gemstone* at col 2, ll 4–6 (cited in note 236) (“[A] diamond must stand out as a stylish alternative to the traditional diamond cuts in order to attract the buyer.”).

²³⁸ *Id* at col 3, ll 8–15 (discussing “the optical properties of brilliance, dispersion and scintillation”).

perfume bottle that visually disappears when immersed in the liquid of the fragrance.²³⁹ Here, the commercial value of the claimed good lies entirely in aesthetics: consumers value a minimalist appearance for a perfume bottle in which the visual distraction of the tube is minimized.²⁴⁰ Yet, the dip tube easily survives the authorship screen: it physically performs differently and produces different results in terms of how it refracts light.²⁴¹ The fact that a consumer values the innovation because of the visual appeal that the performance generates is irrelevant under the authorship screen.²⁴²

The control that a patent owner may obtain over aesthetic innovation due to the permissive nature of the authorship screen does not result from a doctrinal flaw or an error in PTO examination.²⁴³ Patents on mixed innovation are not backdoor copyrights, at least to the extent that the term implies that such patents should not exist. Rather, the permissiveness of the authorship screen reflects how patent law is supposed to work. The underlying policy presumption is simply that the benefit of providing incentives for all functional innovation is sufficiently large that it outweighs the costs of upsetting copyright's competition-protection balance for mixed innovation.²⁴⁴ Something has to give for mixed innovation, and it turns out to be copyright that defers to patent.

²³⁹ James Thompson, et al, *Fragrance Product, Dispenser, and Dispenser Assembly*, US Patent No 7,718,132 B2 (filed Oct 9, 2006). See also *MeadWestvaco Corp v Rexam Beauty and Closures, Inc*, 731 F3d 1258, 1261–63 (Fed Cir 2013). A dip tube is the tube in the fragrance container that draws liquid to the pump.

²⁴⁰ Thompson, et al, *Fragrance Product* at col 1, ll 14–18 (cited in note 239) (“[I]n modish industries, . . . the marketability of a product is determined in a large part by aesthetically pleasing product packaging and presentation.”).

²⁴¹ The claim language emphasizes this functionality. *Id* at col 7, ll 34–35, 44–45 (noting the tube's transparency of “about 80%” and its “refractive index of from about 1.36 to about 1.38”).

²⁴² Bioluminescent novelty items are patentable for a similar reason. See Bruce Bryan, *Bioluminescent Novelty Items*, US Patent No 5,876,995 (filed Nov 25, 1996).

²⁴³ The following two case studies examine these issues. See Part III.B.2 (describing the flaws in the doctrine); Part III.B.3 (discussing erroneously issued patents).

²⁴⁴ In addition, the cost of administering a strict authorship screen for mixed innovation would be significant. Examiners and judges would have to determine when mixed innovation has sufficient aesthetic value to trigger the authorship screen and whether reverse merger has occurred. The parallel administrative costs may be worth bearing in copyright's functionality screen, but they likely are not worth bearing in patent's authorship screen. See notes 82–86 and accompanying text (noting that the costs of a permissive authorship screen in patent are likely less than the costs of a permissive functionality screen in copyright).

2. Flawed for look-like innovation.

Even if mixed innovation is patentable, innovation that changes only what goods look like, without changing how they perform in a physical sense, might be expected to reside in copyright's proper domain and fail patent's aesthetic authorship screen. However, one type of innovation in visual appearance routinely passes through the authorship screen and receives patent protection: *look-like innovation*. In look-like innovation, the departure from the prior art is a set of formal changes that does nothing but make a good look like it is something other than what it is. Look-like innovation frames the issue of what types of performances should count as authorial rather than functional in the first instance.

Some architectural look-like innovation is pure entertainment and fantasy. Buildings in the shape of animals, and elephants in particular, were Victorian-era roadside novelties,²⁴⁵ and contemporary theme attractions construct fantasy worlds like an "Integrated Building Complex Consisting of Ship and Iceberg Building Structures Connected by Tunnels."²⁴⁶ Patents claiming the interior décor of theme restaurants include a "Restaurant Arrangement Including Dining Tables on Simulated Boats"²⁴⁷ and a "Simulated Time Ship Dining and Entertainment Arrangement."²⁴⁸ These claims do not claim innovative construction technologies or dispositions of space. The only purportedly functional innovation is that a building exterior or interior calls to mind something other than what it actually is for a viewer.

²⁴⁵ See James V. Lafferty, *Building*, US Patent No 268,503 (filed June 3, 1882). The patent claims "[a] building having the form of an animal, the body of which is constructed with floors divided into apartments, provided with windows and stairs, and supported on hollow legs, which afford access to the body." *Id.* at col 2, ll 86–90. The disclosure depicts a building in the shape of an elephant, and Lucy, the elephant building constructed by the inventor, still lives on today in New Jersey. See generally William McMahon, *The History of Lucy* (ComteQ 2009). For a more recent patent on an animal-shaped building, see Vagelis Mitsis, *Horse Shaped Building with Recreational Area*, US Patent No 5,564,239 (filed Feb 12, 1996).

²⁴⁶ Cyrus Milanian, *Integrated Building Complex Consisting of Ship and Iceberg Building Structures Connected by Tunnels*, US Patent No 6,073,403 (filed Nov 2, 1998); Cyrus Milanian, *Integrated Building Complex Consisting of Ship and Iceberg Building Structures Connected by Tunnels*, US Patent No 6,119,419 (filed Mar 29, 1999).

²⁴⁷ Edna G. Mozier, *Restaurant Arrangement Including Dining Tables on Simulated Boats*, US Patent No 3,701,224 (filed Feb 12, 1971).

²⁴⁸ Kent G. Anderson, *Simulated Time Ship Dining and Entertainment Arrangement*, US Patent No 6,161,341 (filed Jan 11, 1999).

Other architectural look-like innovation takes itself more seriously. The innovators seek to either deceive consumers or help consumers deceive themselves.²⁴⁹ A business owner patented a building in which two visually distinct structures, one containing a hotel and the other a restaurant, overlap on one corner.²⁵⁰

FIGURE 3. RESTAURANT AND HOTEL COMBINATION

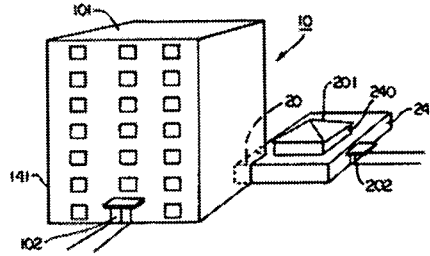

The patent disclosure touts the “functional” advantage of this allegedly novel formal massing arrangement: it “gives the impression that the hotel and restaurant are separate,” which is valuable because patrons of the restaurant who are not guests at the hotel “will tend to regard the restaurant as a stand alone establishment without the presumption that the food and service is of perceived [low] hotel restaurant quality.”²⁵¹ In gross, the innovative design plays into market preconceptions about restaurant quality, making two symbiotic programs that are jointly owned appear, incorrectly, to be under distinct management to people who are not inside the hotel.

Similarly, a housing developer claimed duplex housing units with entrances on opposite sides and, rather than a straight or right-angle common wall between them, “a common wall assembly compris[ing] a minimum of three individual wall segments all joined together to bisect the structure.”²⁵²

²⁴⁹ Innovation that deceives consumers is not problematic under the utility requirement. See note 77 (discussing utility’s moral agnosticism).

²⁵⁰ Dennis W. Quaintance, *Restaurant and Hotel Combination*, US Patent No 6,141,924 (filed July 23, 1998).

²⁵¹ *Id.* at col 1, ll 42–48.

²⁵² Jerry W. Shuster, *Bi-directional Building Arrangement*, US Patent No 5,553,429, col 7, ll 44–46 (filed Aug 10, 1994).

FIGURE 4. BI-DIRECTIONAL BUILDING ARRANGEMENT

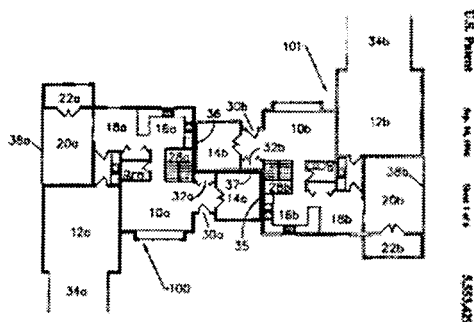

Why is using three segments, rather than one or two, in the common wall of a duplex a functional innovation under the authorship screen? There is no meaningful difference in either how the units stand up or how their interior spaces are arranged. Rather, what the extra segment in the common wall does is make two things look like one: it visually hides the duplex nature of the unit for a viewer of the duplex's exterior. The extra segments make it easier to create "a dwelling that appears to be constructed as a single family house, but which is in fact [] a carefully concealed two-family structure."²⁵³ In turn, concealing the existence of attached, duplex housing has value because it helps residents bask in the societal cache of a single-family home.²⁵⁴

Although architectural examples illustrate the category well, patents on look-like innovation extend into many other arts. On the joke side, the authorship screen routinely sanctions novelty items like a hat simulating a fried egg²⁵⁵ or a trash bag with eyes and a mouth printed thereon that, when filled, looks

²⁵³ Id at col 2, ll 15–17.

²⁵⁴ The patent disclosure emphasizes the social importance of this message:

[P]eople have worked hard to achieve a certain station in life and have certain expectations of what being successful is all about. Part of that expectation is owning a single family home . . . They view attached living, such as a townhouse or duplex, as a comedown from their life long hopes and dreams; kind of like being relegated to apartment living. What they want is a nice house that says, "Hey, I've made it."

Id at col 1, ll 33–43. The claimed innovation has additional advantages, too, insofar as deception is the goal. "Since the land that would normally be used by two single family homes is combined, the house is set further back from the street for a more 'regal' appearance." Id at col 2, ll 30–33. "Each side looks like a home which is much more expensive due to the increased width, mass, and interest of the structure." Id at col 2, ll 34–36.

²⁵⁵ Kiefer, *Hat Simulating a Fried Egg* (cited in note 81).

like a jack-o-lantern.²⁵⁶ On the deception side, the classic case-book opinion on utility in *Juicy Whip, Inc v Orange Bang, Inc*²⁵⁷ involves a look-like innovation: a beverage dispenser with a prominently placed bowl of liquid that gives the consumer the (erroneous) visual impression that she is getting a premixed drink from the bowl rather than a drink mixed from water and flavor syrups below the counter.²⁵⁸

Under conventional inward-looking patent policy that tracks only the consequences of patent protection for functional innovation, upholding the validity of patents on look-like innovation is not problematic. Look-like innovation is dismissed as having only trivial utility, and the social costs of patenting it are presumed to be de minimis.²⁵⁹ However, under the outward-looking policy that follows from framing restrictions on patentability as part of patent law's authorship screen, a new set of potential costs comes to light. Patent law upsets copyright's competition-protection balance for innovation that lies within copyright's proper domain when it deems look-like innovation to be functional in the patent sense.²⁶⁰ Layering patent protection on top of

²⁵⁶ See *In re Dembiczak*, 175 F3d 994, 996 (Fed Cir 1999). It is usually only the first innovation that makes one thing look like another that can be nonobvious under the functionality mandate. A second innovation that is also directed at making the same thing look like the same something else is likely to involve only mere changes of form because, by that point, the "function" of making the thing look like the other thing is known to the PHOSITA. See *Application of Seid*, 161 F2d 229, 230–31 (CCPA 1947).

²⁵⁷ 185 F3d 1364 (Fed Cir 1999).

²⁵⁸ *Id* at 1365–66. The Federal Circuit crisply noted that "[t]he fact that one product can be altered to make it look like another is in itself a specific benefit sufficient to satisfy the statutory requirement of utility." *Id* at 1367. Technically, the more important point is that the function of making one thing look like another is enough to satisfy the functionality mandate of nonobviousness. Drink dispensers are inherently useful, regardless of why they are innovative.

²⁵⁹ See notes 79–81 and accompanying text.

²⁶⁰ This statement assumes that making one thing look like another is authorial innovation. One way to defend this assumption looks to first principles and argues that copyright, rather than patent, provides the better framework for incenting look-like innovation. See notes 263–76 and accompanying text. Another (descriptive) way to defend this assumption is to look at what copyright actually protects today. Given the assumption that copyright and patent should not protect the same innovative features, the existence of copyright protection for look-like innovation means that patent law's authorship screen should screen out look-like innovation. In *Star Athletica, LLC v Varsity Brands, Inc*, 137 S Ct 1002 (2017), the Supreme Court implicitly held that the semiotic function of a pattern on a dress that, thanks to social conventions, many associate with cheerleaders is not the type of functionality that leads to a lack of copyright protection for the pattern. *Id* at 1012–13. In other words, an original feature of a dress that makes its wearer look like a cheerleader is copyrightable innovation. *Star Athletica* thus suggests that the semiotic "function" of making something look like something else currently

copyright protection privileges innovators, and impoverishes the public, because copyright is thin whereas patent is thick. Copyright requires a showing of copying to demonstrate infringement, and it limits authors' rights with both the idea-expression dichotomy of *Nichols* and the fair use defense; patent does not have any of these limitations.²⁶¹ The *Nichols* point in particular is worth emphasizing. An innovator who creates a building that looks like an elephant cannot use copyright to exclude copyists from making all other buildings in the shape of an elephant. Such protection would be impermissibly general; it would extend protection to ideas that are unprotectable under *Nichols*.²⁶² Under copyright, authors are limited to exclusive rights to their original expression, that is, the particular way in which their designs make a building look like an elephant. The patentability of look-like innovation means that the creators of these designs can obtain the broad protection that copyright does not allow. All buildings that look like elephants—in fact, all buildings that look like animals—are precisely what the patent in question encompasses. In sum, copyright and patent protection for the exact same look-like innovation balance competition and protection differently.

Making one thing look like another is a conceptually awkward type of functionality on which to base an innovation's admission into patent's proper domain. In smaller part, the awkwardness follows from labeling a product's visual appearance as functional. Some formulations of the aesthetic authorship screen suggest that a functional appearance is an oxymoron. They draw a categorical distinction between what a good looks like and what it does, implying that what a good looks like can never be functional.²⁶³ Similarly, Professor Robinson's articulation of the functionality mandate asserted that for some innovations, "diversity of shape which makes a different impression on the eye . . . is usually of little consequence" in utility patent law.²⁶⁴

constitutes authorial innovation, not functional innovation in the patent sense. The way in which the *Star Athletica* opinion is written leaves open the possibility that its holding is limited to two-dimensional patterns that make one thing look like another and that its holding does not reach three-dimensional configurations that make one thing look like another. However, such a line would be awkward, formalistic, and unjustifiable.

²⁶¹ See notes 63–72 and accompanying text.

²⁶² See notes 65–69 and accompanying text.

²⁶³ See note 111 and accompanying text.

²⁶⁴ Robinson, 1 *Law of Patents* at 321 (cited in note 22).

However, a *per se* rule that there is no such thing as visual functionality in patent law likely leads to an excessively narrow notion of patent's proper domain and an overly expansive notion of copyright's proper domain.²⁶⁵

In larger part, the patentability of look-like innovation under the authorship screen is conceptually problematic because its defense involves a catch-22: the argument that an innovation in making one thing look like another is something other than an aesthetic innovation necessarily frames the innovation as means of representing informational content to a human reader and thus an unpatentable informative innovation. There is no consensus in the philosophical literature about whether representational properties are in fact aesthetic properties. Some strains of aesthetic theory welcome pictorial representation into the realm of the aesthetic,²⁶⁶ while others distinguish representational properties from aesthetic properties.²⁶⁷ Yet, if making one thing look like another is not aesthetic innovation, the reason why it is not rests on the innovation representing informational content to a human perceiver. As a semiotic matter, look-like innovation is a novel sign: one thing (that does the representing) brings to mind something else (that which is represented) for the viewer.²⁶⁸ A building that is not an elephant brings to mind an elephant; a hotel-restaurant complex that is jointly owned and managed brings to mind a separately owned hotel and restaurant; a restaurant interior that does not actually have floating tables brings to mind boats on a lake. In sum, a defense

²⁶⁵ While visual performance is a peripheral, noncore type of functionality, there likely are certain types of visual performance that should be functional in the patent sense. For example, imagine an unexpected discovery that certain novel shapes for road signs make the signs more salient to drivers or that certain patterns provide excellent camouflage. Innovation with visual functionality is one example of a contestable zone on the patent-copyright boundary. See note 114 and accompanying text.

²⁶⁶ See generally, for example, E.H. Gombrich, *Art and Illusion: A Study in the Psychology of Pictorial Representation* (Pantheon 1960) (developing a theory of depiction framed within the conventions of artistic practice); Nelson Goodman, *Languages of Art: An Approach to a Theory of Symbols* (Hackett 2d ed 1976) (formulating a theory of the aesthetic that implicates symbol systems).

²⁶⁷ Zangwill, *Beauty* at 330 (cited in note 107) ("I prefer not to class representational properties themselves as *aesthetic* properties, though to some extent this is a matter of choice—a matter of what sort of work we want the category of the 'aesthetic' to do.").

²⁶⁸ See note 104 and accompanying text. More specifically, look-like innovation is an iconic sign because there is a physical resemblance between the thing that does the representing and the thing that is the content of the representation. See note 105 (distinguishing symbolic and iconic signs).

of the patentability of look-like innovation gets stuck between a rock and a hard place: if look-like innovation is not aesthetic authorial innovation, then it is informative authorial innovation.

The historically contingent, path-dependent nature of the printed matter doctrine is partly responsible for the failure of the informative authorship screen to spot look-like innovation as authorial innovation. The printed matter doctrine initially arose to deal with the most common type of informative innovation—namely, texts, diagrams, and the like that are pieces of information recorded on a substrate.²⁶⁹ It has not yet evolved to recognize other types of informative innovation when the substrate itself is a functional good shaped so that it has informational content. If an innovator were to seek a patent on a depiction of an egg on a two-dimensional surface that employs an innovative visual system for bringing an egg to mind for a viewer, it would be rejected under the authorship's coarse screen enforced by the printed matter doctrine as grounded in § 101.²⁷⁰ A new visual system for bringing an egg to mind for a viewer that modifies the shape of a hat should similarly be rejected under the authorship's finer screen enforced by the printed matter doctrine as grounded in § 103.²⁷¹ Both are simply innovations in how to bring an egg to mind to a viewer.

Even setting aside the conceptual incoherence of labeling look-like innovation as functional in the patent sense, copyright should set the competition–protection balance for look-like innovation as a policy matter. The different balances of competition and protection established by copyright and patent are not arbitrary. Each is tailored to promote innovation for a different type of subject matter. Copyright protection is more appropriate for innovation when the progress is not as cumulative and when later innovators do not always need to build on and improve earlier innovation.²⁷² Copyright is better suited to innovation in

²⁶⁹ See notes 155–56 and accompanying text.

²⁷⁰ See notes 154–56 and accompanying text.

²⁷¹ See notes 157–61 and accompanying text. One could argue that conveying information by shaping the substrate creates a functional relationship between the informational content and the substrate. See note 164 and accompanying text (discussing the functional-relation exception to the printed matter doctrine). However, this argument would lead to unacceptable distinctions. For example, a picture created by cutting out parts of a sheet of paper would pass through the authorship screen, whereas a picture created by putting pencil to paper would not.

²⁷² Karjala, 66 U Cin L Rev at 60–62 (cited in note 117). See also Julie E. Cohen and Mark A. Lemley, *Patent Scope and Innovation in the Software Industry*, 89 Cal L Rev 1,

which improvement cannot readily be measured in an objective manner,²⁷³ innovation that is easier to copy,²⁷⁴ and innovation that is less likely to be independently created by more than one party.²⁷⁵ Under any of these metrics, look-like innovation is more amenable to copyright than patent protection.²⁷⁶

3. Error prone for multifunctional innovation.

While the examination of look-like innovation in the previous Section identified a doctrinal infirmity in the authorship screen, this Section turns to the PTO's incorrect application of the authorship screen's presumptively correct doctrine. When examining patent applications claiming architectural dispositions of space, the PTO appears to issue patents that should have been rejected under the functionality mandate of nonobviousness on an unusually frequent basis.²⁷⁷ One explanation for these errors is that the resource-intensive nature of the functionality mandate overwhelms resource-constrained examiners when the number of different things that an innovation does multiplies, as it does for an innovative disposition of space.

The disclosures in a fair number of erroneously issued patents on architectural geometries suggest that, even from the

23 (2001) (noting that patent law depends on improvements from prior art more than copyright).

²⁷³ See Karjala, 35 Conn L Rev at 454–55 (cited in note 112).

²⁷⁴ See Glynn S. Lunney Jr, *Lotus v. Borland: Copyright and Computer Programs*, 70 Tulane L Rev 2397, 2427–31 (1996); David Friedman, *Standards as Intellectual Property: An Economic Approach*, 19 U Dayton L Rev 1109, 1118 (1994).

²⁷⁵ Friedman, 19 U Dayton L Rev at 1118 (cited in note 274).

²⁷⁶ The administrative and uncertainty costs of screening out look-like innovation are not daunting. The courts are understandably hesitant to enforce a heightened utility requirement that requires an assessment of what constitutes significant market or aesthetic value. See notes 80, 244. No such problematic line is needed to screen out look-like innovation. A fact finder need only refuse to recognize one discrete type of functionality—the iconic functionality of making one thing look like another—as doing something in the patent sense, much like she already refuses to accept functionality in the form of satisfying consumers' aesthetic preferences as doing something in the patent sense.

²⁷⁷ This assertion is based on my anecdotal examination of the patents in the architectural-innovation dataset. See note 171. Other commentators have noted that courts invalidate issued architectural patents during litigation at an unusually high rate, further bolstering the assertion that the PTO erroneously issues an unusually large percentage of the applications for architectural patents that it receives. See Chisum, 1 *Chisum on Patents*, § 1.02[5] at 1-46 n 180 (cited in note 142). I have not undertaken the empirical analysis needed to support this assertion. Measuring the denominator (the number of disposition-of-space patents) is feasible, but measuring the numerator (the number of erroneously issued patents) is fraught with difficulties. Furthermore, the full comparative proposition requires calculating this ratio for other technologies, as well.

applicant's point of view, the departure from the prior art at issue is a purely aesthetic departure. Consider a patent claiming a building made of "a serial array of first, second and third triangularly shaped building elements."²⁷⁸ The claims recite roughly the exterior massing arrangement exemplified in the following figure:

FIGURE 5. BUILDING WITH TRIANGULAR FACADES

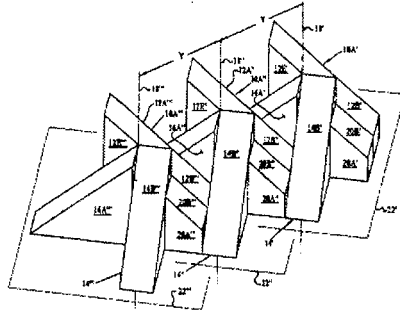

The disclosure generally states that the innovation "esthetically and functionally harmonize[s] the building structure with the topography of the land bearing the [] structure," but it never explains what functional harmonization means or gives an example thereof.²⁷⁹ Similarly, consider a patent claiming a "multi-circular module residence"²⁸⁰ like the one depicted in the following figure:

FIGURE 6. MULTI-CIRCULAR MODULAR RESIDENCE

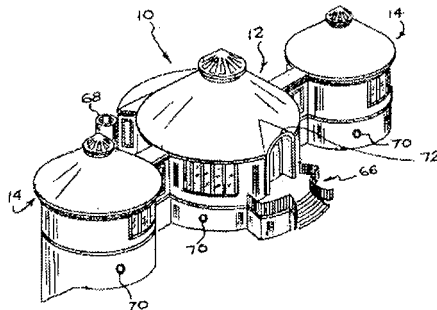

²⁷⁸ Raymond G. Hasley, *Building with Triangular Facades*, US Patent No 7,152,381 B2, col 8, ll 38–40 (filed June 7, 2005).

²⁷⁹ *Id.* at col 1, ll 13–15.

²⁸⁰ Richard Everhart, *Multi-circular Modular Residence*, US Patent No 6,484,454 B1, col 4, l 46 (filed Jan 27, 2000).

The disclosure focuses entirely on the formal, geometric properties of the design to demonstrate its distinction from the prior art, asserting that the dwelling incorporates the concept of "utilizing a consistent array of geometric designs as a theme for the residence."²⁸¹ The disclosure does not articulate any basis for finding any functional innovation that could satisfy the functionality mandate of nonobviousness. Many other patents on innovative dispositions of space follow this same template, claiming geometrically specified dispositions of space without disclosing any conceivable new function that the geometries perform (except satisfying consumers' aesthetic preferences, of course). They claim skyscrapers with terraces and overhangs "being so arranged that the composite full outline of the stories gives the optical illusion of unbalance while substantial structural balance is maintained with respect to said [] framework."²⁸² They claim arrangements of elements dimensioned on the Fibonacci series.²⁸³ They claim buildings with radial spokes and enclosed atria between the spokes.²⁸⁴ They claim U-shaped building structures on waterfront parcels of land.²⁸⁵ Houses and housing units based on hexagonal geometries are particularly well represented in this group.²⁸⁶

One hypothesis for explaining the PTO's unusually high error rate when applying the authorship screen to patents on dispositions of space focuses on examiner expertise and access to relevant prior art. Examiners usually have some expertise in the subject matter of the patents that they examine. However, architects cannot become examiners. While architectural education does include some basic engineering knowledge, architects

²⁸¹ *Id.* at col 1, ll 27-29.

²⁸² Hans Flato, *Building Design and Construction*, US Patent No 2,172,838, 2 at left col, ll 42-46 (filed July 17, 1937).

²⁸³ Michel Ernst Cohen, *Series of Elements*, US Patent No 4,078,342 (filed Jan 17, 1977).

²⁸⁴ Jean Y. de Brabant, *Atrium Building Structure*, US Patent No 4,429,501 (filed July 14, 1982).

²⁸⁵ Louis J. Jenn, *Waterfront Structure*, US Patent No 4,653,240 (filed Mar 15, 1985).

²⁸⁶ See, for example, Donald B. Tschundy and Richard D. Tschundy, *Building Construction*, US Patent No 4,480,414 (filed Sept 24, 1982) (hexagonal housing unit); Lory F. Ice, *Building Structure*, US Patent No 3,754,364 (filed Nov 4, 1971) (hexagonal house); Bruno Josef Petter, *Building with Multangular Rooms, the Ground Plan of Which Is Combined from Hexagonal Elements*, US Patent No 2,886,855 (filed Aug 30, 1954); H.M. Irwin, *Improvement in the Construction of Houses*, US Patent No 94,116 (filed Aug 24, 1869) (house in which all rooms are either hexagonal or lozenge shaped). Octagonal geometries have also been patented. See William E. Brock, *Improvement in Buildings*, US Patent No 217,984 (filed Apr 28, 1879) (octagonal rooms and apartments).

have rarely taken the scientific coursework that the PTO requires of its examiners.²⁸⁷ The lack of examiner expertise in fields like software, financial methods, and biotechnology has been identified as a reason for poor-quality patents,²⁸⁸ and the same logic may explain erroneously issued patents in architecture. Nor do the nonarchitect examiners have easy access to architectural prior art.²⁸⁹ Again, the absence of easy access to the relevant prior art has led to poor-quality patents in other fields, such as software,²⁹⁰ and a similar issue may affect architectural patents.

A different hypothesis builds on the functionality mandate's resource-intensive nature. The functionality mandate always involves fact-specific, time-consuming analyses,²⁹¹ but patents on dispositions of space demand an unusually laborious examination process because of the large number of ways in which dispositions of space are functional in the patent sense.²⁹² To mount an obviousness rejection, an examiner must prove a negative—namely, that there is no functional innovation present. As the number of ways in which a claimed innovation does things in the patent sense increases, so does the complexity of the argument needed to mount the obviousness rejection. In fact, an increase in the number of ways in which an innovation does something leads to an increase in the argument's complexity that is somewhere between geometric and exponential because combinations of different functionalities can be called on to satisfy the functionality mandate.²⁹³

²⁸⁷ Trained architects can become design patent examiners, but not utility patent examiners. See US Patent and Trademark Office, *Patent Examiner Positions*, archived at <http://perma.cc/SQC5-ULLM> (detailing the requirements for patent examiner positions).

²⁸⁸ See Adam B. Jaffe and Josh Lerner, *Innovation and Its Discontents: How Our Broken Patent System Is Endangering Innovation and Progress, and What to Do about It* 12–13 (Princeton 2004).

²⁸⁹ The list of major publishers of electronic journals available through the Scientific and Technical Information Center at the PTO does not include the prominent publishers of architectural journals. See *Electronic Nonpatent Literature Available at the USPTO* (PTO, Sept 28, 2016), archived at <http://perma.cc/3ZNS-68U9>.

²⁹⁰ Jaffe and Lerner, *Innovation and Its Discontents* at 145 (cited in note 288).

²⁹¹ See notes 127, 149–50 and accompanying text.

²⁹² See Part III.A (offering an exemplary list of the functions that a disposition of space can perform).

²⁹³ Assume a set of prior art and consider an applicant's assertion that a claimed invention is nonobvious under the functionality mandate because it performs a pair of functions. If there are only two alleged functionalities (A and B), then there is only one ground for nonobviousness that the examiner must rebut. If there are three alleged functionalities (A, B, and C), then there are three grounds for nonobviousness that the

This latter hypothesis may initially seem counterintuitive. Because dispositions of space are routinely copyrightable, one might reasonably expect that they barely do anything in a patent sense. However, this expectation does not stand up to scrutiny. Compare the application of the functionality mandate to industrial design, arguably architecture's closest analog in terms of its location on the copyright–patent boundary,²⁹⁴ with its application to dispositions of space. When one designs a teakettle, there is some consensus around a limited number of things that the teakettle does in a patent sense. To be nonobvious, the teakettle must do something innovative like boil water more quickly or with less energy input, alert its user that water is boiling more effectively, or provide a more ergonomic handle.²⁹⁵ An examiner at the PTO could likely articulate with only moderate effort the reasons why a claimed teakettle works in the exact same manner that prior-art teakettles work, and thereby show by negative implication that its distinction from prior art lies entirely in aesthetic innovation. In contrast, when an architect designs a building, there are so many different ways in which dispositions of space do things that the examiner may hesitate to mount the unusually complex argument required for the obviousness rejection.²⁹⁶

For example, consider a patent claiming a three-dimensional apartment-unit layout.²⁹⁷ The design groups units in identical pairs, with one unit in the pair rotated 180 degrees in plan from the other. As illustrated in the figures, each unit has four different levels and a connecting stair, the different

examiner must rebut. Any one of the combinations of functionalities AB, BC, and AC may prove the claim valid under the functionality mandate. If there are four alleged functionalities (A, B, C, and D), then there are six pairs of functionalities that need to be separately rebutted (AB, AC, AD, BC, BD, CD). Generally stated, the number of nonobviousness arguments based on pairs of functionalities that need to be rebutted when there are n alleged functionalities is $n!/(2(n-2)!)$. Richard A. Brualdi, *Introductory Combinatorics* 32–34 (North-Holland 1977). If obviousness arguments based on groups of functionalities larger than two are also considered, the examiner's burden increases yet more steeply with each additional alleged functionality.

²⁹⁴ See note 174.

²⁹⁵ This consensus exists for most artifacts of industrial design. See McKenna and Strandburg, 17 *Stan Tech L Rev* at 38–43 (cited in note 1) (analyzing the small number of things that several industrial designs do in a patent sense).

²⁹⁶ See Part III.A (offering an exemplary list of the functions that a disposition of space can perform).

²⁹⁷ Allan S. Miller, *Multi-level Apartment Building*, US Patent No 7,540,120 B2 (filed Sept 23, 2004).

levels house different aspects of the apartment program, and the rooms within each individual unit face outward in opposite directions.

FIGURE 7. MULTI-LEVEL APARTMENT BUILDING

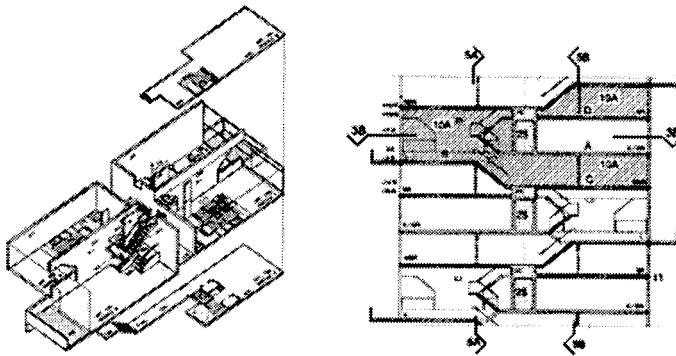

This design clearly displays architectural ingenuity and intricate spatial reasoning. But what does its formal novelty do to satisfy the functionality mandate? The disclosure identifies many problems that the design solves.²⁹⁸ The design creates an “illusion of spaciousness,”²⁹⁹ increases privacy within the unit,³⁰⁰ provides cross ventilation,³⁰¹ and separates the different programmatic activities of cooking, socializing, and eating into different zones so that each has its own spatial identity and the activities don’t interfere with each other.³⁰² The design “combine[s] the features typical of a detached house while conferring the additional advantages to land use, constructability, and sustainable development that are characteristic of high rise apartment buildings.”³⁰³ It “reduces energy consumption in relation to comparable detached residences, because the lower external surface

²⁹⁸ It also sprinkles in some noninventive features of a construction-technology patent. See *id* at col 1, ll 62–64 (discussing a “stairway system that is coupled to a vertically, rectilinearly extending structural stair support wall assembly which contains utility conduits”); *id* at col 2, ll 5–8 (“[T]he stair support assemblies of the respective vertically stacked apartments are vertically aligned to permit a continuous straight line path for vertical utility building services.”).

²⁹⁹ *Id* at col 1, ll 49–50. See also *id* at col 2, ll 16–26 (discussing different rooms with different ceiling heights).

³⁰⁰ *Id* at col 1, ll 64–col 2, ll 1.

³⁰¹ Miller, *Multi-level Apartment Building* at col 2, ll 29–37 (cited in note 297).

³⁰² *Id* at col 2, ll 1–2.

³⁰³ *Id* at col 8, ll 10–14.

to volume ratio for the apartment achieves a reduction in energy losses from exposed surfaces.”³⁰⁴ Rejections for failure to satisfy the functionality mandate require the examiner to collect the needed prior art and rebut not only these bases for nonobviousness but also all of the combinations and permutations of these bases.

Erroneously issued patents on dispositions of space matter. They cover purely aesthetic innovation, so they create backdoor copyrights that upset copyright’s competition–protection balance within its proper domain. The triangular buildings, multicircular houses, and intricate apartment layouts would receive only thin protection under copyright law. The scope of authors’ rights, but not inventors’ rights, are limited by requirements to show actual copying to prove infringement and appropriation of protected expression rather than unprotected ideas under *Nichols*, and copyright owners, but not patent owners, must rebut fair use defenses.³⁰⁵ Allowing aesthetic innovation to masquerade as patentable, functional innovation upsets these competition-enhancing safeguards in copyright law.

Assuming that the high frequency of erroneously issued patents on authorial innovation in dispositions of space should be reduced,³⁰⁶ there are several ways to work toward this goal. The simplest approach is examiner education. The PTO could develop examiner guidelines containing an advisory list of the various things that architecture does, making obviousness rejections for lack of functional innovation more formulaic.³⁰⁷ In the same vein, the status of the functionality mandate could be increased from its nearly invisible status today, buried as an advisory rule of thumb whose continued relevance is questioned,³⁰⁸ to an important and influential principle of nonobviousness. For an example of how giving the functionality mandate greater authority could lead to more rejections, consider the difference between

³⁰⁴ Id at col 8, ll 20–23. When mandated by safety codes, the design also has a “safety room” in each apartment in the case of explosive attack. Id at col 8, ll 24–27.

³⁰⁵ See notes 63–72 and accompanying text.

³⁰⁶ The ideal error cost during patent examination is not zero. Due to the high administrative costs of eliminating all errors, some erroneously issued patents exist even in an optimal patent regime. See generally Mark A. Lemley, *Rational Ignorance at the Patent Office*, 95 *Nw U L Rev* 1495 (2001).

³⁰⁷ See generally, for example, US Patent and Trademark Office, Examination Guidelines Update: Developments in the Obviousness Inquiry after *KSR v. Teleflex*, 75 *Fed Reg* 53643 (2010).

³⁰⁸ See notes 142–48 and accompanying text.

the US and Canadian patent regimes. Canadian patent law openly recognizes that a functional good must contain more than aesthetic innovation to be patentable—the functionality mandate's doctrinal equivalent—and Canada has rejected some of the very architectural patents that the United States has issued.³⁰⁹

Alternatively, more-aggressive responses could impose prophylactic exclusions that tamp down on the patentability of dispositions of space and cut the problem of applying the functionality mandate to a multifunctional technology off at the pass. Courts could thin out patent protection for architecture by reducing the number of things that dispositions of space do in the patent sense. Maybe providing greater privacy, more sight-lines, or differently oriented views should not be deemed functional, even though they involve functionality in the physical sense.³¹⁰ Or, in a yet more radical move, courts could counteract the inefficacy of the functionality mandate by treating dispositions of space as patent-ineligible subject matter.³¹¹ The Supreme Court's recent decisions on patent eligibility have suggested that “method[s] of organizing human activity” are not

³⁰⁹ For example, Canada rejected an innovator's claims seeking protection for a three-story townhouse that has a service door on the front of the bottom floor but whose front facade still has the visual appearance of a two-story townhouse. See Commissioner's Decision 605, *Townhouse Building Design*, Application No 245,995, 10 (Canadian Intellectual Property Office, July 18, 1979) (“This claim, in our view, is clearly directed to a layout, plan or design totally lacking in any mechanical or structural novelty or invention.”). The United States issued the same claims that Canada rejected. See Myron Stuart Hurwitz, *Single Family Townhouse Units*, US Patent No 4,041,661 (filed Aug 25, 1975). Canada's version of the functionality mandate is grounded in patent eligibility rather than its equivalent of nonobviousness, but the Canadian rule is substantively identical to the functionality mandate of nonobviousness in the United States.

³¹⁰ This end could be achieved in one of two ways. First, given Congress's decision to expand copyright protection for architecture to encompass functional features under the AWCPA, see note 172 and accompanying text, innovation that performs functions like providing privacy could be classified as authorial innovation. Second, innovation in how to provide these functions could be placed within patent's proper domain, but patent law could opt not to protect it. See notes 43–45.

³¹¹ Consider Kevin Emerson Collins, *Patent-Ineligibility as Counteraction*, 94 Wash U L Rev 961, 978–79 (2017) (discussing how restrictions on patent eligibility can be used to offset laxity in nonobviousness and the other patentability conditions). The dispute over the patent eligibility of architecture in the nineteenth and early twentieth centuries suggested that no architectural innovation was patentable. Duffy, 51 Wm & Mary L Rev at 637–38 n 121 (cited in note 171). The proposal here excludes only dispositions of space, leaving construction-technology patents in place.

patent eligible.³¹² Applied to architecture, this exclusion from patent eligibility would seem to suggest that the programmatic affordances of distributions of space are not the type of innovation that patent law is supposed to protect.³¹³ The wisdom of these more-aggressive approaches hinges in large part on whether patent incentives are important to ensure that there are sufficient incentives to generate innovative spatial designs at a reasonable pace, a question that reaches beyond the scope of this Article.³¹⁴

CONCLUSION

The threat of copyrights serving as backdoor patents is well known: copyrights could provide long and easily obtained protection for functional innovation that is supposed to be covered only by short and difficult-to-obtain patents. To reduce this threat, copyright uses a functionality screen to exclude functional innovation. However, the inverse problem has gone unacknowledged and unstudied. Patents can be backdoor copyrights: they can provide thick protection for authorial innovation that is supposed to be subject only to thin copyrights. To reduce this threat, patent employs what this Article has termed its authorship screen to exclude authorial innovation.

This Article has examined patent law's authorship screen in three ways, each of which makes an original contribution to the literature on intellectual property boundary screens. A

³¹² *Alice Corp v CLS Bank International*, 134 S Ct 2347, 2356 (2014), quoting *In re Bilski*, 545 F3d 943, 972 (Fed Cir 2008) (Dyk concurring) ("There is no suggestion . . . that processes for organizing human activity were or ever had been patentable.").

³¹³ It is possible, however, that the tangible and (sometimes literally) concrete nature of architecture may save patents on innovative dispositions of space from being classified as abstract ideas and deemed patent ineligible. To date, the exclusion of methods of organizing human activity has been applied only in the context of relatively intangible business methods and computer programs for performing business methods.

³¹⁴ While architects do appreciate that construction technologies can be patented, most do not realize that dispositions of space can be patented. See generally Kevin Emerson Collins, *Architectural Patents beyond Bucky Fuller's Quadrant*, in Amanda Reeser Lawrence and Ana Miljački, eds, *Terms of Appropriation: Modern Architecture and Global Exchange* (Routledge forthcoming 2017). Architects' lack of knowledge that the PTO issues patents on innovative dispositions of space suggests that the promise of such patents has not historically spurred architects to engage in more spatial innovation. However, whether patents are incenting spatial innovation by nonarchitects (many inventors who receive patents on innovative dispositions of space are not architects) and whether greater awareness of those rights by architects would spur them on to yet more spatial innovation or simply more patenting remain open questions.

normative analysis identifies the costs of allowing patents to become backdoor copyrights on aesthetic innovation. A descriptive analysis both sketches the nature of the distinction between authorial and functional innovation and locates the authorship screen in a diffuse array of distinct statutes in the Patent Act. Case studies addressing architectural innovation illustrate the authorship screen in action, arguing that the authorship screen is intentionally permissive for mixed innovation, systematically flawed for look-like innovation, and unusually error prone for multifunctional innovation.

