

Influence of Thermal Phenomena on dc Characteristics of the IGBT

Paweł Górecki and Krzysztof Górecki

Abstract—The paper concerns the study of the effect of thermal phenomena on characteristics of the IGBT. The used measurement set-ups and the results of measurements of dc characteristics of the selected transistor obtained under different cooling conditions are presented. The influence of the ambient temperature and the applied cooling system on the shape of these characteristics is discussed. In particular, attention has been paid to the untypical shape of non-isothermal characteristics of this element in the sub-threshold range.

Keywords—IGBT, thermal phenomena, measurements, dc characteristics, sub-threshold region

I. INTRODUCTION

POWER semiconductor devices are commonly used in switch-mode power supplies circuits and analogue electronic circuits operating in the continuous mode [1, 2, 3]. Within the range of high values of voltages and currents, IGBTs (Insulated Gate Bipolar Transistors) are frequently used [2, 4].

As it is well known, temperature significantly influences properties of semiconductor materials and components [5, 6, 7, 8]. In particular, an increase in the ambient temperature causes quantitative changes in the static characteristics of semiconductor devices [9, 10, 11]. However, the internal temperature of the device is crucial in describing properties of these elements, which is the sum of the ambient temperature and an increase of this temperature caused by thermal phenomena. The most important of these phenomena is self-heating. It shows itself as an increase in the interior temperature of the element due to a change of heat generated in it at not ideal dissipating of this heat into the surroundings. Self-heating can cause a significant change in the shape of characteristics of the considered elements [6, 7, 8].

The characteristics of semiconductor devices presented by manufacturers in the catalogue data are measured without thermal phenomena taken into account. These characteristics are further called isothermal characteristics. Such characteristics could be calculated using e.g. model proposed by the manufacturer [12].

Non-isothermal characteristics, which take into account the self-heating phenomenon, may significantly differ from isothermal characteristics in both quantitative and qualitative terms. For example, in non-isothermal characteristics of such semiconductor devices: as diodes, bipolar transistors and

MOSFET transistors there may occur an electrothermal breakdown point in which the sign of the dynamic output resistance of the device changes. Such characteristics are shown, among others, in the papers [6, 7, 8, 13, 14].

A change of the shape of characteristics of a semiconductor device due to the self-heating phenomena is essential, because their result, among others, in limiting the possible coordinates of the operating points of the device [15]. It is also possible to damage a semiconductor device as a result of the self-heating phenomena, despite polarising the device in the manner recommended by the manufacturer and even when selecting the operating point lying inside the SOA (Safe Operating Area). Therefore, it is important to know the course of non-isothermal characteristics of semiconductor devices, particularly IGBTs.

Over the period of the last thirty years different structures of IGBTs have been elaborated. There are: non-punch-through (NPT), punch-through (PT), field-stop (FS) [16, 17] IGBTs and new generations of this device – the third generation (IGBT3) [18, 19] and the fourth generation (IGBT4) [20].

The aim of this paper is to show the influence of the ambient temperature, self-heating phenomena and cooling conditions of the selected IGBT on its dc characteristics. The output and transfer characteristics of this transistor measured at different values of the ambient temperature for different cooling and control conditions are presented and discussed.

In Section 2 the used measurement set-ups are shown. In Section 3 the results of measurements of isothermal characteristics of the tested transistor are shown, and in Section 4 the results of measurements of non-isothermal characteristics are shown.

II. MEASUREMENT SET-UPS

To investigate the influence of thermal phenomena on dc characteristics of the IGBT transistor it was necessary to measure two types of characteristics: isothermal and non-isothermal. The IGBT manufactured by International Rectifier of the type IRG4PC40UD was selected for the investigation. This transistor belongs to fourth generation of IGBTs [20] and it is characterized by the admissible value of the reverse voltage $V_{CEmax} = 600$ V, with the admissible value of the collector current $I_{Cmax} = 20$ A and with the admissible value of the dissipated power $P_{tot} = 65$ W [20, 21].

In Fig. 1 the set-up to measure isothermal characteristics of the IGBT is shown.

Isothermal characteristics of the investigated transistor were measured using the source-meter Keithley 2612a. The considered transistor was placed in the 65 l thermal test chamber Wamed KBC-65G. The considered source-meter enables output voltages not exceeding 200 V and output currents attains up to 10 A [22]. These characteristics were measured by the pulse method at four ambient temperature values. Measurement

The scientific work financed with the Polish science budget resources in the years 2017-2021, as the investigation project within the framework of the program "Diamentowy Grant".

Paweł Górecki and Krzysztof Górecki are with Department of Marine Electronics, Gdynia Maritime University, Gdynia, Poland (e-mail: p.gorecki@we.am.gdynia.pl, k.gorecki@we.am.gdynia.pl).

pulses have a 50 ms period and the duty factor equal to 1%. Such measurement conditions provide a negligibly small difference between the internal temperature of the transistor and the ambient temperature. In order to limit the adverse effect of the power supply cables on the measurement error, a four-wire system was used to supply the output circuit of the tested transistor. The used thermal test chamber allows regulating the ambient temperature from room temperature to 250 °C with accuracy ± 1 °C.

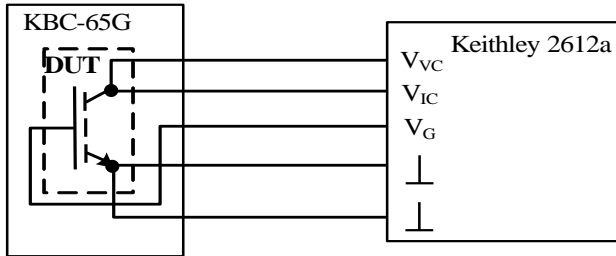

Fig. 1. Set-up for measuring isothermal characteristics of the IGBT

In Fig. 2 the set-up to measure non-isothermal characteristics of the IGBT is shown.

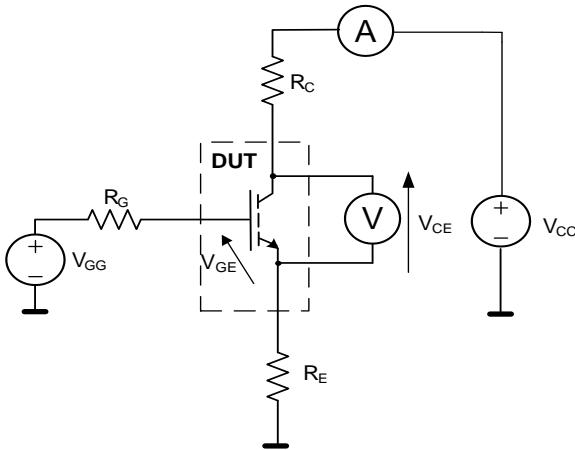

Fig. 2. Set-up to measure non-isothermal characteristics of the IGBT

In the measuring set-up the point-to-point measurement method was applied. The voltage source V_{CC} feeds the collector of the investigated transistor, and the voltage source V_{GG} feeds the gate of the transistor. The R_C resistor limits the collector current. The R_E resistor facilitates stabilization of the transistor operating point. The R_G resistor protects the gate of the transistor while switching-on the system. The UNI-T UT804 multimeters, the Array 3645A power supply with the maximum output power equal to 100 W and the NDN DF1760SL10A power supply with the maximum output power of 600 W are used in the measurement set-up.

The case temperature of the transistor is measured using the infrared pyrometer Optex PT-3S [23]. During the measurement, the indication of individual measuring instruments in the steady state was recorded. This state was found when within a minute the indication of the measuring instruments did not change more than the resolution of these instruments. In the case of a transistor operating without any heat-sink, this time was about 20 minutes, and for the transistor placed on the heat-sink - up to 45 minutes.

III. RESULTS OF ISOTHERMAL MEASUREMENTS

In order to investigate the influence of temperature on properties of the considered transistor, its isothermal dc characteristics were measured for the selected values of the ambient temperature. The selected results of these measurements are shown in Figs. 3-5. In all figures in this section, the blue colour indicates the results of measurements at the ambient temperature equal to 22°C, green - 42°C, orange - 82°C, and red - 109°C.

Fig. 3 shows isothermal transfer characteristics of the investigated transistor measured at the voltage $V_{CE} = 5$ V.

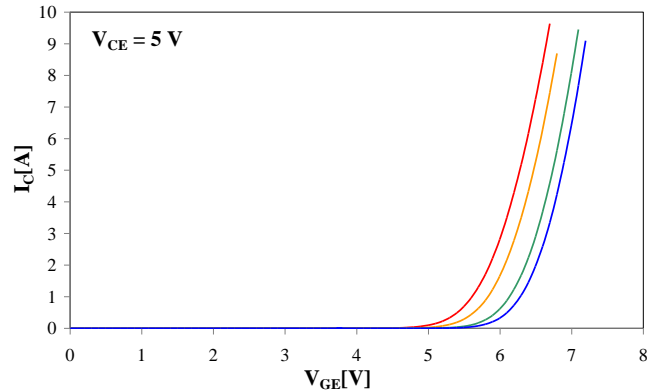

Fig. 3. Measured transfer characteristics of the investigated transistor at $V_{CE} = 5$ V

The significant influence of temperature on the course of the considered characteristics, including the threshold voltage can be observed. In the investigated range of temperature, the threshold voltage varied from 5.15 V at the highest ambient temperature to 5.88 V at room temperature. The temperature coefficient of the threshold voltage is high and it is equal to about -9 mV/K.

Fig. 4 shows the output characteristics of the investigated transistor at $V_{GE} = 5.8$ V (less than V_{th} at room temperature).

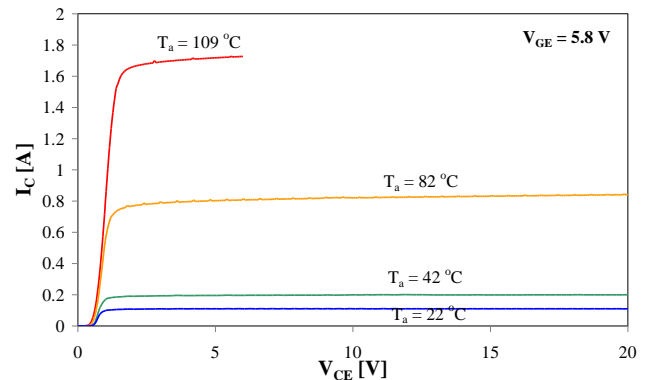

Fig. 4. Measured output characteristics of the investigated transistor at $V_{GE} = 5.8$ V

In these characteristics, the influence of the ambient temperature on the value of the collector current in the active range is particularly visible. As temperature increases, the current rises even 17 times. The nature of the $I_C(T)$ dependence in the active range is nearly exponential. The slope of the output characteristics in this range increase by nearly two orders of

magnitude with an increase in the ambient temperature from 186 μS at $T_a = 22^\circ\text{C}$ to 8.7 mS at $T_a = 109^\circ\text{C}$.

Fig. 5 shows isothermal output characteristics of the investigated transistor at the high value of the control signal - at $V_{GE} = 10\text{ V}$.

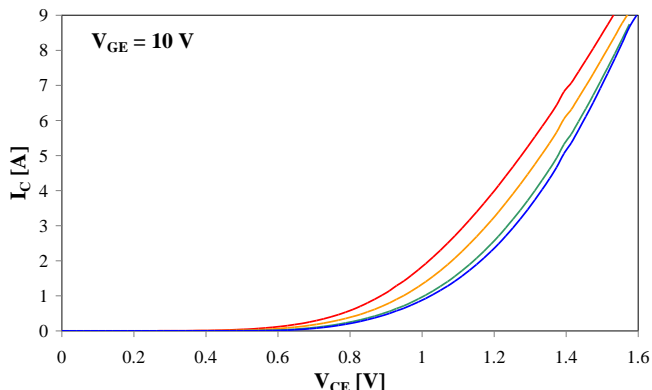

Fig. 5. Measured output characteristics of the investigated transistor under test at $V_{GE} = 10\text{ V}$

As temperature increases within the investigated range, in the linear range of the output characteristics, differential output resistance of the transistor increases by 11%. This is a result of the temperature influence on modulation of the base resistance of the bipolar transistor [24].

Due to strong nonlinearity of characteristics, especially at lower temperatures, it is impossible to calculate one value of the output resistance of the tested transistor. In the range of currents from 2.5 A to 9 A, it decreases from 489 m Ω to 177 m Ω .

The presented in Figs. 3-5 isothermal characteristics of the investigated transistor illustrate the influence of temperature and control voltage on the output and transfer characteristics. It is visible that this influence is both quantitative and qualitative - an increase in temperature at the constant voltage V_{GE} can result in up to a 17 times increase in I_C current and also a change in the slope of the output characteristics by up to two orders of magnitude.

IV. RESULTS OF NON-ISOTHERMAL MEASUREMENTS

Using the measuring system shown in Section 2, non-isothermal characteristics of the investigated transistor at room temperature were measured. In all of the figures shown in this Section the blue colour indicates characteristics of the transistor placed on the heat-sink and the red colour – characteristics of the transistor operating without any heat-sink. In addition, the black dashed line indicates the results of isothermal measurements. The measured values of thermal resistance of considered transistor situated on the heat-sink is equal to 5 K/W, whereas for the transistor operating without any heat-sink the thermal resistance is equal to 25 K/W.

Fig. 6 shows the measured transfer characteristics of the investigated transistor at the voltage $V_{CE} = 5\text{ V}$, and in Fig. 7, the dependence of T_C temperature on the V_{GE} voltage, corresponding to the characteristics presented in Fig. 6, is shown.

In the characteristics shown in Figs 6 and 7, the strong influence of self-heating on their shapes is visible. It shows an increase in the discrepancy between the course of non-isothermal and isothermal characteristics with an increase in the

output power in the device. It is significant that this discrepancy increases with an increase in thermal resistance, i.e. with deterioration of the cooling conditions of the transistor. A change in the slope of the characteristic or transconductance of the tested transistor is also visible. For example, for the collector current I_C equal approximately to 700 mA, in the isothermal characteristic transconductance is equal to 2.73 S, for the transistor operating without any heat-sink transconductance is equal to -2.5 S and 6.13 S for a transistor operating on the heat-sink. This means that the $I_C(V_{GE})$ dependence for a transistor without any heat-sink is not a function in the mathematical sense. Due to the higher value of thermal resistance of the transistor operating without any heat-sink, less power can be dissipated in this device, without exceeding the permissible internal temperature, which is equal to 140 $^\circ\text{C}$. In the case of the constant voltage V_{CE} for both the cooling conditions of the device, it results in a reduction in the maximum permissible collector current.

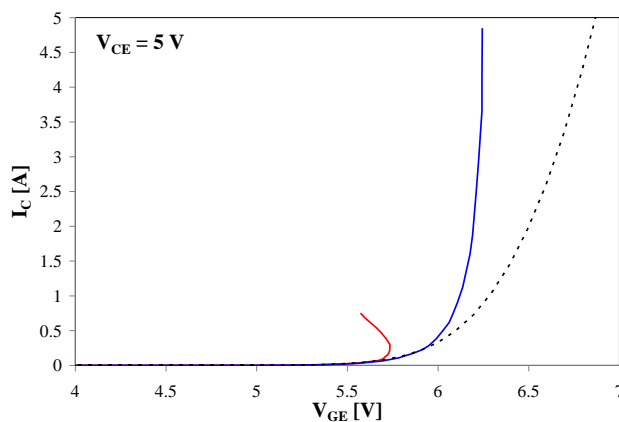

Fig. 6. Measured transfer characteristics of the investigated transistor at $V_{CE} = 5\text{ V}$

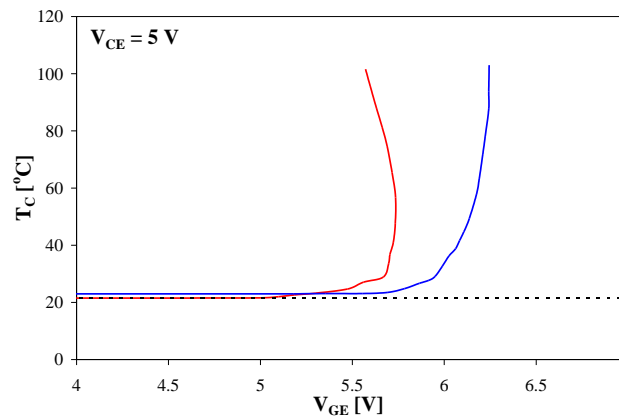

Fig. 7. Measured dependence of the transistor case temperature T_C on the V_{GE} voltage at $V_{CE} = 5\text{ V}$

Fig. 8 shows the measured output characteristics of the investigated transistor at $V_{GE} = 10\text{ V}$, and in Fig. 9, the dependence of T_C temperature on the V_{GE} voltage, corresponding to the characteristics presented in Fig. 8, is shown.

In the characteristics shown in Figs. 8 and 9 the influence of self-heating is less visible than in the case of transfer characteristics. It is worth noting that the slope of the

characteristic, corresponding to the output conductance of the transistor, decreases when the cooling conditions improve. For $I_C = 3$ A it is equal to 12.06 S under the isothermal conditions, 12.39 S for the transistor operating on the heat-sink and 13.16 S for the transistor operating without any heat-sink. In the range from 2.5 A to 9 A, conductivity of the transistor in the on-state increases with the power dissipated in the transistor from 2.07 S to 5.5 S. The obtained results are almost identical as the results obtained in the isothermal conditions. Improvement of the cooling conditions significantly affects the shape of the $T_C(V_{CE})$ characteristics - with their improvement the slope of the characteristics under consideration decreases.

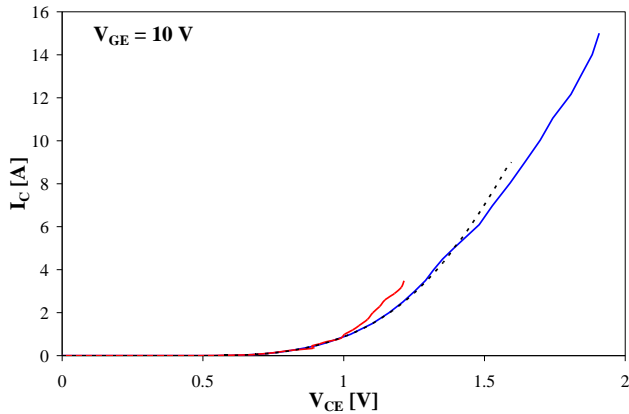

Fig. 8. Measured output characteristics of the investigated transistor at $V_{GE} = 10$ V

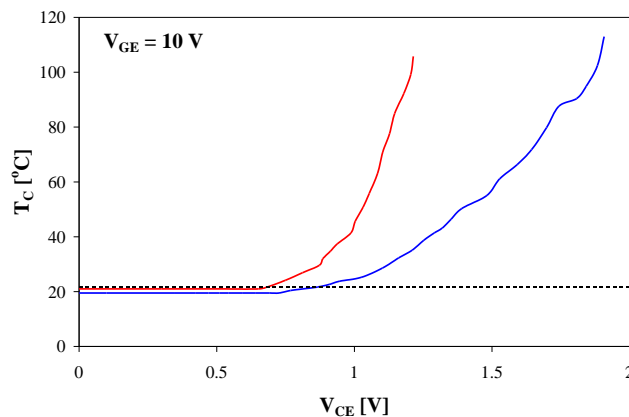

Fig. 9. Measured dependence of the transistor case temperature T_C on the V_{CE} voltage at $V_{GE} = 10$ V

Fig. 10 shows the measured output characteristics of the investigated transistor at $V_{GE} = 5.6$ V, and in Fig. 11, the dependence of T_C temperature on the V_{GE} voltage, corresponding to the characteristics presented in Fig. 10, is shown.

The shape of the output characteristics obtained under the isothermal and non-isothermal conditions differs significantly, because in the considered non-isothermal characteristics under both the considered cooling conditions, the phenomenon of electrothermal breakdown is visible. This is demonstrated by a change of the sign of the slope of the output characteristic of the transistor. The point at which this sign change occurs is called the electrothermal breakdown point [7]. The position of this point strongly depends on the cooling conditions of the

transistor. For transistors placed on the heat-sink, it occurs at $V_{CE} = 48$ V, and in the case of a transistor without any heat-sink - for $V_{CE} = 8.5$ V. The slope of the characteristics in the electrothermal breakdown region decreases when the cooling conditions worsen. It is also noticeable that the value of the current flowing through the investigated device at the constant value of V_{CE} increase when the cooling conditions worsen. In the case of isothermal measurements, the I_C current does not exceed 39 mA in the investigated range, and in non-isothermal characteristics, the I_C current of the investigated transistor exceeds even 1.6 A.

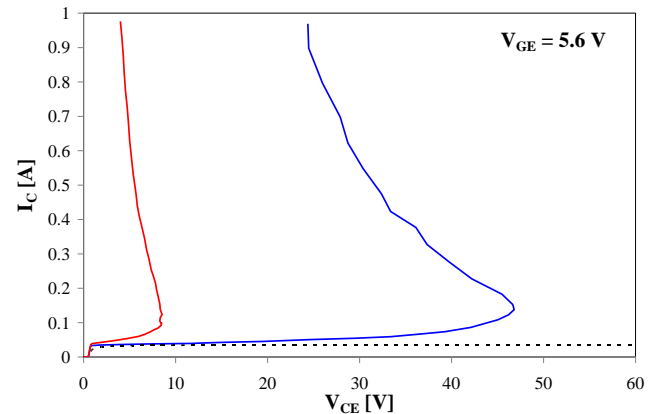

Fig. 10. Measured output characteristics of the investigated transistor at $V_{GE} = 5.6$ V

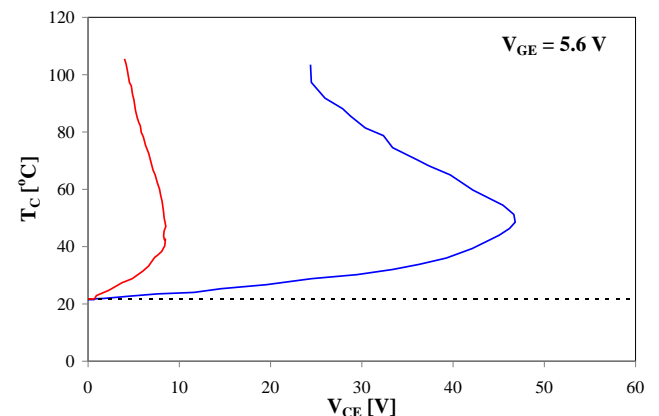

Fig. 11. Measured dependence of the transistor case temperature T_C on the V_{CE} voltage at $V_{GE} = 5.6$ V

Fig. 12 shows the influence of the control voltage on the output characteristics of the transistor placed on the heat-sink. The tests were carried out at three V_{GE} values of 5.6 V (blue colour), 5.8 V (green colour), 6 V (orange colour) and 10 V (red colour). In this figure solid lines denote non-isothermal characteristics, whereas dashed lines - isothermal characteristics.

It is visible that the electrothermal breakdown point moves to the left as the V_{GE} voltage raises. Due to the fact that the permissible power dissipated in the device is approximately constant, the I_C current at the electrothermal breakdown point increases with an increase of the V_{GE} voltage. The obtained shape of $I_C(V_{CE})$ characteristics means that at the constant V_{GE} voltage and the fixed cooling conditions, it is not possible to stabilise the V_{CE} voltage higher than the electrothermal

breakdown point. The case temperature at the electrothermal breakdown point is in the range for 48.5 °C to 65.6 °C. Of course, on the isothermal characteristics the electrothermal breakdown is not observed and in the active range the transistor output resistance of these characteristics is much higher than for non-isothermal characteristics. As a result of self-heating the collector current increases. For the fixed value of V_{CE} voltage observed differences between collector current obtained on isothermal and non-isothermal characteristics increases with an increase of V_{GE} voltage.

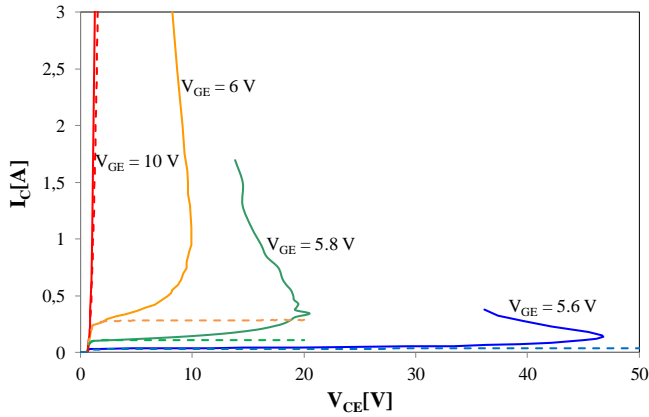

Fig. 12. Measured output characteristics of the investigated transistor placed on the heat-sink at four V_{GE} voltage values

Fig. 13 shows the results of non-isothermal measurements of the output characteristics of the investigated transistor placed on the heat-sink at four V_{GE} voltage values equal to 5.1 V (purple colour), 5.2 V (blue colour), 5.3 V (green colour) 5.4 V (red colour), respectively, on the border of the cut-off and sub-threshold ranges.

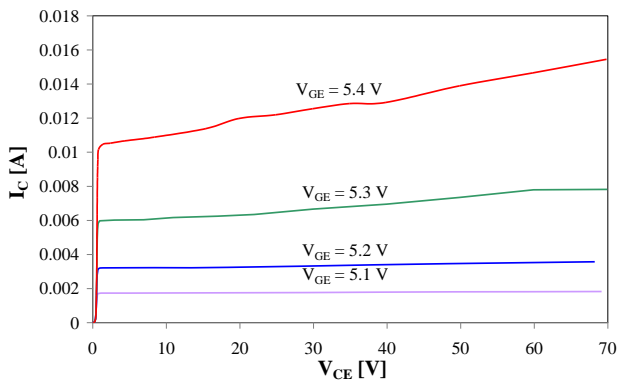

Fig. 13. Measured output characteristics of the investigated transistor placed on the heat-sink at four V_{GE} voltage values

In the investigated range of V_{CE} voltages the electrothermal breakdown was not observed, but it can be assumed that the breakdown also occurs in the case of the $V_{GE} = 5.4$ V curve outside the investigated range of the V_{CE} voltages. Also, in the case of the transistor operating under these control conditions, in the active range, the highest slope of the characteristic of more than 78 μ S occurs, which is caused by self-heating phenomena. For comparison, at $V_{GE} = 5.1$ V the characteristic has the slope of just 1.4 μ S. In the discussed characteristics, the rise of the device case temperature above the ambient temperature does not exceed 10 K.

Fig. 14 shows the results of the measured reverse output characteristics of the transistor under test at $V_{GE} = 0$ V, and in Fig. 15, the dependence of T_C temperature on the V_{GE} voltage, corresponding to the characteristics presented in Fig. 14, is shown.

In the current-voltage characteristics shown in Fig. 14 one can see very large discrepancy (up to 80%) between the voltages measured isothermally and non-isothermally on the investigated diode. Also improving the cooling conditions of the device significantly affects the course of the characteristics. With the improvement of these conditions, with the large collector current, the voltage on the forward biased diode, which is inside the structure of the transistor, increases, and the slope of the $T_C(V_{CE})$ characteristic decreases.

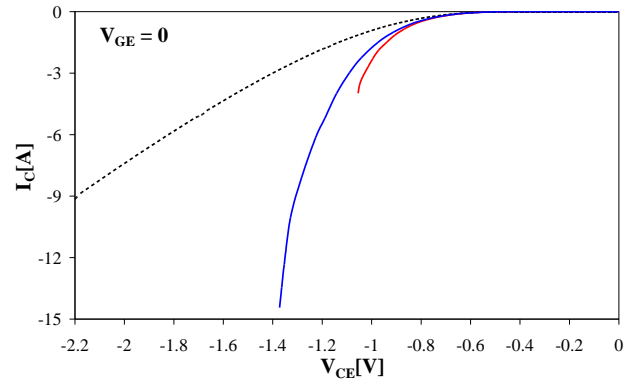

Fig. 14. Measured invert output characteristics of the investigated transistor at $V_{GE} = 0$ V

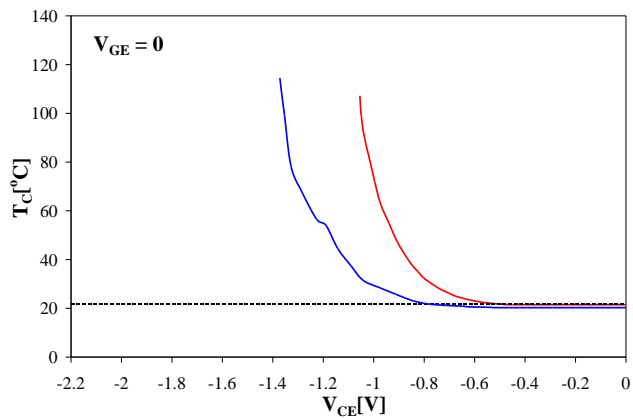

Fig. 15. Measured dependence of the transistor case temperature T_C on the V_{CE} voltage at $V_{GE} = 0$ V

V. CONCLUSIONS

In the paper, the influence of the ambient temperature, self-heating and cooling conditions on isothermal and non-isothermal characteristics of the IGBT transistor is presented. The investigations were carried out in a wide range of V_{GE} and V_{CE} voltages for the IRG4PC40UD transistor by International Rectifier with special focus on operation in the sub-threshold region. It is shown that under the isothermal conditions a change in the ambient temperature can result in a change up to several times in the collector current.

The obtained results of non-isothermal measurements are compared with the isothermal characteristics measured at room temperature. At the high values of the control voltage the

influence of thermal phenomena on characteristics of the IGBT could be omitted. In turn, results of isothermal and non-isothermal; measurements are significantly different from each other, especially in the sub-threshold region, where self-heating is very important. This results, among others, occurrence of the electrothermal breakdown point. This phenomenon causes the change of the sign of the slope of the output characteristics and they also cause a rise even up to 20 times of the collector current value in the investigated range in comparison with isothermal measurements.

The electrothermal breakdown point is significantly affected by the cooling conditions of the transistor. Improving these conditions moves the electrothermal breakdown point towards higher V_{CE} voltages. It could be important in application circuits with the IGBT and operating in a continuous mode. It is also worth to notice that the value of the IGBT internal temperature increases as a result of self-heating phenomena and this increase could in decide manner limit the SOA of this device and its lifetime [25]. Therefore, very important is proper cooling system of the IGBT, which can limit the increase of device internal temperature.

These investigation results can be useful for designers of electronic circuits with IGBTs. They indicate that for certain cooling conditions of this transistor some operating point coordinates are not possible to obtain as a result of self-heating phenomena. In order to help the designers in taking into account thermal phenomena, the electrothermal model of considered transistor should be formulated. This task will be realized shortly by the authors.

REFERENCES

- [1] R. Ericson and D. Maksimovic, *Fundamentals of Power Electronics*, Norwell, Kluwer Academic Publisher, 2001.
- [2] M.H. Rashid, *Power Electronic Handbook*, Academic Press, Elsevier, 2007.
- [3] M.K. Kazimierczuk, *Pulse-width Modulated DC-DC Power Converters*, John Wiley & Sons, Ltd, 2008
- [4] B.J. Baliga, "Analytical Modelling of IGBTs: Challenges and Solutions", *IEEE Transactions on Electron Devices*, Vol. 60, No. 2, 2013, pp. 535-543.
- [5] J. Singh: *Semiconductor Devices. Basic Principles*, John Wiley & Sons, 2001.
- [6] P.A. Mawby, P.M. Iqic and M.S. Towers, "Physically based compact device models for circuit modelling applications", *Microelectronics Journal*, Vol. 32, No. 5-6, 2001, pp. 433-447.
- [7] Ł. Starzak, M. Zubert, M. Janicki, T. Torzewicz, M. Napieralska, G. Jabłoński and A. Napieralski, "Behavioral approach to SiC MPS diode electrothermal model generation", *IEEE Transactions on Electron Devices*, Vol. 60, No. 2, 2013, pp. 630-638.
- [8] J. Zarębski and K. Górecki, "The electrothermal large-signal model of power MOS transistors for SPICE", *IEEE Transactions on Power Electronics*, Vol. 25, No. 5-6, 2010, pp. 1265 – 1274.
- [9] K. Sheng, B.W. Williams and S.J. Finney, "A review of IGBT models", *IEEE Transactions of Power Electronics*, Vol. 15, No. 6, 2000, pp. 1250-1266.
- [10] Z. Wang, W. Qiao, B. Tian and L. Qu, "An effective heat propagation path-based online adaptive thermal model for IGBT modules", *29th Annual IEEE Applied Power Electronics Conference and Exposition, APEC 2014*, Fort Worth, 2014, pp. 513-518.
- [11] K. Górecki, J. Zarębski and D. Bisewski: "An influence of the selected factors on the transient thermal impedance model of power MOSFET", *Informacije MIDEEM – Journal of Microelectronics, Electronic Components and Materials*, Vol. 45, No. 2, 2015, pp. 110-116.
- [12] Spice Models and Saber Models. Web-site of International Rectifier, <http://www.irf.com/product-info/models/saber/>
- [13] A. Poppe, "Multi-domain compact modelling of LEDs, An overview of models and experimental data", *Microelectronics Journal*, Vol. 46, No. 12, 2015, pp. 1138-1151.
- [14] K. Górecki and P. Górecki, "Modelling the influence of self-heating on characteristics of IGBTs", *Proceedings of the 21st International Conference on Mixed Design of Integrated Circuits & Systems, MIXDES 2014*, Lublin, 2014, pp. 298-302.
- [15] J. Zarębski and K. Górecki, "SPICE-aided modelling of dc characteristics of power bipolar transistors with selfheating taken in account", *International Journal of Numerical Modelling Electronic Networks, Devices and Fields*, Vol. 22, No. 6, pp. 422-433, 2009.
- [16] J. Yeon, *Introduction of New Generation Field-Stop Shorted-Anode IGBT*, Digi-Key Electronics, 2014.
- [17] A. Sattar, "Insulated Gate Bipolar Transistor (IGBT) Basics". IXYS Corporation, Application Note IXAN0063.
- [18] A.J. Forsyth, S.Y. Yang, P.A. Mawby and P. Iqic, "Measurement and modelling of power electronic devices at cryogenic temperatures", *IEE Proceedings - Circuits, Devices and Systems*, Vol. 153, No. 5, pp. 407 – 415, 2006.
- [19] G. Busatto, C. Abbate, B. Abbate and F. Iannuzzo, "IGBT modules robustness during turn-off commutation", *Microelectronics Reliability*, Vol. 48, No. 8–9, pp. 1435-1439, 2008.
- [20] IRG4PC40UD Insulated Gate Bipolar Transistor With Ultrafast Soft Recovery Diode, Data sheet, International Rectifier, 1997.
- [21] K. Górecki and P. Górecki, "The Analysis of Accuracy of Selected Methods of Measuring the Thermal Resistance of IGBTs", *Metrology and Measurement Systems*, Vol. 22, No. 3, pp. 455-464, 2015.
- [22] Series 2600 system sourcemeter User's manual, Keithley Instruments, Inc., 2006, <http://www.imperial.ac.uk/media/imperial-college/research-centres-and-groups/centre-for-bio-inspired-technology/7291001.PDF>
- [23] http://www.optex.co.jp/meas/english/potable/pt_3s/index.html
- [24] A.R. Hefner and D.M. Diebolt, "An Experimentally Verified IGBT Model Implemented in the Saber Circuit Simulator", *IEEE Transactions on Power Electronics*, Vol. 9, No. 5, pp. 532-542, 1994.
- [25] A. Castellazzi, Y.C. Gerstenmaier, R. Kraus and G.K.M. Wachutka, "Reliability analysis and modeling of power MOSFETs in the 42-V-PowerNet", *IEEE Transactions on Power Electronics*, Vol. 21, No. 3, pp. 603-612, 2006.