

Washington University in St. Louis

Washington University Open Scholarship

Mechanical Engineering and Materials Science
Independent Study

Mechanical Engineering & Materials Science

5-16-2017

Study and Design Process of Solar PV system

Jiabin Liu

Washington University in St. Louis

Harold Brandon

Washington University in St. Louis

Follow this and additional works at: <https://openscholarship.wustl.edu/mems500>

Recommended Citation

Liu, Jiabin and Brandon, Harold, "Study and Design Process of Solar PV system" (2017). *Mechanical Engineering and Materials Science Independent Study*. 47.

<https://openscholarship.wustl.edu/mems500/47>

This Final Report is brought to you for free and open access by the Mechanical Engineering & Materials Science at Washington University Open Scholarship. It has been accepted for inclusion in Mechanical Engineering and Materials Science Independent Study by an authorized administrator of Washington University Open Scholarship. For more information, please contact digital@wumail.wustl.edu.

Independent Study Report

Study and Design Processes of Solar PV Systems.

Advisor

Pro. Brandon Harold

Jiabin Liu (Bill)

5/1/2017

Department of Mechanical Engineering and Material Science

Photovoltaic (PV) is a system is a term which covers the conversion of light into electricity using semiconducting materials that exhibit the photovoltaic effect, a typical photovoltaic system employs solar panels, each panel is composed by several groups of solar cells. PV systems have greater advantage of the traditional energy sources for its low pollution and no greenhouse gas emission, however, the PV systems' power output is strongly dependent on direct sunlight, so about 10-25% is lost if a tracking system is not used, uncertain weather condition also effect the consistent power output. [1]

Photovoltaic is the third world wide green technology after hydropower and wind power, the worldwide installed PV capacity has reached 227 gigawatts, which is 2 percent of the global electricity production.[2] Since 2000, installed capacity has been an growth factor of about 57^[3], total power output has reached 200TWh of electricity.(Fig 4.1)^[4] In 2017 a study estimated that by 2030 global PV installed capacities will be between 3000 and 10000GW. China is the country with top capacity in 2015, which is 43530MW, and expect an annual increasing of 34.8%^[5]

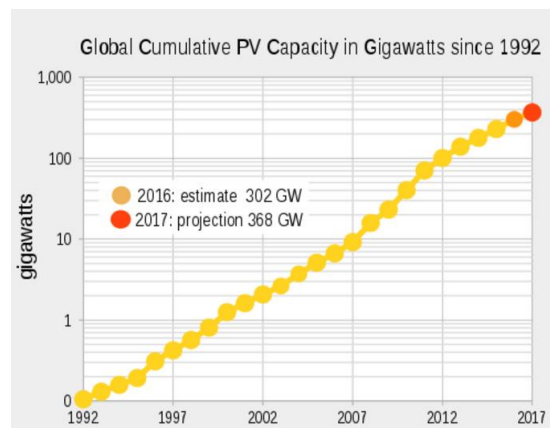

Fig 4.1 Worldwide Growth of Photovoltaics on a semi-log

Utilization of photovoltaic systems

Photovoltaic converters, which is commonly as solar cells (Fig 4.2), are semiconductor devices that convert part of the incident solar radiation energy directly into electricity energy, it is the main part of the photovoltaic system. Early hand-made cells reached efficiency of 5% with an area of 1 and 2cm², the gross output is only few milliwatts. In recent years the efficiency of solar cells have reached over 30%, solar cell modules(group of cells) are being manufactured with areas with many square meters. Solar cells are being used in a range of applications, like powering watch and calculators, street lamp (Fig 4.3) for power generation. Photovoltaic panels have been utilized as supplying power to most of the satellites in outer space for since the beginning of space programs around the world.[6]



Fig4.2 Simple Solar Cells



Fig4.2 Solar cells street lamp

Incident solar radiation can be described as discrete “energy unit” photons, which is the product of frequency and wavelength, the energy of photon is a function of the frequency of the radiation, it is the product of Planck’s constant h . the speed of light is the product of wavelength and frequency

$$C = \lambda \nu \quad 4.1$$

$$E = h\nu \quad 4.2$$

The higher the frequency, and shorter the wavelength, the more energetic the photon. Most commonly used PV cells are made of single-crystal silicon. Atom in silicon in the crystal lattice absorbs a photon from the incident solar radiation. And when the energy of the photon is high enough, electron from the outer shell of the atom is freed, which result in the formation of hole-electron pair. A hole where there is a lack of an electron and an electron out in the crystal structure. [7] These normally disappear spontaneously as electron and an electron out in crystal structure, which let the electrons recombine with holes, which leading to a mutual-effect between n-silicon and p-silicon layer, electrons will flow through the that circuit, which cause the electric energy in the circuit. The schematic section of a cell is shown in Fig 4.3^[6]

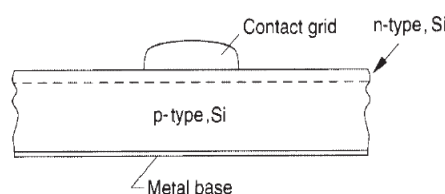

Fig 4.3 Cross Section of a silicon Solar Cell ^[16]

There are many variations on cell material, design and methods of manufacturing, Amorphous or polycrystalline silicon, cadmium sulfide, or other semiconductors are used for cells. The output of cells are limited by several factors, the minimum energy of photons that cause the hole-electron pair. Energy of photons in excess that required to create hole-electron pairs also converted to heat. Due to the limitation, the efficiency of photovoltaic silicon cells have a theoretical limit of 23%. In addition, due to the reflection loss at the cover of solar cells, the top layer should be covered by the contact grid, which also reduce the solar radiation area.

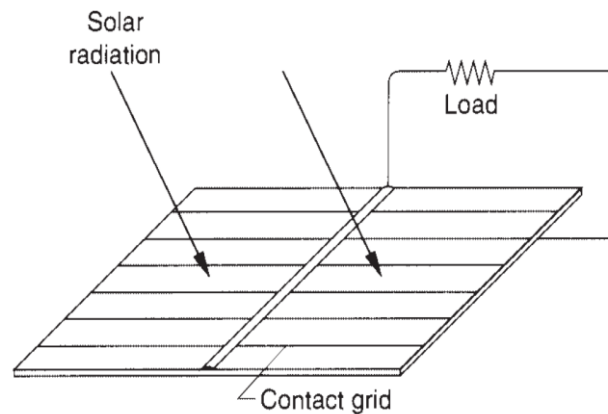

Fig 4.3 Solar Cell with contact grid on top^[16]

The evolvement of solar cell technology is rapid in developing new and more efficient cells and in reducing costs of manufacturing. Recent modules are available with many solar cells connected in series and parallel to provide constant currents and voltages. Electricity efficiency is a contributing factor in the selection of solar panels. In the market, the cell have normal efficiency with around 15% and design lifetime of 10-15 years. In laboratories, silicon crystalline solar cells have reached 25%. Cells with multiple junctions have been constructed that have efficiency more than 30%, the most efficient type of solar cell is the multi junction concentrator with an efficiency of 46.0%^[8], however, these most efficient one have the least economic advantages, therefore, selection is driven by cost efficiency and other factors.

While solar photovoltaic cells are promising for clean energy production, its popularization is hindered by several aspects like production costs, material availability, and toxicity. Crystalline modules, the first generation PV techniques are most extensively studied PV type with average efficiency of 14.0% and energy pay back time 1.5-3years. While in second generation, Cadmium Telluride could reduce more CO₂ in life-cycle analysis and have shorter pay back period 0.3-1.2 years^[9]. The third generation photovoltaic combines first and second generation advantages, techniques like Organic and Polymer Photovoltaic have higher theoretical efficiency and less of 1 year of paying back time.^[10]

4.2 Experimental Study of Photovoltaic panel.

The energy gathering of solar panels is affected by many factors like the wavelength of light, the angle of the panel facing the sun, the material of the panel, etc. In order to determine the effect mechanism between these relations, I have conducted an experiment in the laboratory in the EECE Department. I selected a high pressure sodium lamp (1KW) as a simulation of solar light. By measuring the open circuit voltage (V_{oc}), short current (J_{sc}) fill factor, then calculate the max power output of the panel at different angles to analysis the power and efficiency at different incident angles. (Fig 4.4)^[11] The sodium lamp is shown in Fig 4.5, the panels serve as an simplified equivalent circuit source, the current and voltage drop through a resistance is measured (Fig 4.6) The resistance is adjusted by switching the knob.(Fig 4.7)

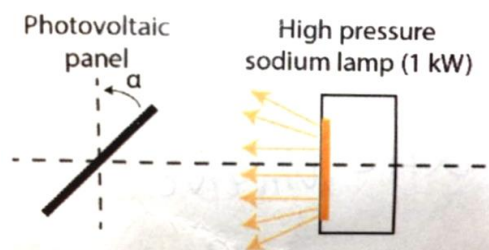

Fig 4.4 Experiment schematic ^[31]

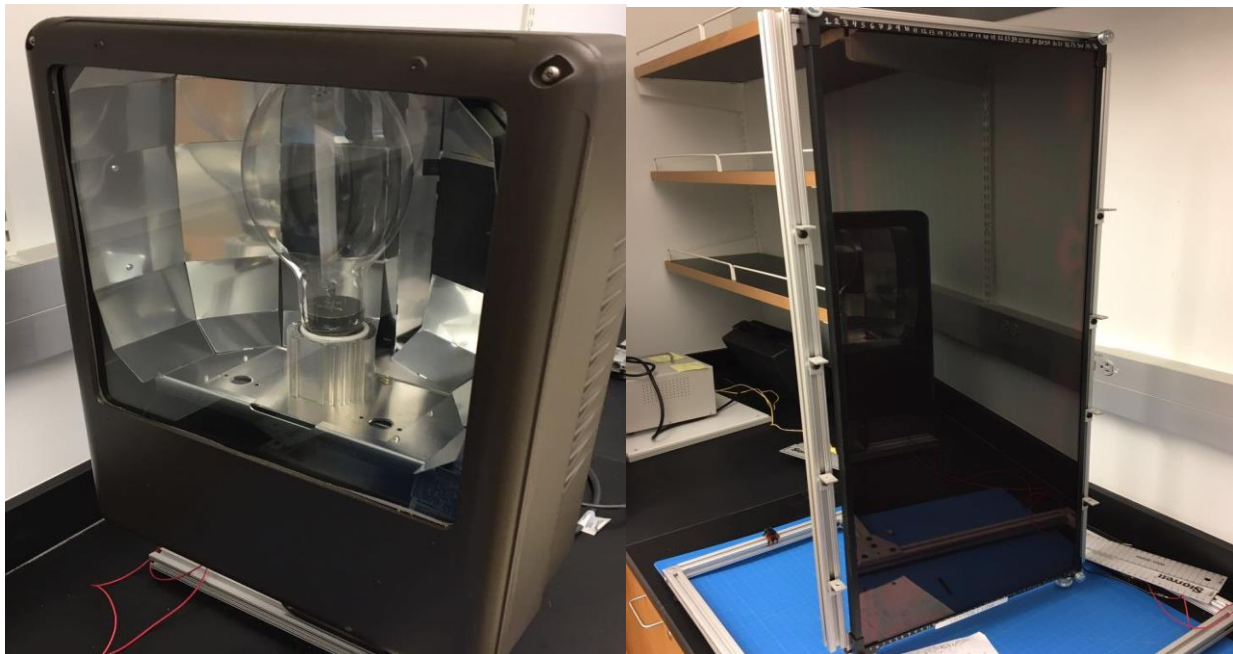

Fig 4.5 Sodium lamp and photovoltaic experimental panel.^[31]

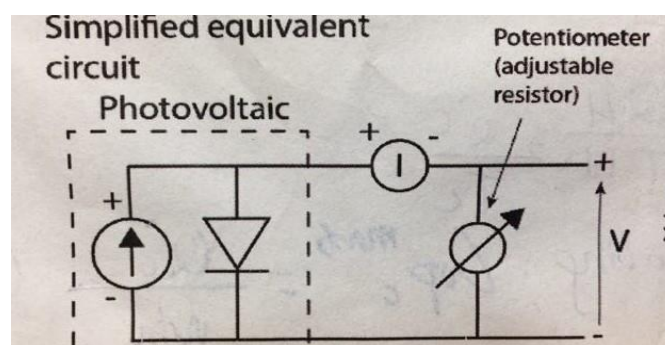

Fig 4.6 circuit schematic of the experiment.^[31]

The photovoltaic panel is 36 series solar cells compacted, the light density in photocurrent density form 42 specific locations at normal incidence is measured, which shows in Fig 4.8, The center of the panel have higher density of photocurrent, which is because the uneven lamp light throw. Then I switched the incident angle of panel from 0, 30,45,60,90 degrees. The I-V curve and P-V curve is plot in Fig 4.9, Fig 4.10.

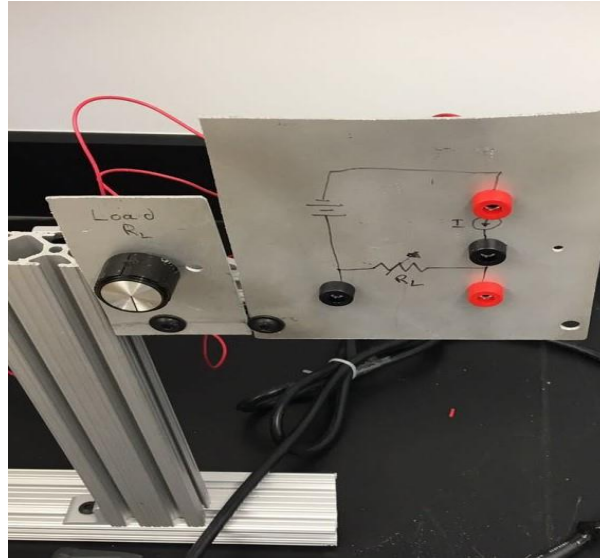

Fig 4.7 Load resistance adjuster

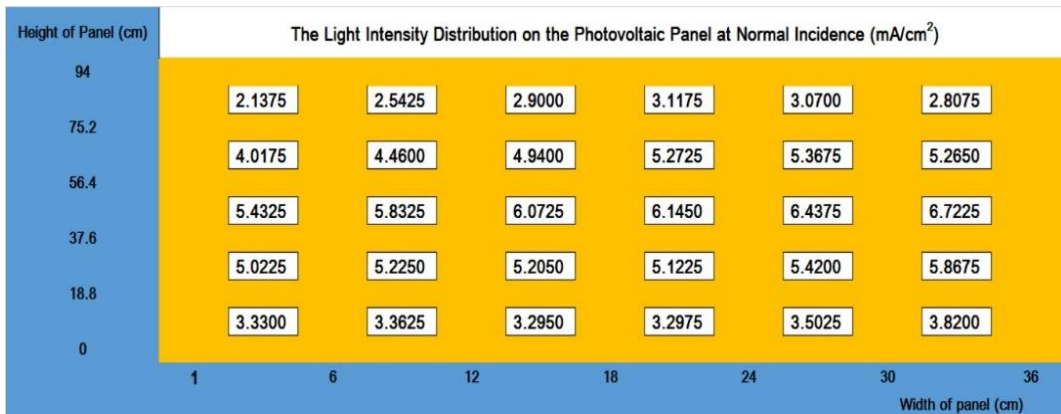

Fig4.8 Light Current of on Photovoltaic Panel

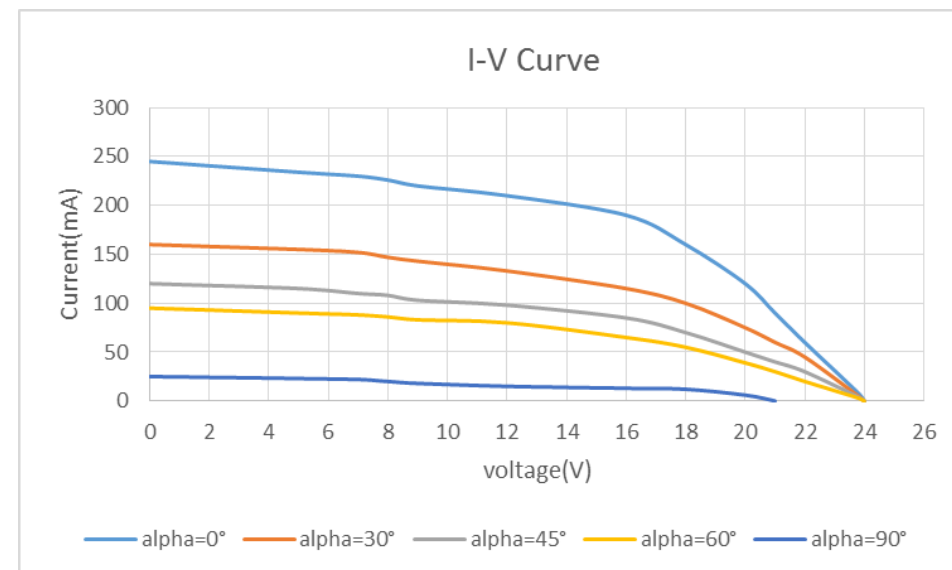

Fig 4.9 I-V Correlations in the circle

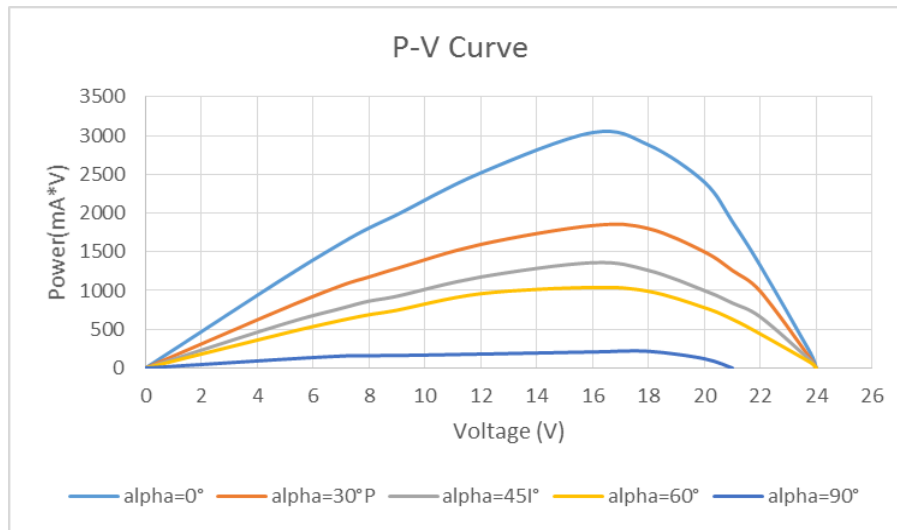

Fig 4.10 P-V Correlations in the circle

The current drops as the increase of voltage, as the increase of incidence angle, the current and the short-circuit current increase, however, the maximum voltage doesn't change with the incident angle. The power in the resistance is the product of current and voltage. Power of voltage is the product of current and voltage. The maximum power happened at the medium voltage, which is around 15V. The power also reached a maximum when the incident angle is 0 degree. This is because the panel get the most portion of energy when it is vertical to the inlet array. When resistance increase. The power first increase then drops. (Fig 4.12) At low resistance value, the increasing voltage increase the power rapidly, but as the voltage decrease, the power then drops. The maximum power point all happened at around 200Ω , which is the critical point of the curve. when the incident angle is 90° , the panel is almost close to the incoming array and obtain little energy.

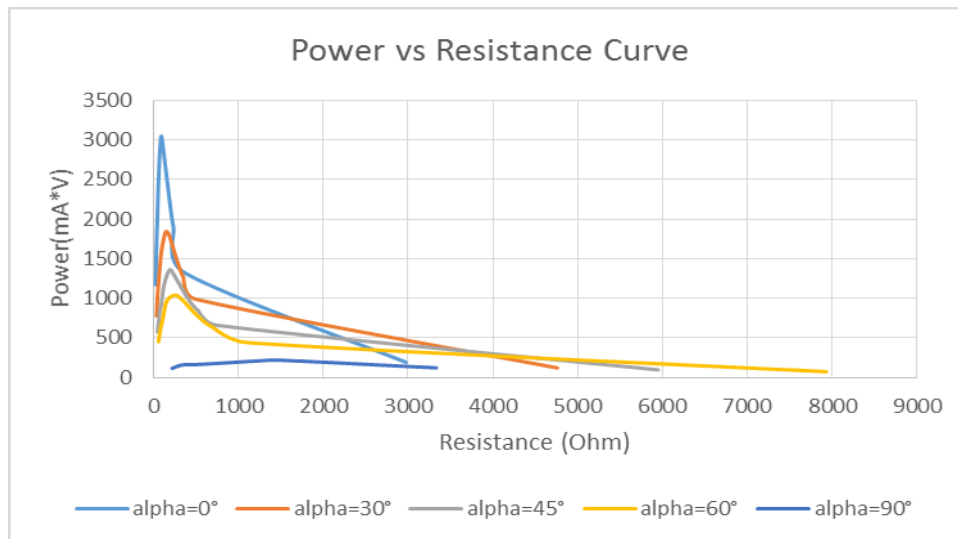

Fig 4.11 Power & Resistance Correlations

In the power analysis, fill factor means the ratio of maximum power and product of short current and open circuit voltage.

$$FF = P_{max} / (I_{sc} * V_{oc}); \quad 4.3$$

Theoretically, the maximum power output is.

$$P_{max,theoretical,alpha} = P_{max,alpha=0} * \cos(\alpha) \quad 4.4$$

The the experimental data become (Fig 4.12) real-time power is plotted in (Fig 4.10), (Fig4.11), a comparison then became (Fig 4.13). when there is a tilt angle, the actual power output is slightly lower than the theoretical.

Alpha°	Voc V	Jsc Ma	Pmax actual Ma*V	FF	Pmax,theoretical MmA*V
0	24.24	237.7	3040	0.52761	3040
30	24.19	160.5	1840	0.47392	2632.717241
45	23.96	120.4	1360	0.47144	2149.604644
60	23.7	95.6	1040	0.45902	1520.000047
90	22.24	18.44	208	0.50719	8.14565E-05

Fig 4.12 Values for some parameters at 5 various tilt angle.

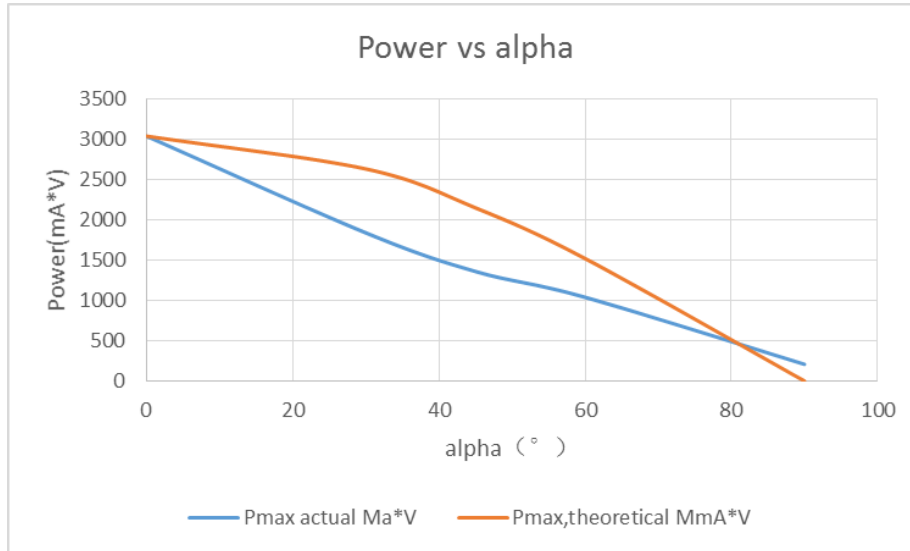

Fig 4.13 Theoretical power and actual power comparison

The analysis then come to the power efficiency of the solar cell J_D is the average current density of the photovoltaic panel in Na lamp spectral photon flux, it is calculated by light intensity distribution.

$$J_D = 1/A * \sum J_{D,i}; \quad 4.5$$

$J_{D,AM1.5}$ is the average current density of the photovoltaic panel in condition of AM1.5G standard spectral photon flux. It is an reference data, and the values goes to (Fig 4.14)

J_D mA/cm ²	$J_{D,AM1.5}$ mA/cm ²
4.500333333	16.00889545

Fig 4.14 current density in the experiment & standard

Input current should be calculated from reference data which is 68.78999 mA/cm²

$$P_{IN,AM1.5} = 68.78999 \text{ mA/cm}^2 * 90 \text{ cm} * 36 \text{ cm} * 24.24 \text{ V} \quad 4.6$$

Pmax,theoretical mA*V	Pmax,AM1.5 mA*V	Pin,AM1.5 mA*V
3040	9174.914858	5402593.65

Fig 4.15 the actual max power, and inlet power from the illumination at normal incidence.

The efficiency is the ratio of actual power and input illumination power, which is **0.001511209**, the estimated efficiency of the solar cell is much smaller than the common value of the solar cell system in the common market, which is 11-15%, it is because the photovoltaic panel used in the laboratory has a low average quantum efficiency, and the energy leakage to the atmosphere also have a large percentage. Bad condition of the solar cell also diminish its efficiency.

4.3 Computational Simulation of the photovoltaic panels.

There are many ways for solar PV simulation, local energy companies usually use PVsyst, Polysun etc. to determine the annual output and bill of buildings. For theoretical analysis, engineers usually use Matlab Simulink and Trnsys to simulate the thermos properties of solar PV. In this project I mainly use Matlab simulate the I-V curve of the system.

In Matlab Simulink, the basic current-voltage characteristics of the PV module can be expressed as

$$I = I_{ph} - I_0 [\exp (V+R_{SI} /VT) - 1] - V+R_{SI} R_p \quad 4.7$$

Where I and V are the current and voltage of the PV panel, respectively, I_{ph} is the photo generated current in the PV module, N_p is the number of cells connected in parallel, V_T is the thermal voltage of the array with N_s cells connected, a is the ideality factor of the diode, $k(1.38e-23J/K)$ is the Boltzman constant, $q(=1.602e-19C)$ is the electronic charge and T is temperature of array in Kelvin. R_s is the equivalent series resistance of the array, while R_p is the parallel resistance of the PV array.

The I-V characteristics of the PV devices depend on the internal characteristics of the device (R_s , R_p) and some external influences like irradiation level and ambient temperature. The incident light is generating the photo current, which depends linearly on the solar irradiation and temperature

$$I_{ph} = (I_{ph,n} + \alpha I \Delta T) S / S_n \quad 4.8$$

$I_{ph,n}$ is the light generated current at STC and $\Delta T = T - T_n$, which is panel temperature irradiation minus the nominal temperature. The current is difficult to determine, we usually assume $I_{sc} = I_{ph}$. The open circuit voltage is assumed to be influenced by the temperature.

$$V_{oc} = V_{oc,n}(1 + \alpha_V \Delta T) + VT \ln (S / S_n) \quad 4.9$$

Where $V_{oc,n}$ is the open circuit voltage measured at the nominal condition and α_V is the voltage-temperature coefficient, these equations is coming from the experiential data from the experiment. All PV array datasheets give basically the following information: the nominal opencircuit voltage($V_{oc,n}$), the nominal short-circuit current($I_{sc,n}$), the Maximum Power Point (MPP) voltage(V_{mp}), the MPP current(I_{mpp}), the short-circuit current/temperature coefficient(α_I), the open-circuit voltage/temperature coefficient(α_V), and the experimental peak power(P_{max}), which are measured at the nominal condition or standard test conditions(STC) of temperature $T=298K$ and solar irradiation of $S=1000W/m^2$ in which the basic equation can be written as.

$$I = I_{ph,n} - I_{0,n} [\exp (V+R_{SI} / VT,n) - 1] - V+R_{SI} R_p \quad 4.10$$

Then I introduced these equation in Matlab, and build a Simulink model to simulate the relations, its input is the ambient conditions like ambient temperature and solar irradiation and its output will be the panel parameters, I simulate the photovoltaic panel in the experiment of Chap 4.2 The code of Matlab simulation is shown in Appendix 2.

From the above calculations, I have built an Matlab Simulink model^[12] to calculate the P-V and I-V curve of the solar cell in the experiment, the basic Simulink model for the PV model shows in Fig 4.16, it has three subsystems, which relations inside is shown in Fig 4.17, Fig 4.18, Fig 4.19.

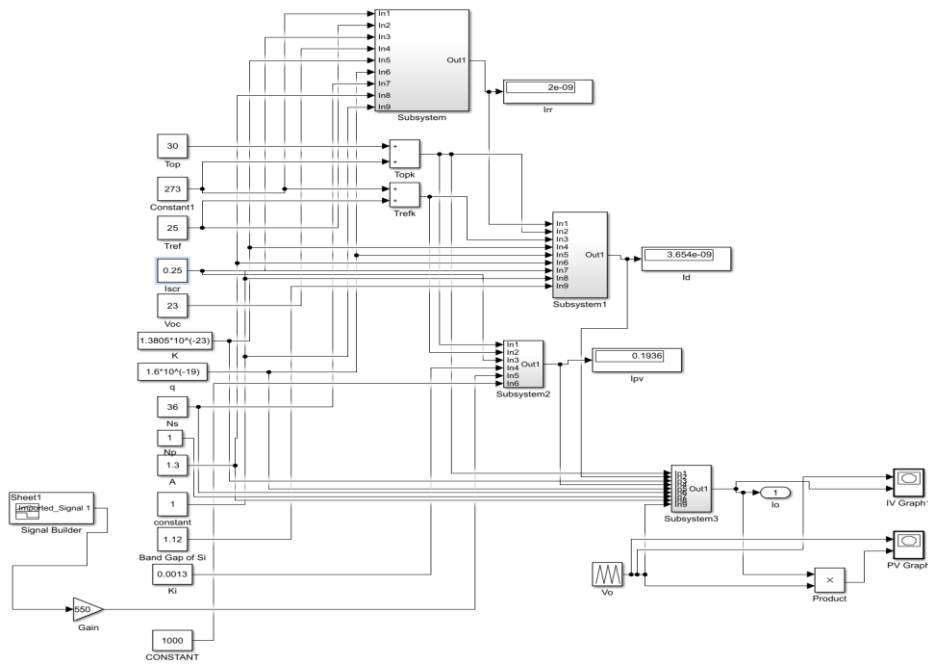

Fig 4.16 Basic model for the whole PV module in Matlab Simulink.

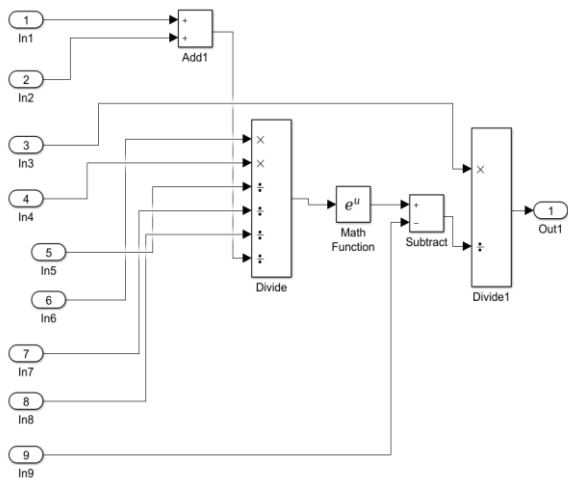

Fig 4.17 Subsystem 1

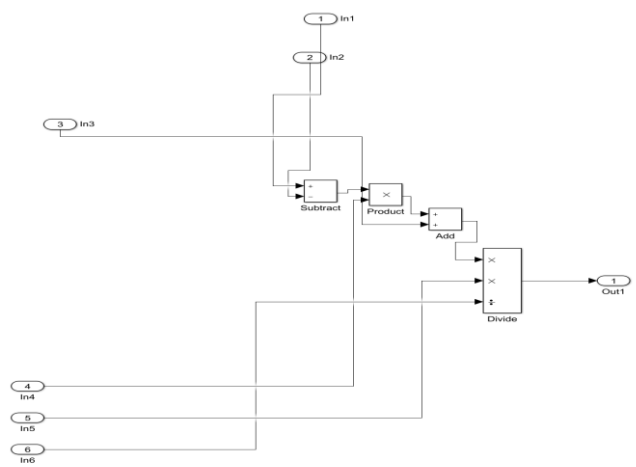

Fig 4.18 Subsystem 2

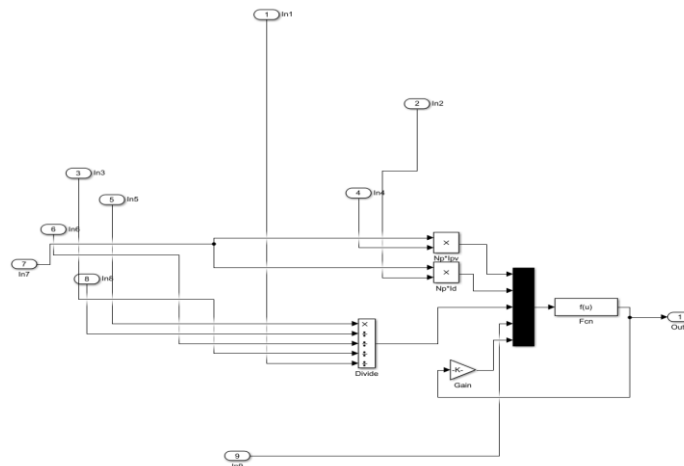

Fig 4.19 Subsystem 3.

Fig 4.20 plot the normal incidence simulation result, Fig 4.21 plot the incidence at 0. 30.45.60 degrees, compared to the result in the experiment in Fig 4.22. The correlation is basically matched. (code Appendix2)

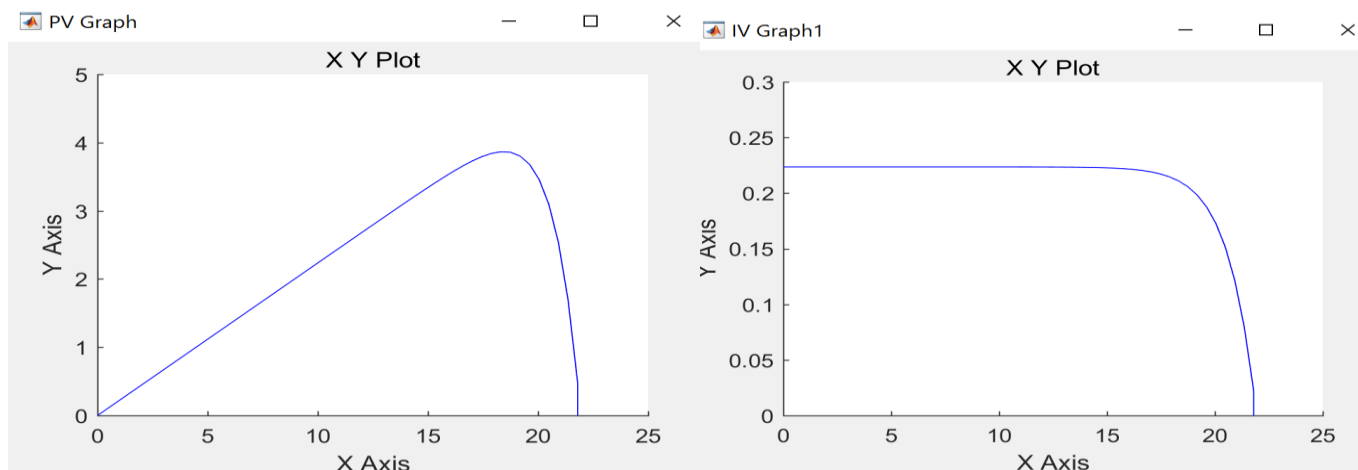

Fig 4.20 PV and IV curve at normal incidence.

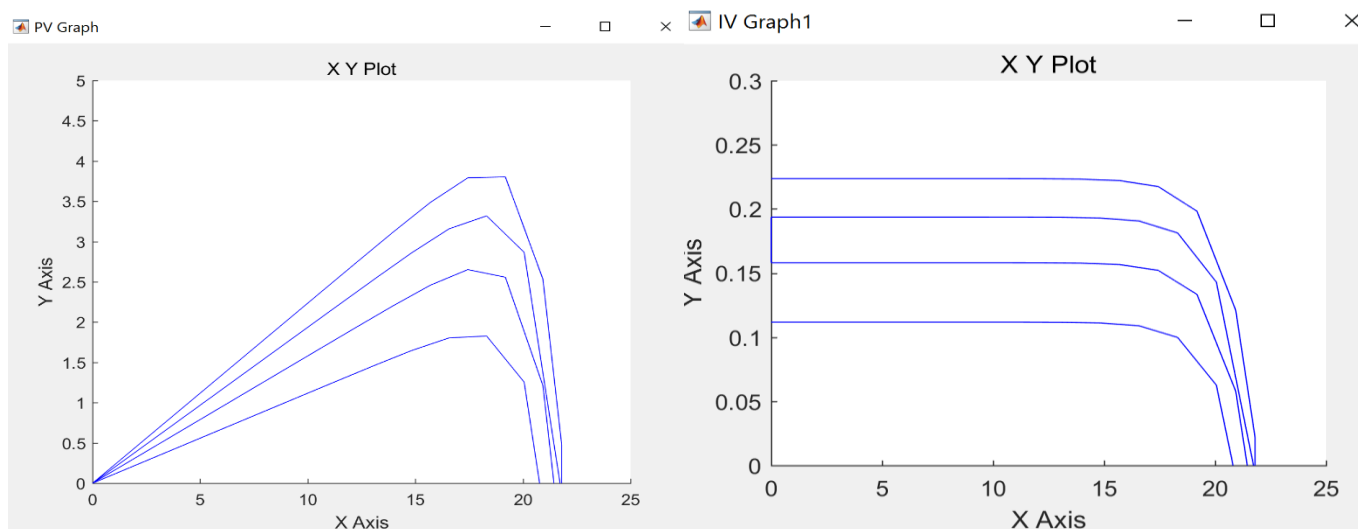

Fig 4.21 PV and IV curve at normal incidence and 30,45 60 degrees inclination in simulation

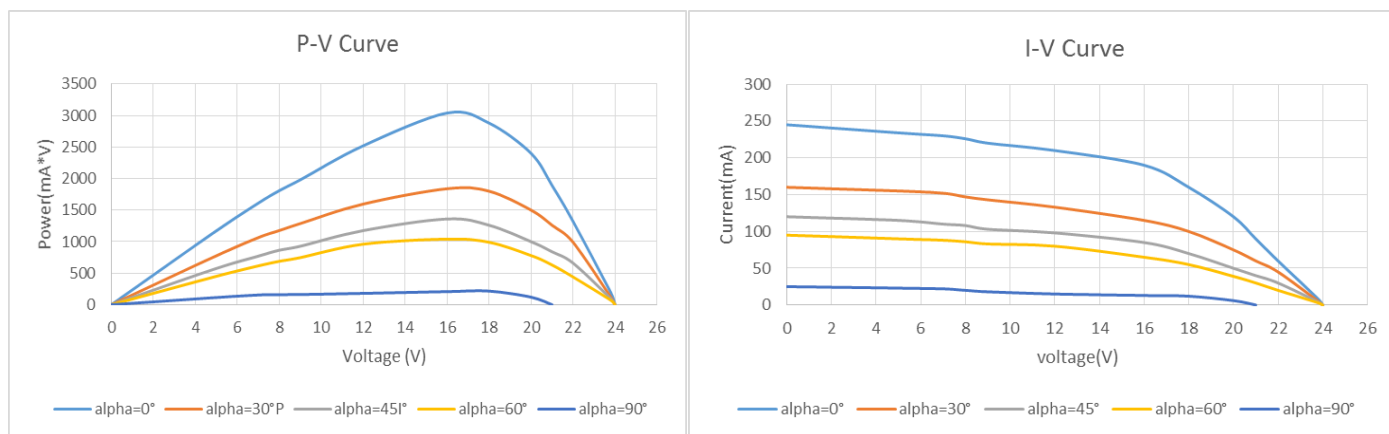

Fig 4.22 PV and IV curve at normal incidence and 30,45 60 degrees inclination.in experiment

In the simulation, the maximum power point voltage is higher than the experiment, and the short circuit current in the simulation of 30,45,60 incidence angle is higher than the experiment, which is because the light incidence on the panel is not proportional to the $\cos(\alpha)$, which will greatly enhance the uncertainty, however under sunlight with an even energy distribution, the error will be minimized. The experiment solar cell only have a maximum power output around 3W in around 0.3 m², it is much lower than the commercial PV, which is mainly due to the low efficiency of the cell and energy loss in the experiment.

4.4. Design of Solar Power Systems

4.4.1 General types of solar PV systems

PV modules can be arranged into arrays to increase electric output, solar PV system are classified based on their functional and operational requirements, component configurations, it can be classified into grid-connection and stand-alone systems.^[32] In grid connected system, the solar power is connected to local grid. The main part in this systems is power-conditioning unit (PCU), which converts the DC power produced by the PV array into AC power as per voltage and power quality requirements of the utility grid.^[13](Fig4.23) Fig 5.1 shows the general block diagram block diagram of the grid connected solar PV system,^[14] the system is connected to a larger independent grid by a residential or commercial building before or after the revenue measurement point.^[3] The size of system vary from residential(2-10kWp) to solar power stations(greater than 10s of MWp). Transforming of DC to AC by a special, synchronizing grid-tie inverter.

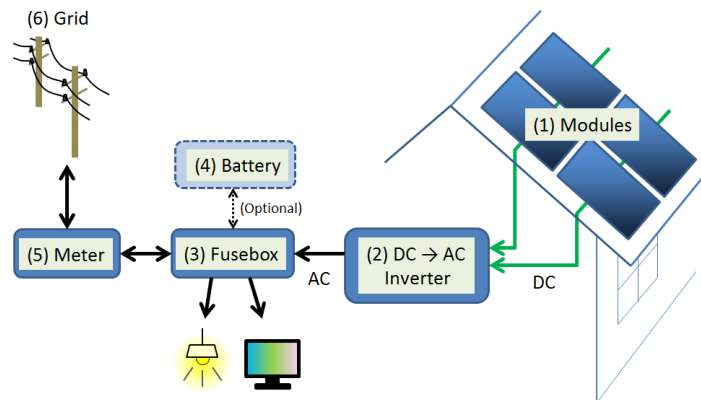

Fig 4.23 Grid-Connected Solar PV system^[33]

When the system is located in a remote area, it is called stand-alone power system, which is an off-the grid electricity system.(Fig 4.24)^[14] A simple system is an automatic solar system that produce electrical power to charge banks of batteries during the day and use at night when suns energy is unavailable, it applies rechargeable batteries to store the energy. Deep cycle lead batteries are generally used.

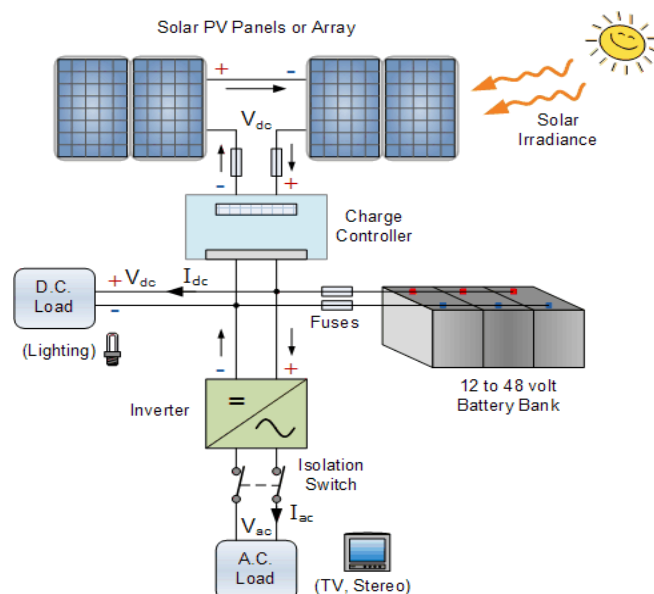

Fig 4.24 Simplified Stand Alone PV system ^[34]

Normally, solar energy would not provide the full portion of the energy need, some buildings may combine solar power from a photovoltaic system with another power generating energy source. ^[15] The common type is photovoltaic diesel hybrid system, photovoltaic-wind hybrid system. ^[16] Solar-diesel power system are generally used for it can constantly fill in the gap between the present load and the actual generated power by the PV system regardless of weather condition. Studies in 2015 showed that hybrid solar-diesel energy system have insignificant or even negative for non-public utilizes commercially. ^[17] The combination of wind and solar has the advantage that both source complement each other for the peak operating times for each system occur different time of the day and year, the output fluctuation is less than other two component systems.

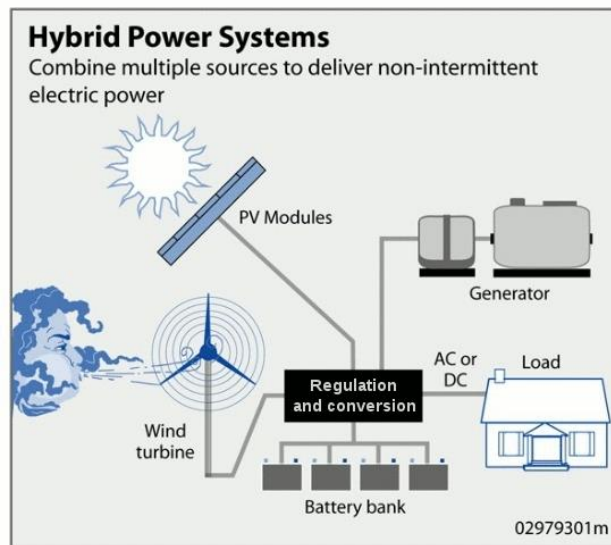

Fig 4.25 photovoltaic-wind hybrid system. ^[36]

4.4.2 Designing of domestic solar PV system

Designing of domestic solar PV system usually take 5 steps. ^[17] Firstly, designers should determine the power consumptions demands to find out the total power and energy consumption of all loads need to be supplied by electricity (in Watt-hours), multiplying the total appliances per day by 1.3, the energy lost in the system to complete the estimation. The next step is sizing the PV modules parameters, it is determined by the size of module and climate of site location, dividing the panel generation factor to calculate the energy need and number of PV panels for the system. For the inverters, the input rating should be 25-30% higher than total Watts of appliance. In the grid-connecting system, the input rating of the inverter should be the same as PV for safety operation.

For energy storage, deep cycle battery is generally used, it is usually designed for discharging at low energy level and rapid charging repeatedly after years and years, it should be large enough to store sufficient energy to operate the appliances at night and cloudy days. The last step is selecting the solar charge controller to match the voltage of PV array and batteries. The sizing of controller is depended on the total PV input current and PV panel configuration.

For my own apartment near wash U, all the electricity is connected on grid, however, in order to make simple estimation for the solar PV plans for the apartment, I made the following calculation. The electrical appliance include

4*30 Watt fluorescent lamp using 6 hours per day
3*20 Watt fluorescent lamp using 2 hours per day
1*75 Watt Refrigerator that runs 24 hours per day compressor working 12 hours on and 12 hours off

The total energy use would be $(4*30W*6h)+(3*20W*2)+(75W*24*0.5h)+ =1740Wh/day$,

Total Wp of PV panel capacity needed is $1740/3.4=511.765W$

Number of PV panels needed= $511.765/110=4.6524$. The system should be powered by at least **5** modules of 110 Wp PV module.

Total Watts of all appliance is $30+20+75=125W$, for safety, the inverter should be considered **25-30%** bigger size, which is **162.5W** or higher.

Total appliances use is **1740Wh/day**, normal battery voltage is **12V**, days for autonomy is **3days**, the battery capacity would be:

$$\frac{[(4*30W*6h)+(3*20W*2)+(75W*24*0.5h)]*3}{0.85*0.8*12} = 568.6275Ah \quad \mathbf{4.11}$$

The suitable battery should be rated 12V, 600mAh for 3 days autonomy.

Solar charge controller sizing. The Charge controller rating is $(4\text{ strings}*7.5A)*1.3=39A$, The solar charger should be rated at 40A at 12V or greater.

Pm	110Wp
Vm	16.7Vdc
Im	6.6A
Voc	20.7A
Isc	7.5A

The total information for this simplified design goes to (Fig 4.26)

Total Energy Use	1740W
Total PV Capacity	511.765W
Number of PV panels needed	5*110Wp PV module
Capacity of Batteries	12V, 600mAH, 3 days of autonomy.
Charge Controller	40A 12V

Fig 4.26 Information of simplified solar design plans.

Compared to experiential method for design, there're already many commercial design software like Polysun, PVsyst is easy to install and operate, especially for small residential building. Following is the results I simulated by PVsyst, an easy-to operate photovoltaic software.^[18]

In the PVsyst software, it automatically generate a building plans and the annual energy cost automatically. I selected PV panel with 30 degrees tilt angle and 0 degree azimuth angle, 1.49 transposition factor.(Fig 4.27)
 Fig 4.28,4.29,4.30 shows the energy consumption at day, night, and by months.

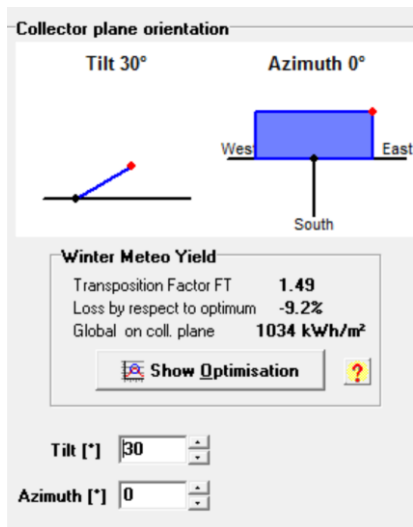

Fig 4.27 Information of Solar PV

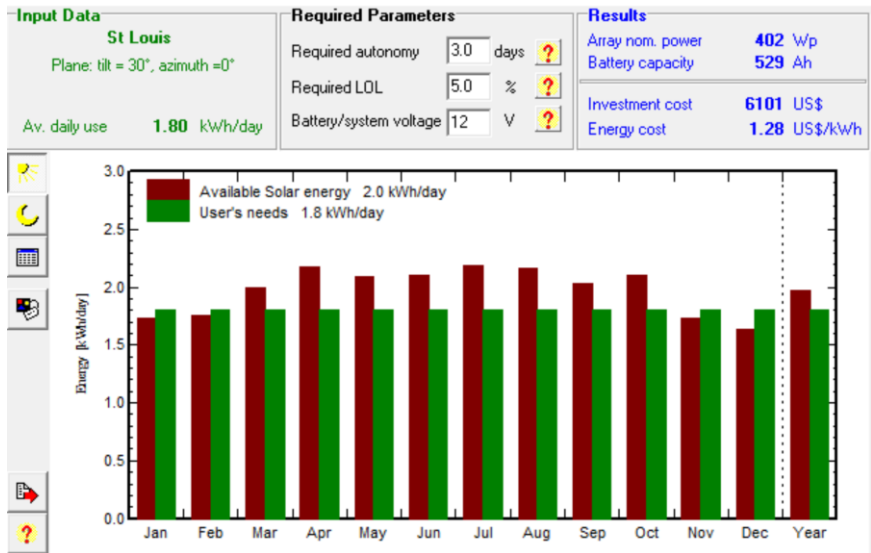

Fig 4.28 Energy consumption during days

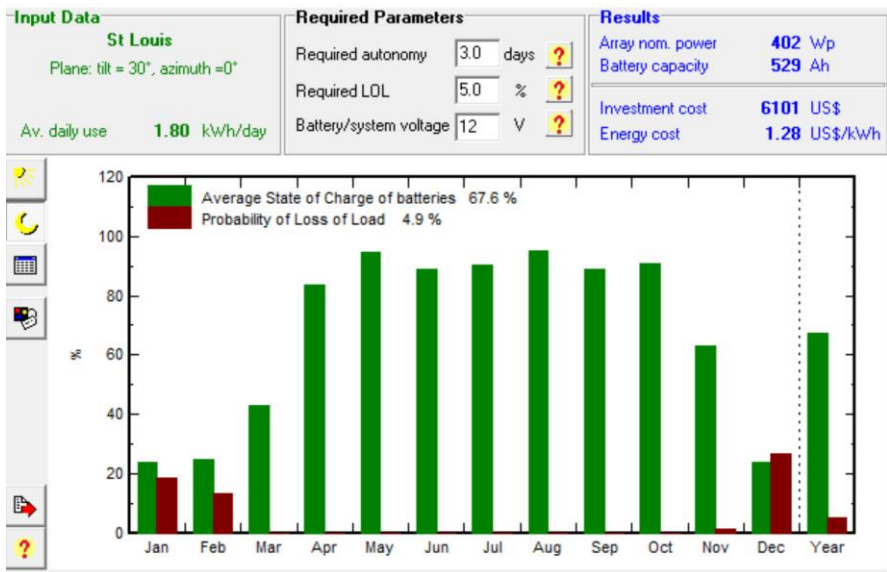

Fig 4.28 Energy consumption during days

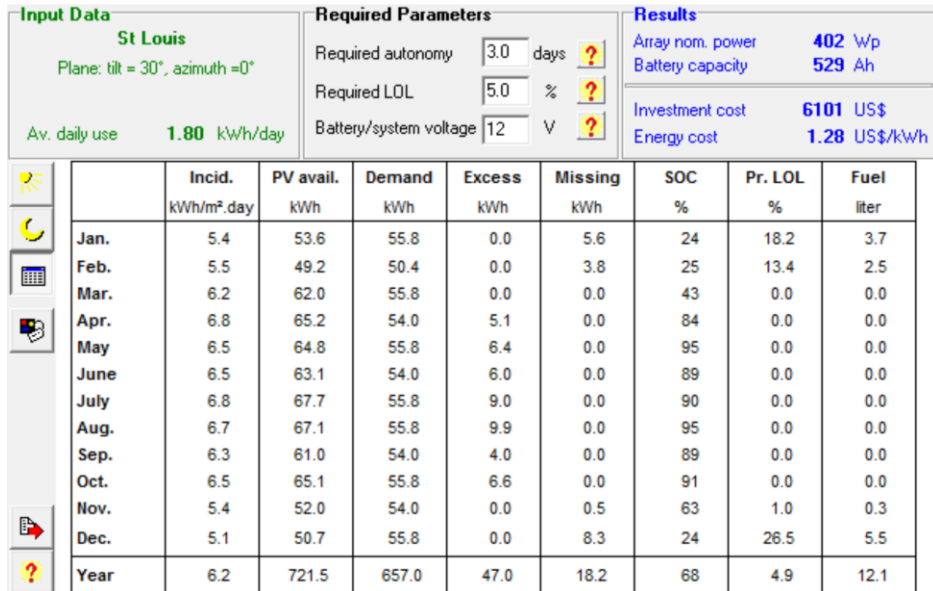

Fig 4.28 Energy consumption listed by months.

The simulation result is basically match with the experiential design, commercial can input more information like working period, location weather, and detailed solar energy information, from the report, the battery capacity is 529Ah, with the energy cost at 1.28US\$/kWh. The annual energy investment cost is 6101US\$. By using solar PV, it saved approximately 12.1 liters of fuel gas. (More information in Appendix C)

4.4.3 Design of Photovoltaic Power Stations.

In the world, different location around the globe has different incidence of solar radiation, The average insolation at a horizontal surface is shown below. Areas near the equator obtained more solar radiation, countries in Africa, South America, Oceania have more than 300W/m² of incidence. Actually, the solar panels are normally propped up at an angle and receive more energy per unit at high altitude. ^[19]

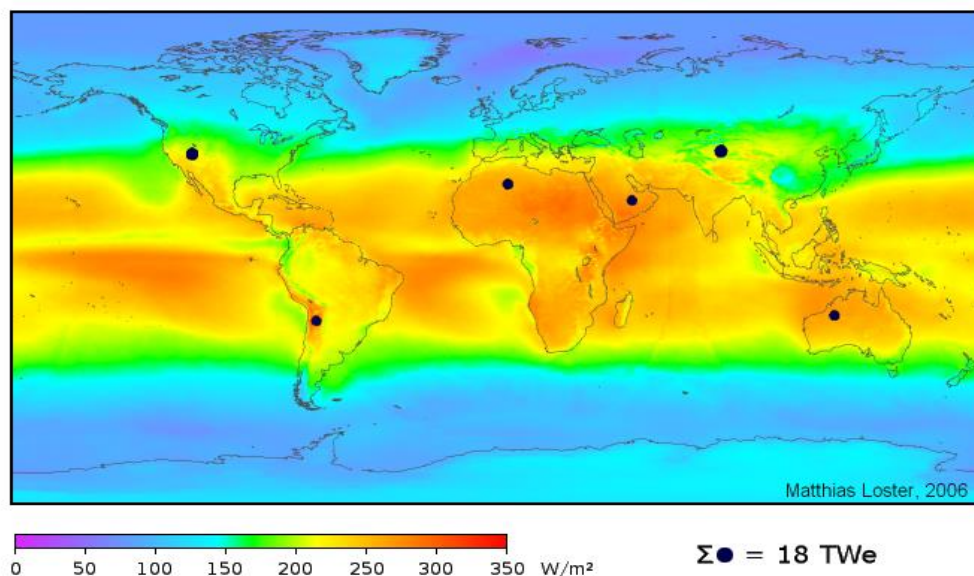

Fig 4.29 Average Insolation around the world

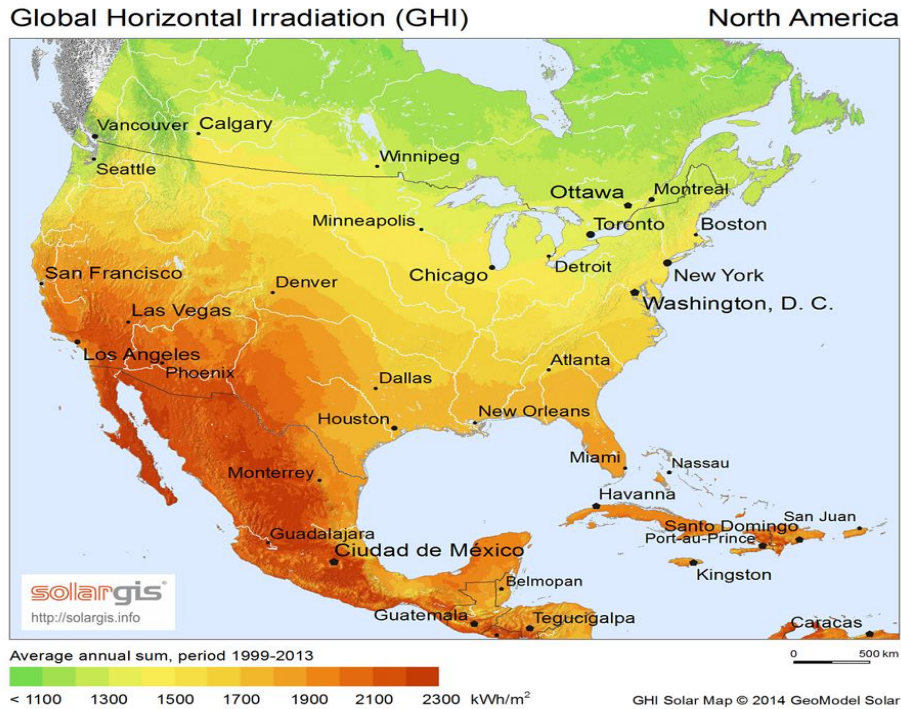

Fig 4.30 Solar Map at North America

In the United States, States like California, Arizona, Nevada has the largest amount of solar energy supply. In California, the largest state by population, Solar power capacity has reached 7378 MW in 2016, which is also the Top.1 among the states. Only a small portion of them is generated by rooftop photovoltaic panels, large scale solar power plant provide large amount of energy to grid. Over 30GW of utility scale photovoltaic power plants were under development in the United States. Some largest solar plant is located in California and Arizona. Solar City, a big energy technology company has made “Solar Strong”, a 5 years plan to build more than \$1 billion for military housing communities and create 300megawatts to provide power up to 120,000 military housing units.^[20] Also, many new manufacturing facilities for solar cells and modules in MA, OH,OR have promise to add enough capacity to produce thousands of megawatts of solar devices. Federal and States Government have pushed new incentives like “Feed-in Tariff”, “Power Purchase Agreement”, “New Construction Mandates” for further promotion.

The largest solar PV plant in US is the 579 megawatt Solar Star project in California, it was also the world largest solar plant in the world till 2015,^[22] it is located in Rosamond, California, completed in June 2015, using 1.7 million solar panels by SUNPOWER company with an area of 13 square kilometers (3200acres). It utilized a smaller number but higher efficiency arrays of solar panels, mounted on single axis trackers, contrasted to other large-scale power station like Desert Sunlight Solar Farm, which used around 9 million no trackings panels. In 2015, Solar Star has produced 821889 MW*h of power, which is 152% larger than the previous year’s energy yield. ^[23] Picture is showed in Fig 4.31, Although there are some complaints about farmland occupation, the project is planning to meet the need of 255,000 homes’ electricity use.



Fig 4.31 Overlook at the Solar Star

Solar power plant's main difference between commercial and residential solar system is its large amount of power output. Not only large number of solar cells should be installed, other technologies are usually used to increase its efficiency and yield, most generally utilized one is the concentrated solar power technology.^[24]

Concentrated solar power system generate solar power by using mirrors or lenses to concentrate sunlight onto small area, usually drive heat engines to convert into electricity. Molten salt is used to storage heat and generate after sunset. The concentrated power is commercially used in a total of 1095MW till the year of 2010, while in 2014, the number has increased to 1740MW. However, the price of concentrated solar power plant could not exceed traditional photovoltaic plant for the price of solar panels have dropped in the recent years.^[25]

Concentrating technologies exist in five common forms, namely parabolic trough, enclosed trough, dish Stirling, concentrating linear Fresnel reflector, and solar power tower.^[24] but all these technologies still far away from theoretical efficiency, using elaborate concentrators based on nonimaging optics could help close to maximum efficiency. These technologies is most efficient while in different temperature and have different efficiencies, new innovations tried to combine these technologies.

Parabolic trough use a linear parabolic reflector to concentrate light onto a receiver positioned along the reflector's focal line, the receiver follows the sun during the daylight hours by tracking along a single axis. This is the most developed CSP technology, working fluid inside the tube is heated to 150-350°C and then used as a heat source for a power generation system, the figure shows in Fig 4.32^[26]



Fig 4.32 Parabolic trough ^[46]

Solar power tower consists of an array of dual-axis tracking reflectors that concentrate sunlight on a central receiver atop a tower, in the tower consist a fluid deposit with sea water, being heated up to 500-1000°C , it has great convenience to adjust the reflectors instead of the whole tower, and have higher efficiency and better energy storage capability.(Fig 4.33) A dish stirling or dish engine system consist stand-alone parabolic reflector that concentrate light onto a receiver positioned at the reflector's focal point, and the reflector track sun along two axes. It focuses all the sunlight that strikes the dish up onto a single point above the dish, where a receiver capture the energy and working fluid is heated up into 250-700 degrees and then drive the striling engine to convert to other power.



Fig 4.33 Scheme of Solar Power Tower^[44]



Fig 4.34 Dish Stirling^[13]

4.4.4 Efficiencies of Solar Power Stations.

The efficiency μ of the incident solar radiation into mechanical work- without considering the ultimate conversion step into electricity by a power generator-depends on the thermal properties of solar receiver and on the heat engine, for theoretical analysis of efficiency, the solar irradiation is first converted into heat by the

solar receiver with efficiency $\eta_{Receiver}$, and the heat converted into work by the heat engine with an efficiency η_{Carnot} , for a solar receiver providing a heat source at temperature from T_H to T_0 , the overall

efficiency goes to

$$\eta = \eta_{Receiver} * \eta_{Carnot}$$

$$\eta_{Carnot} = 1 - \frac{T^0}{T_H}$$

$$\eta_{Receiver} = \frac{Q_{absorbed} - Q_{lost}}{Q_{solar}}$$

For a solar flux $I=1000W/m^2$ concentrated C times with an efficiency η_{Optics} on the system with a collecting area A and an absorptivity α . Emissivity ϵ , the energy equations goes to

$$Q_{solar} = \eta_{Optics} ICA$$

$$Q_{absorbed} = \alpha Q_{solar}$$

$$Q_{lost} = A\epsilon\sigma T_H^4$$

Combining these together, the efficiency relations with the hot source temperature become Fig 4.44. The overall efficiency first increase then decrease as hot source temperature increases, which is due to the relations of absorbed irradianations, and it is important in the design process to adjusting the temperature on the reflector.

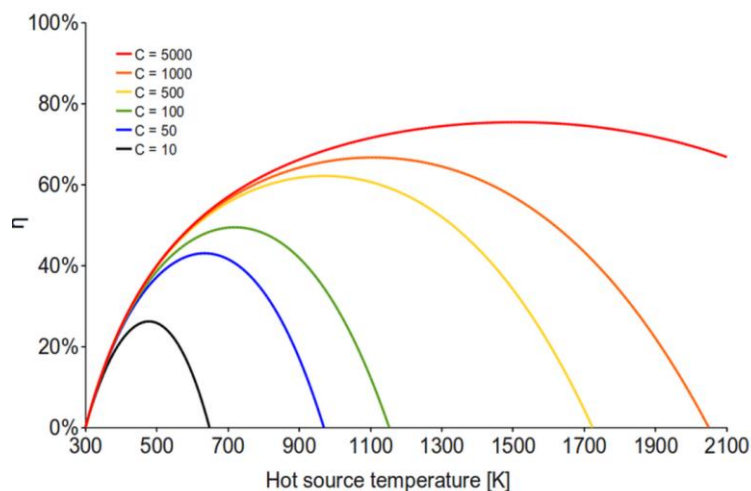

Fig 44 efficiency relations with temperatures^[44]

However, the real production of solar power plant will be 25-40% below theoretical efficiency, for instance, Solana in Arizona have a 25% below projected numbers, Ivanpah in California, is at 40% below projected numbers. Economically, CSP still could not compete with photovoltaic power plant, recent PV commercial power is selling for only 1/3 in the markets.^[44] As the year of 2009, cost of building CSP station typically cost \$2.50 to \$4 per watt, and for building a \$600-\$1000 million to build a 250MW CSP station. The cost of building and operating is expected to drop in recent studies^[29] In the year of 2012, there is already 1.9GW of CSP installed, and nearly 94.7% is utilizing the parabolic trough.

References

1. Photovoltaic <https://en.wikipedia.org/wiki/Photovoltaics>
2. The Solar Singularity is Nigh <https://www.greentechmedia.com/articles/read/The-Solar-Singularity-is-Nigh>
3. Photovoltaic System https://en.wikipedia.org/wiki/Photovoltaic_system
4. Growth of photovoltaics https://en.wikipedia.org/wiki/Growth_of_photovoltaics
5. Snapshot of global photovoltaic markets
http://www.ieapvps.org/fileadmin/dam/public/report/PICS/IEA-PVPS_-_A_Snapshot_of_Global_PV_-_1992-2015_-_Final_2_02.pdf
6. Solar Cell https://en.wikipedia.org/wiki/Solar_cell
7. Photovoltaic Effect https://en.wikipedia.org/wiki/Photovoltaic_effect
8. New world record for solar cell efficiency at 46% – French-German cooperation confirms competitive advantage of European photovoltaic industry <https://www.ise.fraunhofer.de/en/press-media/press-releases/2014/new-world-record-for-solar-cell-efficiency-at-46-percent.html>
9. Strengthening the case for recycling photovoltaics. An energy payback analysis.
<http://www.sciencedirect.com/science/article/pii/S0306261914000555>
10. What it will take for them to become a success outside academia.
<http://www.sciencedirect.com/science/article/pii/S0927024813002535>
11. Photovoltaic Lab material by professor Elijah Thimson.
12. Solar PV and Wind Energy Conversion Systems. An introduction to Theory, Modeling with Matlab, Simulink, and the Role of Soft Computing Techniques, *Green Energy and Technology*.
13. How to design Solar PV system?
http://www.leonics.com/support/article2_12j/articles2_12j_en.php
14. Stand alone PV system https://en.wikipedia.org/wiki/Stand-alone_power_system
15. Solar Hybrid Power systems https://en.wikipedia.org/wiki/Solar_hybrid_power_systems
16. Hybrid Power System https://en.wikipedia.org/wiki/File:Hybrid_Power_System.gif
17. Renewable Energy in Hybrid Mini-Grids and Isolated Grids, Economic Benefits and Business Cases <http://fs-unep-centre.org/publications/renewable-energy-hybrid-mini-grids-and-isolated-grids-economic-benefits-and-business#overlay-context=publications>
18. PVsyst <http://www.pvsyst.com/en/>
19. Solar Power https://en.wikipedia.org/wiki/Solar_power

20. Solar Power in the United States

https://en.wikipedia.org/wiki/Solar_power_in_the_United_States#Solar_photovoltaic_power

21. Solar Star https://en.wikipedia.org/wiki/Solar_Star

22. Solar Star, Largest PV Power Plant in the world, New Operational.

<https://www.greentechmedia.com/articles/read/Solar-Star-Largest-PV-Power-Plant-in-the-World-Now-Operational>

23. We Make the Complex Simple <https://us.sunpower.com/utility-scale-solar-power-plants/>

24. Concentrated Solar Power https://en.wikipedia.org/wiki/Concentrated_solar_power#Efficiency

25. Renewable Bounced Back in 2010, Find REN21 Global Report

https://en.wikipedia.org/wiki/Concentrated_solar_power#Efficiency

26. Parabolic trough https://en.wikipedia.org/wiki/Parabolic_trough

27. Solar Power Tower https://en.wikipedia.org/wiki/Solar_power_tower

28. Solana Generating Station https://en.wikipedia.org/wiki/Solana_Generating_Station

29. Renewable Energy Jobs & Access

<https://web.archive.org/web/20120613192252/http://www.irena.org/menu/index.aspx?mnu=cat&PriMenuID=36&CatID=128>