

Washington University in St. Louis

Washington University Open Scholarship

Mechanical Engineering Design Project Class

Mechanical Engineering & Materials Science

Fall 12-10-2017

Light Activated Blinds Group K

Griffin Beriont

Washington University in St. Louis

Kessashun Arthur

Washington University in St. Louis

Madeline Stadler

Washington University in St. Louis

Follow this and additional works at: <https://openscholarship.wustl.edu/mems411>



Part of the [Mechanical Engineering Commons](#)

Recommended Citation

Beriont, Griffin; Arthur, Kessashun; and Stadler, Madeline, "Light Activated Blinds Group K" (2017).

Mechanical Engineering Design Project Class. 75.

<https://openscholarship.wustl.edu/mems411/75>

This Final Report is brought to you for free and open access by the Mechanical Engineering & Materials Science at Washington University Open Scholarship. It has been accepted for inclusion in Mechanical Engineering Design Project Class by an authorized administrator of Washington University Open Scholarship. For more information, please contact digital@wumail.wustl.edu.



Washington University in St. Louis

SCHOOL OF ENGINEERING & APPLIED SCIENCE

Our final demonstration of our project did not fully meet our expectations, but we were able to meet the majority of our performance goals. We were able to achieve a circuitry setup in which we had light being received and transmitted to activate the motor to drive the motion of the blinds. We were able to keep the overall design under our weight goal of approximately three pounds. We were also able to ensure that our battery life was well able to perform more than 30 cycles of the light detection to movement process.

Meeting our performance goals posed a bigger issue than we had thought as we decided to use pure circuitry instead of some type of Arduino Software. This made our overall process and execution more complex although we were not able to fully succeed in accomplishing our performance goals. Another key takeaway is that motors are more complex than we thought in regards to providing enough torque to speed ratio. Since we were constrained to keep a small budget, we could not afford a motor that could meet our needs by itself. After doing the initial demonstration of our prototype, we determined that we should have designed a gear system that could have increased torque. Overall, we learned that the planning and executing is a complex process that requires a lot of trial and error. In future projects, we would definitely have planned multiple design build cycles to ensure the best possible results/product.

MEMS 411: Senior Design Project

Project Name

Kessashun Arthur

Griffin Beriont

Madeline Stadler

TABLE OF CONTENTS

List of Figures	4
List of Tables	5
1 Introduction and Background Information.....	6
1.1 Initial Project Description	6
1.2 Existing Products	6
1.3 Relevant Patents.....	6
1.4 Codes & Standards.....	6
1.5 Project Scope	6
1.6 Project Planning	8
1.7 Realistic Constraints	8
1.7.1 Functional	8
1.7.2 Safety	8
1.7.3 Quality.....	9
1.7.4 Manufacturing.....	9
1.7.5 Timing.....	9
1.7.6 Economic	9
1.7.7 Ergonomic.....	9
1.7.8 Ecological	9
1.7.9 Aesthetic	9
1.7.10 Life Cycle.....	9
1.7.11 Legal	10
1.8 Revised Project Description.....	10
2 Customer Needs & Product Specifications.....	10
2.1 Customer Interviews	10
2.2 Interpreted Customer Needs.....	11
2.3 Target Specifications.....	12
3 Concept Generation	13
3.1 Functional Decomposition	13
3.2 Morphological Chart.....	14
3.3 Concept #1 – “Solinearcuit”	15

3.4	Concept #2 – “power provides rotation”.....	16
3.5	Concept #3 – “Lights, battery, action”.....	17
3.6	Concept #4 – “spins with the sun”.....	18
3.7	Concept #5 – “directurns”.....	18
3.8	Concept #6 – “solar powered code monkey”.....	19
4	Concept Selection.....	20
4.1	Concept Scoring Matrix.....	20
4.2	Explanation of Winning Concept Scores.....	20
4.3	Explanation of Second-Place Concept Scores.....	21
4.4	Explanation of Third-Place Concept Scores.....	21
4.5	Summary of Evaluation Results.....	21
5	Embodiment & Fabrication plan.....	22
5.1	Exploded view with Bill of Materials.....	22
5.2	Isometric drawing with additional views.....	23
6	Engineering Analysis.....	23
6.1	Engineering Analysis Results.....	23
6.1.1	Motivation.....	23
6.1.2	Summary Statement of the Analysis.....	23
6.1.3	Methodology.....	25
6.1.4	Results.....	25
6.1.5	Significance.....	25
6.2	Product Risk Assessment.....	26
6.2.1	Risk Identification.....	26
	Risk Heat Map.....	27
6.2.2	Risk Prioritization.....	27
7	Design Documentation.....	27
7.1	Performance Goals.....	27
7.2	Working Prototype Demonstration.....	28
7.2.1	Performance Evaluation.....	28
7.2.2	Working Prototype – Video Link.....	28
7.2.3	Working Prototype – Additional Photos.....	29
8	Discussion.....	30
8.1	Design for Manufacturing – Part Redesign for Injection Molding.....	30

8.1.1	Draft Analysis Results	30
8.1.2	Explanation of Design Changes	30
8.2	Design for Usability – Effect of Impairments on Usability	31
8.2.1	Vision.....	31
8.2.2	Hearing.....	31
8.2.3	Physical.....	31
8.2.4	Language.....	31
8.2	Overall Experience.....	31
8.2.1	Does your final project result align with the initial project description?.....	31
8.2.2	Was the project more or less difficult than you had expected?.....	31
8.2.3	In what ways do you wish your final prototype would have performed better?	32
8.2.4	Was your group missing any critical information when you evaluated concepts?	32
8.2.5	Were there additional engineering analyses that could have helped guide your design? ...	32
8.2.6	How did you identify your most relevant codes and standards and how they influence revision of the design?	32
8.2.7	What ethical considerations (from the Engineering Ethics and Design for Environment seminar) are relevant to your device? How could these considerations be addressed?	32
8.2.8	On which part(s) of the design process should your group have spent more time? Which parts required less time?.....	33
8.2.9	Was there a task on your Gantt chart that was much harder than expected? Were there any that were much easier?.....	33
8.2.10	Was there a component of your prototype that was significantly easier or harder to make/assemble than you expected?	33
8.2.11	If your budget were increased to 10x its original amount, would your approach have changed? If so, in what specific ways?.....	33
8.2.12	If you were able to take the course again with the same project and group, what would you have done differently the second time around?.....	33
8.2.13	Were your team member’s skills complementary?	34
8.2.14	Was any needed skill missing from the group?	34
8.2.15	Has the project enhanced your design skills?	34
8.2.16	Would you now feel more comfortable accepting a design project assignment at a job?...	34
8.2.17	Are there projects you would attempt now that you would not have attempted before?	34
9	Appendix A - Parts List	35
10	Appendix B - CAD Models	35

LIST OF FIGURES

Figure 1: Gantt Chart 8
 Figure 2: Function tree for LAB 13
 Figure 3: Concept Design #1: Solinearcuit 15
 Figure 4: Concept Design #2: Power Provides Rotation 16
 Figure 5: Concept Design #3: Lights, Battery, Action..... 17
 Figure 6: Concept Design #4: Spins with the Sun 18
 Figure 7: Concept Design #5: Directurns 18
 Figure 8: Concept Design #6: Solar Powered Code Monkey 19
 Figure 9: Exploded View with Bill of Materials..... 22
 Figure 10: Isometric Draw

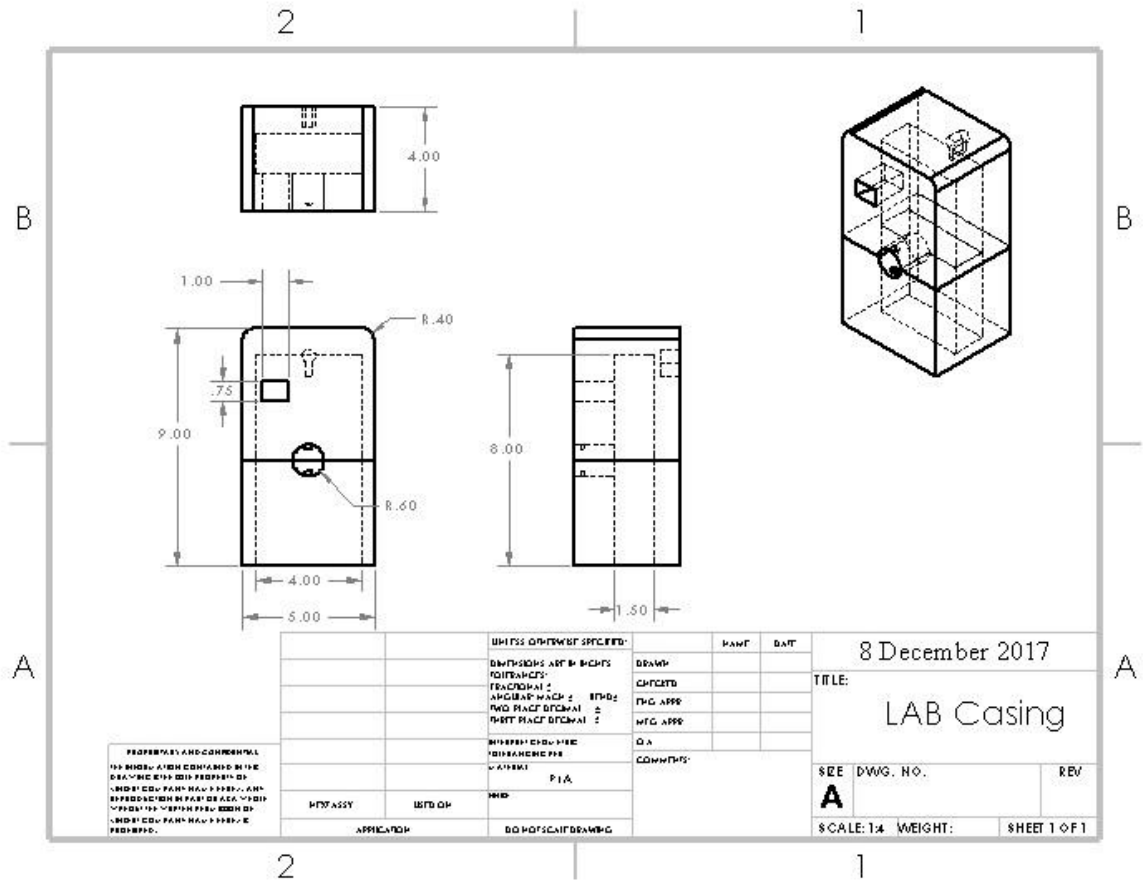

..... 23
 Figure 11: Stresses Present on the Motor..... 25
 Figure 12: Risk Assessment Heat Map 27
 Figure 13: Image of Final Prototype 29
 Figure 14: (Before) Draft Analysis Results 30
 Figure 15: (After) Draft Analysis Results..... 30
 Figure 16: Solidworks Model of Final Part 35

LIST OF TABLES

Table 1: Target product specifications for light automated blinds..... 12
Table 2: Morphological Chart for LAB 14
Table 3: Concept Scoring Matrix..... 20
Table 4: Risk Prioritization..... 26
Table 5: Parts List 35

1 INTRODUCTION AND BACKGROUND INFORMATION

1.1 INITIAL PROJECT DESCRIPTION

The purpose of this project is to develop an attachable device to a pair of rolling blinds that will automatically open them when sunlight is detected and close them when the sun goes down. This device will promote energy efficiency during warmer and colder months. And be a commodity for those who tend to forget to open close blinds.

1.2 EXISTING PRODUCTS



MOVE – blind and shade motorizer: This product uses a motor to open and close various different kinds of shades and blinds that can be found in a typical household. It is easily installed, small, but requires human operation to open and close. It attaches to the string of the blinds and uses a pulley motion to raise and lower them.

1.3 RELEVANT PATENTS

N/A

1.4 CODES & STANDARDS

European Standard on Internal Blinds – Protection from strangulation hazards – Test Methods (safety regulations for all blinds, windows, doors, & shutters)

1.5 PROJECT SCOPE

1. Write an overview of the purpose of the project
 - The purpose of this project is to develop an attachable device to a pair of rolling blinds that will automatically open them when sunlight is detected and close them when the sun goes down. This device will promote energy efficiency during warmer and colder months. And be a commodity for those who tend to forget to open close blinds.
2. Identify the customer for your eventual product
 - Customers for this product would be average home/apartment owners, as well as businesses with many windows that want to promote efficiency. Another potential market could be those who have hard-to-reach blinds.
3. Specify the value or benefits to the customer

- This will be an inexpensive device that will more than pay for itself long-term. Energy bills can be reduced by using this device year-round, to compensate for most homeowners not immediately opening and closing blinds at sunrise and sunset. Larger building/businesses can see even greater savings over time. Beyond being a luxury, it requires no human interaction after installation.
4. Define the project goals. A project goal statement should ideally be:
 - The goal of the project is to produce a device that can easily be attached to an existing pair of rolling blinds. This device will be able to roll up and unroll the blinds without any human operation throughout the process. It will also be able to detect light and use the detection as an indication of when to roll/unroll. Ideally the device will be light weight and easy to install; no electrical connectivity will be necessary.
 5. Identify what is in scope – what will the project accomplish?
 - Some of the design factors that are in the scope of this project include the following:
 - i. Open and close blinds with motor use
 - ii. Light sensing component of a circuit to activate motor
 - iii. Connectivity to an existing pair of rolling blinds
 - iv. Casing that doesn't expose any electrical components; little to no installation needed for device
 - v. Battery usage if necessary
 6. Identify what is out of scope – what will the project not accomplish?
 - Some of the design factors that are not in the scope of this project include:
 - i. Fully run on solar power
 - ii. Remote to allow manual operation
 - iii. Wireless capabilities (mobile app)
 - iv. Calibration of which side of the house window is on us light intensity
 - v. Design to fit all types of blinds
 7. Identify a few critical success factors for your project
 - Some of the critical success factors for this project include:
 - i. Must roll and unroll a pair of blinds automatically
 - ii. Must remain attached or connected to a pair of blinds
 - iii. Must detect sunlight vs darkness
 8. Identify project assumptions Identify items taken as being true for the purposes of planning a project but could change later; think about the potential impact if the assumption prove to be false
 - We assume that all rolling blinds have a uniform design and a similar size. We also assume that all windows will have a reasonable amount of sunlight exposure. If these prove to be false, we would have to adjust the sensitivity of our light detecting or accept that all windows cannot use it. We would also have to make size adjustments or make a more versatile design.
 9. Identify project constraints
 - For the scope of our project, we are constrained with programming and software ability. We cannot make a device that is very “home” compatible as many popular modern products are. We are constrained to a single type of blinds and a single method of opening and closing. Testing also may be constrained as we cannot test the products functionality with natural light at any point of the day or night.
 10. Identify key project deliverables

- Some of the key deliverables for this project included:
 - i. Open and close in a reasonable amount of time
 - ii. Size under 80 in² per side
 - iii. Responds to sunlight detection
 - iv. Relatively cheap to produce; able to sell for \$30

1.6 PROJECT PLANNING

Figure 1: Gantt Chart

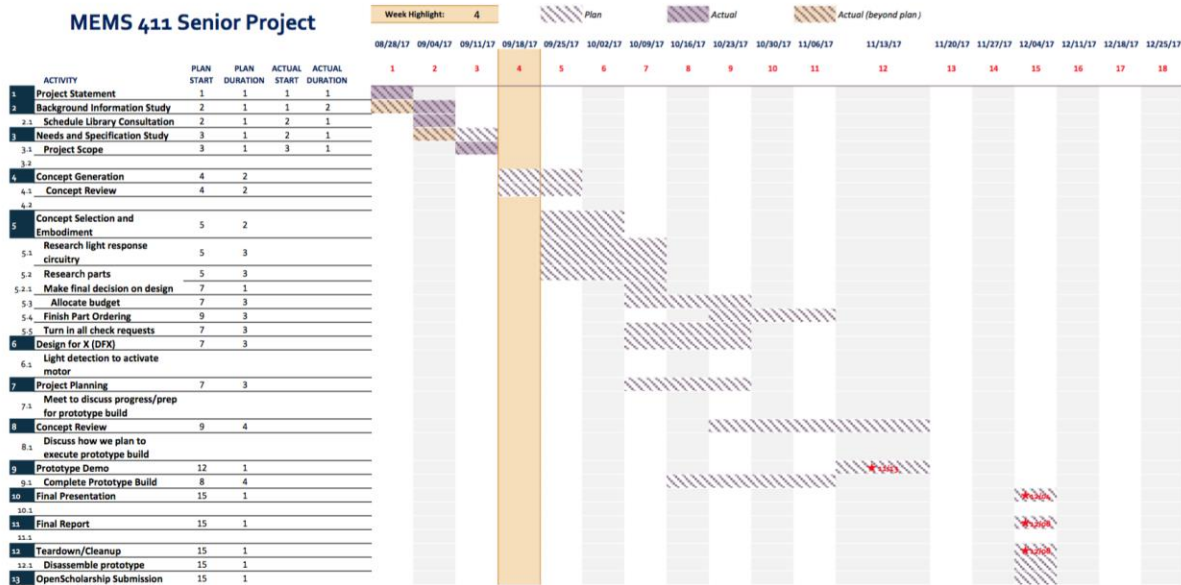

1.7 REALISTIC CONSTRAINTS

1.7.1 Functional

Our design must be able to attach to a wall and hang for a long period of time, therefore, LAB cannot be too heavy or too bulky. We also have to take into account a motor that can turn 360 degrees rather than 180 degrees, and we must make sure that we have a motor that can pull a cord. This can often get pricy so the constraint comes with staying in our given budget. We are constrained to a power source that is mounted within the system rather than plugging the device directly into a power source such as a wall so we must ensure the battery can continue working and does not die out quickly.

1.7.2 Safety

The device is going to be an aftermarket fit to an existing pair of blinds so we must ensure that this is safe to assemble for the user and also that the device is safe once installed. There is little to worry about in regards to this with the main concern being that the box could overheat due to the internal circuitry.

1.7.3 Quality

One of the standards that was applicable was that blinds can often be a choking hazard so we must ensure that the attachment can be manually stopped. We also have to keep in mind that a lot of small parts make up our part so these must be labeled as a potential choking hazard as well.

1.7.4 Manufacturing

We do not have any constraints involved with manufacturing as all of our parts are easy to find on the market today, but we do not have the budget to mass produce the product. This is the only constraint we have, but we are not too concerned, because we have the means to find all of the parts required to build this device.

1.7.5 Timing

We are constrained to one semester to complete the entire project. We also are under a time constraint for each assignment. This makes our design concept generation a very quick process to ensure we can focus our efforts on perfecting that design through the semester. We also are given two weeks to update our prototype after the initial presentation so we must work quickly to make changes with little time to purchase new parts.

1.7.6 Economic

The biggest economic constraint is that we are provided a budget for this project. We have to be able to find parts that are inexpensive in order to stay within that budget and also leave room in case we must make improvements and have to last minute order parts. Mass manufacturing this part would be ideal, but this is also a constraint, because this is extremely expensive compared to that budget we are allotted. For example, many motors with high torque are available, but very few are under hundreds of dollars.

1.7.7 Ergonomic

One of our biggest constraints was using internal circuitry. This required a lot of manual rewiring rather than using a computer software where we could easily rewrite the code quickly.

1.7.8 Ecological

Our biggest constraint is trying to make a product with reusable or recyclable parts. Most of our design is/ will meet this goal. The only issue we may have is that we plan to use a battery. Batteries can be recycled, but most people just toss them into the trash can which is horrible for the environment.

1.7.9 Aesthetic

This product is ideally for a residential home, therefore, the user is most likely looking for something to blend in with their current home décor. We also want to make a product that is an easy fit onto the wall and is out of the way. These are our constraints when trying to keep our product pleasing for the consumer.

1.7.10 Life Cycle

We want to create a product that requires very little maintenance by the consumer, therefore, having a durable device is required. We also want to ensure our battery remains working for a long period of time so the user is not constantly changing it. Most of our parts must also be

recyclable so that they do very little harm to the environment after the user is finished with the product.

1.7.11 Legal

We must comply with the standard that states the blinds cannot be hazardous to the consumer during operation. Other than this, there are not realistic constraints in regards to legal issues.

1.8 REVISED PROJECT DESCRIPTION

The goal of this project is to produce a device that can easily be attached to an existing pair of rolling blinds. This device will be able to roll up and unroll the blinds without any human operation throughout the process. It will also be able to detect light, and use this detection as an indication of when to roll and unroll. This device will promote energy efficiency during warmer and colder months and be a commodity for those who tend to forget to open and close the blinds.

2 CUSTOMER NEEDS & PRODUCT SPECIFICATIONS

2.1 CUSTOMER INTERVIEWS

1. Are the majority of your blinds within reach?
 - Yes, most of them are in reachable spots.
2. Do you have any concerns about the solar panel versus manually rolling the blinds?
 - Yes, what about days when the sun does not come up. I want to be able to manually open the blinds if I have to. Yes, the sun does not hit the side of my house.
3. Do you have an issue with an added attachment on the current string that opens the blinds?
 - I want it as small as it can be.
4. How fast should the blinds open? Does it even matter?
 - I don't want it fast, but I don't want it slow. It should be a reasonable time frame that it takes for the blinds to open and close.
5. Do you think this is convenient for people who may forget to shut their blinds in the evening?
 - Yes. I make sure to shut my blinds so people cannot see in my house. I always get out of bed to shut them if I realize I may have forgotten.
6. Is there a particular reason you prefer your blinds open during the day? Why?
 - I open them to get sunlight into the house, because I t makes me feel better.
7. How much would you spend on a solar panel attachment that we are thinking about creating if your blinds were in fact out of reach? Would you even spend the money on this?
 - Oh wow! If I couldn't reach them that would be bad. I probably would spend about \$50 a blind.
8. Would you also like a remote in case you feel like closing them during the day in case you want to get rid of the light?
 - Yes. That would be worth it to me.
9. Do you have any other capabilities you want to see from this sort of product?
 - I have nothing else I would need. It if works, create it for other types of blinds systems.
Honestly, I just would really like the remote in case it is sunny an I want to take a nap.
10. I asked the interviewee for other questions he is thinking...

- Can I control it with my phone? Are they all attached to one unit so they open in unison or is this just for a single window panes blinds? Can I control it from my Bluetooth remote or an app on my phone that I control from anywhere?
11. Do you think having only solar energy to activate is an issue?
 - Yes. I think a battery backup is necessary. Sometimes we don't get sunlight and people in Seattle rally don't get sunlight. Are you going to only sell this in Jamaica?
 12. Do you think appearance is necessary to think about?
 - Yes. My wife would not like this attachment to throw off the theme of the house so I need different colors or I need to be able to paint it. I also don't want that in the way when the blinds shut.
 13. Do you think this product would sell in a more commercialized setting rather than home settings?
 - Absolutely. If I own a company, I want my blinds to open while we work and I want them to close when no one is there. If I don't have to remember to do that, that is an added bonus. Not to mention, some companies cannot even reach their blinds that easy.
 14. Do you prefer the blinds you have?
 - Yes I like that I can tilt mine open. But like I said, in commercial settings, they want rolling blinds, because they can clean them easy and also most are out of reach. You should make this product geared towards a commercial buyer for a company.

2.2 INTERPRETED CUSTOMER NEEDS

1. Do you have any concerns about the solar panel versus manually rolling the blinds? - Yes, what about days when the sun does not come up. I want to be able to manually open the blinds if I have to. Yes, the sun does not hit the side of my house.
 - LAB allows manual opening.
2. Do you have an issue with an added attachment on the current string that opens the blinds? - I want it as small as it can be.
 - LAB should be small and out of the way.
3. How fast should the blinds open? Does it even matter? - I don't want it fast, but I don't want it slow. It should be a reasonable time frame that it takes for the blinds to open and close.
 - LAB opens blinds at a reasonable pace.
4. Do you think this is convenient for people who may forget to shut their blinds in the evening? - Yes. I make sure to shut my blinds so people cannot see in my house. I always get out of bed to shut them if I realize I may have forgotten.
 - LAB closes blinds when the sun goes down.
5. Is there a particular reason you prefer your blinds open during the day? Why? - I open them to get sunlight into the house, because it makes me feel better.
6. How much would you spend on a solar panel attachment that we are thinking about creating if your blinds were in fact out of reach? Would you even spend the money on this? - Oh wow! If I couldn't reach them that would be bad. I probably would spend about \$50 a blind.
 - LAB should be relatively inexpensive.
7. Would you also like a remote in case you feel like closing them during the day in case you want to get rid of the light? - Yes. That would be worth it to me.
 - LAB has remote control/ wall attachment should be available.

8. Do you have any other capabilities you want to see from this sort of product? – I have nothing else I would need. If it works, create it for other types of blinds systems. Honestly, I just would really like the remote in case it is sunny and I want to take a nap.
 - Remote available so blinds close without disrupting people from rest.
9. I asked the interviewee for other questions he is thinking...- Can I control it with my phone? Are they all attached to one unit so they open in unison or is this just for a single window pane blinds? Can I control it from my Bluetooth remote or an app on my phone that I control from anywhere?
 - LAB system contains wireless capabilities if not only light powered.
10. Do you think having only solar energy to activate is an issue? – Yes. I think a battery backup is necessary. Sometimes we don't get sunlight and people in Seattle really don't get sunlight. Are you going to only sell this in Jamaica?
 - LAB has an alternative way to open blinds.
11. Do you think appearance is necessary to think about? – Yes. My wife would not like this attachment to throw off the theme of the house so I need different colors or I need to be able to paint it. I also don't want that in the way when the blinds shut.
 - LAB is available in multiple colors or can be painted.
12. Do you think this product would sell in a more commercialized setting rather than home settings? – absolutely. If I own a company, I want my blinds to open while we work and I want them to close when no one is there. If I don't have to remember to do that, that is an added bonus. Not to mention, some companies cannot even reach their blinds that easy.
 - LAB has completely automatic open/close setting.
13. Do you prefer the blinds you have? – Yes I like that I can tilt mine open. But like I said, in commercial settings, they want rolling blinds, because they can clean them easy and also most are out of reach. You should make this product geared towards a commercial buyer for a company.
 - LAB is compatible with larger width blinds that exist in a company setting.

2.3 TARGET SPECIFICATIONS

Table 1: Target product specifications for light automated blinds.

Metric Number	Associated Needs	Metric	Units	Acceptable	Ideal
2	2	Area of the entire box	in ²	<80	<70
3	3	Time to open the blinds	Seconds	8<x<10	6<x<8
4	4,8,9	Does the blind perform these tasks?	1=yes,0=no	1	1
5	5	Cost for the consumer	dollars	<50	<30
6	10	Color options	integers	>1	>2
7	12	Torque to enable the blinds to work with different size blinds such as home vs commercial settings	lbf/in	6<x<8	5<x<7

3 CONCEPT GENERATION



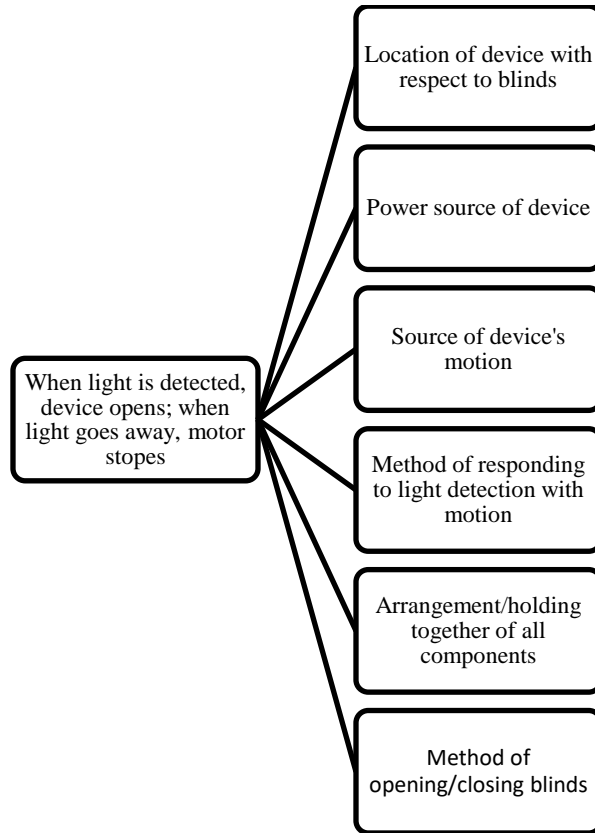

3.1 FUNCTIONAL DECOMPOSITION

Figure 2: Function tree for LAB

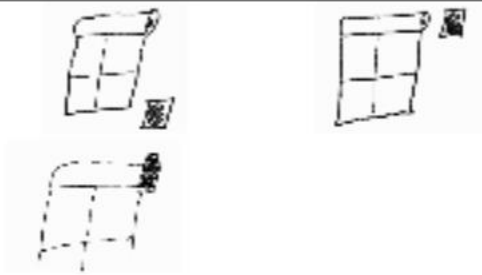

3.2 MORPHOLOGICAL CHART

Table 2: Morphological Chart for LAB

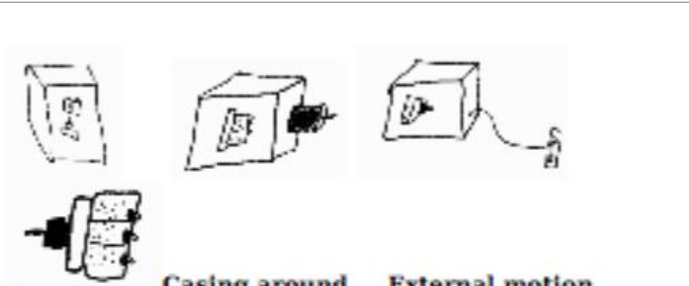
<p>Location of device with respect to blinds</p>	 <p> Wall mounted below Wall mounted at side Attached directly to blind </p>
<p>Power source of device</p>	 <p> Solar Panel Battery Power Outlet </p>
<p>Source of device's motion</p>	 <p> Rotary Motor Linear Motor Pulley System Gear System </p>
<p>Method of responding to light detection with motion</p>	 <p> Circuitry Software/Programming </p>
<p>Arrangement / holding together of all components</p>	 <p> External power everything glued/welded Casing around External motion source No Casing source </p>

3.3 CONCEPT #1 – “SOLINEARCUIT”

Figure 3: Concept Design #1: Solinearcuit

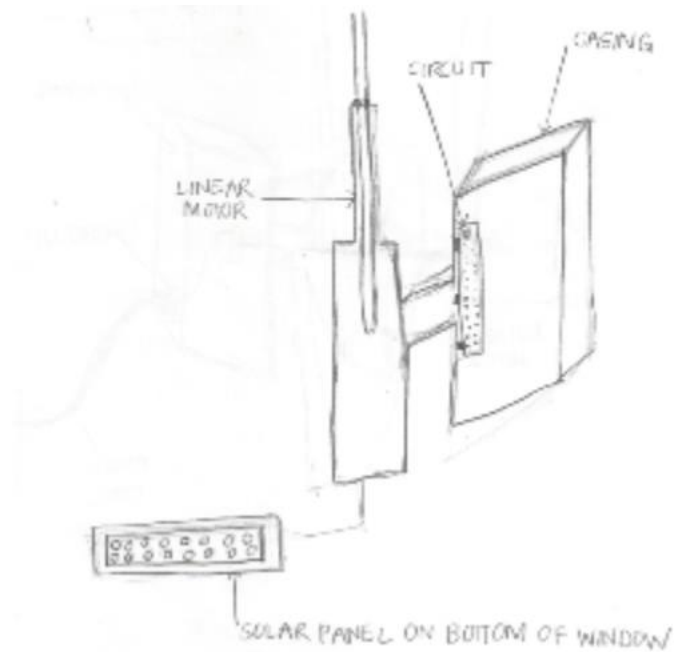

Description: The main source of power for this device is a solar panel that can be attached to the bottom of a window. This panel is connected to the circuit within the device, which activates the motion of the blinds. The linear motor pulls/pushes the blinds when activated by the circuit.

Solutions:

1. Wall mounted below
2. Solar panel
3. Linear Motor
4. Circuitry
5. External motion & power source

3.4 CONCEPT #2 – “POWER PROVIDES ROTATION”

Figure 4: Concept Design #2: Power Provides Rotation

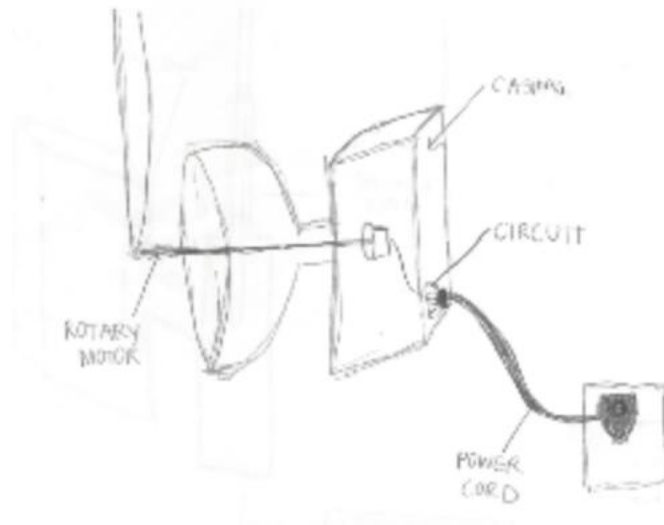

Description: This device is driven by power sourced from an outlet. When plugged in, the power connects to the circuit within the device. The circuit is on the exterior and detects light exposure to trigger the motor on the opposite side. This motor is connected to a tube that rotates with it, and attaches onto the pair of blinds mounted alongside.

Solutions:

1. Wall mounted at side
2. Power outlet
3. Rotary motor
4. Circuitry
5. External power source

3.5 CONCEPT #3 – “LIGHTS, BATTERY, ACTION”

Figure 5: Concept Design #3: Lights, Battery, Action

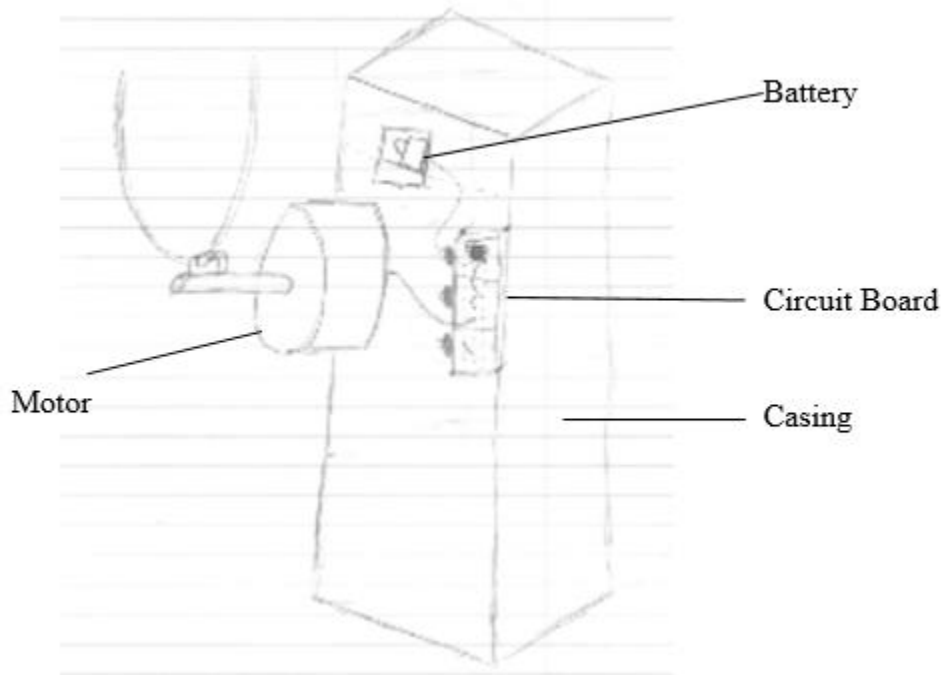

Description: This device is attached to the wall beneath the pair of blinds. It has a circuit internally that converts light detection to rotary motion with the motor. The photo diode is exposed to the outside light through a small window at the top of the device, and the motor is on the outside. The motor has a clip where the string of a blind can be attached and wind the blind up and down when activated.

Solutions:

1. Wall mounted below
2. Battery
3. Rotary motor
4. Circuitry
5. External motor

3.6 CONCEPT #4 – “SPINS WITH THE SUN”

Figure 6: Concept Design #4: Spins with the Sun

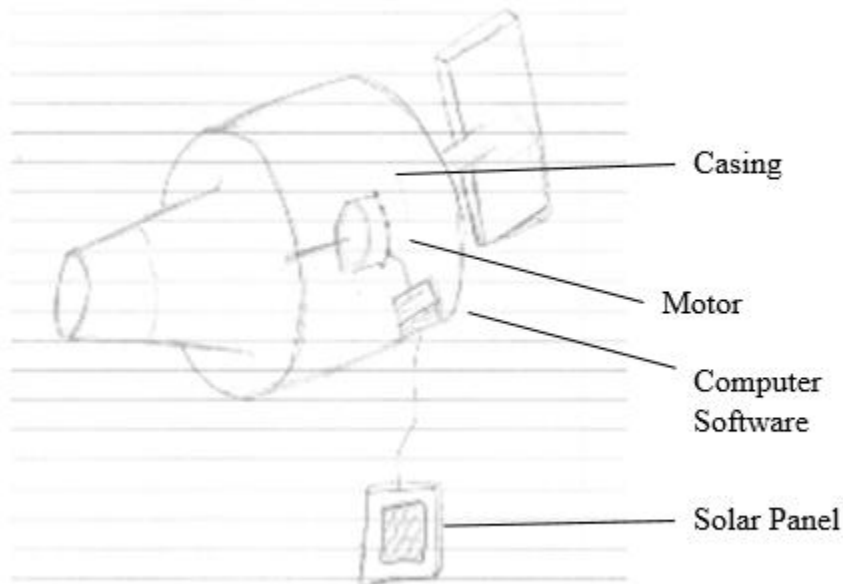

Description: This device is mounted on the wall alongside the blind. It has a cone shaped attachment that allows it to connect to the “tube” of blinds of various sizes. A solar panel hangs beneath it with adhesive that allows it to be attached directly to the window. The device is programmed with software that activates the internal motor connected to the tube when solar power is first received from the panel, and vice versa when light goes away.

Solutions:

1. Wall mounted at side
2. Solar panel
3. Rotary motor
4. Software/programming
5. Casing around everything

3.7 CONCEPT #5 – “DIRECTURNS”

Figure 7: Concept Design #5: Directurns

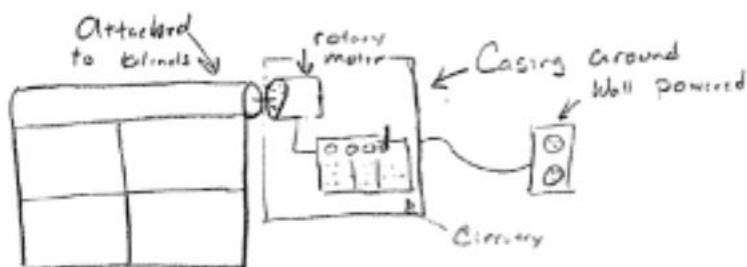

Description: This design attaches directly to the blinds with a rotary motor turning the tube to open and close the blinds. The motor is activated using circuitry to register the sunlight. All components are within a square casing, with an external power source of a power outlet.

Solution:

1. Attached directly to blind
2. Power outlet
3. Rotary motor
4. Circuitry
5. External power source

3.8 CONCEPT #6 – “SOLAR POWERED CODE MONKEY”

Figure 8: Concept Design #6: Solar Powered Code Monkey

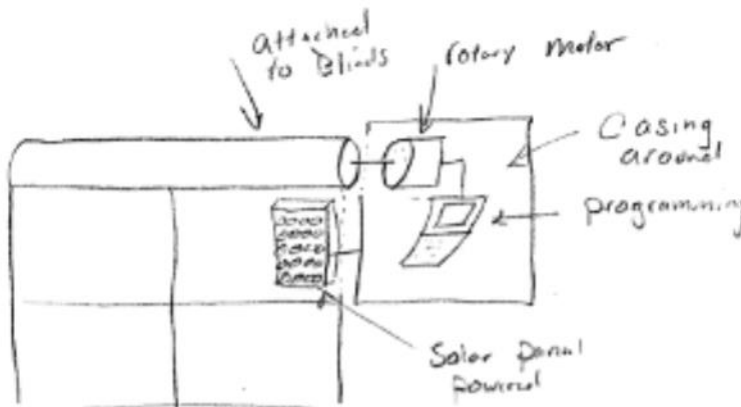

Description: This design attaches directly to the blinds with a rotary motor that connects to the tube of the blind. The motor is activated by a programming component like an Arduino. The components of the unit are enclosed and powered by a solar panel that can attach directly to the window.

Solution:

1. Attached directly to blind
2. Solar powered
3. Rotary motor
4. Software/programming
5. External power source

4 CONCEPT SELECTION

4.1 CONCEPT SCORING MATRIX

Table 2: Analytic Hierarchy

	Mechanical safety	Cost of components	Number of parts	Ease of use	Adaptable	Size	Aesthetically pleasing	Durability	Lifespan	Row Total	Weight Value	Weight (%)
Mechanical safety	1.00	9.00	9.00	9.00	9.00	9.00	9.00	9.00	9.00	73.00	0.36	35.55%
Cost of components	0.11	1.00	3.00	0.33	7.00	0.33	0.14	0.33	3.00	15.25	0.07	7.43%
Number of parts	0.11	0.33	1.00	0.20	3.00	0.33	0.14	0.20	0.20	5.52	0.03	2.69%
Ease of use	0.11	3.00	5.00	1.00	7.00	7.00	9.00	3.00	5.00	40.11	0.20	19.53%
Adaptable	0.11	0.14	0.33	0.14	1.00	0.33	3.00	0.20	1.00	6.26	0.03	3.05%
Size	0.11	3.00	3.00	0.14	3.00	1.00	1.00	0.20	0.33	11.79	0.06	5.74%
Aesthetically pleasing	0.11	0.20	1.00	0.11	0.33	1.00	1.00	0.11	0.14	4.01	0.02	1.95%
Durability	0.11	3.00	5.00	0.33	5.00	5.00	9.00	1.00	3.00	31.44	0.15	15.31%
Lifespan	0.11	0.33	5.00	0.20	1.00	3.00	7.00	0.33	1.00	17.98	0.09	8.75%
Column Total:										205.37	1.00	100%

Table 3: Concept Scoring Matrix

Selection Criterion	Weight (%)	Alternative Design Concepts											
		Solinearcuit		Power Provides Rotation		Lights, Battery, Action		Spins with Rotation		Directurns		Solar Powered Code Monkey	
		Rating	Weighted	Rating	Weighted	Rating	Weighted	Rating	Weighted	Rating	Weighted	Rating	Weighted
Mechanical safety	35.5	5	1.78	5	1.78	5	1.78	5	1.78	4	1.42	4	1.42
Cost of components	7.4	2	0.15	3	0.22	3	0.22	2	0.15	3	0.22	2	0.15
Number of parts	2.7	4	0.11	3	0.08	3	0.08	4	0.11	3	0.08	3	0.08
Ease of use	19.5	3	0.59	4	0.78	4	0.78	3	0.59	2	0.39	2	0.39
Adaptable	3.0	4	0.12	5	0.15	5	0.15	3	0.09	2	0.06	2	0.06
Size	5.7	3	0.17	4	0.23	4	0.23	4	0.23	2	0.11	3	0.17
Aesthetically pleasing	2.0	2	0.04	3	0.06	4	0.08	5	0.10	5	0.10	5	0.10
Durability	15.3	4	0.61	4	0.61	4	0.61	2	0.31	3	0.46	2	0.31
Lifespan	8.8	2	0.18	5	0.44	3	0.26	2	0.18	5	0.44	2	0.18
Total score		3.740		4.353		4.197		3.519		3.286		2.854	
Rank		3		1		2		4		5		6	

4.2 EXPLANATION OF WINNING CONCEPT SCORES

Power Provides Rotation

Power Provides Rotation won by a close margin to concept 3. What made concept 2 stand out more, in comparison, was its life span. Concept 2 has no need to replace batteries or solar panels, and the only reason to replace something would be if it broke. That would be a rare occasion, because concept 2 is also one of the most durable designs we came up with it. Manufacturing concept 2 will not be very costly as the price of part is inexpensive. With its ease of use, durability, mechanical safety and adaptability, concept 2 sets itself above the rest.

4.3 EXPLANATION OF SECOND-PLACE CONCEPT SCORES

Lights, Battery, Action

Lights, Battery, Action powered came in a close second to concept 2. One of the reasons that it fell to concept 2 was its lifespan. In our scoring matrix, Concept 3 had a lifespan score of 3 while concept 2 had a lifespan score of 5. What helped to put this concept in second place was its adaptability, durability, size, and mechanical safety. The design is adaptable and durable due to its casing component, and ability to be moved from point A to point B in one piece. The size also makes it easy to move as well as hang from the wall without falling. Most of these designs are very safe, because they are out of the way of the user. The Its cost of parts, and number of parts, gave it low scores in those aspects respectively; however, the other areas that it excels in outweighs those two factors.

4.4 EXPLANATION OF THIRD-PLACE CONCEPT SCORES

Solinearcuit

Solinearcuit came in third place. Concept 1 excels in adaptability and durability; however, where it as its pitfalls is in lifespan and cost of parts. Even though it has a smaller lifespan and a higher cost of parts in comparison to concept 2 and 3, it scores much better than concept 4, 5, and 6. This has to do with the number of parts that are involved, the size, ease of use, and mechanical safety. Where this product will be hard to accomplish is the solar panel. In general, solar panels are very pricy, which is why this design did not score very high in regards to cost of components. As our budget is limited, we will want our spending on other components to assure we can keep within the given budget.

4.5 SUMMARY OF EVALUATION RESULTS

The most important criterion was safety which is quite important when building any piece of machinery. The user must not be worried about getting injured throughout the process of using the product. Ease of use and durability were also weighted very high. The user must be able to use the product easily or else they will more than likely end up returning it. This idea also goes along with durability. If the product does not hold up, then the user will be angry and more than likely argue for their money back. Taking a look at the design concepts, it appears that the most valuable to least valuable were as follows: the rotary motor wall powered, rotary motor battery powered, linear motor puller, rotary motor with solar panel, direct attachment of rotary motor with power cord and finally, the direct attachment with the solar panel and computerized software.

5 EMBODIMENT & FABRICATION PLAN

5.1 EXPLODED VIEW WITH BILL OF MATERIALS

Figure 9: Exploded View with Bill of Materials

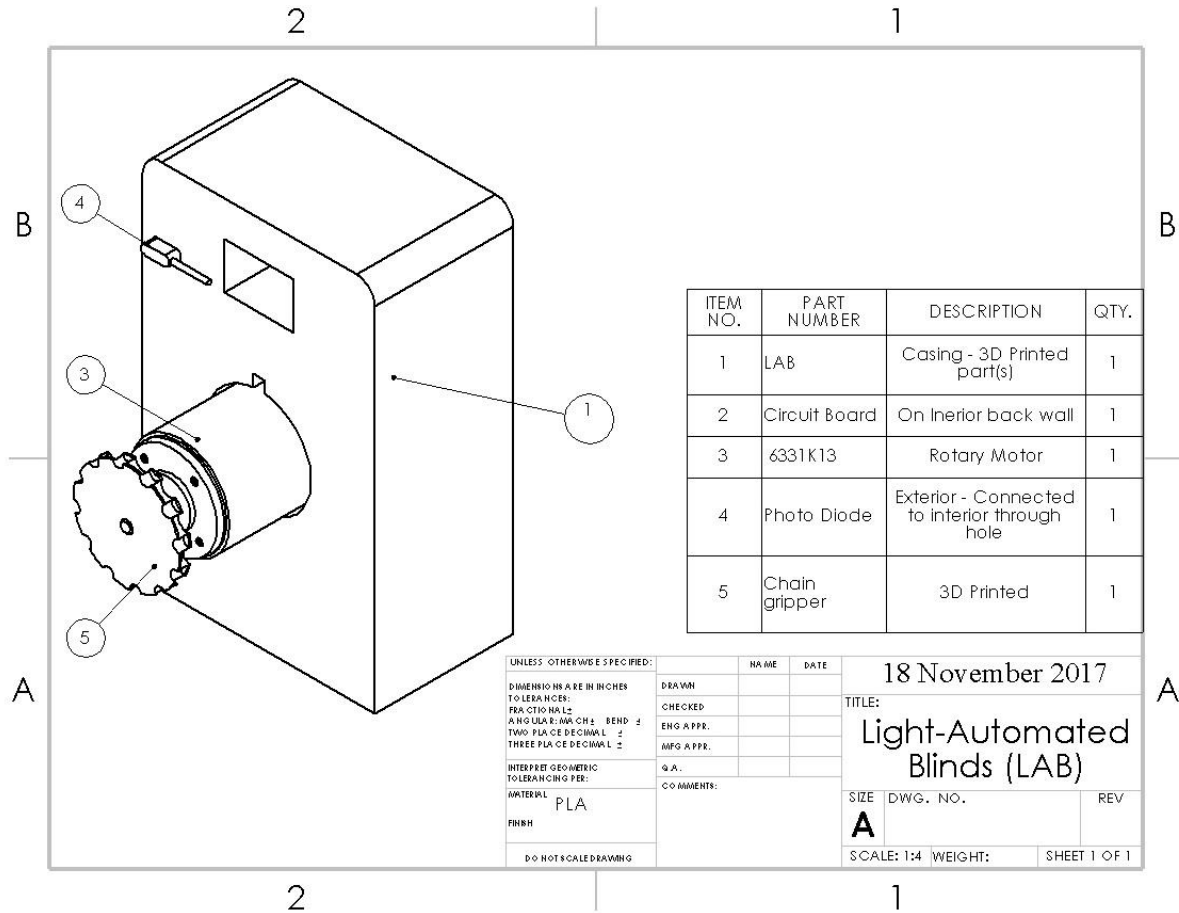

5.2 ISOMETRIC DRAWING WITH ADDITIONAL VIEWS

Figure 10: Isometric Draw

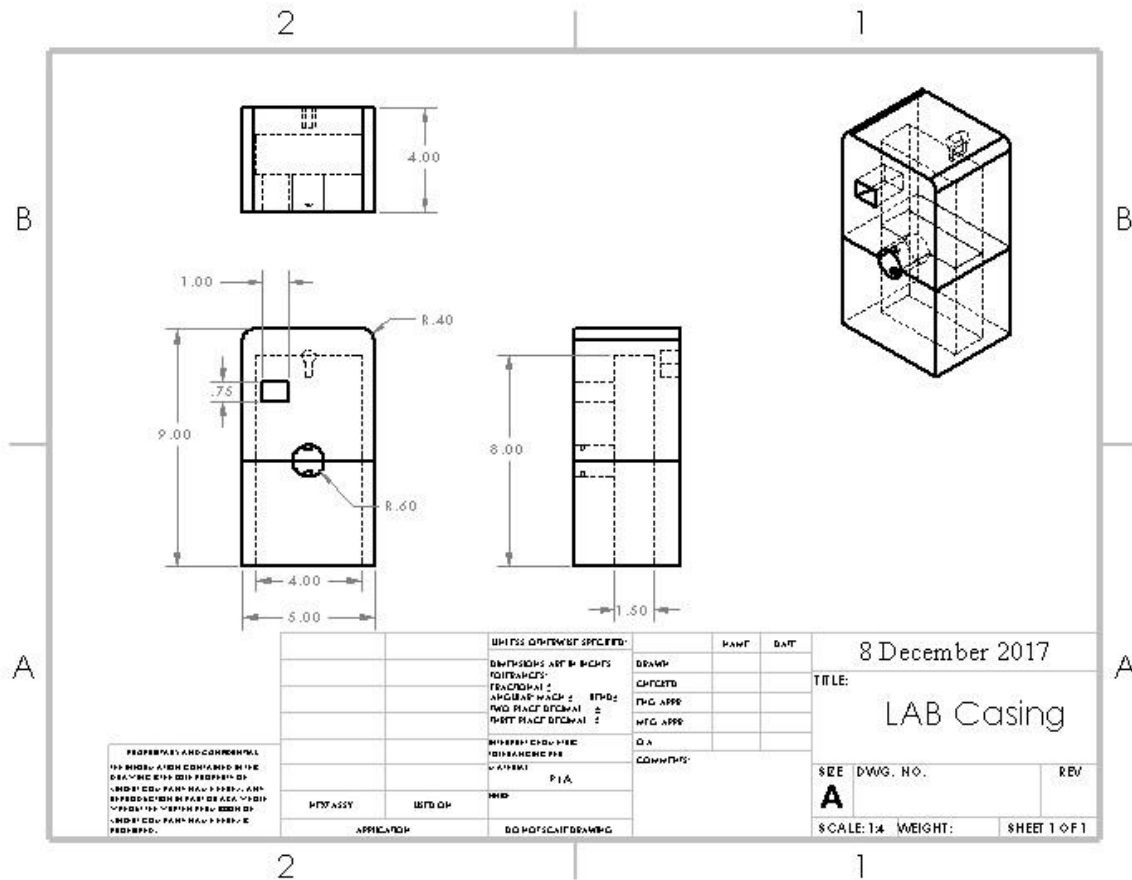

6 ENGINEERING ANALYSIS

6.1 ENGINEERING ANALYSIS RESULTS

6.1.1 Motivation

In terms of engineering analysis, there were no codes and standards that went in to the analysis. The codes and standards feel into the design process making sure that there were no sharp edges. The motivation behind the engineering analysis was to make sure that nothing would break while running the system. We needed to make sure that the torque from the motor wouldn't break the string. We also need to find that torque required to move the blinds, and how much force that would put on the motor. From that force, we need to find if that cause any damage to the motor. Lastly, we need to make sure that the blinds would open in the specified time.

6.1.2 Summary Statement of the Analysis

1. Stress on the string: The stress on the string is important to analyze, because we do not want the string to break in the process of rolling up.

$$\sigma_{string} = \frac{F}{A}$$

$$A = \pi r^2 = 0.093 \text{ in}^2$$

$$F = 20 \text{ lbs}$$

$$\sigma_{string} = 215.19 \text{ lbs}$$

2. The torque required to move the blinds: If the motor is moving too fast or too slow, the product will not work. If we can determine the torque required, we can ensure the blinds will roll up correctly.

$$T = r \times F = 40 \text{ lbs}$$

The radius of the pulley is 2 inches. We tested a 20 pound weight attached to the string and it would move the blinds. So the torque is a simple equation, and it comes back to 40lbs required to move the blinds.

3. The speed to move the blinds: The overall time that the blinds need to roll up within is one of our performance goals so we must calculate this accurately to ensure we are getting the motor to move at the right speed to make our time goal.

$$V = \frac{L}{t} \quad L = 6 \text{ ft} = 72 \text{ in} \quad t = 10 \text{ s}$$

$$V = 7.2 \frac{\text{in}}{\text{s}}$$

$$\omega = \frac{V}{r} \quad r = 2 \text{ in} \quad \omega = 3.6 \text{ rads/s}$$

4. The stress on the motor: The stress on the motor is important, because we need to ensure that we do not break the motor in the process of rolling the blinds. The image below was created using the Inspire Software to do a stress analysis to find the stress on the motor. It was determined that, using the forced found earlier that the max stress experienced on the motor would be 62.08ksi which would not cause the motor to fail. In the figure below that area that is in red is fixed and the other end is allowed to strain and rotate.

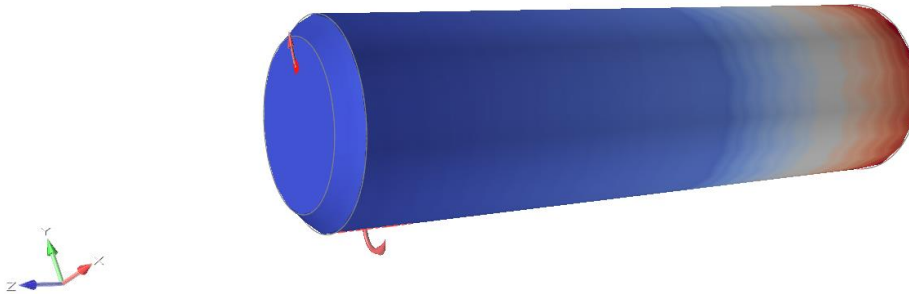
Figure 11: Stresses Present on the Motor

6.1.3 Methodology

1. Stress on the string: This was strictly a pen and paper calculation after calculating the area of the blinds.
2. The torque required to move the blinds: We tested a 20-pound weight attached to the blinds to ensure it could hold that and move that weight. We then could calculate the force over the applied area to determine the torque.
3. The speed to move the blinds: This is also a pen and paper calculation.
4. The stress on the motor: We uploaded a sample motor of the same material and weight into Inspire Software to do a stress analysis to find the stress on the motor

6.1.4 Results

1. Stress on the string: The max yield stress of the string was found to be 2175.56 lbs. So this string will not break, or plastically deform. This was surprising to see, but we would hope a human would have trouble breaking a string that is supposed to be yanked and pulled on a daily basis.
2. The torque required to move the blinds: The torque is a simple equation, and it comes back to 40lbs required to move the blinds. This was surprisingly high, but our blinds are also larger than other blinds. The results are dependent on the type of blinds we purchase.
3. The speed to move the blinds: The speed the pulley needs to move in order for the blinds to open/close in 10 seconds. This was not surprising when thinking about the speed/time it takes blinds to open with human operation.
4. The stress on the motor: The yield strength was researched to be 89.9 ksi. This result was not surprising, because we found that the max stress on the motor would not lead the motor to break. Our motor seems to be extremely sturdy overall. The biggest issue would be that it isn't strong enough to withstand the weight of the blinds.

6.1.5 Significance

These results won't significantly change our prototype, which is really good because there would be a lot more parts to order. The only thing that will be affected will be the pulley. Depending on

how our test preform under these analyses will determine if the pulley would need to be changed. The pulley will contribute to the most torque.

6.2 PRODUCT RISK ASSESSMENT

6.2.1 Risk Identification

Table 4: Risk Prioritization

<u>What is the risk?</u>	<u>Describe Identified Risks</u>	<u>How is the risk managed?</u>	<u>Impact</u>	<u>Likelihood</u>
Device falling off of wall	Deive is not securely mounted and falls onto user from it's mounted height on the wall	Device is lightweight; device uses enough adhesive to mount to the wall and support its weight	Mild	Medium
Over-heating	Motor/circuit/battery generate heat and cause burn from touching device	Engineering analysis performed to ensure that motor will not overheat at operating speeds; casing prevents direct contact with circuit board	Significant	Low-Medium
Pulling blind down	Device operates too quickly or aggressively and yanks the blind from the wall	Battery is not excessively powerful for the motor in use, so likely will not be able to carry far excess of the weight of the blinds	Significant	Low
Damaging blind/string	Device does not properly connect to blind string and damages it.	Same reason as above; also, pulley system is wide enough to attach substantial amount of string, even if it is off-axis	Mild	Low-Medium
Excessive sunlight exposure	Device opens blinds at inopportune times and causes harm to individual who is light-sensitive	Buyer will be aware of the functionality of this device. If they are light-sensitive, this will not be a recommended product to buy.	Significant	Low
Sharp edges	Device has corners that are harmful to touch	Device passes the sharp edge test.	Mild	Low

Risk Heat Map

Figure 12: Risk Assessment Heat Map

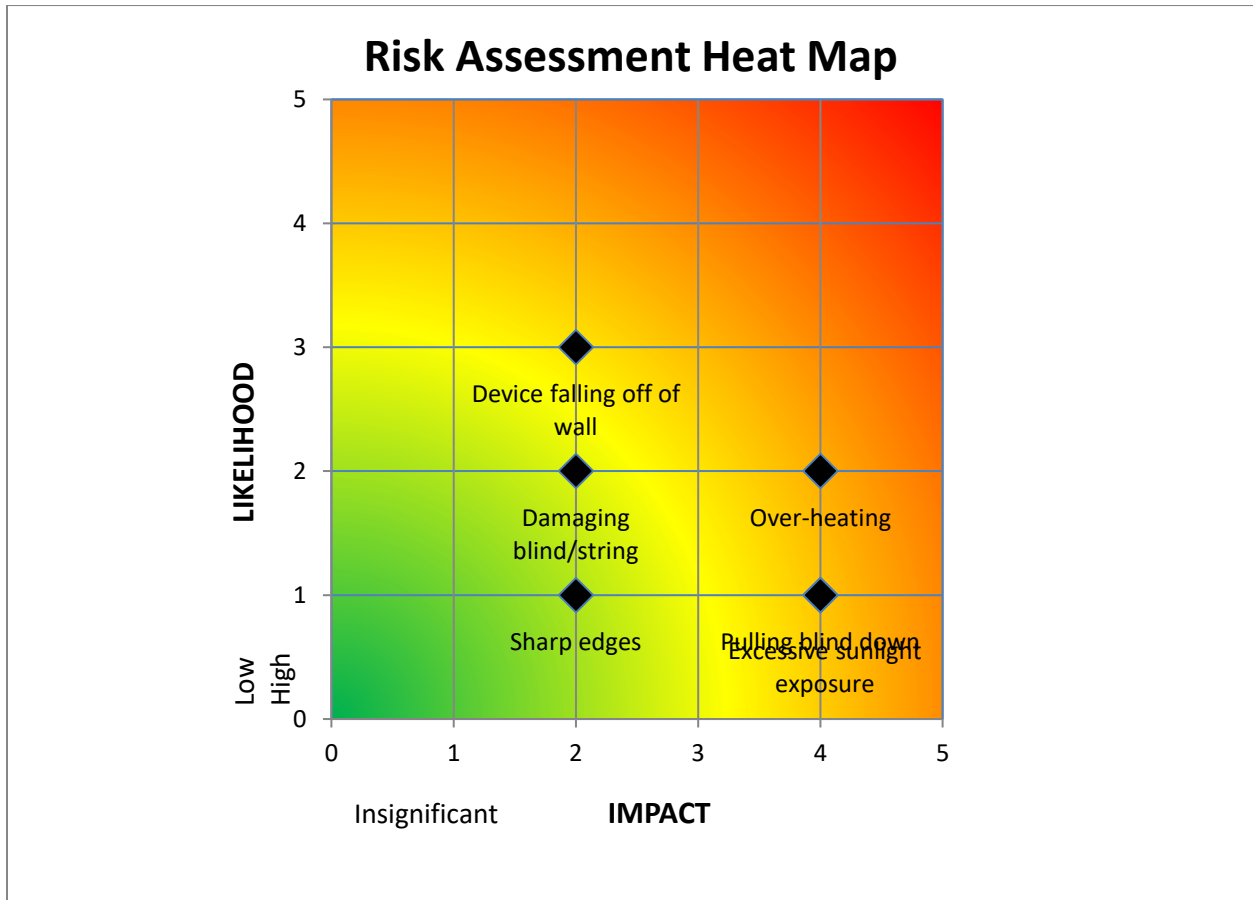

6.2.2 Risk Prioritization

Based upon our heat map, it appears that the main risks we need to be concerned with going forward are our device falling off the wall, over-heating and pulling the blinds down. Going forward we need to make sure our final prototype takes into account these concepts when reanalyzing our circuitry setup to ensure we do not have any issues with the resistors overheating on the board. The device also must not exceed a weight that is too heavy to hang on the wall and ultimately, the blinds need to open and close at a reasonable pace to ensure they do not break in the process.

7 DESIGN DOCUMENTATION

7.1 PERFORMANCE GOALS

1. LAB must move blinds from fully closed to fully open in less than 10 seconds of start.
2. LAB must complete more than 30 open/close cycles without replacing batteries.
3. LAB must weigh less than 3 lb.

4. LAB must complete one closed-open-closed cycle with unmodified test blinds and with 50% load/torque added to strings/cords.
5. LAB must not fail accessible surface temperature test as defined in CPSC child safety standard, after 2 minutes of on/off cycles.

7.2 WORKING PROTOTYPE DEMONSTRATION

7.2.1 Performance Evaluation

We were able to meet the 3 of our performance goals. The first that succeeded very well was the prototype ran 30 cycles without changing the battery. Throughout all the test, the battery never needed to be changed. The second was that the prototype weighed less than 3 pounds. This was easy to meet because we decided to 3-D print the casing to decrease the weight. The third performance goal that we accomplished, was the prototype did not exceed heat requirements. There was never a time that the circuit had overheated or even came close to the temperature. There were two performance goals that we did not achieve. The first that the blinds would roll up then down with 50% more torque. The reason why this wasn't met was because we weren't able to get the blinds to close. We wanted to challenge ourselves by using circuitry instead of a micro controller. We failed to get our logic correct. In an idea situation, our logic would allow for the blinds to close when light wasn't detected. The last performance goal that we didn't complete was that the blinds would close in 10 seconds. This wasn't met because our motor had enough torque to pull the blinds, but the speed wasn't fast enough. We believe that if there was more time to complete the prototype, all of our performance goals would be met.

7.2.2 Working Prototype – Video Link

[Final Demonstration and Evaluation of Project](#)

7.2.3 Working Prototype – Additional Photos

Figure 13: Image of Final Prototype

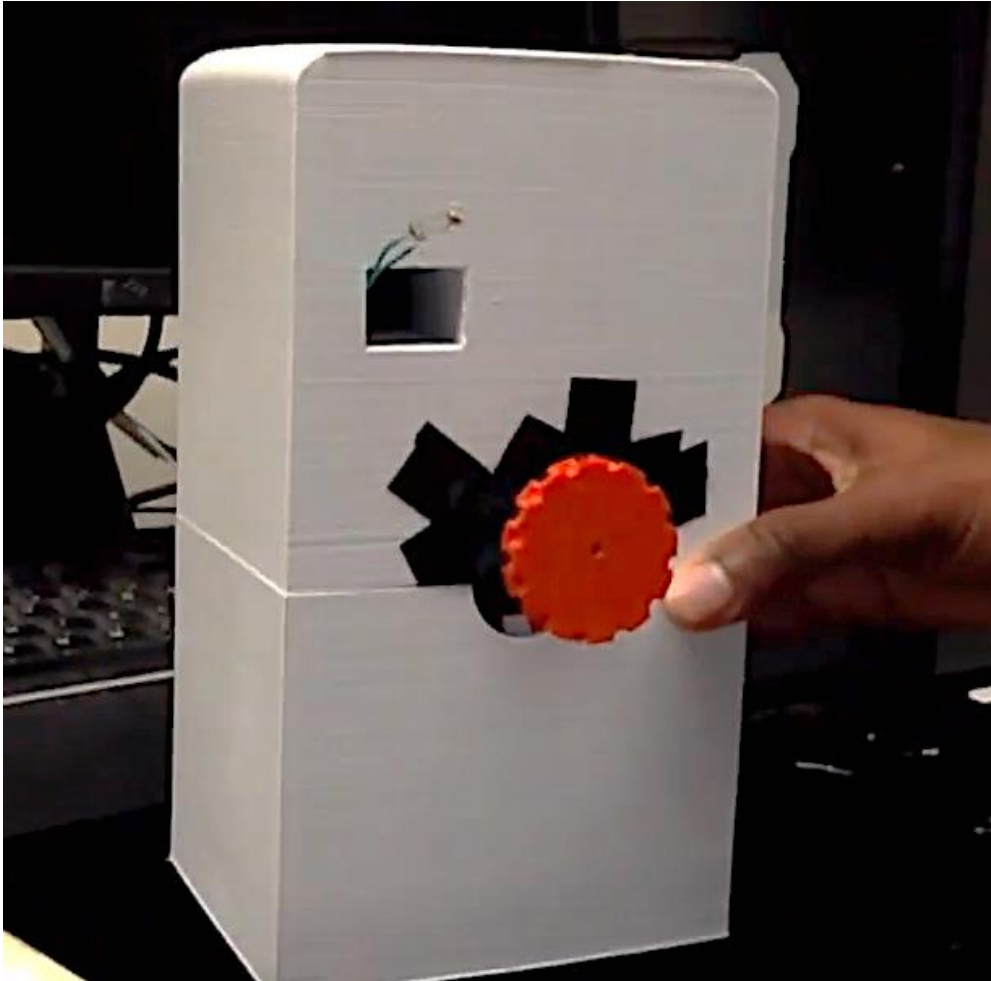

8 DISCUSSION

8.1 DESIGN FOR MANUFACTURING – PART REDESIGN FOR INJECTION MOLDING

8.1.1 Draft Analysis Results

Figure 14: (Before) Draft Analysis Results

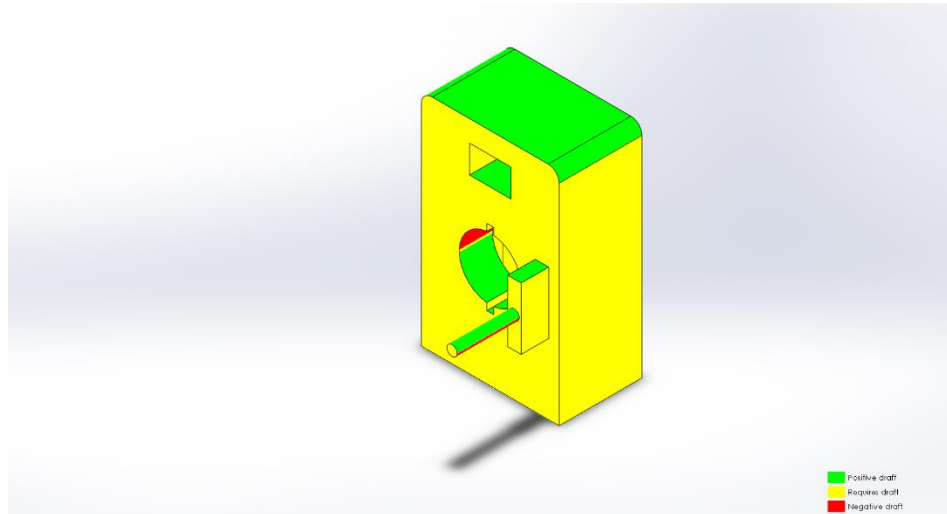
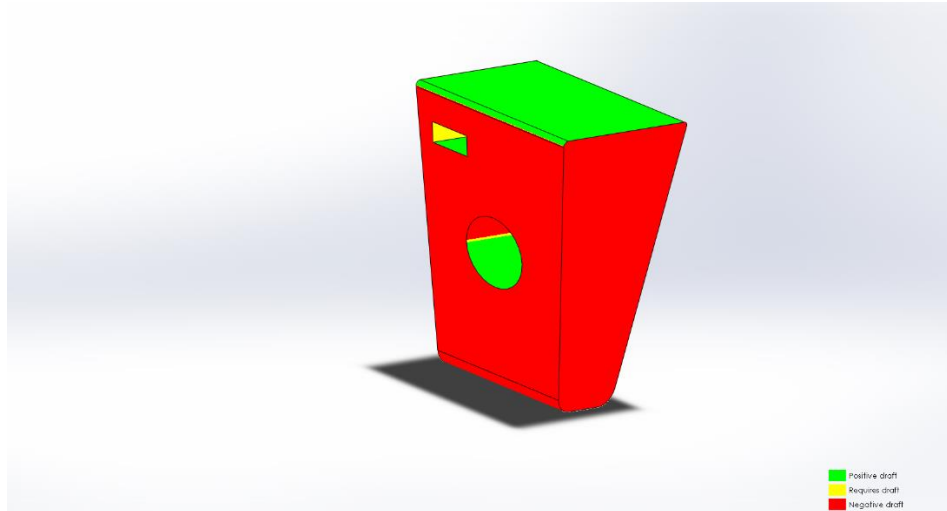

Figure 15: (After) Draft Analysis Results



8.1.2 Explanation of Design Changes

Pictured above are the before and after draft analyses of the casing for our design. Our original design was very square, with sharp edges, and inconsistent wall thicknesses due to the interior holes for the circuit board and the motor. The re-design added a draft angle on all sides and eliminated the extrusion to mount a pulley. This would require us to attach a pulley directly to the motor instead; it would also require our design to have an external circuit instead of an internal attachment to the back wall. There is still a small amount of negative draft remaining in the hole

for the photo diode, but that is very insignificant compared to the changes made to the overall body of the casing, making it far more manufactural.

8.2 DESIGN FOR USABILITY – EFFECT OF IMPAIRMENTS ON USABILITY

8.2.1 Vision

Our project is essentially just an additional attachment to an already existing product. Blinds are present in every household, therefore, our attachment would simply make the blinds self-operating. If a person has a vision impairment, the only real danger they could be in is if they are not aware that the blinds can self-operate, and they hear the noise and attempt to interrupt the motion of the motor and somehow get their hands caught in the device. This is extremely unlikely, however, this could potentially happen.

8.2.2 Hearing

As mentioned above, blinds are already an existing product. Our attachment would essentially make the blinds self-operating. As the product will not make much noise besides the noise that most blinds make along with the very small scale sound of the motor, a person with a hearing impairment would have no safety risks when using this product.

8.2.3 Physical

A person with a physical impairment could actually benefit from the creation and design of this product considering it allows the blinds to open on their own. If a person has any kind of hand, wrist or arm pain, this product would allow them to not have to manually roll the blinds up in the morning allowing for less stress on their weak joints.

8.2.4 Language

The only time language could become an issue is if the installation guide wasn't universal. The product itself, once installed, requires no speech at all. A person who speaks English can use it here in the U.S. or a European native could take this product and install it back in their home overseas. This product is just a way to enhance the current blind system.

8.2 OVERALL EXPERIENCE

8.2.1 Does your final project result align with the initial project description?

Our initial goal was to create a device that would provide sunlight during optimal hours of the day. We had envisioned that when the sun came up, our blinds did as well to ensure that we were letting in natural light to both wake us up in the morning as well as provide a heat source to our rooms during colder months. With that being said, one of our biggest challenges was figuring out the best design and way to complete this. Our final demonstration consisted of a light detection device that, once light was received, sent a message to an internal circuit that then sent a message to drive the motion of an internal motor to drive the blinds open. With that being said, our initial project description was very similar to our final project description.

8.2.2 Was the project more or less difficult than you had expected?

One of the initial goals of our team was to make sure to have a challenge rather than to take the easy route in our designs. This ended up being the most difficult part, because while most groups chose to use a programming software, our group decided to take on the challenge of using

internal circuitry to transfer the signal from the photo diode to drive the motor. This was extremely difficult as we had to ensure our motor had just enough torque to drive the blinds open, and we also had to ensure that the entire circuit was correct and intact when putting the final device together. We also learned a lot of trial and error when it comes to choosing motor wisely. We realized very late in the project that torque is more important than speed in our case, which forced us to work diligently to alter our design as well as obtain a new motor. Overall, this project seemed less difficult at the beginning of the semester, but posed a lot more difficult than we initially thought possible.

8.2.3 In what ways do you wish your final prototype would have performed better?

As a group, we really were a bit disappointed with our final prototype demonstration. When thinking back on the initial design concepts, we realized that for our project in particular, it would have been wise to use a computerized software rather than internal circuitry. This is due to the fact that we would have been able to focus more on ensuring our motor was working properly and in a timely manner. We also wish we would have created our device for a simpler type of blind. The motor we used required a lot of torque to lift the blinds whereas a simple device with a way to twist blinds via a rod maybe have been a bit easier.

8.2.4 Was your group missing any critical information when you evaluated concepts?

One of the things we underestimated in the initial evaluation of concepts was the complexity of trying to create an internal circuit board with multiple inputs. We would have benefitted greatly from a computer program, but due to the initial thought that we wanted to use our engineering courses from the past, we decided to take on the challenge of using an internal circuit board. Another design concept we overlooked was the fact that the blinds we decided to use are very heavy to open so we probably should have looked at a different type of blinds system that did not require a heavy weight to be vertically lifted.

8.2.5 Were there additional engineering analyses that could have helped guide your design?

The only additional engineering analysis we could have potentially spent more time on was a deeper analysis of the particular type of motor we used. We were using a motor that has extremely high speed, but unfortunately very little torque.

8.2.6 How did you identify your most relevant codes and standards and how they influence revision of the design?

Most of our codes and standards that were relevant were in regards to safety. One in particular was that the strings on the blinds could not be considered a choking hazard. This was taken into account when analyzing the speed of rolling the blinds up. This was the only way this influenced our design process.

8.2.7 What ethical considerations (from the Engineering Ethics and Design for Environment seminar) are relevant to your device? How could these considerations be addressed?

The ethical considerations that are most closely related are the ones in terms of utilizing the natural resources we have such as solar energy, for example. We initially talked about making our design with a solar panel to capture the energy from the sun to then convert it to mechanical energy to drive the motion of the motor. The issue with this was the overall cost of a solar panel,

but this consideration was one that would be heavily considered in future projects if cost was not an issue.

8.2.8 On which part(s) of the design process should your group have spent more time? Which parts required less time?

Our group needed to focus a lot more on the initial prototype build. We had the initial plan laid out for a while, and ensured that we were on top of the plan for building. We did not anticipate having to build an additional part or even account for the hours it took for our 3D prints to get completed. We found ourselves rushing to finish when we had planned so meticulously for weeks. Another part we over focused on was coming up with multiple concepts, but we may have rushed when it came to making the final decision of which design to pick as our final concept.

8.2.9 Was there a task on your Gantt chart that was much harder than expected? Were there any that were much easier?

The prototype demonstration/final design build was extremely difficult for our group. We spent a ton of time during the semester planning out what we were going to do rather than actually building. I think we needed a lot more time to get our prototype working effectively, but unfortunately we did not plan for this in our Gantt Chart. We came up with our final idea for building very quickly, because it seemed to be the best/most reliable design while keeping our monetary spending low.

8.2.10 Was there a component of your prototype that was significantly easier or harder to make/assemble than you expected?

The internal circuit board was a complex process and required a ton of research and background, but we surprisingly got this part together extremely quick. Combining our knowledge of circuits, we went through very little trial and error with the initial light detection circuitry setup. The hardest part was trying to make the casing somewhat aesthetically pleasing due to the large size of our internal circuit board. We were, however, able to keep the overall weight of the device under three pounds which was one of our initial performance goals.

8.2.11 If your budget were increased to 10x its original amount, would your approach have changed? If so, in what specific ways?

Absolutely. One of the biggest challenges was trying to work effectively with little room for error as we could not afford to keep ordering parts. We would have definitely taken the approach of using a computerized software to drive the motion of the blinds. We also would have ordered a larger servo motor to make sure that the torque not being great enough was not an issue. With a higher budget, however, there is a lesser emphasis on ensuring we worked wisely and efficiently. Our group stayed well under budget, but we also considered multiple designs to ensure we did not exceed what we were provided with.

8.2.12 If you were able to take the course again with the same project and group, what would you have done differently the second time around?

If we were to redo this course, our group would stick together 100%. We each provided our own unique talents in the entire process of creating and building. We would more than likely choose a new design concept as we had a lot of issues trying to alter our design concept later on in the semester. There was little room for deviation, because after all, there is only one way to open and

close a pair of vertical rolling blinds. If we were to keep this design, the second time around we would start out by considering more than the six required design concepts. We would also try to take more time understanding the start to finish process of each of our design concepts. This was something that would take a lot more time, but could have potentially helped the struggles we came across later on in the semester.

8.2.13 Were your team member's skills complementary?

Each team member had various skills that complemented each other well. We each had knowledge and understanding that filled in the blanks of another teammate. We were able to work efficiently and effectively together to ensure we met deadlines and stayed on top of our work throughout the semester. Kessashun was the organizer and gate keeper of all things related to submissions and receiving things from the professors. Griffin was the mastermind behind ensuring our circuit board was able to work over and over again without having to adjust anything. Madeline was the one organizing meetings and putting everyone's thoughts into words to ensure we submitted the best work possible for each and every assignment. All in all, we worked very well together.

8.2.14 Was any needed skill missing from the group?

In general, our group felt that nothing was missing from a mechanical engineering perspective, but we felt this course would benefit greatly by making it cross functional among all seniors across the engineering school. This may not be feasible, but it would have been helpful having a student with a higher expertise in circuits to make our circuitry more optimal and effective. We also could have chosen a more complex topic given a wider range of skills across multiple disciplines of engineering.

8.2.15 Has the project enhanced your design skills?

This project has most definitely enhanced both our design skills in a means of actual building processes as well as understanding and appreciating the preliminary work behind the entire process. We put in a ton of work to make a prototype that still needed a ton of work after building. We went through a series of trial and error multiple times, and we learned that the process is not easy and each step is crucial in generating the best design possible. Designing and building will definitely be a bit easier when we get the opportunity to have exposure to this process again in our professional careers.

8.2.16 Would you now feel more comfortable accepting a design project assignment at a job?

We feel that going forward, we would feel comfortable taking on a new design project in a potential job. We have gained experience in working in groups in a new way rather than doing research to type a paper or completing a laboratory experiment to write a report. This course has taught us that designing, planning and building has embedded steps that are not easy, but we have gained a newfound knowledge of how to better improve our approach to building in future design projects. This course has given us hands on experience and a taste of what will be expected in industry or research careers that are ahead of us in years to come.

8.2.17 Are there projects you would attempt now that you would not have attempted before?

Our group feels that there are many projects we would attempt now. The beginning of the semester we were all a bit timid and had a great internal fear of failure. What was learned

throughout this semester is that failure is a part of the process. There are very few people if none at all who succeed on the first try. Going forth, we all think that given the opportunity to take on a new project such as a clothes folding machine or an automatic drink dispenser would be exciting to try as we have the skillset to feel less fear and a new sense of excitement.

9 APPENDIX A - PARTS LIST

Table 5: Parts List

	Part	Source Link	Supplier Part Number	Color, TPI, other part IDs	Unit price	Tax (\$0.00 if tax exemption applied)	Shipping	Quantity	Total price
1	Servo Motor	Found in Basement. Comparable to one found on SparkFun	ROB-11885	N/A	\$0.00	\$0.00	\$0.00	1	\$0.00
2	Circuit	McMaster Carr	1388N15		\$20.51	\$0.00	\$0.00	1	\$20.51
3	Casing	3D Printer on Campus	Multiple Printers	PLA Plastic	\$7.41	\$0.00	\$0.00	1	\$7.41
5	Electric Tape	Walmart	3087834365	Black	\$0.57	\$0.46	\$0.00	1	\$1.03
6	9 Volt Battery	Walmart	3980003678	N/A	\$7.47	\$0.46	\$0.00	1	\$7.93
7	Command Strips	Walmart	5114195911	White	\$3.27	\$0.46	\$0.00	1	\$3.73
8	Blinds	Amazon	B074C5WHL7	Tan	\$29.90	\$0.00	\$0.00	1	\$29.90
9	Diode	Amazon	B01M7S2ROI	N/A	\$6.96	\$0.67	\$0.00	1	\$6.96
10	Resistor	Amazon	32101519	N/A	\$6.25	\$0.67	\$0.00	1	\$6.25
12	Transistor	Amazon	CECOMINOD005878	N/A	\$7.00	\$0.67	\$0.00	1	\$7.00
Total:									\$90.73

10 APPENDIX B - CAD MODELS

Figure 16: Solidworks Model of Final Part

