

Washington University in St. Louis
Washington University Open Scholarship

All Theses and Dissertations (ETDs)

January 2010

Inbreeding Depression and Competition in the square-stemmed monkey-flower (*Mimulus ringens*)

Nicholas Griffin

Washington University in St. Louis

Follow this and additional works at: <https://openscholarship.wustl.edu/etd>

Recommended Citation

Griffin, Nicholas, "Inbreeding Depression and Competition in the square-stemmed monkey-flower (*Mimulus ringens*)" (2010). *All Theses and Dissertations (ETDs)*. 137.
<https://openscholarship.wustl.edu/etd/137>

This Dissertation is brought to you for free and open access by Washington University Open Scholarship. It has been accepted for inclusion in All Theses and Dissertations (ETDs) by an authorized administrator of Washington University Open Scholarship. For more information, please contact digital@wumail.wustl.edu.

WASHINGTON UNIVERSITY IN ST. LOUIS

Division of Biology and Biomedical Sciences

Evolution, Ecology and Population Biology

Dissertation Examination Committee:

Alan R. Templeton, co-Chair

Tiffany M. Knight, co-Chair

Jon M. Chase

James M. Cheverud

Kenneth M. Olsen

John L. Orrock

Barbara A. Schaal

INBREEDING DEPRESSION AND COMPETITION IN THE SQUARE-STEMMED

MONKEY-FLOWER (*MIMULUS RINGENS*)

by

Nicholas Wayne Griffin

A dissertation presented to the
Graduate School of Arts and Sciences
of Washington University in
partial fulfillment of the
requirements for the degree
of Doctor of Philosophy.

August 2010

St. Louis, MO

copyright by
Nicholas Wayne Griffin
2010

ABSTRACT OF THE DISSERTATION

Inbreeding depression and competition in the square-stemmed monkeyflower (*Mimulus ringens*)

by

Nicholas W. Griffin

Doctor of Philosophy in Biology and Biomedical Sciences

(Evolution, Ecology and Population Biology)

Washington University in St. Louis, 2010

Professors Alan R. Templeton and Tiffany M. Knight, co-chairs

Matings between biologically related individuals often produce offspring with reduced fitness, a phenomenon known as inbreeding depression. The magnitude of inbreeding depression can play an important role in determining the overall fitness, and persistence, of populations, and is often considered one of the key factors driving the evolution of mating systems and their associated traits. Recent research has shown that the strength of inbreeding depression is often highly sensitive to environmental conditions, such as the availability of abiotic resources or variation in the strengths of ecological interactions between organisms. In plant populations, drought, plant density, herbivory, and infection by pathogens, among other factors, have all been shown to influence inbreeding depression in important fitness-related traits. However, the effects of interspecific competition on inbreeding depression are much less clear, as studies have yielded mixed results, leading some authors to conclude that interspecific competition is

unimportant in models of mating system evolution. *Mimulus ringens* is a perennial plant native to North American wetlands and grows in competition with both an invasive plant, purple loosestrife (*Lythrum salicaria*) and its native congener, winged loosestrife (*L. alatum*). Additionally, it utilizes a mixed mating system and exhibits inbreeding depression in several stages of its lifecycle. Here, common garden experiments reveal that inbreeding depression in several important fitness-related traits varies between different competitive environments. Furthermore, a greenhouse experiment shows that the magnitude of inbreeding depression is altered by the density of *M. ringens* individuals, and this relationship is altered by the presence of purple loosestrife as a competitor. A mating system-explicit model of population growth in *M. ringens* is developed, and shows that variation in competition leads to differences in inbreeding depression in important fitness components, ultimately influencing cumulative estimates of inbreeding depression across the lifecycle. The model demonstrates that competition influences how mating systems affect population growth, the sensitivity of population growth to inbreeding depression in certain fitness components, and the range of outcrossing rates over which natural selection may strongly act on inbreeding depression. Ultimately, we conclude that interspecific competition does alter inbreeding depression and should be considered in future studies of mating system evolution.

Acknowledgments

I sincerely thank all the members of my thesis committee for their continued support throughout this project. Without whom none of this work would have been possible. Likewise, J. Willis and Y-W. Lee provided necessary support for laboratory studies, and J. Karron and R. Mitchell were instrumental in my developing an understanding of *M. ringens*, a study system that they have truly created from the ground up. Much support was provided by the Tyson Research Center and Shaw Nature Reserve, particularly by J. Chase and J. Trager, and the greenhouse staff at Washington University provided selfless assistance and handled even the most uncommon requirements with great zeal. Two undergraduate students, B. Li and M. Caster, worked closely with me in the lab, and their efforts are much appreciated. I owe a huge debt to A. David, an undergraduate researcher who assisted me on many of my studies, while developing his own within the *Mimulus* system. I also owe thanks to a large number of fellow graduate students who provided sound advice, physical labor, moral support and friendship throughout my dissertation work. In particular, M. Johnson, J. Neuwald, A. Conley, E. Frawley, E. Pardini and I. Street were very helpful in the final stages. Finally, this work would not have been possible without funding from a National Science Foundation Doctoral Dissertation Improvement Grant (#0807879) awarded to NWG, ART, and TMK, a scholarship from the Webster Groves Nature Study Society, and the support of Washington University in St. Louis.

Table of Contents

iv.	Acknowledgments
vi.	List of Tables and Figures
1.	Introduction
10.	Chapter 1
32.	Works cited in Chapter 1
43.	Chapter 2
62.	Works cited in Chapter 2
71.	Chapter 3
92.	Works cited in Chapter 3
106.	Chapter 4
119.	Works cited in chapter 4.
125.	Conclusion and Future Directions
129.	Works cited in the introduction and conclusion.

List of Tables and Figures

9. Figure 1 from the Introduction. A conceptual model.
38. Table 1 from Chapter 1.
39. Table 2 from Chapter 1.
40. Figure 1 from Chapter 1.
41. Figure 2 from Chapter 1.
42. Figure 3 from Chapter 1.
66. Table 1 from Chapter 2.
67. Figure 1 from Chapter 2.
68. Figure 2 from Chapter 2.
69. Figure 3 from Chapter 2.
70. Figure 4 from Chapter 2.
97. Table 1 from Chapter 3.
98. Figure 1 from Chapter 3.
99. Figure 2 from Chapter 3.
100. Figure 3 from Chapter 3.
101. Figure 4 from Chapter 3.
102. Appendix A from Chapter 3.
103. Appendix B from Chapter 3.
104. Appendix C from Chapter 3.
105. Appendix D from Chapter 3.
122. Table 1 from Chapter 4.

123. Table 2 from Chapter 4.

124. Figure 1 from Chapter 4.

Introduction

Matings between biological relatives, or inbreeding, results in progeny with a genome-wide increase in individual homozygosity, as both copies of many genes are identical by descent (Templeton 2006). These offspring often exhibit reductions in fitness or beneficial traits, a phenomenon known as inbreeding depression. Inbreeding depression occurs through three primary genetic mechanisms, all of which become expressed in inbred organisms due to increased homozygosity. First, deleterious recessive alleles are expressed in the homozygous state. Second, homozygosity at loci that exhibit heterozygote fitness advantages, or heterosis, contribute to inbreeding depression (*reviewed in* Charlesworth and Charlesworth 1987). Finally, epistatic interactions can lead to inbreeding depression through homozygosity at interacting loci or entire gene complexes (*e.g.*, Templeton and Read 1983). The study of inbreeding depression is one of the oldest aspects of evolutionary biology, with formal experiments dating back to Darwin's time (Darwin 1876), and much research has focused on its genetic bases. Environmental conditions also alter the magnitude of inbreeding depression in a variety of ways, but the full panoply of ecological influences has not been explored, and the population level consequences of this are unclear.

For decades, prevailing wisdom has suggested that increased in environmental stress, which reduces overall fitness, magnify the magnitude of inbreeding depression (*e.g.*, Antonovics 1968, Schemske 1983, Carr and Eubanks 2002). This hypothesis has now been tested in several taxa by estimating inbreeding depression in experimentally manipulated environments, leading many authors to conclude that environmental stress

does increase inbreeding depression (Armbruster and Reed 2005, Cheptou 2006). Both abiotic and biotic stressors have been found to influence inbreeding depression. For instance, the presence of chemical toxins or high temperatures magnifies inbreeding depression for fitness and extinction risk of colonies in *Drosophila melanogaster* (Bijlsma *et al.* 1999, Bijlsma *et al.* 2000), and drought has been shown to increase inbreeding depression for growth rates and fecundity in *Crepis sancta* (Cheptou *et al.* 2000a). Among biotic factors examined, antagonistic interactions such as herbivory (Ivey *et al.* 2004), intraspecific competition (*e.g.*, Wolfe 1993) and infection by pathogens (Carr *et al.* 2003) have all been shown to influence inbreeding depression. Sometimes these effects are quite large, as is the case for *Mimulus guttatus*, which can exhibit twice the level of inbreeding depression for biomass in plants that experience herbivory by spittlebugs, compared to those that do not (Ivey *et al.* 2004). Despite this, a fully consistent pattern has failed to emerge. In a recent meta-analysis, Armbruster and Reed (2005) report that 48% of studies testing for an increase in inbreeding depression with stress detect one, while approximately 25% actually yield the opposite result, in which stresses lead to outbreeding depression, where selfed individuals outperform outcrossed ones.

The ecological interaction that has presented perhaps the most unclear results is interspecific competition, whereby plants growing near each other deprive each other of resources and reduce fitness. For many, if not most, plants, interspecific competition is a very common source of stress, as light, water, nutrients, and space are made limiting factors by the presence of co-occurring plants (*reviewed in* Casper and Jackson 1997).

Yet, studies investigating the effects of variation in competitive environments on inbreeding depression are scarce and have yielded mixed results. A 2007 review by Willi *et al.* cites only six studies that have estimated inbreeding depression in different competitive environments, only two of which utilized experimental crosses in manipulated environments. *Brassica rapa* showed no tendency for increased inbreeding depression when grown with a mix of native wildflowers (Gurevitch *et al.* 1996), but *Crepis sancta* did show an increase in inbreeding depression for flower production in plots where native vegetation was maintained (Cheptou *et al.* 2000b). As a result, some authors have concluded that interspecific competition need not be considered in models of mating-system evolution and dispersal (Willi *et al.* 2007). However, the paucity of studies investigating this relationship, and the mixed results, suggest that more work is necessary to elucidate these effects.

One promising avenue of research is competition between native and invasive species. Invasive species are recent colonizers that have become established and abundant in their invaded habitats, where they negatively impact native species. Because of their novelty in the invaded range, native and invasive species lack a co-evolutionary history, presenting an added opportunity for affecting inbreeding depression. Evidence suggests that different, environmentally-dependent loci, rather than ubiquitously deleterious ones, often contribute to differences in inbreeding depression between environments (Bijlsma *et al.* 1999). This is explained by the tendency of natural selection to eliminate, or purge, the genetic variants responsible for inbreeding depression from populations. In environments where specific loci are not deleterious, purging does

not occur. If invasive species, through creating new magnitudes or mechanisms of competition, cause different loci to cause inbreeding depression, the magnitude of inbreeding depression should increase in their presence.

Additionally, utilizing the novelty of invasive species may allow the exploration of the different hypotheses concerning the basis of the relationship between environmental variation and inbreeding depression. The commonly accepted hypothesis, the stress hypothesis, suggests that inbreeding depression is magnified under stressful conditions, invoking the cooption of new loci or the exacerbation of the effects of ubiquitously acting loci as explanations (Bijlsma *et al.* 1999). Studies report mixed support for this hypothesis. An alternative hypothesis, the variance hypothesis, suggests that the relationship is driven by the effects of the different environments on the variance in the phenotypes under study (Waller *et al.* 2008). In this explanation, the magnitude of inbreeding depression is bounded by Crow's opportunity for selection index, which is the coefficient of variation of the phenotype. If environments increase the variance, inbreeding depression will increase. If the variance decreases, so does inbreeding depression. Support for this hypothesis is also mixed. One dissatisfying aspect of both explanations is that neither can predict the occurrence of outbreeding depression, as the stress hypothesis invokes deleterious recessives or heterotic loci, and the variance hypothesis merely explains the magnitude of the differences between inbred and outbred individuals, but cannot predict the direction of the difference. A recent quantitative genetic model provides a possible solution that invokes stabilizing selection (Ronce *et al.* 2009). Under this model, which assumes that traits are determined by co-dominant

alleles, the dominance with respect to fitness that causes inbreeding depression emerges entirely due to the nonlinear relationship between trait values and fitness. Furthermore, it reveals different relationships between the environment and inbreeding depression, depending on how far the average trait value is from its optimum. When it is close to the optimum, the magnitude of inbreeding depression tracks the variance, and increasing the number of traits under stabilizing selection increases inbreeding depression. Thus, when a population is close to trait optima, or well-adapted to its environment, the model incorporates mechanisms for both the stress and variance hypotheses. However, when the population is far from the optimum, the alleles that reduce fitness become dominant with respect to fitness, and can lead to outbreeding depression when genetic variances are low. This presents the possibility that invasive species could actually lead to outbreeding depression if native plants are poorly adapted to competition with them.

In addition to the inconsistency of relationships between the environment and inbreeding depression, most studies examine traits individually or a composite fitness function, but do not utilize thorough demographic approaches that can make more complex inferences concerning population level consequences. Steets *et al.* (2007) demonstrated the benefits of such an analysis in examining the interaction between herbivory and the mating system in *Impatiens capensis*, whereby herbivory greatly reduced population growth, mainly affecting the performance of selfed individuals from cleistogamous flowers. However, the comparison between cleistogamous and chasmogamous mating used in this study is not precisely the same thing as inbreeding

depression, as selfed and outcrossed individuals necessarily differ in both their maternal environments and genetic makeup.

Here we develop a conceptual model that describes population growth in terms of a population's mating system and degree of inbreeding depression, and describes multiple mechanisms by which interspecific competition may affect population growth. In this model, depicted in Figure 1, population growth is directly described by the average fitness of the individuals making up the population. The population's mating system, defined as the rate of outcrossing, determines the proportion of inbred individuals created within the population, and the magnitude of inbreeding depression determines the degree to which inbred individuals suffer fitness reductions. Competing species may affect population growth by altering any of these. Arrow A depicts the impacts of the invasive on the mating system. Significant evidence suggests that co-flowering plants often compete for pollinator visits, potentially altering outcrossing rates. For instance, *Mimulus ringens* competes with *Lobelia siphilitica* for the service of bumblebee visitors, resulting in reduced outcrossing rates in *M. ringens* (Bell *et al.* 2005). Competitors may also alter the magnitude of inbreeding, through competition for resources (Arrow B). Finally, Arrow C shows influences on population growth due to direct effects on average fitness. In this dissertation, we use experimental approaches combined with demographic modeling to explore the relative importance of each of these pathways in *Mimulus ringens* under different competitive regimes. *Mimulus ringens* is a perennial plant native to wetlands throughout eastern North America, and has been shown to have a mating system sensitive to environmental variation (*e.g.*, Bell *et al.* 2005). Furthermore, it

exhibits inbreeding depression and is found growing in competition with the invasive purple loosestrife (*Lythrum salicaria*), a Eurasian species that has become widespread in North America and has significant negative ecological impacts (Thompson *et al.* 1987). In addition, a native congener of *L. salicaria*, winged loosestrife (*L. alatum*) also grows in competition with *M. ringens*, creating the opportunity to examine our conceptual model utilizing competition with two related plants, one invasive and one native.

In chapter 1, we report the results of a common garden experiment testing the hypothesis that inbreeding depression is increased in *M. ringens* competing with either purple loosestrife or winged loosestrife, and measure the effects of competition on first year *M. ringens* individuals. Chapter 2 complements this study by examining whether variation in intraspecific densities alters inbreeding depression, and whether competition with purple loosestrife alters the relationship between density and inbreeding depression. In chapter 3, we combine the results from chapter 1 with other studies to generate a mating-system explicit model of population growth for *M. ringens* in three different competitive regimes, intraspecific competition, interspecific competition with winged loosestrife, and interspecific competition with purple loosestrife. The behavior of the model is examined over the possible range of outcrossing rates to examine the potential impacts of changing the outcrossing rate in each environment (Arrow A in Figure 1). Retrospective analyses are used to disentangle the relative contributions of direct changes in fitness and changes in inbreeding depression to differences in overall population growth in the three environments (Arrows B and C). One result of the model is that clonal propagation is very important in this species, and in chapter 4 we present

molecular evidence that intraspecific competition among clones is an important driver of genetic variation in *M. ringens* and that this competition follows a pattern of heterozygote advantage, either through inbreeding depression or heterosis.

Figure 1. Conceptual model linking the mating system, inbreeding depression and competition to population growth.

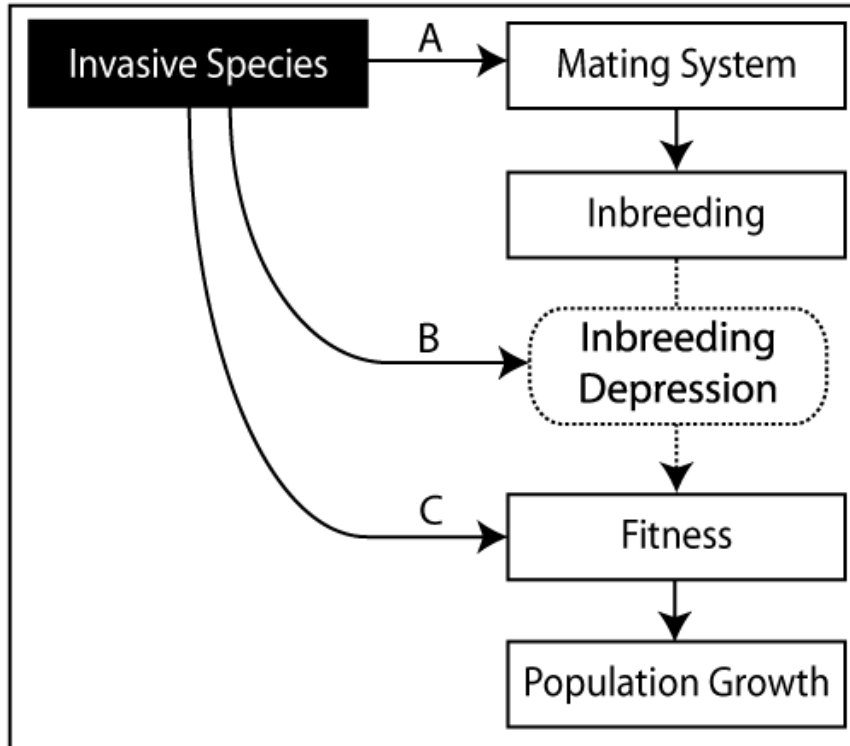

Chapter 1

Invasive loosestrife reduces inbreeding depression in *Mimulus ringens* through
competitive stress

Abstract

Environmental stress often arises from biotic interactions and is thought to increase the magnitude of inbreeding depression. However, empirical studies have yielded mixed results. For many plants, invasive species may be an important source of stress through competition, but it is unclear whether interspecific competition alters inbreeding depression, and whether invasive and native competitors differ in their effects. Here, we report the results of the first study to test whether the magnitude of inbreeding depression is altered by competition with an invasive species. Selfed and outcrossed individuals of the native wetland plant *Mimulus ringens* were grown in three competitive treatments: intraspecific competition and interspecific competition with either the invasive *Lythrum salicaria* or its native congener *L. alatum*. Inbreeding depression did not simply increase with stress; it was least in the presence of *L. salicaria*, the greatest stressor. For biomass and stolon production, inbreeding depression was greatest in the presence of *L. alatum*, the intermediate stressor. These results suggest that variation in interspecific competition may alter inbreeding depression, and that invasive species have the potential to disrupt the selective regimes that maintain mating systems. Furthermore, stress may affect inbreeding depression in a nonlinear fashion, with the greatest inbreeding depression found at intermediate stress levels.

Introduction

Matings between related individuals result in a genome-wide increase in homozygosity within the inbred progeny, which often exhibit reductions in fitness or fitness-related traits, a phenomenon known as inbreeding depression (Templeton 2006). This reduction in fitness is caused by the expression, in the homozygous state, of loci that exhibit overdominance or partial dominance (*reviewed in* Charlesworth and Charlesworth 1987), or by epistatic interactions between loci (*e.g.* Templeton and Read 1983). Environmental conditions also influence the magnitude of inbreeding depression, and the hypothesis that inbreeding depression is greatest in stressful environments has pervaded the literature for decades (*e.g.* Antonovics 1968, Schemske 1983, Carr and Eubanks 2002). This hypothesis has now been explicitly tested in many taxa under a variety of stresses, but few studies have examined the relationship between interspecific competition and the magnitude of inbreeding depression in plants, and none have investigated the effects of invasive competitors. Here, we present the results of the first study to test whether competition with an invasive species leads to greater inbreeding depression in a native plant than competition with another native plant or intraspecific competition.

Although environmental stress has long been thought to increase inbreeding depression, the growing body of research examining the relationship between inbreeding depression and many different sources of stress has failed to yield any general patterns. Here, we define “stressful environments” as those environments that reduce average fitness of the focal organisms relative to other environments, and “environmental stresses” as the specific factors contributing to the stressful environment (*sensu*

Armbruster and Reed 2005). Both abiotic and biotic stresses have been investigated, with mixed results. In a review of 34 studies, Armbruster and Reed (2005) found that only 48% of these studies reported significant increases in inbreeding depression in more stressful environments, while 24% actually detected significant decreases. The relationship between environmental stress and inbreeding depression is highly variable, differing between species, traits, stress types, and even different populations within the same study.

Antagonistic interactions with other species are an important source of stress for most organisms, and can dramatically alter the expression of inbreeding depression in plants. For instance, studies with *Mimulus guttatus* have found that plants grown with spittlebug herbivores exhibit twice the level of inbreeding depression for biomass that those grown without herbivores do (Ivey et al. 2004). Despite this, it is unclear whether variation in interspecific competition can similarly alter the magnitude of inbreeding depression, even though competition between different species for light, water, and nutrients, is a very common source of stress for most plants (*reviewed in* Casper and Jackson 1997). Whereas many studies have examined inbreeding depression under different regimes of intraspecific competition, relatively few have investigated interspecific competition, and most of these reported no effects of different competitors on the magnitude of inbreeding depression. One potential explanation for this lack of an effect is that plants commonly experience competition in most environments. Therefore, natural selection may efficiently eliminate any deleterious genetic variants that cause inbreeding depression in a competition-dependent manner (Willi et al. 2007).

Even if natural selection eliminates such genetic variants, invasive species may alter inbreeding depression through their very novelty. One explanation for the exacerbation of inbreeding depression under stress is that stressful conditions reveal genetic load that is essentially neutral under non-stressed conditions. Evidence suggests that different, environmentally-dependent loci might contribute to differences in inbreeding depression between environments (Bijlsma et al. 1999). Invasive species are recent colonizers that have become established and abundant in their new habitats, where they negatively impact native species. As such, invasive plants lack a coevolutionary history with native plants and may expose their native competitors to novel magnitudes or even new mechanisms of competitive stress, potentially revealing new deleterious variants.

In this study, we test whether the magnitude of inbreeding depression exhibited by the square-stemmed monkeyflower (*Mimulus ringens* L.; Phrymaceae) varies under different competitive regimes. We grew selfed and outcrossed plants under intraspecific competition and interspecific competition with either the invasive wetland plant, purple loosestrife (*Lythrum salicaria* L.; Lythraceae) or its native congener, winged loosestrife (*L. alatum* Pursh; Lythraceae), in order to test the following hypotheses: 1) the degree of competitive stress exerted by the different competitive species follows the ranking *M. ringens* < *L. alatum* < *L. salicaria*, and 2) the magnitude of inbreeding depression varies between competitive treatments.

Materials and Methods

Study System

Square-stemmed monkeyflower, *Mimulus ringens* is a stoloniferous perennial herb native to wetlands throughout central and eastern North America. It reproduces both sexually, through prolific seed production, and clonally, via belowground stolons (Grant 1924). Previous studies have shown that this species exhibits inbreeding depression on the order of a 21% decline in fitness in selfed plants (Bell et al. 2005). Both winged loosestrife, *Lythrum alatum*, and purple loosestrife, *L. salicaria*, are found growing with *M. ringens* in several parts of its range, sometimes growing adjacently to one another (Griffin, *pers. obs.*). Whereas *L. alatum* is native to many of the wetland habitats that it shares with *M. ringens* (Graham 1975), *L. salicaria* is a Eurasian species that has been introduced and become a widespread invasive weed in many parts of North America (Thompson et al. 1987). Both *Lythrum* species have similar growth habits, producing extensive woody roots and showy inflorescences of pinkish-purple flowers, though *L. salicaria* typically grows much larger.

Lythrum salicaria colonized the Northeastern United States during the early 1800s, and has since spread across the continent. It first spread into the Midwest during the late 1800s, most likely via canal traffic to the states surrounding the Great Lakes (Thompson et al. 1987). Thus, *L. salicaria* represents a relatively recent alteration to the competitive environment for *M. ringens* in the United States. Furthermore, *L. salicaria* is rare in Missouri, and does not occur at Shaw Nature Reserve, where the *M. ringens* seeds used in this experiment were collected (Griffin, *pers. obs.*). Therefore, it is likely that the *L. salicaria* used in this study are a novel competitive stress for this population of *M. ringens*, though they do co-occur in other parts of their ranges.

Collection and propagation of plant material

Mimulus ringens individuals for this experiment were generated from hand-crosses performed in the Washington University greenhouse in St. Louis, MO. In October 2006, fruits were collected from several haphazardly selected maternal plants in a large population at Shaw Nature Reserve (Gray Summit, MO). Seeds from each family were placed in Petri dishes to germinate in the greenhouse in November 2006, and one individual from each maternal family was selected to use for breeding. Outcrossed progeny were produced by applying the open anthers of a flower on a randomly selected plant to the open stigma of a recipient flower on another individual. Flowers selected to produce outcrossed seeds were emasculated before the anthers dehisced to prevent selfing. Selfed seeds were generated by crossing two different flowers on the same plant (whenever possible) or by applying the anthers to the stigma of the same flower. Because not all plants flowered and flowering was often asynchronous between plants in the greenhouse, successful pairs of outcrossed and selfed fruits were obtained for 16 of the original 41 seed families planted. Crosses were not reciprocal, and no plant donated pollen to more than one outcrossed fruit. Fruits from these crosses were harvested, dried in envelopes, and stored at 4 °C prior to germination.

Lythrum salicaria individuals were acquired as rootstock from the Illinois Natural History survey at the University of Illinois at Urbana-Champaign, and *L. alatum* rootstock was obtained from Prairie Moon Nursery (Winona, MN). Individuals of both *Lythrum* species used in the experiment were propagated from one-inch stem cuttings. All purple loosestrife cuttings were taken from a single plant, and were thus genetically

identical. *Lythrum salicaria* is tristylous and self-incompatible, and using one genotype should prevent exposing our study site to unwanted escape of *L. salicaria* seed.

Experimental Design

In May 2007, *M. ringens* seeds from the crosses described above were placed in Petri dishes to germinate, and the germinants were sown atop Metro-Mix 360 potting mix (Sun Gro Horticulture, Vancouver, B.C.) in two-inch square pressed peat pots (Jiffy International AS, Kristiansand, Norway). These were flooded with water so that the soil was visibly moist and kept under clear plastic domes for approximately one week. These were then transplanted to individual peat pots and allowed to establish. In June 2007, the seedlings were put into one of three competitive treatments (MR, LA, and LS) and transplanted into plastic pots, which were sunk into the ground in the common garden at Washington University's Tyson Research Center. Each *M. ringens* seedling was paired with a single, randomly chosen, outcrossed *M. ringens* seedling (MR), or a single, rooted stem cutting of *L. alatum* (LA) or *L. salicaria* (LS). Outcrossed *M. ringens* individuals were chosen to create a more uniform competitive treatment, because previous studies have shown that the cross identity of competing plants can influence the outcome of competition (Cheptou et al. 2001). Two seedlings per cross for each of 16 maternal families were planted in this way, resulting in a total of 192 paired plants, each randomly placed in a grid pattern.

Plants were watered daily for the first two weeks and one to two times a week as needed until mid August. To prevent purple loosestrife from dropping seeds at the Tyson Research Center, inflorescences were initially removed prior to maturation of any fruits.

However, this trimming was ceased upon discovering that *L. salicaria* flowers were falling off the stems without producing viable fruits. No purple loosestrife seeds were found during the course of the study. Overall transplant survival was very high, but eight plants either died due to transplant shock or were removed by rodents. These were replaced during the first week of July 2007 and then again in the second week.

Data Collection

The experiment was ended in October 2007, when most *M. ringens* individuals had finished flowering. The *M. ringens* were harvested aboveground, the number of fruits on each plant was recorded, and the aboveground biomass was dried and later weighed.

Half of the pots were harvested in October, and the roots and stolons of each potted pair were separated. The number of stolons produced was recorded for each target plant.

Only stolons longer than one inch were counted. Because it was impossible to separate the roots of plants in the MR treatment completely, stolons were dried and then stripped of their attached roots before being weighed later. The remaining half of the pots were collected a month later in November. Total biomass was calculated for each plant by summing aboveground and belowground biomass. An ANOVA confirmed that the date of belowground harvest affected neither biomass ($F=0.047$, $p=0.828$) nor stolon number ($F=0.082$, $p=0.775$).

Statistical Analyses

Inbreeding depression is a ratio between the mean trait values of individuals with different pedigree inbreeding levels. For the special case of selfed and outcrossed individuals, inbreeding depression is described by the equation,

$$\delta = 1 - w_s / w_o,$$

where w_s and w_o are fitness related traits for selfed and outcrossed individuals, respectively. Because ANOVA tests for absolute differences in response variable means between factor levels, an ANOVA performed on an untransformed response variable is inappropriate for testing for differences in inbreeding depression. Whereas significant main effects of inbreeding level in such a model may indicate inbreeding depression, interaction terms would not necessarily indicate differences in inbreeding depression. However, log-transformation makes differences in the ratio between w_s and w_o additive, thereby allowing ANOVA to test for differences in inbreeding depression between levels of other factors or treatments (Johnston and Schoen 1994).

We performed a mixed model MANOVA to test for effects of the competitive treatments, and whether inbreeding depression was different between competitive treatments, for stolon production and biomass. Both responses were natural-log transformed prior to the analysis. Fruit number was left out of the MANOVA, because log transformation did not normalize this response variable. The model contained three fixed factors [cross type (CROSS), competition treatment (COMP), and their interaction (CROSS*COMP)] and four random factors [maternal line (MAT), and its interactions with the three fixed factors, (MAT*CROSS), (MAT*COMP) and (MAT*CROSS*COMP)]. To perform the mixed model analysis, Wilk's λ and p-values were calculated for the fixed factors by testing over the error associated with the interaction between the factor in question and MAT. Significant effects of the different factors tested different aspects of our hypotheses. COMP indicated that *M. ringens*

differed in performance between competitive treatments, while CROSS tested for an overall signal of inbreeding depression. Their interaction, CROSS*COMP, tested the key hypothesis that inbreeding depression should vary between competitive treatments. MAT was included in the analyses because genetic variation, maternal effects, and prior inbreeding can all affect fitness and responses to inbreeding or environmental stress. Its interactions with other factors indicated whether or not inbreeding depression (MAT*CROSS), responses to competitors (MAT*COMP), or the relationship between competition and inbreeding depression (MAT*CROSS*COMP) varied between maternal lines.

The MANOVA revealed significant effects of COMP (Wilk's $\lambda=0.070$, $p<0.001$), MAT (Wilk's $\lambda=0.504$, $p<0.001$), and CROSS*COMP (Wilk's $\lambda=0.6806$, $p=0.023$). The effect of CROSS was marginally significant (Wilk's $\lambda=0.656$, $p=0.053$). We therefore followed the multivariate analysis with mixed model ANOVAs to investigate effects on stolon production and overall biomass independently. The ANOVAs had the same factors as the MANOVA, and the F-tests for the fixed effects were constructed using the same error structure. In both cases, the models contained significant effects of COMP and the CROSS*COMP interaction, indicating that the competitive treatments influenced the responses themselves and the magnitude of inbreeding depression. To further examine this pattern, we conducted pairwise comparisons of the different competitive treatments and of the different cross types within each competitive treatment, using the same error as the effect tests. The mixed model MANOVA, ANOVAs, and pairwise

comparisons on log-transformed biomass and stolon number were performed in Systat v. 10.2 (SYSTAT Software, Inc. 2002).

Fruit production was analyzed separately because no transformation made it adequately fulfill the assumption of being normally distributed. Approximately half (46.1%) of the plants did not flower and set fruit, yielding a zero-inflated distribution. MANOVA is sensitive to violations of this assumption, so the same hypotheses as before were tested with a permutation approach for fruit number. We constructed 1,000 random permutations of the fruiting data, using the transformation, $\text{LN}(\text{fruit number} + 1)$. For each permutation, we conducted a mixed model ANOVA in the same way as for stolons and biomass. From these, we constructed null distributions of 1,000 permuted F-values for each effect, as well as values for the observed data. We calculated p-values for each effect as the proportion of permuted F-values greater than those from the observed data. Specific comparisons between competitive treatments and cross types within competitive treatments were also performed using the same permutations. For each permuted sample, the means of each group of interest and their differences were calculated. Again, we used the proportion of permuted values greater than those observed as p-values. All analyses on fruit number were performed in R v. 2.6.2 (R Development Core Team 2008). The mixed model ANOVA was conducted using the function, “Anova”, from the CAR-package (Fox 2007), and subsequently reconstructing the F-tests as described above.

The eight plants that were replaced early in the experiment and two others whose pot companion either died or was severely damaged could have influenced the results of these analyses by experiencing slightly different treatments. To ensure that this was not

the case, we attempted to re-perform both ANOVAs and the permutation analysis with these ten observations removed. However, removal of these individuals caused one treatment combination to be absent for one family. We overcame this by eliminating that entire family, in addition to the original ten plants, which resulted in the elimination of 20 plants from the dataset. Because this might significantly affect the balance of the model design, we analyzed all variables with the same permutation test approach as that above for LN (fruits +1). With these plants removed, permutation tests resulted in the following qualitative changes to the results: for LN (biomass), CROSS was only marginally significant ($p=0.056$) and MAT became marginally significant ($p=0.085$); for LN (stolons), the three-way interaction, MAT*CROSS*COMP became significant ($p=0.032$); and for LN (fruits +1), the CROSS*COMP interaction was reduced to marginal significance ($p=0.053$). Because our major effects of interest, particularly COMP and CROSS*COMP were significant or marginally significant even after the very conservative step of eliminating a tenth of our observations, we regard these changes as relatively minor. Therefore, we present and discuss the results of the analyses on the complete dataset below.

We also calculated values of the coefficient of inbreeding depression, δ , for each response variable in each treatment. Because these variables were log transformed, w_s' and w_o' represented the back-transformed mean values of the transformed data for selfed and outcrossed individuals within each environment, respectively. In the case of fruit number, means were back-transformed by raising e to the power of the transformed value and subtracting one.

Results

Competitive Treatments

The factor COMP significantly affected all three response variables (Table 1). As predicted, *M. ringens* individuals experiencing intraspecific competition (MR) produced the most fruits, stolons, and biomass (Figure 1, Table 2). Moreover, those individuals in the LS treatment produced the least of each, though the difference in LN (fruits+1) between the LS and LA treatments was not statistically significant. For both LN (biomass) and LN (stolons), LA individuals were significantly different from and intermediate to the MR and LS individuals. Thus, we conclude that the magnitude of competitive stress exerted by the different species on *M. ringens* followed the pattern, *L. salicaria* > *L. alatum* > *M. ringens*. The benefit of defining environmental stress in terms of plant fitness traits is that stress becomes a hypothesis, rather than an *a priori* assumption, ensuring that inbreeding depression is compared over the proper ranking of treatments as sources of stress.

Inbreeding Depression and Competitive Treatments

A significant CROSS*COMP factor in the mixed model ANOVA of LN (biomass) indicated that inbreeding depression varied between the three competitive treatments (Tables 1 and 2, Figures 2A and 2D). Specific comparisons revealed that inbreeding depression was greatest in *M. ringens* individuals in the LA treatment ($\delta=0.31$, $p=0.007$), and significant in the MR treatment ($\delta=0.29$, $p=0.011$), but not significantly different from zero in the LS treatment ($\delta=-0.06$, $p=0.642$). Inbreeding depression was also greatest in the LA treatment for LN (stolons) ($\delta=0.30$, $p=0.005$), but was not

significant for the MR ($\delta=0.21$, $p=0.06$) and LS treatments ($\delta=-0.24$, $p=0.087$) (Figures 2B and 2E). In the permutation tests of group differences, inbreeding depression was greatest LN (fruits+1) in the MR treatment ($\delta=0.67$, $p<0.001$), intermediate in the LA treatment ($\delta=0.44$, $p=0.048$), and not significant in the LS treatment ($\delta=0.06$, $p=0.401$) (Figures 2C and 2F).

Thus, we conclude that the competitive treatments did influence the magnitude of inbreeding depression in *M. ringens*, though not in the way we expected. We predicted that competition against the invasive *L. salicaria* (LS) would be the most stressful environment, and that inbreeding depression would be greatest in *M. ringens* individuals in this treatment. The LS treatment was indeed the most stressful; however, inbreeding depression was not detectable for any of the three fitness traits in this treatment. Competition against the native *L. alatum* presented an intermediate competitive stress, but yielded the greatest estimates of inbreeding depression for both LN (biomass) and LN (stolons), and was the only treatment in which inbreeding depression was significant for all three traits.

Family Variation

The factor MAT was significant in the mixed-model ANOVA of LN (stolons), due to the presence of some maternal lines that produced more stolons than others. Likewise, a few maternal lines produced many more flowers and fruits than others, as reflected by the significant effect of MAT in the permutation analysis of LN (fruits+1). Though there were no significant interactions with MAT for LN (biomass), a significant effect of the MAT*CROSS interaction indicated that inbreeding depression differed

between families for fruit production (Table 1). The three-way interaction, MAT*CROSS*COMP, was marginally significant in the mixed-model ANOVA of LN (stolons) ($F=1.498$, $p=0.073$) (Table 1) and significant in the permutation tests after the data removals described above ($p=0.032$). Thus, the influence of the environment on inbreeding depression differed between families for this character. We explored this further by estimating each family's level of inbreeding depression, δ_{ij} , in each competitive treatment, using the equation,

$$\delta_{ij}=1-w_{sij}/w_{oij},$$

where w_{sij} and w_{oij} are the mean trait values, for family j , in competitive treatment i , of selfed and outcrossed individuals, respectively. We then determined whether there were any correlations between these family inbreeding depression estimates across competitive treatments. There were no significant correlations, indicating that estimates of inbreeding depression in maternal lines of *M. ringens* did not behave consistently across competitive treatments. Family-wise inbreeding depression in *M. ringens* under intraspecific competition was not predictive of inbreeding depression in either interspecific treatment (Figure 3), nor were estimates under competition with *L. alatum* predictive of family inbreeding depression levels under competition with *L. salicaria*.

Discussion

This study contains four primary results. First, differences in competitive environments influenced the magnitude of inbreeding depression in *M. ringens*. Second, an invasive species dramatically reduced inbreeding depression in *M. ringens*. Third, inbreeding depression varied in a non-linear fashion with the degree of environmental

stress, rather than reflecting a simple increasing or decreasing trend. Finally, genetic variation exists for inbreeding depression in *M. ringens*, and that variation itself can be subject to environmental effects.

Competition and Inbreeding Depression

Interspecific competition can dramatically affect the magnitude of inbreeding depression expressed by plants, and should be an important component of models of mating system evolution in the future. Inbreeding depression varied across the competitive treatments for all three fitness traits we measured. It varied both between intra- and interspecific competition, and between the two interspecific competition treatments. The selective advantage of outcrossed progeny has long been considered the principal force maintaining outcrossing in the face of the transmission bias favoring self-fertilization (*reviewed in* Charlesworth and Charlesworth 1979). Fisher (1941) showed that this transmission bias leads to the fixation of an allele causing selfing, whereas Lloyd (1979) found that inbreeding depression levels of $\delta=0.50$ or greater cause outcrossing to be fixed. Many researchers have since measured inbreeding depression in the context of understanding the evolution of plant mating systems and the complex array of morphological, behavioral, and physiological mechanisms associated with them (*e.g.* Dudash and Fenster 2001, Chang and Rausher 1999, Carr et al. 1997). Mating systems vary extensively across species (Schemske and Lande 1985), populations (*e.g.* Sanders and Hamrick 1980), and even individuals within the same population (*e.g.* Karron et al. 2004). By altering the magnitude of inbreeding depression, variation in the competitive environment experienced by plants may contribute to this variation.

Other ecological interactions involving plants, particularly those with herbivores (*e.g.* Carr and Eubanks 2002) and pathogens (*e.g.* Carr et al. 2003, Stephenson et al. 2004), are known to influence inbreeding depression. Why then, have studies with competing plant species not yielded similar results? One explanation suggests that plants experience competition relatively often, allowing natural selection to eliminate any genetic load that is expressed specifically in the presence of competitors (Willi et al. 2007), whereas more novel sources of stress may reveal deleterious genetic variants that were effectively neutral in non-stressed conditions (Bijlsma et al. 1999). This would lead to the conclusion that competitors are not likely to influence inbreeding depression. Despite this, the lack of a recognized relationship may come merely from the general paucity of studies on the topic and the inconsistency of methods between them. Willi *et al.* (2007) reviewed the literature regarding the effects of competition on inbreeding depression. Of 26 studies concerning plants, only six examined interspecific competition, and only two utilized experimentally generated individuals of different inbreeding levels from a single source population (Cheptou et al. 2000b, Gurevitch et al. 1996). The other four compared cleistogamous and chasmogamous seeds (Berg and Redbo-Torstensson 1999), individuals from populations of different sizes (Kery et al. 2000), or used molecular estimates of population-level heterozygosity as a proxy for average individual inbreeding level (Galeuchet et al. 2005, Pluess and Stocklin 2004). These different types of comparisons address different questions, examine inbreeding depression at different scales, and are unlikely to yield results consistent with each other. Of the two studies that experimentally manipulated inbreeding levels within a single population, one concluded

that inbreeding depression for fruit production was greater with competition than without in *Crepis sancta* (Cheptou et al. 2000b), and the other found no differences between *Brassica rapa* grown with and without a mix of wildflowers (Gurevitch et al. 1996). To fully illuminate the effects of competition on inbreeding depression, more investigations are required, particularly those that manipulate inbreeding levels of individuals within a population and utilize multiple competitive treatments.

Invasive Species and Inbreeding Depression

The second key result of our study is that competition with the invasive species, *L. salicaria*, completely masked the expression of inbreeding depression in *M. ringens*. In fact, selfed individuals actually produced more stolons (marginally significant) than outcrossed individuals in the LS treatment. One potential explanation for this is that competition with *L. salicaria* was an extremely severe stress upon *M. ringens*, dramatically reducing the fitness of both selfed and outcrossed plants. Such extreme environmental effects may overwhelm the effects of inbreeding. This suggests that invasive plants, through interspecific competition, have the capacity to disrupt the selective regimes that maintain mixed mating systems in native plant populations. By reducing the selective advantage of outcrossed individuals or causing selfed plants to be favored, invasive species might cause native plant populations to shift toward more selfing mating systems in invaded habitats. This could change the distribution of genetic diversity within populations, potentially causing them to accumulate pedigree inbreeding more rapidly than in non-invaded habitats.

The accumulation of pedigree inbreeding has important implications for the ecology, evolution, and conservation of populations. In other plant species, inbred individuals are often found to be more susceptible to environmental stresses, such as drought (Cheptou et al. 2000a), herbivore damage (*e.g.* Ivey et al. 2004, Hayes et al. 2004), and viral infection (Carr and Eubanks 2002). Thus, shifts toward inbreeding caused by reductions in inbreeding depression may affect the ability of populations to withstand future environmental stresses. Additionally, previous authors have noted that the environmental dependence of inbreeding depression can complicate the success of conservation and restoration efforts that depend on reintroduction of captive-bred organisms (Pray et al. 1994). It may also be a factor in strategies that involve the removal of unwanted invasive species, as this study suggests that estimates of inbreeding depression before and after such efforts may differ dramatically. Much more work is necessary to determine whether these effects are more general across other taxa and systems, but this highlights an as of yet unrecognized impact of invasive species on their native counterparts.

Environmental Stress and Inbreeding Depression

The results of this study clearly do not support the hypothesis that environmental stress exacerbates inbreeding depression. Rather, the response of inbreeding depression to competitive stress varied among the three traits. Stolon production yielded a non-linear “hump-shaped” relationship, in which intermediate stress levels brought about the greatest magnitudes of inbreeding depression, and biomass exhibited reduced inbreeding

depression in the most stressful environment compared to the other two. Inbreeding depression was least for all three traits in the most stressful treatment (LS).

These non-linear relationships between inbreeding depression and environmental stress lend an interesting perspective to the conclusions of Armbruster and Reed (2005). In their review, 48% of the studies reported an increasing relationship between stress and inbreeding depression, 24% a decreasing one, and the remainder no significant relationship at all. However, most studies only tested for differences across two levels of stress, such as the presence or absence of a particular biotic antagonist or abiotic stress factor, and could not detect such non-linear relationships. If the underlying relationship is actually a hump or exhibits thresholds, studies utilizing only two stress levels may yield increasing, decreasing or no relationships by only capturing one side of the hump or threshold. Such a non-linear relationship with inbreeding depression is consistent with previous studies examining the effects of conspecific plant density on inbreeding depression. For example, previous authors have reported that *Brassica rapa* exhibited greater inbreeding depression when grown at intermediate densities than at lower or higher densities (Gurevitch et al. 1996, Waller et al. 2008).

Though no theoretical treatments explicitly predict a hump-shaped relationship between stress and inbreeding depression, two explanations have been posed. First, although stress may initially exacerbate inbreeding depression, extreme degrees of stress may cause the truncation of the fitness distribution of selfed individuals. Inbreeding increases the phenotypic variance among lineages; therefore, selfed individuals should exhibit greater mortality as stress brings fitness close to zero, causing an overestimation

of the fitness of selfed individuals and non-detectable inbreeding depression (Armbruster and Reed 2005). However, there was no mortality during this experiment, so differences in survivorship did not influence trait distributions. Another explanation invokes Crow's index of the opportunity for selection as bounding the degree of inbreeding depression (Waller et al. 2008). At extreme stress levels, inbreeding depression would decrease as the phenotypic variance of the population as a whole decreases, limiting the opportunity for natural selection. Indeed, in this study, the variances appear to decrease in the presence of purple loosestrife (Figure 2A-C). However, this explanation would not predict outbreeding depression in the stressful environments, which is detectable with marginal significance for some traits. In addition, major shifts in inbreeding depression between environments are not always accompanied by corresponding changes in the variance (Figure 2B), and large changes in the variance do not always lead to large changes in inbreeding depression (Figure 2C).

In many ways, a hump-shaped or threshold relationship between stress and inbreeding depression is the most intuitive and is consistent with previous findings. Many studies report that stress exacerbates inbreeding depression, but extreme stresses must cause it to return to zero, as all individuals die at some point along the stress axis. It also makes intuitive sense that the often minor disadvantages caused by selfing might only greatly affect fitness at intermediate stress levels. In relatively benign conditions, slight physiological or morphological inferiorities may not prove limiting to growth and reproduction, whereas extreme stresses may prove harsh enough to eliminate the advantages of outcrossed individuals. These explanations raise many more questions

than they answer, and a detailed theoretical and empirical examination will be required to fully understand them.

Genetic Variation for Inbreeding Depression

Interpreting the relationship between inbreeding depression and the environment also requires understanding the importance of family variation. The significant effect of MAT*CROSS in the permutation analysis for LN (fruits +1) shows that genetic variation exists for inbreeding depression in fruit number, and the significant MAT*CROSS*COMP factor in the permutation analysis of LN (stolons) suggests that genetic variation for inbreeding depression is dependent on the competitive environment. Just as inbreeding depression is an evolvable character, subject to natural selection, the relationship between inbreeding depression and the environment is as well. Furthermore, the lack of correlations between family-level estimates in different competitive treatments suggests that the genetic variants contributing to inbreeding depression may be different in each environment. These results must be interpreted with caution, due to the low sample replication within families in this study, but they are consistent with previous findings in *Drosophila* (Bijlsma et al. 1999).

Conclusions

We conclude that variation in interspecific competition may be an important influence on variation in the degree of inbreeding depression in plants. Furthermore, invasive species, through competition, may dramatically alter the magnitude of inbreeding depression in plants, thereby disrupting the selective regimes that maintain mating systems. This constitutes an as-of-yet unrecognized impact of invasive species,

which might have negative consequences for native plant populations. Finally, these results suggest that environmental stresses might affect the degree of inbreeding depression in a non-linear fashion, with the selective disadvantage of inbred individuals being greatest at intermediate levels of stress.

Acknowledgements

We would like to thank Missouri Botanical Garden's Shaw Nature Reserve, and particularly J. Trager for assistance locating *M. ringens* and permission to collect fruits on their property. We also thank Washington University's Tyson Research Center for hosting the experiment and logistical support in setup and maintenance, especially T. Mohrman, B. Teller, B. May, J. Mahaljevic, P. Hanley, and J. Lancaster. We thank S. Raghu for providing *L. salicaria* rootstock. Additionally, several people provided insightful comments during the planning or analysis of this research or the writing of this article, including R. Mitchell, J. Karron, D. Waller, K. Moriuchi, J. Jarvis, J. Neuwald, T. Steury, E. Pardini, J. Chase, B. Schaal, J. Orrock, K. Olsen, J. Cheverud, and the entire laboratories of TMK and ART. This work was funded by a National Science Foundation Doctoral Dissertation Improvement Grant (#0807879) awarded to NWG, ART, and TMK.

Works Cited

- Antonovics, J. 1968. Evolution in closely adjacent plant populations V. Evolution of self-fertility. *Heredity* 23:219-238.
- Armbruster, P., and D. H. Reed. 2005. Inbreeding depression in benign and stressful environments. *Heredity* 95:235-242.

- Bell, J. M., J. D. Karron, and R. J. Mitchell. 2005. Interspecific competition for pollination lowers seed production and outcrossing in *Mimulus ringens*. *Ecology* 86:762-771.
- Berg, H., and P. Redbo-Torstensson. 1999. Offspring performance in three cleistogamous *Viola* species. *Plant Ecology* 145:49-58.
- Bijlsma, R., J. Bundgaard, and W. F. Van Putten. 1999. Environmental dependence of inbreeding depression and purging in *Drosophila melanogaster*. *Journal of Evolutionary Biology* 12:1125-1137.
- Carr, D. E., and M. D. Eubanks. 2002. Inbreeding alters resistance to insect herbivory and host plant quality in *Mimulus guttatus* (Scrophulariaceae). *Evolution* 56:22-30.
- Carr, D. E., C. B. Fenster, and M. R. Dudash. 1997. The relationship between mating-system characters and inbreeding depression in *Mimulus guttatus*. *Evolution* 51:363-372.
- Carr, D. E., J. F. Murphy, and M. D. Eubanks. 2003. The susceptibility and response of inbred and outbred *Mimulus guttatus* to infection by Cucumber mosaic virus. *Evolutionary Ecology* 17:85-103.
- Casper, B. B., and R. B. Jackson. 1997. Plant Competition Underground. *Annual Review of Ecology and Systematics* 28:545-570.
- Chang, S. M., and M. D. Rausher. 1999. The role of inbreeding depression in maintaining the mixed mating system of the common morning glory, *Ipomoea purpurea*. *Evolution* 53:1366-1376.

- Charlesworth, D., and B. Charlesworth. 1979. The Evolutionary Genetics of Sexual Systems in Flowering Plants. Proceedings of the Royal Society of London. Series B, Biological Sciences 205:513-530.
- . 1987. Inbreeding Depression and its Evolutionary Consequences. Annual Review of Ecology and Systematics 18:237-268.
- Cheptou, P. O., Lepart, J., and J. Escarré. 2001. Inbreeding depression under intraspecific competition in a highly outcrossing population of *Crepis sancta* (Asteraceae): evidence for frequency-dependent variation. American Journal of Botany 88:1424-1429.
- Cheptou, P. O., A. Berger, A. Blanchard, C. Collin, and J. Escarre. 2000a. The effect of drought stress on inbreeding depression in four populations of the Mediterranean outcrossing plant *Crepis sancta* (Asteraceae). Heredity 85:294-302.
- Cheptou, P. O., E. Imbert, J. Lepart, and J. Escarre. 2000b. Effects of competition on lifetime estimates of inbreeding depression in the outcrossing plant *Crepis sancta* (Asteraceae). Journal of Evolutionary Biology 13:522-531.
- Dudash, M. R., and C. B. Fenster. 2001. The role of breeding system and inbreeding depression in the maintenance of an outcrossing mating strategy in *Silene virginica* (Caryophyllaceae). American Journal of Botany 88:1953-1959.
- Fisher, R. A. 1941. Average excess and average effect of a gene substitution. Annals of Eugenics 11:53-63.
- Fox, J. 2007. car: Companion to Applied Regression, version 1.2-7.

- Galeuchet, D. J., C. Perret, and M. Fischer. 2005. Performance of *Lychnis flos-cuculi* from fragmented populations under experimental biotic interactions. *Ecology* 86:1002-1011.
- Graham, S. A. 1975. Taxonomy of the Lythraceae in the southeastern United States. *Sida* 6:80-103.
- Grant, A. L. 1924. A Monograph of the Genus *Mimulus*. *Annals of the Missouri Botanical Garden* 11:99-388.
- Gurevitch, J., D. R. Taub, T. C. Morton, P. L. Gomez, and I. N. Wang. 1996. Competition and genetic background in a rapid-cycling cultivar of *Brassica rapa* (Brassicaceae). *American Journal of Botany* 83:932-938.
- Hayes, C. N., J. A. Winsor, and A. G. Stephenson. 2004. Inbreeding influences herbivory in *Cucurbita pepo* ssp *texana* (Cucurbitaceae). *Oecologia* 140:601-608.
- Ivey, C. T., Carr, D. E., and M. D. Eubanks. 2004. Effects of inbreeding in *Mimimulus guttatus* on tolerance to herbivory in natural environments. *Ecology* 85:567-574.
- Johnston, M. O., and D. J. Schoen. 1994. On the Measurement of Inbreeding Depression. *Evolution* 48:1735-1741.
- Karron, J. D., R. J. Mitchell, K. G. Holmquist, J. M. Bell, and B. Funk. 2004. The influence of floral display size on selfing rates in *Mimulus ringens*. *Heredity* 92:242-248.
- Kery, M., D. Matthies, and H. H. Spillmann. 2000. Reduced fecundity and offspring performance in small populations of the declining grassland plants *Primula veris* and *Gentiana lutea*. *Journal of Ecology* 88:17-30.

- Lloyd, D. G. 1979. Some Reproductive Factors Affecting the Selection of Self-Fertilization in Plants, Pages 67.
- Pluess, A. R., and J. Stocklin. 2004. Genetic diversity and fitness in *Scabiosa columbaria* in the Swiss Jura in relation to population size. *Conservation Genetics* 5:145-156.
- Pray, L. A., J. M. Schwartz, C. J. Goodnight, and L. Stevens. 1994. Environmental Dependency of Inbreeding Depression: Implications for Conservation Biology. *Conservation Biology* 8:562-568.
- R Development Core Team. 2008. R: A language and environment for statistical computing., version 2.6.2. R Foundation for Statistical Computing, Vienna, Austria.
- Sanders, T. B., and J. L. Hamrick. 1980. Variation in the Breeding System of *Elymus canadensis*. *Evolution* 34:117-122.
- Schemske, D. W. 1983. Breeding System and Habitat Effects on Fitness Components in Three Neotropical *Costus* (Zingiberaceae). *Evolution* 37:523-539.
- Schemske, D. W., and R. Lande. 1985. The Evolution of Self-Fertilization and Inbreeding Depression in Plants. II. Empirical Observations. *Evolution* 39:41-52.
- Stephenson, A. G., B. Leyshon, S. E. Travers, C. N. Hayes, and J. A. Winsor. 2004. Interrelationships among inbreeding, herbivory, and disease on reproduction in a wild gourd. *Ecology* 85:3023-3034.
- Templeton, A. R. 2002. The Speke's gazelle breeding program as an illustration of the importance of multilocus genetic diversity in conservation biology: Response to Kalinowski et al. *Conservation Biology* 16:1151-1155.

- . 2006, Population Genetics and Microevolutionary Theory, John Wiley and Sons, Inc.
- Templeton, A. R., and B. Read. 1983. The elimination of inbreeding depression in a captive herd of Speke's gazelle, Pages 241-262 in C. M. Schonewald-Cox, S. M. Chambers, B. MacBryde, and W. L. Thomas, eds. Genetics and conservation: a reference for managing wild animal and plant populations. Menlo Park, California, Benjamin/Cummings Publishing Company, Inc.
- Thompson, D. G., R. L. Stuckey, and E. B. Thompson. 1987. Spread, impact, and control of purple loosestrife (*Lythrum salicaria*) in North American wetland, Pages 55, Fish and Wildlife Research 2. Jamestown, ND: Northern Prairie Wildlife Research Center, US Fish and Wildlife Service.
- Waller, D. M., J. Dole, and A. J. Bersch. 2008. Effects of stress and phenotypic variation on inbreeding depression in *Brassica rapa*. *Evolution* 62:917-931.
- Willi, Y., S. Dietrich, M. van Kleunen, and M. Fischer. 2007. Inter-specific competitive stress does not affect the magnitude of inbreeding depression. *Evolutionary Ecology Research* 9:959-974.

Table 1. Summary of ANOVAs of LN biomass and LN stolon number and permutation statistics of LN fruit number.

Source	df	LN (biomass)		LN (stolon #)		LN (fruits+1)	
		<i>F</i>	<i>P</i>	<i>F</i>	<i>P</i>	<i>F</i>	<i>P</i> ^a
CROSS	1	7.773	0.014	3.588	0.078	5.777	0.029
COMP	2	164.189	<0.001	120.512	<0.001	32.463	<0.001
MAT	15	1.458	0.137	3.329	<0.001	4.206	<0.001
CROSS*COMP	2	3.584	0.04	6.394	0.005	5.534	0.01
MAT*CROSS	15	1.063	0.401	1.461	0.136	2.703	0.001
MAT*COMP	30	0.791	0.764	1.039	0.429	1.073	0.407
MAT*CROSS*COMP	30	0.941	0.561	1.498	0.073	0.738	0.851
Error	95						

^a *P* values for the permutation tests were estimated as the proportion of permuted *F* values that were more extreme than those for the observed data.

Table 2. Estimates of trait means, confidence intervals, and inbreeding depression.

Trait	Group	Competitive treatment		
		<i>M. ringens</i>	<i>L. alatum</i>	<i>L. salicaria</i>
Fruits (#)	All <i>M. ringens</i>	7.42 (5.10-10.49)	1.31 (0.87-1.88)	1.23 (0.77-1.77)
	Outcrossed	13.75 (8.49-21.21)	2.06 (1.24-3.11)	1.30 (0.70-2.05)
	Selfed	3.82 (2.14-6.59)	0.71 (0.33-1.24)	1.15 (0.56-2.03)
	δ	0.72***	0.66**	0.12
Stolons (#)	All <i>M. ringens</i>	15.23 (13.48-17.22)	7.95 (7.01-9.02)	5.07 (4.56-5.63)
	Outcrossed	17.12 (14.39-20.37)	9.49 (7.91-11.39)	4.55 (3.98-5.20)
	Selfed	13.55 (11.41-16.10)	6.63 (5.66-7.76)	5.64 (4.81-6.62)
	δ	0.21*	0.30*** ^a	-0.24*
Biomass (g)	All <i>M. ringens</i>	18.18 (15.98-20.67)	6.87 (6.05-7.81)	4.29 (3.71-4.95)
	Outcrossed	21.54 (18.01-25.77)	8.24 (6.98-9.72)	4.16 (3.37-5.13)
	Selfed	15.34 (12.89-18.25)	5.70 (4.77-6.83)	4.41 (3.59-5.43)
	δ	0.29*** ^a	0.31*** ^a	-0.06

Note: Estimates were back-transformed from the original transformed data distributions. Fruit number estimates were taken from bootstrap estimates and multiple test corrections were not performed in testing for significant inbreeding depression. Stolon number and biomass estimates were taken from parametric estimates, and Bonferroni adjustments of α were used to determine significance.

^a significant values after multiple test corrections.

* $p < .1$.

** $p < .05$.

*** $p < .001$.

Figure 1. Means and 95% confidence intervals for biomass, stolon number, and fruit number in *M. ringens* in each competitive treatment. Letters above the confidence bars denote significantly different groups, compared against those with the same number of apostrophes.

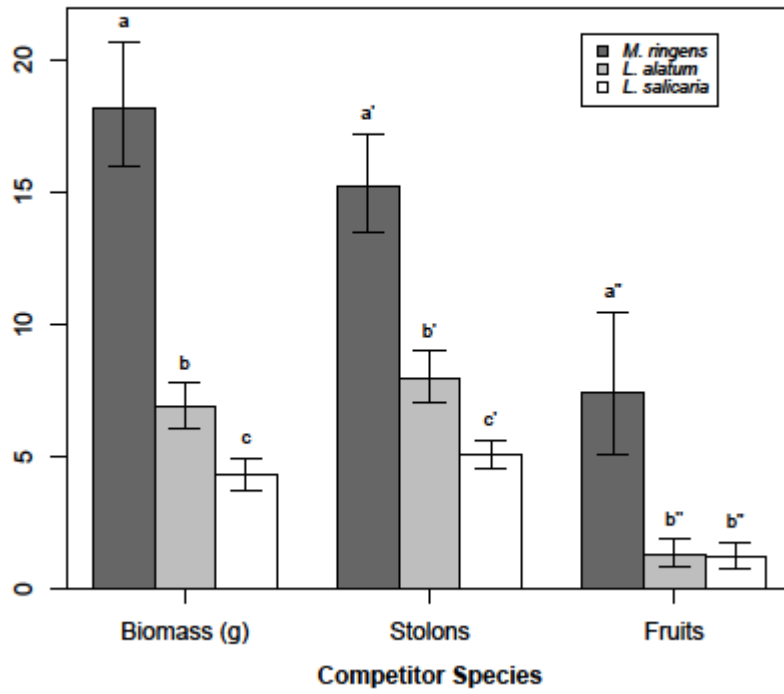

Figure 2. Means and 95% confidence intervals for selfed (open circles, dashed lines) and outcrossed (closed circles, solid lines) individuals in each competitive treatment for A) biomass, B) stolon number, and C) fruit number. Also presented are inbreeding depression estimates for each environment for D) biomass, E) stolon number, and F) fruit number. Asterisks indicate significant differences between selfed and outcrossed individuals or estimates of inbreeding depression.

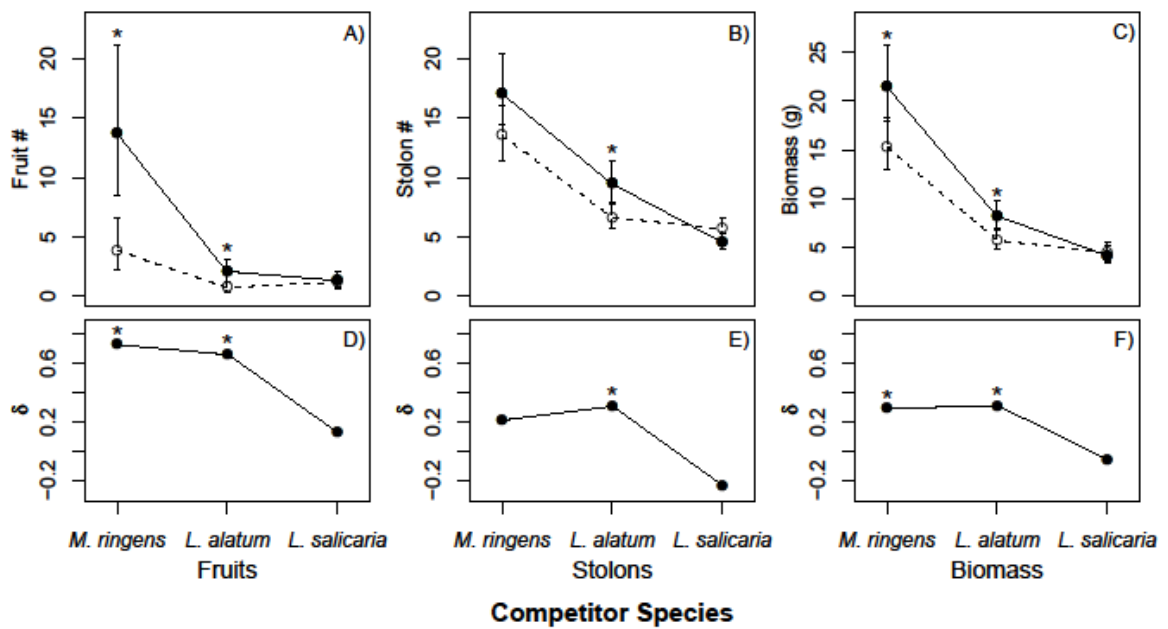
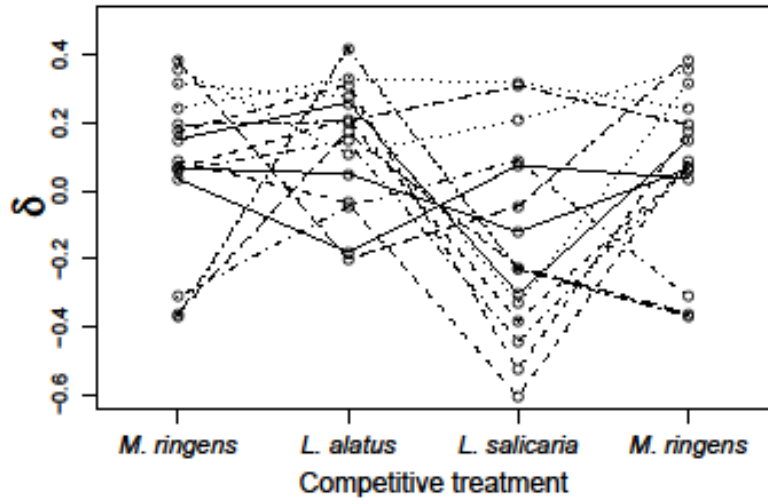

Figure 3. Family estimates of inbreeding depression, δ_{ij} , for stolon number in each competitive treatment. Different line styles represent different maternal families.



Chapter 2

Effects of interspecific and intraspecific competition on inbreeding depression in

Mimulus ringens

Abstract

The magnitude of inbreeding depression often varies between different environments, and several interspecific interactions have been shown to result in this variation.

Intraspecific competition has been shown to influence the degree of inbreeding depression in plants, but the direction of these effects is variable. In some cases, the greatest estimates of inbreeding depression occur at very high densities of individuals, and at intermediate densities in other cases. Whether interspecific competition alters the strength of inbreeding depression is less clear, as fewer studies have explicitly tested this. However, many plants experience both of these competitive interactions simultaneously, creating the possibility for interactions between the two modes. If interspecific competition alters the relationship between inbreeding depression and plant density, these interactions could represent an indirect mechanism by which interspecific competition might affect mating system evolution. Here, we report the results of a greenhouse experiment examining the effects of both interspecific and intraspecific competition on inbreeding depression in the native wetland plant, *Mimulus ringens*. Competition with purple loosestrife (*Lythrum salicaria*) increased survival but decreased biomass and fitness, and the effects of conspecific density varied between competitive treatments. Moreover, increased density tended to decrease inbreeding depression, but this was only significant for fitness in the purple loosestrife treatment, where the trend actually resulted

in significant outbreeding depression. These results suggest that, at some plant densities, interspecific competition could potentially lead to selection in favor of selfing, and that the interaction between interspecific competition and intraspecific competition has a place in the origin and maintenance of mating systems.

Introduction

Inbreeding, defined as the production of offspring by related individuals, leads to a genome-wide increase in homozygosity in the resulting progeny. These offspring often exhibit a reduction in fitness or beneficial traits, known as inbreeding depression, which has broad implications across the fields of evolution, ecology, conservation, and animal and plant breeding (*reviewed in* Charlesworth and Charlesworth 1987). Because of this, a great body of research focuses on quantifying inbreeding depression and uncovering its genetic bases, and a growing amount of recent work shows that environmental conditions can strongly affect its magnitude.

Inbreeding depression is, at its core, a genomic effect, in which inbred individuals suffer fitness losses due to the expression of deleterious recessive alleles, homozygosity at heterotic loci (*reviewed in* Charlesworth and Charlesworth 1987), or “synthetic” recessives resulting from epistatic interactions (*e.g.* Templeton and Read 1983). Fitness, like all phenotypes, is ultimately determined by interactions between both genotypic and environmental effects, creating the opportunity for environmental conditions to affect the magnitude of inbreeding depression by altering the traits important for fitness or the severity of the effects of homozygosity at particular loci. This environmental dependence has most often been studied in the context of the stress hypothesis, which predicts that environmental conditions that reduce fitness also increase inbreeding depression. This hypothesis has now been tested using a variety of taxa and environmental stresses (*e.g.*, herbivory (Ivey *et al.* 2004), drought (Cheptou *et al.* 2000a), competition (Gurevitch *et al.* 1996)), but a clear pattern has failed to emerge, leaving many questions about what

conditions alter inbreeding depression and why. In a recent review, Armbruster and Reed (2005) reported that approximately 50% of such studies show the predicted increase of inbreeding depression in stressful environments, whereas 25% find the reverse, and the remaining 25% fail to detect associations between the environment and inbreeding depression.

This lack of clear generalities underscores a deficiency in our understanding of how inbreeding depression responds to complex environments. To date, most of these studies quantify inbreeding depression at two manipulated levels of a single environmental factor, leaving more complicated multi-factor effects largely unexplored. Higher-order interactions, in which the effects of a particular environmental factor on inbreeding depression are dependent on another environmental factor, may contribute to the lack of support for simple hypotheses like the stress hypothesis. For instance, in *Crepis sancta*, inbreeding depression is higher when inbred and outbred plants compete with each other at high densities, but at low plant densities, inbreeding depression is greater when single cross types are grown together (Cheptou *et al.* 2001).

The combination of inter- and intraspecific competition provides an opportunity to quantify inbreeding depression across multiple combinations of ecologically relevant environmental conditions. Plants often experience competition from both other species and other members of their own species simultaneously, but their effects on inbreeding depression are at odds with each other (*reviewed in* Willi *et al.* 2007). Variation in intraspecific density is known to influence inbreeding depression (*e.g.* Gurevitch *et al.* 1996, Waller *et al.* 2008). By contrast, very few studies have quantified inbreeding

depression using controlled crosses under different regimes of interspecific competition, and they have yielded mixed results. The two such studies known to us report that inbreeding depression is magnified in some traits by competition in *Crepis sancta* (Cheptou *et al.* 2000b), but not in *Brassica rapa* (Gurevitch *et al.* 1996). These inconsistent results have even led some authors to conclude that variation in interspecific competition does not influence inbreeding depression and need not be included in future models of mating system evolution and dispersal (Willi *et al.* 2007).

Further exploration of interspecific competition and inbreeding depression is particularly important in the context of invasive plants, which often adversely affect native plant populations through competition. In a previous study (Griffin *et al.*, *in prep*), we show that the presence of the highly competitive invasive plant, *Lythrum salicaria* (Lythraceae), reduces inbreeding depression for biomass and capsule and stolon production in the native wetland plant, *Mimulus ringens*. This creates the potential for interspecific competition to disrupt the selective regimes responsible for maintaining mixed mating. If these selective regimes are also influenced by the densities of conspecifics, as in other species, interactions between intra- and interspecific competition may have complex effects on inbreeding depression.

Here, we report the results of the first study we know of that explicitly tests whether the presence of an interspecific competitor can alter the relationship between inbreeding depression and variation in the density of conspecifics. By quantifying inbreeding depression in *Mimulus ringens* at three different densities of individual plants, grown with or without *Lythrum salicaria*, we address the following questions: 1) How

does inbreeding depression in *M. ringens* vary across different densities of plants?, and 2) How does the presence of *L. salicaria* alter this relationship?

Materials and Methods

Study System

Mimulus ringens is a perennial wetland herb distributed throughout eastern North America. It can reproduce both clonally, via belowground stolons, or sexually, through prolific seed production (Karron *et al.* 1995). Typically bumblebee pollinated, *M. ringens* employs a mixed mating system, multiple paternity within single capsules, and its flowers can produce fertilized seed without facilitation from visiting pollinators (Mitchell *et al.* 2005). In good years, a large plant in the field may produce hundreds of capsules, approximately 1 cm in length, with seed sets of over 1,000 developed seeds not uncommon in individual capsules. The seeds are very small, and are likely dispersed by water after they fall from the senescing plants. Seeds germinate in the spring, often in dense groups of up to 50 in a 10 cm by 10 cm quadrat (Griffin, *pers. obs.*). Previous work with *M. ringens* shows that it exhibits inbreeding depression both in the field and in the greenhouse, and also that the magnitude of that inbreeding depression is sensitive to its competitive environment.

Lythrum salicaria is a wetland perennial native to Eurasia, now established across much of North America, and can be found growing near *M. ringens* where they co-occur (Thompson *et al.* 1987, Griffin, *pers. obs.*). It has been shown to be a strong competitor, and the presence of *L. salicaria* can reduce inbreeding depression in *M. ringens* individuals compared to those growing with other *Mimulus* or the native plant, *Lythrum*

alatum (Griffin *et al.*, *in prep*). Furthermore, recent evidence suggests that competition for pollination with *L. salicaria* results in reduced pollen deposition and seed set in *M. ringens* (Flanagan *et al.* 2009).

Plant Propagation

All *M. ringens* individuals used in this study are descended from maternal plants from the Missouri Botanical Garden's Shaw Nature Reserve (Eureka, MO) in 2006. We collected full fruits from several haphazardly selected individuals in the largest population at the reserve. We then germinated these seeds in sealed Petri dishes full of water in the Washington University greenhouse. One individual from each of these maternal lines was then selected as a parent plant for the experimental generations. We transplanted the randomly selected parents into individual pots and grew them in the greenhouse. To generate outcrossed and selfed seed families, we hand fertilized flowers by applying the open anthers of one flower to the open and receptive stigma of another. Flowers selected to produce outcrossed families were emasculated the day before opening, to prevent unwanted selfing. Whenever possible, this was also done to flowers set to be selfed. Pollen donors were randomly chosen for each outcross, no plant donated pollen to more than one outcross, and these crosses were never reciprocal. Ripened fruits were collected, allowed to dry, and stored at 4 °C. The *L. salicaria* individuals used in this study were propagated as uniform stem cuttings from individuals derived from rootstock, which was provided by the University of Illinois at Urbana-Champaign.

Experimental Design

To examine the effects of intraspecific density and interspecific competition with *L. salicaria* on inbreeding depression, we grew the selfed and outcrossed seeds described above in pots in the greenhouse using a factorial experimental design in October 2008. We grew plants at three different densities of *M. ringens* seedlings (4, 16, 36), both with and without a single *L. salicaria* individual sharing the pot. Originally, a treatment of 64 individuals was included, but we eliminated this group, because we could not reliably track individuals at that density. To create these conditions, we germinated the *M. ringens* seed families in Petri dishes and then transplanted the young seedlings into square arrays (approximately 16 cm²) in each pot using forceps. Each individual was then marked with a toothpick to keep track of its identity. To synchronize the establishment of both *L. salicaria* stem cuttings and *M. ringens* seedlings, we planted the cuttings in individual cells two weeks prior to setting up the experiment, thereby allowing them to take root. We then transplanted these plants, roots and all, into the pots at the same time as the *M. ringens* individuals. The *M. ringens* arrays contained equal numbers of selfed and outcrossed plants, randomly distributed throughout each array. Whenever possible, we planted equal numbers from each seed family in the 16-plant and 36-plant arrays. For the 4-plant arrays, we randomly distributed maternal families across the pots. Because the lower densities in some treatments provide reduced numbers of plants for data collection, we replicated those treatments differentially, planting 70 pots with four plants, 16 with 16, and 14 with 36, of which half were planted with a single *L. salicaria*. This yielded 100 pots, with 1040 *M. ringens* seedlings, derived from eight maternal plants. These pots were then randomly distributed among six bins kept with standing

water throughout the experiment. To avoid spatial effects in the greenhouse, pots were randomly reorganized periodically, although it became necessary to place all of the *L. salicaria* pots together toward the end of the experiment, as the plants had grown tall enough to shade their neighbors. To avoid losing data to transplant shock, we checked for survival after the first two weeks of the experiment and replaced plants that had died, trying to use individuals from the same seed families as often as possible.

Data Collection

At the end of the experiment, in January 2009, we recorded whether each *M. ringens* individual had survived to the endpoint. In addition, the above-ground biomass of each plant was harvested, dried and weighed.

Data Analysis

Biomass

Preliminary investigation of the biomass data revealed that biomass was distributed non-normally, and that the distribution of the natural-log-transformed biomass of surviving plants was, in fact, bimodal. This bi-modality was largely due to a pronounced difference between plants in the purple loosestrife (**PL**) and *M. ringens* only (**MR**) treatments. A highly significant fixed-effects ANOVA for biomass with competition as a factor ($F=75.67241$, $p<0.0001$) confirmed that this was the case. In addition, survival was highly increased in the **PL** treatment, and analyzing the biomass data all together would introduce great imbalance in the dataset, potentially skewing our results. Thus, we partitioned the biomass data and analyzed them for each competition treatment independently.

Biomass data were natural-log-transformed prior to analysis. Log-transformation makes the proportional changes in a response variable additive, thereby permitting us to test for differences in inbreeding depression, which is measured as one minus a ratio (see equation 1 below), between different levels of the experimental factors (Johnston and Schoen 1994). To examine whether the plants exhibited inbreeding depression for biomass, and whether that inbreeding depression varied between the three density treatments within each competition treatment, we used a mixed-effects linear model. The model included *Mimulus* density (**DENS**), breeding cross (**CROSS**), and their interaction (**DENS:CROSS**) as fixed effects. The model also included nested random effects to account for the spatial effects caused by the pot design and the relatedness among plants derived from the same maternal plant. These random effects were the pot (**POT**), the maternal families within a pot (**POT/MAT**), and the crosses nested within families within pots (**POT/MAT/CROSS**). In this model design, a significant effect of **DENS** indicates that biomass varies between the density treatments, a significant **CROSS** term shows overall differences between selfed and outcrossed plants, and the **DENS:CROSS** factor tests for variation in inbreeding depression across density treatments.

We simplified the model using stepwise removal of fixed-effect terms, and estimated the p-value for each factor using log-likelihood ratio tests (LRTs) against the model with the term of interest removed. To quantify the random effects, we extracted the variance components of the model with the minimum adequate arrangement of fixed effects. The significance of each random effect was tested with LRTs, just as for the fixed effects. This analysis was performed separately for plants in both the **PL** and **MR**

competition treatments. We used randomization tests, with 1000 random permutations, to test for significant differences in biomass between particular treatment values.

We generated 1000 bootstrap samples to estimate 95% confidence intervals of the mean biomass within each treatment level. These same bootstraps were used to generate distributions of the magnitude of inbreeding depression, calculated with the equation,

$$\delta = 1 - \frac{w_s}{w_o},$$

in which the magnitude of inbreeding depression, δ , is the proportional reduction in the back-transformed response variable mean for selfed individuals, w_s , compared to that of outcrossed individuals, w_o . Inbreeding depression was estimated for each density treatment, and was considered significantly different from zero if the randomization test indicated that selfed and outcrossed plants differed in that treatment.

Survival

To test whether survival was affected by the experimental treatments and exhibited inbreeding depression, we analyzed survival with a mixed-effects logistic regression. The model structure was identical to the biomass and fitness models with two exceptions. The first difference was that the data were not split between competitive treatments prior to analysis, so the competition factor (**COMP**) and all its interactions with the other fixed effects were included in the model. This is possible in this analysis, because logistic regression accounts for the binomially distributed survival data, and the **COMP** factor does not introduce imbalance into this design. Second, the inclusion of **POT/MAT/CROSS** was excluded, because it made the model unsolvable, most likely due to the necessary absence of most **MAT/CROSS** groupings in the lowest density treatment.

Thus, we constructed the model with *POT* and *POT/MAT* as the random effects terms. Model simplification and randomization tests were carried out just as in the previously described models. During the model simplification process, **COMP** and **DENS** were retained throughout, because their interaction was significant, and LRTs did not have the necessary degrees of freedom to justify their removal. In analyzing survival this way, significant interactions between **CROSS** and other fixed factors do not necessarily test the hypothesis that inbreeding depression varies between the different levels of those factors, as they would for log-transformed variables. Therefore, whenever a significant interaction was found, we considered inbreeding depression estimates to be different between treatments if their 95% confidence intervals did not overlap.

Individual Fitness Function

To determine whether experimental factors influenced inbreeding depression in a more complete measure of individual plant performance, we calculated a fitness function for each individual, using the equation,

$$fitness = survival (0 \text{ or } 1) \times \ln(biomass + 1),$$

in which each dead individual was assigned a biomass of zero. This measure is quantitatively identical to including the zero values of dead plants and then taking the natural log of biomass plus one. In *M. ringens*, biomass is highly correlated with both sexual reproduction through flowers and clonal reproduction through the production of stolons. Fitness was analyzed with the same model structure and simplification procedure described above for biomass, evaluating each of the models separately within

each competition treatment. All analyses were performed in R v. 2.9.0 (R Development Core Team 2009).

Results

Biomass

As reported above in the justification for partitioning the data, the presence of purple loosestrife in the **PL** treatment greatly reduced biomass (by nearly three orders of magnitude at some planting densities). This effect was clearly visible during harvesting. By partitioning the data in light of this strong effect of competition, we were able to elucidate interesting differences in the responses of biomass to the other factors between the competitive treatments.

The minimum adequate models describing biomass did not differ greatly with respect to which factors were significant between the **PL** and **MR** competition treatments, but the effects were very different. For plants growing with only other *M. ringens*, **DENS** was the only significant fixed effect (see Table 1), due to the strong reduction in biomass among plants in the highest density (36) treatment (see Figure 2A). Among plants in the **MR** treatment, there was no evidence for inbreeding depression in biomass as any density, and none of the random effects explained a significant amount of the variance in the model. In the **PL** treatment, the model included significant effects of **DENS**, **POT**, **POT/MAT**, and a marginally significant **CROSS x DENS** interaction (which was not retained) (see Table 1). However, the effect of **DENS** was opposite in the two competition treatments. Plants in the **PL** treatment responded to the density treatment by attaining greater biomasses in the highest density treatment when competing

against purple loosestrife (see Figure 2B). As in the **MR** treatment, no inbreeding depression for biomass was detectable at any planting density.

Survival

Survival was best described by a minimum adequate model retaining **COMP** ($p < 0.0001$), **DENS**, **CROSS**, and **DENS x CROSS** ($p = 0.0171$) as fixed effects and **POT** as a random effect. Further investigation with permutation tests revealed that selfed and outcrossed (**CROSS**) individuals did not differ in survival across the whole sample, but survival did vary among the different levels of the **DENS** and **COMP** factors. Plants in the **PL** treatment exhibited far greater survival than those in the **MR** treatment (Figure 3A), and the highest density also yielded greater survival than the two lower ones (Figure 3B). Once again, there was a trend toward reduced inbreeding depression with increasing densities, but the overlap of confidence intervals suggests that this was not significant (Figures 3C and D).

Fitness

As was the case for biomass, the presence of purple loosestrife strongly reduced overall fitness, and the two models of fitness revealed several differences between the two competitive treatments. In the **MR** treatment the minimum adequate model included only a random factor of **POT**, which explained 9% of the overall variance in fitness (see Table 1). Thus the inclusion of all individuals competing against only other *M. ringens* resulted in no significant effects of the other experimental treatments, despite the significant effect of **DENS** on biomass, and no detectable levels of inbreeding depression (see Figure 2C). The **PL** group differed from this trend, as significant effects of **DENS**,

DENS x CROSS, *POT*, and *POT/MAT* were all retained in the final model. The significant effect of **DENS** reflected the fact that fitness was highest at the highest density for plants competing against purple loosestrife (see Figure 2D). Additionally, the significant **DENS x CROSS** interaction in the **PL** treatment indicated that inbreeding depression varied between the different density treatments. In fact, for plants competing with purple loosestrife, inbreeding depression was significantly negative at the highest density, indicating that selfed plants actually outperformed outcrossed plants in this group, whereas neither of the lower densities yielded significant estimates (Figure 3D). There was an overall trend for *M. ringens* to exhibit reduced inbreeding depression for fitness with increasing plant density in both competition treatments, though this was not nearly significant in the **MR** group (see Figures 3C).

Discussion

The principle aim of this study was to determine whether interspecific competition with purple loosestrife as a competitor altered the relationship between inbreeding depression and variation in intraspecific density in *M. ringens*. Additionally, our experimental design allowed us to assess whether the responses of survival, biomass, and a fitness function to crowding were different between plants growing with and without loosestrife.

Main effects of interspecific competition

Interspecific competition often results in reductions in fitness and growth rates in plants, and this study is no exception. *Mimulus ringens* seedlings growing with purple loosestrife exhibited severe reductions in both final biomass and overall fitness at the end

of the experiment, with masses three orders of magnitude lower than those growing without loosestrife. This effect was visibly apparent in the greenhouse. Survival rates, however, showed the opposite pattern. The presence of purple loosestrife actually led to significantly increased survival. This probably resulted from the loosestrife plants creating a canopy that protected the much smaller *M. ringens* seedlings from desiccation. Pots containing loosestrife tended to retain more topsoil moisture than those without, which developed visibly dry patches, particularly where plants had died.

Interactions between interspecific and intraspecific competition

Many studies document density-dependence in fitness-related traits in plants, in which increased crowding of individuals reduces key fitness components (*e.g.*, Pardini *et al.* 2009). *Mimulus ringens* individuals in this study clearly followed this pattern for biomass and fitness, but only when loosestrife was absent. In the presence of loosestrife, plants growing at the highest density achieved the greatest biomass and fitness, possibly due to protection from desiccation. Such interactions have been identified before, though they usually result in the reverse pattern, in which high densities exacerbate the effects of competition (*e.g.*, Takahashi and Kimura 2005). The survival rate of establishing seedlings was actually greatest at the highest experimental density of plants. This result may be similar to the increased survival caused by loosestrife, as greater plant densities might also provide some protection from desiccation.

Effects of competition on inbreeding depression

Inbreeding depression in plant populations is known to be both density- and frequency-dependent in the context of intraspecific competition, though the directions of

these relationships vary between studies. In *Crepis sancta*, for instance, the magnitude of inbreeding depression for survival has been reported to be exacerbated by both increasing frequency of outbred individuals and conspecific density (Cheptou et al. 2001). Conversely, Waller *et al.* (2008) reported that inbreeding depression for biomass in *Brassica rapa* was highest at intermediate densities. Whether interspecific competition affects inbreeding depression, however, is much less clearly understood. Only a few studies have tested for effects of interspecific competition on inbreeding depression in plants, and they have yielded results at odds with each other (*e.g.*, Gurevitch *et al.* 1996, Cheptou *et al.* 2000b). These mixed results have led some authors to conclude that variation in interspecific competition is unimportant to inbreeding depression (Willi *et al.* 2007). Despite this, previous work in this system has shown that competition with purple loosestrife reduces inbreeding depression for biomass and clonal reproduction in first-year *M. ringens* individuals (Griffin *et al.*, *in prep.*).

This study suggests that inbreeding depression may actually respond to an interaction between interspecific and intraspecific competition. Competition with purple loosestrife revealed a relationship between inbreeding depression and the strength of intraspecific competition that was not detectable among plants growing only with other conspecifics. This highlights the importance of considering multiple environmental factors when estimating inbreeding depression, and raises questions about the complexity of plant-plant interactions in influencing mating system evolution. It is possible that much of the confusion surrounding the sensitivity of inbreeding depression to interspecific competition is related to masking effects caused by other factors, such as the

densities of plants in experimental treatments. Furthermore, if positive values of inbreeding depression are responsible for maintaining mixed mating systems, plant populations with high densities may exhibit selection for selfing when under severe interspecific competition. Further studies examining this interaction are required to determine whether this is a common result.

The fact that inbreeding depression is sensitive to the interaction between intra- and interspecific competition is consistent with recent additions to our theoretical knowledge. For years, the common understanding has been that stressful environments, defined as those that reduce fitness, exacerbate inbreeding depression. In a thorough review of the literature, Armbruster and Reed (2005) found that this pattern was only detected in 48% of studies, but also noted a trend toward increased estimates of the number of lethal equivalents (a measure of inbreeding depression) in stressful experimental treatments. This explanation is somewhat dissatisfying given the proportion (25%) of studies that significantly detect the opposite pattern. For example, competition with purple loosestrife leads to severe reductions in fitness-related traits in *M. ringens*, but has been shown to lead to reductions, rather than increases, in inbreeding depression in two separate studies (this study, Griffin *et al.*, *in prep*). Waller *et al.* (2008), proposed an alternative to the stress hypothesis, suggesting that the magnitude of inbreeding depression is principally determined by the phenotypic variation of the trait in question. However, large shifts in inbreeding depression are sometimes detected without corresponding changes in phenotypic variation, and the variance hypothesis does not account for environmental conditions leading to outbreeding depression, as was the case

in this study. A recent model combining the two hypotheses may provide some insight (Ronce *et al.* 2009). The model suggests that, if traits contributing to inbreeding depression are under stabilizing selection, the magnitude of inbreeding depression is determined by both the genetic variance and degree of maladaptation of the population to the environment, measured by the distance from the selective phenotypic optimum. In this model, inbreeding depression increases with the variance in populations close to the phenotypic optimum, but maladaptation dramatically reduces inbreeding depression and changes its relationship with the variance. Under severe maladaptation, outbreeding depression is even predicted at some levels of variance. This may present an explanation for the results of this study. Purple loosestrife is an invasive species, with which the source population of *M. ringens* does not have any coevolutionary history. A visual inspection of Figures 3A and 3D reveals that the significant outbreeding depression for fitness in the high density treatment with loosestrife actually accompanies an increase in the variance in fitness. If this model is correct, this study suggests that competition with invasive species may often lead to this result, as native plant populations might be maladapted to their presence.

Conclusion

We conclude that interspecific competition may influence the magnitude of inbreeding depression and, consequently, the evolution of mating systems not only through direct effects of competition, but by altering the ways in which plant populations respond to intrinsic factors like density. Further work is needed to investigate whether this is a general phenomenon. Additionally, though we cannot adequately test the Ronce

et al. (2009) model here, more studies of the effects of multiple environmental factors on inbreeding depression will be useful in evaluating the selective modes that lead to variation between environments.

Acknowledgements

We would like to thank Missouri Botanical Garden's Shaw Nature Reserve, and particularly J. Trager for assistance locating *M. ringens* and permission to collect fruits on their property. We would also like to thank Washington University's greenhouse staff, especially M. Dyer for hosting the experiment and providing logistical support in setup and maintenance. We thank S. Raghu for providing *L. salicaria* rootstock. Additionally, several people provided insightful comments during the planning or analysis of this research or the writing of this article, including E. Pardini, J. Chase, B. Schaal, J. Orrock, K. Olsen, J. Cheverud, and the entire laboratories of TMK and ART. This work was funded by a National Science Foundation Doctoral Dissertation Improvement Grant (#0807879) awarded to NWG, ART, and TMK.

Works Cited

- Armbruster, P., and D. H. Reed. 2005. Inbreeding depression in benign and stressful environments. *Heredity* 95:235-242.
- Charlesworth, D., and B. Charlesworth. 1987. Inbreeding Depression and its Evolutionary Consequences. *Annual Review of Ecology and Systematics* 18:237-268.

- Cheptou, P. O., A. Berger, A. Blanchard, C. Collin, and J. Escarre. 2000a. The effect of drought stress on inbreeding depression in four populations of the Mediterranean outcrossing plant *Crepis sancta* (Asteraceae). *Heredity* 85:294-302.
- Cheptou, P. O., E. Imbert, J. Lepart, and J. Escarre. 2000b. Effects of competition on lifetime estimates of inbreeding depression in the outcrossing plant *Crepis sancta* (Asteraceae). *Journal of Evolutionary Biology* 13:522-531.
- Cheptou, P. O., Lepart, J., and J. Escarré. 2001. Inbreeding depression under intraspecific competition in a highly outcrossing population of *Crepis sancta* (Asteraceae): evidence for frequency-dependent variation. *American Journal of Botany* 88:1424-1429.
- Flanagan, R. J., R. J. Mitchell, D. Knutowski, and J. D. Karron. 2009. Interspecific pollinator movements reduce pollen deposition and seed production in *Mimulus ringens* (Phrymaceae). *American Journal of Botany* 96: 809–815.
- Gurevitch, J., D. R. Taub, T. C. Morton, P. L. Gomez, and I. N. Wang. 1996. Competition and genetic background in a rapid-cycling cultivar of *Brassica rapa* (Brassicaceae). *American Journal of Botany* 83:932-938.
- Ivey, C. T., Carr, D. E., and M. D. Eubanks. 2004. Effects of inbreeding in *Mimimulus guttatus* on tolerance to herbivory in natural environments. *Ecology* 85:567-574.
- Johnston, M. O., and D. J. Schoen. 1994. On the Measurement of Inbreeding Depression. *Evolution* 48:1735-1741.
- Karron, J. D., R. Tucker, N. N. Thumser and J. A. Reinartz. 1995. Comparison of

- pollinator flight movements and gene dispersal patterns in *Mimulus ringens*.
Heredity **75**: 612-617
- Mitchell, R. J., J. D. KARRON, K. G. Holmquist, and J. M. Bell. 2005. Patterns of multiple paternity in fruits of *Mimulus ringens* (Phrymaceae). *American Journal of Botany* **92**: 885-890.
- Pardini, E. A., Drake, J. M., Chase, J. M., and T. M. Knight. 2009. Complex population dynamics and control of the invasive biennial *Alliaria petiolata* (garlic mustard). *Ecological Applications* **19**:387-97.
- R Development Core Team. 2009. R: A language and environment for statistical computing., version 2.9.0. R Foundation for Statistical Computing, Vienna, Austria.
- Ronce, O., Shaw, F. H., Rousset, F., and R. G. Shaw. 2010. Is inbreeding depression lower in maladapted populations? a quantitative genetics model. *Evolution* **63**:1807-1819.
- Takahashi, K. H., and M. T. Kimura. 2005. Intraspecific and interspecific larval interaction in *Drosophila* assessed by integrated fitness measure. *Oikos* **111**:574-581.
- Templeton, A. R., and B. Read. 1983. The elimination of inbreeding depression in a captive herd of Speke's gazelle, Pages 241-262 in C. M. Schonewald-Cox, S. M. Chambers, B. MacBryde, and W. L. Thomas, eds. *Genetics and conservation: a reference for managing wild animal and plant populations*. Menlo Park, California, Benjamin/Cummings Publishing Company, Inc.

- Thompson, D. G., R. L. Stuckey, and E. B. Thompson. 1987. Spread, impact, and control of purple loosestrife (*Lythrum salicaria*) in North American wetland, Pages 55, Fish and Wildlife Research 2. Jamestown, ND: Northern Prairie Wildlife Research Center, US Fish and Wildlife Service.
- Waller, D. M., J. Dole, and A. J. Bersch. 2008. Effects of stress and phenotypic variation on inbreeding depression in *Brassica rapa*. *Evolution* 62:917-931.
- Willi, Y., S. Dietrich, M. van Kleunen, and M. Fischer. 2007. Inter-specific competitive stress does not affect the magnitude of inbreeding depression. *Evolutionary Ecology Research* 9:959-974.

Table 1. Summary of effects from the four mixed model analyses of biomass. F-values are presented for fixed effects, whereas random effects, denoted by italics, are represented by the percentage of the variance explained. Significant effects are in bold.

Source	Biomass		Fitness	
	<i>Mimulus</i>	Purple Loosestrife	<i>Mimulus</i>	Purple Loosestrife
Cross	2.254	1.278	0.334	2.40230
Density	11.334****	28.252****	0.222	32.737****
Cross x Density	1.411	2.682†	1.341	3.419*
<i>Pot</i>	<0.1%	4.2%**	9.0%****	4.4%****
<i>pot/mat</i>	4.7%	5.1%*	1.5%	6.0%***
<i>pot/mat/cross</i>	<0.1%	10.8%	<0.1%	9.7%
Residual	95.3%	79.9%	89.5%	80.0%

**** p<0.0001, *** p<0.001, ** p<0.01, * p<0.05, † p<0.1

Figure 1. Experimental design. Each square represents a single pot, and open and closed circles depict selfed and outcrossed *M. ringens* individuals, respectively. The flower symbol indicates the presence of a single purple loosestrife plant in the pot.

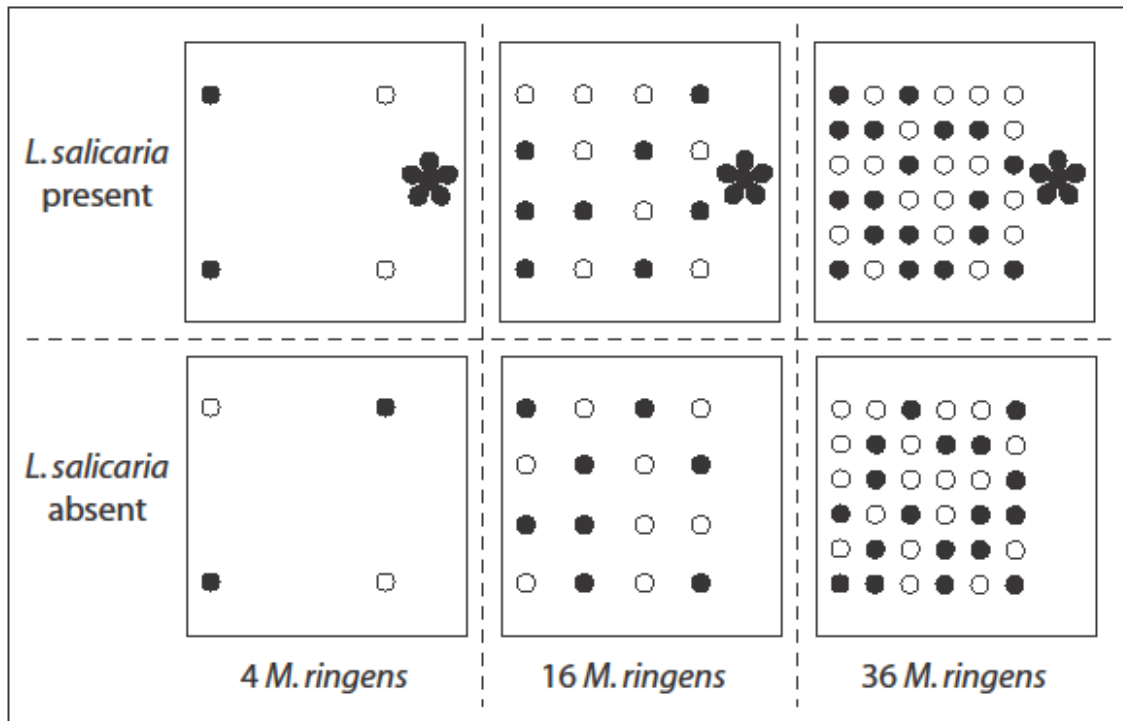

Figure 2. Means and bootstrap 95% confidence intervals for biomass of *M. ringens* in each density treatment for A) biomass without loosestrife, B) biomass with loosestrife, C) fitness without loosestrife, and D) fitness with loosestrife. Different letters above bars represent significant differences based on randomization tests.

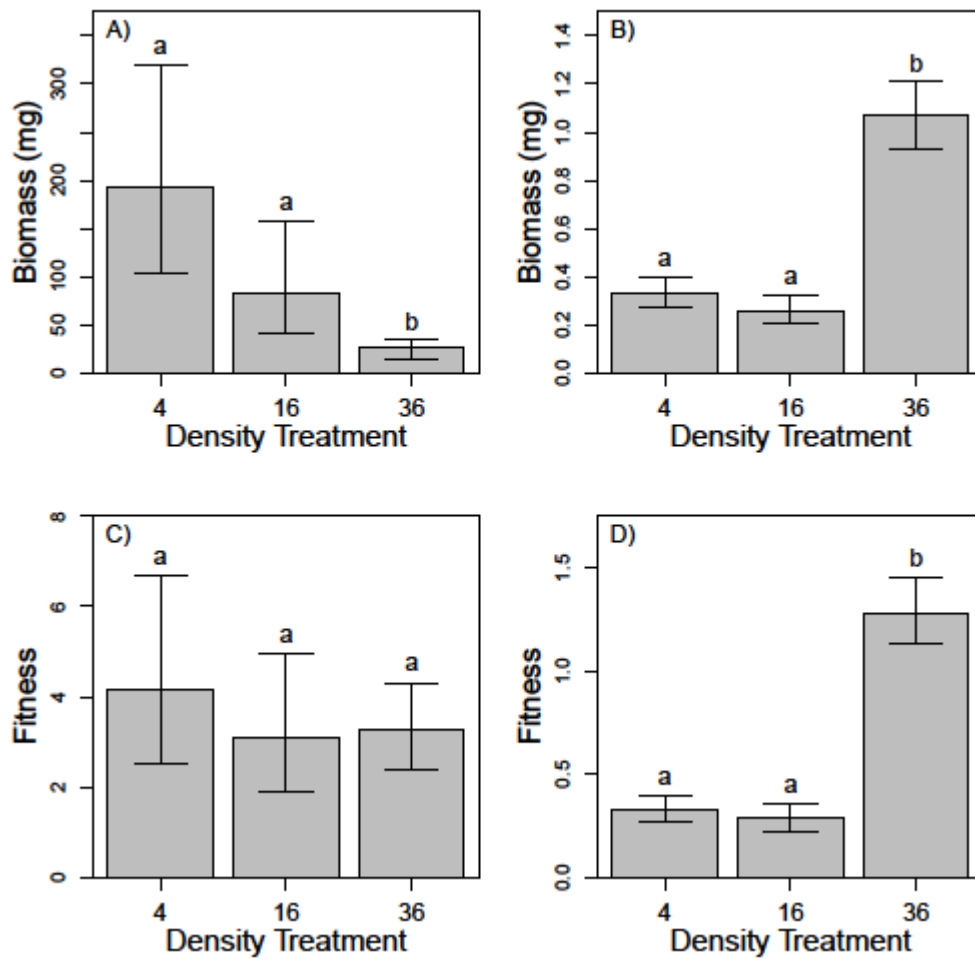

Figure 3. Inbreeding depression for fitness in each density treatment. Panels A) and B) show means and 95% confidence intervals of biomass for each cross by density treatment for all plants with and without loosestrife, respectively. Panels C) and D) show inbreeding depression estimates and 95% confidence intervals for each density treatment, for plants with and without loosestrife, respectively. Significant estimates are indicated by asterisks.

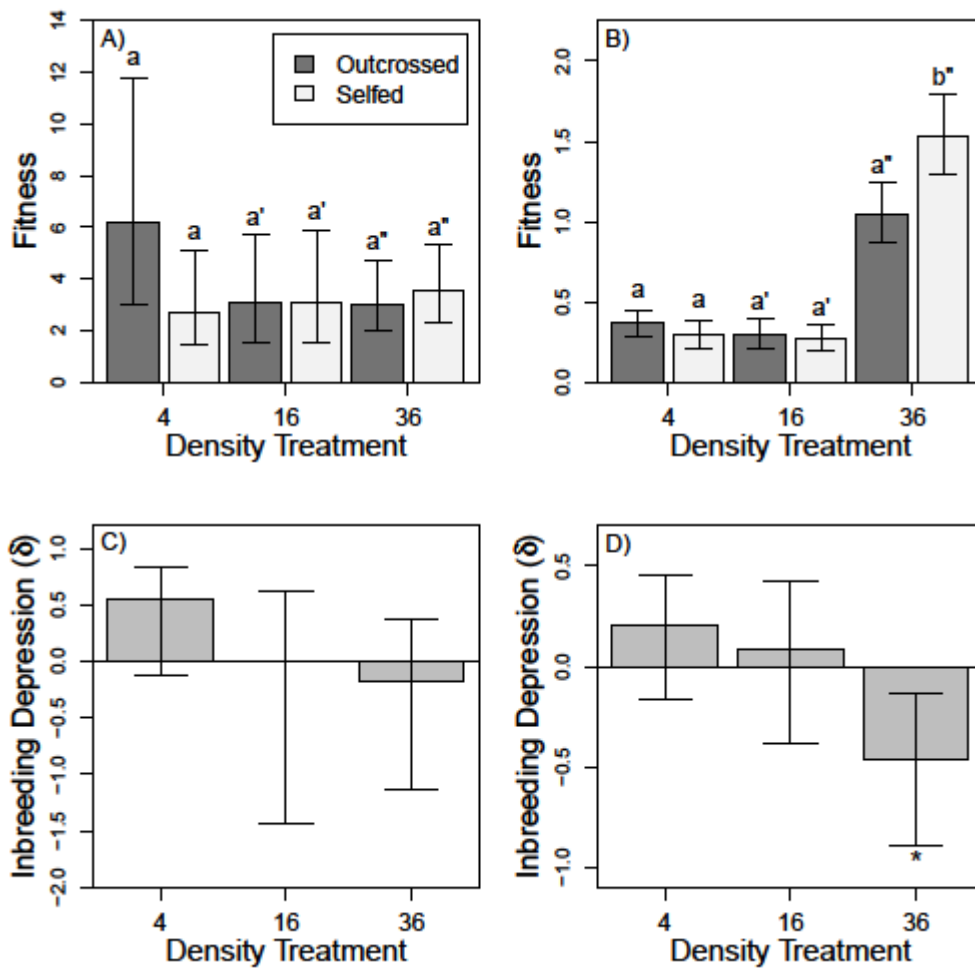
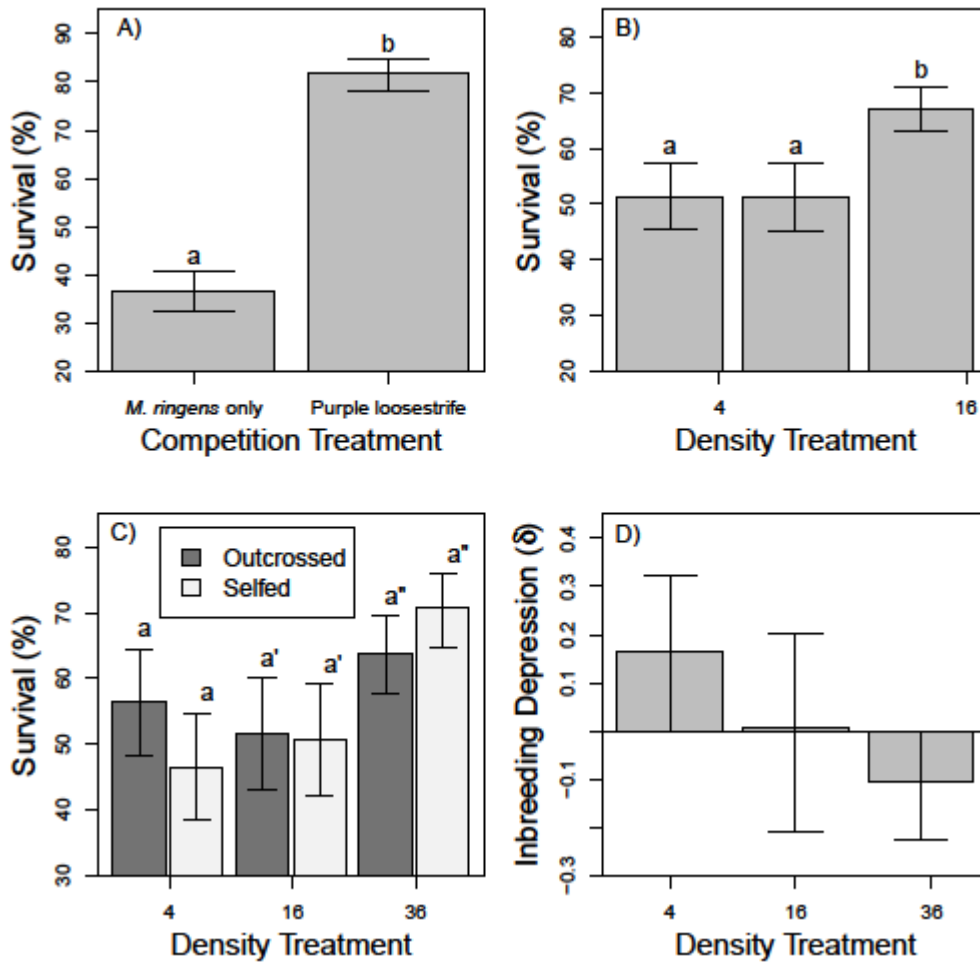

Figure 4. Summaries of the model for survival, depicting variation in survival among A) competition treatments, B) density treatments, C) competition by density, and D) variation in inbreeding depression between density treatments.



Chapter 3

A demographic investigation of the interaction between competition and inbreeding depression in *Mimulus ringens*

Abstract

The magnitude of inbreeding depression often varies between different environments, and a large body of research examines the effects different abiotic and biotic factors in influencing inbreeding depression. However, several gaps in our knowledge remain. The effects of certain important interactions, such as interspecific competition, remain unclear, and the use of fitness traits and cumulative fitness functions has prevented investigations of the implications of this relationship for population growth. Furthermore, the tendency to avoid longer lived plants with complex lifecycles has limited our understanding of the role of environmental variation influencing inbreeding depression in clonal plants. Here, we utilize a series of common garden experiments and a transition matrix model approach to investigate the population level consequences of the relationship between interspecific competition and inbreeding depression in *Mimulus ringens*. Three competitive environments are examined, a typical habitat, and competition with either *Lythrum salicaria* or *L. alatum*. Analyses of the model reveal that competitive interactions alter inbreeding depression in key vital rates and strongly affect the relationship between population growth and the mating system. In addition, differences in sensitivities between the environments suggest that competition can alter the range of outcrossing rates over which natural selection might be effective in eliminating inbreeding depression.

Introduction

Matings between related individuals often produce offspring with reduced fitness, a phenomenon known as inbreeding depression (*reviewed in* Charlesworth and Charlesworth 1987). This fitness cost of inbreeding has wide-ranging ecological and evolutionary implications. Inbreeding depression can reduce population growth rates (Keller and Waller 2002), increase the risk of population extinction (O'Grady *et al.* 2006), and is generally considered to be one of the key factors driving mating system evolution (*reviewed in* Charlesworth and Charlesworth 1987). This is particularly true in the case of flowering plants, many of which utilize mixed mating systems that include a combination of outcrossing and self-fertilization, the most extreme form of inbreeding, as reproductive strategies (Vogler and Kalisz 2001).

Recent research has shown that the magnitude of inbreeding depression is often sensitive to environmental conditions, and both abiotic factors and organismal interactions can alter it (*reviewed in* Armbruster and Reed 2005). For instance, studies in plants have shown that herbivory (*e.g.*, Ivey *et al.* 2004), plant density (*e.g.*, Gurevitch *et al.* 1996), interspecific competition (Cheptou *et al.* 2000), and other environmental factors can all play a role in shaping the strength of inbreeding depression in various taxa and traits. Thus, ecological interactions influence inbreeding depression, which in turn may alter the effects of these interactions.

Inbreeding depression is a dynamic trait, subject to evolution itself, and a rich body of theoretical work and empirical examples examines the effects of natural selection on inbreeding depression throughout the lifecycle and its maintenance and elimination

under different mating systems (Husband and Schemske 1996, Carr *et al.* 1997). Life history theory suggests that natural selection is much more efficient at eliminating, or purging, inbreeding depression in early life stages than in later parts of the life cycle, and several examples support this hypothesis (Husband and Schemske 1996, Dudash 1990). Likewise, a population's outcrossing rate can strongly influence the accumulation and elimination of the genetic variants underlying inbreeding depression. In highly outcrossing populations, these variants accumulate, as few individuals ever suffer inbreeding depression, whereas highly selfing populations are predicted to purge them much more readily (*e.g.*, Carr and Dudash 1996).

Most studies estimating inbreeding depression in multiple environments do not, by necessity, examine the effects of varying outcrossing rates, and many do not provide complete measures of reproductive fitness, instead using fitness proxies and components, such as biomass, survival, and single bouts of reproduction (*reviewed in* Armbruster and Reed 2005). While useful in our understanding of individual traits, this has left a gap in our knowledge of the effects of varying environments on inbreeding depression throughout the lifecycle, and the ultimate consequences for fitness. For plants with mixed mating systems, demographic transition-matrix models provide an opportunity to investigate the effects of inbreeding depression on population growth in multiple environments, as selfed and outcrossed individuals can be described with separate model stages. Furthermore, such models describe the dynamics of populations with complex life cycles, allowing inferences about the population level consequences of variation throughout the lifecycle.

Transition-matrix models have been a regular tool in studying the ecology of populations for decades (Leslie 1945, Lefkovitch 1965), and a well-defined set of mathematical tools exists for their analysis. Through sensitivity analyses and life table response experiments (LTREs), they provide the opportunity to study population growth, the influence of particular traits on population growth, and the overall contributions of certain vital rates to fitness differences between ecological treatments (Morris and Doak 2002, Caswell 2001). Inbreeding depression can easily be included in these models, as selfed and outcrossed individuals can be represented as different stages in the lifecycle. This strategy is unusual in the study of inbreeding depression, but has been employed successfully in investigating the analogous phenomenon of mixed seed types, where obligately selfed cleistogamous seeds and their chasmogamous counterparts represent separate classes (Steets et al. 2007).

In this study, we use the results of multiple experiments examining the effects of competition on inbreeding depression in *Mimulus ringens* to develop a mating-system explicit model of population growth. Competition with winged loosestrife (*Lythrum alatum*) and its invasive congener, purple loosestrife (*L. salicaria*) have been shown to influence inbreeding depression in growth and reproduction in *M. ringens*, which is a native perennial in North American wetlands. Our model examines three competitive treatments, an ambient native population's habitat, competition against winged loosestrife, and competition against purple loosestrife to answer the following questions: 1) Does variation in interspecific competition influence inbreeding depression in vital rates and, ultimately, fitness? 2) Which vital rates contribute most to differences in

fitness between competitive treatments? 3) Which vital rates are most influential to fitness? 4) Does variation in the outcrossing rate influence the effects of competition on these?

Materials and Methods

Study System

Mimulus ringens is a perennial herb native to wetland habitats through much of eastern North America. It exhibits a mixed mating system, producing prolific numbers flowers, each of which is capable of developing into a capsule containing anywhere from several hundred to several thousand seeds (Karron *et al.* 1995). This species reproduces both sexually and asexually through belowground stolons. Previous studies have demonstrated inbreeding depression in several fitness related traits throughout its lifecycle, and that competition with purple loosestrife influences inbreeding depression in many of these traits (Griffin *et al.*, *in prep*).

Winged loosestrife is a native wetland perennial that co-occurs with *M. ringens* in many parts of its range and exhibits a growth form that is similar to its invasive congener, purple loosestrife, though shorter (Griffn, *pers. obs.*). Competition with these species has been shown to alter inbreeding depression in *M. ringens* in biomass, stolon and capsule production (Griffin *et al.*, *in prep*). Furthermore, purple loosestrife is a Eurasian invader known to be highly competitive when growing with many different native species (Gaudet and Keddy 1988), and can have severe impacts on seed set in winged loosestrife (Brown *et al.* 2002).

Lifecycle and Model Stages

For the purposes of this model, the lifecycle of *M. ringens* was broken into four distinct stages, outcrossed stage-1, selfed stage-1, outcrossed stage-2, and selfed stage-2 (see Figure 1). Stage-1 plants are those in their first growing season, having been derived from seeds. Stage-2 plants are those that have arisen through clonal reproduction via underground stolons. It makes sense in this plant to model these clonal individuals as separate ramets, as they quickly lose their belowground connections to other plants and must function as physiologically independent units. This plant does produce a viable seed bank, but attempts to estimate germination and survival of seeds in the field in the wetland were unsuccessful, so the seed bank is not included in the model (Griffin, *pers. obs.*).

Vital Rate Estimation

To estimate vital rates of *M. ringens* under three competitive treatments, in a typical wetland population (**SH**), and competing against winged loosestrife (**WL**) or purple loosestrife (**PL**), we experimentally estimated the effect sizes of different competition treatments on experimentally outcrossed and selfed plants. These effect sizes were used to generate hypothetical plant populations with the appropriate competitive environment, by scaling estimates taken from selfed and outcrossed plants growing along a pond margin with a large population at the Missouri Botanical Garden's Shaw Nature Reserve (SNR, Gray Summit, MO). This method required four separate experiments and two observational estimates of vital rates, which are individually addressed below.

Experiment 1 – Inbreeding depression at SNR

In order to estimate inbreeding depression in sexual and clonal fecundity, and survival in a population of *M. ringens* experiencing a typical habitat for the species, we generated experimentally outcrossed and selfed individuals using seeds collected at SNR as the parental generation. The collection and breeding methods are more fully described elsewhere (Griffin *et al.*, *in prep*). These selfed and outcrossed plants were allowed to establish in the Washington University Greenhouse, after which the resulting seedlings were transplanted into five blocks at SNR. The area selected for planting was adjacent to the core of the main *M. ringens* population, but had relatively few individuals, which were cleared before planting. The vegetation in that area consisted largely of a *Polygonum* species. Each block consisted two replicates of two crosses per each of 16 maternal seed families, for a total of 320 plants in the experiment. At the end of the first year, the number of developed fruits per plant was counted, and the number of successful stoloniferous clones (stage-2) produced by each plant was counted upon emergence the next spring. At the end of the second growing season, the average fruit production for the clones resulting from each experimental plant was recorded. We were not able to estimate the number of clones generated by these stage-2 plants, so we excavated 50 stage-2 plants from the SNR population and counted the number of attached stolons and scars produced by breaking stolons during the excavation. The number of seeds per fruit was estimated by weighing the contents of selected fruits to generate a regression describing the relationship between seed number and mass ($seeds = -94.55 + 92.36 * mass$, $p < 0.0001$, $R^2 = 0.9043$, $N = 19$). Fifty randomly collected fruits were then weighed to estimate an average.

Experiment 2 – Inbreeding depression and competition – Stage 1

To estimate the sexual and clonal fecundities of selfed and outcrossed stage-1 plants in the three competitive environments, we simultaneously grew plants from the same crosses in a common garden at Washington University's Tyson Research Center (TRC, Eureka, MO). These plants were grown while competing with another *M. ringens* individual, a single winged loosestrife, or a single purple loosestrife. The experimental design of this experiment is described elsewhere in full (Griffin et al., *in prep*). At the end of the growing season, the numbers of fruits and stolons were counted for each individual.

Experiment 3 – Inbreeding depression and competition – Stage 2

Several individuals from the above-described crosses were maintained in the greenhouse in order to generate stolons for Experiment 3. These stolons were transplanted into the common garden at TRC in order to estimate fruit and stolon production in stage-2 plants, using the same experimental design as Experiment 1, but with reduced numbers (N=124), due to difficulties in generating large numbers of stolons of reasonably similar sizes. Fruit and stolon number were counted at the end of the season, and an analysis of covariance determined that the experimental factors did not alter the slopes of the effects of initial stolon mass on these fitness traits.

Experiment 4 – Inbreeding depression and competition – Germination

To estimate the effect of inbreeding depression and competition on germination in *M. ringens*, we placed packets of 50 outcrossed or 50 selfed seeds around an older *M. ringens*, a winged loosestrife, or a purple loosestrife in the greenhouse. Each packet was

put into a single pot and represented seeds from one family only, and pots were partially submerged in bins to mimic wetland moisture levels in the spring, when this species germinates. The proportion of successfully established plants was measured approximately one month later.

Vital Rate Adjustments

The vital rates used to simulate a population in a typical habitat (**SH**) were taken directly from Experiment 1 at SNR. Because we could not introduce new plant species, particularly the invasive purple loosestrife into SNR, we simulated the winged loosestrife (**WL**) and purple loosestrife (**PL**) competitive treatments by adjusting the Experiment 1 data using effect sizes from Experiments 2 and 3. To do this, the fruit and stolon number data from each experiment were split by competitive treatment by cross. One thousand bootstrap distributions with replacement were then generated for each group and the effect of competition with either loosestrife species was calculated for each bootstrap estimate by cross, using the log-ratio response,

$$effect\ size_{xcl} = \ln \frac{x_{cl}}{x_{cm}},$$

Where c denotes the cross, l denotes the loosestrife treatment in question, x is the vital rate, and m signifies the *M. ringens* competitive treatment. The Experiment 1 data were then also bootstrapped, by cross, and the new, simulated values of each vital rate were generated by adjusting these bootstrap distributions with the effect sizes, using the equation,

$$x'_{cl} = e^{x + effect\ size_{xcl}},$$

in which x' , represents the simulated vital rate. Because we were unable to measure the number of stolons produced by stage-2 plants in Experiment 1, we were forced to simulate this vital rate by first calculating an effect size for selfing within the *M. ringens* competitive treatment from Experiment 3. The stolon numbers taken from excavations at SNR were then adjusted, assuming they represented outcrossed plants, to simulate selfed plants. These distributions were then adjusted in the same way as described above. Means and 95% confidence intervals for these vital rates are presented, and permutation tests were used to test for the effects of competition and cross within competitive treatment between them.

The germination rates from the greenhouse experiment were quite high, and this parameter must also account for survival through the period of establishment, so we multiplied these data by 0.01 before including them in the model. This also more closely resembles personal observations in the field, where, in many years, successful recruitment of seeds to reproductive individuals at SNR is essentially zero.

Modeling Population Growth

To model the population in the three treatments, we used a transition matrix model of the form, $\mathbf{n}_{t+1} = \mathbf{A} \times \mathbf{n}_t$, in which \mathbf{A} is a matrix describing the probabilities of individuals transitioning between stages and their associated fecundities, t is a subscript denoting the time step, and \mathbf{n} is a vector describing the number of individuals in each stage. In this model, the \mathbf{A} -matrix is a 4x4 matrix, divided into two growth stages and two crossing classes (Figure 1). The individual elements, a_{ij} , are actually constructed from multiple vital rates, as described in full in Table 1. Different \mathbf{A} -matrices were

constructed, representing the three different competitive environments, using the means of the bootstrapped vital rates in each case. In order to analyze the behavior of the model over all possible outcrossing rates, from zero to one, we constructed 101 matrices for each treatment, varying t in increments of 0.01, resulting in 303 separate matrices.

Model Analysis

Population Growth Rates

We calculated the discrete time population growth rate, λ , for each **A**-matrix by calculating its dominant eigenvalue. To investigate the effects of the competitive treatments and inbreeding on population growth, we plotted these by competitive treatment along all possible outcrossing rates. To determine how much population growth was lost to inbreeding at each value of outcrossing, we subtracted the realized λ for each value from the maximum λ for that competitive treatment, which always occurred when $t=1$. We also estimated an overall magnitude of inbreeding depression for population growth in each treatment. To do this, we eliminated t from the vital rate equations and split the resulting three **A**-matrices into two 2x2 matrices reflecting selfed and outcrossed plants. Values of λ were calculated for each, and inbreeding depression was calculated for each competitive treatment with the equation,

$$\delta_{\lambda T} = 1 - \frac{\lambda_{ST}}{\lambda_{OT}},$$

where S denotes selfed individuals, O outcrossed individuals, and T the competitive treatment.

Vital Rate Sensitivities

The principle motivation for this study was to determine how sensitive *M. ringens* population growth was to inbreeding depression in particular vital rates, and how the different competitive environments might change that. We therefore conducted a sensitivity analysis on each of the **A**-matrices described above, using the symbolic logic method described by Morris and Doak (2002). To make this analysis informative for the study of inbreeding depression, we redefined the matrices using the magnitude of observed inbreeding depression for each vital rate as a vital rate itself. This allowed us to describe the vital rates for selfed individuals using the equation, $x_S = x_O(1 - \delta_x)$, where x is the vital rate, S selfed individuals, O outcrossed individuals, and δ the magnitude of inbreeding depression in the vital rate. These sensitivities were calculated for capsule and stolon production in stages 1 and 2, germination, and their associated levels of inbreeding depression.

Life Table Response Experiments (LTREs) and Stable Stage Distributions

We also conducted a life table response experiment to determine how the competitive treatments and variation in outcrossing changed the relative contributions of differences between the different matrix elements to differences in λ . This was performed per the method described in Morris and Doak (2002). We conducted three separate sets of LTREs at each outcrossing rate, two comparing the different loosestrife treatments (**WL** and **PL**) to the **SH** treatment, and one comparing the **WL** and **PL** treatments to each other. Stable stage distributions, described by the right eigenvector of the **A**-matrix, were also calculated to determine how the competitive treatments might influence the relative representation of selfed and outcrossed individuals in the

population. The development of the model and all analyses were performed in R v. 2.92 (R Development Core Team 2010) and made extensive use of the popbio package (Stubben and Milligan 2007)

Results

Vital Rates and Inbreeding Depression

The production of both stolons and capsules was greatest in the **SH** treatment in both stages, whereas germination rates were highest in the **PL** treatment (Figure 2). The **WL** treatment yielded higher capsule and stolon numbers than the **PL** treatment, except for stage-1 capsule numbers, in which selfed **PL** plants outperformed selfed **WL** plants, though not significantly. Outcrossed plants tended to outperform their selfed counterparts, except in stage-1 **PL** plants, for which both capsule and stolon production were lower in outcrossed individuals. This yielded significant inbreeding depression in the **SH** treatment for capsules in both stages and stolons in stage-2, in the **WL** treatment, germination rates and stage-2 stolons, and stage-2 stolons in the **PL** treatment. Other traits tended toward non-significant inbreeding depression.

Population Growth Rates

In each treatment, the reproductive fitness of outcrossed individuals was greater than that of selfed individuals, but not significantly in the **PL** treatment (Figure 3A). This resulted in overall inbreeding depression estimates of 44.2%, 55.6%, and 26.6% in the **SH**, **WL**, and **PL** treatments, respectively. This estimate was not significantly different from zero in the **PL** treatment, and the differences between treatments were also not significant (Figure 3B). Because inbreeding depression estimates were positive in all

three competitive environments, the population growth rate, λ , increased with the outcrossing rate. The inherent inclusion of multiple life stages with variation in inbreeding depression across the lifecycle caused this increase to be nonlinear (Figure 3C). In absolute terms, the **SH** treatment enjoyed the greatest increases in population growth with outcrossing and suffered the greatest absolute losses to inbreeding depression at low outcrossing rates. Analysis of the LTREs revealed that most of the differences in population growth between the **SH** treatment and the other two were determined by the greater productivity of both capsules and stolons by stage-1 plants in that treatment (Appendices A and B). In the two loosestrife treatments, which exhibited more similar cumulative fitness estimates, differences in inbreeding depression actually caused *M. ringens* in the **PL** treatment to outperform those in the **WL** treatment at low outcrossing rates. However, the higher output of outcrossed **WL** individuals caused this relationship to switch at outcrossing rates of approximately 0.1 or higher (Figure 3C). The greater values of λ in the **PL** treatment at low values of t were caused by greater production of stage-1 plants, largely by selfed individuals, when selfing rates were high, and was due, no doubt, to both the high germination in the **PL** treatment and capsule production by selfed plants (Appendix C). Plotting the loss of λ in each treatment to inbreeding depression along the t axis shows that the absolute cost of inbreeding in terms of fitness varied from its maximum at $t=0$ to zero when $t=1$ (Figure 3D). The relationship between the stable stage distribution of the population and the outcrossing rate makes this clear, as the population consisted of entirely selfed individuals at $t=0$, and all outcrossed plants at $t=1$ (Appendix D). The **SH** treatment consistently lost more

population growth to inbreeding effects that the **WL** treatment, which in turn suffered more than the **PL** treatment. In addition to strongly influencing the cost of inbreeding, the competitive treatments altered the long term predictions for the genetic makeup of the population and changed the outcrossing rate at which outcrossed and selfed individuals were equally represented in the population (Appendix D). For instance, in the **WL** treatment, a higher proportion of the population was outcrossed at intermediate outcrossing rates than in the other two treatments.

Vital Rate Sensitivities

In each treatment, the population growth rate of *M. ringens* was most sensitive to germination (not shown), with the next most influential vital rate being the production of stolons by stage-1 plants, followed by stage-1 capsule production (Figure 4A-C). The true influence of germination in these models is difficult to quantify, as our estimates of germination rates must also account for early survival rates of seedlings, and are most likely overestimates of what occurs in nature. Sensitivities to both stage-1 stolons and stage-1 capsules increased with outcrossing rate, except in the **PL** treatment, where sensitivity to stage-1 capsule production remained much higher than in the other treatments, but decreased with outcrossing.

Predictably, population growth rates were most sensitive to changes in inbreeding depression at $t=0$, and not sensitive at all to these changes at $t=1$, as inbreeding depression does not contribute to the A-matrix at this point (Figure 4D-F). However, the pattern of sensitivities to inbreeding depression did not follow those of the vital rates themselves. In every treatment, population growth was most sensitive to inbreeding

depression in stage-2 capsule production at every value of t less than one. This was consistently followed by stage-1 stolon production. The sensitivities to inbreeding depression in stage-2 stolons and stage-1 capsules were low, except in the **SH** treatment, where λ was highly sensitive to stage-1 capsule production. In addition to these differences, the treatments differed in the magnitudes of these sensitivities and the rates of their decline with outcrossing. In the **WL** treatment, the sensitivity to inbreeding depression in particular vital rates declined dramatically with relatively low outcrossing rates, effectively reducing the range of outcrossing rates over which the population was highly sensitive to inbreeding depression. Conversely, sensitivities to inbreeding depression were higher in the **SH** treatment and declined much more gradually with outcrossing.

Discussion

This model reveals that interspecific competition can have dramatic effects on population growth beyond those described by direct reductions in fitness. By influencing inbreeding depression in key vital rates throughout the *M. ringens* lifecycle, variation in competitive treatments changed the relationship between population growth and the outcrossing rate, altered population growth itself, and altered the stable stage distributions and sensitivities of lambda to vital rates. Taken together, these suggest that the effects of interspecific competitors on inbreeding depression may have important implications for the demography, evolution of mating systems and the purging of inbreeding load from native plant populations.

Demographic Implications

Interspecific competition is one of the most studied organismal interactions in all of ecology and evolution, and can greatly affect fitness-related traits and, ultimately, population growth in native plants. Complete demographic analyses allow researchers to untangle this complicated web of effects and traits and allow a thorough examination of fitness consequences. For instance, a recent study of population growth in *Anemone patens* showed that the population growth of *A. patens* is greatly reduced in patches of the invasive grass *Bromus inermis* compared to those growing with native grasses (Williams *et al.* 2006). *Anemone patens* population growth was most sensitive to survival, which was reduced with *B. inermis*, but an LTRE revealed that reductions in plant growth were actually most responsible for the differences. Our study contains similar results; *M. ringens* population growth is highly sensitive to germination and early survival, which is increased in the **PL** treatment. However, the **PL** treatment consistently yielded lower estimates of λ , due to reductions in the production of capsules and stolons.

Predicting which traits will be demographically important between populations or experimental treatments becomes even more complicated when effects of and on inbreeding depression are considered. Most studies of the relationship between inbreeding depression and environmental conditions, often by necessity, focus on one or a few fitness components, such as flowering (*e.g.*, Carr *et al.* 2003), or survival (Eckert and Barrett 1994). When possible, cumulative fitness measures are estimated (*reviewed in* Armbruster and Read 2005). Furthermore, these estimates are often only available for particular parts of the lifecycle. Using the strategies of demographic modeling, further inferences can be made concerning the importance of particular effects on traits, and the

demographic consequences of the sensitivity of inbreeding depression to the environment. In this study, excluding germination, the production of stolons by stage-1 plants was the vital rate most influential to population growth, and population growth was also highly sensitive to changes in inbreeding depression in this trait (though much less so in the **PL** treatment). Furthermore, differences in this vital rate greatly contributed to differences in λ between competitive treatments. However, λ was more sensitive to changes in inbreeding depression in capsule production by stage-2 plants, a vital rate to which population growth was relatively insensitive.

Additionally, the relationship between λ and the outcrossing rate was extremely important in determining the overall effects of competition on population growth, due to differences in inbreeding depression between the treatments. Through superior production of both stolons and capsules at all life stages, plants in the **SH** treatment had higher λ values at all outcrossing rates. However, in the **WL** and **PL** treatments, differences in the performance of selfed plants, which tended to exhibit outbreeding depression in stage-1 plants in the **PL** treatment, led to higher λ estimates in the **PL** treatment for a limited range (0-0.1) of low outcrossing rates. At higher outcrossing rates, plants in the **WL** treatment enjoy a greater release from inbreeding depression, and outperform the **PL** treatment. Thus, variation in outcrossing rates played an important role in determining the overall fitness of the population. *Mimulus ringens* exhibits extensive variation in outcrossing rates between individual plants and environments. Variation in plant density (Karron *et al.* 1995), the presence of co-flowering species (Bell *et al.* 2005), and floral display sizes (Karron *et al.* 2004) have all been shown to influence

its outcrossing rate. Factors such as density (Waller *et al.* 2008) and competition (Cheptou *et al.* 2000b) can also affect inbreeding depression, creating the possibility for highly complex future models of population growth that incorporate the effects of environmental factors on outcrossing, inbreeding depression, and fitness traits.

Evolutionary Implications

One of the mathematical advantages of transition matrix models is that λ can be equated with the average fitness of a population, \bar{W} , taken from quantitative genetic models (Lande 1982a, b), and the sensitivities of λ can be interpreted as selection gradients (Charlesworth 1993, 1994). Thus, the sensitivities of λ to particular vital rates provide insights into their potential evolutionary trajectories. Vital rates with larger sensitivities (in absolute value) are those that greatly affect fitness and are, therefore, under stronger selection than those with smaller sensitivities. In plants with mixed mating systems, the outcrossing rate is very important to the process of selection eliminating inbreeding depression. In highly outcrossing populations, inbreeding load accumulates, because it is effectively “invisible” to selection, whereas highly selfing populations more effectively purge these variants and often do not exhibit detectable inbreeding depression (Carr *et al.* 1997). The sensitivities of the model follow this pattern, with their largest values at $t=0$, and zero-values at $t=1$. However, the competitive treatments differed in the rates of decline in these sensitivities, which were very gradual in the **SH** treatment, but dropped sharply in the **WL** treatment. Thus, competition altered the range of outcrossing rates over which selection might be effective in purging inbreeding depression from the population. This is in part explained by the

additional competitive effect of altering the proportions of selfed and outcrossed individuals estimated by the stable stage distribution, as outcrossed individuals were always over-represented in the **WL** treatment compared to the other two.

In addition to influencing the relationship between vital rate sensitivities and the outcrossing rate, the competitive treatments altered which vital rates exhibited inbreeding depression that was influential to fitness. Both theory and empirical examples suggest that the genetic variants responsible for inbreeding depression, or inbreeding load, are much more easily purged from populations when they affect traits relevant in early life stages, such as germination, seedling survival, and the reproductive output of first-year plants (Husband and Schemske 1996). This held true in this model, for the most part, except that population growth, in each treatment, was highly sensitive to inbreeding depression in capsule number in stage-2 plants. Thus, the competitive environment may be an important factor in determining which traits and parts of the lifecycle natural selection can purge of inbreeding depression.

Future Expansions of the Model

By employing transition matrix models, which have a long history and well defined set of mathematical tools, we were able to make interesting inferences about the relationship between inbreeding depression, outcrossing rates, and interspecific competition throughout the lifecycle of *M. ringens*. Several possible expansions immediately are apparent, and are necessary steps to advance our understanding of inbreeding depression in multiple environments and the competitive interactions involved. First, the model could be expanded to include competition for pollinator

services. This is a natural step in this system, as Flanagan *et al.* (2009) showed that purple loosestrife reduces pollen deposition and seed set in *M. ringens*. Also, the model assumes that selfing is the only mode of inbreeding, and that only two levels of inbreeding exist (zero and one-half). These are useful simplifications in the study of plants, as plants with mixed mating systems provide the clear dichotomy between self-fertilization and outcrossing. However, models with larger matrices, representing multiple levels of inbreeding are possible, as are continuous models such as integral projection models. Ideally, future models will also include links to the specific quantitative traits that contribute to inbreeding depression and its dependency on the environment.

Conclusions

We conclude that interspecific competition may play an important role in determining the demographic and evolutionary effects of inbreeding depression. By altering inbreeding depression throughout the lifecycle and in many different vital rates, variation in competitive environments may strongly influence how populations exhibit inbreeding depression, the potential for natural selection to eliminate inbreeding depression, and the range of outcrossing rates over which inbreeding depression is highly influential to fitness. These, in addition to altering the proportions of selfed and outcrossed individuals in the population, suggest that future models of mating system evolution and our understanding of the population level consequences will be better served by explicitly considering the competitive environment. Finally, transition matrix

models provide a useful, yet underused tool for studying inbreeding depression across the lifecycle and in different populations and environments.

Acknowledgments

We would like to thank Missouri Botanical Garden's Shaw Nature Reserve, and particularly J. Trager for assistance locating *M. ringens* and permission to collect fruits and conduct experiments on their property. We also thank Washington University's greenhouse staff, especially M. Dyer, and the Tyson Research Center for hosting experiments and providing logistical support in setup and maintenance. We thank S. Raghu for providing *L. salicaria* rootstock. Additionally, several people provided insightful comments during the planning or analysis of this research or the writing of this article, including A. Conley, E. Pardini, J. Chase, B. Schaal, J. Orrock, K. Olsen, J. Cheverud, and the entire laboratories of TMK and ART. This work was funded by a National Science Foundation Doctoral Dissertation Improvement Grant (#0807879) awarded to NWG, ART, and TMK.

Works Cited

- Armbruster, P., and D. H. Reed. 2005. Inbreeding depression in benign and stressful environments. *Heredity* 95:235-242.
- Bell, J. M., J. D. Karron, and R. J. Mitchell. 2005. Interspecific competition for pollination lowers seed production and outcrossing in *Mimulus ringens*. *Ecology* 86:762-771.

- Brown, B. J., and R. J. Mitchell. 2002. Competition for pollination by invasive plants: Effects of pollen from *Lythrum salicaria* (Lythraceae) on seed set in native *Lythrum alatum*. *Oecologia* 129:43-49
- Carr, D. M. and M. R. Dudash. 1996. Inbreeding depression in two species of *Mimulus* (Scrophulariaceae) with contrasting mating systems. *American Journal of Botany* 83:586-593.
- Carr, D. E., Fenster, C. B., and M. R. Dudash. 1997. The relationship between mating-system characters and inbreeding depression in *Mimulus guttatus*. *Evolution* 51:363-372.
- Carr, D. E., Murphy, J. H., and M. D. Eubanks. 2003. The susceptibility and response of inbred and outbred *Mimulus guttatus* (Scrophulariaceae). *Evolution* 56:22-30.
- Caswell, H. 2001. Matrix population models: construction, analysis, and interpretation. Second edition. Sinauer Associates, Inc. Sunderland, Massachusetts.
- Charlesworth, B. 1993. Natural selection on multivariate traits in age-structured populations. *Proceedings of the Royal Society of London* B251:47-52.
- Charlesworth, B. 1994. *Evolution in age-structured populations*. Second edition. Cambridge University Press, Cambridge, England.
- Charlesworth, D., and B. Charlesworth. 1987. Inbreeding Depression and its Evolutionary Consequences. *Annual Review of Ecology and Systematics* 18:237-268.

- Cheptou, P. O., E. Imbert, J. Lepart, and J. Escarre. 2000. Effects of competition on lifetime estimates of inbreeding depression in the outcrossing plant *Crepis sancta* (Asteraceae). *Journal of Evolutionary Biology* 13:522-531.
- Dudash, M. R. 1990 Relative fitness of selfed and outcrossed progeny in a self-protandrous species, *Sabatia angularis* L. (Gentianaceae): a comparison of three environments. *Evolution* 44: 1129–1139.
- Eckert, C. G., and S. C. H. Barrett. 1994. Inbreeding depression in partially self-fertilizing *Decodon verticillatus* (Lythraceae): population genetic and experimental analyses. *Evolution* 48:952-964.
- Flanagan, R. J., R. J. Mitchell, D. Knutowski, and J. D. Karron. 2009. Interspecific pollinator movements reduce pollen deposition and seed production in *Mimulus ringens* (Phrymaceae). *American Journal of Botany* 96: 809–815.
- Gaudet, C.L., and P.A. Keddy. 1995. Competitive performance and species distribution in shoreline plant communities: a comparative approach. *Ecology* 76: 280-291.
- Gurevitch, J., D. R. Taub, T. C. Morton, P. L. Gomez, and I. N. Wang. 1996. Competition and genetic background in a rapid-cycling cultivar of *Brassica rapa* (Brassicaceae). *American Journal of Botany* 83:932-938.
- Husband, B. C. and D. W. Schemske. 1996. Evolution of the magnitude and timing of inbreeding depression in plants. *Evolution* 50:54-70.
- Ivey, C. T., Carr, D. E., and M. D. Eubanks. 2004. Effects of inbreeding in *Mimimulus guttatus* on tolerance to herbivory in natural environments. *Ecology* 85:567-574.

- Karron, J. D., R. J. Mitchell, K. G. Holmquist, J. M. Bell, and B. Funk. 2004. The influence of floral display size on selfing rates in *Mimulus ringens*. *Heredity* 92:242-248.
- Karron, J. D., Thumser, N. N., Tucker, R., and A. J. Hessenauer. 1995. The influence of population density on outcrossing rates in *Mimulus ringens*. *Heredity* 75:175-180.
- Keller, L. F., and D. M. Waller. 2002. Inbreeding effects in wild populations. *Trends in Ecology and Evolution* 17:230-241.
- Lande, R. 1982a. A quantitative genetic theory of life history evolution. *Ecology* 63:607-615.
- Lande, R. 1982b. Elements of a quantitative genetic model of life history evolution. Pages 21-29 in Dingle, H. and J. P. Hegmann, eds. *Evolution and genetics of life histories*. Springer-Verlag, New York, New York, USA.
- Lefkovich, L. P. 1965. The study of population growth in organisms grouped by stages. *Biometrics* 21:1-18.
- Leslie, P. H. 1945. On the use of matrices in certain population mathematics. *Biometrika* 33:183-212.
- Morris, W. F., and D. F. Doak. 2002. *Quantitative conservation biology: theory and practice of population viability analysis*. Sinauer Associates, Inc. Sunderland, Massachusetts.
- O'Grady, J. J., Brook, B. W., Reed, D. H., Ballou, J. D., Tonkyn, D. W., and R. Frankam. 2006. Realistic levels of inbreeding depression strongly affect extinction risk in wild populations. *Biological Conservation* 133:42-51.

- R Development Core Team. 2009. R: A language and environment for statistical computing., version 2.9.0. R Foundation for Statistical Computing, Vienna, Austria.
- Steets, J. A., Knight, T. M., and T-L. Ashman. 2007. The interactive effects of herbivory and mixed mating for the population dynamics of *Impatiens capensis*. *American Naturalist* 170:113-127.
- Stubben, C.J. and Milligan, B.G. 2007. Estimating and Analyzing Demographic Models Using the popbio Package in R. *Journal of Statistical Software* 22:11.
- Vogler, D. W. and S. Kalisz. 2001. Sex among the flowers: the distribution of plant mating systems. *Evolution* 55:202–204.
- Waller, D. M., J. Dole, and A. J. Bersch. 2008. Effects of stress and phenotypic variation on inbreeding depression in *Brassica rapa*. *Evolution* 62:917-931.
- Willi, Y., S. Dietrich, M. van Kleunen, and M. Fischer. 2007. Inter-specific competitive stress does not affect the magnitude of inbreeding depression. *Evolutionary Ecology Research* 9:959-974.
- Williams, J. L., and E. E. Crone. 2006. The impact of invasive grasses on the population growth of *Anemone patens*, a long-lived native forb. *Ecology* 87:3200-3208.

Table 1. Mathematical descriptions of the transition probabilities of the A-matrix. The subscripts, *O* and *S*, refer to outcrossed and selfed individuals, respectively, and *g* denotes germination rate, *t*, the outcrossing rate, *F*, the number of capsules, *sd*, the average number of seeds per capsule, and *C*, the number of stolons.

Matrix element	Equation	Transition
f1	$F_{O1} * t * g_o * sd$	O1 by O1
f2	$F_{O1} * (1-t) * g_s * sd$	S1 by O1
f3	$F_{O2} * t * g_o * sd$	O1 by O2
f4	$F_{O2} * (1-t) * g_s * sd$	S1 by O2
f5	$F_{S1} * t * g_o * sd$	O1 by S1
f6	$F_{S1} * (1-t) * g_s * sd$	S1 by S1
f7	$F_{S2} * t * g_o * sd$	O1 by S2
f8	$F_{S2} * (1-t) * g_s * sd$	S1 by S2
c1	C_{O1}	O2 by O1
c2	C_{O2}	O2 by O2
c3	C_{S1}	S2 by S1
c4	C_{S2}	S2 by S2

Figure 1. Lifecycle diagram and basic construction of the A-matrix. Arrows represent sexual and clonal reproductive transition probabilities between outcrossed and selfed stage-1 and stage-2 plants (O1, O2, S1, S2). Transitions represented by an f represent sexual fecundity, and c refers to clonal reproduction.

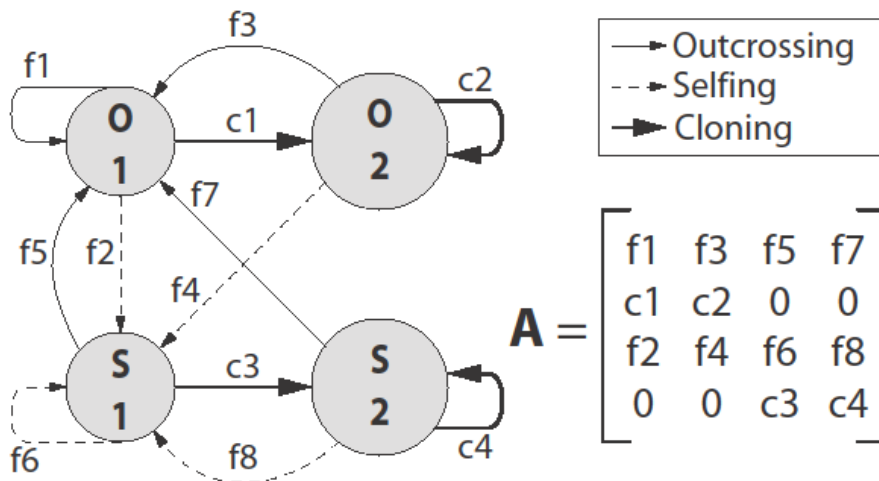

Figure 2. Vital rates and bootstrap 95% confidence intervals for individual vital rates and their associated magnitudes of inbreeding depression for A) germination, B) stage-1 capsules, C) stage-2 capsules, D) stage-1 stolons, and E) stage-2 stolons.

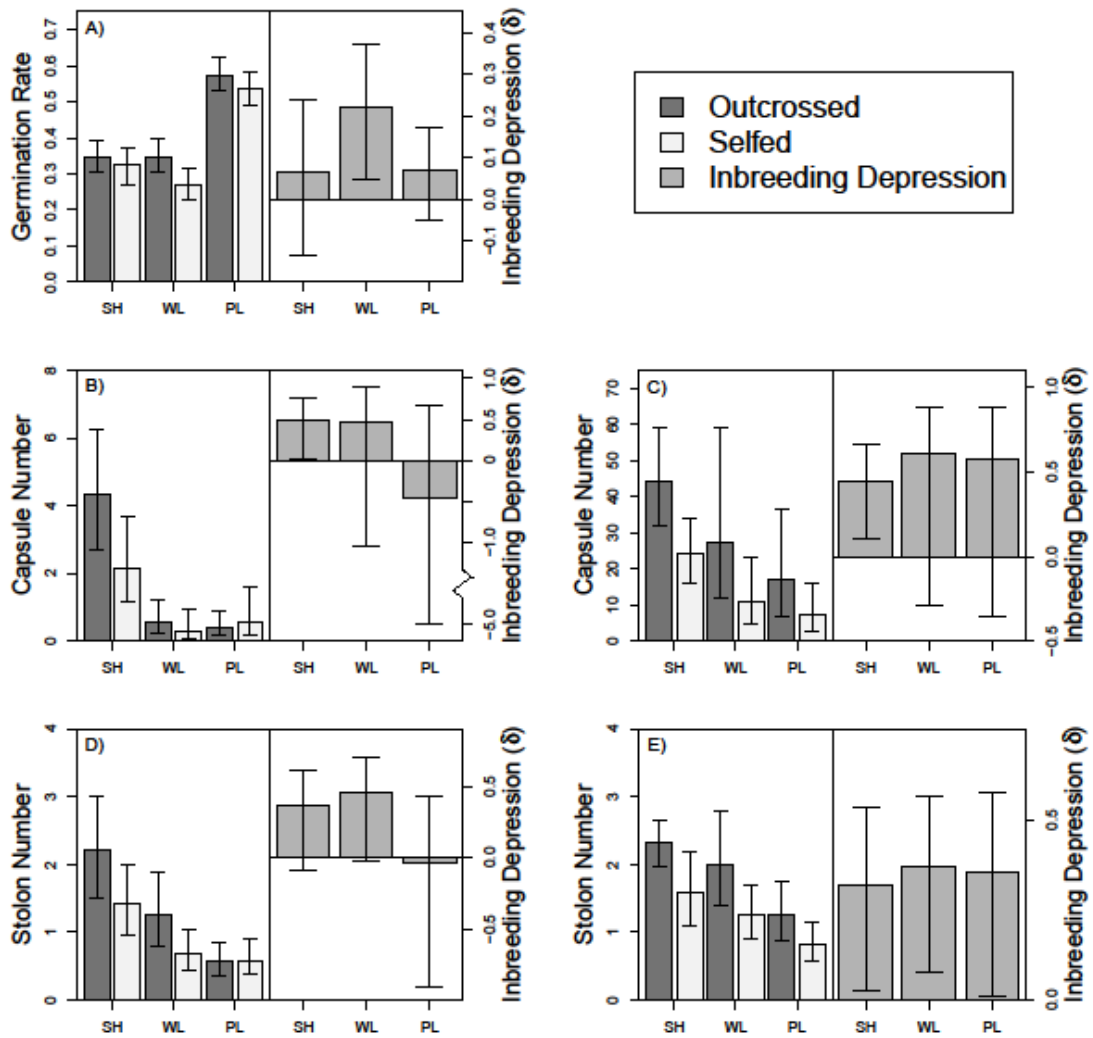

Figure 3. Estimates and 95% confidence intervals of A) population growth (λ) for outcrossed and selfed individuals, B) inbreeding depression for λ , C) λ as a function of the outcrossing rate, t , and D) the loss of λ due to inbreeding as a function of t .

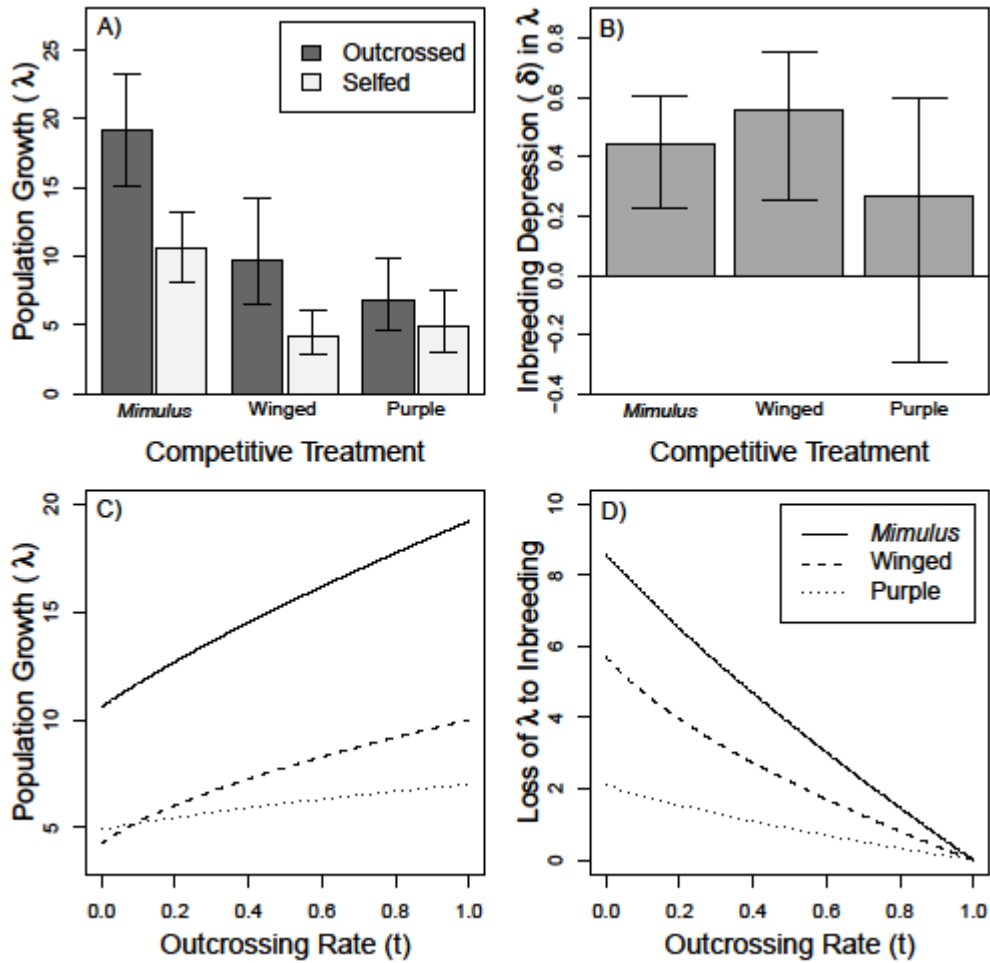
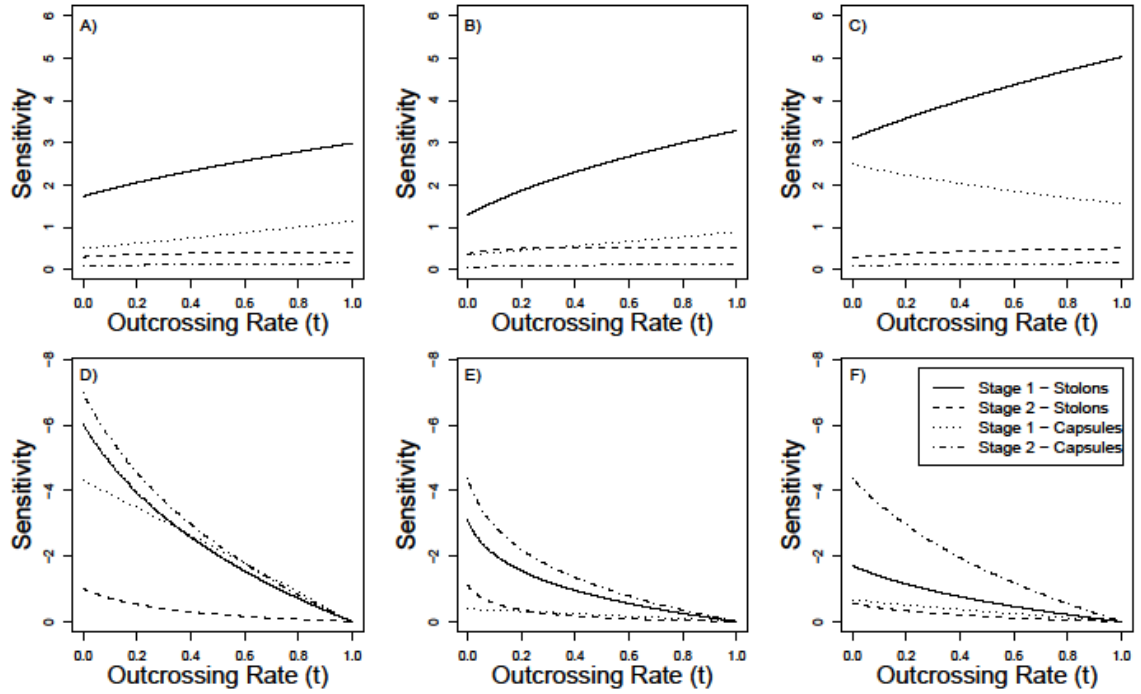
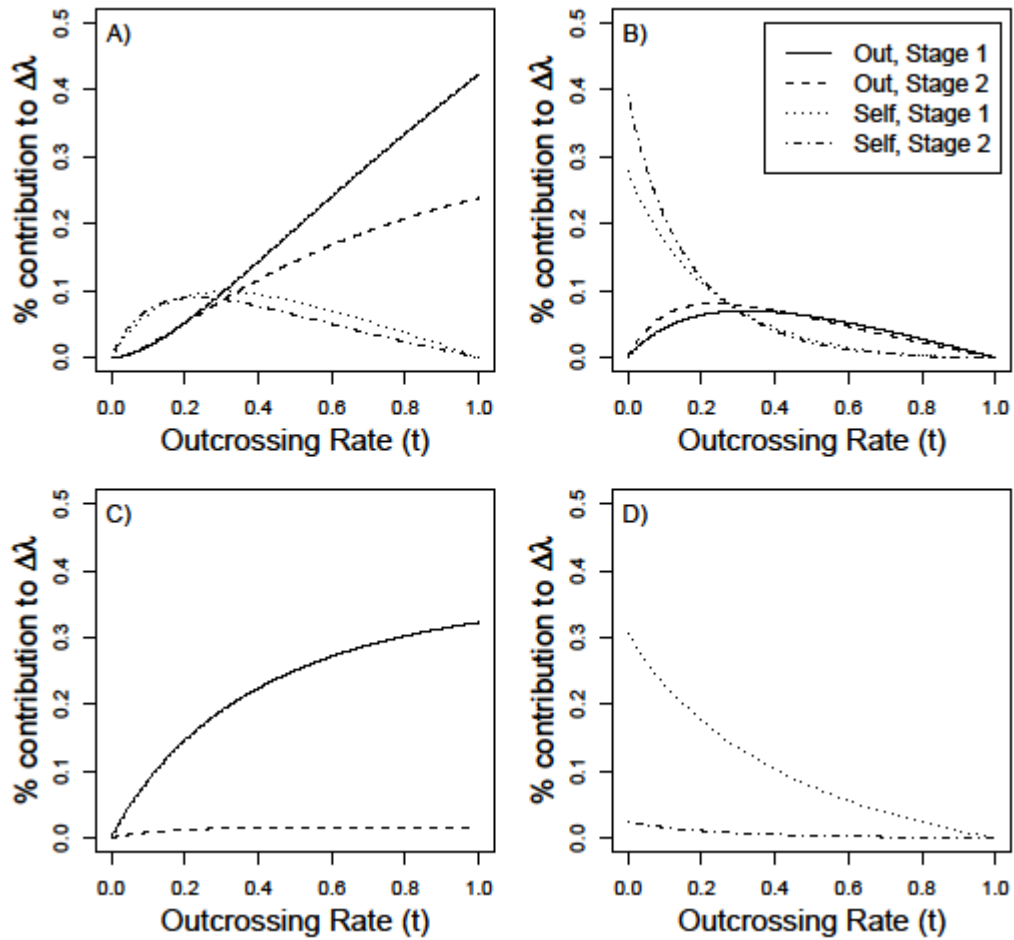

Figure 4. Sensitivities of λ to individual vital rates in the A) **SH**, B) **WL**, and C) **PL** competitive treatments and sensitivities of λ to inbreeding depression in those vital rates (on a negative scale) in those treatments (in order, E, F, G).



Appendix A. Results of the LTRE comparing population growth in the **WL** treatment to the **SH** treatment. The panels represent the contributions made by each stage producing A) outcrossed stage-1 plants, B) selfed stage-1 plants, C) outcrossed stage-2 plants, and D) selfed stage-2 plants.



Appendix B. Results of the LTRE comparing population growth in the **PL** treatment to the **SH** treatment. The panels represent the contributions made by each stage producing A) outcrossed stage-1 plants, B) selfed stage-1 plants, C) outcrossed stage-2 plants, and D) selfed stage-2 plants.

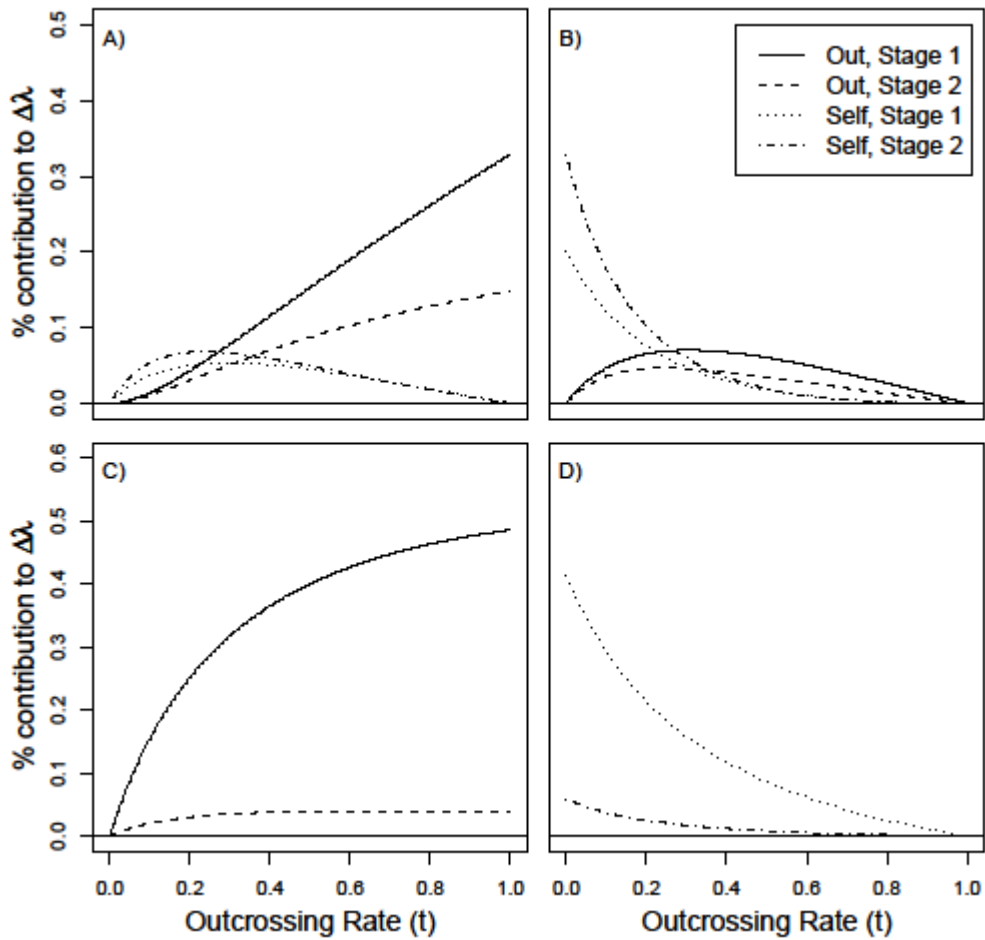

Appendix C. Results of the LTRE comparing population growth in the **PL** treatment to the **WL** treatment. The panels represent the contributions made by each stage producing A) outcrossed stage-1 plants, B) selfed stage-1 plants, C) outcrossed stage-2 plants, and D) selfed stage-2 plants.

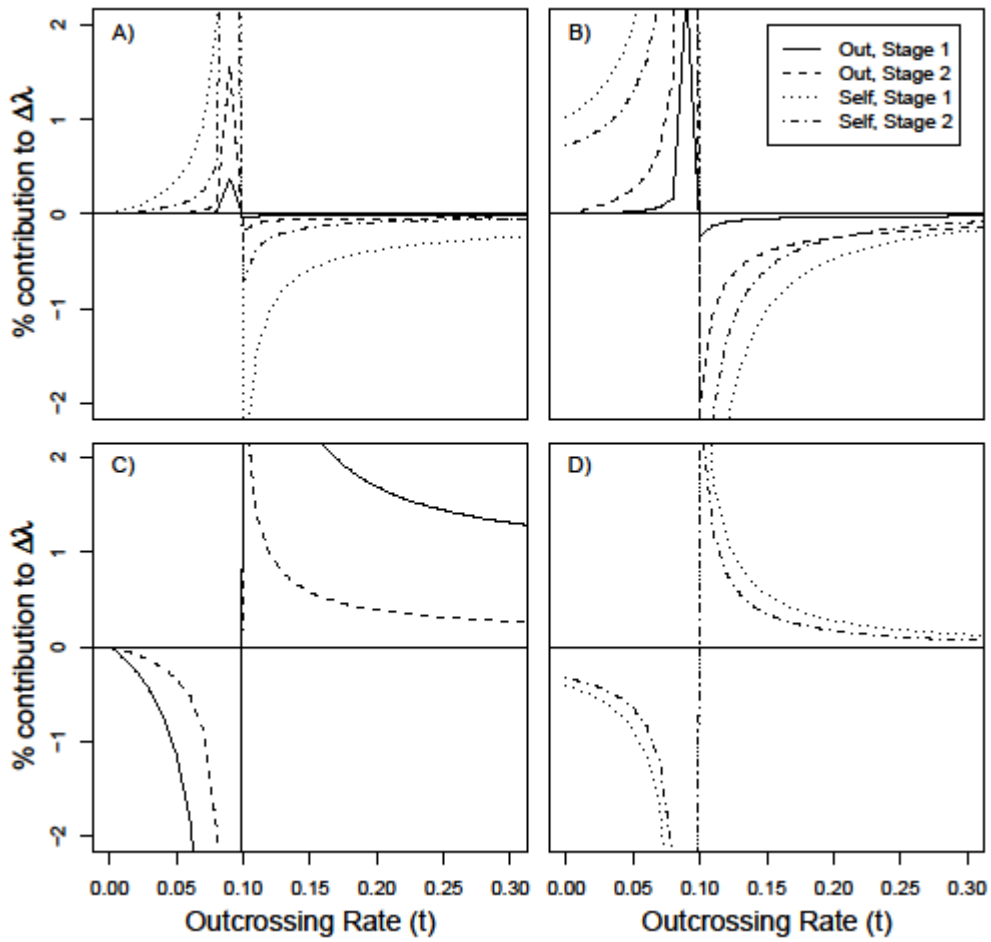

Appendix D. The stable stage distribution as a function of t for each treatment.

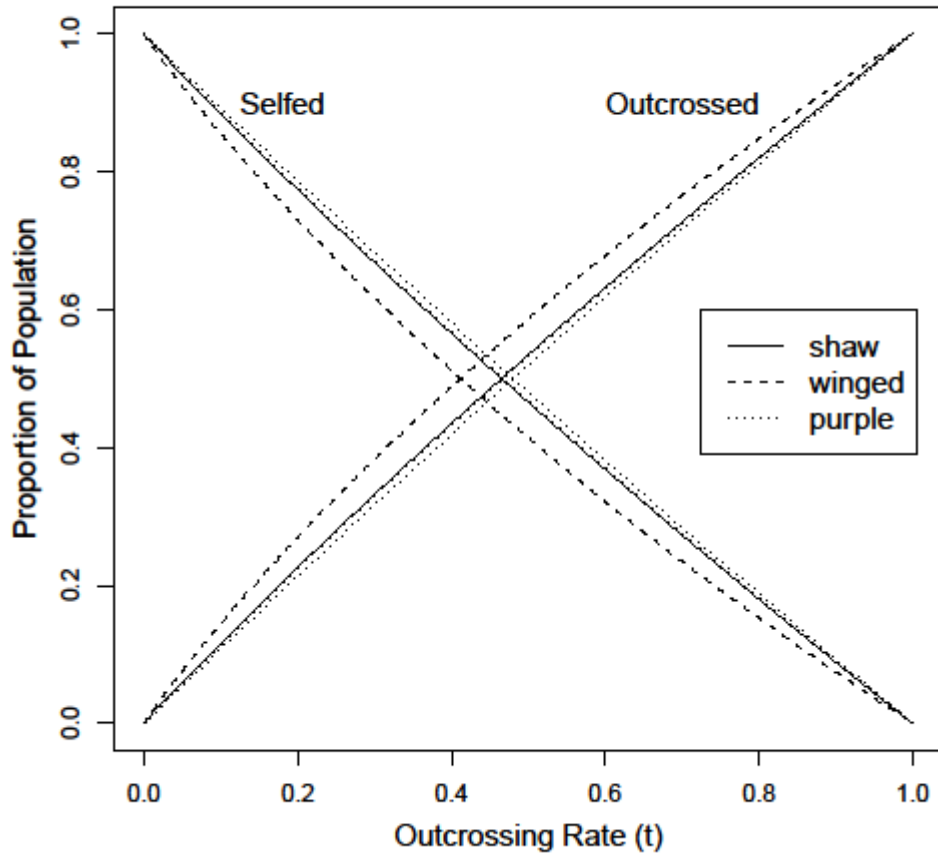

Chapter 4

A major demographic disturbance leads to the dominance of highly heterozygous clones
in *Mimulus ringens*

Abstract

Clonal plants often maintain moderate levels of genetic diversity for long periods, but major demographic disturbances have the potential to cause rapid shifts in genotypic diversity in such populations. Because clonal plants often exhibit spatial autocorrelation of genotypes, demographic disturbances that are restricted to certain areas within populations can affect these genotypes non-randomly due to spatial effects alone. Here, we examine single locus and multiple locus genetic diversity at five exon-priming, intron-crossing nuclear DNA markers before and after a major disturbance. Between 2006 and 2008, the population of *Mimulus ringens* at Shaw Nature Reserve suffered a severe reduction in census numbers, caused by consistently high water levels in an adjacent pond, which restricted available growing habitat. We find evidence that the disturbance dramatically altered genotypic diversity, but spatial explanations alone do not explain the full pattern. In addition, the results suggest an ongoing pattern of competition between genets, with highly heterozygous genotypes being favored.

Introduction

Highly clonal plants are often assumed to be less genetically diverse than sexually reproducing plants, the majority of clonal plant populations contain multiple clonal genotypes of fairly even distributions (*reviewed in* Ellstrand and Roose 1987). In fact, some populations maintain levels of genetic diversity comparable to their sexual counterparts (*e.g.*, *Clematis socialis*, Goertzen and Boyd 2007). However, sexual recombination does not occur during clonal reproduction, preventing the generation of new genotypes. Thus, genetic diversity in highly clonal populations has the potential to change rapidly during major demographic disturbances. By surveying genetic diversity in space at multiple times during such disturbances, it is possible to determine whether changes through time are explained by the disturbance *per se*, or if underlying processes, such as competition between clones are also at work.

Clonal propagation through rhizomes or stolons results in highly limited dispersal compared to the movement of seeds and creates the potential for spatially correlated distributions of genotypes within populations (*e.g.*, Hämmerli and Reusch 2003). Thus, environmental disturbances, which kill or severely reduce the fitness of individuals in a particular area, can dramatically and rapidly alter the diversity of genotypes in a population. In the case of such disturbances, these changes should be random with respect to particular genotypes and determined mainly by their spatial distributions and frequencies. Conversely, forces that affect fitness based on genome-wide homozygosity within individuals, such as inbreeding depression and heterosis may affect diversity by favoring more heterozygous genotypes.

Competition is a common antagonistic interaction in plants, and reduces both sexual and asexual reproduction. Additionally, clonal reproduction itself is often subject to inbreeding depression and heterosis. For instance, selfed *Mimulus ringens* produce fewer stolons than outcrossed plants (Griffin *et al.*, *in prep*) and plants from small, isolated populations of *Ranunculus reptans* produce fewer vegetative rosettes than those from larger populations (Willi *et al.* 2005). If these phenomena are actively occurring in a population, patterns of genotypic diversity should reflect excesses of heterozygous clones.

During the course of our research on the effects of inbreeding depression in the wetland perennial, *Mimulus ringens* (Phrymaceae), persisting high water levels in the adjacent pond led to severe restrictions in available habitat between 2006 and 2008. During this period, the population shrank to less than half its previous size. Our previous work shows that this species exhibits extensive inbreeding depression in both sexual and clonal reproduction. The population size reduction provided an opportunity to investigate the effects of such a disturbance on the genetic diversity of a clonal plant and to examine whether inbreeding depression might be a factor in driving genotypic diversity in this population.

In this study, we use recently developed molecular markers in the genus *Mimulus* to assess whether a rapid reduction in population size was accompanied by a reduction in genetic diversity in *M. ringens*. Specifically, we assess whether habitat loss due to flooding led to the loss of alleles or multilocus genotypes in the population, or significant shifts in observed levels of heterozygosity. Further, we investigate whether the loss of

available growing space alone explains the observed differences, or if there is evidence for competition between clonal genotypes and an effect of heterosis or inbreeding depression.

Methods and Materials

Study System

Mimulus ringens is a wetland perennial native to wetland habitats throughout much of eastern North America. It utilizes multiple modes of reproduction, maintaining a mixed mating system that includes both selfing and outcrossing, and reproducing clonally via belowground stolons (Karron *et al.* 1995). These stolons spread from their parent plant and emerge in the spring. Excavations suggest that the connections between stolon-derived plants and their parent plants quickly deteriorate, and these new clones function as physiologically independent ramets.

The study population is a large population located on the southern margin of a man-made pond and wetland area at the Missouri Botanical Garden's Shaw Nature Reserve (Eureka, MO). This population is part of an ongoing project to maintain high-diversity prairie and wetland communities in the reserve, and was founded approximately 20 years ago by scattering bulk-collected seeds from the surrounding counties (James Trager, *pers. comm.*). In addition to *M. ringens*, the wetland is dominated by *Polygonum*, *Hibiscus*, and several native grasses. The *M. ringens* population is bounded by the pond on its north and stands of *Chamaecrista fasciculata* and willow trees on its south. In 2006, we began sampling the population as part of a mating system assay and to generate seeds for experimental crosses. At that time, we estimate the population comprised over

3,000 adult plants. In 2007 and 2008, spring rains were greater than the previous years, and the water level in the pond stayed high much longer, greatly restricting the available habitat for *M. ringens* to grow. As a result, the population size declined precipitously during this period; a census in 2008 yielded 1,248 adult plants. Sexual recruitment was not detectable during this period. Although seeds germinated around adult *M. ringens* individuals, none were observed to survive to reproduce (Griffin, *unpublished data*). Furthermore, clonal reproduction is extensive in this population. Excavations of 50 adult plants in the population revealed that each plant produced from zero to six stoloniferous clones, averaging 2.3 per plant (Griffin *et al. in prep*)

Sample collection and DNA Isolation

In summer 2006, adult plants were haphazardly selected from a large population of *M. ringens* at Shaw Nature Reserve. We took leaf samples from each, and mapped their locations in x-, y- space using a compass and tape measure. In 2008, we again sampled haphazardly, but much more intensively throughout the now restricted population. The leaf tissue samples were dried in silica gel and stored until DNA isolation in each sampling.

DNA isolation was performed using both pre-packaged spin-column kits (Plant Genomic Mini Kit, Viogene, Inc.) and CTAB-chloroform extractions. CTAB-chloroform isolations were performed in seven steps. First, two leaves from sample were ground using tungsten carbide beads in a bead shaker. Second, the ground tissue was placed in a new microcentrifuge tube with 600 μ l 2X CTAB buffer and placed in a 65°C water bath for ~30 minutes. The CTAB buffer comprised 1.42 M NaCL, 100mM Tris

(tris(hydroxymethyl)aminomethane, pH=8.0), 20 mM EDTA (ethylenediaminetetraacetic acid, pH=8.0), 2% PVP-360 (polyvinylpyrrolidone, molecular weight=360,000), by mass to volume, 2% CTAB (hexadecyltrimethylammonium bromide) by mass to volume, and 5mM ascorbic acid. Third, samples were shaken for five minutes with 400µl of a 24:1 solution of chloroform to isoamyl alcohol. Fourth, samples were centrifuged, and the top layer was retained in a new tube. This was then mixed with an equal volume of 100% isopropyl alcohol and placed in the freezer for 20 minutes or overnight. Finally samples were centrifuged to form a white pellet, which was washed twice with 70% ethanol, allowed to dry, and re-suspended in 100µl sterile water or 1X TE buffer (Tris-EDTA, pH=8.0). Initial visualization of DNA on agarose gels revealed two bands of low molecular weight in CTAB-isolated DNA, suggesting RNA present in the samples. Leaving the tubes at 20°C for three to four days eliminated these, as naturally occurring RNases break down RNA molecules quickly. Samples were then stored at 4°C until later use.

Molecular Marker Selection

The recent emergence of *Mimulus guttatus*, a congener of *M. ringens*, as a model system in quantitative genetics has led to an expansion of the molecular resources available for use in the genus. Several thousand exon-priming, intron-crossing nuclear DNA markers (EPICs) have been designed for use in *M. guttatus*, as described elsewhere (Bouck and Vision 2007). These markers can be analyzed for polymorphism in fragment lengths, much like microsatellite loci, using florescent-labeled oligonucleotide primers. In 2006, we screened ~400 of these markers for successful amplification in *M. ringens*.

Approximately half of these produced visible PCR products on agarose after a single attempt at PCR amplification. Of these, we selected 112 that produced clear, single bands and amplified them in six randomly selected *M. ringens* individuals to assess their potential for fragment length polymorphism. From these, we found 13 markers that appeared to produce products of at least two different fragment sizes, indicating polymorphism in the locus. None of the markers screened were highly polymorphic, with most being monomorphic, or yielding at most two or three allele classes.

DNA Amplification and Genotype Assignment

We performed DNA amplification through the polymerase chain reaction (PCR) for seven EPIC loci in 95 individuals collected in 2006 and 191 individuals collected in 2008. Each reaction was 15 μ l total volume, which consisted of 3 μ l suspended DNA, 1X Flexi colorless PCR buffer (Promega, Inc.), 2mM MgCl₂, 0.4 mM each of the four nucleotides, dGTP, dCTP, dATP, dTTP, 0.75mM GoTAQ Flexi polymerase (Promega, Inc.), and 0.1 μ M each for the fluorescently-labeled forward primer and its unlabeled reverse counterpart. Oligonucleotide primers were labeled on the 5' end with either 6-FAM or HEX dyes. To perform the amplifications, we used a 40 cycle touchdown protocol, in which the initial annealing temperature was 62°C for all loci except EPIC 437, which used 58°C. The protocol included an initial three minute denaturation step, followed by ten touchdown cycles of 30s at 94°C, 30s at the annealing temperature, and a 45s extension step at 72°C. Over the first ten cycles, the annealing temperature was decreased to a common temperature of 52°C, which was then used as the annealing

temperature in 30 additional cycles. This protocol was followed by a 20 minute extension at 72°C.

All PCR products were visualized in dilutions of 1:100 to 1:300 using an ABI Sequence 3130 capillary DNA analysis machine, and individual genotypes were assigned manually using GeneMapper (Applied Biosystems, Inc.).

Data Analysis

Due to variation in PCR success rates among loci and individuals, we reduced the data for further analysis to 63 individuals from the 2006 collection and 138 from 2008, all of which yielded scorable genotypes at five loci, EPICs 437, 84, 455, 329, and 801. Our further analyses utilize these individuals and loci.

To assess whether the reduction in population size between the two sampling times also led to a reduction in genetic diversity, we made use of both single-locus and multiple-locus approaches. For each locus, we assessed allelic richness, A , the expected heterozygosity, H_E , the observed heterozygosity H_O , the deviation from Hardy-Weinberg equilibrium (HWE) expectations for random mating, f , and their averages across all loci. Values of f were tested for statistical significance with X^2 tests. To examine multilocus genetic diversity in each sampling period, we calculated the number of unique five-locus genotypes, G , the ratio of genotypes to individuals, G/N , the number of heterozygous loci, and the frequency of the most dominant genotype. We used t -tests to test for significant differences in the average number of heterozygous loci, and X^2 tests to test for differences in the G/N ratio and dominant genotype frequency.

We examined whether differences in genetic and genotypic diversity between 2006 and 2008 were entirely explainable by spatial correlations among genotypes. To do this, we partitioned the 2006 data into two groups. The first consisted of all individuals, but the second eliminated all those individuals that occurred in the area where floods prevented *M. ringens* from growing in 2008 (Figure 1). We performed the above analyses for these three groups, the 2006 individuals, the 2008 individuals, and the reduced subset from 2006. All analyses are performed in R v 2.9.0 (R Development Core Team 2009).

Results

Single Loci

None of the EPIC markers were highly polymorphic. EPIC 437 had the greatest number of allele classes, with three (Table 1). Each locus tended toward heterozygote excess in all samples; three markers significantly deviated from HWE expectations in both 2006 groups, and all markers did so in 2008. Furthermore, although estimates of H_E did not vary extensively, f values were much more negative at every locus in 2008 than 2006, sometimes double or even triple. The reduced 2006 group also exhibited greater deviations from HWE expectations, but the differences between these and the rest of the 2006 group were not as great as those between 2006 and 2008. Average f values declined from -0.302 in 2006 to -0.763 in 2008, and the reduced 2006 group fell in between with an estimate of -0.525.

Multiple Loci

Both 2006 samples were fairly genotypically diverse. In the 2006 group, we recovered 20 unique genotypes from 63 individuals, compared to nine genotypes from 138 individuals in 2008 (Table 2). The reduced subset from 2006 was also diverse, yielding eight genotypes from 34 individuals. These diversity estimates resulted in a significant reduction in the G/N ratio between 2006 and 2008. Furthermore, individual heterozygosity increased during that period, going from an average of 2.714 heterozygous to 4.217 between 2006 and 2008. Spatial correlation alone cannot explain this result, as the reduced 2006 subset yielded an average of 3.588, which differed significantly from both the sample years. Moreover, the frequency of the most common multilocus genotype climbed from 34.9% to 63.8% between 2006 and 2008, which is no doubt responsible in part for the dramatically reduced genotypic diversity in 2008.

Discussion

Though not as polymorphic as most microsatellite loci, the EPIC markers did reveal some interesting changes in genetic diversity that occurred in the population between 2006 and 2008, concurrent with a dramatic reduction in population census size. Several key features of these changes, when considered together, suggest that the *M. ringens* population at Shaw Nature Reserve is undergoing a period of intense competition between clonal genotypes, in which one highly heterozygous genotype is dominant. This not only adds to our knowledge of the importance of clonality in this species, but demonstrates how rapidly dramatic changes in genetic diversity can occur when clonal reproduction and major demographic disturbances coincide. Furthermore, it raises questions about restoration practices when clonal plants are involved.

Between 2006 and 2008, the *M. ringens* population experienced an extreme reduction in overall size, driven mostly by greater rainfall and the adjacent pond maintaining higher water levels over a longer period than in the previous year (Griffin, *pers. obs.*). Such a phenomenon has a definite spatial element, as plants nearer the pond were more likely to perish. Thus, spatial autocorrelation in genotypes could have caused the increase in the dominance of the most common genotype. Indeed, when plants in areas that were not inhabited in 2008 were removed from the 2006 collection, the most dominant genotype increased slightly in frequency, suggesting that it was more common in the stable area than throughout the whole population. Furthermore, the number of genotypes in the reduced 2006 set was dramatically lower, suggesting that flooding alone may have accounted for the loss of half of the total genotypes. However, autocorrelations in space alone cannot explain the observed pattern. The number of genotypes recovered in the stable area remained similar, despite much more extensive sampling in 2008, and the dominant genotype accounted for a much higher proportion of the population. Single locus patterns also reflect this, as the 2008 group exhibits much greater excesses in heterozygosity than the reduced 2006 group. Furthermore, there seems to be a trend toward more heterozygous loci dominating in competition, and the increase in the average individual heterozygosity is not due solely to the high abundance of the most common genotype. In each year, the dominant genotype is heterozygous at four loci, but in 2008, the three most common genotypes have four or five heterozygous loci.

These patterns could reflect inbreeding depression acting in the population. This population exhibits inbreeding depression in important fitness components, such as the

number of stolons, and competition with other plants also reduces its fitness (Griffin *et al. in prep*), creating the potential for dynamics of competitive dominance and suppression to occur among genotypes. However, it is impossible in this case to distinguish between inbreeding depression and the signatures of the populations founding history. The *M. ringens* populations at Shaw Nature Reserve are approximately 20 years old, and were founded by bulk collecting seed from plants in surrounding counties (James Trager, *pers. comm.*). This practice, while common, can have profound impacts on the genetic makeup of the resulting population, if the source populations exhibit significant between-population genetic structure (Templeton *et al.* 2007). *Mimulus ringens* is most often found in small populations in Missouri (Griffin, *pers. obs.*), and populations are thought to be founded by a few individuals in most cases (J. Karron, R. Mitchell, D. Carr, *pers. comm.*). Thus, the original founding of the Shaw population might have caused significant admixture from previously genetically differentiated populations. This founding event may have caused an interesting interaction between the dynamics of between-population matings, and common dynamics of genets in clonal plants.

Clonal plants display varying patterns of genetic diversity through time, as the dynamics of seed recruitment, and the growth and death of genets interact to determine how the number of genetic individuals changes in a population (*reviewed in* Eriksson 1993). One common pattern is that new genotypes are recruited only in the first few years after a population's founding and then decline gradually until an equilibrium is reached, as has been shown in *Solidago canadensis* (Hartnett and Bazzaz 1985). If the initial admixture in a founding event also results in heterosis, the highly heterozygous

genotypes created in the original flush of sexual reproduction would be those most likely to persist and dominate throughout the population's history. Examples of such increases in the clonal fitness of hybrids are common at the between-species level (*e.g.*, *Carpobrotus spp.*, Villa and D'Antonio 1998) and at the between-population level (*e.g.*, *Leavenworthia alabamica*, Busch 2006). Furthermore clonal propagation has been shown to preserve hybrid genotypes. In the most extreme case, Kameyama and Ohara (2006) concluded that hybrid genotypes in *Utricularia australis f. australis*, which is a sterile F1 hybrid of two *Utricularia* species, are entirely maintained by clonal reproduction.

Conclusions

We conclude that the rapid reduction in population size associated with high water levels in this population of *M. ringens* was accompanied by marked reductions in genotypic diversity, resulting in the dominance by one highly heterozygous genotype and a trend toward increased individual heterozygosity in general. Moreover, the spatial distribution of genets before the event cannot explain this pattern entirely. The success of very heterozygous genotypes in the remaining wetland habitat, and the dramatic increase in frequency of the dominant genotype are most likely the result of competition between clones exhibiting inbreeding depression or heterosis. More work is necessary to determine which of these is acting in this population. In particular, assays of the genetic diversity of populations in the surrounding area, including potential parental populations, will help ascertain whether clonal propagation at Shaw Nature Reserve is preserving

unusual levels of heterozygosity for this species and whether populations exhibit significant genetic structure between each other.

Acknowledgments

We would like to thank J. Willis for selflessly sharing his laboratory resources and providing EPIC primers for screening, Y-W. Lee for her patient advice and assistance. We also thank a number of people who provided help during mapping of the population, including M. Johnson, M. Schutzenhofer, and A. David, and B. Li and M. Caster, who assisted with lab work. In addition, we must acknowledge James Trager of Shaw Nature Reserve and J. Karron and R. Mitchell, for useful discussions about the genetics of *M. ringens*. Finally, B. Schaal, J. Chase, J. Orrock, J. Cheverud, and K. Olsen all provided useful suggestions during the writing of this study, E. Frawley, for much support. This work was funded by a Mickey Scudder Scholarship from the Webster Groves Nature Study Society, and an NSF DDIG (#0807879) awarded to NWG, ART, and TMK.

Works Cited

- Bouck, A., and T. Vision. 2007. The molecular ecologist's guide to expressed sequence tags. *Molecular Ecology* 16:907-924.
- Busch, J. W. 2006. Heterosis in an isolated, effectively small, and self-fertilizing population of the flowering plant *Leavenworthia alabamica*. *Evolution* 60:184-191.
- Ellstrand, N. C., and M. L. Roose. 1987. Patterns of genotypic diversity in clonal species. *American Journal of Botany* 74:123-131.

- Eriksson, O. 1993. Dynamics of genets in clonal plants. *Trends in Ecology and Evolution* 8:313-316.
- Goertzen, L. R., and R. S. Boyd. 2007. Genetic diversity and clonality in the federally endangered plant *Clematis socialis* Kral (Ranunculaceae). *The Journal of the Torrey Botanical Society* 134:433-440.
- Hämmerli, A., and T. B. H. Reusch. 2003. Genetic neighborhood of clone structures in eelgrass meadows quantified by spatial autocorrelation of microsatellite markers. *Heredity* 91:448-455.
- Hartnett, D. C., and F. A. Bazzaz. 1985. The integration of neighbourhood effects by clonal genets in *Solidago canadensis*. *Journal of Ecology* 73:415-427.
- Kameyama, Y., and M. Ohara. 2006. Genetic structure in aquatic bladderworts: clonal propagation and hybrid perpetuation. *Annals of Botany* 98:1017-1024.
- Karron, J. D., Thumser, N. N., Tucker, R., and A. J. Hessenauer. 1995. The influence of population density on outcrossing rates in *Mimulus ringens*. *Heredity* 75:175-180.
- R Development Core Team. 2009. R: A language and environment for statistical computing., version 2.9.0. R Foundation for Statistical Computing, Vienna, Austria.
- Templeton, A. R., Neuwald, J. L., Brazael, H., and R. J. Robertson. 2007. Restoring Demographic processes in translocated populations: the case of collared lizards in the Missouri Ozarks using prescribed forest fires. *Israel Journal of Ecology and Evolution* 53:179-196.

Vila, M., and C. M. D'Antonio. 1998. Hybrid vigor for clonal growth in *Carpobrotus* (Aizoaceae) in coastal California. *Ecological Applications* 8:1196-1205.

Willi, Y., Van Buskirk, J., and M. Fischer. 2005. A threefold genetic Allee effect: population size affects cross-compatibility, inbreeding depression and drift load in the self-incompatible *Ranunculus reptans*. *Genetics* 169:2255-2265.

Table 1. Summary of single locus estimates of genetic diversity in each collecting period. For each locus, allelic richness, A , expected heterozygosity, HE , observed heterozygosity, HO , and the deviation from Hardy-Weinberg expectations of heterozygosity under random mating, f , are presented.

		EPIC	EPIC	EPIC	EPIC	EPIC	Mean
		437	84	455	329	801	
	A	3	2	2	2	2	2.2
2006	H_E	0.484	0.485	0.133	0.459	0.464	0.405
(N=63)	H_O	0.651	0.698	0.143	0.587	0.635	0.543
	f	-0.344	-0.441***	-0.077	-0.279*	-0.370**	-0.302
	A	3	2	2	2	2	2.2
2006†	H_E	0.500	0.493	0.208	0.484	0.479	0.433
(N=34)	H_O	0.794	0.824	0.235	0.765	0.794	0.682
	f	-0.587	-0.670***	-0.133	-0.579**	-0.659****	-0.525
	A	3	2	2	2	2	2.2
2008	H_e	0.546	0.500	0.268	0.499	0.500	0.463
(N=138)	H_o	0.971	1.000	0.319	0.949	0.971	0.842
	f	-0.780****	-1.000****	-0.190*	-0.901****	-0.944****	-0.763

†, signifies the reduced 2006 sampling subset

****, $p < 0.0001$

***, $p < 0.001$

** , $p < 0.01$

* , $p < 0.05$

Table 2. Summary of multi-locus estimates of genetic diversity. The number of samples, N , number of detected multi-locus genotypes, G , their ratio, G/N , number of heterozygous loci within individuals, and the frequency of the most common genotype are all presented.

	Year		
	2006	2006†	2008
N	63	34	138
G	20	8	9
G/N	0.317 ^a	0.317 ^a	0.065 ^b
Average number of heterozygous loci	2.714 ^a	3.588 ^b	4.217 ^c
Frequency of the dominant genotype	34.9% ^a	47.1% ^{ab}	63.8% ^b

Superscripts, a, b and c denote significant differences between samples

†, signifies the reduced 2006 sampling subset

Figure 1. Map of sampled individuals in 2006. Open circles show plants in habitat made unavailable by flooding in 2008. Dark circles depict individuals in habitat that remained. The dashed line indicates the approximate zone above which habitat was not available.

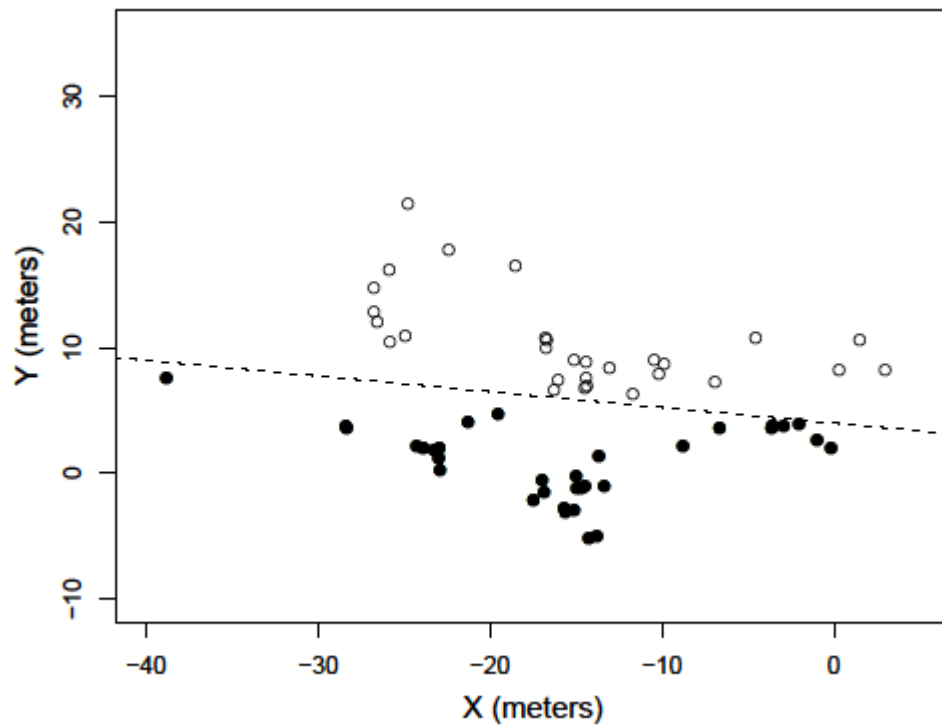

Chapter 5

Conclusion and Future Directions

From the four studies included in this work, we draw several conclusions regarding the importance of interactions between interspecific competition and inbreeding in general and the population level effects of inbreeding depression for *M. ringens* specifically. First, *M. ringens* at Shaw Nature Reserve suffers inbreeding depression throughout its lifecycle, and the magnitude of that inbreeding depression is sensitive to variation in interspecific competition. Second, inbreeding depression in *M. ringens* varies with the density of conspecific plants, and the presence of interspecific competitors can alter that relationship. Third, variation in inbreeding depression throughout the lifecycle and between competitive environments influences the degree to which outcrossing is beneficial for *M. ringens* and leads to different implications for mating system evolution in different competitive environments. Finally, molecular evidence suggests that clonal propagation and competition between clones are prevalent in *M. ringens* at Shaw Nature Reserve, and inbreeding depression and heterosis may play a part in determining competitive outcomes between clones.

The experiment described in Chapter 1 clearly shows that competition affects inbreeding depression for both biomass production and clonal reproduction, but does not support the stress hypothesis. Competition with purple loosestrife has dramatic fitness consequences, causing the greatest reductions in both traits, but consistently leads to the lowest estimates of inbreeding depression. The results do not necessarily support the variance hypothesis, either, as reductions in the variance do not necessarily accompany

changes in the magnitude of inbreeding depression. Furthermore, in competition with purple loosestrife, these traits tend toward exhibiting outbreeding depression. This result is also reflected in the results of the greenhouse experiment in chapter 2, as significant outbreeding depression occurs at high plant densities when purple loosestrife is present. In both cases, purple loosestrife had the most profound effects on overall fitness, suggesting that *M. ringens* is poorly adapted to competition with the invader. Taken together, these results present tentative support for the model of inbreeding depression described by Ronce *et al.* (2009). However, this model raises several questions about the genetic basis of inbreeding depression and implies a particular model of natural selection acting on individual traits. Further work is needed to evaluate the assumptions of the model. Of particular use would be investigations of the genetic architectures of particular traits, with respect to fitness, under different environmental conditions, and in combination with estimates of inbreeding depression.

This work also presents a compelling case for including interspecific competition in models of mating system evolution. The conclusions of Willi *et al.* (2007) are premature given the paucity of experimental investigations into the effects of competition on inbreeding depression. Here, we show that variation in interspecific competition not only influences inbreeding depression in *M. ringens*, but also changes the relationship between inbreeding depression and intraspecific competition. This suggests that the failure to detect consistent effects of interspecific competition may be in part due to the failure of most studies to consider both modes of competition at once. Furthermore, our studies show that competition can alter the relationship between the sensitivity of

population growth to inbreeding depression in key vital rates. In each treatment, these sensitivities decreased monotonically with outcrossing, but the rates of their decline varied. This suggests that competition can extend or restrict the range of outcrossing rates over which inbreeding depression is important to fitness and implies an important role for competition in influencing the evolution of mating systems. Future studies should examine this phenomenon in other species, under a variety of competitive environments, to assess whether this is a general phenomenon or an idiosyncrasy of interactions between these three species.

We have also demonstrated a new set of potential impacts of invasive species in an evolutionary sense. By reducing inbreeding depression in several important traits and, ultimately, cumulative fitness, purple loosestrife dramatically decreased the benefits of outcrossing in *M. ringens*. This suggests that invasive species may have the potential to disrupt the selective regimes that maintain mixed mating systems in flowering plants. In some cases, selfing may actually be selectively advantageous, creating the potential for competition with invasives to alter the genetic makeup of native plant populations. Again, our results are specific to these three species and more studies with different species are necessary to determine whether this is a consistent pattern. Furthermore, more work in this system is required to assess the degree to which these effects occur in natural populations. Our results all come from controlled experiments in a common garden or greenhouse, and cannot determine the effects of other important factors, such as the density of interspecific competitors or variation in the effects of competition in different habitat types. In addition, surveys of naturally occurring *M. ringens* populations

with different histories with purple loosestrife would be required to assess whether such competition is leading to changes in inbreeding depression or outcrossing rates in the wild.

Finally, both the demographic model and patterns of genetic diversity within the population at Shaw Nature Reserve indicate that clonal reproduction is an important component of fitness in *M. ringens*, and that competition between clones is an important driver of within-population genetic variation. The fact that the dominant genotypes tended to be extremely heterozygous at Shaw Nature Reserve suggests that inbreeding depression, heterosis, or both, are driving the dynamics of this intraspecific competition. If heterosis is responsible, it is likely due to admixture caused by the initial founding of the population at the nature reserve. *Mimulus ringens* populations tend to be small in Missouri, and could be subject to fixing deleterious alleles due to genetic drift. In this case, matings between members of different origin populations would lead to heterosis, and highly heterozygous genotypes would be favored. To determine if this is the case, a first step would be to survey genetic diversity in the founding populations. However, as is often the case, adequate records were not kept, making it impossible to positively identify all these sources of seed.

Works Cited

- Armbruster, P., and D. H. Reed. 2005. Inbreeding depression in benign and stressful environments. *Heredity* 95:235-242.
- Bell, J. M., J. D. Karron, and R. J. Mitchell. 2005. Interspecific competition for pollination lowers seed production and outcrossing in *Mimulus ringens*. *Ecology* 86:762-771.
- Bijlsma, R., J. Bundgaard, and AC Boerema. 2000. Does inbreeding affect the extinction risk of small populations?: predictions from *Drosophila*. *Journal of Evolutionary Biology* 13:502-514.
- Bijlsma, R., J. Bundgaard, and W. F. Van Putten. 1999. Environmental dependence of inbreeding depression and purging in *Drosophila melanogaster*. *Journal of Evolutionary Biology* 12:1125-1137.
- Carr, D. E., J. F. Murphy, and M. D. Eubanks. 2003. The susceptibility and response of inbred and outbred *Mimulus guttatus* to infection by Cucumber mosaic virus. *Evolutionary Ecology* 17:85-103.
- Casper, B. B., and R. B. Jackson. 1997. Plant Competition Underground. *Annual Review of Ecology and Systematics* 28:545-570.
- Charlesworth, D., and B. Charlesworth. 1987. Inbreeding Depression and its Evolutionary Consequences. *Annual Review of Ecology and Systematics* 18:237-268.
- Cheptou, P-O. 2006. The Ecology of inbreeding depression. *Heredity* 96:110.

- Cheptou, P. O., A. Berger, A. Blanchard, C. Collin, and J. Escarre. 2000a. The effect of drought stress on inbreeding depression in four populations of the Mediterranean outcrossing plant *Crepis sancta* (Asteraceae). *Heredity* 85:294-302.
- Cheptou, P. O., E. Imbert, J. Lepart, and J. Escarre. 2000b. Effects of competition on lifetime estimates of inbreeding depression in the outcrossing plant *Crepis sancta* (Asteraceae). *Journal of Evolutionary Biology* 13:522-531.
- Darwin, C. 1876. The effect of cross and self fertilization in the vegetable kingdom. John Murray, London.
- Gurevitch, J., D. R. Taub, T. C. Morton, P. L. Gomez, and I. N. Wang. 1996. Competition and genetic background in a rapid-cycling cultivar of *Brassica rapa* (Brassicaceae). *American Journal of Botany* 83:932-938.
- Ivey, C. T., Carr, D. E., and M. D. Eubanks. 2004. Effects of inbreeding in *Mimimulus guttatus* on tolerance to herbivory in natural environments. *Ecology* 85:567-574.
- Ronce, O., Shaw, F. H., Rousset, F., and R. G. Shaw. 2010. Is inbreeding depression lower in maladapted populations? a quantitative genetics model. *Evolution* 63:1807-1819.
- Steets, J. A., Knight, T. M., and T-L. Ashman. 2007. The interactive effects of herbivory and mixed mating for the population dynamics of *Impatiens capensis*. *American Naturalist* 170:113-127.
- Templeton, A. R. 2006, *Population Genetics and Microevolutionary Theory*, John Wiley and Sons, Inc.

- Templeton, A. R., and B. Read. 1983. The elimination of inbreeding depression in a captive herd of Speke's gazelle, Pages 241-262 in C. M. Schonewald-Cox, S. M. Chambers, B. MacBryde, and W. L. Thomas, eds. Genetics and conservation: a reference for managing wild animal and plant populations. Menlo Park, California, Benjamin/Cummings Publishing Company, Inc.
- Thompson, D. G., R. L. Stuckey, and E. B. Thompson. 1987. Spread, impact, and control of purple loosestrife (*Lythrum salicaria*) in North American wetland, Pages 55, Fish and Wildlife Research 2. Jamestown, ND: Northern Prairie Wildlife Research Center, US Fish and Wildlife Service.
- Waller, D. M., J. Dole, and A. J. Bersch. 2008. Effects of stress and phenotypic variation on inbreeding depression in *Brassica rapa*. *Evolution* 62:917-931.
- Willi, Y., S. Dietrich, M. van Kleunen, and M. Fischer. 2007. Inter-specific competitive stress does not affect the magnitude of inbreeding depression. *Evolutionary Ecology Research* 9:959-974.
- Wolfe, L. M. 1993. Inbreeding depression in *Hydrophyllum appendiculatum*: role of maternal effects, crowding and parental mating history. *Evolution* 47:374-386.