

World Maritime University

The Maritime Commons: Digital Repository of the World Maritime University

World Maritime University Dissertations

Dissertations

1985

Diesel engine room simulator for marine engineering education and training in Morocco

Abderrafia Bennis
WMU

Follow this and additional works at: https://commons.wmu.se/all_dissertations

Recommended Citation

Bennis, Abderrafia, "Diesel engine room simulator for marine engineering education and training in Morocco" (1985). *World Maritime University Dissertations*. 1072.

https://commons.wmu.se/all_dissertations/1072

This Dissertation is brought to you courtesy of Maritime Commons. Open Access items may be downloaded for non-commercial, fair use academic purposes. No items may be hosted on another server or web site without express written permission from the World Maritime University. For more information, please contact library@wmu.se.

WORLD MARITIME UNIVERSITY
MALMÖ, SWEDEN

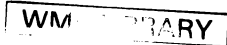

DIESEL ENGINE ROOM SIMULATOR FOR
MARINE ENGINEERING EDUCATION
AND TRAINING IN MOROCCO

by
BENNIS, Abderrafia
(Morocco)

A paper submitted to the Faculty of the World
Maritime University in partial satisfaction
of the requirements of the degree of Master
of Sciences (M.Sc.) in Maritime Education
(Engineering) Course

Bennis
MET (E)
1983

May 1985

The contents of this paper reflect my own
personal views and are not necessarily
endorsed by the University.

May 1985

Paper directed by:
Charles E. Mathieu
Professor, World Maritime University

Approved by:

Charles E. Mathieu

TABLE OF CONTENTS

Chapter	Page
Abstract	i
Preface	ii
INTRODUCTION	1
1 MARITIME EDUCATION AND TRAINING	5
1.1 General Education System	5
1.2 Maritime Secondary Schools	6
1.3 Marine Officers	7
1.3.1 Historical Background	7
1.3.2 Training System	9
1.3.3 Maritime Institute	16
1.4 Practical Training Aids for Marine Engineers	16
1.5 The International Convention on STCW 1978	19
2 DIESEL ENGINE ROOM SIMULATOR	28
2.1 Introduction	28
2.2 Purpose	29
2.3 Advantages	30
2.4 Simulation Process by Computer Techniques	39
2.5 Description	44
2.6 IMO's Work on Marine Simulators	49
3 SIMULATOR TRAINING COURSE	51
3.1 Objectives	51
3.2 Programmes	52
3.3 Implementation	56
4 CONCLUSION	59

ABSTRACT

This paper discusses the use of a diesel engine room simulator as a training aid for the education and training of marine engineers at the Higher Institute for Maritime Studies in Casablanca, Morocco. This facility can be used in the training of marine engineers to master the operational skills in basic engine room operation, ship automation, control engineering, trouble-shooting diagnostics, power plant optimization, fuel economy, energy saving and maintenance planning to lower operational costs. The main sound arguments for using this simulator are: lowered training costs, time-saving in achieving operational experience, more effective training, repeatability conditions and safer training. However, the simulator characteristics, the training programmes, the instructor experience and the number of course participants during an exercise affect the simulator training effectiveness. The main conclusion is that such a simulator can provide a positive and valuable contribution to marine engineers' training. Nevertheless, I will not pretend that this simulator is a complete substitute for sea experience; but I will claim that it is a most valuable supplement to, and preparation for sea experience. The simulated machinery proposed is based on the parameters of a slow-speed diesel main engine, type SULZER, six cylinders, two strokes, for a bulk carrier. The simulator to be chosen should have a sufficient built-in flexibility in the program and in the simulator potential to adapt training to the needs.

PREFACE

It is a requirement of the degree of Master of Science (M.Sc.) in Maritime Education (Engineering) that students enrolled for the two year course in this field, prepare a thesis on some aspect of their country's needs in the maritime field. I have chosen to critically examine the use of a diesel engine room simulator as a training aid for education and training of marine engineers at the Higher Institute for Maritime Studies in Casablanca, Morocco. This facility can be used in training of those marine engineers who are operating the ships and those who will operate the ships.

Consequently, based on my operating experience as chief engineer, and upon experience gained while following the two year course at the World Maritime University, which includes field trips to many maritime training institutions throughout the world, I would like to express my views and give my opinion and suggestions on the subject. In trying to examine this subject, I decided that the writing sequence of the content of my thesis will be the answers to the following questions: Who needs to be trained? What for ? By what means ? and how ? The main aspects of each question are explained in the following chapters.

Chapter 1 deals with maritime education and training in Morocco. Consequently when utilizing a diesel engine room simulator, the entry qualification of the trainees has to be taken into consideration. The training system and the means used to ensure proper maritime training are described. There are three main practical training aids for marine engineers, two of them laboratory workshops and training vessels are mentioned, while the third, which is needed, is the diesel engine room simulator, as described in detail in the next chapter. The world of shipping is increasingly having to operate within a voluntary framework of international codes, conventions and other instruments developed through the United Nations and its specialized agencies. However, the convention which has a great relevance to maritime training is the STCW 1978 Convention of the International Maritime Organization. A brief review of this convention, with more details as to training of marine engineers, is discussed also. The IMO assistance to Morocco in the matter of training is mentioned.

Chapter 2 discusses the diesel engine room simulator. The maritime training institutions all over the world use such simulators, and have discovered many special merits. Consequently this chapter points out the main advantages of using this simulator in training, illustrated with some examples. The use of mathematical models in marine simulation has given an added dimension to further development in diesel simulators. This Chapter also gives a general insight into the process of simulation of diesel plant simulator by computer techniques. The description, I shall emphasize in this Chapter, also is the third question of those mentioned earlier. The most popular diesel engine room simulators nowadays are described.

Chapter 3 deals with the simulator training course. Two general programmes are given in order to achieve the objectives of the training. Further details are pointed out for the execution of the simulator training course. The task, responsibility and qualification of the instructors are discussed. In general the main elements affecting the simulator training course effectiveness are mentioned.

Chapter 4 contains conclusions.

The suggestions made are an academic exercise, trying to apply principles learned to the real world situation. It is not claimed that the suggestions and recommendations provide a perfect solution, however, they could serve as a valuable guideline in the years ahead, particularly in the event that a decision is taken to install a simulator.

In writing this thesis I wish to express my sincere gratitude to my mother Aziza, my sisters, brothers and all the family for the support given to me whilst here in Malmö, Sweden. I am most deeply grateful to Monsieur Chaguer Ahmed, Director of the Higher Institute for Maritime Studies in Casablanca (ISEM) for the encouragement given to me before and during the studies undertaken at the World Maritime University, Sweden. I do wish to acknowledge with warm thanks the valuable assistance received from Visiting Professor Jerzy Listewnik from the University of Szczecin, Poland.

My thanks also go to NORCONTROL, which company was kind enough to furnish data and drawings for use in this thesis. Last, but not least, my thanks go to all professors and the staff of the World Maritime University for the invaluable assistance received during the two year course.

D

D

→

)

INTRODUCTION

The Kingdom of Morocco is situated in the extreme north west of Africa, between 23° and $35^{\circ}20'$ northern latitude, 16° and 1.5° western longitude. Morocco occupies the westernmost portion of North Africa with an area of 458,730 sq.km. It has a long coastline on the shores of the Atlantic Ocean and, east of the Strait of Gibraltar, on the Mediterranean Sea facing southern Spain. Morocco's eastern frontier is with Algeria and borders Mauritania to the east and south. It has approximately a population of twenty four million.

The strategic geographical position of Morocco between the Mediterranean Sea and the Atlantic Ocean makes Morocco a maritime state with a coastline stretching over about 3,400 km. The Moroccan coastline is endowed with picturesque sites and ports, much frequented by vessels from all over the world. Morocco depends on maritime transport for most of its economic activities. As a matter of fact 98% of the external trade is carried by sea. This therefore shows the extreme necessity for Morocco to establish a very highly developed port infrastructure of its own, and a national merchant fleet adjusted to a diverse variety of traffic which corresponds to its external trade.

Enormous concrete efforts have been made by Morocco to have a very developed port infrastructure comprising eight ports of national importance: Casablanca, Mohammedia, Tangier, Kenitra, Agadir, Safi, Nador, Jorf Lasfar; and ten others of a regional character: Al Hoceima, Larache, Essaouira, El Jadida, M'diq, Jebha, Ifni, Tan Tan, Tarfaya, Laayoun (see Figure 1).

The evolution of the national merchant fleet is one of the main elements to consider in the development of the Moroccan economy, bearing in mind that the economic expansion plan of any maritime state is built upon the transportation of goods at sea. In the 1960's, Morocco had not yet developed a well-established merchant fleet of its own, despite its external trade and geographical position. The development and setting up of a good structure for a Moroccan fleet actually gained momentum in the early 1970's and a concrete plan was established in

the five year development plan between 1973-77. In fact, until 1970, the national merchant fleet consisted of only eight units without specialization. The above plan, which permitted the development of the Moroccan national fleet, dates back to 1973 with the promulgation of an act from the Government (DAHIR) on a maritime investment code. The Moroccan merchant fleet, which possessed twenty ships in 1973, now owns sixty-three ships with specialization. The Government has decided to further develop its merchant fleet and the present development plan, 1981-85, makes provision for the financing of several additional new ships. The present national merchant fleet comprises modern vessels, equipped with modern technological equipment. Presently all ships of the merchant fleet are equipped with diesel engine plans for the propulsion. In order that this fleet can operate safely and efficiently, maritime education and training of national seafarers is most important and is an absolute requirement. Therefore the Ministry of Maritime Fisheries and Merchant Marine gives the highest priority to the training of marine officers.

Over the past few years there has been a change in the operation of merchant ships' propulsion plants worldwide. Modern propulsion installations are becoming more and more complex. Diesel engine plants often operate under conditions close to their technical limits. Automatic control and monitoring systems are widely used nowadays. The increasing technical complexity of daily engine room routine by the comprehensive use of engine room automation, and the introduction of periodically unmanned engine rooms, leads to less opportunities for operational training on board. Increasing fuel oil prices make the economic consequences of improper operation more significant. The increasing fuel oil deterioration requires better bunker treatment and better maintenance planning when it is known that increased fuel consumption causes higher operating costs. The increasing thermal load on the main diesel engine gives a smaller margin of safe operation. The increasing international shipping market competition, combined with higher fuel oil cost, gives smaller margins between profit and loss. The changing structure of shipping, combined with an over-capacity of all types of vessel with a large number of laid-up tonnages, has produced fierce competition and with it a general depression of

freight rates. This has made costs a crucial factor in the operation of ships. In their everlasting effort to maintain a competitive position in sea transport, shipowners always attempt to increase the overall efficiency of their ships.

"Not all marine casualties are prevented or caused from the ship's bridge. Some result from human error or mechanical failure in the engine room. For the area within 50 miles of the British Isles between the years 1974 to 1978, Lloyds List have reported 851 cases of engine trouble, resulting in four groundings. They have also reported 232 cases of engine failure, resulting in three groundings, five collisions, one sinking, six collisions with jetties and two collisions with buoys."²

All these parameters increase demand for skilled marine engineers in order to achieve safety, reliability and economy, which are key words in the running of any ship and any engine room today. There is thus a conflict between modern engine room requirements and training of marine engineers for their coming duties in any modern and complex diesel engine propulsion system. What is required from a marine engineer officer in a changing technological world? The marine engineer officer should have to demonstrate his practical as well as theoretical abilities, but according to the rapid evolution of engine room technology, practical and experience aspects of the training must use the most up-to-date techniques, including the diesel engine room simulators as a training aid. In detail, the engineer should learn in a modern and fast, as well as an efficient way, to master the following operational skills:

- a ship automation
- b control engineering
- c trouble-shooting diagnostics
- d power plant optimization - fuel economy, energy saving and maintenance planning to lower operational costs

² I.C. Millar and J. Reynolds, p.34, Practice of Marine Education and Training in Europe and the new IMCO Requirements in Amsterdam, 5-6 June 1980.

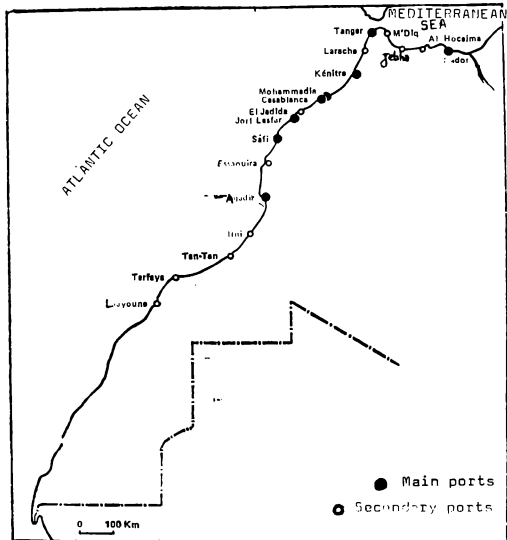

CHAPTER 1

MARITIME EDUCATION AND TRAINING

"Training is imparting so much knowledge to a student that he is well equipped for the task of which he has to fulfil, and moreover has such basic knowledge that he can follow the development in the maritime industry."²

1.1 General education system

The pivotal role that education plays in the social, cultural and economic development of a nation cannot be over-emphasized. In a developing country manpower constitutes a key resource which has to be developed fully, in order to assure its fullest and most productive utilization in all aspects of nation building. Education is also the main instrument for ensuring the effective participation of the masses of the people in productive life. As a direct investment in human capital, education is the principal instrument for providing the overall levels of the efficiency, productivity, technological and managerial performance of the labour force. Education thus is a major form of investment.

The educational organization system in Morocco comprises a set of common educational institutions which are connected with one another in respect of their function and content. Primary education is common, free and compulsory. It is the lowest level, commences at the age of six and consists of six years of schooling. Secondary education covers seven years, of which four years are common and three years may be spent in one of the following branches: science, mathematics, math-technical, technical, literature. On completion of the secondary education, students take a regional examination and successful students obtain a baccalaureat in their respective branches. The baccalaureat

² Captain P. van Driest, Principal Hoger Zeevaartschool Amsterdam, Seminar on the practice of marine education and training in Europe and new IMCO requirements.

provides the possibility to pursue higher education. Higher education establishments include universities, technological institutes, pedagogical institutes, maritime institutes and other higher specialized establishments. Periods of study are generally between two and six years, depending on the field of study and the nature of specialization.

1.2 Maritime secondary schools

There are three maritime professional schools, "EPM" on the coast of Morocco, located at Safi, Al Hoceima and Agadir. The maritime school of Safi was started in 1939, the school of Agadir in 1942 and the school of Al Hoceima in October 1981.

The training programme in these maritime professional schools is divided into two branches, namely "deck" section and "engineer" section. Admission in the first year is subject to an entrance examination for applicants having completed at least four years in secondary school. The age limit for qualified candidates is from 16 to 19 years, and the duration of studies is two years. Training is financed by the Government, in State-owned schools. Tuition is without cost to the students.

Training is divided into theoretical and practical instruction and efforts are made to give students a general education in addition to knowledge of professional subjects. The theoretical instruction is based on the knowledge and skills and practical training requiring the students' participation is included in the two years of study. Some emphasis is given generally to the professional and practical subjects. About 37 hours of instruction are given each week, to each section, during the two years at the maritime schools. The various subjects which are included in the curricula are as follows:

Deck

Mathematics
Physics
Electricity
Geography
Navigation
Boat handling
Signal techniques
General fishing techniques
First aid - safety
Regulations
Hygiene
French
Arabic
Marlin-spike seamanship
Ship's knowledge
Training on board fishing ships
Sport

Engineer

Mathematics
Physics
Electricity and its lab.
Engineering drawing and design
General marine engineering
Geography
Arabic
French
Engine room duties
Workshop practice
Hygiene
Ship knowledge
Regulation
First aid - safety
Marine engines
Training on board fishing ships
Sport

At the end of these two years' training, the successful students obtain a maritime professional aptitude certificate "CAPM". This certificate permits them to work on board fishing trawlers or commercial vessels. They embark at first as simple crew members and then get more responsibility between the officers and the crew (equivalent to petty officers in the Navy). Furthermore, the holders of the "CAPM" may sit for the entrance examination at the professional Maritime School of Agadir. This would enable them to attend a one-year course leading to a diploma of watchkeeper for fishing vessels. After this one year course, successful students then have the possibility to pursue studies in short cycle training at the higher institute of maritime studies. This short cycle training leads to the skipper's certificate "Patron de Pêche", to captain or engineer officers, third grade.

The number of students trained at the professional maritime schools in the seven year period 1978-1984 totals 812. The evolution of the number of students trained is illustrated in tabular form in Figure 2.

1.3 Marine officers

1.3.1 Historical background

Nautical education in Morocco today owes its background to the developments in maritime education and training of merchant marine

EVOLUTION OF NUMBER OF STUDENTS TRAINED IN
MARITIME VOCATIONAL SCHOOLS

Year	EMP of Safi	EPM of Agadir	EPM of Al Hoceima
1977-78	31	28	-
1978-79	32	37	-
1979-80	36	54	-
1980-81	37	49	-
1981-82	35	85	38
1982-83	35	85	55
1983-84	35	85	55
	241	423	148
TOTAL: 812			

officers which have taken place during the past years. As late as 1951 Morocco did not have a maritime school for the training of marine officers, although institutions for the training of ratings did exist. In 1956 the first students were admitted for training as marine officers. In order to meet the needs of the shipping companies, the first theoretical training courses leading to captain and engineer officer third grade were started in 1962 at the National Merchant Marine School "ENOMM". In 1967 the first training courses for captain officers second grade commenced. This was supplemented by the training of marine engineer officers in French nautical schools, leading to the brevet of marine engineer officers second grade. In 1974 the first training courses were commenced in Morocco for engineer officers second grade. Increasing demand for sea-going officers resulted in a further course commencing in 1977-78 for the training of officers first grade. Training courses for students leading to engineer officer first grade only commenced in October 1979 in a new maritime high school named Higher Institute for Maritime Studies "ISEM" (Institut Supérieur d'Etudes Maritimes).

1.3.2 Training system

Maritime studies for merchant marine officers are provided without cost to the trainees. Training schemes are entirely financed by the Government, and tuition, board and lodging are provided for students, who are also given a monthly allowance. The training courses include theoretical instruction related to the shipboard skills required by officers, general educational subjects and practical exercises and lessons.

Maritime studies for marine officers, available at the Higher Institute for Maritime Studies, include three cycles, namely:

- i the higher cycle, or level 1
- ii the normal cycle, or level 2
- iii the short cycle, or level 3

i The higher cycle

The higher cycle is for the training of captain and engineer officers, first grade (refer to Figure 3). The duration of

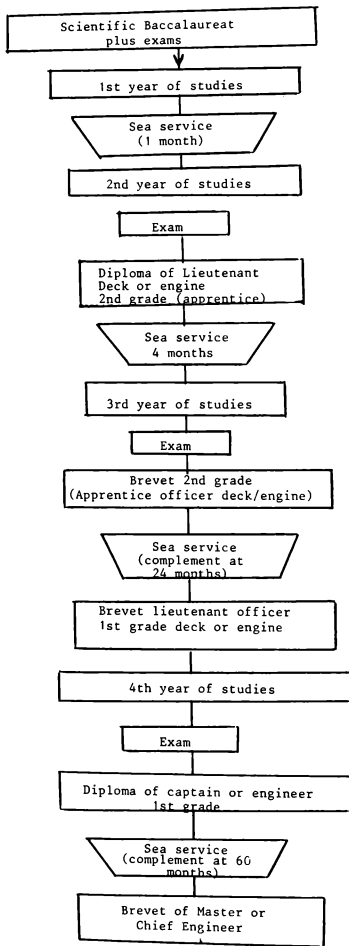

training is six years. Four years are devoted to theoretical and practical studies at ISEM and two years' sea training on board merchant ships as apprentice officer. This cycle is the upper level one and there are two ways to enter it:

- a to have a baccalaureat, scientific, mathematics, technical or mathematics-technical;
 - the student must be less than 23 years old and pass medical and physical fitness examinations;
 - to pass with success an entrance examination:
this examination is given each year in the following subjects:
mathematics, physics and
English and engineering drawing are optional subjects;
 - the successful candidates selected from applicants who best fulfil the above requirements, have a sea-training test prior to the studies;
- b to have started the lower level (the normal cycle) and be admitted to follow the upper one after examination.

The diploma of lieutenant, deck or engine, second grade (apprentice) is awarded after a common examination at the end of the second year at the institute. The diploma of apprentice officer, deck or engine (diploma of lieutenant 1st grade) is awarded after examination at the end of the third year at the institute. The brevet as officer (brevet lieutenant officer, 1st grade) is awarded after 24 months at sea. It permits the holder to be officer in charge of a navigational watch or officer in charge of an engineering watch, in accordance with Rules II/4 and III/4 of STCW 1978. The diploma of captain or engineer officer first grade is awarded after examination at the end of the fourth year at "ISEM". It allows the holder, after a certain time at sea as an officer in charge of a navigational watch, to become chief mate (Rule II/2) or second engineer officer, to become a chief engineer (Rule III/2). The brevet of master or engineer officer first grade allows the holder, having at least 60 months' sea service, to carry out the function of master or chief engineer on board ships of any tonnage and power (Rules II/2 and III/2 of STCW 1978). It should be noted that the certificates of competency awarded to officers are of

two types: firstly the "Diploma", awarded for theoretical and practical training indicating the level of knowledge acquired during the studies at the institute; secondly, the "Brevet" attesting that trainees have acquired experience on board merchant ships. This will assure the competent authorities that they possess the necessary qualifications and experience to exercise their functions on board ships. The various subjects which are included in the curricula are illustrated in Figure 4.

ii The normal cycle

The normal cycle may be called also the training of level two. It is for the training of captain and engineer officers, second grade. See Figure 5. The duration of training is five years, of which three years' theoretical and practical course are undertaken at "ISEM" and 24 months at sea on board merchant ships as apprentice officer. For entrance into the first year course the student must have the same entrance conditions as for the higher cycle, except that there is no entrance examination. The training at the normal level is in accordance with Regulations II/4, III/4 and III/2 of STCW 1978 (also refer to Figure 5). The captain and engineer officers third grade of the short cycle can be admitted to the second year course of the normal cycle after an entrance examination. The normal cycle consists also of training of radio officers for the merchant marine.

iii The short cycle

The short cycle is for the training of marine personnel for fishing ships. In addition this cycle has essentially the objective to help the students of maritime professional schools for the preparation to the brevet of skipper, captain and engineer officers, third grade (see Figure 6). To enter this cycle the applicants must have the diploma of watchkeeper for fishing ships from EPM of Agadir and also have at least 24 months sea service. After a one year course at the institute the students take an examination and the successful students obtain the Diploma of Skipper "Patron de peche", captain or engineer officer, third grade. Within 60 months' sea service the deck officer obtains the brevet of captain officer third grade, while the others obtain the brevet of patron de peche or engineer officer, third grade, after a total sea service of 48 months.

SUBJECTS INCLUDED IN THE CURRICULA OF THE HIGHER
CYCLE FOR TRAINING MASTERS AND CHIEF ENGINEERS

<u>DECK</u>	<u>ENGINEER</u>
English	English
Arabic	Arabic
Mathematics	Mathematics
Mechanics	Mechanics
Strength of materials	Strength of materials
Electricity	Electricity and practice laboratory
Electronics	Electronics and practice laboratory
Electro-techniques	Electro-techniques and practice laboratory
Automation	Automation and practice laboratory
Navigation	Internal combustion engines
Cosmography	Auxiliary machinery
Nautical calculus	Steam engineering
Marine charts	Thermodynamics
Instrumentation	Engineering drawings and design
Manoeuvring and propulsion	Technology and laboratory
Simulator radar	Metallurgy technology
Safety	Marine engines practice
Meteorology	Naval architecture
Ship's theory	Safety
Signal techniques	Ship's theory
Marine engines	Rules and regulations
Rules of the road	Hygiene
Marlinspike seamanship	Engine complements
Naval architecture technology	Engine operation and maintenance
Rules and law	Reports
Transport economy	Thesis
Hygiene	Training ship
Oceanography	
Comptability	
Thesis	
Reports	
Training ship	

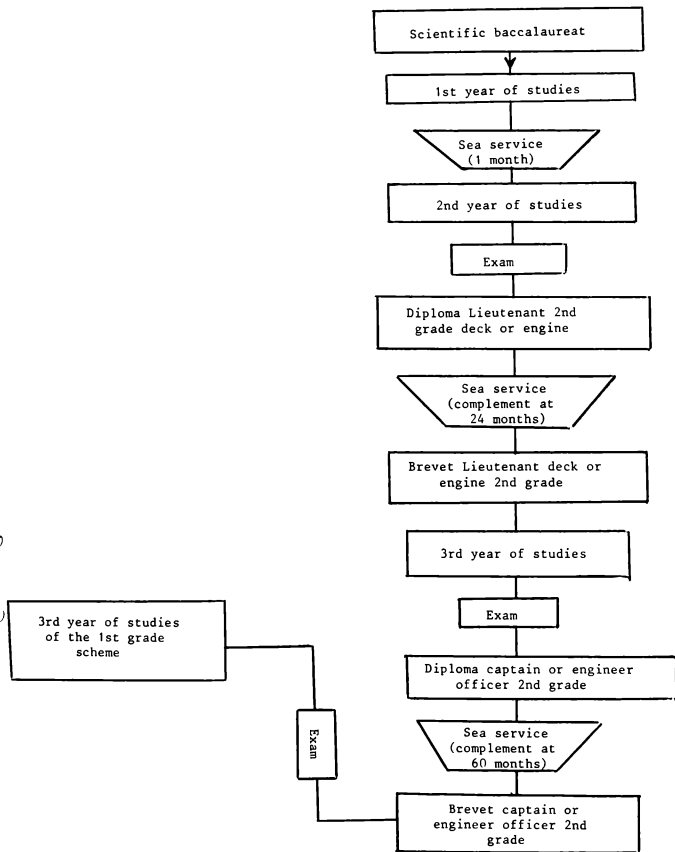

TRAINING SCHEME OF "P.P.", CAPTAIN
ENGINEER OFFICERS 3RD GRADE

Figure 6

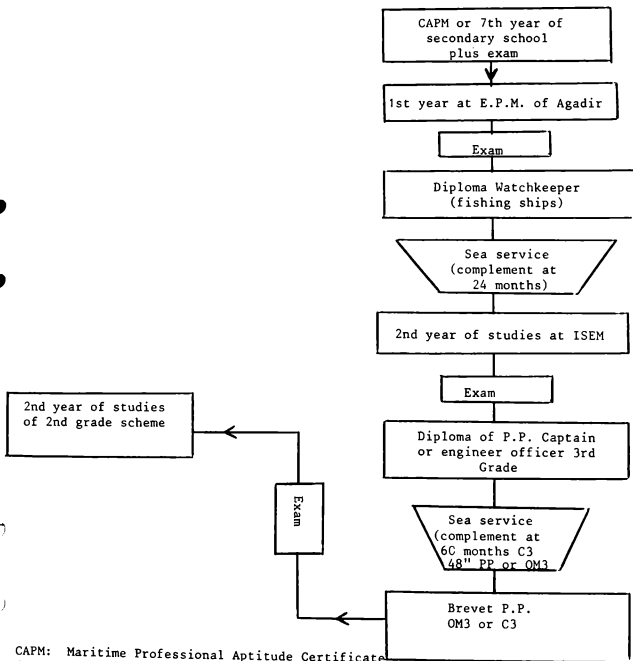

- CAPM: Maritime Professional Aptitude Certificate
- EPM: Maritime Secondary Vocational School
- ISEM: Higher Institute for Maritime Studies
- PP: Patron de peche = "Skipper"
- C3: Captain Officer 3rd Grade
- OM3: Engineer Officer 3rd Grade

During the training at the institute, special attention is paid to the instruction of students with courses and practical exercises in fire fighting, first aid and personal survival. The instruction of these courses is carried out in special centres arranged for the purpose. The students are always called upon to keep the principle of safety in their minds as a priority. During the fourth year of the course at the institute, students have to prepare a thesis on a maritime subject which is taken into consideration for the academic degree.

Since the opening of the higher institute for maritime studies in 1978, about 800 officers and cadets have been trained, about two-thirds for the merchant marine and one-third for fishing vessels. Among them were students from Lebanon, Tunisia, Gabon, Ivory Coast, Mauritania and France. The evolution of the number of students trained at ISEM is shown in Figure 7.

1.3.3 Higher Maritime Institute

The training of marine officers is carried out at the Higher Institute for Maritime Studies "ISEM". It is the only establishment for the training of marine officers for the merchant marine. "ISEM" operates under the supervision of the Ministry of Maritime Fisheries and Merchant Navy. It was established in January 1978, replacing the old school for merchant marine officers, the "ENOMM". The Institute is built on its present site on an area of four hectares in the city of Casablanca, the biggest city and port of Morocco. It serves as a boarding school and has a capacity for 400 students, including 300 boarders. The principal buildings of the Institute include: academic laboratories and workshops, academic buildings with 16 classrooms, a library as well as offices for the faculty and administrative staff, large dormitories, a mess hall and galley, and sports facilities. Aside from the Director, the staff of "ISEM" consists of 26 professors, including 9 Moroccan nationals. The number of part-time professors is 12. Service and administrative staff number a further 88 persons.

1.4 Practical training aids for marine engineers

Training aids are any physical devices or tools used by the instructor as an added means of communication to facilitate the learning of the trainees.

EVOLUTION OF NUMBER OF STUDENTS AT "ISEM"

Year	Number of students	Number of foreign students
1977-78	187	10
1978-79	220	4
1979-80	245	5
1980-81	260	5
1981-82	320	18
1982-83	240	15
1983-84	230	16
1984-85	250	20

They are used in conjunction with instruction when explaining practical exercises in certain skills. Training aids are an aid to instruction, learning and direct experience, but not a substitute. Spoken or written words are the expression of thought and we use our senses of imagination to form a mental picture of the notion that the words seem to impart. Training aids assist in the process of communication by adding realism and substance to ideas, descriptions and explanations given in words during training courses. This is done through sight, the means by which a great part of all the things we learn come to us. Training aids put sight to us in learning, and they also give the trainee the opportunity to perform practical operations with his own hands. The result is an easier understanding and fuller retention of the subject matter by the trainee, a saving in teaching time, greater interest and morale of the trainees and the development of practical skills. For these reasons nobody concerned with the training of seafarers and marine engineers can really afford to neglect to employ or to use appropriate maritime aids to the fullest extent possible.

The practical training in professional courses for marine engineers at the maritime institute and at sea, forms a very important and an integral part of the training scheme and curriculum. This is carried out by two training aids: (i) laboratories and workshops; (ii) training vessels.

i Laboratories and workshops

Laboratories are used to implement and expand on the classroom instruction and to develop the practical skills which are required of the different categories and grades of marine engineers. Laboratory work is one of the most important phases of training for practical marine engineers, who must have an intimate knowledge of how to operate, test, maintain and repair a wide variety of machinery and equipment. The Higher Institute for Maritime Studies has at the disposal of the students, the following laboratories for marine engineers: electronics, electro-technology, electricity, automation, refrigeration plant, diesel engine, water, oil and fuel analysis, etc. The workshops comprise lathe operation, welding, fitting, forge. The instruction in the workshops as training aids is intended to qualify trainees to perform emergency

repairs or basic shipboard maintenance. Generally the training in workshops is carried out during the first two years of the training at the Institute.

ii Training vessels

The use of training vessels offers certain advantages in the practical instruction of marine engineers. Ship construction details, the various machinery and equipment fitted on board, piping electrical and other systems, layout, etc. are more readily studied and understood onboard ship. Trainees can also be exercised in such work as machinery operation, maintenance and repair. The ISEM also has at its disposal a training ship "Al Mohit", whose gross register tonnage is 220 tons and her machinery develops 800 horsepower. The "Al Mohit" can embark thirty students for one day trips, and eighteen students for longer cruising. One part of the sea training is carried out on board this training vessel. The other part is on board trading ships. The latter is executed through the collaboration of shipowners. Collective agreements require the engagement of apprentice officers on board merchant vessels.

1.5 The International Convention on Standards of Training, Certification and Watchkeeping for Seafarers, 1978 (STCW 1978)

Maritime training, examination/certification of seafarers are two vital and inseparable links in a chain which determines the standards of safety and efficiency of the operation of ships. It should be borne in mind that proper maritime training is the very fundamental requirement and a most important element in ensuring the safe and efficient operation of ships.

This Convention, which has great relevance for training of seafarers, is the International Convention on Standards of Training, Certification and Watchkeeping for Seafarers, 1978 of the International Maritime Organization. This Convention is the first attempt to establish global minimum professional standards for seafarers. The whole aim of the STCW 1978 Convention is to ensure that merchant ships operate safely and efficiently with maximum protection of the environment against pollution.

The STCW 1978 Convention

The STCW 1978 Convention was adopted by the Member States of the International Maritime Organization (IMO) at an international conference held in London in 1978. The Convention prescribes minimum standards which Contracting Parties are obliged to meet or exceed. The Convention would come into force one year from the date on which twenty-five countries, the combined merchant fleets of which constitute not less than fifty percent (50%) of the world's merchant shipping (of vessels of 100 gross register tons or more) have acceded to it. This target was reached on 27 April 1983 and the STCW 1978 Convention entered into force on 28 April 1984. The Convention provides for the first time, on an international scale, minimum standards for seafarers in terms of the levels of theoretical and practical knowledge linked to professional experience and understanding required for the certification of professional competence of seafarers. The effect of the Convention's entry into force will therefore be to raise standards in the world on a global basis. One especially important feature of the Convention is that it will apply to ships of non-Party States when visiting ports of States which are Parties to the Convention.

The technical provisions of the Convention are contained in an annex which is divided into six chapters dealing with the following subjects:

- i General provisions
- ii Deck department
- iii Engine department
- iv Radio department
- v Special requirements for tankers
- vi Proficiency in survival craft

i General provisions

This deals with control procedures, certification and power of the port States.

ii Deck department

This chapter establishes the basic principles to be observed in keeping a navigational watch, watch arrangements, fitness for duty, navigation, navigational equipment navigational duties and responsibilities, the duties of the lookout, navigation with pilot on board and protection of the marine environment. It covers masters and chief mates of ships of 200 gross tons to 1,600 gt and of ships of 1,600 gt and above; masters and officers in charge of navigational watches on ships below 200 gt; and for ratings. The structure relating to deck officers certification is illustrated in Figure 8.

iii Engine department

This chapter sets up the basic principles to be observed in keeping an engineering watch, general, operation, watch requirements, fitness for duty, protection of the marine environment. The requirements for deck officers vary according to the tonnage of the ship, however, for engineer officers the determining factor is the propulsion power of the engine. The Regulations cover mandatory minimum requirements for certification of chief engineer and second engineer officers of ships powered by main propulsion machinery of 3000 kW propulsion power or more and ships of 750 kW to 3000 kW. There are also requirements for engineer officers in periodically unmanned engine rooms. The mandatory requirements for the engine department are contained in six regulations and the appendices to them.

- Reg. III/1 Basic principles to be observed in keeping an engineering watch.
- Reg. III/2 Mandatory minimum requirements for Certification of Chief and Second Engineer Officers of ships powered by main propulsion machinery of 3000 kW or more.
- Reg. III/3 Mandatory minimum requirements for Certification of Chief and Second Engineer Officers of ships powered by main propulsion machinery between 750 kW and 3000 kW propulsion power.

DECK OFFICER TRAINING AND CERTIFICATION,
AS REQUIRED BY IMO STCW 1978 CONVENTION

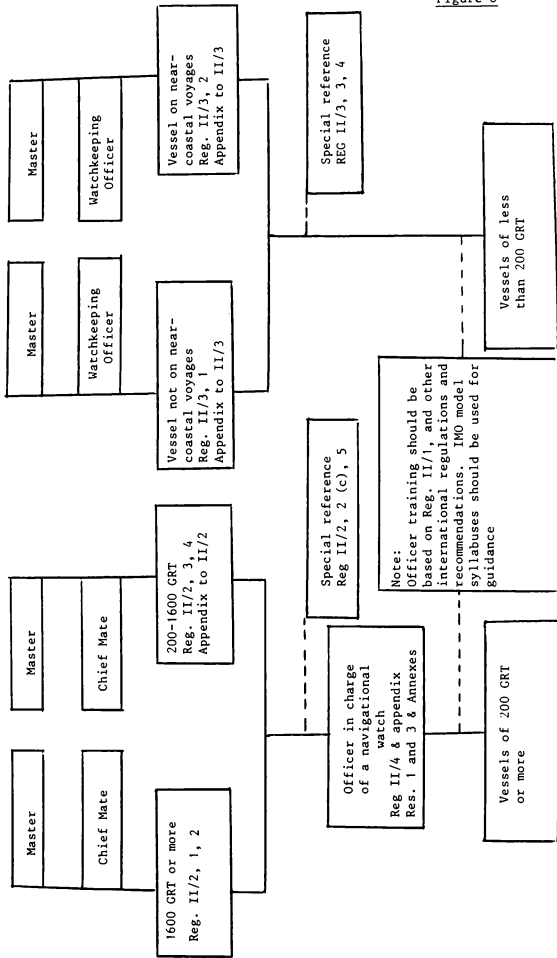

Reg. III/4 Mandatory minimum requirements for Certification of Engineer Officers in charge of a watch in a traditionally manned Engine Room or Designated Duty Engineer Officers in a periodically Unmanned Engine Room where the propulsion power is 750 kW or more.

Reg. III/5 Mandatory minimum requirements to ensure the continued proficiency and updating of knowledge for Engineer Officers.

Reg. III/6 Mandatory minimum requirements for Ratings forming part of an Engine Room Watch.

The structure relating to the engineer officers certification is illustrated in Figure 9. A detailed diagram for marine engineer officers is shown in Figure 10.

iv Radio department

The chapter is concerned with the radio department. The mandatory provisions relating to this department appear in the Radio Regulations and the SOLAS Convention.

V Special Requirements for Tankers

The chapter illustrates the importance of this type of ship. Attention is paid to both safety and pollution aspects.

vi Proficiency in Survival Craft

This chapter establishes requirements governing the issuance of certificates and proficiency in survival craft. There are also a number of Resolutions adopted by IMO since 1978 until now, relating to training of seafarers. The updated list on this is shown in Figure 11.

IMO's assistance in Morocco

The Moroccan Ministry of Maritime Fisheries and Merchant Navy established in 1981, gives the highest priority to the training of national seafarers. The Higher Institute for Maritime Studies "ISEM", which is under the supervision of this Ministry, works in close collaboration with the International Maritime Organization. In order

MARINE ENGINEER OFFICER TRAINING AND CERTIFICATION AS REQUIRED BY IMO STCW 1978 CONVENTION

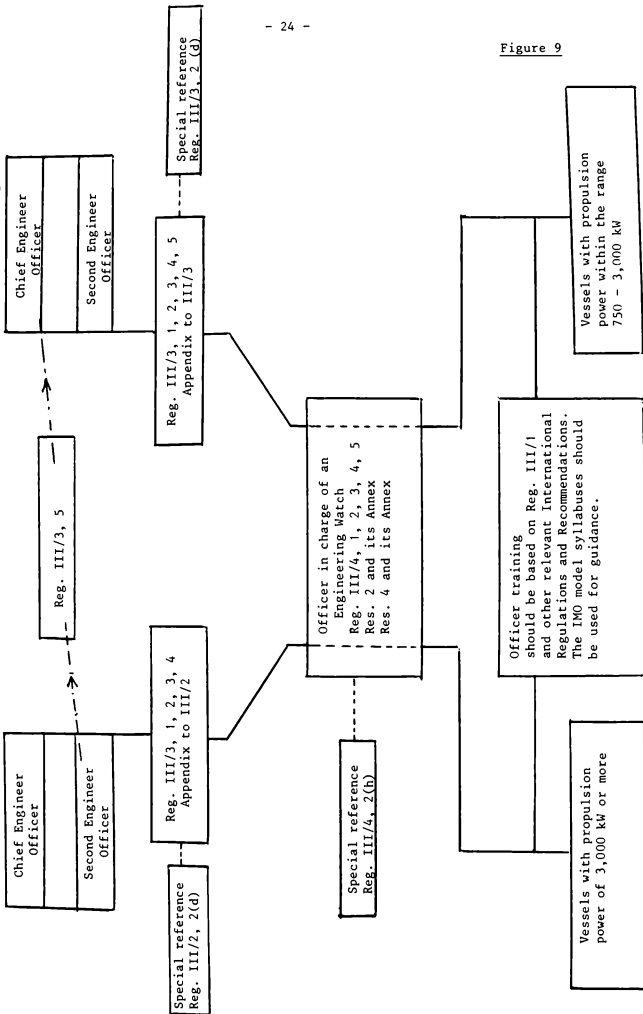
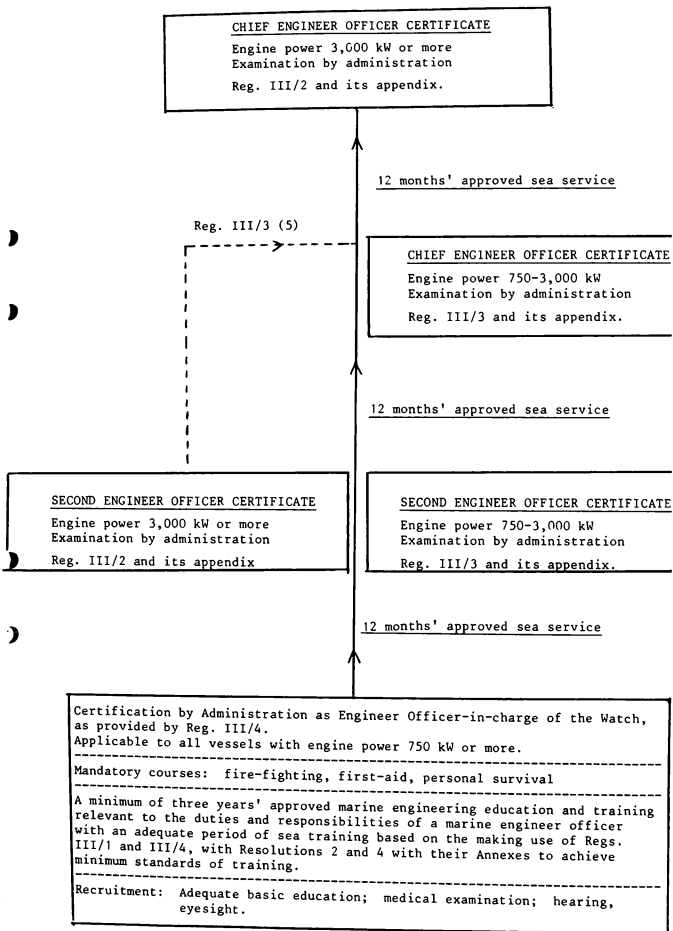

Figure 9

MARINE ENGINEER OFFICER TRAINING AND CERTIFICATION
IN TERMS OF THE IMO STCW 1978 CONVENTION



LIST OF IMO RESOLUTIONS ADOPTED BY ASSEMBLY OF THE
INTERNATIONAL MARITIME ORGANIZATION, RELATING TO
MARITIME TRAINING

RESOLUTIONS

- | | |
|--------------|--|
| A. 89(IV) | Training of Seafarers |
| A. 124(V) | Recommendation on Crew Training |
| A. 181(VI) | Instructions on Survival in Liferrafts |
| A. 188(VI) | Training of Masters, Officer and Crew |
| A. 216(VII) | Instructions for Action in Survival Craft |
| A. 285(VIII) | Recommendation on Basic Principles and Operational Guidance relating to Navigational Watchkeeping |
| A. 286(VIII) | Recommendation on Training and Qualifications of Officers and Crews of Ships carrying Hazardous or Noxious Chemicals in Bulk |
| A. 311(VIII) | Safety of Maritime Navigation |
| A. 337(IX) | Recommendation on Principles and Operational Guidance for Deck Officers in charge of Watch in Port |
| A. 380(X) | Standard Marine Navigational Vocabulary |
| A. 437(XI) | Training of Crews in Fire-Fighting |
| A. 438(XI) | Training and Qualifications of Persons in Charge of Medical Care aboard Ship |
| A. 443(XI) | Decisions of the Ship Master with regard to Maritime Safety and Marine Environment Protection |
| A. 481(XII) | Principles of Safe Manning |
| A. 482(XII) | Training in the use of automatic radar plotting aids (ARPA) |
| A. 483(XII) | Training in radar observation and plotting |
| A. 484(XII) | Basic Principles to be observed in keeping a Navigational Watch on board Fishing Vessels |
| A. 485(XII) | Training, Qualifications and Operational Procedures for Maritime Pilots other than Deep-sea Pilots |
| A. 488(XII) | Use of the Standard Marine Navigational Vocabulary |
| A. 537(XIII) | Training of Officers and Ratings Responsible for Cargo Handling on Ships Carrying Dangerous and Hazardous Substances in Solid Form in Bulk or in Packaged Form |
| A. 538(XIII) | Maritime Safety Training of Personnel on Mobile Offshore Units |
| A. 539(XIII) | Certification of Skippers and Officers in Charge of a Navigational Watch on Fishing Vessels of 24 metres in length and over |

that "ISEM" fulfills its objectives at the professional level and in order to improve the standards of education and training of seafarers to meet the requirement of STCW 1978, the Moroccan Government requested IMO to provide project assistance. The objectives of the project are: to reinforce the maritime institute, to train national training staff with the assistance of a number of expatriate personnel, and to develop a mid-term strategy for maritime training. The foregoing was envisaged to contribute in the application of the STCW Convention. A programme drawn up by IMO, the United Nations Development Programme (UNDP) and the Government, was approved in May 1983. It called for an adviser, experts, consultants, equipment and also a training component. A national expert has been appointed as chief technical adviser and with the cooperation of the national experts actively dealing with the modernization of the training provided by the Maritime Institute.

CHAPTER 2

DIESEL ENGINEER ROOM SIMULATOR

"You do things right because you have experience;
You have experience because you did things wrong."

(Chinese proverb)

2.1 Introduction

We live in a world of man-machine systems. We have such a system when a man interacts with a machine in such a way that he is provided with various sensory inputs by the machine, and the machine is controlled or influenced by him. We have for instance a particular man-machine system comprising a ship and her operators. This is a special case of the man-vehicle system. For certain purposes we may wish to operate the human part of such a system, but avoiding the trouble and expense of actually running the physical machinery. In such a case we may replace the machine with a reduced or simplified version, complete enough to provide the human sensory input-meter readings, noises, accelerations, and so on, and to appear to respond to man's orders, but lacking the expensive external part. This system of operating is named simulation and the device with which the machine is replaced is called a simulator.

During the last decade simulators for training have become an accepted teaching aid in nautical circles. The most used application of marine simulators nowadays has become the ship's bridge and engine room simulators for training deck and engineer officers. The gradually improved marine training simulators have become more true-to-life. The invention, design and creation of suitable forms and types of these simulators occupy a considerable amount of the ingenuity of professional engineers, technologists and scientists throughout the world. More recently computers have enabled machine responses to be modelled in a most sophisticated manner.

Today the simulator honeymoon is over. Ship simulators for training are no longer a novelty; they are becoming essential aids in maritime training and like any other training aid, they should be used to maximum advantage. The reason for using ship's simulators for training can be summarized as having two objectives: safe and efficient ship operation. What does safe and efficient ship operation mean? It means a further reduction of the ship's complement, an integration of function on board, more and more reliable automatic control and monitoring system on board, and more efficient sailing with respect to fuel economy. It can also mean a stronger demand for safety at sea.

With the rapid development of marine power plants in becoming complex, longer, faster, more automated and more sophisticated, the engine room simulators for training marine engineers have been built, developed and installed in many maritime training institutions in recent years. A question arises as to what shall be called an engine room simulator. A common, general definition of an engine room simulator is a complete engine room system where all the machinery has been reproduced through the application of a computer programmed to present specific engine room components as they would be onboard modern ships. The system is designed in such a way that all operational actions taken by the trainee produce fair operational functions of a typical main propulsion plant. The simulated engine room system covers both the main propulsion plant and the auxiliary components throughout the engine room. The engine room simulators are divided into three versions:

- i steam plant simulators
- ii medium-speed diesel plant simulators
- iii slow-speed diesel plant simulators

This chapter deals with an engine room simulator with a slow speed diesel plant and is called "diesel engine room simulator".

2.2 Purpose

The purpose of using a diesel engine room simulator is to provide an educational and training aid that will give a fairly realistic reproduction of the behaviour of a typical propulsion diesel plant and auxiliary equipment as found on board modern ships. This facility will permit the marine engineers to gain significant training in skills

to efficiently operate and troubleshoot a modern automated propulsion system. This aid can be used also in training of ship engineers in the safe and economic operation of diesel engine machinery. Therefore for training junior engineers in basic engine room operation, training senior engineers in emergency operation and trouble-shooting and training senior and chief engineers in optimal plant operations, fuel economy and energy saving.

2.3 Advantages

There are five main advantages for using a diesel engine room simulator in training:

- i lowered training costs
- ii time saving in achieving operational experience
- iii more effective training
- iv repeatability conditions
- v safer training

i Lowered training costs

The diesel engine room simulator can save money. It may be expensive, but it is still cheaper than a ship to buy, and far cheaper to run. The economic gains are obvious, for instance the cost of the delay of a bulk carrier or container ships or oil tanker because of training which must take place at sea would be enormous, while the cost of using a special training ship of this size would also be unthinkable. In addition, the simulator has no large and complicated engine room mechanical equipment. A main propulsion diesel engine plant on board ship costs millions of dollars. Therefore using the simulator not only saves a lot of money from the point of view of initial investment, but it also saves a large amount of money in terms of running costs (i.e. the expense for fuel oil, lubricating oil, water, etc.) since the training in continuous engine room operation is carried out without using any oil and moreover power and daily maintenance costs are greatly minimized.

The 5th Ship Control Systems Symposium (SCSS) in 1978 in the USA held the opinion that the training cost associated with the use of such a simulator amounts to only one-eighth to one-tenth the cost on real ships.

ii Time saving in achieving operational experience

It takes years for a marine engineer to experience a sufficiently great number of various malfunctions and failures in the machinery installation to really become an experienced and safe operator. The engine room "diesel plant" simulator overcomes this by the considerably fewer practice hours for approximately the same experience. The dynamic real-time simulator may compress years of experience into a few weeks, thus the simulator saves time.

iii More effective training

Whether the training is more effective can perhaps be questioned, mainly because factors such as attitude training and factual training are so important on board vessel. On the other hand, skill training is almost certainly more effective on the diesel engine room simulator than on board ship, because the conditions are completely under control. The trainee certainly will both remember and believe in his theoretical knowledge better when he tests and proves it during training on the simulator. The training on the diesel engine room simulator is furthermore effective since it develops the students' ability and methods of decision-making.

Some examples of exercises which can be undertaken on the simulator which are effective training possibilities, are as follows:

i) It is possible to analyse the combustion and injection information of each cylinder on the indicator diagram. The diagram is printed by a six-channel recorder. The recent use of Diesel Engine Tuning System (DETS) for the control of the combustion and injection make the exercise and analysis of such a system on the simulator more effective. Figure 12 illustrates an example of the possibility to analyse the combustion and injection pressure of one cylinder.

ii) Wear of the piston rings and bearings on a marine diesel engine is very slow and is only apparent over a long period. The recent use of Piston Condition Monitoring System (PCMS) provides the opportunity to see the wear condition on different positions of the piston rings. On the simulator serious wear can be demonstrated and analysed. As an example Figure 13A shows normal piston ring condition. Figure 13B

Figure 12

INDICATOR DIAGRAM

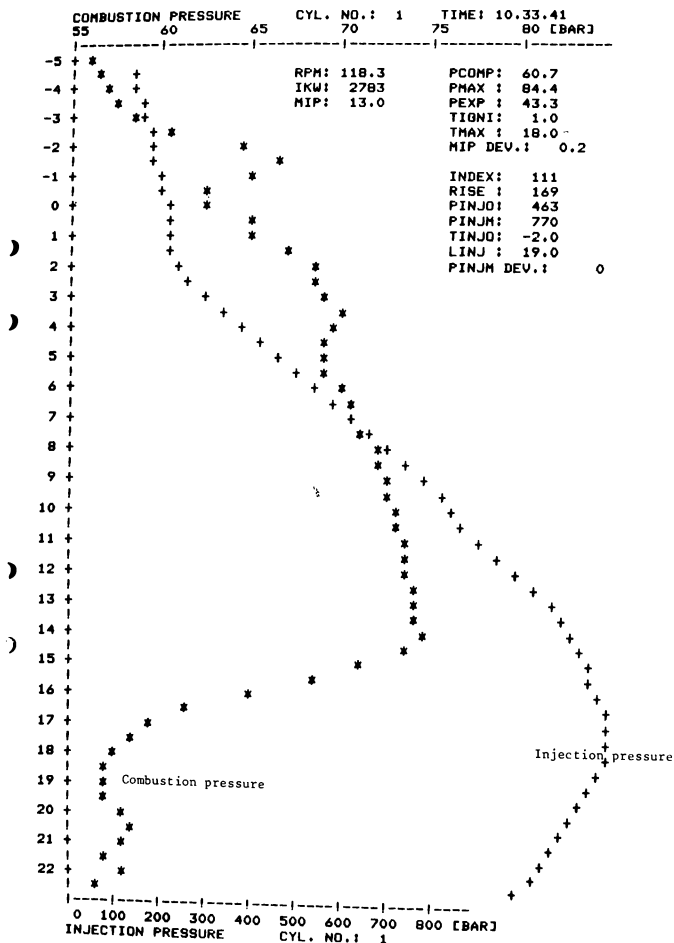

PISTON RINGS, CYLINDER NO.: 2

LINER	MAN. SIDE	PISTON	LINER	EXH. SIDE
1	81			94
2	98			97
3	100			100
4	100			100
5	27			99

Figure 13A

PISTON RINGS, CYLINDER NO.: 2

LINER	MAN. SIDE	PISTON	LINER	EXH. SIDE
1	75			99
2	100			100
3	40			40
4	99			100
5	16			99

Figure 13B

PISTON RINGS, CYLINDER NO.: 2

LINER	MAN. SIDE	PISTON	LINER	EXH. SIDE
1	64			99
2	100			100
3	10			10
4	99			100
5	10			99

Figure 13C

shows piston ring wear condition after a certain time; Figure 13C demonstrates the piston ring wear condition after a certain different period of time. If the value is considered to be expressed in numbers of asterisks (*) showing the piston ring condition monitoring system above 30%, then we assume that the piston rings are still in good condition. When the value drops below 30, the piston rings should be replaced. When during the piston ring rotation the sensor will face the piston ring gap, then for a certain time we shall have a lower signal value or no signal at all (no asterisk). This will however be only a temporary situation because after further piston ring rotation the sensor will again be facing the piston and a full number of asterisks will appear. When comparing Figure 13A, 13B and 13C, we can conclude that the third piston ring is affected by serious wear.

iv Repeatability conditions

The repeatability improves the student's practical skill. All conditions as on board ship are fairly repeatable in time, so that an exercise can be wound back and run again from any chosen point. Using a simulator it is easy to freeze current situations for clarification and discussion, and even if necessary to stress a particular lesson. The repeatability also allows performance of different teams under identical inputs to be compared, opening up the possibility of the diesel engine room simulator being capable of use as an examination tool.

v Safer training

Finally, and perhaps most important of all, the diesel engine room simulator is the safest method of training. Training to enable personnel to meet dangerous situations is best carried out under safe conditions where there is no risk of damage, for instance the training in emergency stoppage of the main propulsion plant, emergency running, scavenging air box fire, piston seizure, crankcase explosion, engine room fire, lost propeller, heavy hull fouling, electric power supply blackout, and so on, can all be practised safely. Additionally several other instances which may occur in the engine room machinery and remote control room can be exercised on the simulator whereas they cannot safely be carried out on board a vessel without jeopardizing the interest of the

shipowner or the safety of the ship, her crew and in some cases also the environment. Examples of some exercise situations carried out under safe conditions are:

a) analysing and exercising the effects of the main engine when the propeller is lost can be drilled in safe condition. When the propeller is lost, the main engine is overspeed. The regulator adjusts the fuel lever and the engine speed returns to normal, the ship speed decreases gradually due to the ship's inertia (see Figure 14).

b) analysing the effects of various parameters on the characteristics of the engine when the hull of the vessel is fouled. These parameters are:

Parameter name		Normal	Heavily fouled
Main engine speed	RPM	114	114
Cylinder temperature	Dgr C	99.7	108
Exhaust temperature	Dgr C	394	426
Fuel lever		0.752	0.901
Main engine shaft power	MW	13.320	15.967
Fuel oil flow	T/H	2.723	3.262
Ship speed	knots	16.645	14.144
Fuel oil inlet pressure	Bar	4.982	4.207
Mean indicated pressure	Bar	10.6	12.6
Main engine efficiency		0.8955	0.9027

Figure 15 illustrates the dynamic characteristics of the main engine. The main engine speed is normally controlled by the regulator and line to maintain the speed at the set value. But the fuel lever is shifted further, the ship speed still decreases, the exhaust temperature rises, the temperature of cylinder and cylinder liner increases. The main engine is therefore developing more power. The mean indicated pressure then increases.

c) The simulator can also simulate the functioning of the variable pitch propeller at different pitches with the change of the pitch, the main engine speed, fuel lever, power, ship speed, propeller torque and thrust. All these parameters change correspondingly as illustrated in the table on Figure 16A. The characteristics of the propeller pitch can be plotted as shown in Figure 16B.

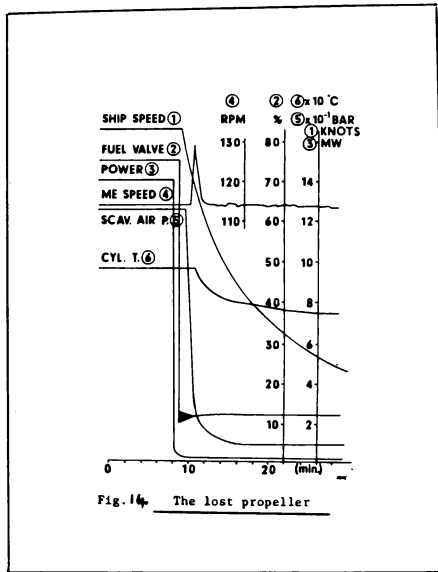

Fig. 14. The lost propeller

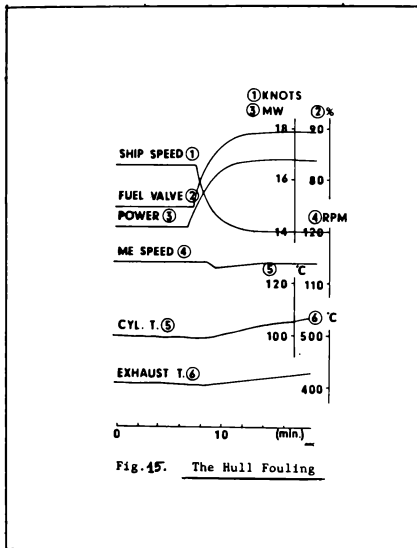
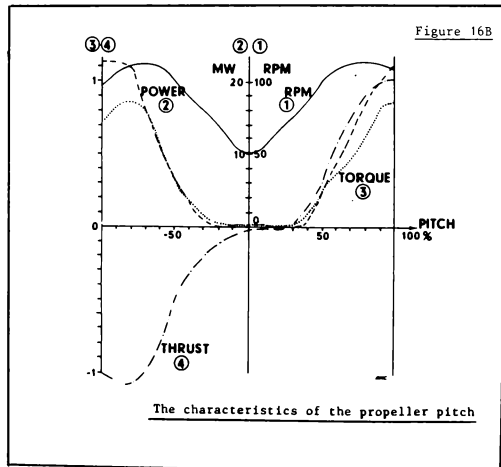

Fig. 15. The Hull Fouling

Figure 16A

The characteristics of varying pitch propeller

Pitch	Engine Speed RPM	Shaft Power MW	Torque	Thrust	Ship Speed KNOTS	Fuel Valve opening
100%	110	16.595	1.137	0.992	18.0	3.36
90%	114	16.246	1.079	1.003	17.3	3.31
80%	114	13.354	0.887	0.885	16.8	2.70
70%	114	9.975	0.664	0.734	16.0	2.17
60%	111	6.506	0.444	0.553	14.6	1.55
50%	99	7.860	0.221	0.331	11.5	0.889
40%	86.9	0.900	0.080	0.156	8.4	0.428
30%	75.1	0.126	0.014	0.040	5.7	0.206
20%	69.7	-0.003	0	-0.034	4.0	0.188
0%	50.8	0.398	0.059	-0.047	2.0	0.211
-20%	70.1	0.272	0.028	-0.123	-1.2	0.275
-40%	89.2	1.995	0.169	-0.313	-6.5	0.782
-60%	112	9.975	0.673	-0.834	-11.1	2.21
-80%	113	17.031	1.137	-1.132	-13.0	3.47
-100%	97.3	14.759	1.149	-0.992	-12.3	3.0



2.4 Simulation process by computer techniques

In the past few years "diesel plant" simulators have been developed, built and put into operation in many countries. What they all have in common is a mathematical simulation model programmed on a computer technique, describing an engine room's characteristics. The use of digital computers replacing the analogue computers, has given a new dimension in the development of the engine room simulation process by computer techniques. This has permitted the building up of good and efficient models with certain flexibility. The diesel engine room simulator is controlled by a computer system, in which have been built up the mathematical models called simulation models. The simulator models are able to duplicate the behaviour of the diesel engine room and all its vital parameters, as well as the interaction between the sub-systems of a diesel plant. The simulation models are built up in three different types, which are inter-connected with each other.

- i basic models
- ii system models
- iii plant models

i Basic models

A basic model may represent, for instance, a valve, pump, filter, actuator, combustion, sensor, controller, cooler, heater, tube, tank, etc. Each basic model is set up as a mathematical function describing the laws of physics, and has input variables, mathematical functions and output variables. The mathematical function contains also certain constant factors. The mathematical functions are computed at regular intervals, the output values varying with the variation of input (time-dependent), therefore the simulation models are dynamic.

ii System models

The system models consist of various numbers of basic models. An output variable from one basic model, e.g. valve, is an input variable to another basic model, e.g. a pump; the output of the pump may be an input for a filter, and so on with various basic models concerned. All of these basic models are linked together to form a system model. The system model represents a specific major part or function of the

plant. The following samples are some of the system models that can be made:

- fresh water system
- lubricating oil system for main engine
- sea water system
- fuel oil system
- fuel oil storage tank system
- electric power supply system
- compressed air system
- boiler combustion system
- piston cooling system
- ship propulsion system
- injection valve cooling system
- main engine bearing system

Note may be taken of the model drawings of lubricating oil system and fresh water system, as shown in Figures 17 and 18.

iii Plant model

The plant model represents the total engine room configuration and it is built up by various system models. For example, a model drawing with a slow speed diesel engine plant is illustrated in Figure 19. After analysing all engine room machinery and systems, they are represented by a mathematical model, and a programme is thus obtained for the computer to simulate the engine room operations. Dynamic models of each component are accurately depicted. The connection and integration of all component models forms a complete engine room process which is controlled by the computer system. Mathematical models of the propulsion plant with associated auxiliary systems are loaded into the computer's memory through a floppy disc. The computer with simulation models is connected to the instructor's station and the engine control equipment. The programmed diesel engine room model responds accurately to the input from the engine control room. The software of the computer consists of various programmes necessary to operate the whole engine room, presented through mathematical models. The flexibility is achieved by using a general purpose computer with memory directly accessible from the floppy disc. Extension or alteration of the simulating programmes may be done by just reading in a new floppy disc.

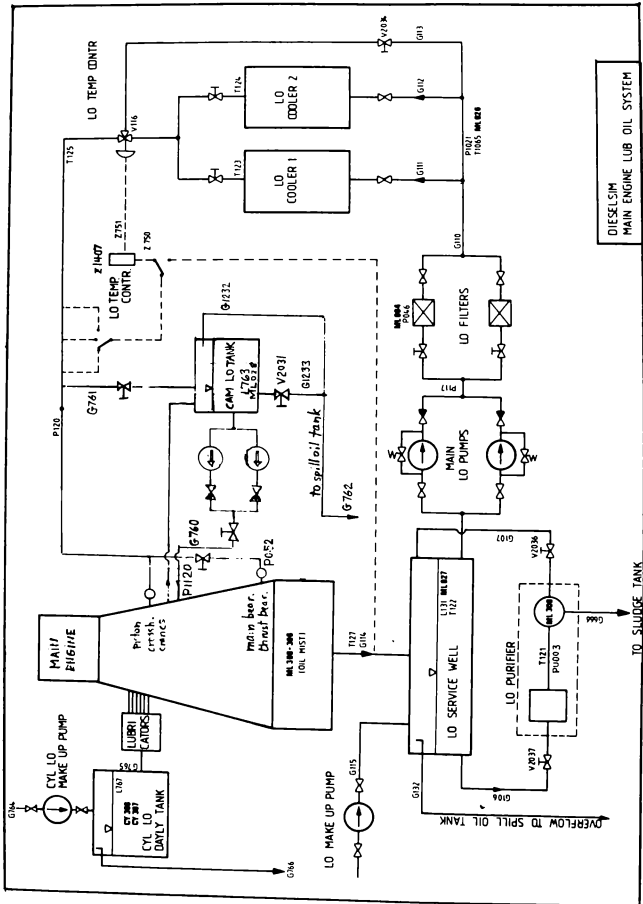

DIESELSIM
MAIN ENGINE LUB OIL SYSTEM

TO SLUDGE TANK

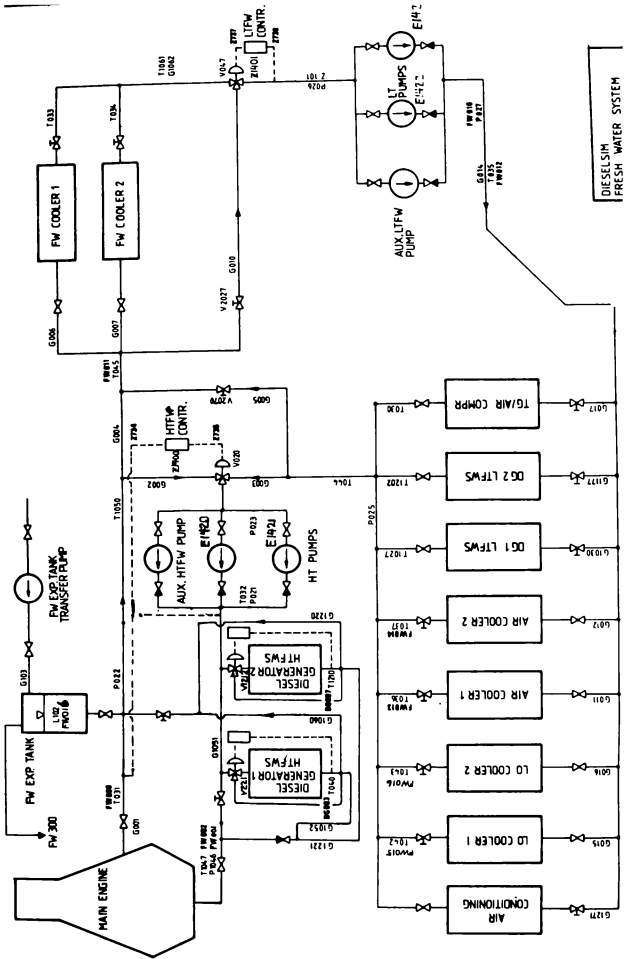

DIESELIM FRESH WATER SYSTEM

2.5 Description

A sample of a standard engineroom "diesel plant" training simulator is arranged mainly over three separate rooms, e.g.:

- the engine control room
- the instructor's room or "bridge"
- the engine room

Refer to Figure 20.

i The engine control room

The engine control room is equipped with the main operating panels such as alarm panel, communication panel, remote control panel and the main engine manoeuvring panel, the computer, the floppy disc unit, the main switchboard, pen recorder, controllers, a mimic panel and teletype. Some of these items of equipment are briefly described below.

- Alarm panel

The alarm panel includes controls for alarm and monitoring power on/off, indication of computer failure and built-in tests for display, indicator lamps and proper alarm system functioning.

- Communication panel

The communication panel includes controls for general system communication. All communication is basically made from the function pushbuttons, the keyboard and the display unit. Moreover the panel contains controls for stopping (freezing) the simulated process at any time to save actual process status on a floppy disc for future training purposes. Controls for computer starting and programme loading are also located on this panel.

- Remote control panel

The remote control panel contains indicators and operating controls, for instance, for diesel generators, low and high temperature fresh water pumps, sea water, fuel oil pumps, etc. The panel also includes indicators for main engine RPM, ahead and astern, ship speed, propeller shaft and other continuous instrument presentation.

SAMPLE OF A LAYOUT OF A DIESEL ENGINE ROOM SIMULATOR

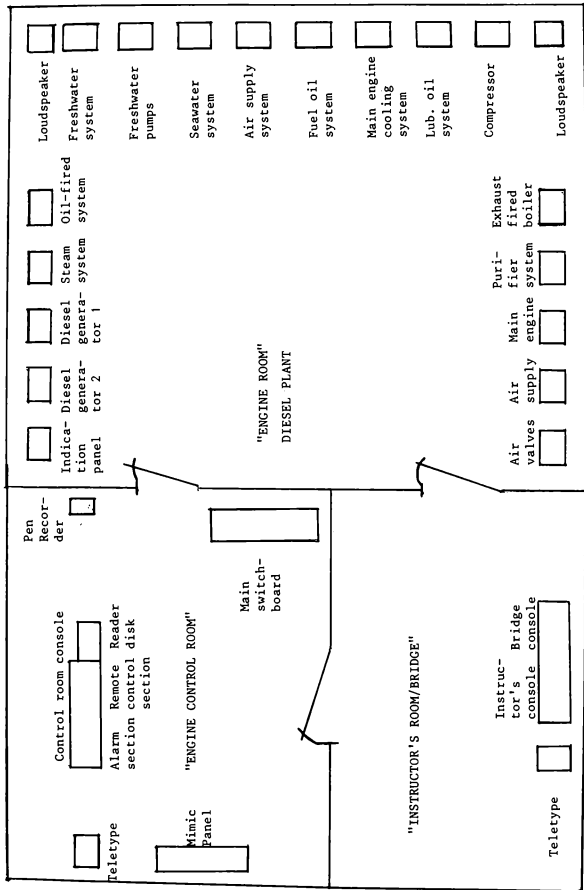

- The main engine manoeuvring panel

The main engine manoeuvring panel contains the engine room unit of the main engine remote control system, controls for controllable pitch propeller system, controls for start air and service air compressors.

- Mimic panel

The mimic panel displays main engine and sub-system details and flows, to introduce new students to the plant simulated. The mimic panel represents generally a coloured flow diagram of the main engine propulsion system and the main auxiliaries. Located on this diagram, at representative points, are a number of coloured lights (green, amber and red). The green lights indicate running machinery as selected on the motor panel. The amber lights indicate for example the coolers selected and/or pumps for duty, the open or closed position of main shut-off valves, temperature control on auto or manual, turning gear in or out and so on. The red warning lights indicate abnormal operating conditions.

- The computer

The computer is housed in the control room console. The computer has a memory directly accessible from a floppy disc.

ii The instructor's room or "bridge"

The instructor's room is located in the control room with a glass partition and houses the main communication equipment, such as teletype and acoustic equipment, and the main engine bridge remote control panel which enables the instructor to act as the duty deck officer. It may also be used for training in remote manoeuvring training for engineers and deck officers in the change-over watch responsibility and training in normal conditions at sea for the engineers with remote controlled main engine. From the instructor's room, the instructor may gradually increase the level of difficulty by introducing simple or more complicated failures which may occur in machinery components, controllers and indicating instruments, sophisticated malfunctions and wear, etc. He may also change for instance weather conditions and ship size, start the execution of fault sequence, remove faults, introduce other events in the process and check proper functioning of the simulator. The number of faults vary from one manufacturer to another. In general

the "diesel plant" simulator may have some few hundred faults programmed in its software. Each fault is represented by a code number. The instructor can push the "set fault" pushbutton on the control panel and use the keyboard on the teletype to set the fault code into the computer and therefore the fault will be displayed on the control box and on the control console. Sample of some general faults are illustrated in Figure 21.

iii The engine room

) In a space adjacent to the control room different local control panels are located. They are very similar to real ones on board and form the main simulated components of the engine room. For instance the existing local panels represent the following systems/components:

- main engine including air cooler and turbochargers
- compressed air system
- air valves
- diesel generators
- boiler system
- fuel oil treatment
- temperature control system
- sea water pumps
- fresh water pumps
-) - lubricating oil pumps
- fuel oil booster pumps
- hull propulsion
- compressors, and indication panel, etc.

More components and systems may be added according to the engine room simulator required. Equipment for resetting of trip and for simulating repair of malfunctioning components are also available on the local panels. The student is normally confined to the control room, but visits the engine room to check the state of the controlled component, re-set malfunction, practice the normal operation of control valves, for example. The main engine panel has several pushbuttons, each representing one type of fault. Additionally the panel has provision for adjustment of the fuel rack position for each cylinder. Loudspeakers may also be available in the engine room in order to reproduce the engine

SAMPLE OF SOME GENERAL FAULTS

	Pumps discharge pressure	Poor lubrication main bearing
	Pumps wear	Poor lubrication thrust bearing
	Glauad leakage	Lost water seal
	Dirty coolers	Purifiers system faults
	Main bearings L.O. pressure	Turbocharger system faults
	Cylinder daily leakage	Reduced piston cooling flow
)	Increased ME L.O. consumption	Low or high gain controllers
	Reduced turbines efficiency	Tanks level
	Drain valves open	Bilges alarm level
)	Dirty L.O. filters	Temperatures pistons
	Dirty S.W. filters	Temperatures cylinders
	Dirty diesel generator LO, FO filters	Temperature exhausts
	Low gain diesel rpm controller	Temperature air coolers
	Start air supply closed	Sinking ship
	High L.O., D.G. consumption	High friction, FO flow meter
	Boiler failures	SW leakage into FW system
	Water in start air receiver	LO leakage into FW system
	Sticking astern	Gas in FW
	Lost propeller/shaft failure	Short integration time controller
)	Air conditioner failure	Very high SW leak (grounding)
	Injection nozzle wear	High diesel generator L.O. consumption
	Injection time early or late	Increased ME, LO consumption
	Cylinder liner crack	Dirty vacuum condenser
	Scavenging air ports deposit	F.O. heater leak (water in F.O.)
	Dirty air filters	etc...

sounds which are synchronized with the r.p.m. of the engine and the turbochargers, noises from pumps and diesel alternator. These are presented through separate sound amplifiers and the sound amplifiers are located in the instructor's room.

) There are also other diesel engine room simulators using a more advanced simulation technology. In this type all panels and consoles may be replaced by a colour-graphic processor and colour-graphic screen housed in the student's and the teacher's terminals. The colour-graphic screen displays system diagrams of the simulated diesel engine room. It is also the engine room panel. The student's terminal consists of a colour data video display, a keyboard and a printer for logging of actions taken by the student and by the teacher, as well as normal alarm printout. The student terminal is part of the alarm and the remote machinery operation system. The student is able to call a mimic diagram to the colour display for each of the simulated sub-systems. In the mimic diagrams the trainee is able to observe the conditions of the simulated systems. Several of the simulated machinery components displayed can be operated from the student's keyboard, for example open and close a valve in the freshwater system. The same keyboard is used to acknowledge the alarms coming up. From the student's keyboard, it is also possible to make simulated overhauls of malfunctions introduced from the teacher's keyboard.

2.6 IMO's work on marine simulators

) With the present advanced marine technology and sophistication of ship automation, it was found out that contacts between researchers, designers, manufacturers and users of marine simulators is of great importance. So in September 1978 the International Maritime Organization established the International Marine Simulators Forum "IMSF". The aims of "IMSF" are:

- to provide an effective medium for the interchange of views and experiences of simulator development;
- to improve the state of art of simulators;
- to study the manufacture and utilization of marine simulators for training and examination of seamen and to improve their application for training and research;

- to advance the development and to promote the use of marine simulators in order to improve maritime safety and productivity worldwide.

The work of the "IMSF" has successfully been supported by the International Conferences on marine simulation held in 1978 at Southampton, England, in 1981 in New York, USA, and in 1984 in Rotterdam, The Netherlands.

CHAPTER 3

SIMULATOR TRAINING COURSE

"Tell me and I shall forget
Show me and I shall remember
Let me do it and I shall understand."

(Chinese proverb)

3.1 Objectives

The exercises to be used for the training course incorporate several and various objectives. For marine engineers the main objectives of a diesel engine room simulator training course are:

- to give trainees a total understanding of the engine room with the mutual dependance of all systems and machinery;
- to familiarize the trainee with the unmanned machinery space which includes alarm system, remote control of propulsion plant, alarm logging, conditions monitoring, remote control of all main pumps and automation system;
- to refresh the marine engineer's knowledge of diesel propulsion plant principles and its various components and sub-systems;
- to increase the trainee's practical skill and experience in the operation of the main engine remote control equipment and to give him also practice in responding to malfunctions occurring during the operation of diesel propulsion plant, the rapid recognition of such malfunctions and their causes, and the correct selection of measures aimed at rectifying them;
- to train junior engineers in basic engine room operations and main engine standby, such as preparation for getting underway, manoeuvring to open sea, manoeuvring into harbour, finishing with the engines, operation of auxiliary boiler, etc.
- to train also the junior engineers for the routine operation in the engine room, i.e. to train him for the daily work as an engineer on duty;

- to provide an opportunity for the marine engineer to handle wide malfunctions and failures which are either dangerous, difficult or too costly to enact on board vessel;
- to increase the engineer's confidence in demonstrating and testing the effect of varying parameters, and component deterioration on plant behaviour, such as cylinder pressures, (P_i , P_{max} , P_{comp}), rpm, air filter pressure drop, air temperature, oil temperature for turbocharger, efficiency for air cooler, short circuit, frequency, voltage, load in diesel generators, sea water temperature, lubricating oil pressure, etc.
- to improve practice's operation and enable trainees to get experience and better understanding in studies of process optimizing, fuel economy and energy saving. For example, some of these studies are:
 - . to differentiate between external and internal causes of deterioration in performance;
 - . calculation of heat balance, heat recovery and study their influence on fuel oil economy;
 - . the effect of wrong fuel oil injection timing, poor fuel oil quality, viscosity, nozzle wear, combustion performance;
 - . consequences of control loop tuning in control engineering;
 - . optimizing studies on main engine load and variable pitch performance;
 - . the influence of external conditions like weather, sea state, air and sea temperature on fuel economy, etc.
 - . the effects of deterioration (fouling and wear) in the various components such as pumps, coolers, hull, piston rings, actuators, valves, etc.

3.2 Programmes

In the present state of the art, the training programme is the main key to profitable use of training simulator. The development of the training programme is chiefly based on the fundamental aspects of a slow speed diesel engine propulsion plant operation. The typical exercises

to be used for the training course incorporate training in basic engine operation, training in emergency operations and trouble-shooting, training in control engineering, training in optimal plant operations, fuel economy and energy saving. Additionally, beside these operational possibilities, the different experience and knowledge levels of the trainees are taken into account. The programmes will therefore apply to trainees with widely differing proficiency in the operation of handling the engine room machinery on board the ships.

-) Modular training programmes are set up providing flexibility in meeting training needs. The programmes differentiate between the experienced senior engineers (chief engineers, second engineers) and less experienced junior engineers (third engineers, fourth engineers) or generally watchkeeper engineers. The training programmes proposed are divided into two general programmes. Each programme is set up in several successive exercise modules which contain a collection of tasks classified in different degrees of difficulty and complexity. The first training course is for engineers on watch and students of the third year of the higher cycle and normal cycle of studies at ISEM. The total time to be used for the training course is 35 hours. The general programme with exercise modules postulated is as follows:

Exercise module No. 1 - 4 hours

) DIESEL SIMULATOR GENERAL DESCRIPTION

-)
1. Diesel simulator configuration, working principles, models and real scale elements.
 2. Operating principles of the alarm system.
 3. Methods of communication system use.
 4. Diesel simulator plant description.

Exercise module No. 2 - 6 hours

DESCRIPTION OF THE SIMULATOR'S DYNAMIC PLANT SYSTEM MODELS

1. Explanation of symbols meaning on system models and diesel simulator plant parameters checking.
2. Demonstration of starting procedures for some selected diesel simulator systems, i.e. sea water system, piston cooling system, fuel systems, lubricating oil systems, etc.

Exercise module No. 3 - 6 hours

DIESEL SIMULATOR PLANT STARTING-UP PROCEDURE

1. Diesel simulator plant operating conditions: "dead ship", harbour operation, manoeuvring, sea passage.
2. Diesel simulator plant starting procedures from "dead ship" to standby readiness for sea passage.

Exercise module No. 4 - 4 hours

) DIESEL SIMULATOR PLANT FAULT-FINDING AND CORRECTIVE ACTION OF PREVIOUSLY "SET" FAULTS

) Exercise module No. 5 - 6 hours

COMPUTERIZED ENGINE ROOM AUTOMATION SYSTEM DESCRIPTION AND SUB-SYSTEMS DEMONSTRATION

1. Main engine condition monitoring and maintenance predication system.
2. Watchkeeping, monitoring and logging system, automation system of pumps, purifiers, compressors, etc.
3. Automation system of auxiliary engines and generators, electric power supply and required power control.
4. Main engine bridge control system and engine overload systems.

) Exercise module No. 6 - 3 hours

) SOME SELECTED PROBLEMS OF SUB-SYSTEM PERFORMANCE

) Exercise module No. 7 - 6 hours

MAIN ENGINE DIAGNOSIS - INTRODUCTION AND EXPLANATION OF SOME PHENOMENA CONCERNING MAIN ENGINE WORKING PROCESSES: COMBUSTION, INJECTION, PISTON RING CONDITION ANALYSIS

The second training course is for chief engineers as well as second engineers sent by shipping companies, and for students of the fourth year course of the higher cycle. The total time to be used for the training course is 28 hours. The general programme with exercise modules is as follows:

Exercise module No. 1 - 1 hour

DIESEL SIMULATOR GENERAL DESCRIPTION

1. Diesel simulator configuration, working principles, dynamic models and real scale elements.
2. Operating principles of the alarm system.
3. Methods of communication system use.
4. Diesel simulator plant technical and operational data.

Exercise module No. 2 - 4 hours

DIESEL SIMULATOR PLANT STARTING PROCEDURE FROM "DEAD SHIP" TO SEA PASSAGE CONDITIONS - STANDBY

Exercise module No. 3 - 4 hours

COMPUTERIZED ENGINE ROOM AUTOMATION SYSTEM. DESCRIPTION AND SUB-SYSTEMS DEMONSTRATION

1. Main engine condition monitoring and maintenance prediction system.
2. Watchkeeping, monitoring and logging system. Automation systems of pumps, purifiers, compressors, etc.
3. Automation systems of auxiliary engines and generators. Electric power supply and required power control.
4. Main engine bridge control system and engine overload protection arrangements.

Exercise module No. 4 - 3 hours

MAIN ENGINE REMOTE CONTROL - SUB-SYSTEMS - DESIGN ADJUSTMENTS AND ON-BOARD MAINTENANCE

Exercise module No. 5 - 6 hours

MAIN ENGINE CONDITION MONITORING AND DIAGNOSIS

1. Taking cylinder indicator diagrams.
2. Piston rings monitoring.
3. Metal temperature monitoring of cylinder liners and head covers.

4. Cylinder faults detection through indicator diagrams analysis.
5. Engine conditions analysis.
6. Trend condition prediction of engine wear based on partial analyses.

Exercise module No. 6 - 4 hours

SIMULATED ENGINE ROOM PLANT PERFORMANCE WITH INTRODUCED FAULTS.
DEMONSTRATION AND INTERPRETATION OF RESULTS MASTERING OF DIAGNOSIS
AND FAULT-FINDING FOR SHIP'S ENGINE ROOM PLANTS

Exercise module No. 7 - 6 hours

CONTROLLERS

Influence of controllers setting on their proper performance.
Demonstration of such effects on so-called hardware regulator.

The two programmes are designed as general programmes, however a more detailed, expanded and completed programme of any course may be realised in consultation with the biggest shipping companies. The consultation will ensure that the simulator training course agrees with the company's requirements with respect to their operational philosophy and procedures.

3.3 Implementation

In order to achieve high quality training and to meet the student's simulator training objectives, two qualified instructors should be appointed and affiliated to the simulator training programmes. The instructors, or at least one of them, should be a chief engineer who has gained sufficient practical experience. They should also attend special simulator training courses to gain knowledge on simulator use. The instructors may work together or solely, according to the complexity of the exercises and the specific group to be trained (junior, senior, chief engineer). Their close co-operation is important to ensure high quality training, therefore, they would be better able to modify successive courses, not only to take account of the lessons learned in previous courses but also to address specific weaknesses identified among particular groups of trainees. The instructors have to assume a

great task. Each one must always bear in mind that the exercises shall give the students training on their level of knowledge. Each exercise must be carefully pre-planned with regard to purpose and student's level of knowledge. The exercises must be realistic, care should be taken that the instructor is not bored with many sample exercises and begins to use the simulator to experiment for himself. All equipment and instruments should be checked and made ready for the trainees. The students should be asked to give their own opinion and indicate whether they have understood the exercises. The simulator should not be the lazy teacher's escape, insofar as programming an exercise and leaving the students to operate the simulator in his absence. Even though instructors may be bored with repeating the same exercises over and over again, each exercise is new to the trainee and this should be borne in mind.

The instructor has been found to be one of the most important elements in simulator training, although simulator and training programme characteristics also have a substantial impact on the effectiveness of training. For reasons of effectiveness also, during each training course the maximum number of course participants is recommended to be six. The simulator/trainee ratio would be more appropriate, however, this limitation would contribute to avoiding placing too much stress on the instructor(s). During the training on the simulator, the trainees can be divided into two groups. One group would execute an exercise, while the other group would act as a critical observer. The two groups could then alternate roles.

The implementation of the simulator training course for students following studies at ISEM should be during the second semester of the corresponding years, as mentioned earlier. On completion of the training course the Maritime Institute (ISEM) would issue a certificate to certify that the trainee has completed a training course on diesel engine room simulators at the appropriate level. A model of this certificate is shown on the following page.

HIGHER INSTITUTE FOR
MARTIME STUDIES

MINISTRY OF MARITIME FISHERIES
AND MERCHANT MARINE

C E R T I F I C A T E

OF COURSE COMPLETION ON DIESEL ENGINE ROOM SIMULATOR

This is to certify that Mr has completed
a training course for marine engineer
on a Diesel Engine Room Simulator, thus updating his knowledge in a modern
fully automated ship power plant operation.

Casablanca the

Head of Department

CHAPTER 4

CONCLUSION

It is evident from the changing technological world that the national marine engineer's requirement to handle economically, efficiently and safely the main ship machinery today and in the future, will be different in many aspects from the role of those trained in the past. Thus the requirement becomes more and more demanding to train the marine engineers by applying the latest technology. The provision of a diesel engine room simulator for training is highly necessary when viewed in consideration of increasing engine room complexity.

A diesel engine room simulator is a valuable training aid which can contribute to the training of marine engineers for the safe, efficient and economic operation of modern automated ship's machinery. Besides the training of marine engineers, this simulator can also provide a positive contribution to the training of masters, mates, and marine pilots. It is invaluable in assisting them to gain more insight into engine room operation, and its effect on the manoeuvring capabilities of a vessel. It will increase their knowledge of main engine thermal overload and damage possibilities while manoeuvring.

The use of environmental sound effects in the simulator increases the feeling of reality and conveys the stress level of the trainees. The stress aspect in simulator training is important because the exercises are more difficult to realize under pressure than without. The sound situation must therefore be similar to that on board ships. It should be borne in mind that an engineer judges the engine's condition by its sound and his own senses.

The diesel engine room simulators which comprise a Colour Graphic System lack the realistic atmosphere of the engine room. However the first simulator detailed in this thesis has a better built-in, realistic engine room environment, a sufficient flexibility in the program and simulator potential.

Tailored training programs are identified with different groups of marine engineers to achieve the most effective training. The programs are outlined as general programs, however, a more detailed, expanded and completed program may be realized in consultation with the biggest shipping companies.

The instructor is one of the most important elements in simulator training, although the simulator and the training program characteristics and the number of course participants during an exercise have a substantial impact on the training effectiveness.

The use of diesel engine room training simulators cannot completely replace the training on board ships, however the training at sea and the simulator training are complementary to one another. This simulator training is a valuable supplement for gaining in greater detail and more speedily the required sea experience and it also helps to prepare the students for their first sea practice.

The shipping companies operating in the country must be aware of the importance of simulator training and its impact on the cost-effectiveness and efficient operation of their ships. A good, close cooperation and coordination of the shipping companies, particularly the large ones, is required in order to achieve the installation of the proposed diesel engine room simulator at the Higher Institute for Maritime Studies.

The proposed machinery is based on the parameters of a slow-speed diesel main engine, type SULZER, six cylinders, two strokes, for a bulk carrier. The simulator should also have a sufficient built-in flexibility in the program, potential and realistic engine room environment.

It is the general conviction of shipowners who have trained their staff on ship's simulators that the number of machinery breakdowns has been significantly reduced due to simulator training.

BIBLIOGRAPHY

Annuaire de l'Afrique et du moyen orient 1979, volume I, l'economie et la politique (supplement annuel à jeune Afric).

Europa Year Book 1984, A world survey, Volume II.
Europa Publications Limited, 1984, England.

Newspaper: "Maroc Soir", Edition No. 4.256.
Le transport maritime.

Documents from the Ministry of Maritime Fisheries and Merchant Marine,
"Training Department".

Sea Trade, Arab Shipping Guide, notes about Morocco.

Report on Nautical Education and Training in Europe.
The Nautical Institute, October 1977.

International Convention on Standards of Training, Certification and
Watchkeeping for Seafarers, 1978, of the International Maritime Organization.

Monographs of seafarers' vocational training programmes in various countries
of the International Labour Organization.

Journée de Reflexion sur les Cadres Naviguants de la Marine Marchande,
organisée par ISEM/CCAM, Casablanca, le 10 juin 1982.

IMO's Technical Assistance Programme.

Seminar on: The Practice of Marine Education and Training in Europe
and the new IMCO Requirements, Amsterdam, 5-6 June 1980.

First International Conference on Marine Simulation, 1978.
MARSIM 78. The College of Nautical Studies, Southampton.
5-8 September 1978.

Proceedings of the Second International Conference on Marine Simulation
1981. MARSIM 81. King's Point, New York, USA.

Proceedings of the Third International Conference on Marine Simulation
1984. MARSIM 84. Rotterdam, the Netherlands, 19-22 June 1984.

The Journal of Navigation of the Royal Institute of Navigation, London.
Vol. 34, No. 2, 1981.

Magazine "MER", March 1984.

"Motor Ship", March 1979.
"Motor Ship", July 1983.

Conference on: Education and Training for Seafarers. What policy for
the 1990's. 9-10 February 1984.
Institute of Marine Engineers, London.

Conference on: Ship Operation and Safety
Southampton, 7-9 April 1981.

Macgregor News 86, December 1979.
Macgregor News 88, June 1979.

Marin Report, No. 18, June 1984.

Simulator's International Guide.
Editor R.A. Collacot.
Published in Great Britain by Gower Press Ltd.
Epping Essex, No. ISBN 0716101718.