

Southern Adventist University
KnowledgeExchange@Southern

Faculty Works

Physics and Engineering Department

3-14-2008

Kronecker-Product Periodic Systems of Small Gas-Phase Molecules and the Search for Order in Atomic Ensembles of Any Phase

Ray Hefferlin

Follow this and additional works at: https://knowledge.e.southern.edu/facworks_physics

Recommended Citation

Hefferlin, Ray, "Kronecker-Product Periodic Systems of Small Gas-Phase Molecules and the Search for Order in Atomic Ensembles of Any Phase" (2008). *Faculty Works*. 10.

https://knowledge.e.southern.edu/facworks_physics/10

This Article is brought to you for free and open access by the Physics and Engineering Department at KnowledgeExchange@Southern. It has been accepted for inclusion in Faculty Works by an authorized administrator of KnowledgeExchange@Southern. For more information, please contact jspears@southern.edu.

Kronecker-Product Periodic Systems of Small Gas-Phase Molecules and the Search for Order in Atomic Ensembles of Any Phase

Ray Hefferlin*

Southern Adventist University, Collegedale, Tennessee 37315, USA

Abstract: The periodic law, manifested in the chart of the elements, is so fundamental in chemistry and related areas of physics that the question arises "Might periodicity among molecules also be embodied in a periodic system?" This review paper details how a particular periodic system of gas-phase diatomic molecules, allowing for the forecasting of thousands of new data, was developed. It can include ionized and even quarked-nuclei molecules and it coincides with locality (averaging) and the additivity found in some data; it has interesting vector properties, and it may be related in challenging ways to partial order. The review then explains how periodic systems for triatomic and four-atomic species are evolving along a similar path. The systems rest largely upon exhaustive comparisons of tabulated data, relate to some extent to the octet rule, and include reducible representations of the dynamic group $SO(4)$ in higher spaces. Finally, the paper shows how periodicity can be quantified in data for larger molecules. Data for properties of homologous or substituted molecules, in any phase, are quantified with a vector index, and the index for one set can be transformed into that for another set.

1. INTRODUCTION

Here we present a review of a quantitative search for periodicity in molecules. Successes in the work, which has spanned over three decades, are very largely attributable to the author's students at Southern Adventist University (SAU) and to the intermittent but crucial collaborations of numerous colleagues around the world. These collaborations are peculiar in that only a few of the participants are chemists, that some aspects of the chemistry were therefore re-phrased, and that some of the work was done by quantifying patterns seen graphically.

The SAU group has conceived a paradigm that constructs periodic systems for molecules with any number of atoms. The system for diatomic molecules has been exhaustively tested and has predictive capability; the system for triatomics has been partially tested and has some predictive power. Theoretical support is provided by reducible representations, in the Hilbert spaces $\mathcal{H}(2)$ and $\mathcal{H}(3)$ of diatomic and triatomic molecules, of the group $SO(4)$ multiplied (in the Kronecker sense) once or twice by itself [$\mathcal{H}(1)$ is the space of atoms]. Included in the paradigm is the concept that atoms maintain enough of their individualities to "own" their valence-shell electrons, and to echo their element-chart periodicity, when bonded into molecules.

The initial restriction to molecules in the gas phase is then relaxed in a survey of triatomic molecules in any phase. Data for still larger molecules, in any phase, are being approached one molecular similarity class after another — such as transition-metal oxides or halogen-substituted benzenes. This approach is due to the scarcity of data.

A vector index is formulated for each similarity class and the index for one class can be transformed into that for any other class by means of dyadics; both the indices and the dyadics show clear footprints of periodicity.

Other efforts to classify molecules consistently with atomic periodicity exist, many having exquisite beauty. They have been described elsewhere [1,2] and are largely omitted in this parochial review at the request of the editor. This review is roughly chronological, but since many of the topics overlap and contribute to each other, every step (and mis-step) is not detailed. We hope that the brief paragraphs on partial order in Section 11.1 will suggest new areas for research into partial order, which is so appropriate for this issue.

2. BACKGROUND: THE NEED FOR MOLECULAR DATA

That data are needed is hardly a new realization, but an illustration tightly related to this review will be helpful. Astrophysicists attribute the origin of stellar luminosity to nuclear fusion reactions. Testing their models includes spectroscopic measurement of the numbers of atoms and molecules per unit area on the stellar surface. This measurement, in turn, requires knowing the ability of the species to absorb light coming up from the inside of the star at a given frequency (as well as knowing several other factors such as the temperature). This ability to absorb is named, for atoms, the f -value (oscillator strength) or, with different parameters, the Einstein absorption coefficient. For molecules, there are variously-defined band f -values and, also with different parameters, transition moments. In general, all of these — as well as state lifetimes — are called intensity constants.

A similar situation applies to interstellar matter, to dark nebulae, and to the earth's atmosphere (in which the species populations are crucial to studies of the ozone hole and of climate change, and for which other techniques such as probes are available). An analogous situation applies to combustion engines, arcs, incinerators, and luminous nebulae; however, in these cases *emission* intensity constants are needed instead of *absorption* intensity constants.

The determinations of intensity constants, in the laboratory or by computation, are difficult tasks and cannot be

*Address correspondence to this author at the Southern Adventist University, Collegedale, Tennessee 37315, USA; E-mail: hefferln@southern.edu

described here. The salient fact is that too few of them are known. The author heard of a case, some 50 years ago, where needed transition moments for a molecule of astro-physical interest were estimated by averaging known moments for neighboring molecules! The meanings of “neighboring” (similar) are scattered throughout this review, since any architecture of a periodic system must place similar molecules as neighbors.

3. THE ODYSSEY BEGINS: A COMPILATION OF ATOMIC OSCILLATOR STRENGTHS

Our group had devoted some years to the measurement of f -values for neutral atoms excited in iron, manganese, and chromium arcs, and to the compilation of f -values from the literature. Russian publications on spectroscopy contributed greatly to this work, and on the flip side this work contributed to the very fruitful collaborations on periodic systems of molecules which are to be described in Sections 5.5 and 5.7. This compilation was given to the National Bureau of Standards (now NIST), which absorbed it into its superb publications. Then our group found that, for a given transition and sequence of atoms and isoelectronic ions (*e.g.*, the $2s$ - $2p$ transition of Li^+ , Be^{2+} , B^{3+} , ...) the f -values often have a hyperbolic dependence on the ionization stage [3]. This dependence was reformulated by the NIST group and is now known as the $1/Z$ relation. Thus, the beginning of the odyssey resulted in a healthy respect for how tedious it is to make critical tables of spectroscopic constants and also of a suspicion that systematic trends are to be found among the constants.

4. THE LOGICAL NEXT STEP: A COMPILATION OF DIATOMIC MOLECULAR INTENSITY CONSTANTS

The SAU group then embarked upon the compilation [4], and upon graphical systematics [5, 6] of, diatomic molecular band intensity constants. The graphs consist of nine unrelated cases where there were sufficient numbers of one or another kind of intensity constant: group-1 and group-7 dimers; group-1 hydrides; group-2 oxides; group-3 halides; and for 12 to 15 electron, neutral and ionized, molecular isoelectronic series. The plots have large error bars or discrepancies, but one could be used to estimate a reasonably defensible intensity constant. Another shows that the necessarily linear behaviors of the transition moments for OH and HF^+ (two species with 9 electrons) and for SH and HCl^+ (17 electrons) are parallel — suggesting the importance of isoelectronic and isovalent molecules.

5. CONSTRUCTION OF THE KRONECKER-PRODUCT PERIODIC SYSTEM FOR DIATOMIC MOLECULES WITH DATA ACCUMULATED TO 1978

5.1. A “Eureka!” Moment, Late 1976

The graphs led to the constructing of “periodic tables” for dimers, hydrides, and for oxides and halides of main-group atoms [5]. The first two of these tables were based on molecular orbital configurations. The others were based on data for dissociation potentials (D_0°). Syrkin, in honor of the anniversary of Mendeleev’s death [7], had published tables very similar to the first two.

Years later, the Moscow State University molecular spectroscopy laboratory published a superb new critically-analyzed compilation of transition-moments [8,9]. Graphs from this compilation of data for isoelectronic and isovalent series were sufficiently well-behaved that functions of the appropriate variables could be eye-ball fitted to the data, and two transition moments (for CaCl and SrCl) were predicted [10].

For molecules with one or two rare-gas atoms, D_0° and vibration frequencies (ω_e) are so small, and internuclear separations (r_e) are so large, that these species are quite unique (even though some of their other property data are in normal ranges). A graph of D_0° of dimers and of oxides of the elements, Fig. (1), demonstrates [11] that zinc, cadmium, and (not shown) mercury molecules, at the ends of the transition-metal series, act like closed-shell rare-gas molecules. This graph led to defining the property surfaces or terrains on coordinate systems specifically suited to two-atom systems, as explained in the next section.

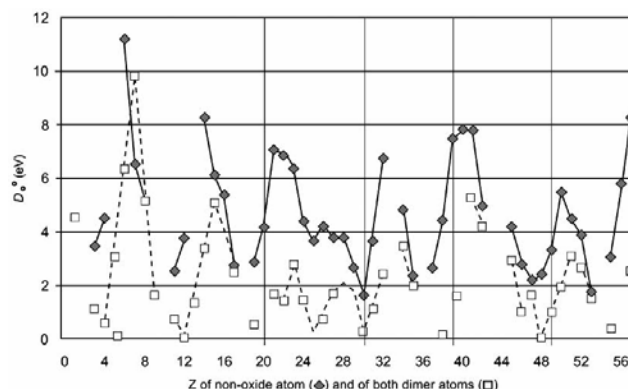

Fig. (1). Dissociation energies of homonuclear and oxide molecules out to $Z = 56$. The domain is divided into seven regions, the fourth and sixth of which are where transition-metal molecules reside. Rare-gas dimers and oxides have near-zero values at abscissae 2, 10, 18, 36, and 54 (not shown); Be, Mg, and Sr dimers have the very low values of van der Waals species at 4, 12, 20 (not shown), and 38; Zn and Cd dimers have the very low values signaling the ends of transition-metal series at $Z = 30$ and 48. Additional evidence that Zn, Cd, and Hg molecules form a physical (as well as configurational) boundary for a periodic-system area is found in low-magnitude data for such species as ZnCd, ZnHg, and CdHg

5.2. The Definition of Fixed-Period Areas of the Diatomic-Molecule Periodic System

The first step in defining how property data are distributed in suitable coordinates was made graphically. It was the plot, mentioned just above, of molecular dimers and of oxides on an axis which enumerates the one atomic number Z . The peaks of this familiar graph have a surprising aspect — the peaks for the dimers and oxides are not at the same places. For instance, the highest values of D_0° for molecules with second-period atoms have Z values at 7 and 6 (N in N_2 and C in CO), Fig. (1), and those for molecules with third-period atoms have Z -values of 15 and 14 (P in P_2 and Si in SiO). This repeated behavior led to the understanding that the molecules with the highest D_0° values are isoelectronic (in that portion of the isoelectronic sequence not near inert-

gas molecules). The same relationship is seen for other properties.

The incomplete “periodic tables” described in Section 5.1 then evolved into square and rectangular areas populated by fixed-period molecules as follows: the x and y axes of a plane were labeled Z_1 and Z_2 . Perpendicular lines were drawn from points on each axis at the atomic magic numbers Z_i of the rare-gas atoms. The same was done for Z_i of Zn, Cd, and Hg and for Z_i of the elements terminating the lanthanoids and actinoids. These lines defined the square and rectangular areas [11] shown in Fig. (2). How many kinds of areas are there? It depends on whether or not the types of atoms (main-group, transition-metal, and rare-earth) are separated, and on whether areas containing homonuclear species (e.g. N_2 , P_2) are kept together with areas having atoms from different periods (e.g., PN).

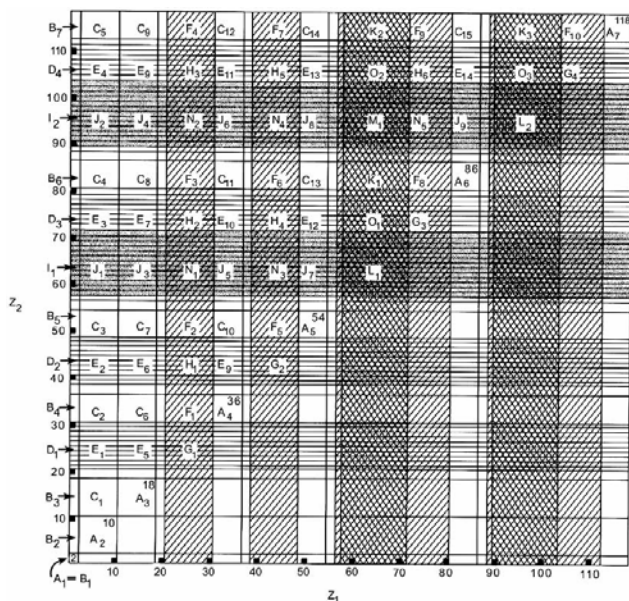

Fig. (2). The space of diatomic molecules out to atomic numbers 118. Hatched areas are populated by species containing transition-metal and rare-earth atoms. The areas are designated arbitrarily as follows: A, G, and L, main-group, transition-metal, and rare-earth pairs containing homonuclear molecules; B, main-group hydrides; $A_1=B_1$ contain H_2 , HeH, and HeH₂; D, transition-metal hydrides; I, rare-earth hydrides; C, H, and M, main-group, transition-metal, and rare-earth pairs not containing homonuclears; E and F, molecules with the main-group atom on one axis and the transition-metal atom on the other; J and K, those with the main-group atom on one axis and with the rare-earth atom on the other; N and O, molecules with the transition-metal atom on one axis and the rare-earth atom on the other. Thus there are 15 areas; however merging A with C, E with F, G with H, J with K, L with M, and N with O results in the nine final areas. Used by permission from *Periodic Systems and their Relation to the Systematic Analysis of Molecular Data*, The Edwen Mellen Press, Lewiston, NY, from Ref. [18], and by permission from Elsevier Publishers, from [Ref. 11].

The process, then, consists of dividing the Z_1, Z_2 plane into areas which are enumerated according to the period numbers, R_1 and R_2 , of the atoms, such as in Fig. (3); within the areas the molecules are enumerated according to the group numbers, C_1 and C_2 , of the atoms. This exchange of

two coordinates for four seems disingenuous but the evidence to be presented supports its usefulness.

Among several enumerations of fixed-period areas, three were studied in detail and one proved to be optimal. The first had all atoms in a given period kept together; this meant that the areas have places for 32×32 molecules to accommodate diatomics with atoms from periods 6 and 7. Consequently, the other areas have gaps, most spectacularly the area with $R_1 = R_2 = 1$, having H_2 , HeH, HHe, and He₂ on its corners, as can be seen in Fig. (8) of [11]. The second had 15 kinds of areas, as shown in Fig. (5) of [11]. The third, optimal, enumeration (shown in Fig. (9) of [11] and here in Fig. (4)) is derived from the second and has nine areas. Fig. (6) of Ref. [11] shows a few of the blocks in enough detail that molecular locations can be identified. Its main advantage is that molecules with main group atoms (s and p) are kept together; given that these species have been the most studied, there was a greater chance of understanding the trends in the data.

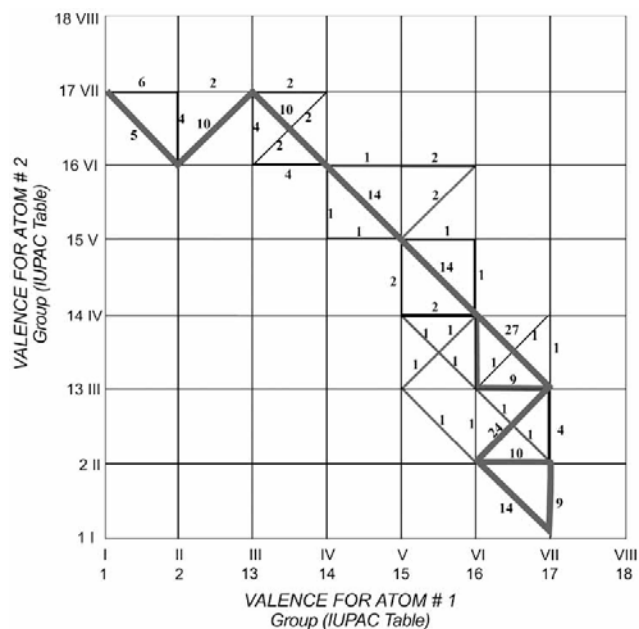

Fig. (3). Several properties of main-group ground-state diatomic molecules, with atoms from various periods (R_1, R_2), were studied. In each case, if possible, the line starting from the highest (or lowest) value(s) and going the least rapidly toward zero was drawn. The starting values were either at $(C_1, C_2) = (5, 5)$ or at $(6, 4)$ and $(4, 6)$, i.e., at the positions of N_2 or CO. The asymmetry of the diagram is due to the restriction $R_1 \leq R_2$. The totality of lines between addresses in the plane is indicated by the width of the lines and by the accompanying number. Neglecting the lines with small weights, it is clear that the main part of the ridge (valley) of extreme data lies on the isoelectronic line $C_1 + C_2 = 10$.

5.3. Distributions of Data on Fixed-Period (R_1, R_2) Areas

The investigation began with by printing molecular configurations, terms, or values on the fixed-period molecular areas. Thus there came about an understanding of how the data are distributed — at least on the 8×8 “chessboard” areas for main-group molecules:

- It was found that neutral molecules near the middles of diagonal sequences seemed to have the similar sta-

bilities. For instance, among molecules with $(R_1, R_2) = (2, 2)$, the very stable CO, N₂, and OC are isoelectronic, lying on the diagonal $C_1 + C_2 = 10$ (the total number of their valence-shell electrons) [12].

- b. Starting with the molecule having the highest D_0° , ω_e , and ionization potential (IP), there is a line of least descent on the chessboard; similarly, starting with the molecule having the lowest r_e , total entropy at 1kK (S°_{1000}), logarithm of the partition function [$Q(1000)$], or logarithm of the equilibrium constant between isolated atoms and diatomic molecules ($\log_p K_{1000}$), there is a line of least ascent [12]. The lines for each of these properties and for each choice of the fixed periods define a very clear ridge or valley which (if one does not extend it too close to molecules with a rare-gas atom) falls on the same diagonal as described above. Fig. (3) shows the result of this investigation.
- c. Assuming that covalently-bonded molecules with p atoms which "obey" the rule of 8 are the most stable fails to place them on the lines described above because these molecules are on the major diagonal of their areas (e.g., N₂, O₂, and F₂). However, dative bonding can cause (an isomer of) CO to join the list; then CO, N₂, and OC *do* lie on the same diagonal ridge [13]. Similar considerations apply to areas with other (R_1, R_2) . An algebraic study of molecules containing period-4 transition-metal atoms with covalent and dative bonds has helped map their portions of the (Z_1, Z_2) plane [14].
- d. On the fixed-period areas with large numbers of data (those containing the lighter molecules), contour lines were sketched. The data of highest magnitude appear to be surrounded by sausage-shaped contours surrounding the same 10 valence-shell electron ridges.
- e. A way of confirming the results was contributed by F.-A. Kong [15], who had plotted data for several properties of diatomics against a "molecular number" that is piecewise continuous with respect to $Z_1 + Z_2$.

Ionized molecules can be addressed on these same fixed-period chessboards. It is obvious from orbital configurations that N₂²⁺ should be placed at the same location as C₂, and it seems reasonable that N₂⁺ should be located half-way between these two. But should NO⁺ be placed at CO or at N₂? Since the question has nothing to do with dissociation channels, both of these options were rejected and it was assumed that if a molecule having atoms with numbers Z_1 and Z_2 has positive charge q , then its address should be $(Z_1 - q/2, Z_2 - q/2)$ [16,17].

By extension, hypothetical molecules containing quarked nuclei (*i.e.* molecules having nuclear charges differing from integers by $e/3$, where e is the electron charge) were later placed on the grids so that their properties could be estimated by interpolation [Ref. 18, pp. 330-350].

The next question is, How are these fixed-period areas to be arranged from period to period?

5.4. Stacking of Fixed-Period Molecule Areas to Complete the Three-Dimensional Periodic System of Diatomic Molecules

The numerical data lying at fixed-*group* addresses in the various squares or rectangles described above tend to vary in a quite similar monotonic way with respect to the period numbers of the two atoms. Graphical and statistical analyses found that the variation was the most monotonic with respect to $(R_1 \cdot R_2)$ [11]. A function for the internuclear separation r_e ,

$$r_e = A + \frac{1}{2} \log(R_1 \cdot R_2), \quad (1)$$

where A is a constant dependent upon the group numbers, has been derived theoretically [19]. Its profile is in accord with the known uniqueness of period-2 atoms (equivalently, with second periodicity) in the element chart and it (in conjunction with Badger's rule) suggests a function with which to begin fitting for the vibration frequency ω_e .

As stated in Section 5.2, the optimum number of fixed-period areas was found to be nine. Thus, the entire process resulted in nine blocks of areas, stacked according to Eq. (1), and the molecules are addressed on each area according to C_1 and C_2 . This ensemble forms the *three-dimensional* periodic system of diatomic molecules. But is there any theoretical justification for this architecture? Sections 5.6 to 5.8 deals with this question.

5.5. Help from an Unexpected Quarter, November 1978 to June 1979

The author was invited by the American and Soviet Academies of Sciences to serve as an exchange scholar in the field of optical spectroscopy (measuring spectroscopic constants of Dy⁺ and Dy²⁺ and investigating the spectrum of CaXe at Leningrad State University, LSU [20]). This invitation gave an unparalleled opportunity to explore the subject of molecular periodicity on the side: the periodic table of the elements had been a symbol of national pride and study in Russia for decades and several investigators had considered an extension into the space of diatomic or even larger molecules. Morozov had in 1907 assembled the alkanes into a periodic table [2]; Syrkin had in 1971 published a periodic system of practically the same molecules as those contained in the classification described in Section 4 [7]; and the chemistry faculty at Leningrad State University had for years been assembling molecular data for their eventual classification into a "supermatrix" [21].

Soon after our first meeting, Monyakin constructed a beautiful system of diatomic molecules which also consisted of three-dimensional blocks [Ref. 18, pp. 438-442; Ref. 22]. There are 16 of them, and the coordinates are different than those of the system built by our group. What was the relationship between these two systems? This question caused much concern for over two years, and its resolution is given in Section 5.9.

5.6. Using the New Data to Improve Previous Results and to Produce Visual Representations

After the exchange trip, the magnificent 1979 compilation of molecular properties of Huber and Herzberg [23]

appeared, and the SAU group had collected many additional data for properties for rare-gas molecules and alkaline-earth pairs from the literature. All of this led to the assembly of a new data base so that the enumerated steps in Section 5.3 could be redone.

Also, our group sought attractive presentations of the system in three dimensions. For example, a poster showed the stacked areas containing main-group molecules twice, at slightly different angles, such that by looking at the display with eyes crossed creates a three-dimensional image [Ref. 18, pp. 471-473; Ref. 24]. The molecules' internuclear separations were shown as balls of various radii. As another example, molecular symbols were printed on each area, the areas were glued to blocks of wood, and these were stacked to create a truly three-dimensional display. Fig. (4) is a two-dimensional representation of this display. Finally, the areas can be mapped onto Möbius strips, which can be stacked according to Eq. (1). This representation eliminates redundant molecules on $R_1 = R_2$ areas [25].

5.7. A Molecular Classification from Group Theory, Russia, January to July 1981

The major advance during a second exchange visit was to extend the existing group theoretical representations of the periodic table of the elements, which consists of multiplets of state vectors in Hilbert space $\mathcal{H}(1)$ [26-32], to molecules. The appropriate irreducible representations for diatomic and triatomic molecular states were derived, largely thanks to G. V. Zhuvikin (LSU) [33-36].

This advance involved starting out with the several group-dynamic chains that had led to representations in slightly different forms of the element chart. Then it required the creation, using ladder operators, of the multiplets of state vectors, for each chain, in the spaces $\mathcal{H}(2)$ and $\mathcal{H}(3)$.

The mathematical procedure is analogous to the determination of configurations for two or three electrons using Clebsch-Gordan coefficients [37], and therefore we use nomenclature such as “chemical angular momentum” and

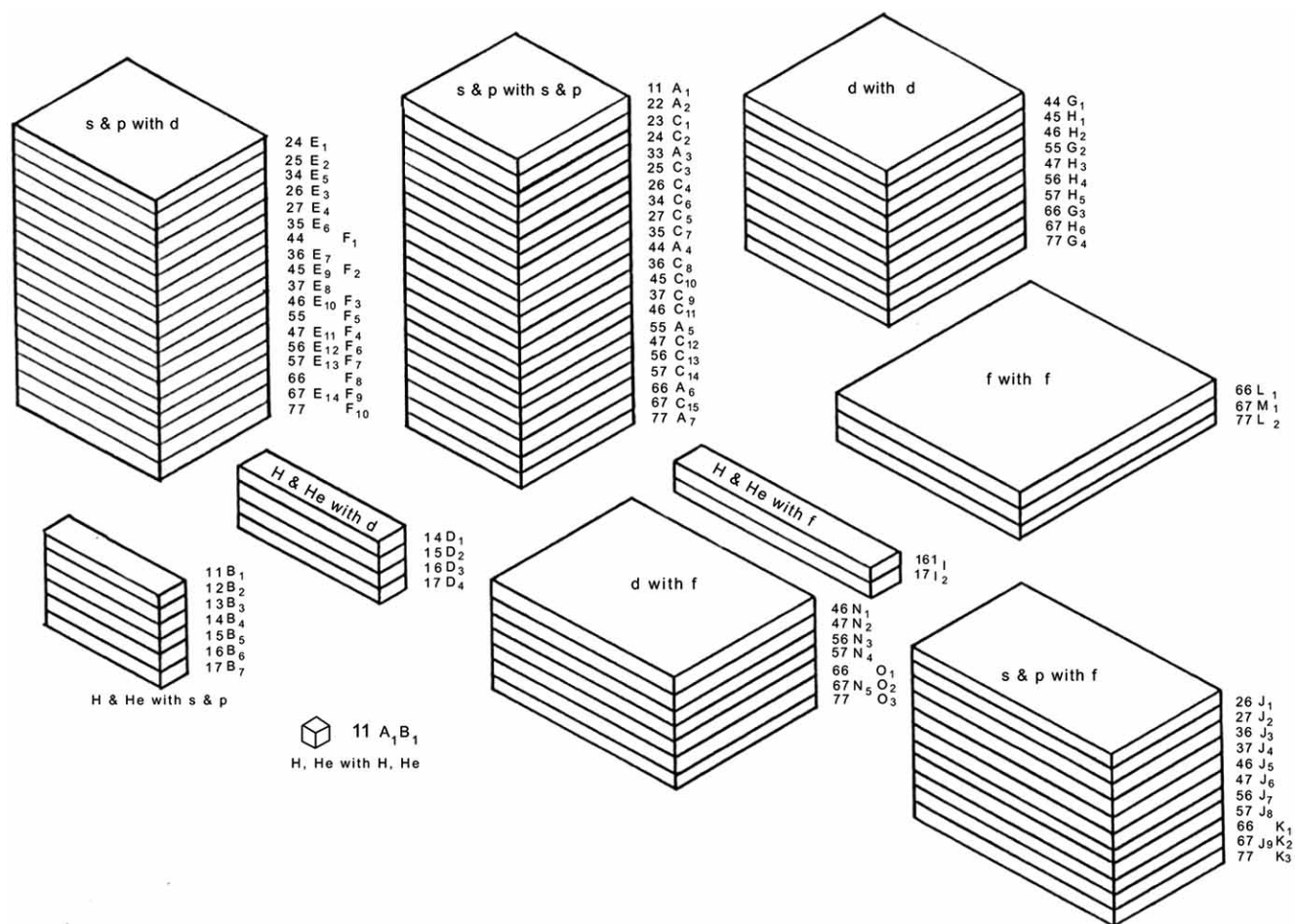

Fig. (4). The nine blocks formed from stacking the 15 kinds of areas enumerated in Fig. (2). By the side of each block are the area notations. The little cube “11 A_1B_1 ” belongs either on one end of the top of “H & He with $s \& p$ ” or on a corner of the top of “ $s \& p$ with $s \& p$ ”. It is not a tenth block, even though placed alone in this rendering — the situation is analogous to the locations of H on the element chart, which has caused so much frustration that hydrogen is sometimes put all by itself, and of He, which is sometimes found over Be instead of over Ne.

“chemical spin” (which is quite distasteful to more abstract mathematicians). This work continued after the exchange visit was over, as will now be described.

5.8. The Group Dynamic Classification Provides Theoretical Support for the Periodic System

It was found, by graphing data for the irreducible representations of several different dynamic-group chains, that agreement with the molecular data was by far the most satisfactory with $SO(3) \otimes SU(2)_s \otimes SO(3) \otimes SU(2)_s$ as seen in Fig. (5). All the multiplets for diatomic and triatomic molecules were derived, *i.e.*, the complete periodic systems (in this group representation) were built [38], and all the molecular symbols in the multiplets for diatomic species are presented on two wall charts [39]. Additional important results come from theorems relating various ways of writing equations for observables [35]. One of these theorems supposes that molecular data are inscribed in a “first-order” matrix $\mathbf{P}(1)$; it states that

$$\langle AB | \mathbf{P}(1)_{AB} | AB \rangle = (1/2) \langle AA | \mathbf{P}(1)_{AA} | AA \rangle + (1/2) \langle BB | \mathbf{P}(1)_{BB} | BB \rangle \quad (2)$$

where the heteronuclear-molecule matrix element is $\mathbf{P}(1)_{AB}$ and the homonuclear-molecule matrix elements are $\mathbf{P}(1)_{AA}$ and $\mathbf{P}(1)_{BB}$. There is an analogous theorem for triatomic molecules. They both state that some molecular data can be written as the average of corresponding data for neighboring homonuclear molecules; this relates to averaging as it has been discussed in Section 2 and will be discussed again in Section 10.2. Another theorem suggests that some diatomic molecular data can be written as the sum of the constituent atomic data, and a third, involving a “second-order” matrix $\mathbf{P}(2)$, suggests that some triatomic molecular data can be written as the sum of the constituent diatomic molecular data. Data additivity will be considered in the following section.

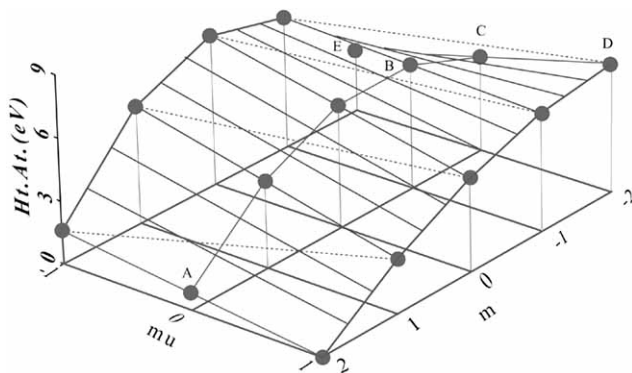

Fig. (5). Dissociation energy for the 3D multiplet of $(R_1, R_2) = (2, 2)$ diatomic molecules plotted on the z -component quantum numbers of the chemical angular momentum (m) and of the chemical spin (μ) related to the group $SO(3) \times SU(2)_s$. A, C, D, and E indicate the positions of FNe, BC, C_2 , and B_2 ; B indicates the location of a linear superposition of BO and CN (all of these molecular formulae have normalization constants). The dashed lines with approximately constant ordinate connect isoelectronic species with totals of 18, 16, 14, and 12 electrons from left to right. The canting of the surface makes least-squares fitting extremely difficult.

This periodic system derived from the group $SO(3) \otimes SU(2)_s \otimes SO(3) \otimes SU(2)_s$ and from Eq. (1) serves as an alternative to the Kronecker-product periodic system in *somewhat* the same way as the “short-form” chart of the elements serves as an alternative to the long form, where the transition-metals are separate from the main-group elements. The fact that it is a *viable* alternative is less obvious — firstly, because the irreducible representations produce molecular states consisting of linear combinations of molecules, and secondly because of the very large number of multiplets. The linear combinations are analogous to the multitudes of isotopes implicit in compartments of the periodic chart of the elements, and the molecules in the combinations usually have similar data. The large number of multiplets simply increases the size of the display [39].

If, in the development of the group-dynamic system, *reducible* representations of the group $SO(4) \otimes SO(4)$ are used instead of irreducible representations; are suitably partitioned into combinations of s , p , d , and f groups; and are used with Eq. (1), then they reproduce the areas of the 9-block system of diatomic molecules and give it a partial theoretical basis [17,35].

5.9. Completion of the Four-Dimensional Periodic System of Diatomic Molecules

A combination of several factors — passing comments by a student and by C.E. Wulfman (University of the Pacific, retired); the group dynamics treatment just described; a couple of papers showing molecular combinations in “multiplication tables”; and the long process of seeking to deconvolute Monyakin’s system into an element chart that could be self-multiplied to reconstitute his system (and realizing that it was very close to the form of the periodic chart popular in Russia) — resulted in the (now obvious) realization that Monyakin’s system and our group’s system could be reconciled: they were both Kronecker products of periodic charts (different charts) of the elements with themselves [22]. To be more precise, they are both Kronecker products of zero matrices in which the element charts have been embedded.

With this formulation, the quest for a periodic system of diatomic molecules is concluded. It is a four-dimensional architecture formed by a Kronecker product of any chart of the elements embedded in a square null matrix. The concept is shown in Figs. (6) to (8).

$$\begin{pmatrix} \text{Li} & \text{Be} \\ \text{Na} & \text{Mg} \end{pmatrix} \otimes \begin{pmatrix} \text{Li} & \text{Be} \\ \text{Na} & \text{Mg} \end{pmatrix} = \begin{pmatrix} \text{Li}_2 & \text{LiBe} & \text{BeLi} & \text{Be}_2 \\ \text{LiNa} & \text{LiMg} & \text{BeNa} & \text{BeMg} \\ \text{NaLi} & \text{NaBe} & \text{MgLi} & \text{MgBe} \\ \text{Na}_2 & \text{NaMg} & \text{MgNa} & \text{Mg}_2 \end{pmatrix}$$

Fig. (6). Imagine that there are only four elements in the Mendeleev chart, and that they are arranged in a 2×2 matrix. The Kronecker product produces a 4×4 matrix which contains four 2×2 submatrices; one of them has elements Li_2 , LiBe , LiNa , and LiMg .

The symbols like C and O (for carbon and oxygen) are entries in the element-chart matrix, and so “multiplied” symbols like CO will appear in the Kronecker-product matrix. We will encounter just below cases where data are additive.

All of the previously proposed two-dimensional periodic systems of diatomics [1,2] are special cases of the Kronecker-product architecture; it is possible to build a four-dimensional hyperspherical periodic system with toroidal cross-sections if one begins with a polar-coordinate element chart [22]. It is also possible to take a previously proposed chart for elements in a two-dimensional world [40] and to construct a periodic system for diatomic molecules in that world.

Various phenomena are predicted with the Kronecker-product periodic system, such as the additivity of some atomic/molecular properties. For instance, the additivity of covalent radii to form internuclear separations is incorporated by supposing that the data are positioned as exponents of some number, say the natural number e . The entries in the product system (internuclear separations) are then sums (of covalent radii) in the exponents. The same applies to NMR chemical shifts, to various cross-sections at high energy, and to the rate of change of ionization potential with respect to the extent of ionization (q), evaluated at $q = 0$, with the number of electrons fixed [Ref. 18, pp. 304-316 and 321-326; Ref. 41].

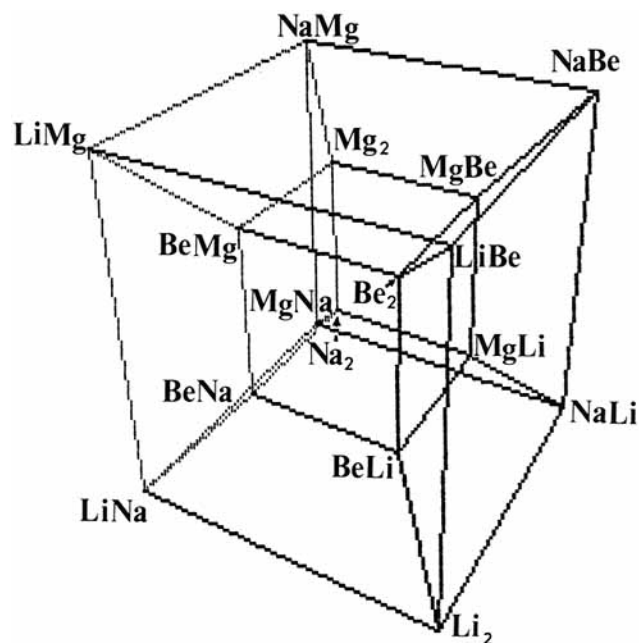

Fig. (7). The matrix shown in Fig. (6) is here represented as a tesseract. If a larger number of molecules are included in Fig. (6) and (7), some beautiful symmetries are seen in the placements of molecular symbols [16,18]. Used by permission from *Periodic Systems and their Relation to the Systematic Analysis of Molecular Data*, The Edivine Mellen Press, Lewiston, NY, Ref. [18].

For some time, our group had sought to find more appealing ways to present the 9-block system, beyond the efforts described in Section 5.6. This search eventually resulted in the computer plotting of isometric stick (or

“drop-down”) graphs for molecular structure data on all of the main-group areas for diatomic molecules, which in turn resulted in isometric shaded drawings of the surfaces for D_0° [2,12], r_e [2,12,42], ω_e [2,21] and IP . Stick graphs were also plotted for fixed-group molecules [ch. 6 of 18]. These graphs showed that the $(R_1 \cdot R_2)$ dependence established earlier (Section 5.4) is an excellent first approximation.

The advent of computer-aided literature searches was largely responsible for the realization that not only other Russian (Morozov, Syrkin), but also American [43], British [44], Chinese (Kong), and German [45] scientists had published periodic classifications of molecules. Most of these had proceeded in the same way as had our group in that “all” of the molecules with a fixed number of atoms, invariably starting with two, were included; we choose to call these “physical periodic systems.” The other systems [43,45] are classifications of specific kinds of molecules with various numbers of atoms, such as polycyclic aromatic hydrocarbons or fluorine functional groups; we choose to call these “chemical periodic systems” [1,2].

6. CONSTRUCTING OF THE KRONECKER-PRODUCT PERIODIC SYSTEM FOR LINEAR/BENT TRIATOMIC MOLECULES, BEGINNING 1984

6.1. Initial Expectations and Problems

It was expected that investigating periodicity among triatomic molecules would follow a sequence just like that for diatomic molecules, perhaps with initial obstacles such as notation in the databases — the naming of atoms in ABC molecules, and even in some AB_2 species, for instance — and the lack of consistent error evaluations. And it was confidently expected that if periodicity were demonstrated to exist, then the periodic system coordinates would be R_1 , C_1 , R_2 , C_2 , R_3 , and C_3 .

6.2. Periodicity on the Homonuclear Axis

A first hint of periodicity emerged, but not as expected by analogy to the diatomic history. The analogue of item 5.3e came first. Kong, in chapter 11 of [18], plotted data for several properties of triatomic molecules against a “molecular number” that is piecewise continuous with respect to $Z_1 + Z_2 + Z_3$. The properties are the average of the binding energies (AB with C) and (A with BC); the relative contraction of the internuclear separations; IP ; and the bond angle. Kong justified the curves on the basis of molecular orbital theory (maximum stability should occur for species with 12 electrons) and a rule that the abrupt occurrence of bent species should occur at 16 electrons.

Our group also graphed several properties on Kong’s “molecular number” axis, but with more resolution: the heat of atomization (ΔH_a) [46,47]; IP [46]; the internal entropy at 1000K [$S_{1000}^\circ(\text{internal})$] [46]; the total entropy ($S_{298.15}^\circ$); the partition function $Q(1000)$; and $\log_p K_{1000}$. One such plot is shown in Fig. (9). Of course there was general agreement with Kong, but we found that tagging the points for molecules with different central atoms resulted in discovering displacements of their peaks, as shown for ΔH_a in Fig. (10). This result, reminiscent of the shift described at the beginning of Section 5.2, was to prove very significant (Section 6.4).

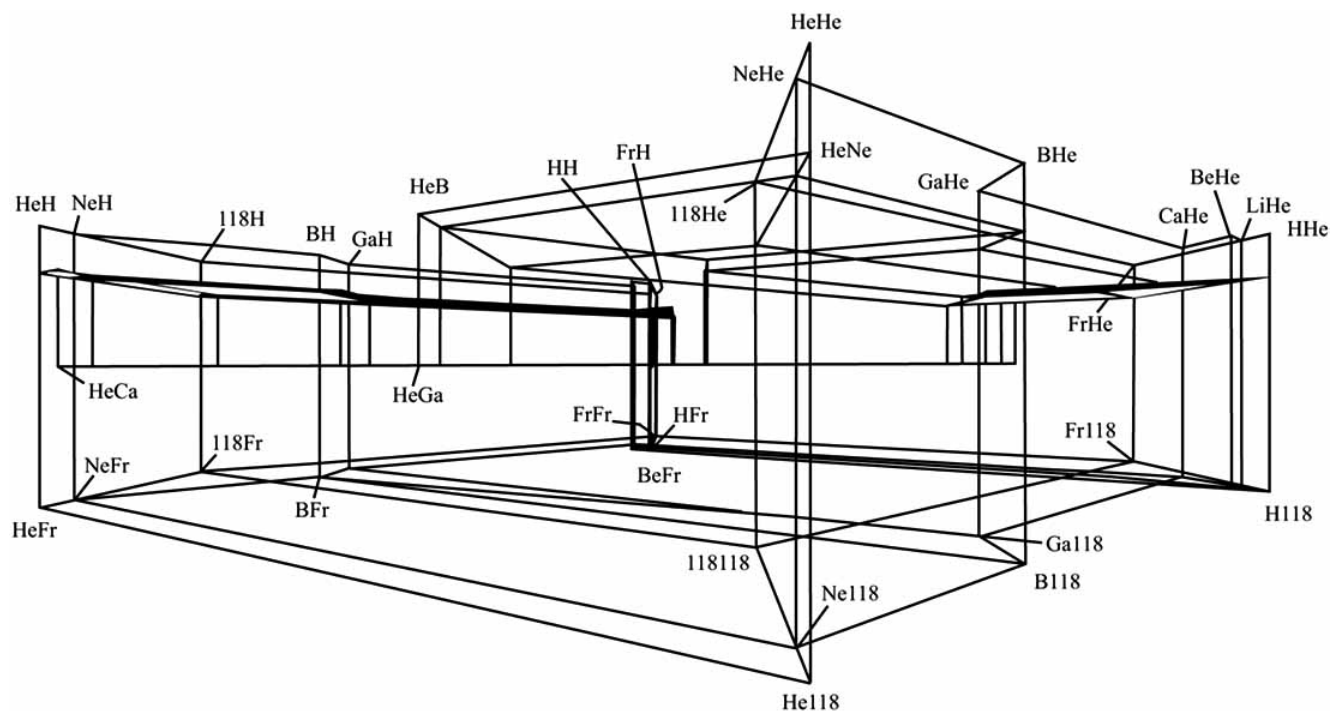

Fig. (8). Now imagine that all of the elements of the long-form chart are present (but not the lanthanoids and actinoids). The process described in Figs. (6) and (7) produces a much more complex four-dimensional architecture. This representation places molecules at vertices (not in compartments) connected by lines. If one looks carefully it is possible to see the long-form element chart, often skewed, in any one of several orientations. For example, begin with H118 (element 118 hydride) at the bottom right, move “back” and left to Fr118, proceed “frontward” and to the left to 118118, thence “downward” to He118, “backwards” to Ne118, advance “back” and to the right to B118 and Ga118, then along the transition-metal-118 molecules to Ca118 (not identified), “down” and to the right to Be118 (not identified), thereafter a step to the right to Li118 (not identified), and back to H118. Many other projections of this four-dimensional system, and the placements of homonuclear molecules in the structure can be found in chapter 10 of [18] or are available from the author. Used by permission from *Periodic Systems and their Relation to the Systematic Analysis of Molecular Data*, The Edivine Mellen Press, Lewiston, NY, Ref. [18].

6.3. Distributions of Data in Fixed-Period Volumes

Just as understanding the distribution of diatomic molecular data started on fixed-period squares and rectangles defined by molecules at the ends of *s*, *p*, *d*, and *f* series, so seeking to understand the distribution of triatomic data began by defining cubes and parallelepipeds bounded by the same magic numbers, Fig. (11). Just as the next step for diatomics was printing main-group molecular configurations and terms, or data, on 8 × 8 chessboards, so the next step (after item 5.3.e) for triatomics entailed plotting ΔH_a [47]; *IP*; $S^\circ_{298.15}$ [48]; $S^\circ(\text{internal})_{1000}$; Q(1000) and the bond angle in 8 × 8 × 8 cubes, as shown by one example in Fig. (12). There are not many data within any one of the cubes but there are enough to draw these conclusions, which largely follow the enumeration in Section 5.3:

- a. Walsh’s rule [49] is of course almost always obeyed by the bond angle. No other data have an isoelectronic tendency except possibly weakly for *IP*. (Isoelectronic molecules lie on planes, perpendicular to the homonuclear axis, or its analog in cases where the atoms come from different periods, described by $C_1 + C_2 + C_3 = \text{constant}$.) It is not obvious that the maximum ΔH_a occurs for 12 electrons — in fact, by far the most stable molecule (even as defined by the

partition function at 1kK) is CO₂, with 16 electrons and represented in the figure by +.

- i. There do, however, seem to be molecules with similar data (for all the properties except bond angle and *IP*) falling on the plane $C_1 + 2C_2 + C_3 = 18$; note the five hexagons from FBeF at the bottom right and going to BeOBe toward the top in a row in Fig. (12). As will be described in Section 6.4, this result was to prove very significant.
- ii. There were more points with $C_2 = 4$ (carbon, if $R_2 = 2$) than for other C_2 [46].
- b. Starting with the molecule in a given (R_1, R_2, R_3) and wishing to start with, for instance, the highest ΔH_a , one can draw a series of straight lines showing the path of least descent. The path is very erratic and even non-informative because so few data are available — percentage-wise, far fewer than for diatomic molecules.
- c. Identifying the covalently-bonded molecules with *s* and *p* atoms which “obey” the rule of 8 does not help to determine the distribution of stable molecules because there are only six of them for any choice of period numbers. For instance, if $R_1 = R_2 = R_3 = 2$, they

are OCO, FOF, NCF, ONF and the mirror images of the last two. Adding dative bonding results in including far more molecules — *s* and *p* octet molecules lie on planes described by $C_1 + C_2 + C_3 = 16, 18, \text{ and } 20$ [50] — in the portion of the cubes where most known molecular data lie. In any case, the method does not rank the species in order of stability.

- d. Repeated attempts to draw contours on the basis of alluring suggestions in the data (e.g., a spherical contour around CO_2) have been mildly encouraging [46].

The work is incomplete, yet there is confidence that the outer-product six-dimensional periodic system of triatomic molecules will ultimately be acceptably vindicated when graphical displays of up-coming experimental, theoretical, or forecasted data show periodicity among all the equivalent (R_1, R_2, R_3) cubes and parallelepipeds and when data predictions can be made in quantity. In the meantime, an interesting phenomenon emerged which poses a possible challenge for molecular quantum theory and which spawned what seemed for awhile to be a competitive periodic system. The phenomenon and the competitive system deserve the explanations that follow.

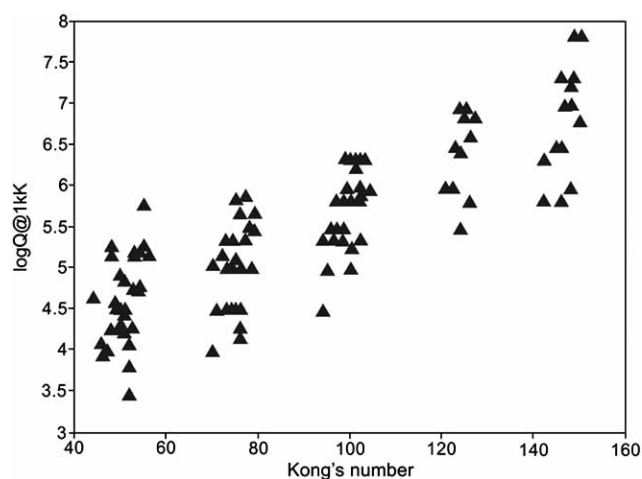

Fig. (9). The partition function at 1kK for diatomic molecules plotted on Kong's number, which is piecewise continuous with total electron population in such a way that the five cohorts (really canyons) correspond to $(R_1, R_2, R_3) = (2,2,2), (2,3,2), (3,2,3), (3,3,3), \text{ and } (3,4,3)$. Careful identification of each point to be sure that a molecule was of the form ABA and not AAB, made possible the determination — for a similar plot of $\Delta_a H$ at least — that the extrema of (probably) dicarbides and dinitrides, and (certainly) for dioxides and difluorides tend to be displaced one unit from each other in the positive direction.

6.4. The “Adjacent Diatomics-in-Molecules” Model

As hinted in Section 6.2, data points for molecules with central atoms F, O, maybe N, C, and possibly B are shifted one unit on the axis of Fig. (10). This shift suggests a new sort of isoelectronic series described by a constant value of $C_1 + 2C_2 + C_3 = (C_1 + C_2) + (C_2 + C_3)$. The series suggest a model of linear/bent triatomic molecules in which the atoms ABC are replaced by two diatomic molecules AB and BC. This model is somewhat akin to the “Diatomics in Molecules” (DIM) model except that there is no term for the (non-existent) bond AC. The model shows statistical significance

for various properties of isomers of four-atom molecules [47].

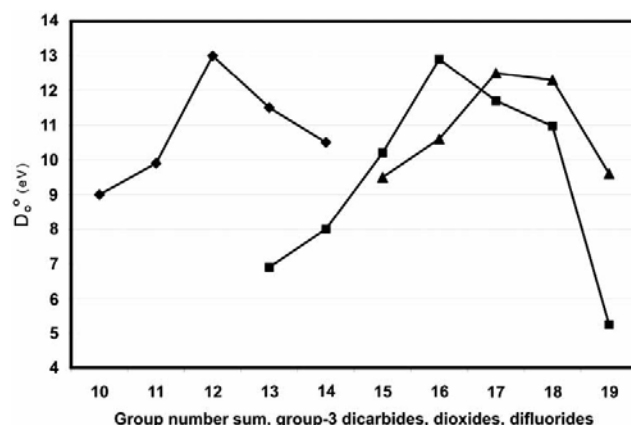

Fig. (10). Heat of atomization of (from left to right) of dicarbide, dioxide, and difluoride molecules with central atoms from period 3. These molecules are extracted from a swarm of data resembling one of the swarms in Fig. (9), but for $\Delta_a H$. The sum of the group numbers is based on the old (groups 1 to 7) notation for main-group species. The peaks here have displacements of two and one. Because of the uncertainty of from five to ten percent which is typical of $\Delta_a H$ data, many such graphs were prepared; they show that, on average, the peaks are displaced one unit as the central atom's group number increases by one.

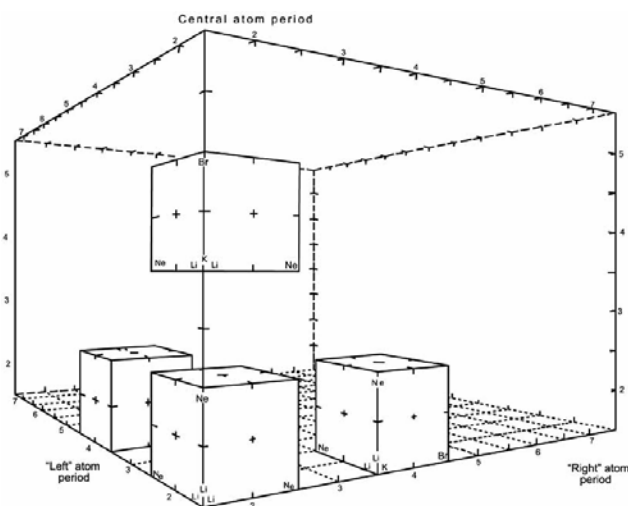

Fig. (11). The space of triatomic main-group molecules with outer atoms from periods 2 to 7 and with the central atoms from periods 2 to 5. Four $8 \times 8 \times 8$ cubes are shown, each containing 512 molecules. The two cubes with “right” and “left” atoms both from row 2 contain 288 non-redundant species. The two other cubes have no redundant molecules within them but are mirror images of each other. Used by permission from Elsevier Publishers, from [Ref. 12].

6.5. An Alternate Periodic System for Triatomic Molecules

Some of the many ways of looking at triatomic-species data suggested the construction of an alternate periodic system of triatomic molecules — using the group number of the central atom, C_2 ; the total number of atomic valence-shell

electrons, $n_e = C_1 + C_2 + C_3$; and some area-stacking function of R_1 , R_2 , and R_3 — that would be three-dimensional instead of six-dimensional. Neural-network predicted data (later, in Section 7.2) for ΔH_a and $S_{1000}^{\circ}(\text{internal})$ form very elegant surfaces on these axes, as Fig. (13) illustrates.

These areas can then be stacked according to a function of the period numbers. This function should include the period number of the third atom (R_3) but should also reduce to the function for diatomic molecules ($R_1 \cdot R_2$) if the third atom (C of ABC) is removed [46]. The plots on various functions of the three period numbers showed $f(R) = (R_1 \cdot R_2 + R_2 \cdot R_3)$ to be a good choice for the function.

This alternative periodic system was discarded because of the fact that more than one molecule can exist at a given address, especially for large values of $f(R)$, thus making it impossible to use the system for good predictions of unknown data at large values of $f(R)$.

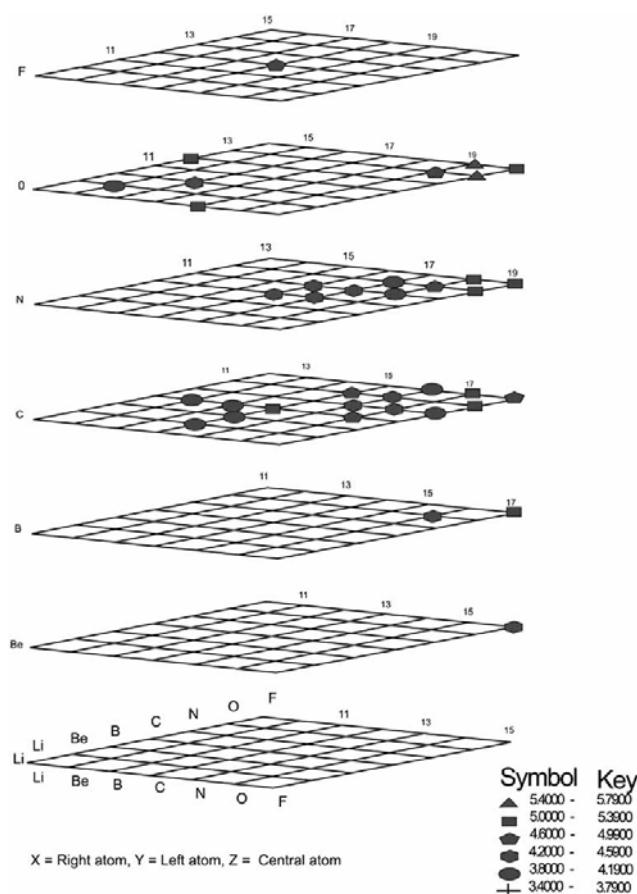

Fig. (12). A detailed view of the cube closest to the origin of the space in Fig. (11), with the log of the partition function at 1000K being plotted. The x , y , and z axes represent the “left-hand”, center, and “right-hand” atoms in the molecules. The small numbers on the right and top edges of each plane indicate the total number of atomic valence-shell electrons of molecules in isoelectronic series, which lie in planes in and out of the figure (orthogonal to the centerline which divides the plane into mirror images). Symbols coded at the lower right to represent the magnitudes of the data are placed at the locations pertaining to molecules.

7. FITTING AND PREDICTION FOR DIATOMIC AND TRIATOMIC MOLECULAR DATA

7.1. Least-Squares and Multiple-Regression Results

One-dimensional least-squares fitting and prediction of diatomic molecular data with respect to periods (Section 5.4) was done in a very preliminary way [11, 51]. Subsequently, triatomic molecules with s and p atoms were subjected to multiple-regression smoothing and forecasts, using powers of the three axes described in the previous section, just to see what general trends might emerge. The following properties were treated: ΔH_a ; IP ; $\log_p K_{1000}$; and $\log Q(1000)$ [48]. When the fitted data are compared with the tabulated data (when such exist) the agreements are surprisingly good for $f(R) < 19$, e.g., an average difference of 21 kJ mol⁻¹ for ΔH_a . The agreements are the result of the fact that by far most of the known data are in the domains $f(R) = (2 \cdot 2 + 2 \cdot 2) = 8$, $f(R) = (2 \cdot 3 + 3 \cdot 2) = (4 \cdot 2 + 2 \cdot 2) = 12$, and $f(R) = (3 \cdot 3 + 3 \cdot 3) = 18$.

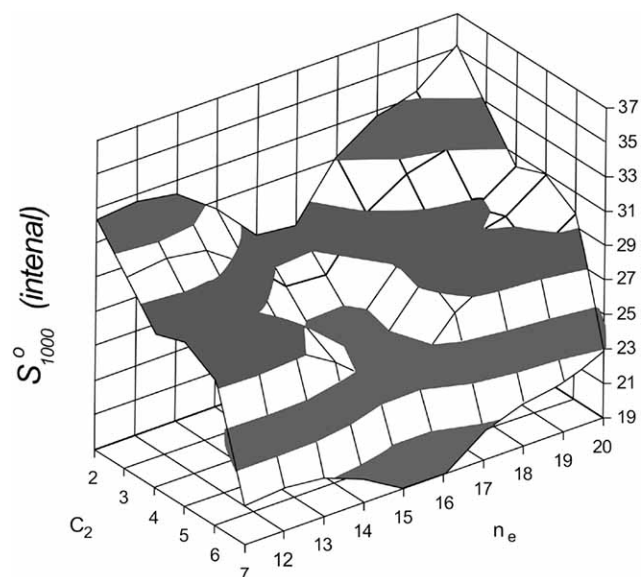

Fig. (13). The internal entropy at 1kK plotted on the sum of the two atoms’ valence electron count n_e and the group number of the central atom C_2 . All of the molecules correspond to $f(R) = (R_1 \cdot R_2 + R_2 \cdot R_3) = 8$. The high-stability valley at 15-16 is where molecules change from linear to bent, and the hanging valley at $C_2 = 4$ suggests again that among the molecules in the data set, those with carbon in the center are somewhat more stable or more often studied than their immediate neighbors. Plots with larger values of $f(R)$ are similar but less sharply defined.

7.2. Neural Network Results for Gas-Phase Diatomic and Triatomic Molecules

Our collaboration with W. B. Davis (Davis Research, Rio Linda, CA) began by fitting and forecasting of diatomic-molecular data for several of the properties mentioned above by using inputs R_1 , C_1 , R_2 , C_2 , and terms related to the electronegativities of the atoms. It was assumed that equal-period non-homonuclear molecules should be entered twice [for instance CO at $(C_1, C_2) = (4, 6)$ and OC at $(6, 4)$]. After many

trials in which the models treated the inputs unequally or even ignored some of them, the squares and cubes of the inputs were also inserted; this procedure resulted in improved agreement with tabulated data. Further improvement was achieved by inserting duplicate data at the low and high ends of the data domain (where the data are under-represented). Still further improvement was attained when the duplication of entries for molecules like CO and OC (the original assumption) was abandoned. 1,001 r_e data [52] and 1,920 ω_e data [53] not found in critical tables were predicted. Comparisons with some values gleaned from the literature showed that the predictions have sufficiently good accuracies to be adequate for preliminary studies of, say, stellar atmospheres.

Neural-network predictions for triatomic molecules, using the coordinates $R_1, C_1, R_2, C_2, R_3,$ and C_3 , where each molecule has its own unique location, have been partially successful for small $f(R)$.

8. EXPLORATIONS OF TRIATOMIC MOLECULES IN ANY PHASE

8.1. Introduction

Now we begin to consider molecules in all phases, concentrating on regularities in just main-group triatomic molecules (not including hydrogen or helium). Dr. Babaev, of Moscow State University, has contributed greatly to studies of molecular structure and periodicity. This Section is abstracted from a summary written by him some time ago [54]; it may be considered a continuation of Section 6.3. This entire section revolves around Fig. (14).

Qualitative stabilities or instabilities will be given for some series of molecules that are present in all or many of the cubical spaces of Fig. (11) — series of molecules which have the same location for all values of the three atomic period numbers (R_1, R_2, R_3). In time, it is hoped that quantitative measures will be sufficiently numerous to replace the qualitative measures.

8.2. Notation

Frequent reference to molecules by means of the group numbers of their atoms requires a shorter notation. Thus, 113 will mean exactly that $(C_1, C_2, C_3) = (113)$. If the atoms can be from *any* period of the element chart, then M, E, X, and Rg designate metals in groups 1 to 3 (from the domain 1 to 8), central-group atoms from groups 4 to 6, halides in group 7, and rare-gas atoms in group 8 respectively. Just which group each comes from is indicated by the corresponding Roman numeral; thus, M^{II} indicates a metal atom from group 2.

8.3. Metallic Bonding, $3 < n_e \leq 8$

The molecules discussed in this section lie in a diagonal band near the lower-left portion of Fig. (12). For the electron-deficient triatomic combinations with $n_e < 8$ there is no known driving force that might stabilize isolated molecules, *i.e.*, that might support the dominance of intramolecular bonds over intermolecular bonds. Although compounds with formulae AAA, AAB, or ABC are all known in the condensed phase, they are usually binary or ternary alloys with high electroconductivity. All outer electrons are delocalized — neither localized at separate atoms (as lone pairs) nor

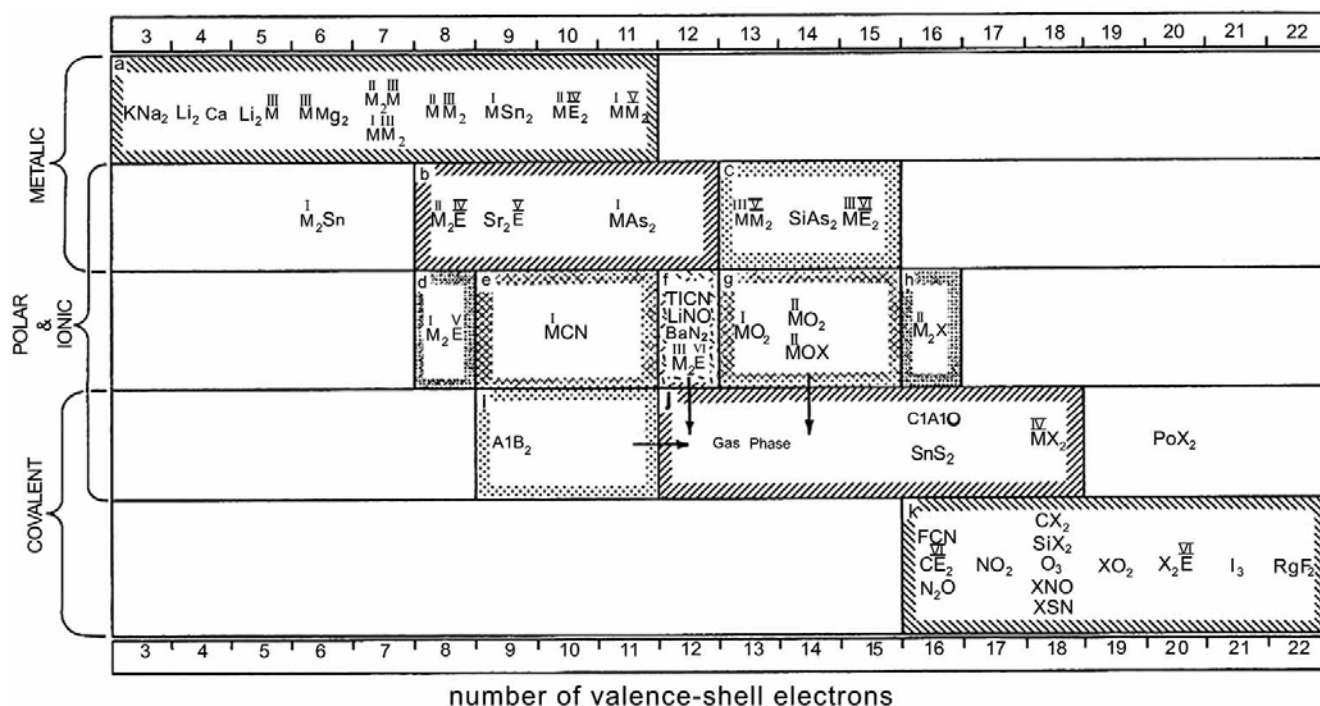

Fig. (14). Babaev's overview of triatomic molecules, showing representative species distributed according to their bondings and numbers of electrons. The individual species notations are explained in the text. The various hatched regions in the grey zone, $8 \leq n_e \leq 15$ particularly, are of secondary interest. They somewhat follow the text and in some cases indicate a phase change or a different data source.

between atomic pairs (as bonds). Hence, there is no justification for constructing Lewis diagrams.

Moreover, since atoms in these compounds form lattices, the main factor that defines the chemical constitution of the solids with $n_e < 8$ is the relative sizes of the corresponding atoms. Just this factor is important for species with atoms from column numbers 111 (archetype NaNaK), 113 (Li_2M), 222 (CaMgMg) and 114 (NaNaSn), 223 (BaBaTi), and 133 (RbGaGa).

There are exceptions connected with the appearance of a B atom, the most electro-negative atom in groups 1 to 3. In the case of BeBeB, there may be some sort of covalent bonding.

8.4. Ionic Bonding and Cases that Border Metallic Bonding, $8 \leq n_e \leq 15$

The molecules discussed in this section lie in a diagonal band starting where the previous cohort lay to a diagonal somewhat higher than the middle diagonal plane in Fig. (12). One general type of ionic compounds contains MEM or MXM and EME or XM₂. Stability is determined mainly by the difference between the free-atom valences of M and of E or X; thus, LiSLi is more stable than SrOSr and AISAl. The second general type contains MEE or MXX (written EEM or XXM if the electronegativity of E or X is less than that of M).

At $n_e = 8$ the first ionic series 116 ($\text{M}^{\text{II}}\text{E}^{\text{IV}}\text{M}^{\text{II}}$) appears. This is the first period-independent series to be encountered. The high chemical stability of these molecules obviously follows from the octet rule, as the E atom ends up with eight electrons. Two almost full isoelectronic series including 233 (CaAlAl) and 242 (CaSiCa) are also known as solids for $n_e = 8$. "Almost full" means that members of the series are known to be stable for many period combinations but not for all. These two series lie on the border between the metallic lattices and the structures with covalent or ionic bonds; their structures are determined by geometric factors. It would be quite interesting if any data on the structures of *isolated molecules* with atomic valences 233 or 224 would appear.

For $8 \leq n_e \leq 15$, the main factor of stability seems to be the ionic bonding between some cation M^{I} to M^{III} and some diatomic anion. The following compounds with more or less pronounced ionic character are listed here:

$n_e = 10$:	145 – Alkali cyanides like LiCN
	244 – Alkali-earth carbides like CaCC
$n_e = 12$:	156 – LiNO (its dimer, $\text{Li}_2\text{N}_2\text{O}_2$ is clearly not a triatomic)
	255 – BaNN
	345 – TiCN
$n_e = 13$:	166 – Alkali superoxides like KOO/g13
$n_e = 14$:	167 – Alkali superhalogenides like KOCl
	266 – Alkali-earth peroxides and disulfides like BaOO and CaSS

The second factor that determines stability in these compounds is the stability of the valence shell of the corresponding diatomic anion, *i.e.*, CN^- , CC^{2-} , OO^- , OO^{2-} , SS^{2-} , and

ClO^- ; the same may be true for NN^{2-} and NO^- . Similar considerations may apply to the bonding in the 244 species $\text{M}^{\text{I}}\text{SiSi}$ and $\text{M}^{\text{II}}\text{GeGe}$.

There are compounds appearing in $8 \leq n_e \leq 15$ that are not stable — they may undergo disintegration into "normal" chalcogenides and a metal — but still the ionic character of the intra-molecular bonds is evident. Examples are the species 363, such as GaOGa, and the alkaline-earth sub-oxides 262, like BaOBa.

It is difficult to make any general statements about the structures of other members in $8 \leq n_e \leq 15$. These compounds show no pronounced chemical "individuality", and the existence and stability of the solids seems to be mainly due to geometrical factors:

8.5. The Covalent, Borderline Ionic, and Van Der Waals Bonding, $16 \leq n_e \leq 22$

The molecules discussed in this section lie in the volume above and to the right of $n_e = 15$ in Fig. (12). A giant "island of stability" appears at $n_e = 16$.

556 – NNO

457 – XCN

466 – $\text{E}^{\text{IV}}\text{E}^{\text{VI}}\text{E}^{\text{VI}}$, ranging from OCO to PbSS but missing some members of the series

277 – $\text{XM}^{\text{II}}\text{X}$ (the full family from FBeF to IRaI)

$n_e = 16$ is the first possibility to achieve the octet rule for each atom in a triatomic molecule. Indeed, bonding in FCN and OCO corresponds to 4 localized bonds, *i.e.*, $\text{F}:\text{C}::\text{N}$ and $\text{O}::\text{C}::\text{O}$. The appearance of one more bond breaks down the octet rule, and hence the bonding in NNO (which also has 16 valence electrons) is *represented* analogously, like $\text{O}:\text{N}::\text{N}$ or $\text{O}::\text{N}::\text{N}$, rather than like $\text{O}::\text{N}::\text{N}$.

Triple-octet molecules are particularly interesting, and were studied algebraically as described in Sections 5.3 and 6.3. It was there pointed out that the algebraic method is limited in that it does not rank the "stable molecules" in order of stability, and indeed the many stable molecules are not triple octets.

Since multiple bonds are typical only for second-row (main-group) elements, it is not surprising that the molecules isovalent to second-row species do not in general have the same structures. Examples are FSiN, FCP, *etc.*, and SNN, OPN, ONP, *etc.* Moreover, some molecules like OSiO are not found in the gas phase and immediately polymerize to giant supermolecules in a condensed phase.

The cyan halides XCN (like many other polyatomics with a polar pi-bond) easily undergo trimerization into hexagonal triazines. The general stability of 16-electron shells also causes the stability of oxohalides of group 3, leading to stable solids like CIAIO and others known in the gas phase to be linear. More than that, many ions with less or more than 16 valence electrons tend to form this same shell structure and exist as stable, linear, 16-electron cations and anions. Two singly-ionized cations are ONO^+ and COF^+ ; some singly-ionized anions are BOO^- , NCO^- , CNO^- , NCS^- , NCSe^- , and NNN^- ; a doubly-ionized anion is NCN^{2-} (within cyanamide it occurs as CaC₂N₂); a triply-ionized anion is

NBN^{3-} ; and a four-times-ionized anion is CCC^{4-} (as it occurs in MgCCCMg).

Stable series of covalent molecules and corresponding compounds appear within $n_e > 16$, even granted that the new electrons are antibonding, even as far as $n_e = 22$, where FXeF and FKrF are found.

Most limitations on the stability of molecules with $n_e > 15$ are caused by the non-stability of multiple bonds for heavy main-group atoms. For instance, in $\text{E}^{\text{VI}}\text{E}^{\text{VI}}\text{E}^{\text{VI}}$, OSO , OSeO , and OTeO are stable whereas OOO , SSO , SSeO , STeO , SeSeO , SeTeO , and TeTeO are unstable. Analogously, in XE^{VI} , XNO is stable whereas XPO and XAsO , and XNS , XNSE , and XNTE , are not.

8.6. How are Sections 8 and 6.4 Related to the Kronecker-Product Periodic System?

The preceding section implies that each of the blocks in Fig. (11) has the same layers of isoelectronic molecules with various characteristics, modified in some cases [46] by the adjacent-DIM isoelectronic effect. At the same time, it has been shown here that there are complete series of stable molecules such as $\text{M}^{\text{II}}\text{E}^{\text{IV}}\text{M}^{\text{II}}$ and $\text{XM}^{\text{II}}\text{X}$; partially-complete series such as $\text{M}^{\text{IV}}\text{E}^{\text{V}}$; and stable series such as those whose archetypes are listed in Section 8.3, which lie at exactly the same address in all or many possible R_1 , R_2 , and R_3 cubes, which suggests the need for the six-dimensional Kronecker-product periodic system of triatomics. Of course, Fig. (11) is only one projection of this six-dimensional system. There is another projection in which a large space with coordinates C_1 , C_2 , and C_3 is filled with small cubes having axes R_1 , R_2 , and R_3 . In this projection, each of the series listed above would fill or partly fill just one cube.

9. PROBING THE MOLECULAR SPACE BEYOND THREE-ATOMIC MOLECULES

9.1. Background

Clearly, moving from molecules having two to those having three atoms presents increasing difficulty, due largely to the fact that the number of critically analyzed data becomes smaller compared to the number of molecules. Going to four atoms would be worse yet — the more so because of the proliferation of isomers — although some unpublished work by F.-A. Kong (Academia Sinica) is very promising. An algebraic prediction of closed-shell four-atom species [55] was successful but, as with similar predictions for triatomic molecules [50], it can not tell us which of these species is stable under normal conditions.

It was at this juncture that two previously peripheral streams of thought converged into a plan for exploring larger molecular spaces: first, the decades of work done by mathematical chemists in characterizing classes of molecules using graph-theoretical (topological) indices, and second, the insights gleaned from the visits to Russia (Sections 5.5 and 5.7).

A group of Russian chemists at LSU had long hoped to describe *all* molecules in such a way that the properties of one set of them, in a given phase, could be related to the properties and phase of some other set of molecules by

mathematical techniques [21]. They considered that the techniques were not yet available, and in order to prepare for the day when they were available, the chemists embarked on a massive experimental data-collection enterprise. In the process, they brought to light a large number of cases where there are almost linear relations between property data and the numbers of ligands or substituents in homologous molecules (series known as congeneric molecules), particularly for ΔH_a [56-58]. Fig. (15) shows a congeneric series.

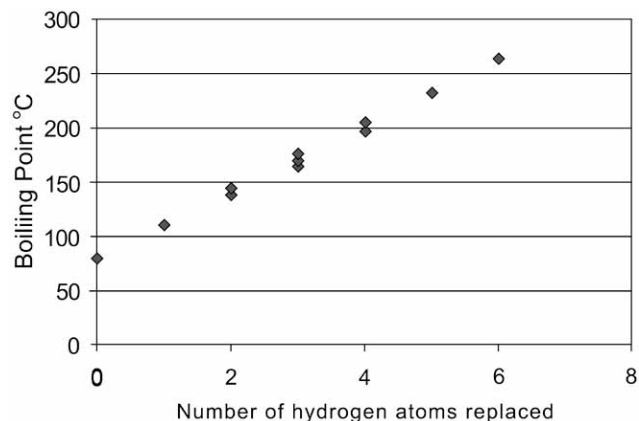

Fig. (15). Boiling points for benzene with from one to six hydrogen atoms replaced with a methyl group. The trend is quite linear. For two, three, and four substituents, there are three data; in two of these three, only two data were found.

9.2. Pursuit of the Dream, 2002 and Onwards

We begin by plotting ΔH_a of such a series on the x axis and the total number of atoms on the y axis, and finding the best-fit trend line passing through $(x,y) = (1,0)$. A rank-2 vector index is defined which has the value of ΔH_a for the central atom (zero by definition) as the upper component, and the reciprocal of the slope of the line divided by 10^3 by convention, as the lower component. The lower component (which represents the whole homologous or substitution set) is often periodic with respect to the central atom or the ligand atom, or with respect to the substituent atom. The work has been generalized to *other properties* and to *other phases*. The work can also be extended to have a *molecule* as the central object, and to have identical *molecular* ligands (or substituents) [59,60]. These generalizations alter the value of the upper vector component.

The procedure has been applied to $S_{298.15}^\circ$, boiling points, heats of formation, Kovats' retention index of various inorganic and organic sets, and to the dipole moments of the long carbon chains found in interstellar and circumstellar space. Going from the properties of one set in a given phase to the properties and phase of some other set is done trivially with dyadics (or diagonal matrices) [60], thus fulfilling the hopes of the Leningrad State University scientists. The current research plan of our group is to determine vector indices for additional series (*e.g.*, those in vertical columns of Hass's periodic system [45] of functional groups) and to ascertain the extent to which periodicity is manifested.

The vector indices and their transforming dyadics show definite traces of periodicity. In the process of the investigation, these traces have been shown to exist in molecules with

as many as 12 atoms, and possibly in molecules with 32 atoms [61].

9.3. Hyperperiodicity and a Possible Merging of Periodic Systems

Babaev has presented an ingenious proposal that organizes together the chart of the elements with present and future systems of diatomic and larger molecules [62]. His proposal includes “hyperperiodicity,” which classifies molecules according to their numbers of non-hydrogen atoms and their shapes (in which lone-pair electrons are included). He illustrates the proposal with various well-known molecular species. It is the case that to work out this proposal completely requires several other implicit dimensions [2]. Hyperperiodicity is another of the surprises encountered in this odyssey, preceded by the extent of molecular periodicity itself and then the adjacent-DIM effect.

10. NEIGHBORING (SIMILAR) MOLECULES

It is well to collect the scattered allusions to neighboring (or similar) molecules found in this review. For diatomic molecules, to first order, neighborliness is found in isoelectronic species like N_2 , CO, and BF (and ions like CN^- and CF^+) and in isovalent species like Li_2 , NaLi, and Na_2 (and ions like $LiBe^+$ and NaB^+ , which may or may not ever be seen under standard laboratory conditions). For triatomic and tetra-atomic molecules, the same first-order effects dominate. A second-order effect is embodied in the adjacent-DIM model. For linear homologous series, neighbors are of the form AB_n and AB_{n+1} ; for substituted series, neighbors are of the form $A_kB_lC_m\dots$ and $A_kB_lC_{m-n}D_n\dots$. (Also, molecular similarity is characterized by numerically-close topological indices or by small Euclidean distances on correlation plots.) And, of course, the thesis of this review is that even dissimilar species are part of an overarching periodicity.

11. OTHER ASPECTS OF MOLECULAR PERIODIC SYSTEMS

11.1. Partial Order and Periodic Systems of Molecules

While it may seem that the Kronecker-product periodic system paradigm and the in-principle organization of homologous and substituted series are complete, several interesting topics remain to be pursued. One of them is partial order. It is hoped that this essay will stimulate some ideas useful in the researches of specialists in partial order.

Reference has been made to how sparse the data are, the more so as the numbers of atoms in the molecules increase. It could be interesting to study the partial-order, or at least the related Hasse diagrams, of data [63] for some of the sets of molecules described. Since good data are continually being determined by computation or experiment, the study seems not to have much long-term use.

Partial order does find, however, application on a larger scale. Absolute symmetry among data for properties of atoms in the periods of the element chart is broken — the data differ. An appropriate Hasse diagram can be visualized if one imagines the periods of the element chart (a poset) to be slightly tilted in accordance with how data for a property varies from group to group in a period [64]. The same might be developed for molecules in their periodic systems (as multiposets) [65]. Closely related to partial order in periodic

systems is the chemotopological approach, combined with partially ordered sets, being pursued by G. Restrepo (University of Pamplona, Colombia) [66-68]. The averaging scheme based on the discrete vector-calculus Laplacian constructed from data, to be described in the next section, is related to interpolation in posets [69,70].

11.2. The Vector Calculus of the Periodic Systems

As stated in item 5.3.d we tried to use contours to characterize data on fixed-row planes of the periodic system of diatomic molecules. An alternative, visually effective, method is to create a discrete vector field [71]. The divergences of these vectors are also interesting in that they show periodicity and second periodicity. The curl of a lattice of data points is of course zero.

It is possible to average iteratively all of the data values inside a two-dimensional boundary if data are known at least on the boundary and if the expected maximum and minimum values are known. This process, which can be done in Excel[®] for instance, is theoretically equivalent to solving the numerical Laplace equation [Ref. 41, pp. 80, 83; Ref. 72]. A test of this theory was accomplished by showing that fixed-period, and fixed-group, D_o° and r_e data of diatomic molecules have opposite curvatures with respect to C_1 and C_2 and with respect to R_1 and R_2 . Predictions agreeing reasonably well with the known data (when available) can be made, using the numerical Laplace equation, for main-group molecules on the $(R_1, R_2) = (2, 2)$ area in a triangular region bounded by $(C_1 + C_2) = 10$ — the ridge containing OC, N_2 and CO — and by C_1 or C_2 equal to eight (18 in the IUPAC scheme), where rare-gas molecules having $D_o^\circ = 0$ lie. We have generalized the method to include all *four* axes; by using 126 tabulated data and neural-network predicted data, and were able to forecast the values of six molecules (three not in critical tables) with a simple standard deviation of 14% [12,73].

12. OTHER APPLICATIONS OF THE PERIODIC-SYSTEM PARADIGM

Just as two atoms can form a molecule, so two nuclei have also been observed to form a “nuclear molecule.” If sufficient numbers of these are detected and evaluated, a periodic system for them can be tested.

The nearly 2,000 known, and, in fact, all possible nuclides have already been arranged into periodic systems using the same approach as described in this paper [Ref. 18, pp. 561-565], and using information theory [74].

The three light quarks can be represented in a triangular diagram. The “Kronecker product” of this triangle, taken twice, produces a triangle with 27 baryons, the irreducible representations of which comprise the periodic system of many baryons. Addition of the charm quark generalizes the original system to be tetrahedral [$SU(4)$] and causes the Kronecker products to form a corresponding tetrahedron [75]. The same has been recently claimed for the bottom (or beauty) quark [76]. It can be anticipated that the same could in principle apply to the top (or truth) quark — granted that these heavy quarks do not behave in many ways as do the light quarks — and in each case there are options as to which three other quarks shall be included in the original tetrahedron.

13. DISCUSSION

This investigation has been largely curiosity-driven, however it can be hoped that the predictions for small-molecule gas-phase data might be of aid to spectroscopists, that the forecasts for other species might help in bench chemistry, and that the estimates for larger molecules (Section 9) might be of assistance for the toxicological or environmental sciences. The investigation has proven tremendously attractive to undergraduate students.

A prominent astrophysicist once described his role in a large collaboration as being in an orchestra. This paper shows how a much more modest orchestra of a dozen part-time senior investigators, plus their students, have started off with the one-part harmony of the chart of the elements and are now playing multi-part harmonies with molecules.

ACKNOWLEDGEMENTS

E.V. Babaev has our gratitude for all the information and insights provided in Section 8. D.J. Klein and another, anonymous, reviewer went so far beyond the usual standards for refereeing an article that the author must express his sincere thanks. To A.B. Berezin (Ioffe Technical Institute, retired) and N.P. Penkin (LSU, deceased) the author will be forever indebted for their facilitating their side of the Academy of Sciences exchange visits.

REFERENCES

- [1] Hefferlin, R.; Burdick, G. W. *Russ. J. Gen. Chem.*, **1994**, *64*, 1659.
- [2] Hefferlin, R. In *Philosophy of chemistry*; Baird, D.; Scerri, E.; McIntyre, L., Eds.; Springer: Dordrecht, **2006**; pp. 221-243. Fig. (7) of the chapter is in error and the correct figure will be sent upon request.
- [3] Hefferlin, R.; Rascon, L. *J. Opt. Soc. Am.*, **1967**, *57*, 964.
- [4] Hefferlin, R.; Mashburn, J.; Flechas, J.; Main, R.P. *J. Tenn. Acad. Sci.*, **1976**, *51*, 100.
- [5] Hefferlin, R. *J. Quant. Spectrosc. Radiat. Transfer*, **1976**, *16*, 1101.
- [6] Hefferlin, R. *J. Quant. Spectrosc. Radiat. Transfer*, **1978**, *19*, 335.
- [7] Syrkin, Y.K. In *100 let periodicheskovo zakona khimicheskix elementov. 1869-1969 (X yubileniyi Mendeleevskii s'ezd). Doklady na plenarnykh zasedaniyakh X yubileinovo Mendeleevskovo s'ezda*, Semenov, N.N., Ed.; Nauka: Moscow, **1969**.
- [8] <http://www.elch.chem.msu.ru/raden/index.htm>
- [9] Kuznetsova, L.A.; Pazyuk, E.A.; Stolyarov, A.V. *The Data Bank RADEN*; Proceedings Colloq. 146 Int Astronomical Union, May 19-24. Niels Bohr Institute and Nordita: Copenhagen, **1993**, pp. 231-237.
- [10] Hefferlin, R.; Kuznetsova, L.A. *J. Quant. Spectrosc. Radiat. Transfer*, **1999**, *62*, 765.
- [11] Hefferlin, R.; Campbell, R.; Gimbel, D.; Kuhlman, H.; Cayton, T. *J. Quant. Spectrosc. Radiat. Transfer*, **1979**, *21*, 315.
- [12] Hefferlin, R. *J. Mol. Struct.*, **2000**, *506*, 71.
- [13] James, B.; Caviness, K.; Geach, J.; Walters, C.; Hefferlin, R. *J. Chem. Inf. Comp. Sci.*, **2002**, *42*, 1.
- [14] Hefferlin, R.; Luk, K. *Croat. Chem. Acta*, **2007**, *80*, 227.
- [15] Kong, F. *J. Mol. Struct.*, **1982**, *90*, 17.
- [16] Hefferlin, R.; Kuhlman, H. *J. Quant. Spectrosc. Radiat. Transfer*, **1980**, *24*, 379.
- [17] Hefferlin, R.; Zhuvikin, G.; Caviness, K.; Duerksen, P.J. *J. Quant. Spectrosc. Radiat. Transfer*, **1984**, *32*, 257.
- [18] Hefferlin, R. *Periodic systems of molecules and their relation to the systematic analysis of molecular data*, Edwin Mellen Press: Lewiston, **1989**.
- [19] Nalawajski, R.F.; Thakkar, A. J. *J. Phys. Chem.*, **1983**, *87*, 5361.
- [20] Gorshchov, V.N. *Opt. i Spekr. (Russian)*, **1980**, *48*, 657.
- [21] Latysheva, V.A.; Hefferlin, R. *J. Chem. Inf. Comput. Sci.*, **2004**, *44*, 1202.
- [22] Hefferlin, R. *J. Chem. Inf. Comp. Sci.*, **1994**, *34*, 314.
- [23] Huber, K.P.; Herzberg, G. *Constants of diatomic molecules*, Van Nostrand Reinhold Company: New York, **1979**.
- [24] Cornell, E. C.; Hefferlin, R.A. *Graphic portrayal of periodicity of properties of diatomic molecules*, First Annual National Conference on Undergraduate Research, Asheville, North Carolina, April 24, **1987**.
- [25] Hefferlin, R. *Croat. Chem. Acta*, **2008**, submitted.
- [26] Rumer, Y.B.; Fet, A.I. *Teor. Mat. Fiz. (Russ.)*, **1971**, *9*, 203.
- [27] Fet, A.I. *The system of elements from the group-theoretic viewpoint*, Institute of Inorganic Chemistry, Siberian Branch, Academy of Sciences of the U.S.S.R., Preprint No. 1: Novosibirsk, **1979**.
- [28] Fet, A. I. *Theor. Math. Phys.*, **1975**, *22*, 227.
- [29] Ostrovsky, V.N. *J. Phys. B.*, **1981**, *14*, 4425.
- [30] Barut, A. O., In *Structure of matter (Proceedings of the Rutherford Centenary Symposium, 1971)*; Wybourne, B., Ed.; University of Canterbury Press: Canterbury, **1972**; pp. 126-136.
- [31] Kitagawara, Y.; Barut, A.O. *J. Phys. B.*, **1983**, *16*, 3305.
- [32] Berrondo, M.; Novaro, O. *J. Phys. B.*, **1973**, *6*, 761.
- [33] Zhuvikin, G.V.; Hefferlin, R. *The periodic system of diatomic molecules: group-theoretical approach*, Vestnik Leningradskovo Universiteta, No. 16, **1983**, pp. 10-16.
- [34] Zhuvikin, G.V.; Hefferlin, R. *Anales de fisica, Monographias 1, Real Sociedad Española de Fisica*, Proceedings of the XIX International Colloquium: Salamanca, **1992**, Vol. 2, pp. 358-361.
- [35] Zhuvikin, G.V.; Hefferlin, R. *Joint report #1 of the physics departments of Southern College [SAU], Collegedale, TN, USA and St. Petersburg University, St. Petersburg, Russia*, Southern Adventist University: Collegedale, Tennessee, **1994**.
- [36] Carlson, C.M.; Hefferlin, R.; Zhuvikin, G.V. *Joint report #2 of the physics departments of Southern College [SAU], Collegedale, TN, USA and St. Petersburg University, St. Petersburg, Russia*, Southern Adventist University: Collegedale, Tennessee, **1995**.
- [37] Griffiths, D.J. *Introduction to quantum mechanics*, Prentice Hall: Upper Saddle River, **2005**.
- [38] Carlson, C.M.; Cavanaugh, R.J.; Hefferlin, R.; Zhuvikin, G.V. *J. Chem. Inf. Comp. Sci.*, **1996**, *36*, 396.
- [39] Zhuvikin, G.V.; Carlson, C.M.; Cavanaugh, R.J.; Hefferlin, R.A. *Periodic system of diatomic molecules in SO(3) ⊗ SU(2)s bosonic symmetry: singlets and triplets*: Physics Department, Southern Adventist University, Collegedale, Tennessee, **1994** (available from the author).
- [40] Asturias, F.J.; Aragon, S.R. *Am. J. Phys.*, **1985**, *53*, 893.
- [41] Hefferlin, R.; Innis, W. *J. Quant. Spectrosc. Radiat. Transfer*, **1983**, *24*, 97.
- [42] Hefferlin, R.; Kutzner, M. *J. Chem. Phys.*, **1981**, *75*, 1035.
- [43] Dias, J.R. *J. Chem. Inf. Comput. Sci.*, **1996**, *36*, 361.
- [44] Clark, C.H.D. *Trans. Faraday Soc.*, **1935**, *31*, 1017.
- [45] Haas, A. *Adv. Inorg. Chem. Radiochem.*, **1984**, *28*, 167.
- [46] Carlson, C.; Gilkeson, J.; Linderman, K.; LeBlanc, S.; Hefferlin, R. *Croat. Chem. Acta*, **1997**, *70*, 479.
- [47] Hefferlin, R.; Matus, M.T. *J. Chem. Inf. Comp. Sci.*, **2001**, *41*, 484.
- [48] Cavanaugh, R.; Marsa, R.; Robertson, R.; Hefferlin, R. *J. Mol. Struct.*, **1996**, *382*, 137.
- [49] Takahata, Y.; Schuelle, G.W.; Parr, R.G. *J. Am. Chem. Soc.*, **1971**, *93*, 784.
- [50] Geach, J.; Walters, C.; James, B.; Caviness, K.E.; Hefferlin, R.A. *Croat. Chem. Acta*, **2002**, *75*, 383.
- [51] Hefferlin, R.; Kuhlman, H.; Campbell, R.; Gimbel, D. *J. Quant. Spectrosc. Radiat. Transfer*, **1979**, *21*, 337.
- [52] Hefferlin, R.; Davis, W.B.; Iletto, J. *J. Chem. Inf. Comp. Sci.*, **2003**, *43*, 622.
- [53] Davis, W.B.; Hefferlin, R. *J. Chem. Inf. Mol. Model.*, **2006**, *46*, 820.
- [54] Babaev, E.V. *Private Communication*, **1991**.
- [55] Walters, C.J.; Caviness, K.E.; Hefferlin, R. *Croat. Chem. Acta*, **2004**, *77*, 65.
- [56] Shchukarev, S.A. *Neorganicheskaya khimiya, Vol. 1: Vysshaya shkola*, Moscow, **1970**.
- [57] Shchukarev, S.A. *Neorganicheskaya khimiya, Vol. 2: Vysshaya shkola*, Moscow, **1974**.
- [58] Karapet'yantz, M. Kh. *Khimicheskoe srodstvo: Znanie*, Moscow, **1972**.
- [59] Hefferlin, R.; Luk, K. *Croat. Chem. Acta*, **2006**, *79*, 559.
- [60] Hefferlin, R. *Croat. Chem. Acta*, **2008**, submitted.
- [61] Luk, K.; Hefferlin, R.; Johnson, G. *How Deep in Molecular Space can Periodicity be Found?*, Proceedings of the 9th WSEAS International CSCC Multiconference: Web and CD edition, **2005**.

- [62] Babaev, E.V.; Hefferlin, R. In *Concepts in chemistry, a contemporary challenge*, Rouvray, D.H., Ed.; John Wiley: New York, **1997**; pp. 41-100.
- [63] Hefferlin, R. In *Partial order in environmental sciences and chemistry*; Brüggemann, R.; Carlsen, L., Eds.; Springer: Berlin, **2006**; pp. 27-33.
- [64] Klein, D.J. *J. Math. Chem.*, **1995**, *18*, 321.
- [65] Klein, D.J.; Babić, D. *J. Chem. Inf. Comput. Sci.*, **1997**, *37*, 656.
- [66] Restrepo, G.; Mesa, H.; Llanos, E.J. *J. Chem. Inf. Model.*, **2007**, *47*, 761.
- [67] Daza, M.C.; Restrepo, G.; Uribe, E.A.; Villaveces, J.L. *Chem. Phys. Lett.*, **2006**, *428*, 55.
- [68] Restrepo, G.; Weckert, M.; Brüggemann, R.; Gerstmann, S.; Frank, H. Refrigerants ranked by partial order theory, in Hryniewicz, O.; Studzinski, J.; Szediw, A., Eds., *EnviroInfo 2007, 21st International conference on informatics for environmental protection*: Shaker: Aachen, Germany, **2007**; pp. 209-217.
- [69] Ivanciuc, T.; Klein, D.J. *J. Chem. Inf. Comput. Sci.*, **2004**, *44*, 610.
- [70] Doslić, T.; Klein, D.J. *J. Comp. Appl. Math.*, **2005**, *177*, 175.
- [71] Hefferlin, R. *J. Math. Chem.*, **2008**, *43*, 386-394.
- [72] Sears, F.W.; Zermansky, M.W.; Young, H.D. *University physics*, Addison-Wesley: Reading, **1986**.
- [73] Hefferlin, R.; Knoll, J., *J. Math. Chem.*, **2000**, *28*, 169.
- [74] Bonchev, D. In *The mathematics of the periodic table*; Rouvray, D.H.; King, R.B., Eds.; Nova Science Publishers: New York, **2006**; pp. 205-225.
- [75] Halzen, F.; Martin, A.D. *Quarks & leptons: an introductory course in modern particle physics*, John Wiley: New York, **1984**, chapter 2.
- [76] <http://www.aip.org/png/2006/270.htm>

Received: October 10, 2007

Revised: January 30, 2008

Accepted: March 14, 2008