

1956

# Acute hypertension in the pulmonary vascular bed of the dog: a physiological study

Shirley Evans Downing  
*Yale University*

Follow this and additional works at: <http://elischolar.library.yale.edu/ymtdl>

---

## Recommended Citation

Downing, Shirley Evans, "Acute hypertension in the pulmonary vascular bed of the dog: a physiological study" (1956). *Yale Medicine Thesis Digital Library*. 2534.  
<http://elischolar.library.yale.edu/ymtdl/2534>

This Open Access Thesis is brought to you for free and open access by the School of Medicine at EliScholar – A Digital Platform for Scholarly Publishing at Yale. It has been accepted for inclusion in Yale Medicine Thesis Digital Library by an authorized administrator of EliScholar – A Digital Platform for Scholarly Publishing at Yale. For more information, please contact [elischolar@yale.edu](mailto:elischolar@yale.edu).

T113  
+Y12  
1986

YALE UNIVERSITY LIBRARY



3 9002 06670 9453

ACUTE HYPERTENSION IN THE PULMONARY  
VASCULAR BED OF THE DOG:  
A PHYSIOLOGICAL STUDY

~~~~~  
S. E. Downing

1956

MUDD  
LIBRARY  
Medical

YALE



MEDICAL LIBRARY

YALE MEDICAL LIBRARY

Manuscript Theses

Unpublished theses submitted for the Master's and Doctor's degrees and deposited in the Yale Medical Library are to be used only with due regard to the rights of the authors. Bibliographical references may be noted, but passages must not be copied without permission of the authors, and without proper credit being given in subsequent written or published work.

This thesis by . . . . . has been used by the following persons, whose signatures attest their acceptance of the above restrictions.

---

---

NAME AND ADDRESS

DATE



ACUTE HYPERTENSION IN THE PULMONARY VASCULAR  
BED OF THE DOG: A PHYSIOLOGICAL STUDY

S. E. Downing, B. S.

University of New Hampshire, 1952

A Thesis Presented to the Faculty of the  
Yale University School of Medicine  
in Candidacy for the Degree  
of Doctor of Medicine

Department of Pathology  
Yale University School of Medicine  
1956

THE UNIVERSITY OF CHICAGO  
MEDICAL CENTER

1956



THE UNIVERSITY OF CHICAGO  
MEDICAL CENTER

T113  
Y12  
1986

THE UNIVERSITY OF CHICAGO  
MEDICAL CENTER

#### ACKNOWLEDGMENTS

I am deeply grateful to Dr. Averill A. Liebow, for his interest and wisdom in guiding me in this work and for his complete cooperation in making the facilities of his laboratory available to me.

To Mr. Frank Cappiello and Mr. Zacharias Abbey, I wish to express my thanks for their competent technical assistance.

To my wife, Helen, I am indebted for her capable technical assistance in developing the definitive surgical procedure used in preparing the animals.

The work was supported in part by a James Hudson Brown Memorial Fellowship.

S. E. D.





ACUTE HYPERTENSION IN THE PULMONARY VASCULAR BED  
OF THE DOG: A PHYSIOLOGICAL STUDY

S. E. Downing

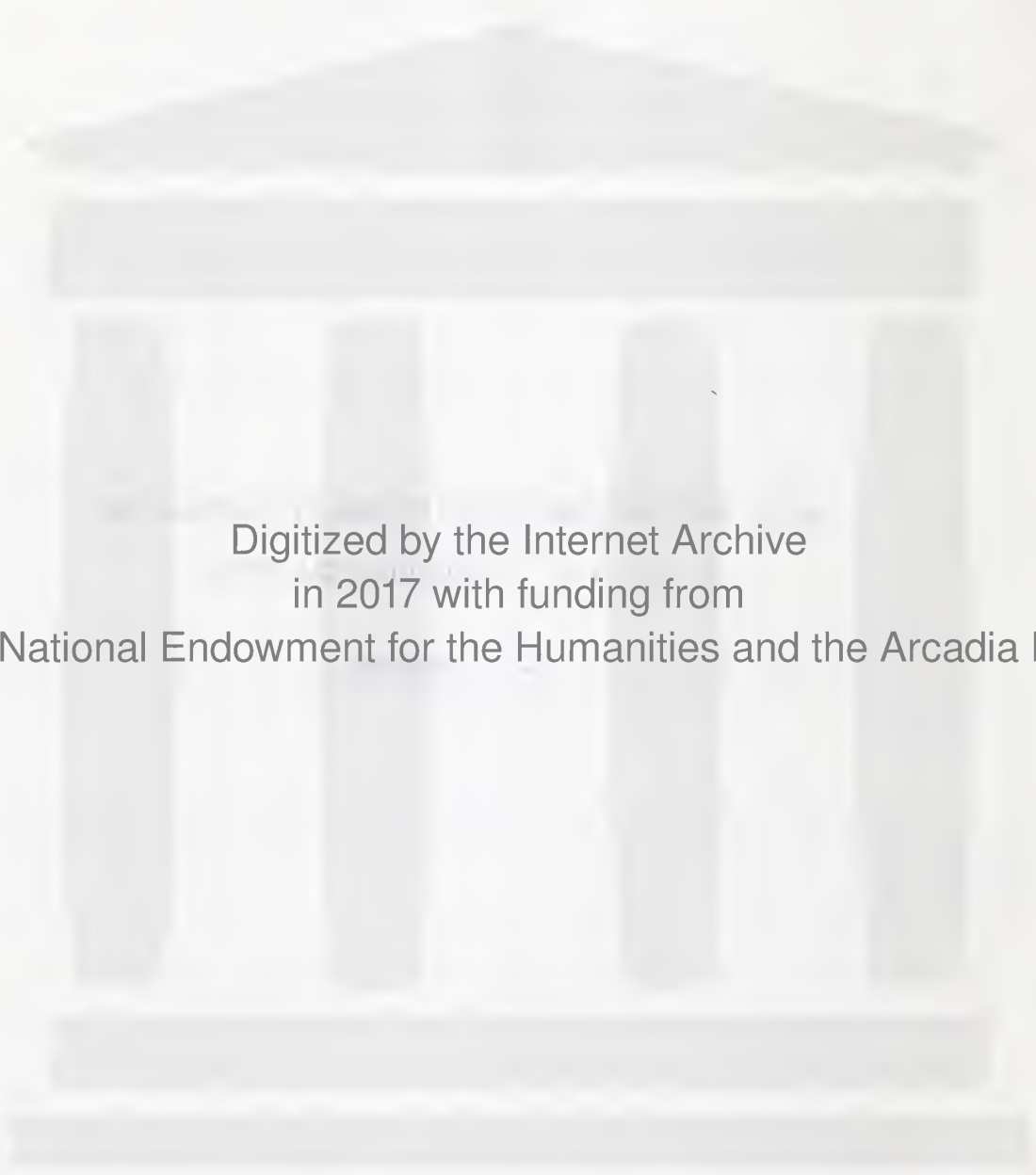

Digitized by the Internet Archive  
in 2017 with funding from  
The National Endowment for the Humanities and the Arcadia Fund

<https://archive.org/details/acutehypertensio00down>

## TABLE OF CONTENTS

|                                                                                |    |
|--------------------------------------------------------------------------------|----|
| INTRODUCTION.....                                                              | 1  |
| THE NERVE SUPPLY OF THE PULMONARY VASCULAR BED.....                            | 2  |
| PHYSIOLOGICAL STUDIES ON PRESSORECEPTORS IN THE PULMONARY<br>VASCULAR BED..... | 3  |
| PLAN.....                                                                      | 9  |
| MATERIALS AND METHODS.....                                                     | 11 |
| Cannulae and Snares.....                                                       | 11 |
| Veratridine.....                                                               | 12 |
| Saline Perfusant.....                                                          | 13 |
| Animals.....                                                                   | 13 |
| Infusion Apparatus.....                                                        | 16 |
| Calculation of Perfusion Pressure.....                                         | 19 |
| Surgical Preparation.....                                                      | 20 |
| Experimental Procedure.....                                                    | 22 |
| RESULTS.....                                                                   | 25 |
| Effects on Systemic Blood Pressure.....                                        | 26 |
| Effects on Heart Rate.....                                                     | 27 |
| Effects on Respiration.....                                                    | 28 |
| Main Pulmonary Artery Pressure.....                                            | 29 |
| Post-mortem Examination.....                                                   | 29 |
| Tabulation of Data.....                                                        | 37 |
| DISCUSSION.....                                                                | 39 |
| Significance of the Reflex.....                                                | 41 |
| SUMMARY AND CONCLUSIONS.....                                                   | 44 |
| BIBLIOGRAPHY.....                                                              | 46 |



## INTRODUCTION

Since Ibn-Nafis in Arabia,<sup>1,2</sup> and much later Servetus<sup>3</sup> and Colombo<sup>4</sup> in Europe established the presence of a communication between the right and left sides of the heart by way of the lungs through which nearly all of the blood of the body must pass in its circuit, investigators began to search for factors which might influence or control the flow of blood through these vessels; control exerted, if not by active change in the vessels themselves, then secondary to changes in the heart action and the peripheral systemic circulation.

The early investigators of this problem working in the latter part of the 19th century found that, in lower animals, the stimulation of the nerve supply of the respiratory organ would elicit certain definite changes in the systemic circulation and heart rate. MacWilliam (1885)<sup>5</sup> demonstrated that slight stimulation by several methods of either gill of the eel produced a sudden and powerful inhibition of the heart. Prior to this time Einbrodt (1860),<sup>6</sup> Hering (1871),<sup>7</sup> and Sommerbrodt (1881)<sup>8</sup> had shown that appropriate stimulation of the efferent nerve supply of the lung by forced respiration with air under increased pressure produced changes in heart action and systemic circulation. Brodie and Russell (1900)<sup>9</sup> showed that faradic stimulation of the central end of pulmonary branches of the vagus resulted in an immediate and pronounced drop in the systemic blood pressure and bradycardia. He also found that this reflex was accompanied by apnea. In another paper in the same year, Brody<sup>10</sup> also reported the effects of injecting blood serum into the jugular vein of the cat. He found that injection of this material from any source, including autologous serum, produced an immediate and marked





inhibition of the heart and drop of the systemic blood pressure in the cat, but not in the dog or rabbit which were also tested. The pulmonary branches of the vagus were found to be essential for this reaction, their removal preventing the response from occurring or stopping it if they were severed during a response.

Hence, evidence accumulated which indicated that the lungs and pulmonary vascular bed are not entirely passive entities but, indeed, have a very definite functional relationship to the respiratory and cardio-vascular systems by way of neural reflexes. However, the nature of this relationship remained to be more thoroughly investigated.

#### The Nerve Supply of the Pulmonary Vascular Bed

Anatomical evidence for the presence of a rich nerve plexus innervating the pulmonary vascular bed has been available for many years. Takino,<sup>11</sup> reporting his observations in 1933, found that, in the dog, the pulmonary vascular nerve supply extends over the whole of the pulmonary arterial tree as far as and including the arterioles, but it is limited to the extra-pulmonary and larger intra-pulmonary veins. He found the sensory endings of these nerve fibers in the media or adventitia of the vessels. It was his interpretation from histological evidence that the arteries are principally supplied with sensory and the veins principally with motor endings.

However, Elftman (1943)<sup>12</sup> found in the dog sensory endings in the pulmonary veins of the hilar region only, which were thought to be presoreceptors. She concluded from evidence derived by differential staining techniques that the pulmonary perivascular nerve plexus as described by Takino is probably primarily sympathetic in nature.





Nonidez (1941)<sup>13</sup> described in detail subendothelial endings and perimuscular arborizations in the proximal portions of the pulmonary veins in the cat and dog. He felt the possibility existed that these might be sympathetic afferent endings rather than vagal afferents as was concluded by others. He found, also, typical pressoreceptors in the region of the bifurcation of the main pulmonary artery, but none distal to this point on the arterial side.

A careful anatomical study of the innervation of the human lung was done by Larsell and Dow<sup>14</sup> in 1933. They showed that the pulmonary hilar plexus of nerves divided into a peribronchial and periarterial group. The latter was found to consist only of unmyelinated fibers--probably postganglionic sympathetic. However, they were able to demonstrate intercommunications between the periarterial and the peribronchial groups, the latter having been derived in a large measure from the vagus nerve.

Hence, there is some disagreement among the anatomists regarding the nature and distribution of the nerve supply of the pulmonary vascular bed; and few conclusions can be drawn regarding the function of these nerves from histological studies.

#### Physiological Studies on Pressoreceptors on the Pulmonary Vascular Bed

Probably the first evidence to suggest that pressoreceptors did in fact exist in the pulmonary vascular bed of mammals which had functional importance was the work of Churchill and Cope<sup>15</sup> in 1929. They approached the problem by ligating the pulmonary veins of the right lung of cats and infusing heparinized blood into the right pulmonary artery by cannula under controlled pressures. They found that, by raising the



pressure in this isolated intact lung from 0 to 42 mm Hg that a drop of systemic blood pressure of 18 mm Hg, bradycardia and apnea for 8 seconds followed by rapid, shallow breathing resulted. This effect failed to occur after the ipsilateral vagus had been severed.

Harrison, et al,<sup>16</sup> while studying the effects of congestion of the pulmonary vascular bed on respiration showed that the rapid infusion of 100 cc of blood into the left pulmonary artery of the dog produced tachypnea. No attempt was made, however, to determine the effect on systemic blood pressure or heart rate.

In 1935 Schwiegk<sup>17</sup> in Germany approached the problem by tying off all the blood vessels of the left lung of the dog and inserting a cannula into the peripheral end of the pulmonary artery. He found that, by raising the static pressure in the vascular bed of the lung, that a reflex bradycardia and a decrease in systemic blood pressure resulted. Both of these effects required the integrity of the vagi. He found that the reduction of systemic pressure was due to peripheral vasodilation and an increase of splenic volume.

However, Schweitzer (1936),<sup>18</sup> working with cats, found that raising the pressure in the left pulmonary artery from 0 to 60 mm Hg gave a significant response in only two out of 12 animals. He concluded that the reflex described by Schwiegk was an inconstant finding.

Daly, et al (1937),<sup>19</sup> using techniques by which they independently perfused the lesser and greater circulations of dogs, found that an increase in pulmonary blood flow produced a reduction of systemic blood pressure and an increase or decrease in heart rate and occasionally an increase in the respiratory rate. All of these effects were





abolished by bilateral section of the cervical vagosympathetic. They concluded that the activity of pressoreceptors in the pulmonary vascular bed is small but definite and that the activity of the venous pressoreceptors is much more readily elicited. They later stated, however, that their method inevitably led to distension of the left auricle and, therefore, are not entirely certain whether the reflex was from the left auricle, the pulmonary veins, or both.

It should be mentioned that any hemodynamic alterations which might be produced during such a perfusion experiment by way of the bronchial collateral circulation was shown by Berry, Brailsford and Daly<sup>20</sup> in 1931 to be very small. Perfusion of the lungs of dogs at very high pressures in the absence of their nerve supply produced only a very slight (2 to 3 mm Hg) rise in the systemic blood pressure.

Megibow, Katz and Steinitz<sup>21</sup> in 1942 reported further evidence that raising the pulmonary arterial pressure to abnormally high levels produced an increase in the respiratory rate as described previously in a small percentage of the cases by Daly, et al. Also, the observation by Yeomans, Porter and Swank (1943)<sup>22</sup> may be mentioned. They found while studying the effects of venous congestion by rapid saline infusion into a peripheral vein that a marked increase in pulmonary venous pressure which resulted produced shallow respirations.

Heyer, Holman and Shires<sup>23</sup> in 1948 attempted to elucidate the mechanism of this respiratory response of pulmonary congestion by the infusion of saline into the left pulmonary artery of dogs whose ipsilateral pulmonary veins had been tied. They felt that the response was due to the increased sensitization of the Hering-Breuer reflex, and that it was unrelated to the hydrogen ion or carbon dioxide concentration.



However, Bulbring and Witteridge (1943)<sup>24</sup> had failed to show a change in recorded action potential activity initiated by the "inflation stretch receptors" of the Hering-Breuer reflex when an increase in the blood volume of the lungs was induced.

Parin (1943)<sup>25</sup> in Moscow essentially repeated the work of Churchill and Cope and Schwiegk by infusing Bayliss' 8 per cent gum acacia Ringer's solution into the cannulated left pulmonary artery of cats after ligating the pulmonary veins on the same side. He found that a perfusion pressure of 45 mm Hg or more was sufficient to produce a drop in carotid artery pressure and a bradycardia. He observed this effect following a latency of 2 to 3 seconds after the perfusion pressure had been elevated to the appropriate level. The maximum drop was found to occur at 25 to 40 seconds after starting the infusion. He made no attempt, however, to measure the respiratory response. It is interesting that Parin was apparently not aware of the work of Churchill and Cope done in 1929 and gave Schwiegk the credit for making the original observations of this phenomenon, the latter work having been done in 1935, in Germany. This oversight may have been due to the somewhat obscure title selected by Churchill and Cope for their paper ("The Rapid Shallow Breathing Resulting from Pulmonary Congestion and Edema").

Aviado, et al (1951),<sup>26</sup> reported a study of the effects of raising the pressure in the pulmonary vascular bed on the respiratory and cardiovascular systems of dogs. They used perfusion techniques in which blood was pumped from the right auricle through the left pulmonary artery of the dog at controlled pressures. Their results showed that raising the perfusion pressure in the left pulmonary artery alone produced no effect on heart rate, blood pressure or respiration. But





that raising the perfusion pressure after first clamping the left pulmonary veins produced a fall in systemic blood pressure, no change in pulse rate and an increase in respiratory rate. This effect is not produced after the ipsilateral vagus has been severed. They concluded that the great majority of the receptors responsible for this reflex were probably located in the pulmonary veins because reverse perfusion with the pulmonary artery open gave the same response as forward perfusion with the pulmonary veins closed. They also concluded that the bradycardia observed by Churchill and Cope and others was due to the stimulation of pressoreceptors in the region of the bifurcation of the main pulmonary artery resulting from a rise in pressure in that region, and not due to the same receptors located more peripherally in the pulmonary vascular bed which produced the respiratory and hypotensive responses.

In a recent review of publications regarding reflexes from stretch receptors, Aviado and Schmidt (1955)<sup>27</sup> concluded that the pattern of reflex action elicited by raising the pressure in the pulmonary vascular bed is (1) a biphasic respiratory response, apnea followed by tachypnea, and (2) peripheral vasodilation. They also concluded that bradycardia was not a part of this reflex, but that it was due to hypertension induced during the infusion in the region of the bifurcation of the main pulmonary artery where pressoreceptors were found that produced only bradycardia when stimulated.

Somewhat more direct evidence for the presence of pressoreceptors in the pulmonary vascular bed was that of Pearce and Witteridge (1951)<sup>28</sup> who recorded the action potential activity of the afferent nerves from these receptors from slips of the cervical vagus. They showed that



raising the pressure in the pulmonary artery increased the rate of action potential activity proportionately, and that lowering the pressure produced a reduction in the rate of fire. This work was done in the cat. Witteridge<sup>29</sup> had previously reported in 1948, recording in a similar manner action potentials from slips of the cervical vagus which appeared to have their origin from pressoreceptors in the pulmonary arterial bed and which increased when the pulmonary arterial blood flow was increased.

Hence, it appears that receptors sensitive to pressure changes may be present on the arterial side of the pulmonary vascular bed as well as on the venous side.





PLAN

Although a rather extensive literature on the subject of pressoreceptors in the pulmonary vascular bed has evolved since the work of Churchill and Cope in 1929, it is seen that there is rather a wide divergence of opinion regarding the nature of the reflex response produced by induced pulmonary hypertension. Consequently, although the presence of functionally significant pressoreceptors in the pulmonary vascular bed has been rather generally accepted, it was felt that further study of the nature of the reflex response elicited following their stimulation was warranted.

In general, the present approach to the problem was to perfuse the entire left lung of the intact dog with normal saline at body temperature under variable pressures and rates of flow and to measure (1) the perfusion pressure and rate of flow, (2) the femoral arterial pressure, (3) the pulse rate, (4) the main pulmonary arterial pressure, and (5) the intrapleural pressure (respiratory rate and depth). For this reason an apparatus was constructed by means of which the infusion pressure and rate of flow could be regulated. In order that the experiment might be performed on an intact animal, it was necessary to construct various cannulae so that the necessary manipulations could be performed on the close-chested preparation. Consequently, into each animal was placed (1) an infusion cannula into the left pulmonary artery, (2) a guide cannula sutured to the main pulmonary artery through which a 19 gauge L.P. needle could be passed for the purpose of measuring the main pulmonary arterial pressure, and (3) two specially designed snares for the pulmonary



veins, one for the upper and middle lobe veins and one for the lower lobe veins, by means of which the venous return of the left lung could be occluded or opened at will from the exterior of the animal. The effects of pulmonary hypertension induced by rapid saline infusion on the animals prepared in this manner were recorded by means of a Hathaway multichannel electronic recorder.

The animals were divided into two groups, a chronic group and an acute group. In the former the animals were prepared surgically under the usual aseptic conditions ten to fourteen days prior to the experiment. Fourteen animals were prepared in this group of which five could not be used for various technical reasons. Eight animals were prepared for acute experiments. In this latter group one could not be used because of death immediately following the the surgical preparation. It is important to note that in the acute as well as the chronic group the chest was carefully closed and the animal allowed to breathe room air entirely at his own volition. It would appear, therefore, that the two groups are comarable in this respect in terms of responses obtained.





## MATERIALS AND METHODS

### Cannulae and Snares

All of the cannulae and snares were constructed of the relatively inert plastic, polyethylene, from various sized of polyethylene tubing as supplied by the Clay-Adams Company of New York.

#### A. The infusion cannula:

The infusion cannula was constructed from P.E. 330 tubing with an internal diameter of .115 inches and an outside diameter of .147 inches. It was made in such a fashion that it had a bulge of somewhat greater diameter near the orifice. It was constructed in this way so that it would fit snugly in the vessel and not be able to slip out through the incision in the wall of the vessel through which it entered. For better anatomical placement, a bend of about 30° was made in the cannula at the point of egress through the vessel wall, this being 1.5 cm from the orifice.

#### B. The guide cannula:

The guide cannula was patterned after the suggestion of Harrison and Liebow.<sup>30</sup> It was constructed of P.E. 330 tubing. A foot plate was made by heating the end in a low flame and pressing it against a flat glass surface. A thin membrane of polyethylene was affixed to the plate with a hot instrument, thus sealing the end of the tube. Several holes were then punctured about the rim of the plate with a hot needle to facilitate suturing the cannula to the vessel. The sealing membrane permitted the introduction of a needle from the exterior without the danger of pneumothorax or hemorrhage in the acute experiments. In the chronic experiments it was useful in gauging the position

THE UNIVERSITY OF CHICAGO

PHILOSOPHY

THE UNIVERSITY OF CHICAGO  
PHILOSOPHY DEPARTMENT  
550 UNIVERSITY DRIVE  
CHICAGO, ILLINOIS 60607

PHILOSOPHY

THE UNIVERSITY OF CHICAGO  
PHILOSOPHY DEPARTMENT  
550 UNIVERSITY DRIVE  
CHICAGO, ILLINOIS 60607

PHILOSOPHY

THE UNIVERSITY OF CHICAGO  
PHILOSOPHY DEPARTMENT  
550 UNIVERSITY DRIVE  
CHICAGO, ILLINOIS 60607

of the vessel wall so that the needle could be introduced to the proper depth.

C. The snare:

The snare consisted of a piece of P.E. 330 polyethylene tubing which had been rendered slightly funnel-shaped at one end by heating over a low flame. Through this funnel were passed the two ends of a length of P.E. 60 polyethylene tubing to form the loop of a snare. A disc was then affixed to the outer tube, as illustrated in figure 1, which had been perforated about its circumference for the purpose of suturing to the pericardial sac as described in the operative procedure.

Veratridine

Veratridine, a member of the veratrum alkaloid group, known to stimulate certain receptors in the cardiovascular system as demonstrated by many workers,<sup>31,32,33,34,35,36</sup> was used to ascertain whether denervation of the pulmonary vascular bed had occurred accidentally during surgical manipulations in the region of the hilar plexus of nerves. This compound was shown by Heymans and de Vleeschouwer (1950)<sup>32</sup> and by Dawes, Mott and Widdicombe (1951)<sup>33</sup> to produce the sudden onset of apnea, bradycardia and hypotension, this being a reflex response dependent upon the integrity of the vagi. Aviado (1949)<sup>34</sup> showed that injection of the substance into the pulmonary artery produced immediate apnea, the bradycardia and hypotension not occurring until about 6 seconds after the injection. He concluded that the apnea was due to the stimulation of receptors present in the pulmonary vascular bed. This latter fact was used as a method of demonstrating the probable presence of intact pathways over which a reflex response could be mediated. And, therefore, any failure of response would not be on the





basis of accidental denervation during the surgical procedure. For this purpose 10 micrograms per Kg of veratridine were injected into the left pulmonary artery after closing the snares and occluding the venous return from the lung (with the exception of the bronchial veins).

#### Saline Perfusant

Saline was used for the perfusions in all instances. It was warmed to 37° C and kept at this temperature by immersing the reservoir in a constant temperature bath. This material was used not only because of its ready availability and convenience, but also because of the possibility that anticoagulated or defibrinated whole blood might produce a bradycardia by stimulation of chemoreceptors within the pulmonary vascular bed. Brodie (1900)<sup>10</sup> showed that the injection of serum from any animal into the external jugular vein produces immediate and marked inhibition of the heart with a fall of blood pressure and a simultaneous apnea. This attack is terminated by severing the vagi. However, he was able to produce this effect only in the cat and not in the dog or rabbit. Dawes (1949)<sup>37</sup> showed that the injection of as little as 0.05 ml of serum into the right heart of the cat produced this response. A much smaller response was elicited when the serum was introduced into the left heart. He concluded that the reflex was due primarily to chemoreceptors in the pulmonary vascular bed. Consequently, it was thought advisable to avoid introducing protein-containing material with the perfusant even though this effect has not been demonstrated as yet in the dog.

#### Animals

Mongrel dogs of both sexes weighing from 12 to 22 kg were used for



the experiments. Animals showing evidence of illness or pregnancy were not considered suitable.







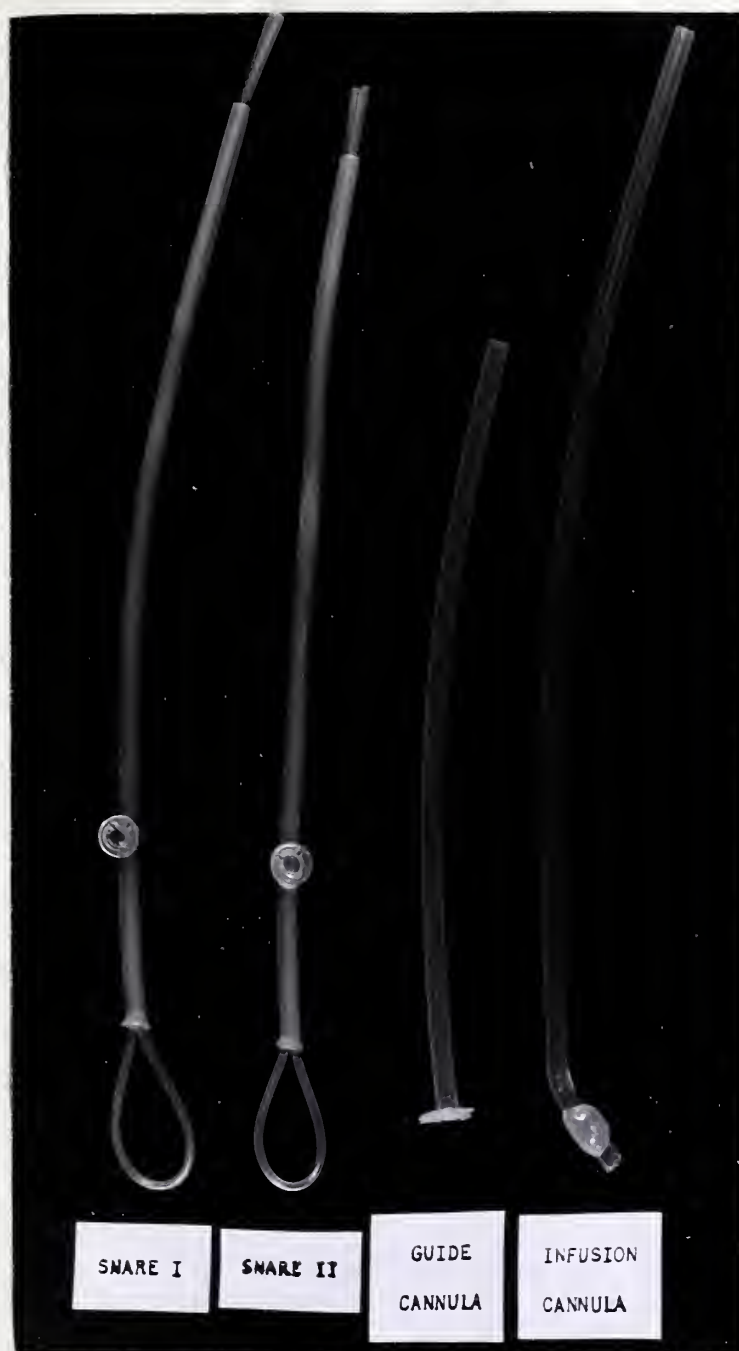

Fig. 1. Infusion cannula, Guide cannula and Snares. It is to be noted that two snares were used in each preparation, one for the upper and middle lobe veins and one for the lower lobe vein of the left lung.



## INFUSION APPARATUS

The infusion apparatus consisted of a calibrated reservoir of infusion fluid (saline) placed in a constant temperature bath, two mercury manometers, and the necessary tubing. Air under pressure was introduced into the top of the infusion reservoir and allowed to escape by way of an exhaust line also leading from the top of the reservoir. Hence, the pressure within the reservoir could be regulated by changing the resistance to egress of the air through the exhaust line, using a screw clamp for this purpose. The pressure within the reservoir was measured with a mercury manometer appropriately placed in the system. A second manometer was placed in the system between the reservoir and the infusion cannula in order to estimate the amount of pressure in the pulmonary vascular bed at the time of the infusion. This latter manometer was only for the purpose of convenience during the experiment, the actual pressure in the left pulmonary artery being accurately recorded by way of a cannula placed directly within the infused vessel. At the end of the infusion tubing was placed a glass "Y", one arm of which was attached to the infusion tubing. The base of the "Y" was attached to the infusion cannula. The other arm of the "Y" was sealed by a rubber diaphragm. A number 15 needle was used to perforate the diaphragm, and through the latter beyond its distal orifice for about 1 cm. into the left pulmonary artery. When the needle was removed from the diaphragm a watertight seal was left around the P.E. 90 cannula. This cannula so placed was used to measure the induced pressure in the left pulmonary vascular bed.

Utilizing the apparatus described above, it was possible to infuse saline at 37° C under controlled conditions of pressure and rate of flow.





The flow rate was found to be accurate within 3 to 5 per cent as determined by repeated infusions through the apparatus of 100 cc units at pressures ranging from 100 to 200 mm Hg in the saline reservoir. By measuring the actual volume ejected from the orifice of the cannula in a graduated cylinder, the graduations on the reservoir were accurately calibrated. During an infusion, the time required for 100 cc to flow from the apparatus was recorded by the time lines of the Hathaway recorder which are accurate to 0.1 second.



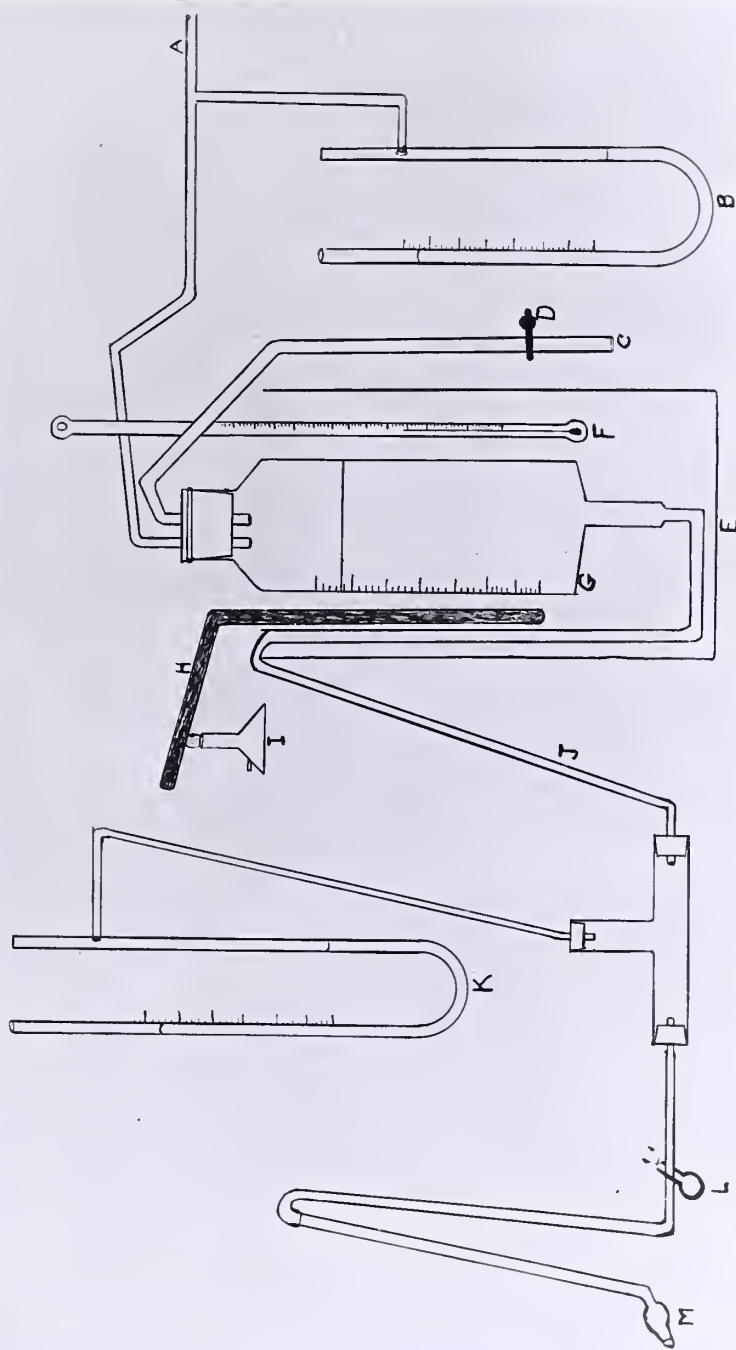

Fig. 2. Diagram of infusion apparatus. A = compressed air line. B = mercury manometer for measuring pressure in saline reservoir. C = exhaust line (air). D = screw clamp for regulating resistance in exhaust line and consequently pressure in saline reservoir. E = water bath at 37°C. F = thermometer. G = saline reservoir. H = conductor. I = heat source. J = saline infusion line. K = manometer for measuring approximate pressure in infusion line. L = pinch clamp. M = infusion cannula.



CALCULATION OF PERFUSION PRESSURES

In those instances where the perfusion pressure could not be recorded for technical reasons, the pressure was determined mathematically. The calculations were based on the formula

$$R = \frac{P_1 - P_2}{F}$$

or expressed differently

$$P_2 = P_1 - RF$$

where  $P_2$  is the pressure at the orifice of the infusion cannula;  $P_1$  is the pressure in the saline reservoir;  $F$  is the measured rate of flow of the saline through the infusion apparatus; and  $R$  is the resistance to flow through the infusion apparatus for that rate of flow that occurs during the infusion, as determined by measuring the flow through the apparatus at different reservoir pressures when the pressure at the orifice of the cannula is zero (atmospheric). A graph expressing the resistance to flow through the apparatus in relation to the rate of flow was constructed utilizing the first formula above when the pressure at the orifice of the cannula was zero. From this graph could be read the  $R$  for that rate of flow that occurred during an infusion which may then be used as the  $R$  in the second formula in order to calculate the  $P_2$  or pressure at the orifice of the infusion cannula.

Inspection of the data shows that where comparison of the recorded and calculated perfusion pressures is possible that the figures were in agreement generally, differing from 0 to 9 mm Hg with one exception in which the difference was 23 mm Hg.





SURGICAL PREPARATION - CHRONIC GROUP

The animals were not fed for 18 hours prior to surgery to obviate the danger of aspiration pneumonitis. On the morning of the operation those in the chronic group were given an injection of 600,000 units of penicillin and 1 gm of streptomycin intramuscularly. The animals were anaesthetized with Na pentobarbital/30 mg per kilogram. The chest was prepared by shaving and cleansing with green soap and zepharin solution. The animals was then draped in the usual fashion for a sterile operative procedure. An incision was made midsternally the entire length of the sternum and carried down to the periosteum. At this time the animal was placed on a positive pressure oxygen respirator, an endotracheal catheter with an inflatable bag to insure a snug fit having been previously introduced for this purpose. The sternum was split its entire length by means of an electrically powered rotary saw. The chest was thus opened widely and excellent exposure of its contents obtained. The pericardial sac was opened longitudinally and the left pulmonary artery identified. An F-silk suture and an elastic band of suitable size were passed around the left pulmonary artery in the region of the bifurcation of the main pulmonary artery. The elastic band was used for temporary occlusion of the left pulmonary artery and the F-silk for a safety device should the elastic band give way or function improperly. The hilar plexus of nerves was reflected in a sheet of connective tissue laterally as far as possible without damaging the nerves. The portion of the pulmonary artery just after its exodus from the pericardial sac was exposed. Four fine arterial sutures were placed on the wall of the vessel in the pattern of a square of 3 to 4 millimeters on a side. An incision was made within the area circumscribed by the square parallel to the long



axis of the vessel through its wall with a #15 knife blade. The infusion cannula introduced through this incision with its orifice pointing distally and the vessel wall closed by tying the previously placed sutures. The elastic band was then removed and, if no bleeding occurred, the F-silk also. Following introduction of the infusion cannula polyethylene plastic needle guide cannula as described was sutured to the surface of the main pulmonary artery. The pericardial sac was loosely closed with A-silk. The lung was retracted laterally and the hilar portions of all the pulmonary veins of the left lung identified and dissected free from the surrounding connective tissue. The inner portion of each of the venous snares was passed around these vessels, one around the upper and middle lobe veins and one around the lower lobe veins. The barrels of the snares were placed in position and sutured to the pericardial sac in order to maintain them in this position. The opposite ends of the infusion cannula, guide cannula, and venous snares were brought through the second, third, fourth, and fifth intercostal spaces, respectively, to a subcutaneous position where they were secured. Two million units of crystalline penicillin in 10 cc of saline was sprayed about the chest cavity and the chest closed with wire and silk.

The animals were kept on intramuscular injections of 200,000 units of penicillin and 1 gram of streptomycin daily for five days. There were no deaths from sepsis or pneumonitis. The skin stitches were removed after seven or eight days.

#### SURGICAL PREPARATION - ACUTE GROUP

In animals prepared for the acute group of experiments, no sterile precautions were used or antibiotics given. After closure of the chest,



The first part of the report deals with the general situation of the country and the progress of the work done during the year. It is followed by a detailed account of the various projects and schemes undertaken, and a summary of the results achieved. The report concludes with a list of the names of the staff and a statement of the total expenditure incurred.

The work done during the year has been of a most satisfactory nature, and it is a pleasure to record the progress made in all directions. The various projects and schemes undertaken have all been carried out in accordance with the programme of work laid down at the beginning of the year, and the results achieved are most encouraging.

The total expenditure incurred during the year has been within the limits of the estimate, and it is a pleasure to record that the accounts have been kept in a most satisfactory manner.

115

The second part of the report deals with the progress of the various projects and schemes undertaken during the year. It is followed by a detailed account of the results achieved, and a summary of the total expenditure incurred.

The progress made in all directions has been most satisfactory, and it is a pleasure to record the results achieved in each of the various projects and schemes undertaken.

The third part of the report deals with the progress of the various projects and schemes undertaken during the year. It is followed by a detailed account of the results achieved, and a summary of the total expenditure incurred.

The progress made in all directions has been most satisfactory, and it is a pleasure to record the results achieved in each of the various projects and schemes undertaken.



all incised areas in the skin were sealed with collodion. The animals were taken off the oxygen respirator but the endotracheal tube was left in place in case of an emergency. Otherwise, the preparation was essentially the same as for the chronic group.

#### COMMENTS ON PREPARATION OF ANIMALS

The reason for using snares for occluding the pulmonary veins rather than simply ligating them was so that it would be possible to perfuse the lung with the veins open first, and then with the veins occluded without necessitating opening the chest cavity.

#### EXPERIMENTAL PROCEDURE

The animals were anaesthetized very lightly with Na thiopental intravenously and titrated in such a way that they maintained an active eyelid reflex. An incision was made in the skin overlying the ends of the cannulae and the latter exposed. A #19 L.P. needle was passed through the guide cannula into the main pulmonary artery. The infusion apparatus was attached to the left pulmonary artery cannula. The left femoral vessels were cannulated, the femoral artery being used for recording systemic pressure changes and the femoral vein for infusion of the anaesthetic. A P.E. 90 cannula was inserted through the right chest wall through a #15 needle for recording intrapleural pressure changes. The left pulmonary artery infusion pressure was recorded by passing a P.E. 90 cannula into the left pulmonary artery through the lumen of the infusion cannula. The various cannulae were then attached to blood pressure capsules of a Hathaway multichannel electronic recorder; and the left pulmonary artery infusion pressure, the systemic blood pressure, the heart rate, the main pulmonary artery pressure and the



intrapleural pressure were all measured simultaneously. It is to be observed that the animal was breathing atmospheric air spontaneously and was otherwise an essentially intact, normal dog, with the exception of having only one lung (the right) available for respiratory exchange.

The animals were not heparinized systemically, but heparin was used in the various cannulae to keep them free of clot.

The animals were thus set up for recording the effects of raising the pressure in the pulmonary vascular bed from zero to hypertensive levels. The following experiment was performed and recorded:-

1. Base lines were obtained.
2. The Hathaway machine was standardized.
3. 100 cc of normal saline at 37° C was introduced into the left pulmonary artery at a pressure of 200 mm Hg in the saline reservoir.
4. The pulmonary veins of the left lung were occluded by pulling up the snares.
5. 100 cc saline at 200 mm Hg, as above.
6. 100 cc saline at 160 mm Hg, as above.
7. 100 cc saline at 100 mm Hg, as above.
8. Right vagosympathetic nerve severed in the cervical region.
9. 100 cc saline at 200 mm Hg, as above.
10. 100 micrograms per kilogram body weight of Veratridine introduced into the left pulmonary artery.
11. Left vagosympathetic nerve severed in the cervical region.
12. 100 cc saline at 200 mm Hg introduced, as above.
13. Veratridine, 10 micrograms per Kg introduced as above.
14. Machine recalibrated.

...the ... ..  
... ..  
... ..  
... ..  
... ..

... ..  
... ..  
... ..  
... ..

... ..  
... ..

... ..  
... ..

... ..  
... ..

... ..  
... ..

... ..  
... ..

... ..  
... ..

... ..  
... ..

... ..  
... ..

... ..  
... ..

15. Animal sacrificed.

It should be mentioned that after each infusion the pulmonary vein snares were opened in order to prevent the development of pulmonary edema from loading the pulmonary vascular bed with several hundred cubic cm of saline. Ample time was allowed following reclosure for equilibrium to occur.





## RESULTS

Twenty-two animals were prepared as described. Of these, five died of various causes prior to the recording. In the first six of the recorded series, no response was obtained because of the very small rate of perfusion obtained (less than 0.5 cc per second) through the small cannula of P. E. 205 utilized in the first eight dogs of the series. In two of the animals prepared with the larger cannulae, the cannulae were found at post mortem to have slipped out of position, one into the left lower lobe and one into the lingular lobe. No response was observed when these animals were perfused.

Twenty-nine observations were recorded on the nine remaining dogs in the manner described above, which demonstrated the response to acute pulmonary hypertension. Fourteen responses occurred in the four chronic dogs and fifteen responses in the five acute experiments. In the first two dogs of the chronic group the smaller cannulae were used (constructed of P. E. 205 with an internal diameter of 0.062 inches) and the infusion pressure was not recorded. However, when adequate flow was obtained by using very high pressures in the infusion reservoir an excellent response occurred. In all of the chronic animals that had the infusion cannula in their left pulmonary artery for ten to fourteen days, clotting occurred in the region of the orifice of the cannula to a variable extent. This was cleared as much as possible by aspiration, utilizing a cannula passed through the infusion cannula. However, there was always some clot left in the vessel which narrowed its lumen at a point slightly distal to the orifice of the infusion cannula. This obstruction resulted in an unusually high perfusion pressure just proximal to the clot where it was being recorded and



means that the remainder of the vascular bed was being perfused at a much lower pressure, relative to this proximal segment. This interpretation is borne out when one compares the pressures required to produce comparable responses in the chronic and the acute groups. For example, in dog #4444 of the chronic group, a pressure of about 135 mm Hg produced a drop of 37 mm Hg in systemic pressure, whereas in dog #7-0 of the acute group, the same degree of hypotension resulted from a pressure of only 42 mm Hg in the left pulmonary artery. Also, evidence for increased resistance to flow is suggested in comparing dog #4444 of the chronic group in which a left pulmonary artery pressure of 80 mm Hg produced a flow of only 0.9 cc per second, while a comparable pressure of 86 mm Hg in dog #5-0 of the acute group resulted in a flow of 3.8 cc per second.

It is to be noted that in none of the animals of either group was a response observed when perfused with the venous snares open and the venous return of the perfused lung unobstructed.

#### Effects on Systemic Blood Pressure

A drop in mean blood pressure as measured in the femoral artery of from 8 to 38 mm Hg occurred in all but one animal (#6-0) in which, however, the remainder of the reflex was elicited. This may be explained by the fact that the perfusion pressure did not rise above 36 mm Hg, which appears to be below the threshold required to elicit this response. There was, however, in this animal, a 30 mm Hg drop in diastolic pressure which was compensated for by a 60 mm Hg rise in the pulse pressure, suggesting that there may in fact have been some peripheral vasodilatation. This widening of the pulse pressure during the response was characteristic in all animals. Therefore, the drop in





diastolic pressure was in all instances greater than the drop in mean pressure because of the partial compensation by the increased pulse pressure.

In dog #444 of the chronic group where a long series of perfusions at various pressures was possible, there was an average drop of 1 mm Hg of systemic pressure for each 2.4 mm Hg rise in perfusion pressure with a range of 1:2.2 to 1:2.5. In dog #8-0 of the acute group in which a long series was also obtained, there was a 1 mm Hg drop for each 2.6 mm Hg rise in perfusion pressure with a range of 1:2.4 to 1:3.1. In dog #7-0 this figure was a 2.1 mm Hg rise in the perfusion pressure producing a 1 mm Hg drop in the mean systemic pressure with a range of 1:1.1 to 1:3.0. Hence, the average for the acute group correlates well with the chronic group, there being a 2.4 mm Hg rise required for each 1 mm Hg drop in systemic pressure.

It was observed that, after several perfusions in the same animal, the response to the same perfusion pressure was somewhat diminished. This characteristic was also noted by Parin (1943)

The drop in systemic pressure occurred simultaneously with the bradycardia and respiratory response six to seven seconds after the infusion had been started. The maximal pressure drop usually occurred between 15 and 30 seconds after starting the infusion. In most instances there appeared to be a tendency for the pressure to return to normotensive levels while the perfusion pressure was still elevated. The systemic pressure returned to normotensive levels in all cases in one to five minutes after lowering the perfusion pressure.

#### Effects on the Heart Rate

In 27 of the 29 observations, a cardiac slowing of from 5 to 90





beats per minute occurred simultaneously with the other effects. In one of the cases where bradycardia did not occur the animal had had several previous infusions in rapid succession, and one would expect a diminution in the response for this reason. The other failure was in an animal who showed only minimal response in the other portions of the reflex. This may have been on the basis of damage to the hilar plexus of nerves during the preparation of the animal.

There appeared to be some relationship between the reduction in heart rate and the perfusion pressure. However, this relationship seems to hold for only the first three or four perfusions. Calculations show that, very roughly, there is a slowing of the heart of about 1 beat per minute for every 2 mm Hg rise in perfusion pressure.

As was mentioned above, the bradycardia is usually accompanied by a considerable increase in the pulse pressure.

In all instances severing the right vagus had little or no effect on the response. However, after severing the left cervical vagosympathetic there was no change in heart rate, blood pressure or respirations when the perfusion pressure was again raised.

#### Effects on Respiration

The effects on respiration generally consisted of depression, a period of apnea or bradypnea, lasting for ten to twenty seconds and followed by a resumption of normal respirations. This effect was characteristic of all of the animals in the chronic group. However, three of the five animals in the acute group manifested rapid, shallow breathing rather than depression. The onset of both responses occurred 6 to 7 seconds after the infusion pressure had been raised. The degree of



respiratory depression or stimulation seems to have some correlation with the perfusion pressure, the amount of depression or stimulation being greater with greater perfusion pressures.

#### Main Pulmonary Artery Pressures

As noted, the main pulmonary artery pressure was measured in the region of its bifurcation. During the infusion the pressure in this vessel never increased more than 3 mm Hg, and frequently fell during the response period.

#### Post-mortem Examination

In all instances the animals were examined after sacrifice to be certain that all cannulae and snares were functioning properly. This proved to be the case in all but two of the animals examined as had been previously mentioned.

It is of interest that grossly obvious pulmonary edema occurred in one or more lobes of all of the animals of the chronic group. In one case (dog #445), all lobes of both lungs were filled with edema fluid, as was the trachea. However, edema which was grossly observable occurred in only one of the acute group (dog #4-0).

... ..  
... ..  
... ..

... ..

... ..  
... ..  
... ..  
... ..

... ..

... ..  
... ..  
... ..  
... ..

... ..  
... ..  
... ..  
... ..  
... ..  
... ..  
... ..



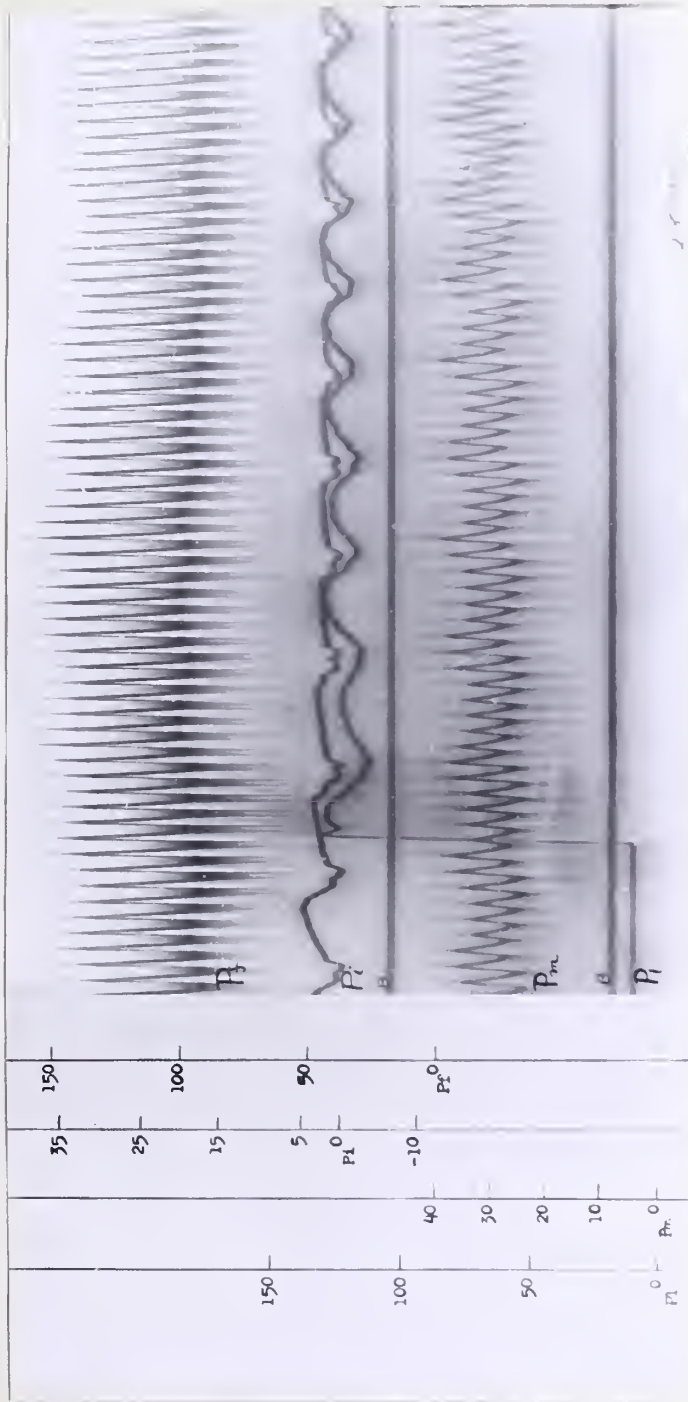

Fig. 3. Dog #444. Infusion of 100 cc saline with the pulmonary veins open.  $P_f$  = pressure in the femoral artery.  $P_i$  = intrapleural pressure.  $B$  = base lines.  $P_m$  = pressure in main pulmonary artery.  $P_l$  = pressure in the left pulmonary artery (infusion pressure). Time lines in 0.1 seconds. Minimal fluctuation of systemic blood pressure and no change in heart rate are observed after rapidly raising the pressure in the left P.A. from 0 to 116 mm Hg. There is no change in respiratory rate, the diminution of depth probably being due to the volume of fluid introduced. The main P.A. pressure is seen to rise only slightly.



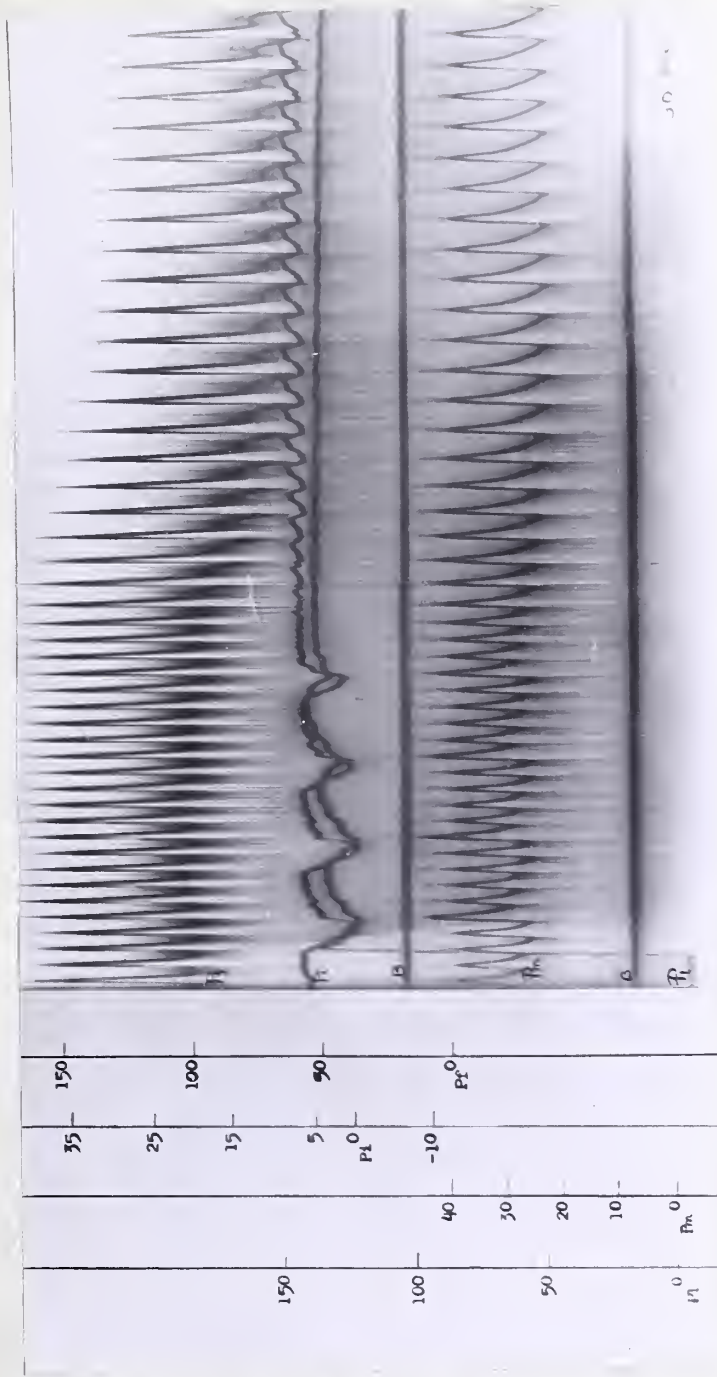

Fig. 4. Dog #444. Infusion of 100 cc saline with left pulmonary veins occluded. Pf=pressure in femoral artery. Pi=intrapleural pressure. B=base lines. Pm=pressure in main pulmonary artery. Pl=infusion pressure in left P.A. Time in 0.1 seconds. The pressure in the left P.A. is raised from 0 to 142 mm Hg. In 6 sec. the systemic blood pressure is seen to drop from a mean of 126 mm Hg to 88 mm Hg, the heart rate to drop from 180/min. to 90/min., and the respirations to cease. It is observed that the main P.A. pressure drops 2 to 3 mm Hg.





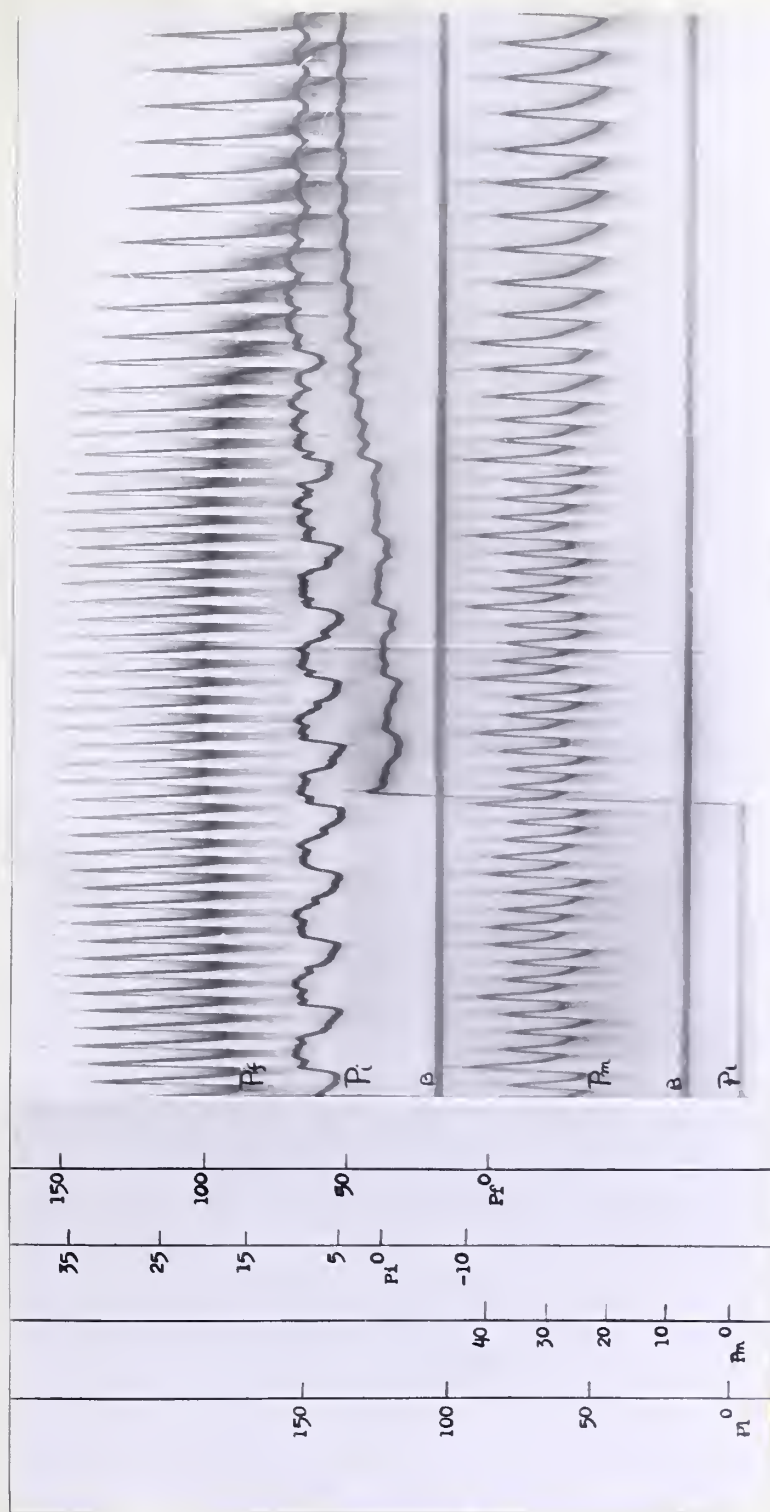

Fig. 5. Dog #1114. Introduction of 100 cc saline. Pulmonary veins (left) occluded. (Fourth infusion). Pf= pressure in femoral artery. Pi=intrapleural pressure. B=base lines. Pm=pressure in main P.A. P1=pressure in left P.A. (infusion). Time in 0.1 seconds. This represents a repetition of the infusion shown in Fig. 4. A drop of systemic pressure of 38 mm Hg, bradycardia (180 to 90/min.), and apnea are observed. The main P.A. pressure is seen to drop slightly. The left P.A. pressure in this infusion is also 142 mm Hg. The onset of the response is 6 sec. after the start of the infusion.



Handwritten text, likely bleed-through from the reverse side of the page. The text is extremely faint and illegible due to the quality of the scan and the age of the paper.



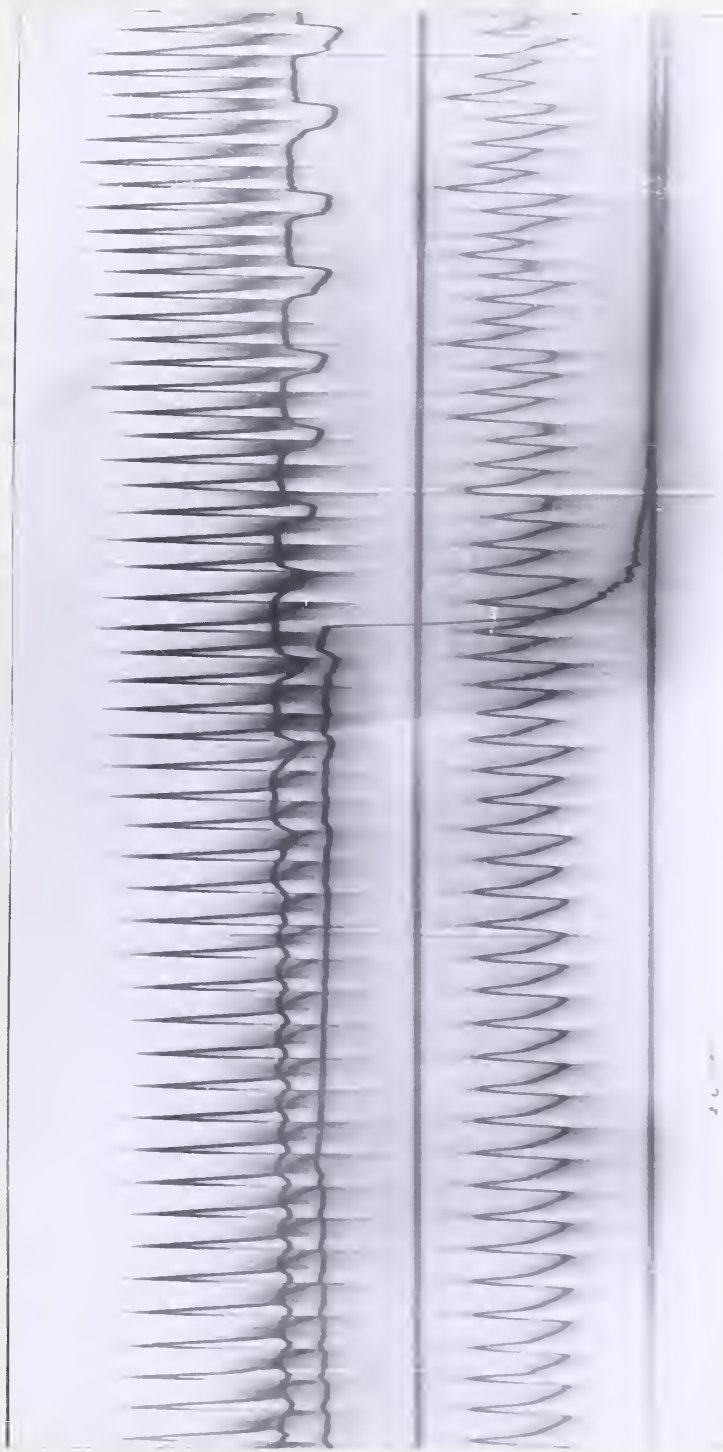

Fig. 6. Continuation of figure 5. About 0.4 seconds of recording between the two figures not included. It is seen that there is "vagal escape" to some extent in that the systemic pressure, the heart rate and the respirations begin to return to the pre-infusion state while the pressure in the left P.A. is still elevated.



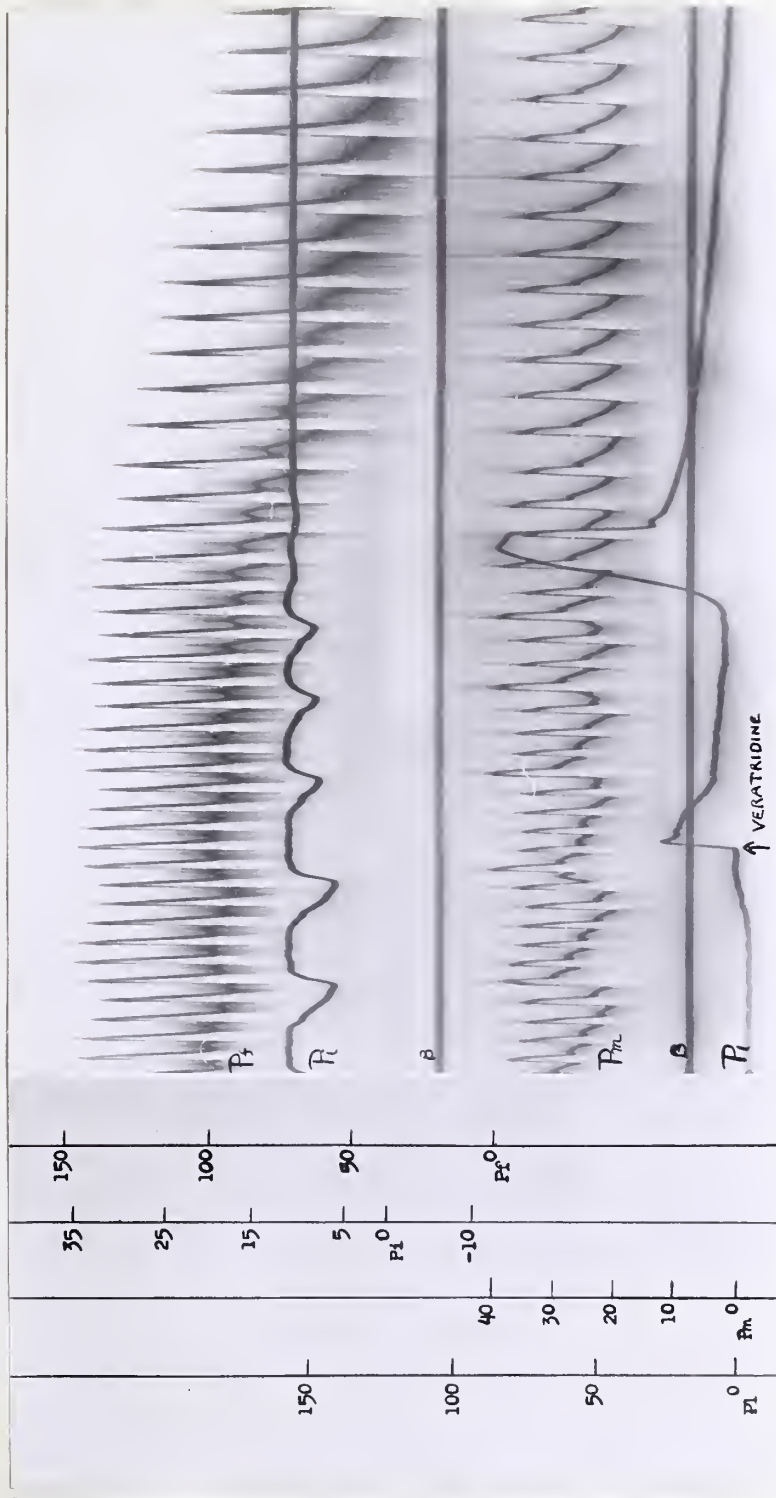

Fig. 7. Dog #444. Introduction of 10 mg/kg veratridine into the left P.A. Pf = pressure in femoral artery. Pi = intrapleural pressure. B = base lines. Pm = pressure in main P.A. P = pressure in left P.A. The characteristic response of this drug is seen to be a drop in systemic blood pressure, bradycardia and apnea, occurring 6 sec. after the injection. With the pulmonary veins occluded, it would appear that the response is due to the stimulation of receptors in the pulmonary vascular bed. Consequently, the material was used to determine if accidental denervation of the lung had occurred during the surgical preparation. The similarity of the response to that of acute hypertension in the same vessels is striking.





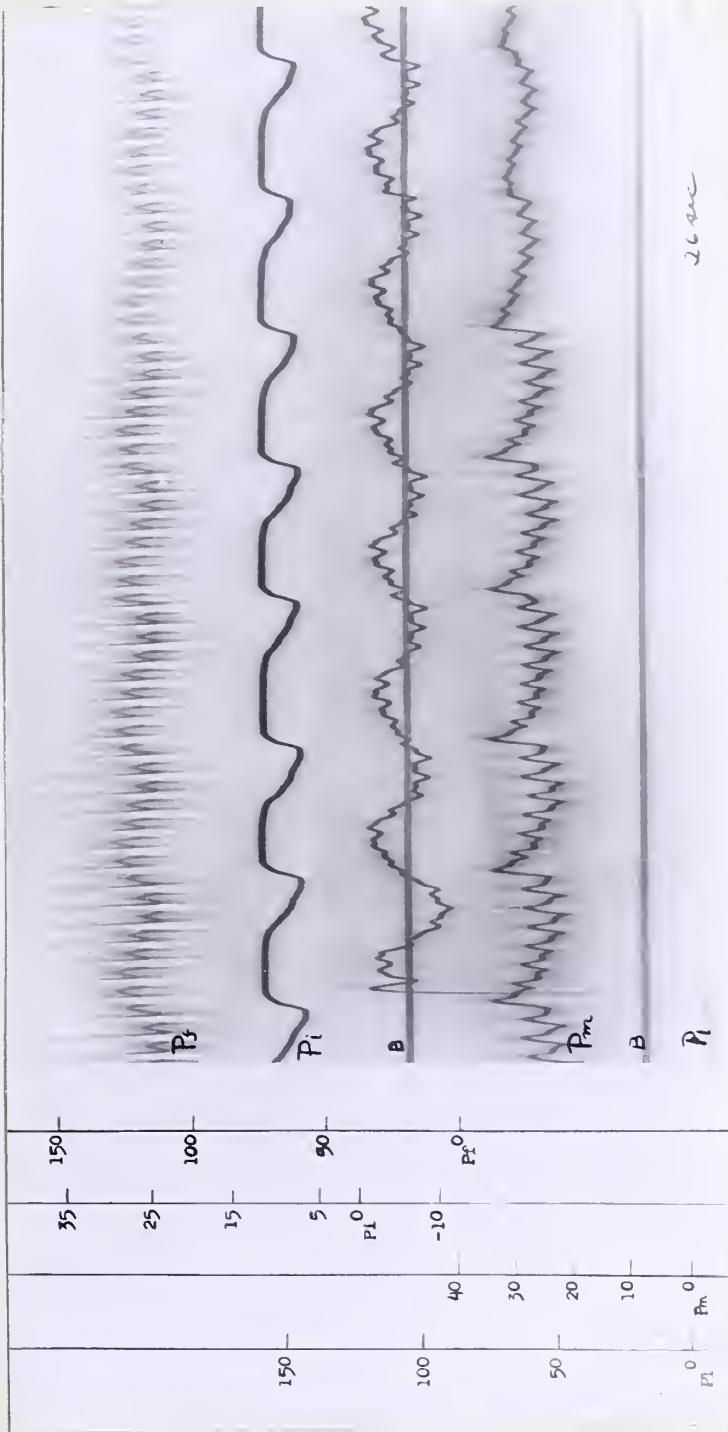

Fig. 8. Dog #444. Infusion of 100 cc saline after ipsilateral cervical vagosympathectomy. Pulmonary veins occluded on left. Pf = pressure in femoral artery. Pi = intrapleural pressure. B = base lines. Pm = pressure in main P.A. P1 = pressure in left P.A. time in 0.1 sec. It is seen that raising the pressure in the left P.A. to 120 mm Hg produces no effect on the systemic blood pressure, heart rate or respiration following denervation.



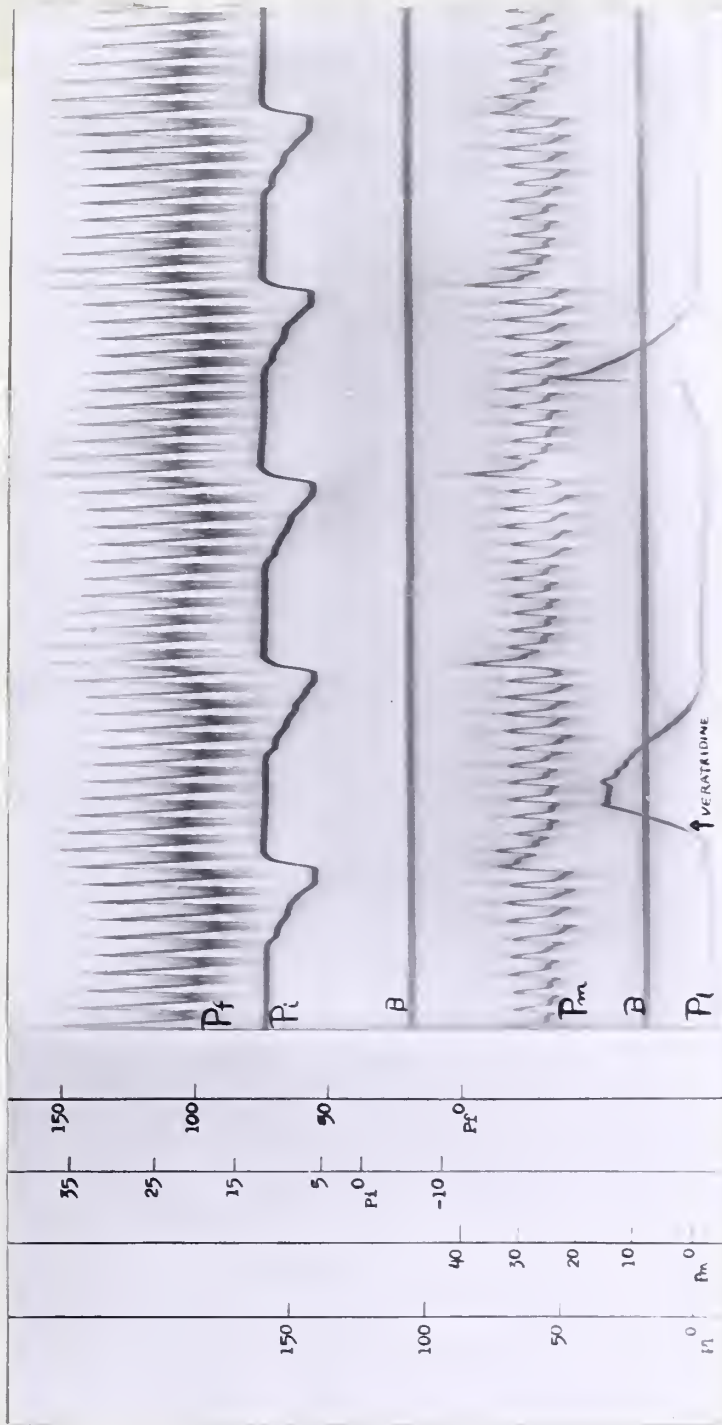

Fig. 9. Dog #444. Introduction of 10 mg/kg veratridine into left P.A. after ipsilateral cervical vagosympathectomy. Compare with Fig. 7. Pf = pressure in femoral artery. Pi = intrapleural pressure. B = base lines. Pm = pressure in main P.A. Pl = pressure in left P.A. Time in 0.1 sec. It is seen that the effects of veratridine as shown in Fig. 7 are abolished by denervation.



TABULATION OF DATA

Chronic Group

| Dog# | Weight (Kg) | Time  | Flow (cc/sec.) | Recorded LPAP in mm Hg                                                                                                                                | Calculated LPAP in mm Hg | Respiratory Response/min. * | Decrease in Heart Rate in beats/min. | Decrease in Blood Press. in mm Hg | Saline reservoir Pressure in mm Hg |
|------|-------------|-------|----------------|-------------------------------------------------------------------------------------------------------------------------------------------------------|--------------------------|-----------------------------|--------------------------------------|-----------------------------------|------------------------------------|
|      |             |       |                | (In this group of animals, a flow of not over 0.5 cc per second of perfusant was given. No response occurred because of inadequate rate of infusion.) |                          |                             |                                      |                                   |                                    |
| 395  | 18          |       |                |                                                                                                                                                       |                          |                             |                                      |                                   |                                    |
| 397  | 21          |       |                |                                                                                                                                                       |                          |                             |                                      |                                   |                                    |
| 398  | 13          |       |                |                                                                                                                                                       |                          |                             |                                      |                                   |                                    |
| 419  | 15          |       |                |                                                                                                                                                       |                          |                             |                                      |                                   |                                    |
| 427  | 19          |       |                |                                                                                                                                                       |                          |                             |                                      |                                   |                                    |
| 1-0  | 14          |       |                |                                                                                                                                                       |                          |                             |                                      |                                   |                                    |
| 430  | 12          | 10:00 | 3.3            | --                                                                                                                                                    | --                       | 70-60-70                    | 10                                   | 16                                | --                                 |
| 432  | 12          | 10:00 | 3.6            | --                                                                                                                                                    | --                       | 50-30-50                    | 5                                    | 21                                | --                                 |
| "    | 12          | 10:00 | 3.8            | --                                                                                                                                                    | --                       | 40-0-80                     | 18                                   | 12                                | --                                 |
| 444  | 13          | 12:44 | 3.3            | 142                                                                                                                                                   | 135                      | 40-0-45                     | 90                                   | 37                                | 200                                |
| "    | 13          | 12:50 | 3.8            | 142                                                                                                                                                   | 119                      | 50-0-50                     | 90                                   | 38                                | 200                                |
| "    | 13          | 1:10  | 2.7            | 107                                                                                                                                                   | 111                      | 55-35-55                    | 90                                   | 22                                | 160                                |
| "    | 13          | 1:15  | 0.9            | 80                                                                                                                                                    | 80                       | 60-50-60                    | 30                                   | 12                                | 100                                |
| "    | 13          | 1:27  | 3.8            | 123                                                                                                                                                   | 119                      | 38-50-45                    | 60                                   | 30                                | 300 (Rt. vagus cut)                |
| 445  | 17          | 12:55 | 4.0            | 114                                                                                                                                                   | 112                      | 20-0-20                     | 20                                   | 7                                 | 200                                |
| "    | 17          | 1:05  | 3.0            | 138                                                                                                                                                   | 143                      | 25-0-25                     | 36                                   | 13                                | 200                                |
| "    | 17          | 1:13  | 3.6            | 122                                                                                                                                                   | 125                      | 50-0-40                     | 30                                   | 0                                 | 200                                |
| "    | 17          | 1:20  | 3.9            | 134                                                                                                                                                   | 136                      | 10-0-10                     | 15                                   | 13                                | 220 (Rt. vagus cut)                |
| "    | 17          | 1:31  | 3.6            | 130                                                                                                                                                   | 125                      | 10-0-10                     | 16                                   | 7                                 | 200 (Rt. vagus cut)                |
| "    | 17          | 1:37  | 2.0            | 82                                                                                                                                                    | 74                       | 10-0-10                     | 24                                   | 20                                | 150 (Rt. vagus cut)                |

\* As the respiratory response is expressed here the first figure indicates the rate per minute prior to the infusion, the second figure is the rate during the infusion (0 indicates a period of apnea) and the third figure the rate following the infusion when the animal has returned to a relatively steady state.

LPAP indicates the perfusion pressure in the left pulmonary artery, as recorded and/or calculated.





Acute Group

| Dog# | Weight (Kg) | Time  | Flow (cc/sec.) | Recorded LPAP in mm Hg | Calculated LPAP in mm Hg | Respiratory Response/min.* | Decrease in Heart Rate in beats/min. | Decrease in Blood Press. in mm Hg | Saline reservoir Pressure in mm Hg |
|------|-------------|-------|----------------|------------------------|--------------------------|----------------------------|--------------------------------------|-----------------------------------|------------------------------------|
| 4-0  | 12          | 10:30 | 5.2            | --                     | 45                       | 10-0-10                    | 60                                   | 38                                | 200                                |
| "    | 12          | 10:45 | 1.9            | --                     | 56                       | 10-0-10                    | 30                                   | 15                                | 100                                |
| 5-0  | 22          | 1:18  | 3.8            | --                     | 86                       | 55-96-60                   | 0                                    | 8                                 | 200                                |
| 6-0  | 20          | 7:37  | 5.5            | --                     | 36                       | 50-80-55                   | 65                                   | 0                                 | 200                                |
| "    | 20          | 7:42  | 5.5            | --                     | 36                       | 50-75-50                   | 45                                   | 0                                 | 200                                |
| 7-0  | 12          | 1:43  | 5.3            | --                     | 42                       | 50-95-55                   | 68                                   | 38                                | 200                                |
| "    | 12          | 1:50  | 3.8            | --                     | 58                       | 50-65-50                   | 30                                   | 23                                | 160                                |
| "    | 12          | 2:00  | 5.3            | --                     | 42                       | 40-60-45                   | 30                                   | 14                                | 200                                |
| "    | 12          | 2:15  | 5.3            | --                     | 42                       | 12-40-20                   | 0                                    | 13                                | 200                                |
| 8-0  | 12          | 12:05 | 5.0            | 59                     | 50                       | 38-20-35                   | 45                                   | 21                                | 200                                |
| "    | 12          | 12:07 | 4.3            | 46                     | 45                       | 30-12-30                   | 25                                   | 3                                 | 160                                |
| "    | 12          | 12:10 | 5.0            | 46                     | 50                       | 38-15-25                   | 25                                   | 16                                | 200                                |
| "    | 12          | 12:17 | 5.0            | 51                     | 50                       | 18-8-18                    | 20                                   | 9                                 | 200 (Rt. vagus cut)                |
| "    | 12          | 12:36 | 4.5            | 37                     | 39                       | 14-12-14                   | 8                                    | 10(incr.)                         | 160                                |

\* As the respiratory response is expressed here the first figure indicates the rate per minute prior to the infusion, the second figure is the rate during the infusion (0 indicates a period of apnea) and the third figure the rate following the infusion when the animal has returned to a relatively steady state.

LPAP indicates the perfusion pressure in the left pulmonary artery, as recorded and/or calculated.



## DISCUSSION

The purpose of this investigation was to study the effects of acute hypertension in the pulmonary vascular bed of the dog. The observations in the species were similar to those of Churchill and Cope in 1929 in the cat. These workers found that acute pulmonary hypertension elicits a response consisting of a drop in systemic blood pressure, bradycardia, and apnea, followed by rapid shallow breathing. It was felt desirable to determine whether this response could be obtained in another species and, for this reason, dogs were used in the study. Saline was used as the perfusing material because of the findings of Brodie<sup>8</sup> and Dawes and Feldberg<sup>35</sup> that the introduction of serum into the pulmonary vascular bed would in itself produce a response similar to that described by Churchill and Cope.

The results showed an average of 1 mm Hg drop in systemic pressure for each 2.4 mm Hg elevation of perfusion pressure. This compares favorably with the findings of Churchill and Cope who found a 1 mm Hg drop in systemic pressure for each 2.3 mm Hg rise in perfusion pressure in the cat.

Bradycardia was found to be a component of this reflex almost consistently (27 out of 29 observations) in contrast to Daly, et al,<sup>17</sup> who found a decrease or increase in heart rate, and to Aviado<sup>24</sup> who found no change in the heart rate. It was the suggestion of Aviado that the other workers who had found bradycardia as part of the response may have been stimulating receptors in the region of the bifurcation of the pulmonary artery. For this reason the infusion cannula was constructed in such a way that very little, if any, perfusant could pass in a retrograde manner into the main or right pulmonary artery. The pressure





recordings in the main pulmonary artery never showed a rise of more than 3 mm Hg and more commonly the pressure in this vessel fell during the infusion. Therefore, it is concluded that bradycardia is a part of the response to hypertension in the peripheral pulmonary vascular bed, in agreement with Churchill and Cope.

The effects of the perfusion on the respirations of the animal were not so consistent. Churchill and Cope found that a period of apnea followed by rapid shallow breathing occurred in the cat. Aviado found that the response was characterized by an increase in the respiratory rate without a preceding period of apnea. In the present study it was found that, in six of the nine dogs, the response was one of depression, apnea or bradypnea, followed in a few seconds after the infusion had been terminated by a resumption of the original rate, or nearly so. The period of apnea when it occurred lasted from 10 to 20 seconds. In three of the animals, however, the response was that of rapid, shallow breathing during the infusion followed by a resumption of the original rate. The reason for this difference in response is not readily apparent from the data.

It was observed that all the components of the reflex occurred simultaneously 6 to 7 seconds after starting the infusion. Severing the contralateral vagosympathetic nerve in the cervical region did not appear to inhibit the reflex. However, severing the ipsilateral nerve abolished the response entirely.

In accord with the findings of Daly, et al,<sup>17</sup> a response to the high perfusion pressure did not occur when the pulmonary vein snares were left open and the venous return of the lung unimpeded with one exception. This may have been due to impingment on the veins by malplacement of the snare.



It is concluded that his study confirms the original findings of Churchill and Cope regarding the response of the cardiovascular system to acute pulmonary hypertension both qualitatively and quantitatively. The respiratory response, however, though a component of this reflex response is not as consistent and considerably more complex than the cardiovascular response.

#### Significance of the Reflex

An evaluation of the relative importance of a particular reflex in maintaining the homeostasis of the "milieu interne" of Claude Bernard and its relationship to the numerous other reflex mechanisms which are apparently of considerable import in the economy of the organism is somewhat tenuous. An attempt at elucidating the integrative activity of these various reflexes which have been "dissected", in a physiological sense, from the remainder of the homeostatic mechanisms also presents difficulties. However, a comparison of this reflex with other well established reflexes in the cardiovascular system may be attempted.

It has been well established that a drop in blood pressure in the region of the aortic arch results in an increase in heart rate because of reduction of vagal inhibition on the heart. This same response occurs when carotid sinus receptors are similarly stimulated, in addition to compensatory vasoconstriction. However, it appears that under the conditions of these experiments, the reflexes from the pulmonary vascular bed predominated over the former reflexes, and a bradycardia and hypotension was the net result of the summation of these forces.

As was mentioned, Schwiegk found that increasing the perfusion pressure in the pulmonary vascular bed resulted in an increase in splenic volume and peripheral vasodilation in the extremities. The





present study demonstrated a marked widening of the pulse pressure, also suggesting peripheral vasodilatation. It may be postulated that the venous return has been thereby diminished. If this is so, then the MacDowell reflex, which should tend to produce vasoconstriction in the peripheral vascular bed under circumstances of diminished venous return is also subjugated by the reflex from the pulmonary vascular bed.

Hence, it appears that this reflex may have considerable significance under certain conditions where a rapid elevation of pressure in the pulmonary vascular bed, especially on the venous side, is encountered.

This reflex may function to protect the pulmonary vascular bed from engorgment under circumstances in which the left ventricle is incapable of keeping up with the venous return. Under the physiological stress of exercise, for example, the venous return is greatly enhanced by muscular contractions. If the left ventricle should become temporarily deficient in its capacity to empty the pulmonary vascular bed, the resultant rise in pressure in this bed might then elicit the reflex. The resultant vasodilatation with pooling of blood in the visceral organs and reduction in the circulating volume would in turn reduce the venous return. A reduction of either the rate or depth of the respiratory excursions by counter-balancing the hyperpnea of exercise would reduce the pumping action of the lungs, and also tend to reduce the venous return which is over-loading the left ventricle.

Any beneficial effect of the cardiac inhibitory response is somewhat less evident. However, it may be postulated that, in concord with Starling's law of heart muscle, the efficiency of the ventricular contraction would be increased by reducing the tachycardia of exercise



The first part of the report deals with the general situation in the country. It is a very interesting and detailed study of the economic and social conditions of the country. The author has done a great deal of research and has gathered a wealth of material. The report is well written and is a valuable contribution to the knowledge of the country.

of the report.

The second part of the report deals with the specific details of the country. It is a very interesting and detailed study of the economic and social conditions of the country. The author has done a great deal of research and has gathered a wealth of material. The report is well written and is a valuable contribution to the knowledge of the country.

The third part of the report deals with the specific details of the country. It is a very interesting and detailed study of the economic and social conditions of the country. The author has done a great deal of research and has gathered a wealth of material. The report is well written and is a valuable contribution to the knowledge of the country.

The fourth part of the report deals with the specific details of the country. It is a very interesting and detailed study of the economic and social conditions of the country. The author has done a great deal of research and has gathered a wealth of material. The report is well written and is a valuable contribution to the knowledge of the country.

The fifth part of the report deals with the specific details of the country. It is a very interesting and detailed study of the economic and social conditions of the country. The author has done a great deal of research and has gathered a wealth of material. The report is well written and is a valuable contribution to the knowledge of the country.

The sixth part of the report deals with the specific details of the country. It is a very interesting and detailed study of the economic and social conditions of the country. The author has done a great deal of research and has gathered a wealth of material. The report is well written and is a valuable contribution to the knowledge of the country.

The seventh part of the report deals with the specific details of the country. It is a very interesting and detailed study of the economic and social conditions of the country. The author has done a great deal of research and has gathered a wealth of material. The report is well written and is a valuable contribution to the knowledge of the country.

The eighth part of the report deals with the specific details of the country. It is a very interesting and detailed study of the economic and social conditions of the country. The author has done a great deal of research and has gathered a wealth of material. The report is well written and is a valuable contribution to the knowledge of the country.

The ninth part of the report deals with the specific details of the country. It is a very interesting and detailed study of the economic and social conditions of the country. The author has done a great deal of research and has gathered a wealth of material. The report is well written and is a valuable contribution to the knowledge of the country.

The tenth part of the report deals with the specific details of the country. It is a very interesting and detailed study of the economic and social conditions of the country. The author has done a great deal of research and has gathered a wealth of material. The report is well written and is a valuable contribution to the knowledge of the country.

somewhat and allowing greater diastolic filling with resultant increase in stroke volume.

In a system of multiple checks and balances of the complexity encountered in the mammalian organism, the precise manner in which a given reflex is integrated into the total economy of the organism is not always entirely apparent.

In considering certain pathological states in which a rapid rise of pressure in the pulmonary vascular bed might be encountered as, for instance, in left ventricular failure following acute myocardial infarction, one is also on uncertain ground because of the multiplicity of factors involved. However, certain interpretations may be suggested.

Under circumstances of left ventricular failure with relatively more efficient right ventricular function, dyspnea, characterized by rapid, shallow breathing is a frequent finding. It may be postulated that, under these circumstances, engorgement of the pulmonary vascular bed and a rise in pressure is present. In three of the five animals of the acute group perfused in this series, rapid, shallow breathing was encountered. This was the characteristic finding of Churchill and Cope. Thus, the possibility exists that the dyspnea of the left heart failure is at least partially on the basis of this reflex.

How much of a role the reflex might have in the production of the hypotension and visceral congestion so commonly encountered in left ventricular failure is not evident. Also, the frequent finding of tachycardia in left ventricular failure of either a hypodynamic circulation or high output failure would suggest that the net balance of the integrated forces outweighs this tendency to cardiac slowing in these instances.



## SUMMARY AND CONCLUSIONS

In this investigation an attempt was made to determine the qualitative and quantitative nature of the reflex response elicited by the production of hypertension acutely in the pulmonary vascular bed of the dog. Saline was used for purposes of perfusion. It was introduced by an apparatus constructed in such a way that the perfusion pressure and rate of flow could readily be controlled. By utilizing especially constructed cannulae of polyethylene, it was possible to perform all of the experiments using animals with intact chests. Veratridine was used to determine if damage to the hilar plexus of nerves had occurred during the surgical placement of the cannulae and snares. The data includes 29 observations on nine dogs which showed a definite reflex response. Four of these animals were run as chronic experiments and five as acute experiments.

The results showed that a drop in blood pressure of 1 mm Hg occurred for every 2.4 mm Hg rise in perfusion pressure, a bradycardia of roughly 1 beat per minute for every 2 mm Hg rise in pressure, and a depression of respiration in six animals and rapid, shallow breathing in the remaining three.

Occlusion of the venous return of the perfused lung was necessary in order to produce the response in all but one instance.

All three components have their onset simultaneously 6 to 7 seconds after starting the perfusion. There appears to be some tendency for escape of the vagal inhibition after 20 to 30 seconds as manifested by a partial reversion of all components to the original state.







Severing the contralateral cervical vagosympathetic appears to have no effect on the response. However, severing the ipsilateral nerve completely abolishes all components of the reflex.

This study confirms in the dog the work of Churchill and Cope, with cats, as regards changes in heart rate and blood pressure. However, the respiratory response was found to be less consistent and somewhat different than that described by them.



BIBLIOGRAPHY

1. Temkin, O.: Was Servetus Influenced by Ibn al-Nafis?, *Bull. Hist. Med.*, viii: no. 5, 1940.
2. Bittar, Edward: A Study of Ibn Nafis, *Bull. Hist. Med.*, 29:352-368, 429-447, 1955.
3. Servetus, Michael: *Christianismi Restitutio*, p. 170, 1553
4. Colombo, Realdo: *De Re Anatomica Libri*, p. 123, 1559.
5. MacWilliam, J.A.: On Reflex Excitation of the Cardiac Nerves in Fishes, *J. Physiol.*, 4:233, 1885.
6. Einbrodt, N.: *Sitz. d. k. Akad. Wien*, 40:361, 1860.
7. Hering, E.: *Sitz. d. k. Akad. Wein*, 44:333, 1871.
8. Sommerbrodt, M.: *Zeitschr. f. klin. Med.*, II:601, 1881.
9. Brodie, T.G. and Russell, A.E.: On Reflex Cardiac Inhibition, *J. Physiol.*, 26:92, 1900.
10. Brodie, T.G.: The Immediate Action of an Intravenous Injection of Blood-Serum, *J. Physiol.*, 26:48, 1900.
11. Takino, M.: Vergleichende Studien über die histologische Struktur der Arteriae und Venae pulmonales, die Blutgefässnerven der Lungs und die Nerven der Bronchien, *Acta Sch. med., Univ. Kioto*, 15: 321-254, 1933.
12. Elftman, A.G.: The Innervation of the Lungs and Trachea, *Am. J. Anat.*, 72:1-27, 1943.
13. Nonidez, J.F.: Studies on the Innervation of the Heart. Afferent Nerve Endings in the Large Arteries and Veins, *Am. J. Anat.*, 68: 151-189, 1941.
14. Larsell, O. and Dow, R.S.: The Innervation of the Human Lung, *Am. J. Anat.*, 52:125-146, 1933.
15. Churchill, E.D. and Cope, O.: The Rapid Shallow Breathing Resulting from Pulmonary Congestion and Edema, *J. Exp. Med.*, 49:531-537, 1929.
16. Harrison, T.R., Calhoun, J.A., Cullen, G.E., Wilkins, W.E. and Pilcher, O.: Studies in Congestive Heart Failure. XV, *J. Clin. Invest.*, 11:133, 1932.
17. Schwiegk, H.: Der Lungenentlastungsreflex, *Arch. f. d. ges. Physiol.*, 236:206, 1935.



18. Schweitzer, A.: Vascular Reflexes from the Lung, *J. Physiol.*, 87: 46P., 1936.
19. Daly, I. deB., Ludany, G.V., Todd, A., and Verney, E.B.: Sensory Receptors in the Pulmonary Vascular Bed, *Quart. J. Exp. Physiol.*, 27:123, 1937.
20. Berry, J.L., Brailsford, J.F. and Daly, I. deB.: The Bronchial Vascular System in the Dog, *Proc. Roy. Soc. s.B.*, 109:319, 1931.
21. Megibow, R.S., Katz, L.N. and Steinitz, F.S.: Dynamic Changes in Experimental Pulmonary Embolism, *Surgery*, 11:19, 1942.
22. Yeomans, A., Porter, R.R., Swank, R.L.: Observations on Certain Manifestations of Circulatory Congestion Produced in Dogs by Rapid Infusion, *J. Clin. Invest.*, 22:33-45, 1943.
23. Heyer, H.E., Holman, J., and Shires, G.T.: Diminished Efficiency and Altered Dynamics of Respiration in Experimental Pulmonary Congestion, *Am. Heart J.*, 35:463-479, 1948.
24. Bulbring, E. and Witteridge, D.: The Activity of Vagal Stretch Endings During Congestion in Perfused Lungs, *J. Physiol.*, 103: 477-487, 1943.
25. Parin, V.V.: Role of Pulmonary Vessels in Reflex Control of Blood Circulation, *Am. J. M. Sc.*, 214:167-175, 1947.
26. Aviado, D.M., Li, T.H., Kalow, W., Peakin, G.W., Turnbull, G.L., Hess, M.E. and Weiss, A.J.: Respiratory and Circulatory Reflexes from the Perfused Heart and Pulmonary Circulation of the Dog, *Am. J. Physiol.*, 165:261-277, 1951.
27. Aviado, D.M. and Schmidt, C.F.: Reflexes from Stretch Receptors in Blood Vessels, Heart and Lungs, *Physiol. Rev.*, 35:247-300, 1955.
28. Pearce, J.W. and Witteridge, D.: The Relation of Pulmonary Arterial Pressure Variations to the Activity of Afferent Pulmonary Vascular Fibers, *Quart. J. Exp. Physiol.*, 36:177-188, 1950-51.
29. Witteridge, D.: Afferent Nerve Fibers from the Heart and Lungs in the Cervical Vagus, *J. Physiol.*, 107:496-512, 1948.
30. Harrison, W. and Liebow, A.A.: Polyethylene Plastic Needle Guides for Angiostomy, *Proc. Soc. Exp. Biol. and Med.*, 70:226-227, 1949.
31. Krayner, O. and Acheson, G.H.: The Pharmacology of the Veratrum Alkaloids, *Physiol. Rev.*, 26:383, 1946.
32. Heymans, C. and de Vleeschlouwer, G.: Mechanism of Bradycardia by Veratridine, *Arch. Int. Pharmacodyn.*, 84:409, 1950.
33. Dawes, G.S., Mott, J.C. and Widdicombe, J.G.: Respiratory and Cardiovascular Reflexes from the Heart and Lungs, *J. Physiol.*, 115:258, 1951.





34. Aviado, D.M.: The Reflex Respiratory and Circulatory Actions of Veratridine on Pulmonary, Cardiac and Carotid Receptors, *J. Pharm. and Exp. Ther.*, 97:420, 1949.
35. Dawes, G.S. and Widdicombe, J.G.: The Afferent Pathways of the Bezold Reflex: The Left Vagal Branches in Dogs, *Brit. J. Pharm.*, 8: 395, 1953.
36. Aviado, D.M., Cerletti, A., Li, T.H. and Schmidt, C.F.: The Activation of Carotid Sinus Pressoreceptors and Intracranial Receptors by Veratridine and Potassium, *J. Pharm. and Exp. Ther.*, 115:329, 1955.
37. Dawes, G.S. and Feldberg, W.: The Causes of Serum Bradycardia, *J. Physiol.*, 108:362, 1949.









1113  
412  
1980

