



University of Kentucky
UKnowledge

Biosystems and Agricultural Engineering Faculty
Publications

Biosystems and Agricultural Engineering

7-2006

Development and Testing of a Low-Cost Condensation Detection System

Michael D. Montross

University of Kentucky, michael.montross@uky.edu

George A. Duncan

University of Kentucky, gduncan@uky.edu

Richard S. Gates

University of Kentucky

Right click to open a feedback form in a new tab to let us know how this document benefits you.

Follow this and additional works at: https://uknowledge.uky.edu/bae_facpub

 Part of the [Agriculture Commons](#), and the [Bioresource and Agricultural Engineering Commons](#)

Repository Citation

Montross, Michael D.; Duncan, George A.; and Gates, Richard S., "Development and Testing of a Low-Cost Condensation Detection System" (2006). *Biosystems and Agricultural Engineering Faculty Publications*. 92.

https://uknowledge.uky.edu/bae_facpub/92

This Article is brought to you for free and open access by the Biosystems and Agricultural Engineering at UKnowledge. It has been accepted for inclusion in Biosystems and Agricultural Engineering Faculty Publications by an authorized administrator of UKnowledge. For more information, please contact UKnowledge@lsv.uky.edu.

Development and Testing of a Low-Cost Condensation Detection System

Notes/Citation Information

Published in *Applied Engineering in Agriculture*, v. 22, issue 4, p. 603-608.

© 2006 American Society of Agricultural and Biological Engineers

The copyright holder has granted the permission for posting the article here.

Digital Object Identifier (DOI)

<https://doi.org/10.13031/2013.21218>

DEVELOPMENT AND TESTING OF A LOW-COST CONDENSATION DETECTION SYSTEM

M. D. Montross, G. A. Duncan, R. S. Gates

ABSTRACT. A condensation sensing and control system was designed to detect condensation using a commercially available leaf wetness sensor (LWS). The leaf wetness sensor was a variable resistance grid-type that responded to moisture on the surface. A circuit was developed to compare the LWS voltage output to a user specified reference voltage, and operate a relay for possible switching of a humidity control device (for example a fan and/or heater). The condensation detection system operation was validated in an environmental chamber in the laboratory using a heat exchanger and water bath. Condensate was immediately detected when the plate was cooled below the dew point temperature of the chamber. When the water temperature increased above the dew point temperature, there was a delay as the moisture evaporated from the plate. Soil and other foreign material were added to the leaf wetness sensor with little effect on system performance. The soil acted to further delay the sensor from drying and predicted slightly longer condensation and recovery periods. The condensation detection system was tested in a transplant growing greenhouse and a grain bin, with operation verified by simultaneously measuring the relative humidity and dry bulb temperature. There were frequent periods of condensation in the greenhouse and the system accurately predicted them. Condensation did not occur in the grain bin, as was verified using the relative humidity and dry bulb temperature. The condensation detection system can provide a low-cost, rugged method for determining periods of condensation without the need for routine maintenance and calibration.

Keywords. Greenhouse, Grain bin, Moisture, Ventilation, Dehumidification, Humidity control.

Condensation in greenhouses, grain bins, peanut warehouses, and other structures can have deleterious effects on crops growing or products in storage. Condensation occurs more readily as a result of inadequate ventilation or poor air distribution (Hellickson and Walker, 1983). Relative humidities above 85% to 90% can result in the germination of pathogenic mold spores. If water vapor is not removed from a structure, then condensation will form on cool surfaces (Aldrich and Bartok, 1994), i.e. those with temperatures less than the dew point. Ventilation for moisture control is a critical aspect of greenhouse operation (Gates and Duncan, 1996). Simultaneous temperature and humidity control can be expensive in agricultural production systems, and simple methods to adjust temperature control systems as humidity increases shows promise (Bottcher et al., 1999).

Moisture control during grain storage is critical for maintaining optimal grain quality. Condensation and subsequent grain spoilage occur in the poorly ventilated headspace of a grain bin (Tanaka and Yoshida, 1984). Condensed moisture on grain leads to conditions that promote the development of molds and insects (Anonymous, 1992). Condensation on stored products such as, potatoes (Burton et al., 1991) and peanuts (Navarro et al., 1988), lead to significant economic losses.

Measuring the dew point temperature and surface temperature is one method that has been used to sense condensation. It has been successfully used to determine periods of condensation during grain storage (Montross et al., 2002). However, determining the dew point temperature requires knowledge of two air properties to calculate condensation conditions. Accurate relative humidity sensors are expensive, require frequent calibration, are sensitive to contamination, and usually do not function well in near saturation conditions.

Another method to determine condensation is to measure the temperature of the air and surface temperature and determine a temperature difference where condensation could be expected. This approach has been utilized in grain bins (Multon et al., 1980). However, the temperature difference was experimentally determined and probably would be a function of the grain bin structure, ventilation rate, and conditions of the stored product.

Systems have been developed to measure the wet bulb or dew point temperature and could be used to determine the potential for condensation. However, they are expensive, require frequent calibration, and cleaning. A low-cost system that is capable of reliably sensing the onset and the end of

Submitted for review in June 2004 as manuscript number SE 5358; approved for publication by the Structures & Environment Division of ASABE in April 2006. Presented at the 2002 ASAE Annual Meeting as Paper No. 024013.

This article is published with the approval of the Director of the Kentucky Agricultural Experiment Station and designated paper number 05-05-64.

The authors are **Michael D. Montross, ASABE Member Engineer**, Associate Professor, Biosystems and Agricultural Engineering Department, **George A. Duncan, ASABE Fellow Engineer**, Extension Professor, and **Richard S. Gates**, Professor and Chair, Biosystems and Agricultural Engineering Department, University of Kentucky, Lexington, Kentucky. **Corresponding author:** Michael D. Montross, Biosystems and Agricultural Engineering Department, 128 Barnhart Bldg., University of Kentucky, Lexington, KY 40546; phone: 859-257-7381 ext. 106; fax: 859-257-5671; e-mail: montross@bae.uky.edu.

condensation in structures with minimal need for calibration or maintenance would be desirable by scientists and industry.

The objectives of this study were to:

- develop a low-cost, low-maintenance system for the detection of condensation within structures;
- build and test the system under laboratory conditions, in a transplant growing greenhouse, and the headspace of a grain bin.

EQUIPMENT AND METHODS

A leaf wetness sensor (Vantage Pro, Davis Instruments, Hayward, Calif.) was determined to be an effective method of detecting condensation. Leaf wetness sensors (LWS) are designed to sense surface moisture. They work by using a gold-sketched sensing grid that is excited using a bi-polar 5-VDC source and a conductivity sensing circuit. The LWS is a variable resistance device that responds to the presence of surface moisture. When water droplets form on the gold-plated grid, the resistance changes from approximately 1 M Ω (under dry conditions) to approximately 130 k Ω (fully saturated conditions). The variable internal resistance within the sensor translates the change in resistance to a voltage output that varies between 1 and 6 VDC using a pull up resistor. Leaf wetness sensors are designed to work in weather stations and are used to detect surface moisture for irrigation control, pesticide application, disease prediction models and planting scheduling. The sensor eliminates concerns with the accurate measurement of relative humidity, dew point temperature, or wet bulb temperature and was developed for use in dirty environments without frequent calibration.

A control circuit (fig. 1) was designed to compare the output voltage from the leaf wetness sensor to a user

changeable reference voltage. The circuit was powered using an 18-VDC wall transformer. LM7812 and LM7805 voltage regulators (National Semiconductor, Santa Clara, Calif.) were used to provide 12 and 5 VDC for the control circuit and power for the leaf wetness sensor, respectively.

A voltage divider was used to control the output values from the leaf wetness sensor between 1 and 6 VDC. The output voltage is one of two input signals to an LM311 voltage comparator (VC in fig. 1, National Semiconductor, Santa Clara, Calif.). A reference voltage, created using a potentiometer in a voltage divider is connected to the comparator input. When the voltage from the sensor is less than the reference voltage, the low-level relay coils (CR in fig. 1) are grounded through the voltage comparator and a 12-VDC relay is closed (G3M, Omron Corporation, Kyoto, Japan). The CR contacts are used to control larger relays that switch the heaters or fans for humidity control. Two LEDs are used to provide visible feedback on CR coil status and control circuit power.

The condensation detection system poses a minimal safety hazard. The entire system is placed in a sealed box (NEMA 4) and can be located in a dusty and moist environment without risk to workers. The control relay (CR) is mounted in the control box and can be used to control power relays or motor starters located within other properly configured electrical junction boxes. Alternatively, the low voltage control signal could be used to activate power relays in other boxes mounted near the equipment to be controlled.

PROCEDURES

LABORATORY TESTS

Laboratory tests were devised to provide a repeatable and predictable test protocol prior to placing the system in the

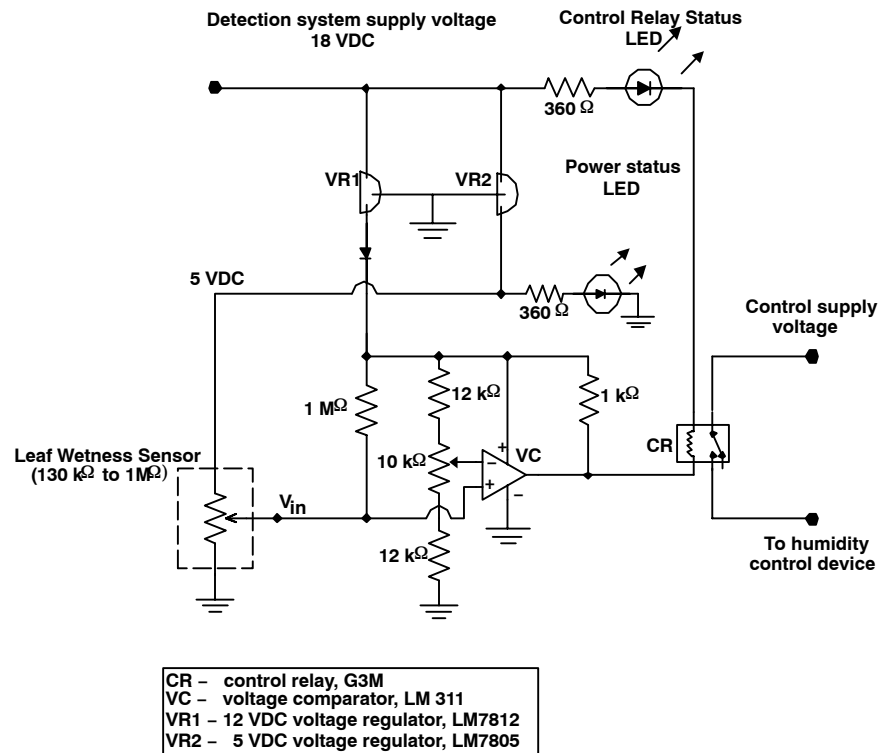

Figure 1. Schematic diagram of the control circuit for condensation sensor.

field. Sensitivity, accuracy, and effect of contamination on the performance of the system were evaluated. The system was tested using a temperature and relative humidity conditioning unit (Parameter Generation and Control, Model 9280, Black Mountain, N.C.) with a relative humidity accuracy of 0.5% and a temperature accuracy of 0.1°C. The unit supplied an airflow rate of 0.38 m³/min into an insulated chamber 1.2 m square with a height of 2.5 m. As a result, the air inside the chamber was well mixed and no additional aspiration for the instrumentation was used. The leaf wetness sensor was mounted on a copper plate with copper tubing soldered onto the plate to create a heat exchanger. A water bath with ice cooled the copper plate by means of a small submersible pump that circulated water from the water bath to the heat exchanger at a flow rate of approximately 4 l/min. The ice gradually melted, slowly increasing the temperature of the copper plate and the leaf wetness sensor. The system simulated the walls or ceilings of a structure being exposed to warm air inside (the environmental chamber) and cooler air outside (the cooled plate). Thermocouples were installed in the water bath, on the copper plate and in the air of the environmental chamber. The voltage output from the leaf wetness sensor and thermocouples were logged at 2-s intervals. The thermocouples were used to determine if the plate temperature was less than the dew point temperature of the air.

Three condensation detection systems were built and placed in the chamber and tested for accuracy and repeatability of the system. Trials were conducted at 25°C, 30°C, and 35°C and a relative humidity of 60%, 75%, and 90%. The output of the environmental chamber was verified using a chilled mirror dew point hygrometer (Edgetech, DewPrime II, Marlborough, Mass.) with a dew point accuracy of $\pm 0.2^\circ\text{C}$ and the chamber was determined to be working within its humidity accuracy of $\pm 0.5\%$ and a temperature of $\pm 0.1^\circ\text{C}$. The sensors were tested with each combination of temperature and relative humidity, resulting in dew point temperatures between 16.7°C and 33.1°C. All sensors were exposed in an air stream with an approximate velocity of 0.19 m/s. The sensors were tested in three positions: face up, face down, and vertically. Most of the tests were done with the face suspended down in the environmental chamber. This simulated the mounting of the sensor on the roof of a structure.

TRANSPLANT GROWING GREENHOUSE

A potential application of the system is the control of fans and/or heaters in a greenhouse, based on condensation formation on the “roof” of the structure. The system was tested in a double-layer plastic, hoop style, transplant growing greenhouse during May when seeds were germinated in floating seed trays. The leaf wetness sensor was mounted on an aluminum block that was pressed against the inner layer of plastic sheeting that acted as the greenhouse covering film, using a spring-loaded mechanism to insure good thermal contact. This allowed the block and leaf wetness sensor to be in thermal equilibrium with the inner layer plastic sheeting (“roof”) temperature.

Relative humidity and temperature were recorded using a HOBO Pro RH/Temp data logger (Onset Computer, Pocasset, Mass.) with an accuracy of $\pm 3\%$ RH in noncondensing environments ($\pm 4\%$ RH in condensing environments) and a temperature accuracy of $\pm 0.2^\circ\text{C}$. Additional temperature

measurements were taken with a HOBO H8 4-channel data logger (Onset Computer, Pocasset, Mass.) outside the greenhouse, above the float bed, and near the leaf wetness sensor (accuracy of $\pm 0.4^\circ\text{C}$). In addition, a thermistor was mounted on the aluminum plate. Based on these measurements, the dew point temperature of the air was calculated and periods of condensation could be predicted to verify the operation of the circuit.

GRAIN BIN

Another potential application of the system is to control grain bin headspace ventilation and similar stored product applications. A series of tests were performed in a grain bin after wheat harvest. The bin was a 7.3-m diameter, smooth walled bin filled to a depth of 9.1 m with wheat immediately after harvest, with a moisture content of approximately 14% wet basis. Three sensor systems were placed in the bin. The condensation detection system was installed on the south side of the grain bin near the manhole roof access point. This minimized the length of life lines required to enter the bin and reduced worker safety concerns. One sensor was placed on the south roof approximately 30 cm from the bin wall. The second sensor was placed about 5 cm from the top of the grain surface against the south side of the bin wall to sense condensation forming on the bin wall. The last sensor was set on the grain surface exposed to the bin headspace to detect condensation forming on the top grain surface of the bin. Each sensor was mounted on aluminum blocks similar to that described for the greenhouse test and bolted to the surfaces to ensure good thermal contact.

Temperature and relative humidity data loggers were used to measure the ambient and headspace air. Based on these data, the dew point temperatures of the air were calculated. Thermistors were mounted on an aluminum block to compare dew point temperatures during periods of condensation and to verify operation of the condensation detection system.

RESULTS AND DISCUSSION

LABORATORY TESTS

Uncontaminated Sensor

Figure 2 shows the typical response of the condensation detection system in an environmental chamber with a temperature of 30°C and 75% RH, with a corresponding dew point temperature of 25.1°C. The water temperature and leaf wetness sensor were initially at a temperature of approximately 30°C and no condensation was detected as expected. Ice was placed into the water bath at 2 min after the start of the experiment, and the cooled water was circulated through the copper plate with the attached leaf wetness sensor. At about 3 min into the test, the water temperature dropped to approximately 6°C and condensation immediately formed on the leaf wetness sensor. The sensor voltage was initially at 6 VDC and decreased to 1 VDC when condensate formed on the plate. The reference voltage was set at 5 VDC, and therefore whenever the sensor voltage was less than 5 VDC, the relay closed. The water temperature gradually increased and warmed to approximately 30°C. Based on the dew point and the plate temperature, the condensate began to evaporate after approximately 22 min. At a plate temperature of approximately 30°C, the condensate had evaporated from the

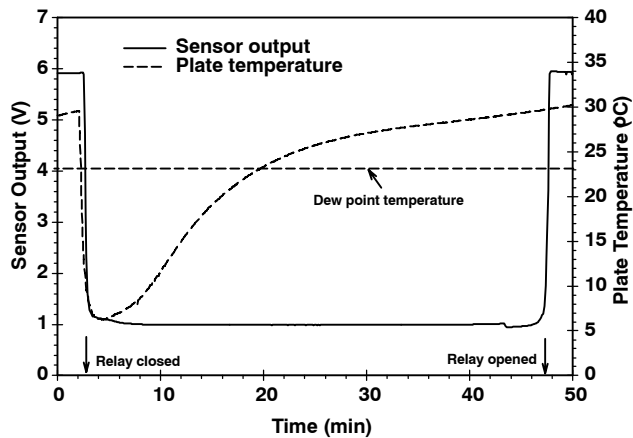

Figure 2. Performance of the condensation detection system in an environmental chamber with a dry bulb temperature of 30°C and 75% RH (dew point temperature of 25.1°C) using a water bath and heat exchanger to cool the sensor and produce condensation conditions with a reference voltage of 5 VDC.

leaf wetness sensor signifying that no condensation was detected, and the relay was opened.

The relay was closed for a total of 46 min. The time delay between the plate temperature crossing the dew point temperature and the relay opening was approximately 24 min. The time delay was due to mass transfer between the leaf wetness sensor and chamber air, a process that is relatively slow.

In another test, with a temperature of 30°C and a relative humidity of 90% (fig. 3, dew point temperature of 28.2°C), the system accurately predicted condensation. At the start of the test, the plate temperature was approximately 34°C. When ice was added to the water bath, the temperature immediately dropped to 7°C. Condensation formed and the relay closed. The water temperature gradually warmed past the dew point temperature (28.2°C) after 20 min. Condensate began to evaporate off of the plate and after an additional 38 min, the relay opened. The reference voltage was set at 5 VDC, therefore whenever the sensor voltage was less than 5 VDC, the relay was activated.

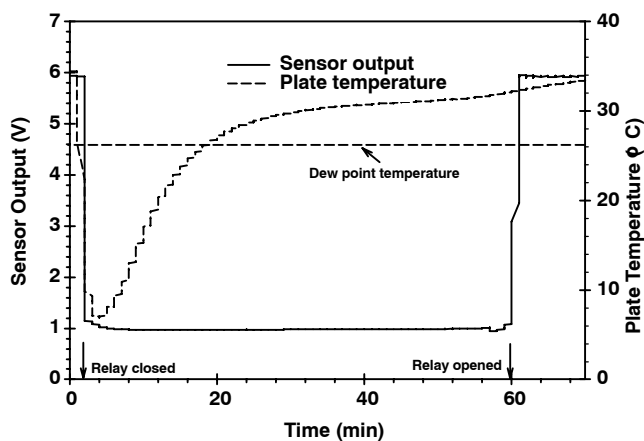

Figure 3. Performance of the condensation detection system in an environmental chamber with a dry bulb temperature of 30°C and 90% RH (dew point temperature of 28.2°C) using a water bath and heat exchanger to cool the sensor and produce condensation conditions with a reference voltage of 5 VDC.

The amount of condensate on the plate was not estimated or measured. However, the time the relay remained closed was a function of dry bulb temperature, relative humidity, and airflow rate (fig. 4). At a dew point temperature of 33.1°C (35°C, 90% RH), the average time the relay remained closed was 60 min. However, at a dew point temperature of 16.7°C (25°C, 60% RH), the relay was closed for 15 min. With high dew point temperatures, the relay remained closed for longer periods of time. The time delay for evaporating the condensate from the leaf wetness sensor was between 5 and 40 min. The time delay was a function of the relative humidity during the constant temperature and airflow conditions. Orientation of the leaf wetness sensor did not affect the system performance. Therefore, the sensor could be mounted on the underside of roofs and against walls.

Effect of Contamination

Dust and soil were added to the leaf wetness sensor as a thin film before condensate formed and after condensate had formed. During periods of condensation, foreign material and dirt would be a major problem for the sensing element. Figure 5 shows a trial with varying amounts of dirt, namely: clean, 50% covered, and 100% covered. The voltage reference was lowered to 3 VDC to prevent the relay from activating due to the presence of dry dirt. With dry dirt on the sensor, the output was 5 VDC. With a reference voltage of 5 VDC, the circuit produced a false positive due to the presence of the dry dirt. Lowering the voltage reference to the comparator prevented the circuit from returning false predictions of condensation conditions. A voltage output of 4 VDC from the leaf wetness sensor would have produced a positive reading if the reference voltage were left at 5 VDC. This would have resulted in the circuit predicting condensation due to the conductivity of the soil particles on the leaf wetness sensor.

Soil particles slowed the mass transfer from the sensor and resulted in the relay remaining closed for a slightly longer period (approximately 7% to 14% compared to the sensor with no soil particles). However, after the soil was wiped off, there was no residual effect and the system behaved identical to the previous tests with no soil particles. The delay was insignificant when the user settable reference voltage was set to 3 VDC. However if the reference voltage was set in the 5-

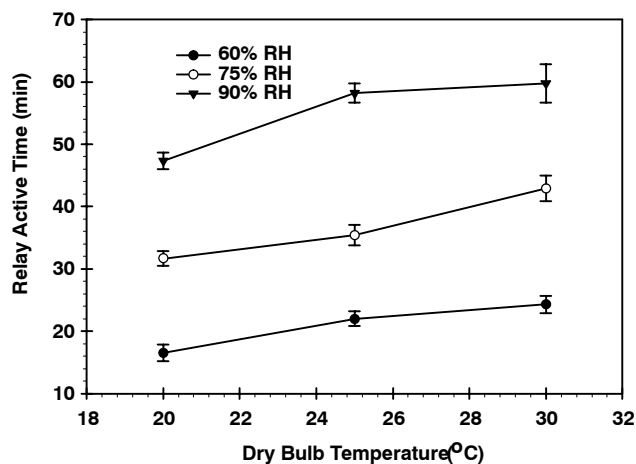

Figure 4. Average and standard error ($n = 5$) of the relay active time as a function of temperature and relative humidity.

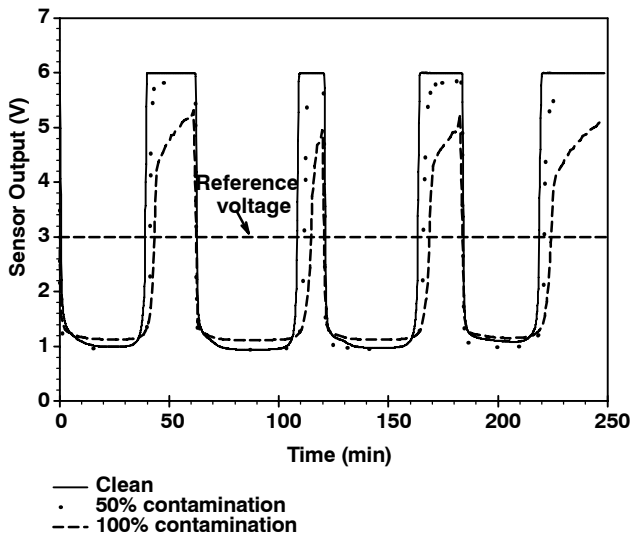

Figure 5. Reference voltage and sensor voltage output with no contamination, 50% contamination in the form of soil particles, and sensor 100% covered with soil particles in a chamber with a dry bulb temperature of 20°C and 90% RH (dew point temperature of 18.3°C). (Sensor output voltages less than the reference voltage resulted in the relay closing).

to 6-VDC range, the delay due to dirt would be more significant in addition to false positive indications of condensation. The system was also tested with grain dust on the leaf wetness sensor. The same general behavior was observed. A delay was created due to the foreign material on the leaf wetness sensor that inhibited mass transfer. A reference voltage of 3 VDC was therefore used for all tests to prevent false positive readings.

FIELD TESTS

Operation in a Transplant Growing Greenhouse

The results were consistent (dry in the day and condensation at night) except for four days where the circuit was activated for unknown reasons during the day, probably liquid fertilizer being applied to the beds which could have caused moisture to form on the sensor (not shown). Figure 6

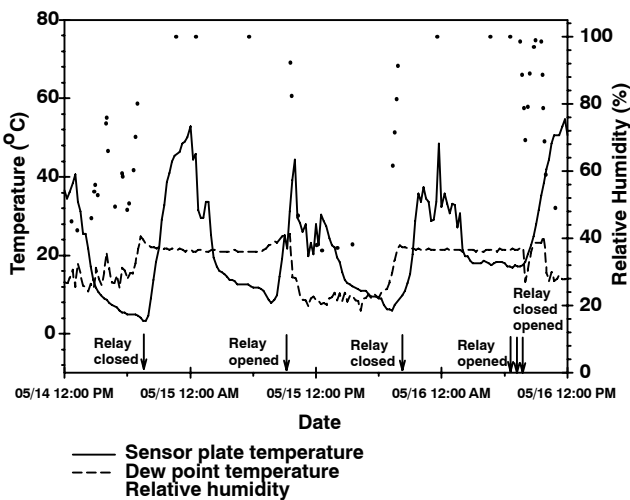

Figure 6. Field test in transplant growing greenhouse showing sensor mounting plate temperature (located near the top of the greenhouse), dew point temperature 1 m above float trays, relative humidity and relay state (closed or open) with a reference voltage of 3 VDC.

shows the relay status, plate temperature, dew point temperature, and relative humidity of the system at the peak of the greenhouse.

On 14 May (fig. 6), the relays were closed at night after condensate had built up on the sensor. The dew point temperature was greater than the temperature of the aluminum block and condensation formed and closed the relay. Around 9:00 PM the temperature of the plate increased above the dew point temperature and the condensation evaporated from the leaf wetness sensor. The relay opened at approximately the same time as the dew point decreased below the temperature of the leaf wetness sensor.

The relative humidity approached 100% every night during the test. The increase in the roof temperature (using a sensor pushed up against the plastic covering of the greenhouse near the top of the hoop) during the night was a result of the heaters running in the greenhouse. However, condensation had already formed on the leaf wetness sensor before the heater was turned on. An insufficient amount of heat was supplied to reduce the condensation that formed on the leaf wetness sensor until early morning. The plate temperature was greater than the dew point temperature after 9:30 PM. However, with relative humidity values near 100%, the condensate had not evaporated from the leaf wetness sensor until 9:00 AM.

A similar trend can be seen the following night when the dew point temperature was higher than the sensor temperature. There was a delay after the dew point temperature increased above the plate temperature and the relay closed. The plate temperature increased above the dew point temperature and the relative humidity was 100%. This did not allow any condensate to evaporate from the leaf wetness sensor; so the relay remained closed. The plate temperature dipped below the dew point again at 2:00 AM of the next day and rose above the dew point temperature around 9:00 AM. The relays turned off at 9:07 AM and the cycle repeated in the evening. The data confirmed the operation of the system. When the sensor plate temperature was below the dew point, condensation was expected, and the relay was closed. However, after the heater was turned on, the relative humidity remained at 100% near the peak of the greenhouse and condensate did not evaporate from the leaf wetness sensor until the following morning. Condensation was consistently predicted around 7:00 PM and lasted until the following morning until around 9:00 AM. The heaters did not supply enough energy to the greenhouse to prevent condensation on the underside of the roof structure. However, the crop produced was healthy without any disease or mold problems reported, perhaps due to the low temperatures that existed within the greenhouse.

Operation in a Grain Bin

There were no periods of condensation detected using the leaf wetness circuit or with the roof and dew point temperature comparison. Conversations with the farmer indicated that the wheat was unloaded in excellent condition and there were no signs of condensation problems in the bin.

Figure 7 shows the dew point, wall, roof, and grain surface temperature and the relative humidity of the headspace air. The dew point temperature was considerably lower than the surface temperatures measured at the three locations within the bin. In addition, the relative humidity of the headspace air

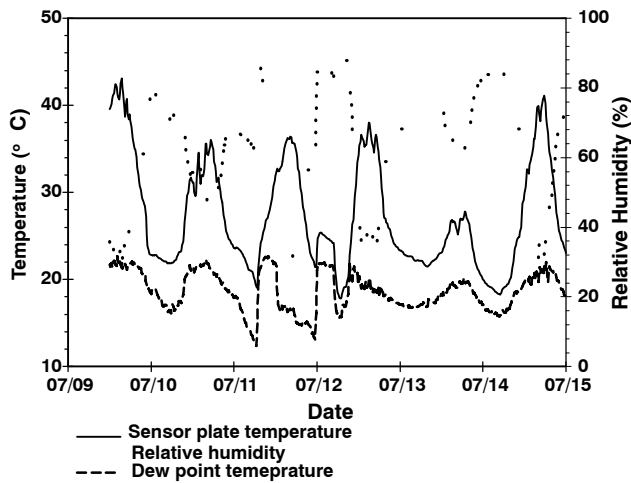

Figure 7. Field test in grain bin headspace of sensor mounting plate temperature, dew point temperature, and relative humidity with a reference voltage of 3 VDC.

remained below 100% over the period tested. However, this system did not predict any periods of condensation although the dew point and surface temperature approached an equal value. Data collected (fig. 7) confirmed that there were only brief periods of time when condensation was possible. These three instances were within the accuracy of the relative humidity and temperature sensors.

On 11 July, the measured roof temperature and dew point temperature were approximately equal. A couple reasons are suggested as to why the circuit did not detect condensation. First, the relative humidity sensor was mounted near the leaf wetness sensor and may not have accurately represented the true conditions of the headspace air. The relative humidity sensor was only accurate to $\pm 4\%$ at a RH of 90%. The errors associated with the relative humidity sensor and thermistor limit the accuracy of predicting condensation in high humidity environments. Secondly, the environment in the bin was clean and the system could have been made more sensitive by adjusting the reference voltage from 3 to 5 VDC. This could have resulted in condensation conditions being predicted during the test.

COST OF SYSTEM

The overall cost of the system was approximately \$125. The largest expense of the system was the leaf wetness sensor at a cost of approximately \$85. All components of the circuit are readily available and relatively inexpensive. Other special relays would be required to control higher amperage motors on heaters and fans.

SUMMARY AND CONCLUSIONS

The condensation detection system is a low-cost, repeatable system, capable of predicting condensation in a number of structures including greenhouses and grain bins. Tests conducted in the laboratory indicated that the circuit and sensors produced repeatable results. In addition, the system

was not significantly affected by dirt or other contamination on the surface. Contamination of the leaf wetness sensor required a decrease in the reference voltage. However, the system performed in a similar manner to a system with no contamination when the leaf wetness sensor was wiped clean. The system performed well in a transplant growing greenhouse, accurately predicting condensation during night-time periods. Condensation was not detected in the grain bin during the limited tests conducted. The control circuit and system allowed for the prediction of periods of condensation without relying on relative humidity or dew point temperature sensors. This should improve the reliability of ventilation systems that require the accurate sensing of periods of condensation.

ACKNOWLEDGEMENTS

The authors wish to acknowledge Mr. Charles Beaman, Science Instructor for Jessamine County High School, Nicholasville, Kentucky, and Mr. Matthew Braun, former student at Jessamine County High School for their collaboration with the design and construction of the system.

REFERENCES

- Aldrich, R. A., and J. W. Bartok, Jr. 1994. Greenhouse Engineering. Northeast Regional Agricultural Engineering Service Publication NRAES-33. Ithaca N.Y.: NRAES, Cooperative Extension, Cornell University.
- Anonymous. 1992. *Storage of Cereal Grains and their Products*, ed. D. B. Sauer. St. Paul, Minn.: American Association of Cereal Chemists.
- Botcher, R. W., D. G. Overhults, R. S. Gates, and M. B. Timmons. 1999. Field studies of time integrated variable control in broiler growout housing. ASAE Paper No. 994223. St. Joseph, Mich.: ASAE.
- Burton, W., A. Van Es, and K. Hartmans. 1991. The physics and physiology of storage. In *The Potato Crop*, ed. P. Harris, 608-727. New York: Chapman and Hall.
- Gates, R. S., and G. A. Duncan. 1996. Ventilation system design parameters for greenhouses for tobacco production. AEU-90. Lexington, Ky.: Biosystems and Agricultural Engineering Department, University of Kentucky.
- Hellickson, M. A., and J. N. Walker. 1983. *Ventilation of Agricultural Structures*. St. Joseph, Mich.: ASAE.
- Montross, M. D., D. E. Maier, and K. Haghghi. 2002. Development of a finite element stored grain ecosystem model. *Transactions of the ASAE* 45(5): 1455-1464.
- Multon, J. L., B. Cahagnier, G. Bryon, J. C. Lasseran, and G. Niquet. 1980. Heat and water vapor transfers in corn (maize) bin and improvement of ventilation management. *Cereal Foods World* 25(1): 16-20.
- Navarro, S., N. Paster, and Y. Carmi. 1988. Prevention of condensation damage to groundnuts in containers using calcium chloride. *Crop Prot.* 7(3): 198-201.
- Tanaka, H., and K. Yoshida. 1984. Heat and mass transfer mechanisms in a grain storage silo. In *Eng. and Food*, Vol. I, ed. B. M. McKenna. New York: Elsevier Applied Science Publ.
- Timmons, M. B., and R. S. Gates. 1987. Relative humidity as a control parameter in broiler housing. *Transactions of the ASAE* 30(4): 1111-1115.