



KENTUCKY TRANSPORTATION CENTER

**STRUCTURAL EVALUATION OF THE JOHN A. ROEBLING
SUSPENSION BRIDGE - ELEMENT LEVEL ANALYSIS**





OUR MISSION

We provide services to the transportation community
through research, technology transfer and education.

We create and participate in partnerships
to promote safe and effective
transportation systems.

OUR VALUES

Teamwork

Listening and communicating along with
courtesy and respect for others.

Honesty and Ethical Behavior

Delivering the highest quality
products and services.

Continuous Improvement

In all that we do.

Research Report
KTC-08-23/KH53-06-1F

STRUCTURAL EVALUATION OF THE JOHN A. ROEBLING SUSPENSION BRIDGE –ELEMENT LEVEL ANALYSIS

by

Ching Chiaw Choo

Post-doctoral Research Fellow, Kentucky Transportation Center
Department of Civil Engineering
University of Kentucky

and

Issam E. Harik

Professor of Civil Engineering and Program Manager, Structures and Coatings Section,
Kentucky Transportation Center
University of Kentucky

Kentucky Transportation Center
College of Engineering, University of Kentucky

in cooperation with

Transportation Cabinet
Commonwealth of Kentucky

and

Federal Highway Administration
U.S. Department of Transportation

The contents of this report reflect the views of the authors who are responsible for the facts and accuracy of the data presented herein. The contents do not necessarily reflect the official views or policies of the University of Kentucky, the Kentucky Transportation Cabinet, nor the Federal Highway Administration. This report does not constitute a standard, specification or regulation. Manufacturer or trade names are included for identification purposes only and are not to be considered an endorsement.

July 2008

Technical Report Documentation Page

1. Report No. KTC-08-23/KH53-06-1F	2. Government Accession No.	3. Recipient's Catalog No.	
4. Title and Subtitle STRUCTURAL EVALUATION OF THE JOHN A. ROEBLING SUSPENSION BRIDGE – ELEMENT LEVEL ANALYSIS		5. Report Date July 2008	
		6. Performing Organization Code	
7. Author(s): Ching Chiaw Choo and Issam Harik		8. Performing Organization Report No. KTC-08-23/KH53-06-1F	
9. Performing Organization Name and Address Kentucky Transportation Center College of Engineering University of Kentucky Lexington, Kentucky 40506-0281		10. Work Unit No. (TRAIS)	
		11. Contract or Grant No. KH 53	
		13. Type of Report and Period Covered Final	
12. Sponsoring Agency Name and Address Kentucky Transportation Cabinet State Office Building Frankfort, Kentucky 40622		14. Sponsoring Agency Code	
		15. Supplementary Notes Prepared in cooperation with the Kentucky Transportation Cabinet and the U.S. Department of Transportation, Federal Highway Administration.	
16. Abstract The primary objective of the structural evaluation of the John A. Roebling Bridge is to determine the maximum allowable gross vehicle weight (GVW) that can be carried by the bridge deck structural elements such as the open steel grid deck, channels, standard sections, or built-up sections. To achieve this objective, an "Element Level Analysis" is carried out. The maximum allowable GVW for different truck and bus types are presented for different levels of structural elements sectional loss. The loss or reduction in element sectional properties is due to rust, cracks, etc. The critical member in the bridge deck is the built-up 36 inch deep section. Its allowable bending strength controls the maximum GVW that can be permitted on the bridge. Results are presented for different levels of sectional losses (10% to 40%, in 10% increments). In the event that replacement of the open grid deck will take place in the future, results are presented for different deck weights (10 psf to 50 psf in 10 psf increments). The current open grid deck weight is 20 psf.			
17. Key Words Suspension Bridge, Structural Evaluation, Bending Capacity, Shear Capacity, Truck, Bus, Weight Limit		18. Distribution Statement Unlimited with approval of Kentucky Transportation Cabinet	
19. Security Classif. (of this report) Unclassified	20. Security Classif. (of this page) Unclassified	21. No. of Pages 35	22. Price

EXECUTIVE SUMMARY



The primary objective of the structural evaluation of the John A. Roebling Bridge is to determine the maximum allowable gross vehicle (truck or bus) weight (GVW) that can be carried by the bridge deck structural elements: steel grid decking, channels, standard sections, and/or built-up members. The John A Roebling Bridge carries KY 17 over the Ohio River between Covington, KY, and Cincinnati, OH. A detailed evaluation of the load carrying capacity of the cables and truss elements was completed in 2003 (Report No. KTC-03-10/MS097-1F).

An “Element Level Analysis” is carried out to determine the maximum allowable GVW for different truck and bus types. The bridge deck structural elements are analyzed independent of each other. Each element is assigned a specific tributary area, and the element support conditions are idealized as appropriate (i.e., simple, fixed, etc.).

Four truck types and three bus types are considered in the analysis. In 2007, the posted weight limits on the bridge were 17 tons for two-axle trucks and 22 tons for three-, four-, and five-axle trucks.

The built-up 36 inch deep member turned out to be the critical member. The maximum allowable GVWs for trucks and buses are presented in Table E.1.

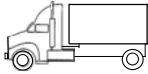
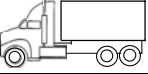
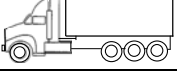
Table E.1. Allowable Gross Vehicle Weight (GVW) in Tons for Different Percentages of Sectional Loss in the Built-Up Member

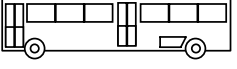
Vehicle Type	Allowable GVW (in tons) for different percentages of sectional loss*				
	0% Sectional Loss	10% Sectional Loss	20% Sectional Loss	30% Sectional Loss	40% Sectional Loss
2-axle truck – Type 1 	20.17 tons	15.61 tons	11.04 tons	7.68 tons	4.80 tons
3-axle truck – Type 2 	21.52 tons	16.65 tons	11.78 tons	8.19 tons	5.12 tons
4-axle truck – Type 3 	24.09 tons	18.64 tons	13.19 tons	9.17 tons	5.73 tons
5-axle truck – Type 4 	36.68 tons	28.38 tons	20.08 tons	13.97 tons	8.72 tons
2-axle bus - Types 1, 2, & 3 	26.50 tons	20.50 tons	14.51 tons	10.09 tons	6.30 tons

* In case a % sectional loss falls between two values (e.g. 14% sectional loss), a linear interpolation between the % sectional loss that is lower and the one that is higher than the one in question (e.g. 10% and 20% sectional loss) should yield adequate results.

In the event that replacement of the open grid deck will take place in the future, results are presented for different deck weights (10 psf to 50 psf, in 10 psf increments) in Chapter 5. The current open grid deck weight is 20 psf.

ACKNOWLEDGEMENTS

The financial support provided by the Kentucky Transportation Cabinet (KyTC) is greatly appreciated. The authors would also like to thank the assistance of Mr. Robert Hans (KyTC-D06), Mr. Tom Schomaker (KyTC-D06), and Mr. David Steele (KyTC-Division of Maintenance). In addition, the authors would like to express their gratitude to Mr. Andrew C. Aiello, Assistant Director - Communications & Development of the Transit Authority of Northern Kentucky (TANK), for providing information regarding the bus types.

TABLE OF CONTENTS

	EXECUTIVE SUMMARY	i
	ACKNOWLEDGEMENTS	iii
	TABLE OF CONTENTS	iv
	LIST OF TABLES	vi
	LIST OF FIGURES	vii
1	INTRODUCTION	1
	1.1 The John A. Roebling Bridge	1
	1.2 Research Objective and Scope	2
2	CAPACITY EVALUATION OF EXISTING STRUCTURAL ELEMENTS	3
	2.1 Steel Decking	3
	2.2 Steel Channels (C)	5
	2.3 Steel Standard (S)	6
	2.4 Steel Built-up Members	6
3	BRIDGE LOADING	8
	3.1 Self-weight Loads	8
	3.2 Live Loads	8
	3.1.1 Truck Types	8
	3.1.2 Bus Types	8
	3.3 Assumptions	8
4	ELEMENT SECTIONAL LOSSES AND STRENGTH CAPACITY LOSSES	11
5	ELEMENT LEVEL ANALYSIS	13
	5.1 Structural Idealization	13
	5.1.1 Steel Decking	13
	5.1.2 Steel Channel Section	13
	5.1.3 Steel Standard Section	13
	5.1.4 Built-up Section	15
	5.2 Maximum Allowable Gross Vehicle Weight (GVW)	15
	5.2.1 Maximum Allowable GVW on the Steel Decking	15
	5.2.2 Maximum Allowable GVW on the Steel Channel Sections	15
	5.2.3 Maximum Allowable GVW on the Steel Standard Sections	16
	5.2.4 Maximum Allowable GVW on the Steel Built-up Sections	16
	5.3 Critical Member for determining the GVW	16
	5.4 Sample Calculations for the Gross Vehicle Weight GVW Limit	16
	5.4.1 Tributary Width, Length, and Area	16
	5.4.2 Dead Loads	16
	5.4.3 Live Loads	17
	5.4.3.1 Live Load Distribution for the Front Axle	17

5.4.3.2	Live Load Distribution for the Rear Axle and Tandem Axle	17
5.4.4	Bending Moments	18
5.4.5	Allowable GVW Calculation	19
5.5	Allowable Gross Vehicle Weight (GVW) for Trucks and Buses	20
5.6	Allowable Gross Vehicle Weight (GVW) for Different Deck Weights	21
6	SUMMARY AND CONCLUSIONS	26
	REFERENCES	28

LIST OF TABLES

Table 2.1.1	Load table for IDSI steel decks (2004)	5
Table 2.2.1	Flexural and shear capacity of the C10x20 channel section	6
Table 2.3.1	Flexural and shear capacity of the S15x50 standard section	6
Table 2.4.1	Flexural and shear capacity of 36-in built-up member	7
Table 3.1	Trucks traversing the Roebling Bridge	9
Table 3.2	Buses traversing the Roebling Bridge	10
Table 4.1	Effect of 10%, 20%, 30%, and 40% sectional loss on the sectional properties and capacities of the 36" built-up member	12
Table 5.4.1	Fraction of gross vehicle weight, ξ , attributed to the rear axle(s)	18
Table 5.5.1	Element Level Analysis - Allowable Gross Vehicle Weight (GVW) in tons for different percentages of sectional loss in the Built-Up Member	20
Table 5.6.1	Element Level Analysis - Allowable gross vehicle weight (GVW) in tons for different percentages in sectional loss in the built-up member when the deck weight equals 10 psf	21
Table 5.6.2	Element Level Analysis - Allowable gross vehicle weight (GVW) in tons for different percentages in sectional loss in the built-up member when the deck weight equals 20 psf	22
Table 5.6.3	Element Level Analysis - Allowable gross vehicle weight (GVW) in tons for different percentages in sectional loss in the built-up member when the deck weight equals 30 psf	23
Table 5.6.4	Element Level Analysis - Allowable gross vehicle weight (GVW) in tons for different percentages in sectional loss in the built-up member when the deck weight equals 40 psf	24
Table 5.6.5	Element Level Analysis - Allowable gross vehicle weight (GVW) in tons for different percentages in sectional loss in the built-up member when the deck weight equals 50 psf	24
Table 6.1	Allowable gross vehicle weight (GVW) in tons for different percentages in sectional loss in the built-up member	26

LIST OF FIGURES

Figure 1.1	The John A. Roebling Bridge carries KY 17 over the Ohio River between Covington, KY, and Cincinnati, OH	1
Figure 1.2	Structural elements of the John A. Roebling Bridge	2
Figure 2.1	Structural elements of the bridge deck	3
Figure 2.1.1	Steel grid decking manufactured by Interlocking Deck Systems International (IDSI), Inc (2004)	4
Figure 2.1.2	Sectional properties of the IDSI's deck with 6-in main rail spacing (2004)	4
Figure 2.2.1	Properties of C 10x20 channel section	5
Figure 2.3.1	Properties of S 15x50 standard section	6
Figure 2.4.1	36-inch built-up member	7
Figure 5.1.1	Idealization of steel decking for the Element Level Analysis	13
Figure 5.1.2	Idealization of steel channel (C) for the Element Level Analysis	14
Figure 5.1.3	Idealization of steel standard (S) for the Element Level Analysis	14
Figure 5.1.4	Idealization of 36-in deep built-up member	15
Figure 5.4.1	Loadings on 36-in built-up section	17
Figure 5.4.2	Moment due to dead loads	18
Figure 5.4.3	Moment due to truck or bus loads	18

1 INTRODUCTION

1.1 THE JOHN A. ROEBLING BRIDGE

Completed in 1867, the John A. Roebling Bridge (Fig. 1.1) – formerly the Covington-Cincinnati Suspension Bridge – was the first permanent bridge to span the Ohio River between Kentucky and Ohio. In 1975, the bridge was designated as a National Historic Civil Engineering Landmark by the American Society of Civil Engineers and was listed on the National Register of Historic Places.

The John A. Roebling Bridge carries KY 17 over the Ohio River between the two aforementioned cities. The bridge is a three-span bridge. The main span of the bridge is approximately 1,100-ft long, carrying a two-lane 28-ft wide roadway. The two approach spans are approximately 300-ft long; the entire superstructure is thus approximately 1700-ft long. In addition, the bridge also carries an 8-ft 6-inch wide sidewalk cantilevered from both sides of the superstructure. The roadway is supported by a steel grid decking system, structural channel (**C**) sections, structural standard (**S**) sections, and built-up I-shaped plate girders. The roadway structural system is in turn supported by planar trusses, secondary suspenders, and primary cables. In 2007, the bridge's weight restrictions are posted as 17 tons for two-axle trucks and 22 tons for three-, four-, and five-axle trucks. Numerous structural truss and floor system repairs had been made in the past, with the latest one in the early 1990s.



Fig. 1.1 – The John A. Roebling Bridge carries KY 17 over the Ohio River between Covington, KY, and Cincinnati, OH.

1.2 RESEARCH OBJECTIVE AND SCOPE

The objective of this study is to conduct a structural evaluation of the John A. Roebling Bridge in order to determine the maximum allowable gross vehicle weight (GVW) that can be carried by the bridge deck structural elements shown in Fig. 1.2 (i.e., open steel grid decking, channel sections, standard sections, and built-up sections).

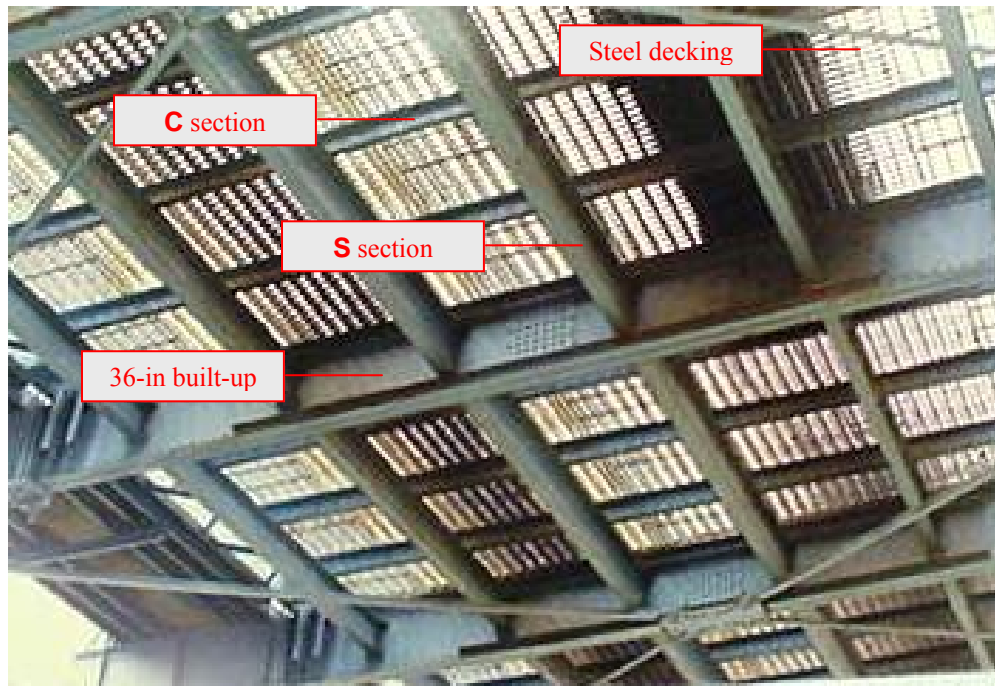
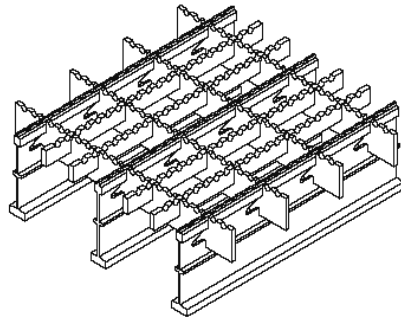

Fig. 1.2 – Structural elements of the John A. Roebling Bridge

2 CAPACITY EVALUATION OF THE BRIDGE DECK ELEMENTS

The bridge deck consists of the following four (4) structural components: open steel grid decking system (Fig. 2.1.a), structural channel (C) section (Fig. 2.1.b), structural standard (S) section (Fig. 2.1.c), and built-up I-shaped plate girder (Fig. 2.1.d).



(a) 5-inch steel deck

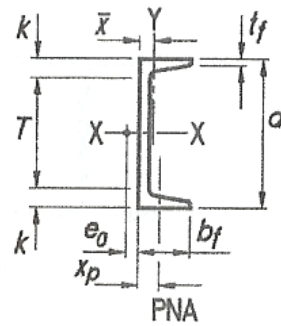

(b) Channel (C) section

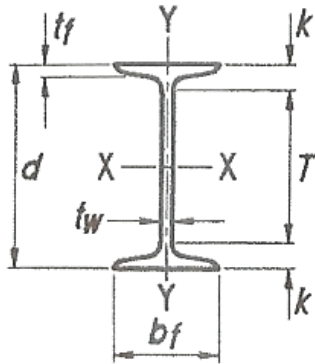

(c) Standard (S) section

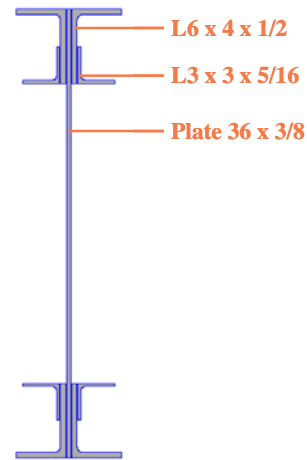

(d) 36-inch built-up section

Fig. 2.1 – Structural elements of the bridge deck.

2.1 STEEL DECKING

The capacity of the existing open steel decking was determined by comparing the existing deck to a similar type of commercially available steel decking. The dimensions of the existing steel decking were measured to be 5-1/4" in height with main rails spaced 6-in center-to-center.

One commercially available open steel grid decking manufactured by the Interlocking Deck Systems International (IDSI), Inc. (2004), was found to be comparable to the existing steel decking. The main rail of the IDSI's steel decking has a height of 5-3/16", as shown in Fig. 2.1.1.a. A complete steel grid decking system (Fig. 2.1.1.b) may consist cross bars in the two perpendicular directions, main rails in the traffic direction, and reinforcing bars (not shown) in the transverse direction. Section properties of the IDSI's steel decking with main rails spaced at 6-in center-to-center are presented in Fig. 2.1.2.

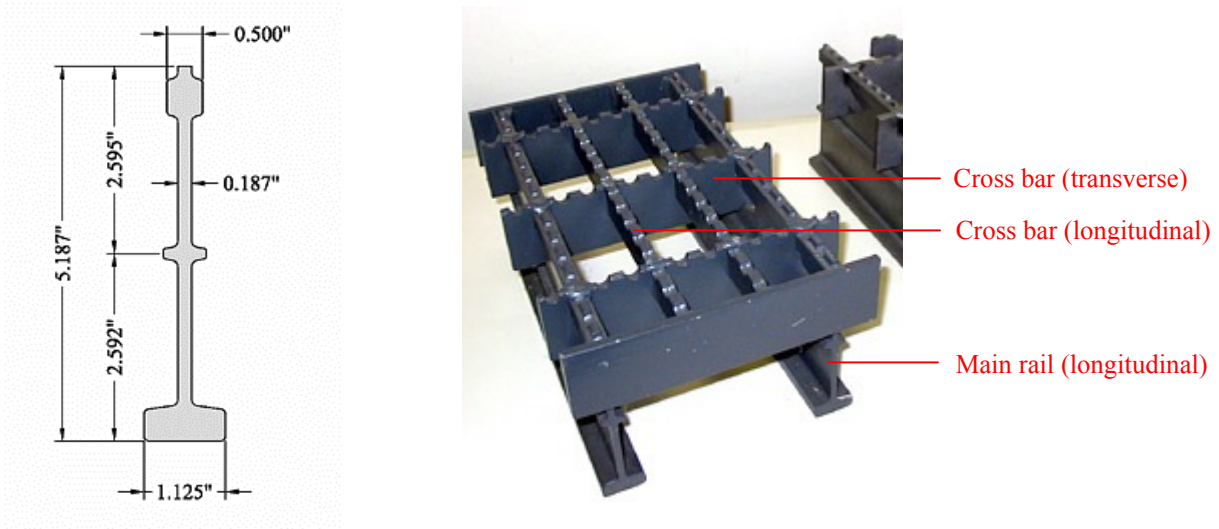

(a) Main rail of the IDSI deck

(b) Components of the IDSI deck

Fig. 2.1.1 – Steel grid decking manufactured by Interlocking Deck Systems International (IDSI), Inc (2004).

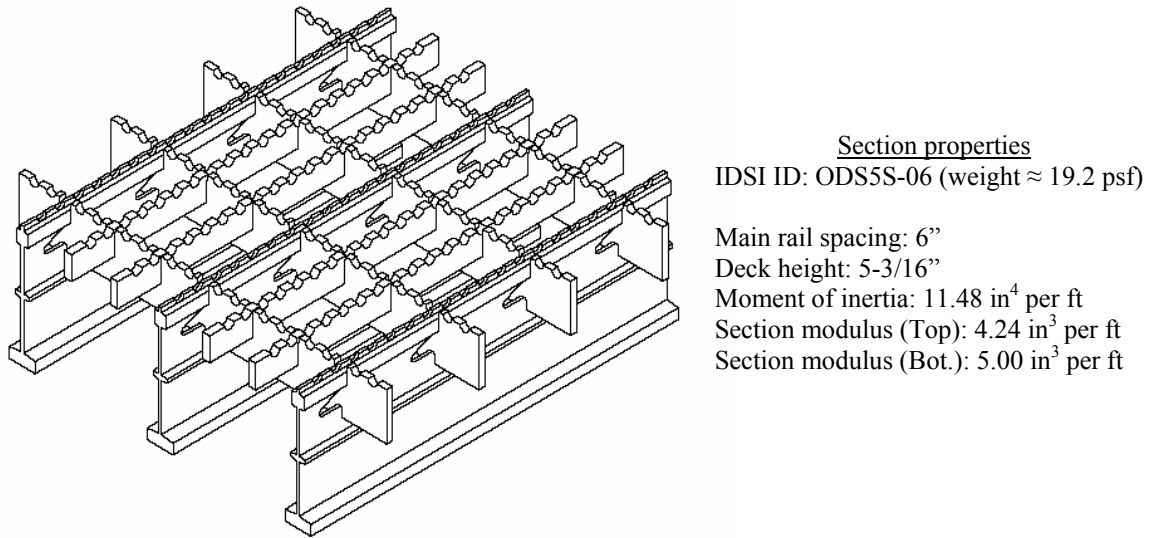

Fig. 2.1.2 – Section properties of the IDSI's deck with 6-in main rail spacing (2004).

The IDSI's decks are designed in accordance with AASHTO Allowable Stress Design (2002). The load capacities of steel decks with 6-in main rail spacing are tabulated in Table 2.1.1 (IDSI 2004). As illustrated, two different steel grades of yield strengths 36 ksi and 50 ksi, respectively, are considered for design trucks of HS 20 (MS 18) and HS25 (MS 22) – 25% weight or load increase of the HS 20 truck type.

Table 2.1.1. Load table for IDSI steel decks (2004)

IDSI ID	HS 20 (MS 18) Max. Cont. Clear Span			HS 25 (MS 22) Max. Cont. Clear Span		
	Transverse/Parallel to Traffic		Deflection $L/800$	Transverse/Parallel to Traffic		Deflection $L/800$
	36 ksi	50 ksi		36 ksi	50 ksi	
ODS5S-06	5.34 ft	7.19 ft	5.61 ft	5.01 ft	6.74 ft	5.43 ft

- Apply only for ODS5S-06 where main rails are 6-in center-to-center
- Modulus of elasticity of steel decks = 29×10^6 psi
- Clear span = L
- Deflection limits shown are independent of the main rail orientation for AASHTO ASD method
- Steel strength limits = 27 ksi for 50 ksi yield steel or 20 ksi for 36 ksi yield steel
- Fatigue was not considered

2.2 STEEL CHANNELS (C)

The steel channel (C) used in the John A. Roebling Bridge is a C10x20, as shown in Fig. 2.2.1.

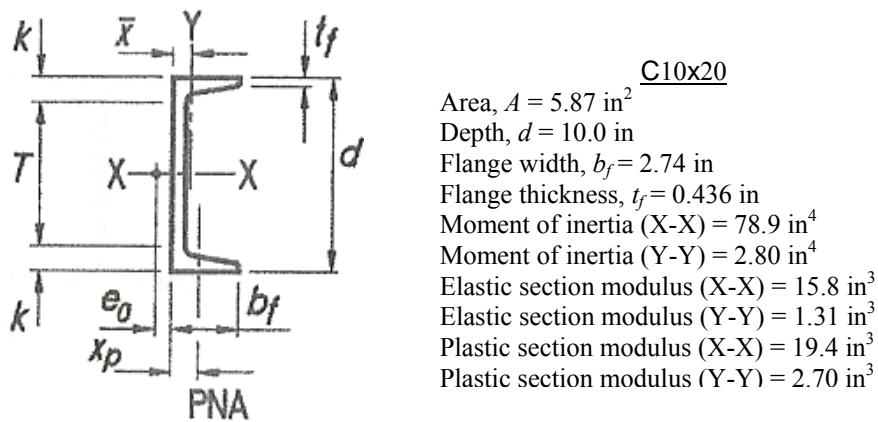

Fig. 2.2.1 – Properties of C10x20 channel section.

The allowable flexural and shear capacities presented in Table 2.2.1 for the C10x20 were determined per the 2005AISC Allowable Stress Design (ASD).

Table 2.2.1. Flexural and shear capacity of the C10x20 channel section

Member	Steel Grade	Allowable M_a	Allowable V_a
C10x20	A36 (36 ksi)	31.3 k-ft	49.0 k

2.3 STEEL STANDARDS (S)

There are two types of steel standards (S) used in the John A. Roebling Bridge: S15x50 and S20x66. Only the capacities of the S15x50 (Fig. 2.3.1) were evaluated as it is the smaller and the more critical structural member in this case.

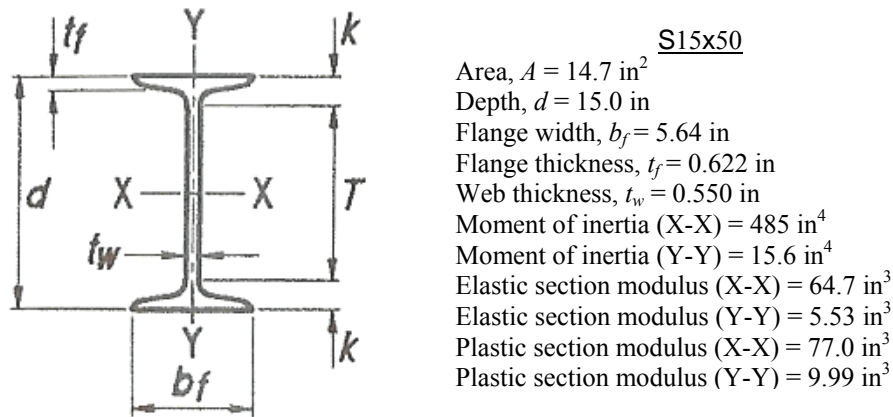

Fig. 2.3.1 – Properties of S15x50 standard section.

The allowable flexural and shear capacities presented in Table 2.3.1 for the standard section S15x50 were determined per the 2005AISC Allowable Stress Design (ASD).

Table 2.3.1. Flexural and shear capacity of the S15x50 standard section

Member	Steel Grade	Allowable M_a	Allowable V_a
S15x50	A7 (33 ksi)	95.0 k-ft	109.0 k

2.4 STEEL BUILT-UP MEMBER

The built-up members supporting the open grid steel decking, channels, and standards, have a 36-in height and are composed of four angles L6x4x1/2 (two at top and two at bottom), four angles L3x3x5/16 (two at top and two at bottom), and a steel plate 36x3/8 (Fig. 2.4.1). Intermediate web stiffeners are not shown in Fig. 2.4.1.

The allowable flexural and shear capacities presented in Table 2.4.1 for the built-up members were determined per the 2005 AISC Allowable Stress Design (ASD).

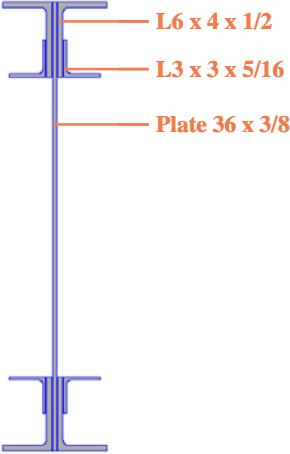

Fig. 2.4.1 – 36-inch built-up section.

Table 2.4.1. Flexural and shear capacity of 36-inch built-up section.

Member	Steel Grade	Allowable M_a	Allowable V_a
36-inch built-up	A36 (36 ksi)	549.7 k-ft	175.0 k

3 BRIDGE LOADING

Two types of gravity loads are considered in the analysis: self-weight loads of the structural and non-structural elements, and live loads.

3.1 SELF-WEIGHT LOADS

Attributable self-weight loads include loads of the bridge deck structural elements (i.e., steel decking, channel sections, standard sections, and built-up sections) and non-structural elements (i.e., electrical and mechanical conduits, traffic signs, posts, etc.).

3.2 LIVE LOADS

By definition, live loads are transient loads. In this study, live loads are contributed by the different truck and bus types.

3.2.1 Truck Types

The four truck types traversing the bridge are presented in Table 3.1.

3.2.2 Bus Types

The four bus types traversing the bridge are presented in Table 3.2.

3.3 ASSUMPTIONS

The following assumptions are introduced in the analysis:

- A 30% impact load is considered in the analysis. This is in accordance with the 2002 AASHTO Standard Specification Section 3.8.2.
- Two vehicles (i.e., trucks and/or buses) can travel parallel to each other on the bridge at the same time to produce the maximum load effect. This condition applies to certain structural elements (i.e., channel sections and the 36-in built-up member).

Table 3.1. Trucks Traversing the Roebling Bridge

Truck Type	Truck Information	
	Axle Spacing s	Wheel Spacing s_w
 <p>Diagram of Type 1 truck showing axle spacing s and wheel spacing s_w. Axle weights are $0.2W$ and $0.8W$.</p>	$s = 14'-0''$	$6'-0''$
 <p>Diagram of Type 2 truck showing axle spacings s_1 and s_2, and wheel spacing s_w. Axle weights are $0.14W$, $0.43W$, and $0.43W$.</p>	$s_1 = 12'-0''$ $s_2 = 4'-0''$	$6'-0''$
 <p>Diagram of Type 3 truck showing axle spacings s_1 and s_2, and wheel spacing s_w. Axle weights are $0.19W$, $0.27W$, $0.27W$, and $0.27W$.</p>	$s_1 = 12'-0''$ $s_2 = 4'-0''$	$6'-0''$
 <p>Diagram of Type 4 truck showing axle spacings s_1, s_2, and s_3, and wheel spacing s_w. Axle weights are $0.12W$, $0.22W$, $0.22W$, $0.22W$, and $0.22W$.</p>	$s_1 = 12'-0''$ $s_2 = 4'-0''$ $s_3 = 14'-0''$	$6'-0''$

Table 3.2. Buses Traversing the Roebling Bridge

Bus Type	Bus Information		
	Gross Vehicle Weight* W	Axle Spacing** s	Wheel Spacing** S_w
<p>Type 1</p> 	30,000 lbs (15.00 Tons)	13' 6"	8' 1" (+/- 1")
<p>Type 2</p> 	39,500 lbs (19.75 Tons)	18' 4"	8' 3" (+/- 1")
<p>Type 3</p> 	39,500 lbs (19.75 Tons)	23' 8"	8' 3" (+/- 1")

* The Gross vehicle weight is the weight for the fully loaded bus. The information was provided by the Transit Authority of Northern Kentucky (TANK).

** Information provided by the Transit Authority of Northern Kentucky (TANK).

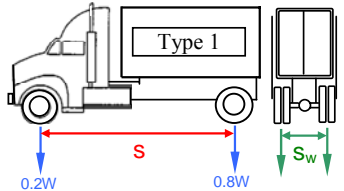
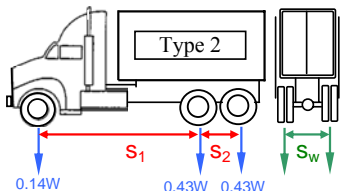
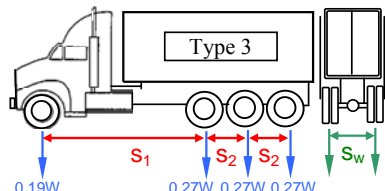
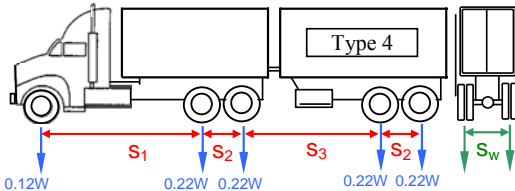
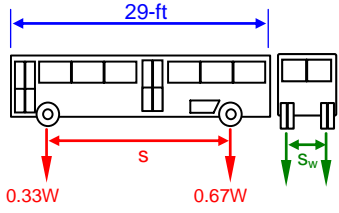
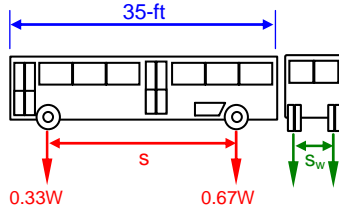
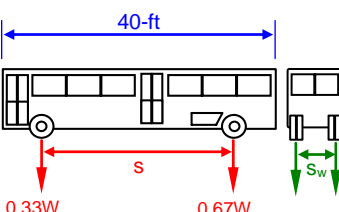
4 ELEMENT SECTIONAL LOSSES AND STRENGTH CAPACITY LOSSES

Recent field inspections revealed that some structural elements in the deck have experienced sectional loss up to 20%. The loss can be attributed to rust, visible cracks, etc. An accurate estimate of the section loss requires element removal from the bridge, cleaning, detailed measurements, etc. Consequently, an estimate based on visual inspection and field measurements is more practical. However, only visible losses can be measured, and these generally underestimate the actual section losses (e.g., cracks that are not visible to the naked eye, etc.).

The sectional losses reduce the sectional geometric properties of the element (area A , moment of inertia I , section modulus S , etc.) and, in turn, reduce the strength capacity of the section in bending, shear, etc.

In order to quantify the relation between the percentage of section loss and the percentage of capacity loss, results are presented in tables in Chapter 5 for 10% to 40% loss in section, in 10% increments. The percentage loss is applied uniformly to the flanges and webs of the steel sections (e.g., **C** and **S** sections) and to the walls of the steel sections that make up the built-up member. For example, a 10% section loss is applied by reducing the thickness of the flanges and webs by 10%.

Table 4.1 shows that, a 10% section loss leads to a 19% loss in allowable bending moment capacity and 10% loss in allowable shear capacity of the built-up section. A 20% section loss leads to 38% loss in allowable bending moment capacity and 20% loss in allowable shear capacity of the built-up section.

Table 4.1. Effect of 10%, 20%, 30%, and 40% sectional loss on the sectional properties and capacities of the 36” built-up member.

Section Properties and allowable Shear and Bending Capacities	Value of the section properties and capacities for different % in sectional loss								
	0% sectional loss	10% sectional loss		20% sectional loss		30% sectional loss		40% sectional loss	
		Value	% reduction = η	Value	% reduction = η	Value	% reduction = η	Value	% reduction = η
Area, A (in ²)	39.62	32.90	17%	26.79	32%	22.18	44%	17.41	56%
Moment of inertia, I_x (in ⁴)	7,580	5,923	22%	4,750	37%	3,686	51%	2,702	64%
Elastic section modulus, S_x (in ³)	421	340	19%	260	38%	204	52%	150	64%
Plastic section modulus, Z_x (in ³)	523	422	19%	322	38%	251	52%	188	64%
Shear capacity, V_a (k)	175	157	10%	139	20%	121	31%	104	41%
Bending moment capacity, M_a (k-ft)	549.7	445	19%	341	38%	264	52%	198	64%

Notes for Table 4.1:

- 1- The sectional loss in the bridge elements may occur as a result of a crack propagating in the web or the flange(s). In this case, the section properties and capacities listed in column 1 in table 4.1 can be derived based on the uncracked section in order to determine % reduction.
- 2- In case a % sectional loss falls between two values in Table 4.1 (e.g. 14% sectional loss), a linear interpolation between the % sectional loss that is lower and the one that is higher than the one in question (e.g. 10% and 20% sectional loss) should yield adequate results.

5 ELEMENT LEVEL ANALYSIS

5.1 STRUCTURAL IDEALIZATION

5.1.1 STEEL DECKING

The following assumptions are applied to the open steel grid decking for this level of analysis:

- The deck is to be continuously supported over several spans; and
- The channels (**C**), supporting the deck, are idealized as simple supports (Fig. 5.1.1).

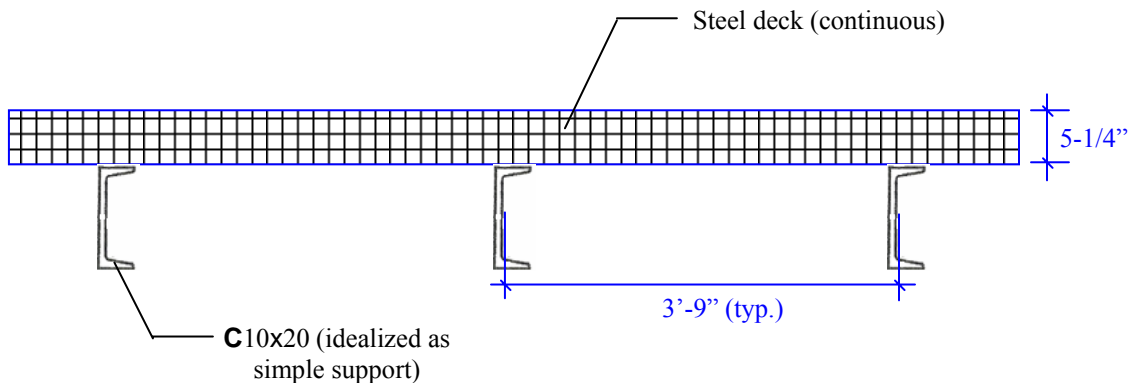

Fig. 5.1.1 – Idealization of steel decking for the Element Level Analysis.

5.1.2 STEEL CHANNEL SECTION

The following assumptions are applied to the steel channel for this level of analysis:

- Each channel (**C**) is continuously supported over several spans (i.e., constant spacing of 5'-3") with the supporting standard (**S**) sections idealized as simple supports (Fig. 5.1.2); and
- The tributary area is bounded by the center to center spacing of the **C**-sections and **S**-section (3'-9" and 5'-3", respectively).

5.1.3 STEEL STANDARD SECTION

The following assumptions are applied to the steel channel for this level of analysis:

- Each standard (**S**) section is idealized as a single-span beam with the supporting 36-in deep built-up members idealized as simple or fixed support depending on the type of connection to the built-up member. The simple connection is the critical one. (Fig. 5.1.3); and
- The tributary area is bounded by the center to center spacing of the **S**-sections and the built-up member (5'-3" and 15'-0", respectively).

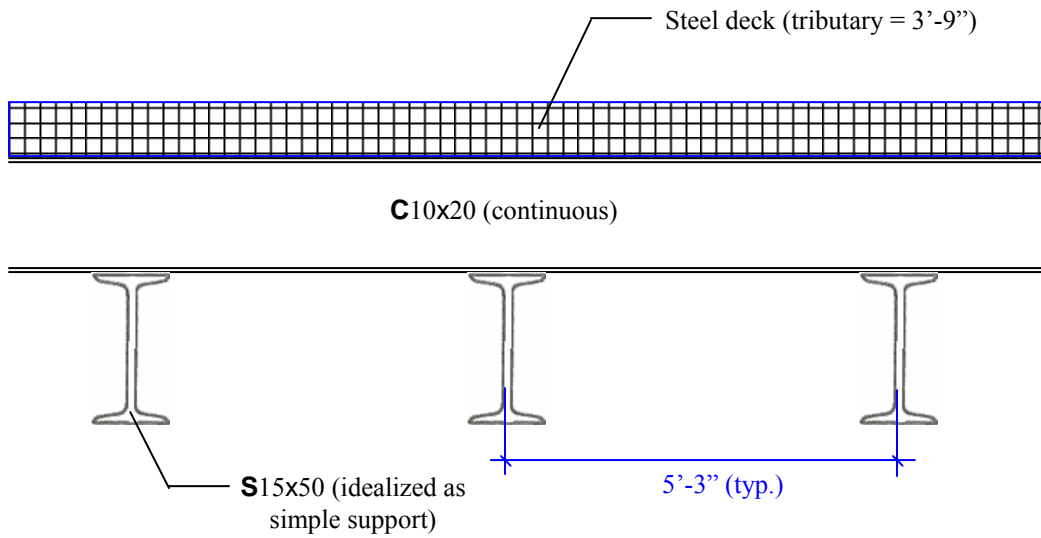

Fig. 5.1.2 – Idealization of steel channel (C) section for the Element Level Analysis.

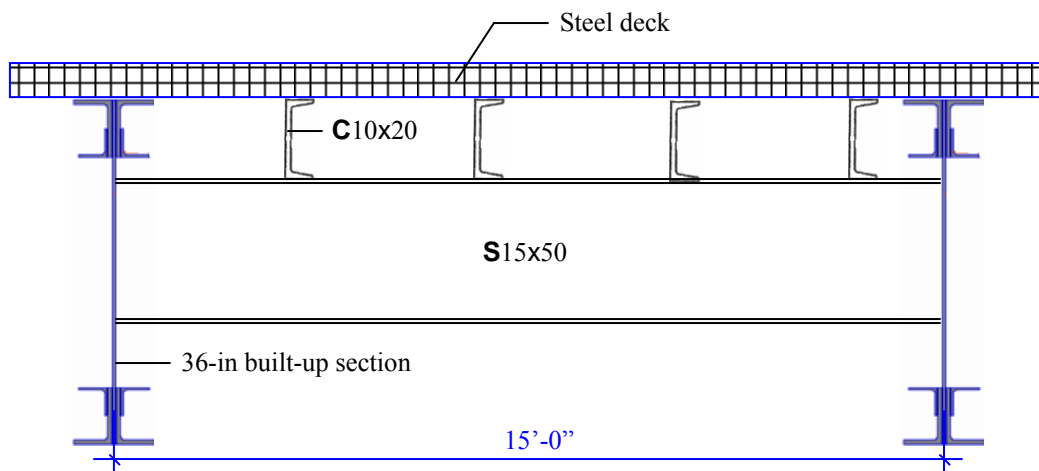

Fig. 5.1.3 – Idealization of steel standard (S) section for the Element Level Analysis.

5.1.4 BUILT-UP SECTION

The 36-in deep built-up section is represented by a beam with supporting cables idealized as simple supports (Fig. 5.1.4). The tributary area of the vehicle traffic portion of the deck is bounded by the width of the bridge deck supported by the suspender cable and the center to center spacing of the built-up member (32'-0" and 15'-0", respectively). The tributary area of each overhang segment (or pedestrian portion) is bounded by the length of the overhang and the center to center spacing of built-up member (8'-6" and 15'-0", respectively).

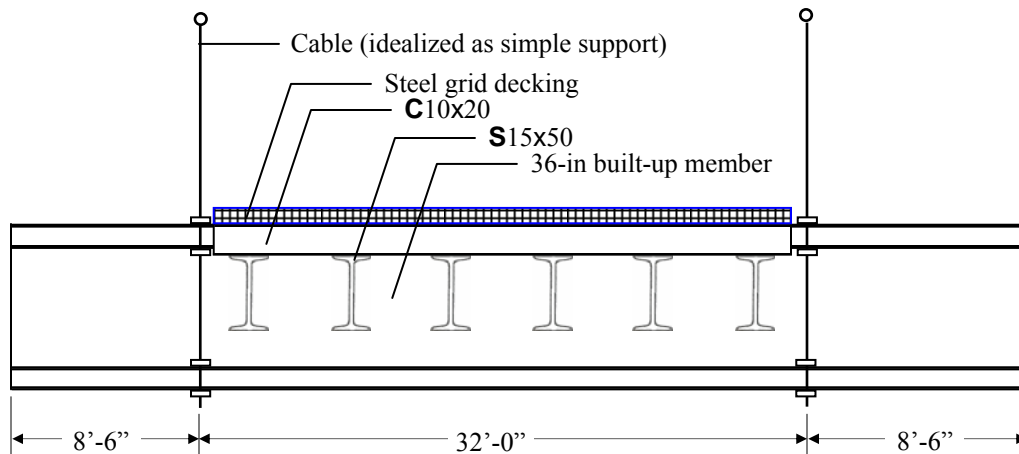

Fig. 5.1.4 – Idealization of 36-in deep built-up member.

5.2 MAXIMUM ALLOWABLE GROSS VEHICLE WEIGHT (GVW)

5.2.1 Maximum Allowable GVW on the Steel Decking

The commercially available open steel grid decking manufactured by the Interlocking Deck Systems International (IDSI), Inc. (2004), is comparable to the existing steel decking and is used in this case to determine the load capacity. The steel decking can carry a HS25 and HS20 truck at spacing of 5.01 ft and 5.34 ft, respectively. The existing steel decking is supported by Channel sections at spacing of 3.75 ft. It is therefore concluded that the steel decking will be able, at 0% loss in bending capacity, to carry any vehicle types shown in Tables 3.1 and 3.2, and will not control the determination of the allowable gross vehicle weight.

5.2.2 Maximum Allowable GVW on the Steel Channel Sections

C10x20 sections are used to support the open grid steel decking. The A36 channel section has an allowable bending capacity of 31.3 k-ft and an allowable shearing capacity of 49 kips. Shear capacity, deflection limit, and connection capacity do not control and will not be

included in the sample calculations. The maximum allowable GVWs at 0% loss in bending capacity (or $\eta = 0$) are: 34.38 tons, 31.98 tons, 33.96 tons, 43.26 tons, and 36.40 tons, for the 2-, 3-, 4-, and 5-axle trucks, and the 2-axle buses, respectively. Shear and deflection do not control.

5.2.3 Maximum Allowable GVW on the Steel Standard Sections

S15x50 and S20x66 sections are used to support the steel channels. The A36 S15x50 standard section is the critical section. It has an allowable bending capacity of 95 k-ft and an allowable shearing capacity of 109 kips. Shear capacity, deflection limit, and connection capacity do not control and will not be included in the sample calculations. The maximum allowable GVWs at 0% loss in bending capacity (or $\eta = 0$) are: 42.50 tons, 39.53 tons, 41.98 tons, 53.49 tons, and 45.00 tons, for the 2-, 3-, 4-, and 5-axle trucks, and the 2-axle buses, respectively.

5.2.4 Maximum Allowable GVW on the Steel Built-up Sections

Each A36 built-up member has an allowable bending capacity of 549.7 k-ft and an allowable shear capacity of 175 kips. Shear capacity, deflection limit, and connection capacity do not control and will not be included in the sample calculations. The maximum allowable GVWs at 0% loss in bending capacity (or $\eta = 0$) are: 20.17 tons, 21.52 tons, 24.09 tons, 36.68 tons, and 26.50 tons, for 2-, 3-, 4-, and 5-axle trucks, and the 2-axle buses, respectively.

5.3 CRITICAL MEMBER FOR DETERMINING THE GVW

The results from the Element Level Analysis indicate that the built-up member is the critical member for determining the load carrying capacity. In the following section, the results are generated for the built-up member.

5.4 SAMPLE CALCULATIONS FOR THE GROSS VEHICLE WEIGHT (GVW) LIMIT

The following illustrates how the maximum allowable GVW is determined for the critical member (i.e., built-up section):

5.4.1. Tributary Width, Length, and Area

Tributary width of the built-up member excluding the overhang = 15 ft
Tributary length of the built-up member excluding the overhang = 32 ft
Tributary area of the built-up member excluding the overhang = (15×32) ft²

Tributary width of the built-up member overhang = 15 ft
Tributary length of the built-up member overhang = 8.5 ft
Tributary area of the built-up member overhang = (15×8.5) ft²

5.4.2. Dead Loads

Open grid steel deck weight = 20 psf

Weight of other structural and non-structural components excluding overhang = 40 psf

Total dead weight excluding = $w_d = (20 + 40) = 60 \text{ psf} = 0.06 \text{ ksf}$

Dead weight on the overhang = $w_{oh} \simeq 50 \text{ psf} = 0.05 \text{ ksf}$

5.4.3. Live Loads

Live load = Vehicle loading = Two trucks or buses placed side-by-side, separated by a distance of 4 ft (see Figs. 5.4.1).

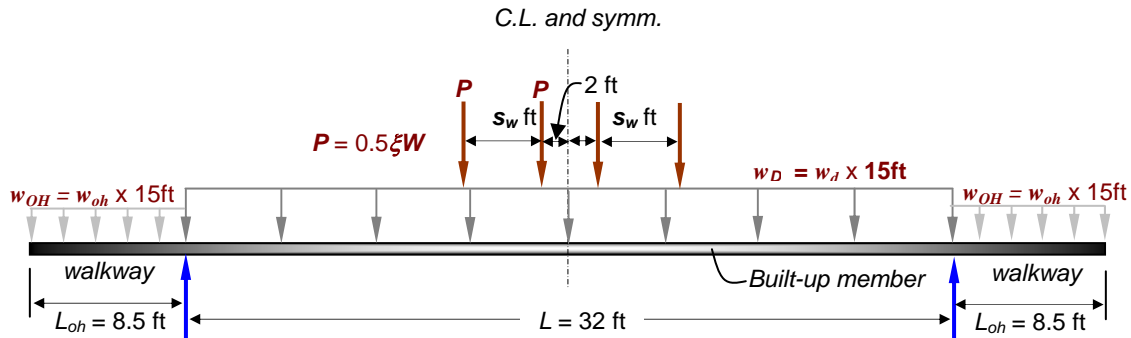

Fig. 5.4.1 – Loadings on 36-in built-up section.

5.4.3.1. Live Load Distribution for the Front Axle

For the front axle, the load P in Fig. 5.4.1 represents the resultant pressure under the tire at one end of the front axle. Consequently, P is equal to 50% of the weight attributed to the front axle, and can be represented by:

$$P = 0.5\xi W$$

where ξ = fraction of gross vehicle weight (GVW) attributed to the axle (Tables 3.1 and 3.2), and W = gross vehicle weight.

5.4.3.2. Live Load Distribution for the Rear Single and Tandem Axles

For the rear single axle, ξ = fraction of gross vehicle weight (GVW) attributed to the single rear axle (Truck Type 1 or Bus Type 1, 2, and 3 in Tables 3.1 and 3.2, respectively).

For the rear tandem axle(s) for Truck Type 2 and 4 in Table 3.1, the centerline of the tandem axles is placed over the built-up member. The percentage of the load distribution to the member is derived by considering a beam (S - section) in the longitudinal direction spanning between three built-up members with the centerline of the dual tandem axles placed on the built-up member in the middle. The built-up members are assumed to provide a simple support for the longitudinal beam.

For the three rear axles for Truck Type 3 in Table 3.1, the centerline of the middle rear axle is placed over the built-up member. The percentage of the load distribution to the member is derived by considering a beam (S - section) in the longitudinal direction spanning between three built-up members with the middle axle placed on the built-up member in the middle. The built-up members are assumed to provide a simple support for the longitudinal beam.

Table 5.4.1 presents the values of the fraction of GVW, ξ , attributed to the rear axle(s) for the trucks and buses in Tables 3.1 and 3.2, respectively.

Table 5.4.1 – Fraction of gross vehicle weight, ξ , attributed to the rear axle(s)

Fraction of gross vehicle weight attributed to the rear axle(s)	Vehicle Type				
	Type – 1	Type – 2	Type – 3	Type – 4	Types 1, 2 & 3
ξ	0.8	0.75	0.67	0.44	0.67

For the rear axle(s), the load P can also be represented by:

$$P = 0.5\xi W$$

where ξ = fraction of gross vehicle weight (GVW) attributed to the rear axle(s) in Table 5.4.1, and W = gross vehicle weight.

5.4.4. Bending Moments

Moment due to dead load, M_D , (Fig. 5.4.2):

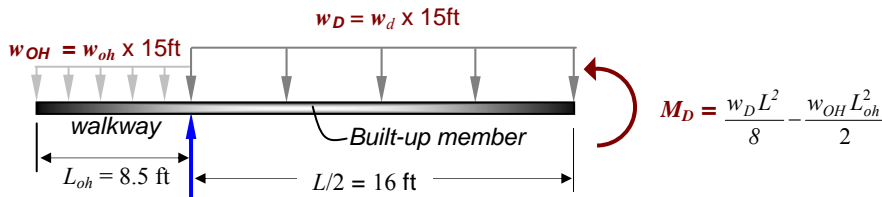

Fig. 5.4.2 – Moment due to dead loads.

Moment due to vehicle live load including a 30% impact load, M_{L+I} , (Fig. 5.4.3):

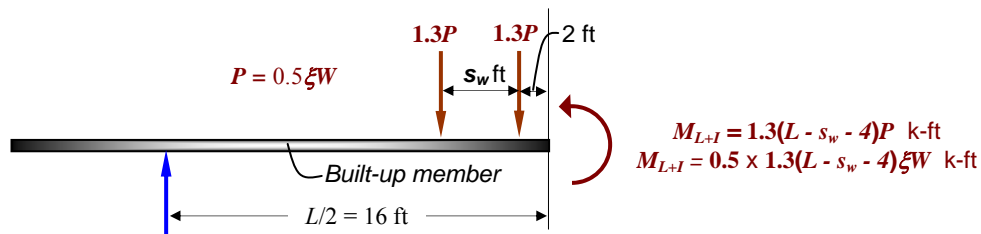

Fig. 5.4.3 – Moment due to truck or bus loads.

5.4.5. Allowable GVW Calculation

Based on the allowable stress design (ASD), $M_a \geq M_D + M_{L+I}$ or $M_{L+I} \leq M_a - M_D$. When considering a loss in the allowable bending capacity (M_a) of magnitude η (where $\eta = 19\%$, 38% , etc., Table 4.1), the moment relationship can be written as follows:

$$M_{L+I} \leq (1 - \eta) M_a - M_D \quad (\text{Eq. 5.1})$$

$$0.5 \times 1.3(L - s_w - 4)\xi W \leq (1 - \eta)M_a - \frac{w_D L^2}{8} + \frac{w_{OH} L_{oh}^2}{2} \quad (\text{Eq. 5.2})$$

$$W = \frac{(1 - \eta)M_a - \frac{w_D L^2}{8} + \frac{w_{OH} L_{oh}^2}{2}}{0.5 \times 1.3(L - s_w - 4)\xi} \quad (\text{Eq. 5.3})$$

Considering that the built-up member has a 20% sectional loss [or loss in bending capacity of 38% (or $\eta = 0.38$) in Table 4.1] and is subjected to the 4-axle truck (Type 3 in Table 3.1), the maximum allowable gross vehicle weight (W) can be determined as follows:

$$M_a = 549.7 \text{ k-ft (Table 4.1 for 0\% sectional loss)}$$

$$\eta = 0.38 \text{ (38\% loss in bending capacity)}$$

$$w_D = 0.9 \text{ k/ft}$$

$$w_{OH} = 0.75 \text{ k/ft}$$

$$L = 32 \text{ ft}$$

$$L_{oh} = 8.5 \text{ ft}$$

$$s_w = 6 \text{ ft (Truck Type 3 in Table 3.1)}$$

$$\xi = 0.67 \text{ (Truck Type 3 in Table 5.4.1)}$$

$$W = \mathbf{26.38 \text{ k} = \mathbf{13.19 \text{ tons}}}$$

5.5 ALLOWABLE GROSS VEHICLE WEIGHT (GVW) FOR TRUCKS AND BUSES

The allowable gross vehicle weights (GVWs) for the 2-, 3-, 4-, and 5-axle trucks, and the Type 1, 2, and 3 two-axle buses, are presented in Table 5.5.1 for different percentages of sectional losses varying from 10% to 40%, in 10% increments.

Table 5.5.1. Element Level Analysis - Allowable Gross Vehicle Weight (GVW) in Tons for Different Percentages of Sectional Loss in the Built-Up Member

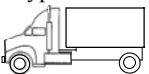
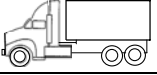
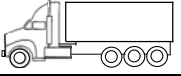
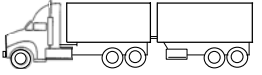
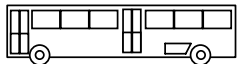
Vehicle Type	Allowable GVW (in tons) for different percentages of sectional loss*				
	0% Sectional Loss	10% Sectional Loss	20% Sectional Loss	30% Sectional Loss	40% Sectional Loss
2-axle truck – Type 1 	20.17 tons	15.61 tons	11.04 tons	7.68 tons	4.80 tons
3-axle truck – Type 2 	21.52 tons	16.65 tons	11.78 tons	8.19 tons	5.12 tons
4-axle truck – Type 3 	24.09 tons	18.64 tons	13.19 tons	9.17 tons	5.73 tons
5-axle truck – Type 4 	36.68 tons	28.38 tons	20.08 tons	13.97 tons	8.72 tons
2-axle bus - Types 1, 2, & 3 	26.50 tons	20.50 tons	14.51 tons	10.09 tons	6.30 tons

* In case a % sectional loss falls between two values (e.g. 14% sectional loss), a linear interpolation between the % sectional loss that is lower and the one that is higher than the one in question (e.g. 10% and 20% sectional loss) should yield adequate results.

5.6 ALLOWABLE GROSS VEHICLE WEIGHT (GVW) FOR DIFFERENT DECK WEIGHTS

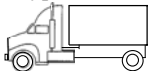
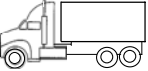
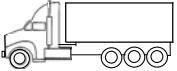
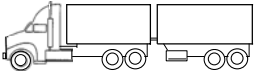
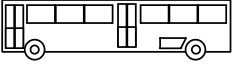

In the event that replacement of the open grid deck will take place in the future, results are presented in Tables 5.6.1 to 5.6.5 for different deck weights (10 psf to 50 psf in 10 psf increments). The current deck weight is 20 psf.

Table 5.6.1. Element Level Analysis - Allowable gross vehicle weight (GVW) in tons for different percentages in sectional loss in the built-up member when the deck weight equals 10 psf.

Deck Weight = 10 psf					
Vehicle Type	Allowable GVW (in tons) for different percentages of sectional loss*				
	0% Sectional Loss	10% Sectional Loss	20% Sectional Loss	30% Sectional Loss	40% Sectional Loss
2-axle truck – Type 1 	21.01 tons	16.45 tons	11.88 tons	8.52 tons	5.64 tons
3-axle truck – Type 2 	22.41 tons	17.55 tons	12.68 tons	9.09 tons	6.01 tons
4-axle truck – Type 3 	25.09 tons	19.64 tons	14.19 tons	10.17 tons	6.73 tons
5-axle truck – Type 4 	38.21 tons	29.91 tons	21.61 tons	15.49 tons	10.25 tons
2-axle bus - Types 1, 2, & 3 	27.60 tons	21.60 tons	15.61 tons	11.19 tons	7.40 tons

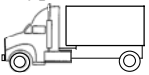
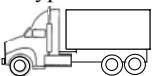
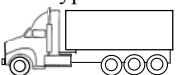

* In case a % sectional loss falls between two values (e.g. 14% sectional loss), a linear interpolation between the % sectional loss that is lower and the one that is higher than the one in question (e.g. 10% and 20% sectional loss) should yield adequate results.

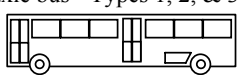
Table 5.6.2. Element Level Analysis - Allowable gross vehicle weight (GVW) in tons for different percentages in sectional loss in the built-up member when the deck weight equals 20 psf.

Deck Weight = 20 psf					
Vehicle Type	Allowable GVW (in tons) for different percentages of sectional loss*				
	0% Sectional Loss	10% Sectional Loss	20% Sectional Loss	30% Sectional Loss	40% Sectional Loss
2-axle truck – Type 1 	20.17 tons	15.61 tons	11.04 tons	7.68 tons	4.80 tons
3-axle truck – Type 2 	21.52 tons	16.65 tons	11.78 tons	8.19 tons	5.12 tons
4-axle truck – Type 3 	24.09 tons	18.64 tons	13.19 tons	9.17 tons	5.73 tons
5-axle truck – Type 4 	36.68 tons	28.38 tons	20.08 tons	13.97 tons	8.72 tons
2-axle bus - Types 1, 2, & 3 	26.50 tons	20.50 tons	14.51 tons	10.09 tons	6.30 tons

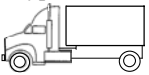
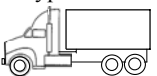
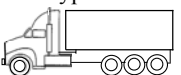

* In case a % sectional loss falls between two values (e.g. 14% sectional loss), a linear interpolation between the % sectional loss that is lower and the one that is higher than the one in question (e.g. 10% and 20% sectional loss) should yield adequate results.

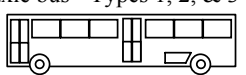
Table 5.6.3. Element Level Analysis - Allowable gross vehicle weight (GVW) in tons for different percentages in sectional loss in the built-up member when the deck weight equals 30 psf.

Deck Weight = 30 psf					
Vehicle Type	Allowable GVW (in tons) for different percentages of sectional loss*				
	0% Sectional Loss	10% Sectional Loss	20% Sectional Loss	30% Sectional Loss	40% Sectional Loss
2-axle truck – Type 1 	19.34 tons	14.77 tons	10.21 tons	6.84 tons	3.96 tons
3-axle truck – Type 2 	20.62 tons	15.76 tons	10.89 tons	7.30 tons	4.22 tons
4-axle truck – Type 3 	23.09 tons	17.64 tons	12.19 tons	8.17 tons	4.73 tons
5-axle truck – Type 4 	35.16 tons	26.86 tons	18.56 tons	12.44 tons	7.20 tons
2-axle bus - Types 1, 2, & 3 	25.40 tons	19.40 tons	13.40 tons	8.99 tons	5.20 tons

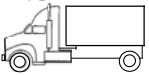
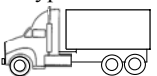
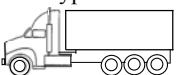

* In case a % sectional loss falls between two values (e.g. 14% sectional loss), a linear interpolation between the % sectional loss that is lower and the one that is higher than the one in question (e.g. 10% and 20% sectional loss) should yield adequate results.

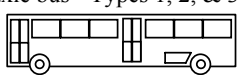
Table 5.6.4. Element Level Analysis - Allowable gross vehicle weight (GVW) in tons for different percentages in sectional loss in the built-up member when the deck weight equals 40 psf.

Deck Weight = 40 psf					
Vehicle Type	Allowable GVW (in tons) for different percentages of sectional loss*				
	0% Sectional Loss	10% Sectional Loss	20% Sectional Loss	30% Sectional Loss	40% Sectional Loss
2-axle truck – Type 1 	18.50 tons	13.93 tons	9.37 tons	6.00 tons	3.12 tons
3-axle truck – Type 2 	19.73 tons	14.86 tons	9.99 tons	6.40 tons	3.33 tons
4-axle truck – Type 3 	22.09 tons	16.63 tons	11.18 tons	7.17 tons	3.73 tons
5-axle truck – Type 4 	33.63 tons	25.33 tons	17.03 tons	10.91 tons	5.67 tons
2-axle bus - Types 1, 2, & 3 	24.29 tons	18.30 tons	12.30 tons	7.88 tons	4.10 tons

* In case a % sectional loss falls between two values (e.g. 14% sectional loss), a linear interpolation between the % sectional loss that is lower and the one that is higher than the one in question (e.g. 10% and 20% sectional loss) should yield adequate results.

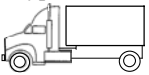
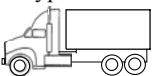
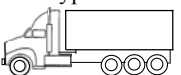
Table 5.6.5. Element Level Analysis - Allowable gross vehicle weight (GVW) in tons for different percentages in sectional loss in the built-up member when the deck weight equals 50 psf.

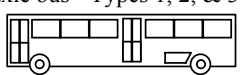
Deck Weight = 50 psf					
Vehicle Type	Allowable GVW (in tons) for different percentages of sectional loss*				
	0% Sectional Loss	10% Sectional Loss	20% Sectional Loss	30% Sectional Loss	40% Sectional Loss
2-axle truck – Type 1 	17.66 tons	13.09 tons	8.53 tons	5.16 tons	2.28 tons
3-axle truck – Type 2 	18.83 tons	13.97 tons	9.10 tons	5.51 tons	2.43 tons
4-axle truck – Type 3 	21.08tons	15.63 tons	10.18 tons	6.17 tons	2.72 tons
5-axle truck – Type 4 	32.10 tons	23.80 tons	15.50 tons	9.39 tons	4.15 tons
2-axle bus - Types 1, 2, & 3 	23.19 tons	17.20 tons	11.20 tons	6.78 tons	3.00 tons

* In case a % sectional loss falls between two values (e.g. 14% sectional loss), a linear interpolation between the % sectional loss that is lower and the one that is higher than the one in question (e.g. 10% and 20% sectional loss) should yield adequate results.

6 SUMMARY AND CONCLUSIONS



The primary objective of the structural evaluation of the John A. Roebling Bridge is to determine the maximum allowable gross vehicle (truck or bus) weight (GVW) that can be carried by the bridge deck structural elements: steel grid decking, channels, standard sections, and/or built-up members. The John A Roebling Bridge carries KY 17 over the Ohio River between Covington, KY, and Cincinnati, OH. A detailed evaluation of the load carrying capacity of the cables and truss elements was completed in 2003 (Report No. KTC-03-10/MS097-1F).

An “Element Level Analysis” is carried out to determine the maximum allowable GVW for different truck and bus types. The bridge deck structural elements are analyzed independent of each other. Each element is assigned a specific tributary area, and the element support conditions are idealized as appropriate (i.e., simple, fixed, etc.).

Four truck types and three bus types are considered in the analysis. In 2007, the posted weight limits on the bridge were 17 tons for two-axle trucks and 22 tons for three-, four-, and five-axle trucks.

The built-up 36 inch deep member turned out to be the critical member. The maximum allowable GVWs for trucks and buses are presented in Table 6.1.

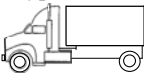
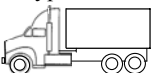
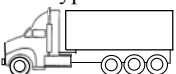
Table 6.1. Allowable Gross Vehicle Weight (GVW) in Tons for Different Percentages of Sectional Loss in the Built-Up Member

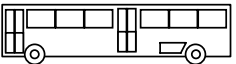
Vehicle Type	Allowable GVW (in tons) for different percentages of sectional loss*				
	0% Sectional Loss	10% Sectional Loss	20% Sectional Loss	30% Sectional Loss	40% Sectional Loss
2-axle truck – Type 1 	20.17 tons	15.61 tons	11.04 tons	7.68 tons	4.80 tons
3-axle truck – Type 2 	21.52 tons	16.65 tons	11.78 tons	8.19 tons	5.12 tons
4-axle truck – Type 3 	24.09 tons	18.64 tons	13.19 tons	9.17 tons	5.73 tons
5-axle truck – Type 4 	36.68 tons	28.38 tons	20.08 tons	13.97 tons	8.72 tons
2-axle bus - Types 1, 2, & 3 	26.50 tons	20.50 tons	14.51 tons	10.09 tons	6.30 tons

* In case a % sectional loss falls between two values (e.g. 14% sectional loss), a linear interpolation between the % sectional loss that is lower and the one that is higher (e.g. 10% and 20% sectional loss) should yield adequate results.

In the event that replacement of the open grid deck will take place in the future, results are presented for different deck weights (10 psf to 50 psf, in 10 psf increments) in Chapter 5. The current open grid deck weight is 20 psf.

REFERENCES

AASHTO, "Standard Specifications for Highway Bridge. 17th Ed. American Association of State Highway and Transportation Officials. Washington, D.C., 2002.

AISC, "Steel Construction Manual," 13th Edition, American Institute of Steel Construction Inc., 2005.

Interlocking Deck Systems International (IDSI), Inc. (2004): <http://www.idsi.org/>

Ren, W.X., Harik, I.E., Blandford, G.E., Lenett, M., and Baseheart, T.M., "Structural Evaluation of The Historic John A. Roebling Suspension Bridge," Research Report (KTC03-10/MS97-1F), Kentucky Transportation Center, University of Kentucky, April 2003.

For more information or a complete publication list, contact us at:

KENTUCKY TRANSPORTATION CENTER

176 Raymond Building
University of Kentucky
Lexington, Kentucky 40506-0281

(859) 257-4513
(859) 257-1815 (FAX)
1-800-432-0719
www.ktc.uky.edu
ktc@engr.uky.edu

The University of Kentucky is an Equal Opportunity Organization