

University of Groningen

## Allozyme variation in populations of 4 racopilum species, including the polyploid r-tomentosum

de Vries, A; Bramer, JPJ; van Zanten, B. O.; Hofman, A; Bijlsma, R

*Published in:*  
Lindbergia

**IMPORTANT NOTE: You are advised to consult the publisher's version (publisher's PDF) if you wish to cite from it. Please check the document version below.**

*Document Version*  
Publisher's PDF, also known as Version of record

*Publication date:*  
1989

[Link to publication in University of Groningen/UMCG research database](#)

*Citation for published version (APA):*

de Vries, A., Bramer, JPJ., van Zanten, B. O., Hofman, A., & Bijlsma, R. (1989). Allozyme variation in populations of 4 racopilum species, including the polyploid r-tomentosum. *Lindbergia*, 15(2), 47-59.

### Copyright

Other than for strictly personal use, it is not permitted to download or to forward/distribute the text or part of it without the consent of the author(s) and/or copyright holder(s), unless the work is under an open content license (like Creative Commons).

### Take-down policy

If you believe that this document breaches copyright please contact us providing details, and we will remove access to the work immediately and investigate your claim.

*Downloaded from the University of Groningen/UMCG research database (Pure): <http://www.rug.nl/research/portal>. For technical reasons the number of authors shown on this cover page is limited to 10 maximum.*

Allozyme Variation in Populations of Four *Racopilum* Species, including the Polyploid *R. tomentosum*

Author(s): A. de Vries, J. P. J. Bramer, B. O. van Zanten, A. Hofman and R. Bijlsma

Source: *Lindbergia*, Vol. 15, No. 2 (1989), pp. 47-59

Published by: Oikos Editorial Office

Stable URL: <http://www.jstor.org/stable/20149698>

Accessed: 04-05-2018 08:23 UTC

---

JSTOR is a not-for-profit service that helps scholars, researchers, and students discover, use, and build upon a wide range of content in a trusted digital archive. We use information technology and tools to increase productivity and facilitate new forms of scholarship. For more information about JSTOR, please contact [support@jstor.org](mailto:support@jstor.org).

Your use of the JSTOR archive indicates your acceptance of the Terms & Conditions of Use, available at <http://about.jstor.org/terms>



JSTOR

*Oikos Editorial Office* is collaborating with JSTOR to digitize, preserve and extend access to *Lindbergia*

## Allozyme variation in populations of four *Racomitrium* species, including the polyploid *R. tomentosum*

A. de Vries, J. P. J. Bramer, B. O. van Zanten, A. Hofman and R. Bijlsma



A. de Vries

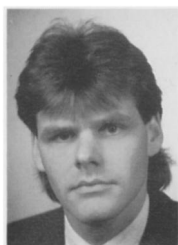

J. P. J. Bramer

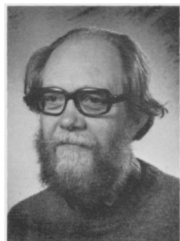

B. O. van Zanten



R. Bijlsma

Vries, A. de, Bramer, J. P. J., Zanten, B. O. van, Hofman, A. and Bijlsma, R. 1989. Allozyme variation in populations of four *Racomitrium* species, including the polyploid *R. tomentosum*. – *Lindbergia* 15: 47–59.

Enzyme electrophoresis was used to estimate genetic variation in *R. strumiferum*, *R. tomentosum*, *R. intermedium* and *R. capense*. Eight enzyme systems, representing 10 loci, were used. Three loci showed double bands in the monoicous *R. tomentosum*, while the other, dioicous, species produced only single bands for these loci. Chromosome counts showed that the double banding pattern in *R. tomentosum* coincided with a double number of chromosomes ( $n = 20$ , versus  $n = 10$  in *R. strumiferum* and *R. capense*). The finding of both heterozygotes and homozygotes for Pgm-2 and Got suggests that autodiploidy is the most likely origin of *R. tomentosum*. The mean gene diversity within populations of the four *Racomitrium* species ranged from 0.06–0.21, which is a moderate to high level of genetic variation compared with phanerogams. Between populations of different species the genetic distances were generally much larger than between populations within each species. In view of its very distinct sporophyte, *R. intermedium* might be ranked as a separate genus. The electrophoretic data, however, do not support this view and show a close genetic relationship with *R. tomentosum* and *R. capense*. The taxonomic consequences of the allozyme data are discussed.

A. de Vries, J. P. J. Bramer, A. Hofman and R. Bijlsma, Dept of Genetics; B. O. van Zanten, Dept of Plant Ecology; Univ. of Groningen, Kerklaan 30, NL-9751 NN Haren (Gr.), The Netherlands.

Ферментный электрофорез был использован для оценки родовой вариации в *R. strumiferum*, *R. tomentosum*, *R. intermedium* и *R. capense*. Использованы были восемь ферментных систем, представляющих 10 локусов. Три локуса обнаружили двойные диски в однодомном *R. tomentosum*, в то время как другой, двудомный, вид производил только одинарные диски для этих локусов. Подсчеты хромосом показали, что паттерн двойного распределения дисков в *R. tomentosum* совпадал с двойным количеством хромосом ( $n = 20$ , против  $n = 10$  в *R. strumiferum* и *R. capense*). Обнаружение и гетерозигот и гомозигот в Pgm-2 и Got предполагает, что автодиплоидия является самым вероятным происхождением *R. tomentosum*. Среднее разнообразие генов внутри популяций четырех видов *Racomitrium* охватывало от 0.06–0.21, что является показателем умеренного до высокого уровня генетической вариации в сравнении с явноточными растениями. Между популяциями разных видов генетические расстояния были вообще гораздо большими, чем между популяциями внутри каждого отдельного вида. Учитывая весьма явный спорофит *R. intermedium* можно классифицировать как отдельный род. Однако данные электрофореза не поддерживают эту точку зрения, и они показывают близкое генетическое родство с *R. tomentosum* и *R. capense*. Обсуждаются таксономические последствия данных аллозима.

### Introduction

Enzyme electrophoresis is a useful tool in both systematics and population genetics. Compared with morphological characters, the enzyme variants of a certain loci (allozymes) are much less influenced by environmental

factors. As allozymes reflect genetic differences between species more directly, they may give a better picture of phylogenetic relationships. Under the assumption that the rate of codon substitutions (mutations) within a group of related species is more or less

Accepted 16 October 1989

© LINDBERGIA

LINDBERGIA 15:2 (1989)

47

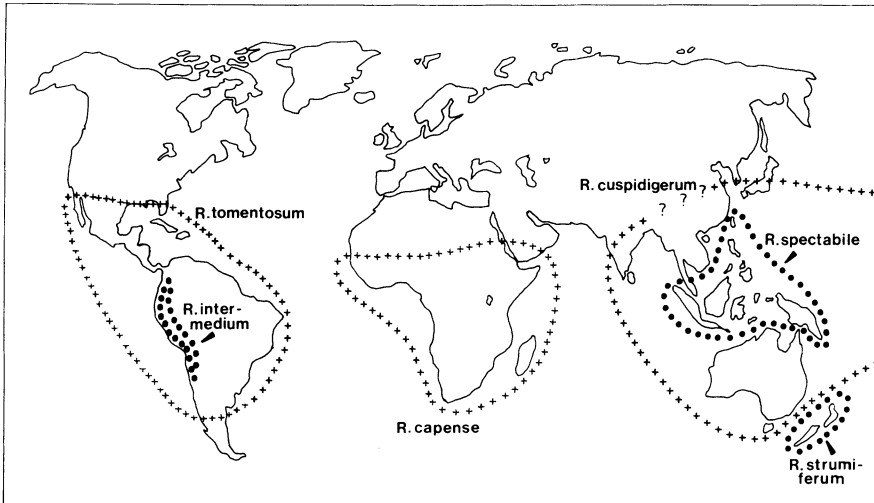

Fig. 1. Global distribution of the species studied, including *R. spectabile* and *R. cuspidigerum*.

constant, it is possible to estimate the rate of speciation (Nei 1971). Between natural populations of a given species, the allozyme differences are an indication of the extent of gene flow. Within species, it is assumed that the amount of genetic variation of natural populations is indicative of the evolutionary potential.

Considering the ongoing debate about the evolutionary potentials of bryophytes, it is surprising that the number of electrophoretic studies is still low. The few studies available at the moment show some interesting trends. Within natural populations, most of the investigated liverworts show a very uniform genetic structure (Zielinski 1987, Odrzykoski 1987). In contrast, all the electrophoretic studies in mosses show a moderate to high level of within-population variability (Cummins and Wyatt 1981, De Vries et al. 1983, Wyatt et al. 1987, Shaw et al. 1987, Hofman 1988b). In this respect, mosses show comparable amounts of allozyme variation to phanerogams. Interestingly, these observations support the view that mosses have a greater evolutionary potential than liverworts (Khanna 1964, Van Zanten and Pocs 1981).

Two *Racopilum* species (*Racopilum cuspidigerum* and *R. spectabile*) have already been studied by De Vries et al. (1983). They found high levels of genetic variation within populations. In the present study four other species of *Racopilum* are investigated: *R. strumiferum*, *R. intermedium*, *R. capense* and the diploid *R. tomentosum*. The aim of the study was to assess the genetic variation within and between populations of these four species. The systematic relationships between the six *Racopilum* species are discussed.

### The species

The genus *Racopilum* belongs to the Racopilaceae (Bryopsida, Isobryales). This family is characterized by plants with two rows of small dorsal leaves, in addition

to the more or less complanate lateral leaves. *Racopilum*, with about 20 species, is widespread throughout the tropics and the temperate zones of the Southern hemisphere (Fig. 1).

### Morphological data and geographical distribution

*R. strumiferum* (C. Muell.) Mitt. differs from all other *Racopilum* species by its mitrate calyptra, thick seta and strumiferous capsule. The gametophyte can hardly be distinguished from *R. convolutaceum* (C. Muell.) Reichenb. and is morphologically moderately variable. The species is restricted to New Zealand, where it is common in all parts of the country. It grows from sea level up to ca. 2000 m, on shaded or exposed earth, rotten wood or rocks, in native forests as well as in disturbed areas.

*R. tomentosum* (Hedw.) Brid. is morphologically a very variable species. It differs from the South East Asian *R. cuspidigerum* (Schwaegr.) Aongstr. only by its monoicy. *R. tomentosum* is the only known polyploid member of the genus (Inoue 1979) with  $n = 20$  versus  $n = 10$  in the six other species from which chromosome counts are available (Fritsch 1982, the present study). It is common in tropical and subtropical America, where it grows in the lowlands and the montane zone, in open as well as in shaded situations, on rocks, earth or trees.

*R. intermedium* Hampe has a sporophyte which is very distinct from all other *Racopilum* species, with a long, not furrowed capsule, very longly rostrate lid, long peristome teeth and strongly reduced basal membrane of the endostome. The gametophyte is similar to *R. tomentosum*, but it can usually be distinguished by the long, remotely pinnate stems and by its phyllocladocy. Morphologically, it is not very variable. *R. intermedium* is restricted to the tropical Andean mountains of South America, where it is a rather rare montane rainforest species.

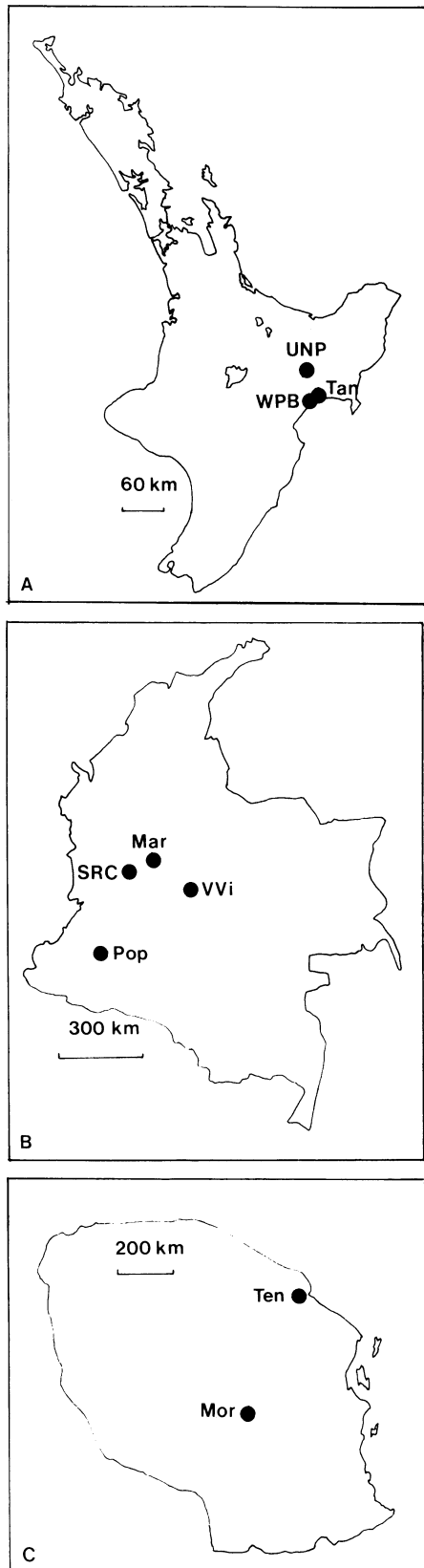

*R. capense* C. Muell. et Broth. is morphologically very variable. It is closely related to *R. tomentosum* but the main distinguishing character is its phylloidiocy. Morphologically it is an extremely variable species. *R. capense* is common in Africa south of the Sahara. There is also one record from North Yemen. It grows usually in open, often disturbed areas, but also in (rain)forests, from sea level up to ca. 2000 m. on rocks, trees or soil.

#### Reproduction

**Sexual reproduction:** *R. strumiferum*, *R. intermedium* and *R. capense* are phylloidiocous (male plants very small, nestling on the female plants). Of *R. strumiferum* and *R. capense* male plants of the same size of the female plants are also found, although very rarely. Sporophyte production is rather common. Of all herbarium specimens studied of *R. strumiferum* and *R. intermedium*, ca. 75% bear sporophytes, and of *R. capense* ca. 35%. *R. tomentosum* is monoicous (usually autoicous, rarely synoicous), and ca. 80% of the herbarium specimens bear sporophytes. *R. strumiferum* and *R. capense* never produced sporophytes in culture, not even when living spores of the species were sown on the female plants. *R. tomentosum*, on the other hand, produced several generations of sporophytes, when kept in culture.

**Asexual reproduction:** *R. intermedium*, and to a lesser extent *R. capense* and *R. tomentosum*, produce flagellae bearing small caducous leaves. After breaking off, these leaves produce buds from the basal ventral side of the nerve and can develop into adult female plants. Such flagellae were never observed in *R. strumiferum*. New female plants may also grow from leaf fragments, and, by sprouting of 'sleeping' buds, from stem fragments (De Vries et al. 1983).

#### Dispersal ability

The spores of the investigated species are small (10–16  $\mu\text{m}$ ) and have a moderate to high tolerance to desiccation and freezing. The tolerance to UV radiation, however, is poor, especially in *R. intermedium* (Van Zanten, unpubl. data). As a consequence, it seems unlikely that the spores will survive long range transoceanic transport. Effective long range dispersal by air-currents from Australasia to America and Africa (or vice versa) is therefore questionable. The spores may survive medium range dispersal (ca. 500–2000 km), even when they are sucked high into the air by heavy

Fig. 2. Locations of the populations studied in New Zealand (North Island, A), Colombia (B) and Tanzania (C). *R. strumiferum* (New Zealand): UNP, Urawera National Park; WPB, White Pine Bush; Tan, Tangoio Reserve. *R. tomentosum* (Colombia): SRC, Santa Rosa de Cabal; Mar, Mariquita; VVi, Villavicencio. *R. intermedium* (Colombia): Pop, Popayan. *R. capense* (Tanzania): Ten, Tenguru; Mor, Morningside.

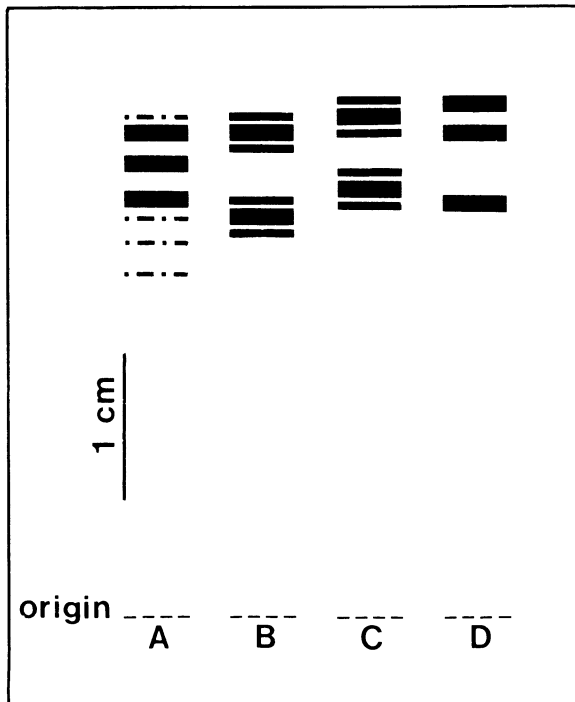

Fig. 3. Observed electromorphs of ICD, showing 4 types of multiple banding patterns.

showers or thunderstorms, since in these cases they are not exposed to UV radiation. Local dispersal is also possible by the caducous leaves which can withstand freezing.

### Materials and methods

Specimens of three populations of *R. strumiferum* were collected in 1982 from the North Island of New Zealand (Fig. 2A). In 1984, three populations of *R. tomentosum* and one population of *R. intermedium* were sampled from Colombia (Fig. 2B). Finally, two populations of *R. capense* from Tanzania were sampled in 1986 (Fig. 2C). From each of the nine populations, 4–12 specimens were collected. The distance between samples ranged from a few decimeters to three kilometers. Samples were sent to our laboratory, and were grown, using the methods described in De Vries et al. (1983). Voucher specimens are kept in the herbarium of the University of Groningen.

Protein extracts of *R. strumiferum*, *R. tomentosum* and *R. intermedium* were prepared by crushing 100 mg plant material in a mortar with a pestle, after addition of 4 mg Polyclar AT and 7% mercapto-ethanol solution (in 0.01 M tris-citrate, pH 7). After centrifugation at 4°C for 5 min at 10,000 rpm, the supernatant was ready for electrophoresis. Electrophoresis on horizontal polyacrylamide gels and staining methods were carried out according to De Vries et al. (1983) and Shaw and Prasad (1970), respectively.

Due to a change in electrophoretic procedure a somewhat different extraction method was used for *R. capense*. Single moss shoots were crushed on a precooled porcelain spot plate in 80 µl extraction buffer, with Polyclar AT and 2% mercapto-ethanol solution. Small pieces of Whatman 3 M paper were saturated with the extract, and were placed on the gel origin. In this case electrophoresis was carried out on horizontal starch gels. Gel preparation, electrophoresis procedure and staining methods are described by Hofman (1988a). To enable a comparison of the banding patterns obtained by both electrophoretic procedures, reference samples of the other species were also run on starch gels.

Of the 22 enzyme systems tested, eight showed scorable bands: glyceraldehyde-3-phosphate dehydrogenase (GA3PD; EC 1.2.1.12), glutamate-oxaloacetate transaminase (GOT; EC 2.6.1.1), glucosephosphate isomerase (GPI; EC 5.3.1.9), isocitrate dehydrogenase (ICD; EC 1.1.1.42), 6-phosphogluconate dehydrogenase (PGD; EC 1.1.1.44), peroxidase (PEROX; EC 1.11.1.7), phosphoglucomutase (PGM; EC 2.7.5.1) and triosephosphate isomerase (TPI; EC 5.3.1.1). GA3PD and ICD were determined only for *R. strumiferum*, *R. tomentosum* and *R. intermedium*. PEROX gave more distinct bands on starch gels than on polyacrylamide gels. Therefore, PEROX was interpreted and scored only in *R. capense*. TPI was studied only in *R. capense*. After staining, the enzyme bands were interpreted as alleles of a particular enzyme locus.

Values of genetic variation and genetic identity (and distance) were calculated using the methods described by Nei (1972, 1975). The mean effective number of alleles ( $\bar{A}_{eff}$ ) is given by  $1/\sum x_i^2$ , where  $x_i$  is the frequency of the  $i$ -th allele at a locus. A phylogenetic tree (UP-GMA) was constructed from the distance matrix (Ferguson 1980). The presumed time of divergence was estimated according to Nei (1971).

To confirm polyploidy in *R. tomentosum* (Inoue 1979), chromosome counts were made, using the method described in Hofman (1988b). Chromosome counts were also made for specimens of *R. strumiferum* and *R. capense* (at the time these counts were performed, unfortunately all samples of *R. intermedium* had already deteriorated).

### Results

#### Enzyme loci and allele frequencies

The majority of the enzyme systems, representing at least 10 enzyme loci produced simple banding patterns. Every specimen of *R. strumiferum*, *R. intermedium* and *R. capense* showed one band for each locus, except for ICD. Bands with a different electrophoretic mobility were scored as different alleles for each locus. The electromorphs of ICD consisted of complex patterns of

Fig. 4. Electromorphs of PGM and GOT in *R. tomentosum*. Pgm-1 shows fixed heterozygosity (\*) in all three populations. For Pgm-2, only homozygous single bands were found in the Mar and VVi populations, while the SRC population shows both homozygotes and heterozygotes. In both the Mar and VVi populations heterozygotes are found for the Got-locus. For abbreviations see legend of Fig. 2 and text.

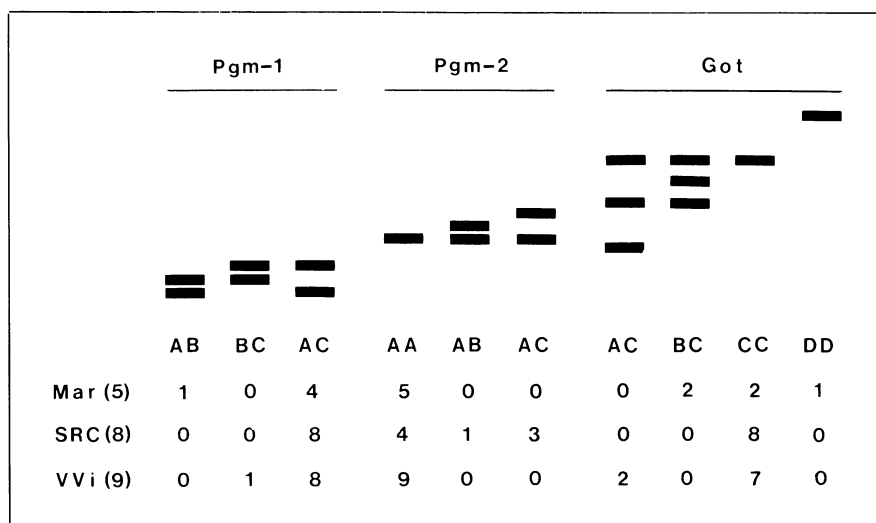

multiple bands (Fig. 3). For convenience the four complex genotypes (A, B, C and D) were scored as 4 alleles of one locus. All specimens of *R. tomentosum* showed two bands for Pgm-1 (Fig. 4), a situation not observed for the other species. Double bands for Pgm-2 were present in 4 out of 22 specimens (Fig. 4). In the majority of samples Got was expressed as a single band, but in 4 specimens three bands were seen (Fig. 4). These deviating banding patterns coincide with the existence of a double set of chromosomes in *R. tomentosum* (see below). The most likely explanation for this phenomenon is therefore that specimens with double or triple banding patterns are heterozygotes for the particular locus, while specimens with a single band represent homozygotes.

The allele frequencies of the enzyme loci for each population are given in Tab. 1. Because of its diploidy *R. tomentosum* requires a different calculation of allele frequencies. When  $H_o$  and  $H_c$  are the number of homozygotes and heterozygotes with respect to a particular allele, respectively, the frequency of this allele is given by  $(2H_o + H_c)/2N$ , where  $N$  is the number of samples from the population. Except for the Tpi-2 locus, which was only examined in *R. capense*, all loci are found to be polymorphic in at least one population. *R. strumiferum* differs from the other species by two unique alleles for Pgd. There is considerable overlap in alleles between *R. tomentosum*, *R. intermedium* and *R. capense*. Within each species, populations mostly share the same alleles,

with only relatively small differences in allele frequencies.

#### Genetic variation and genetic distance

The various measures for the amount of genetic variation in each population are shown in Tab. 2. On average all measures are higher for *R. strumiferum* and *R. tomentosum* than for *R. intermedium* and *R. capense*.

The values of genetic identity and genetic distance between the studied populations are presented in Tab. 3. Between populations within species the mean genetic distance is only 0.05, whereas the mean distance between populations of different species is 0.46. However, there are marked differences between these latter measures. Between *R. strumiferum* and the other species the observed mean genetic distance is 0.69 while between *R. tomentosum* and *R. intermedium* and between *R. tomentosum* and *R. capense* the mean distances are only 0.06 and 0.05, respectively. These latter two values are comparable with the one observed within species. With respect to *R. strumiferum*, the Tan and WPB populations, which are only 2 km apart, are more similar to each other than to the UNP population 50 km distant. In *R. tomentosum* no such relationship exists between geographical and genetic distance. Fig. 5 shows the phylogenetic tree, constructed from the genetic distances. The data of De Vries et al. (1983) on *R. spectabile* and *R. cuspidigerum* are also included in this figure.

(\*) If an individual contains two different copies of a gene, thus being heterozygous for that gene, it produces two different gene products (polypeptides) and both these polypeptides will be found after electrophoresis and staining. This is the case when the gene product is the active enzyme like with PGM. However, many enzymes are dimeric, which means that the active enzyme is created by combining two primary polypeptide chains (subunits) as is the case for GOT. The subunits combine at random which means that three types of active enzymes can be formed: two of them are a combination of two subunits produced by the same gene, but the third is a combination of one subunit of both genes (hybrid enzyme). The result is that after electrophoresis in a heterozygote three bands will be visible instead of two.

Tab. 1. Allele frequencies of populations of four *Racopilum* species. Number of specimens per population and running distances of alleles (in mm) in brackets (ns = not scored for this enzyme). For abbreviations see legend to Fig. 2 and text.

locus	allele	<i>R. strumiferum</i>			<i>R. tomentosum</i>			<i>R. intermedium</i>	<i>R. capense</i>	
		WPB (12)	UNP (7)	Tan (4)	Mar (5)	SRC (8)	VVi (9)	Pop (11)	Mor (7)	Ten (6)
<i>Ga3pd</i>	A(18)	.17		.50						
	B(23)	.83	1.00	.50	1.00	1.00	1.00	1.00	ns	ns
<i>Got</i>	A(31)						.11			
	B(36)	.92	.29	.75	.20					
	C(41)	.08	.71	.25	.60	1.00	.89	1.00	1.00	1.00
	D(46)				.20					
<i>Gpi-1</i>	A(10)							.18		
	B(13)	1.00	1.00	1.00	1.00	1.00	1.00	.82	1.00	1.00
<i>Icd</i> (*)	A	1.00	1.00	1.00			.11		ns	ns
	B				.80	.88	.89	1.00		
	C				.20					
	D					.12				
<i>Pgd</i>	A(13)				1.00	1.00	1.00	1.00	1.00	1.00
	B(16)	.92	.86	1.00						
	C(19)	.08	.14							
<i>Perox</i>	A(8)	ns	ns	ns	ns	ns	ns	ns	.86	.60
	B(10)								.14	.40
<i>Pgm-1</i>	A(26)	.92	1.00	1.00	.50	.50	.44		.86	1.00
	B(27)				.10		.06			
	C(29)	.08			.40	.50	.50	1.00	.14	
<i>Pgm-2</i>	A(32)	.17	.71	.25	1.00	.75	1.00	.82	1.00	1.00
	B(33.5)	.50	.29	.75		.06				
	C(35)	.25				.19				
	D(37)	.08						.18		
<i>Tpi-1</i>	A(19)	ns	ns	ns	ns	ns	ns	ns	.14	
	B(24)								.86	1.00
<i>Tpi-2</i>	A(41)	ns	ns	ns	ns	ns	ns	ns	1.00	1.00

\* Alleles of *Icd* are interpreted as multiple bands (see Fig. 3).

Tab. 2. Genetic variation within populations of four *Racopilum* species expressed as fraction of polymorphic loci (P), mean number of alleles per locus ( $\bar{A}$ ), mean effective number of alleles ( $\bar{A}_{eff}$ ) and mean gene diversity ( $\bar{H}_L$ ) with standard error (se). Number of specimens in brackets. For abbreviations see legend to Fig. 2.

species	population	P*	$\bar{A}$	$\bar{A}_{eff}$	$\bar{H}_L$	±	se
<i>R. strumiferum</i>	WPB (12)	.75	2.0	1.1	.20	±	.08
	UNP (7)	.50	1.4	1.3	.15	±	.07
	Tan (4)	.43	1.4	1.3	.18	±	.09
	mean	.56	1.6	1.3	.18		
<i>R. tomentosum</i>	Mar (5)	.43	1.7	1.5	.21	±	.10
	SRC (8)	.43	1.6	1.3	.16	±	.08
	VVI (9)	.43	1.6	1.3	.13	±	.08
	mean	.43	1.6	1.4	.17		
<i>R. intermedium</i>	Pop (11)	.29	1.3	1.1	.08	±	.05
<i>R. capense</i>	Mor (7)	.38	1.4	1.1	.09	±	.04
	Ten (6)	.13	1.1	1.1	.06	±	.06
	mean	.26	1.3	1.1	.08		

\* Total number of loci is 7, except for the *R. capense* populations and the WPB and UNP populations of *R. strumiferum*, where *Perox* is added as 8th-polymorphic-locus.



Tab. 3. Estimates of genetic identity and distance (below diagonal) between populations of four *Racopilum* species. For abbreviations see legend to Fig. 2.

		<i>R. strumiferum</i>			<i>R. tomentosum</i>			<i>R. intermedium</i>	<i>R. capense</i>	
		WPB	UNP	Tan	Mar	SRC	VVi	Pop	Mor	Ten
<i>R. strum</i>	WPB		.89	.96	.49	.45	.45	.33	.32	.33
<i>R. strum</i>	UNP	.12		.88	.64	.64	.65	.51	.50	.51
<i>R. strum</i>	Tan	.04	.13		.45	.43	.43	.29	.37	.38
<i>R. tomen</i>	Mar	.72	.44	.80		.96	.98	.91	.64	.64
<i>R. tomen</i>	SRC	.79	.45	.85	.04		.99	.95	.65	.64
<i>R. tomen</i>	VVi	.80	.43	.85	.02	.01		.95	.65	.64
<i>R. inter</i>	Pop	1.10	.68	1.23	.09	.05	.05		.55	.52
<i>R. capen</i>	Mor	.74	.28	.65	.05	.04	.04	.19		.99
<i>R. capen</i>	Ten	.71	.26	.61	.07	.06	.06	.26	.01	

### Chromosome numbers

*R. tomentosum* was found to have 20 chromosomes (counts in three plants). The chromosome number of *R. strumiferum* was  $n = 10$  (two plants) and in *R. capense* also  $n = 10$  (one plant).

### Discussion

#### General

The genetic basis of enzyme phenotypes can only be established by crossing parents and analyzing the enzyme patterns of their offspring. Unfortunately, crossing experiments are complicated in mosses. Therefore an interpretation of enzyme phenotypes is at the moment more or less tentative. However, most of the explored enzyme systems in bryophytes produce simple banding patterns, which can easily be interpreted as loci with different alleles. Since the haploid gametophyte possesses one set of chromosomes, each enzyme locus produces only one polypeptide chain (a single band). Obviously, this is the case for all studied enzyme systems in *R. strumiferum*, *R. intermedium* and *R. capense*, except for ICD. However, multiple banding patterns are a common feature of ICD, caused by post-translational modification.

More accurate estimates of the genetic variation could have been obtained by exploring more enzyme systems. Also, the small sample size underestimates the fraction of polymorphic loci and the number of alleles present in the population, because rare alleles may not be discovered. On the other hand, estimates of the effective number of alleles and of gene diversity may be less dependent on the number of specimens, because they are based on allele frequencies.

#### Ployploidy and electrophoresis in *R. tomentosum*

*R. tomentosum* showed double and triple banding patterns for the Pgm and Got loci, respectively. In general,

the finding of 'heterozygotes' in apparent haploids such as gametophytes is unexpected, since each locus in an individual is represented by only one copy of the gene. Possible explanations for the observed heterozygous banding patterns in *R. tomentosum* are gene duplication, allopolyploidy, and autopolyploidy.

In haploids, gene duplication results in two copies of a particular gene. By mutation, these copies can become different which, in the case of allozymes, can result in double or multiple banding patterns. Gene duplication is an unlikely explanation for the heterozygotes in *R. tomentosum*. Firstly, it has a double set of chromosomes ( $n = 20$ ), and may be considered gametophytically diploid. Secondly, heterozygous banding patterns have never been observed in the *Racopilum* species with  $n = 10$ , except in one specimen of *R. cuspidigerum* from Taiwan. This plant showed double bands for the Pgm loci, but turned out to be a diploid

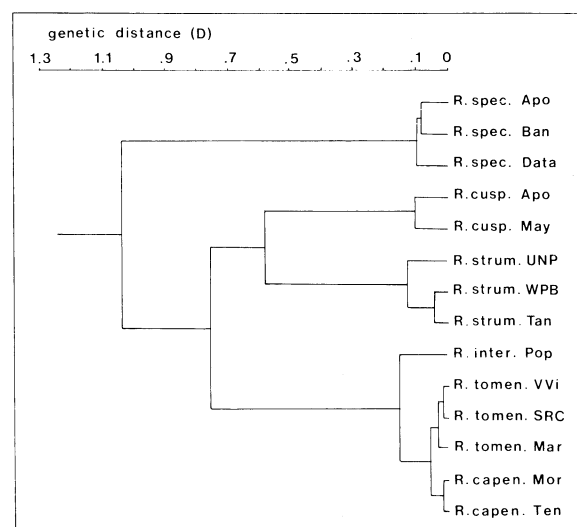

Fig. 5. Phylogenetic tree constructed from genetic distances between populations of six *Racopilum* species. For abbreviations see legend of Fig. 2.

also (Bramer 1986). Obviously, in *Racomium*, heterozygous banding patterns are associated with diploidy.

Allopolyploidy or interspecific hybridization will result in fixed heterozygosity, as in *Plagiomnium medium* (Wyatt et al. 1988), when the two parent species have different alleles for a particular locus. This is because the homologous chromosomes in the gametophyte probably differ too much to allow random pairing during meiosis. Evidence for allopolyploidy in *R. tomentosum* is poor. Firstly, fixed heterozygosity was only observed for Pgm-1, but not for Pgm-2 and Got. Theoretically, the finding of homozygotes in Pgm-2 and Got does not preclude the possibility of allopolyploidy when *R. tomentosum* originated more than once from the two haploid progenitors (the finding of different types of fixed heterozygotes in Pgm-1 would also suggest a multiple origin in this case), assuming that the parent species shared some but not all of the alleles of Pgm-2 and Got. Secondly, it is not possible to designate the two parent species, either on morphological grounds, or with help of allozyme patterns of the species studied so far. In South America, besides *R. tomentosum*, *R. intermedium* and *R. chilense* are the only *Racomium* species. *R. intermedium* seems unlikely to be the progenitor of *R. tomentosum*, because of its very distinct sporophyte.

Most polyploid mosses are considered to be autopolyploids or intraspecific hybrids, arising after the failure of one of the meiotic divisions (diplospory) (Smith 1978, Ramsay 1983, Wyatt and Anderson 1984). Autopolyploids may have originated after self-fertilization (homozygous autopolyploidy) or from cross-fertilization between two different genotypes (heterozygous autopolyploidy) (Lewis 1980). Homozygous autopolyploids would show only single banding patterns after electrophoresis, at least when they originated recently. This situation probably is met in *Plagiothecium nemorale*, with  $n = 21$  in Dutch populations ( $n = 11$  outside The Netherlands), which reveals no heterozygotes (Hofman 1988b). Homozygous autopolyploidy in *R. tomentosum* seems not very likely, because three of the examined loci showed several heterozygotes. Theoretically it is, however, possible that in homozygous autopolyploids heterozygotes may arise, by mutations of one of the two initially identical alleles of a given locus. Furthermore, assuming homozygous autopolyploidy would, in view of the considerable number of different heterozygotes and considering the low mutation rate, imply that *R. tomentosum* is an old species. The electrophoretic results, however, point to a recent origin (Fig. 5).

Heterozygous autopolyploidy seems therefore the most likely origin of *R. tomentosum*. The finding of different heterozygotes for each of the Pgm and Got loci points to a multiple origin of this species. In addition, new alleles (and heterozygotes) may have arisen by recent mutations. Heterozygous autopolyploidy may also explain the finding of both homozygotes and heterozygotes for Pgm-2 and Got, at least when random pairing between the four homologues during meiosis takes place to en-

able recombination (tetraploid heterozygous spore mother cells then segregate both homozygous and heterozygous spores). Of course, only experimental crosses combined with an electrophoretic analysis of offspring might confirm this assumption of random pairing.

The finding of only (fixed) heterozygotes for Pgm-1 seems to contradict heterozygous autopolyploidy, although it could be coincident in view of the limited number of specimens. However, locating Pgm-1 on the sex-chromosomes, could also result in fixed heterozygosity for this locus, even in the case of heterozygous autopolyploidy. Of course, this assumption is speculative. The existence of sex chromosomes in *Racomium* seems probable, because all haploid *Racomium* species, and most probably also the haploid ancestor(s) of the monoicous *R. tomentosum*, are dioicous and according to Smith (1978), in bryophytes diploidization often parallels a shift from dioicy towards monoicy. After diplospory the resulting diploid gametophyte would contain both sex chromosomes (X and Y), enabling the production of both male and female sex organs. Since monoicous polyploid mosses often show preferential pairing between the X-chromosomes together and the Y-chromosomes together (Wyatt and Anderson 1984), only XY spores would be produced. Consequently, the fully monoicous offspring could show fixed heterozygosity for Pgm-1.

The importance of polyploidy for the evolutionary potential of bryophytes is stressed by many authors (Khanna 1964, Longton 1976, Smith 1978, Vitt 1983, Ramsay 1983, Newton 1984, Wyatt et al. 1988). As a consequence of the change of chromosome numbers, polyploidy is most often followed by reproductive isolation between the ancestor(s) and its polyploid descendant (Smith 1978). Therefore, polyploidy might be an effective way to prevent gene flow between diverging populations, and promote sympatric speciation in bryophytes.

Duplication of chromosomes also results in the presence of two alleles for each locus in the gametophyte. New mutant alleles that normally might have been harmful for the organism, can be protected against selection by the other regular copy of the allele (shielding effect). The preservation of new alleles theoretically results in increased genetic variation, which constitutes the raw material for further evolution.

With regard to the evolutionary significance of polyploidy, there is an important difference between autopolyploidy and allopolyploidy. In allopolyploidy, as discussed above, it seems unlikely that the two 'homologues' in the gametophyte – which were derived from two different parental species – form bivalents during meiosis. In fact they behave as separate chromosomes, without interchange by recombination (the term 'homologue' is then incorrect). Since the 'homologous' loci behave independently, each of these loci is represented by only one allele in the gametophyte. The independence of these loci leads to their gradual divergence. In the beginning, the shielding effect may still be functional, but

eventually it will be lost. Thus, while allodiploids might initially take advantage of the existence of two related loci, this evolutionary benefit will disappear eventually. Allopolyploids therefore slip back into the haploid nature of many of their relatives, and become functionally haploid again.

In contrast, autodiploidy could hypothetically approach functional diploidy, at least when there is random pairing of the four homologues during meiosis (and recombination between all possible bivalents). This would result in the generation of homozygotes and heterozygotes in the gametophyte. Random pairing during meiosis in a tetraploid sporophyte would also result in an increased variety of genetically different spores.

#### Genetic variation within populations

The results of our study show moderate to high levels of genetic variation within populations, which fall within the range of phanerogams (Hamrick et al. 1979, Gottlieb 1981). These findings correspond with previous estimates of genetic variation in *R. cuspidigerum* and *R. spectabile* (De Vries et al. 1983).

In comparison with the other *Racopilum* species, the variation in populations of *R. intermedium* and *R. capense* is lower. Since the populations of both species were located in the unnatural environment of cleared sites (*R. capense*) and secondary forest (*R. intermedium*), founder effects or bottlenecks have probably reduced genetic variation. Therefore, it is possible that the variability in more natural populations of these species might be considerably higher. Genetic uniformity was also observed in one of the populations of *R. cuspidigerum*, which was located in a plantation (De Vries et al. 1983). Likewise, Wyatt et al. (1987) found lower levels of genetic variation in populations of *Plagiomnium ciliare* from disturbed localities than from undisturbed sites.

With respect to the amount of genetic variation the tropical moss genus *Racopilum* (De Vries et al. 1983, this study) and the temperate genus *Plagiothecium* (Hoffman 1988b) have been studied in greatest detail to date. Both genera show comparable levels of genetic variation: the mean gene diversity in populations of *Plagiothecium* was 0.15 versus 0.14 in *Racopilum*. Populations of *Plagiomnium ciliare* show less variation, the mean gene diversity was found to be 0.08 (Wyatt et al. 1987). Unfortunately, in most other electrophoretic studies in mosses gene diversity was not calculated. Among hepatics studies, *Plagiochila asplenioides* seems the most variable species, but Krzakowa and Szweykowski (1979) examined only two very variable enzyme systems. The observed gene diversity of 0.20 is in sharp contrast with the low values found in species of the thallose *Pellia* and *Conocephalum*, which vary between 0.01 and 0.05 (Szweykowski 1984, Zielinski 1987). Yamazaki (1981, 1984) found high levels of genetic variation in Japanese populations of *Conocephalum con-*

*icum*. In Europe, however, morphologically hardly distinguishable forms of *C. conicum* exist, which are genetically isolated (Odrzykoski 1987). These sibling species show very low levels of variation (Szweykowski 1984). It seems possible, therefore, that Yamazaki (1981, 1984) examined different sibling species of *C. conicum* which might explain the high total gene diversity observed. In conclusion, bryophytes show a wide range of genetic variation: *Racopilum* and *Plagiothecium* seem to belong to the most variable bryophytes, while the thallose liverworts exhibit the lowest levels of variation.

The significance of allozyme variation with respect to evolution is still not fully understood. The hypothesis that most of the enzyme polymorphisms are in fact selectively neutral (Kimura 1968), has still not been rejected, although there are some examples of a relation between allele frequencies and environmental conditions (Nevo 1978). The data so far indicate that a correlation exists between the amount of genetic variation in bryophytes and the supposed rate of speciation. *Racopilum* and *Plagiothecium* belong to the pleurocarpous diplolepidae, which are considered as a relatively young group of mosses with active speciation (Vitt 1983). The Plagiochilaceae, with their highly variable member *Plagiochila asplenioides* (Krzakowa and Szweykowski 1979), are regarded as a rapidly evolving group among hepatics (Schuster 1969). On the other hand, the low levels of genetic variation in *Pellia* (Zielinski 1987) might correspond with the view of Schuster (1983) that the majority of the genera in the Metzgeriales, including *Pellia*, are old relicts. Perhaps also the low level of variation in *Conocephalum* is indicative of slow evolution (Schofield 1985). This suggests that the amount of genetic variation found in bryophyte populations might be indicative of their evolutionary potential. The differences between mosses and hepatics in the degree of genetic variation agrees well with the view that mosses are evolutionarily more successful than liverworts (Khanna 1964). Of course, much more research is needed to reveal the validity of these assumptions.

Within bryophyte populations several factors may increase or decrease the amount of genetic variation. Haploidy of the gametophyte might reduce genetic variation, since newly arisen detrimental alleles will not be protected against selection as might be the case in diploids (Anderson 1963, Crum 1972, Szweykowski 1984). Although allozyme loci are most probably selectively neutral (at least in plants), they can be tightly linked to fitness genes and selection at these loci may therefore also affect the level of allozyme variation. The data on *Racopilum* (and also on *Plagiothecium*, Hofman 1988b), however, reveal moderate to high levels of genetic variation. Moreover, in the diploid *R. tomentosum*, the amount of variation is not different from the haploid members of the genus (although a higher degree of inbreeding could be a limiting factor especially

in the monoicous *R. tomentosum*). It seems, therefore, unlikely that haploidy is a predominating factor in limiting genetic variation.

Many bryophytes (e.g. *Racopilum*) live in a spatially and temporally heterogeneous environment. It has therefore been suggested that local ecotypes might arise, adapted to different microhabitats, thereby increasing the genetic differentiation (Cummins and Wyatt 1981, Hamrick et al. 1979). Using theoretical models, however, Hoekstra (1978) showed that spatial and temporal varying selection pressures are not sufficient to maintain genetic variation in haploid populations.

The influence of life history characteristics on the genetic variation in *Racopilum* is easier to understand than the role of selection. One of the most important characteristics is the reproductive strategy: outcrossing will increase genetic variation, whilst selfing and asexual reproduction will decrease it. Since all *Racopilum* species, except *R. tomentosum*, are dioicous, outcrossing is obligate, and consequently, many different genotypes can be produced by recombination. The mean gene diversity of 0.18 in the natural populations of *Racopilum*, including *R. cuspidigerum* and *R. spectabile*, closely resembles the mean gene diversity observed for outcrossed seed plants (0.18), and is considerably higher than the value of 0.09 of inbreeding seed plants (Hamrick et al. 1979).

Given the limited sperm dispersal distances in bryophytes, the amount of genetic variation in *Racopilum* is unexpectedly high. Firstly, restricted sperm dispersal hinders effective cross-fertilization, resulting in a high degree of asexual reproduction in dioicous bryophytes (Longton and Schuster 1983). Secondly, limited sperm dispersal leads to inbreeding. Since the majority of spores will probably germinate close to or even on the mother plant in the case of *Racopilum* (dwarf males), the incidence of son-mother crosses will be high.

Pleurocarps like *Racopilum* may grow very old. A long life span will maintain high levels of genetic variation, since populations consisting of different generations preserve genotypes that might have arisen under different selective forces (Hamrick et al. 1979). *R. spectabile*, for example, generates large carpets of several square meters, growing in the stable environment of a rainforest. Most of the other *Racopilum* species grow in subclimax vegetation, but the ability of vegetative reproduction, by e.g. flagellae and leaf fragments, ensures a very long life of genotypes. Compared with Hamrick's (1979) category 'herbaceous perennials' with a mean diversity of 0.12, the mean gene diversity in *Racopilum* (0.18) is considerable.

A third factor that may increase the genetic variation is spore dispersal. Although gene flow by sperm dispersal is limited, gene flow by means of spores may be extensive (Van Zanten and Pocs 1981). Long dispersal distances will increase the levels of genetic variation, because new alleles may be introduced regularly from

other populations (Hamrick et al. 1979, Loveless and Hamrick 1984). Those species of *Racopilum* which live in open vegetation may have especially good opportunities for long (spore) dispersal distances.

Other life history traits of *Racopilum* may also favour a high level of genetic variation within populations. Among these are a high fecundity and a large population size. Hamrick et al. (1979) demonstrated a significant positive correlation between the reproductive potential and the amount of genetic variation, both in plants and animals. In bryophytes, which show a high spore output per capsule (Longton and Schuster 1983), a high fecundity could occur, especially in the pleurocarps due to their long life span. In large stable populations the effects of genetic drift are negligible, thereby preserving the genetic diversity (Loveless and Hamrick 1984). That bryophyte populations contain large numbers of individuals is illustrated by the neighborhood size of more than 300,000 plants of *Atrichum angustatum* (Wyatt and Anderson 1984).

In conclusion, although it is postulated that the predominant haploid phase of bryophytes will tend to reduce genetic variation compared with diploid seed plants (Anderson 1963, Crum 1972, Szweykowski 1984), there are many characteristics of bryophytes that might favour variation. Among these characteristics in *Racopilum* are outcrossing, a long life span, extensive gene flow, a high fecundity and a large population size.

#### Genetic distances within species

The estimated genetic distances (D) between populations of the same species are comparable with observed values in seed plants (Hamrick 1979). Genetic distances are larger within *R. strumiferum* than within *R. tomentosum* and *R. capense*, while the three populations of *R. strumiferum* are geographically closer to each other. De Vries et al. (1983) observed increasing genetic distances between populations of *R. spectabile* with increasing geographical distances. In the present study also the adjacent Tangoio and White Pine Bush populations of *R. strumiferum* seem to be more related to each other genetically than to the population of Urawera National Park, which is 50 km away. As in *Plagiomnium ciliare* (Wyatt et al. 1987), no correlation between genetic and geographic distance is found in *R. tomentosum*.

Selection, genetic drift and migration are processes that can affect the extent of genetic differentiation between populations. We think that the latter two are the most important with respect to allozyme variation in bryophytes. Migration between adjacent populations tends to reduce the extent of differentiation and might explain why the two adjacent populations of *R. strumiferum* are less differentiated from each other than from the more distant UNP population. Genetic drift promotes differentiation but also tends to decrease the amount of genetic variation within populations. This

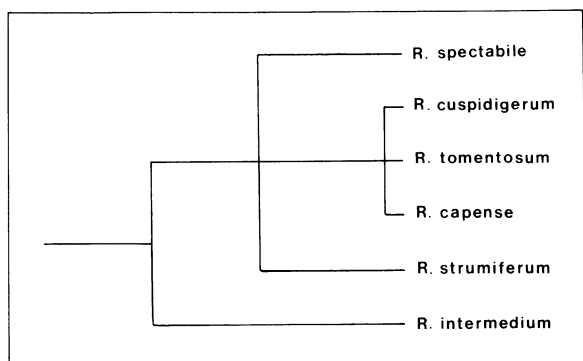

Fig. 6. Provisional tree at the species level, based on morphological characters.

might explain the relatively low degree of polymorphism found for the two *R. capense* populations but contradicts the observed small genetic distance between the two remote populations.

#### Electrophoretic data and taxonomy

As expected, the genetic distances between populations of the same species are generally much smaller than between pairs of populations of different species (Tab. 3, Fig. 5). This observation supports the reliability of enzyme electrophoresis as a tool in systematics. The number of studied specimens and loci is low, however, which implies that the data in Tab. 3 have to be regarded as crude estimates. To what extent are these data in agreement with morphological differences? Because the taxonomic revision of the *Racopilaceae* is still in progress, for the moment we want to give just preliminary comments. To compare the tree, constructed from the genetic distances (Fig. 5), with morphological data, a provisional tree based on gametophytic and sporophytic characters is shown in Fig. 6. There are a number of differences between the trees.

Most surprising are the small genetic distances (0.05–0.09) between the *R. intermedium* population and the populations of *R. tomentosum*. These distances fall within the range of 0.01–0.13 that is observed between populations within a species. In other words, the electrophoretic data suggest differentiation between these two species only at the population level. This is in sharp contrast with the sporophytic differences between *R. intermedium* and all other *Racopilum* species (Fig. 6; *R. intermedium* possesses very long and narrow peristome teeth, and a very low basal membrane of the endostome). Based on these distinctions, *R. intermedium* could well be separated as a new genus. Morphological characters are thought to be determined by many loci. Therefore, large changes in sporophyte morphology would generally arise only after mutations at many of these loci. But in that case one would also expect a considerable differentiation at the enzyme level. The contradiction between morphological and electropho-

retic data can possibly be explained by assuming that in the ancestral population of *R. intermedium* a mutation occurred in a regulatory gene, which caused a large correlated change in many peristome characters. An analogous case of morphological divergence also exists in the *Onagraceae* between *Heterogaura heterandra*, with very distinct floral and fruit characters and therefore placed in a separate genus, and species of the genus *Clarkia*. Recent DNA-analysis, however, has shown that *H. heterandra* is more closely related to one particular *Clarkia* species, *C. dudleyana*, than this species to the other *Clarkia* species (Sytsma and Gottlieb 1986). This strongly suggests that these two species share a common origin, as is most probably also the case between *R. intermedium* and *R. tomentosum*.

The genetic distances between *R. capense* and *R. tomentosum* are also remarkably small, but this is in full agreement with the morphological similarities. Besides the different chromosome numbers, the only distinction between these taxa is the monoicy of *R. tomentosum*, in contrast to the phylloidiocy of *R. capense*. Although *R. capense* and *R. cuspidigerum* are morphologically hardly distinguishable, the electrophoretic data show considerable differences at the species level (Fig. 5). This can be explained by a convergent morphological evolution. Another possibility is that both species share a common ancestor, but, due to their existence on different continents, they might (in the absence of intercontinental spore dispersal) be reproductively isolated. Consequently one has to assume that in spite of the considerable genetic divergence, no major morphological divergence occurred (Selander et al. 1970).

Although *R. strumiferum* can hardly be distinguished from *R. cuspidigerum* gametophytically, its sporophyte is characteristic. The allozyme data show also a considerable divergence between these two species (Fig. 5). Morphologically, *R. spectabile* can easily be recognized because of its conspicuously toothed leaf margin. The distinct taxonomic status of *R. spectabile* is confirmed by the electrophoretic data.

At this moment, we can only speculate about the evolutionary pathways and rate of speciation within *Racopilum*. The observed genetic distances between the six species studied to date suggest a recent evolution, which started approximately 5 Myr ago. This figure is based, however, on certain presumptions like the rate and constancy of codon substitutions (Nei 1971), and may therefore show a considerable deviation. Nevertheless, it seems very likely that the present *Racopilum* species developed after the continental drift (50 Myr BP). This implies that the present geographical distribution is, at least in part, the result of medium or long range dispersal.

The available geographical, morphological and electrophoretic data suggest that *Racopilum* originated in South East Asia, particularly in the Malesian region. *R. spectabile* is a distinct species with only one narrow relative (*R. verrucosum*), and, in addition, seems one of

the oldest *Racopilum* species (Fig. 5). Therefore, a *R. spectabile* – like moss could perhaps be considered as the common ancestor of the six presently studied *Racopilum* species. This ancestor could subsequently have given rise to a *R. cuspidigerum* – like species, which successfully extended, possibly by means of medium range dispersal, to Australia and New Zealand, where *R. strumiferum* was derived. Much later, perhaps at a time when the *R. cuspidigerum* – like species was already differentiated into the present *R. cuspidigerum* and *R. capense*, the latter also established itself in South America and Africa (by means of long range dispersal). Tab. 3 and Fig. 5 suggest that *R. capense* and *R. tomentosum* were derived from a *R. intermedium* – like ancestor, but the differences in genetic distance between the species are small and not significant. It is therefore also possible that *R. tomentosum* and *R. intermedium* originated independently in South America from *R. capense*. *R. tomentosum* did presumably emerge by heterozygous autopolyploidy, *R. intermedium* by a mutation of a regulatory gene. Finally, *R. capense* could have been eliminated from South America, for example, by competition from the much more abundantly fruiting *R. tomentosum*. Further research has to be done to allow more definitive conclusions.

*Acknowledgement* – We thank H. P. Ramsay for critically reviewing the manuscript.

## References

- Anderson, L. E. 1963. Modern species concepts: mosses. – *Bryologist* 66: 107–119.
- Bramer, J. P. J. 1986. De systematiek van de Racopilaceae met behulp van electroforese. – Internal report. Biological Centre, Haren.
- Crum, H. 1972. The geographic origins of the mosses of North America's eastern deciduous forest. – *J. Hattori Bot. Lab.* 35: 269–298.
- Cummins, H. and Wyatt, R. 1981. Genetic variation in natural populations of the moss *Atrichum angustatum*. – *Bryologist* 84: 30–38.
- Ferguson, A. 1980. Biochemical systematics and evolution. – Blackie, Glasgow.
- Fritsch, R. 1982. Index to plant chromosome numbers – Bryophyta. – *Regn. Veg.* 108: 1–268.
- Gottlieb, L. D. 1981. Electrophoretic evidence and plant populations. – In: Reinhold, T., Harborne, J. B. and Swain, T. (eds), *Progress in phytochemistry*, Vol. 7. Pergamon, Oxford, pp. 1–46.
- Hamrick, J. L. 1979. Genetic variation and longevity. – In: Solbrig, O. T. et al. (eds), *Topics of plant population biology*. Columbia Univ. Press, New York.
- , Linhart, Y. B. and Mitton, J. B. 1979. Relationships between life history characteristics and electrophoretically detectable genetic variation in plants. – *Ann. Rev. Ecol. Syst.* 10: 173–200.
- Hoekstra, R. F. 1978. Sufficient conditions for polymorphism with clinal selection in a subdivided population. – *Genet. Res.* 31: 67–73.
- Hofman, A. 1988a. Starch gel electrophoresis: a tool for studying the evolutionary systematics and population genetics of mosses. – In: Glime, J. M. (ed.), *Methods in bryology*. Hattori Bot. Lab., Nichinan, pp. 353–358.
- 1988b. A preliminary survey of allozyme variation in the genus *Plagiothecium* (Plagiotheciaceae, Bryopsida). – *J. Hattori Bot. Lab.* In press.
- Inoue, S. 1979. A preliminary report on moss chromosome numbers. – *Misc. Bryol. Lich.* 8(6): 109–113.
- Khanna, K. R. 1964. Differential evolutionary activity in bryophytes. – *Evolution* 18: 652–670.
- Kimura, M. 1968. Evolutionary rate at the molecular level. – *Nature, Lond.* 217: 624–626.
- Krzakowa, M. and Szweykowski, J. 1979. Isozyme polymorphism in natural populations of a liverwort, *Plagiochila asplenioides*. – *Genetics* 93: 711–719.
- Lewis, W. H. 1980. Polyploidy in species populations. – In: Lewis, W. H. (ed.), *Polyploidy*. Plenum Press, New York, pp. 103–144.
- Longton, R. E. 1976. Reproductive biology and evolutionary potential in bryophytes. – *J. Hattori Bot. Lab.* 41: 205–223.
- and Schuster, R. M. 1983. Reproductive biology. – In: Schuster, R. M. (ed.), *New manual of bryology*, Vol. 1. Hattori Bot. Lab., Nichinan, pp. 386–462.
- Loveless, M. D. and Hamrick, L. J. 1984. Ecological determinants of genetic structure in plant populations. – *Ann. Rev. Ecol. Syst.* 15: 65–95.
- Nei, M. 1971. Interspecific gene differences and evolutionary time estimated from electrophoretic data on protein identity. – *Am. Nat.* 105: 385–398.
- 1972. Genetic distance between populations. – *Am. Nat.* 106: 283–292.
- 1975. *Molecular population genetics and evolution*. – Elsevier, New York.
- Nevo, E. 1978. Genetic variation in natural populations: patterns and theory. – *Theor. Pop. Biol.* 13: 121–177.
- Newton, M. E. 1984. The cytogenetics of bryophytes. – In: Dyer, A. F. and Duckett, J. G. (eds), *The experimental biology of bryophytes*. Academic Press, London.
- Odrzykoski, I. J. 1987. Genetic evidence for reproductive isolation between two European 'forms' of *Conocephalum conicum*. – In: Pocs, T. et al. (eds), *Proc. IAB Conf. Bryocology. Symp. Biol. Hungarica* 35: 577–588.
- Ramsay, H. P. 1983. Cytology of mosses. – In: Schuster, R. M. (ed.), *New manual of bryology*, Vol. 1. Hattori Bot. Lab., Nichinan, pp. 149–221.
- Schofield, W. B. 1985. *Introduction to bryology*. – Macmillan, New York.
- Schuster, R. M. 1969. *The Hepaticae and Anthocerotae of North America*, Vol. II. – Columbia Univ. Press, New York.
- 1983. Evolution, phylogeny and classification of the Hepaticae. – In: Schuster, R. M. (ed.), *New manual of bryology*, Vol. 2. Hattori Bot. Lab., Nichinan, pp. 892–1070.
- Selander, R. K., Yang, S. Y., Lewontin, R. C. and Johnson, W. E. 1970. Genetic variation in the horseshoe crab (*Limulus polyphemus*), a phylogenetic relict. – *Evolution* 24: 402–414.
- Shaw, C. R. and Prasad, R. 1970. Starch gel electrophoresis of enzymes. A compilation of recipes. – *Biochem. Genet.* 4: 297–320.
- Shaw, J., Meagher, T. R. and Harley, P. 1987. Electrophoretic evidence of reproductive isolation between two varieties of the moss, *Climacium americanum*. – *Hereditas* 59: 337–343.
- Smith, A. J. E. 1978. Cytogenetics, biosystematics and evolution in the Bryophyta. – In: Woolhouse, H. (ed.), *Adv. Bot. Res.* 6: 196–277. Academic Press, London.
- Szweykowski, J. 1984. What do we know about the evolutionary process in bryophytes? – *J. Hattori Bot. Lab.* 55: 209–218.
- Sytsma, K. J. and Gottlieb, L. D. 1986. Chloroplast DNA evidence for the origin of the genus *Heterogaura* from a species of *Clarkia* (Onagraceae). – *Proc. Nat. Acad. Sci. USA* 83: 5554–5557.

- Vitt, D. H. 1983. Classification of the Bryopsida. – In: Schuster, R. M. (ed.), *New manual of bryology*, Vol. 2, Hattori Bot. Lab, Nichinan, pp. 696–759.
- Vries A. de, Van Zanten, B. O. van and Dijk, H. van. 1983. Genetic variation within and between populations of two species of *Racopilum* (Racopilaceae, Bryopsida). – *Lindbergia* 9: 73–80.
- Wyatt, R. and Anderson, L. E. 1984. Breeding systems in bryophytes. – In: Dyer, A. F. and Duckett, J. G. (eds), *The Experimental biology of bryophytes*. Academic Press, London, pp. 39–64.
- , Odrzykoski, I. J. and Stoneburger, A. 1987. Electrophoretically detectable genetic variation in *Plagiomnium ciliare*: a preliminary report. – In: Pocs, T. et al. (eds), *Proc. IAB Conf. Bryoecology. Symp. Biol. Hungarica* 35: 589–602.
- , Odrzykoski, I. J., Stoneburger, A., Bass, H. W. and Galau, G. A. 1988. Allopolyploidy in bryophytes: Multiple origins of *Plagiomnium medium*. – *Proc. Nat. Acad. Sci. USA* 85: 5601–5604.
- Yamazaki, T. 1981. Genetic variation in natural populations of a haploid plant, *Conocephalum conicum*. I. The amount of heterozygosity. – *Jap. J. Genet.* 56: 373–383.
- 1984. The amount of polymorphism and genetic differentiation in natural populations of the haploid liverwort *Conocephalum conicum*. – *Jap. J. Genet.* 59: 133–139.
- Zanten, B. O. van and Pocs, T. 1981. Distribution and dispersal of bryophytes. – *Adv. Bryology* 1: 479–562.
- Zielinski, R. 1987. Genetic variation in the liverwort genus *Pellia* with special reference to central European territory. – In: Pocs, T. et al. (eds), *Proc. IAB Conf. Bryoecology. Symp. Biol. Hungarica* 35: 175–189.

---

## News and progress...

Longton, R. E. 1988. Adaptations and strategies of polar bryophytes. – *Bot. J. Linn. Soc.* 98: 253–268.

Physiological characteristics of polar bryophytes are discussed in relation to geographical distribution patterns, current polar climates, and the environmental history of the polar regions. The most significant attributes conferring fitness in contemporary polar environments appear to be phenotypic plasticity, opportunistic responses in CO<sub>2</sub> exchange, and poikilohydrous water relations leading to considerable tolerance of desiccation and frost. These features are widely distributed among bryophytes generally, and cannot be regarded as specific adaptations to polar conditions. This conclusion is consistent with the fact that most members of the polar bryophyte floras range widely in boreal forest, and in many cases also temperate regions. They are believed to have evolved under temperate conditions before the advent of polar environments during Tertiary climatic cooling, and they are characterized by an evolutionarily conservative life strategy. However, such species may show inherent, inter-population variation of an apparently adaptive nature in morphological or physiological characters. A small, contrasting assemblage of Arctic-endemic species, so far uninvestigated physiologically, shows high fertility and is suspected as being of more recent, possibly Pleistocene origin.

*R. E. Longton, Dept of Botany, School of Plant Sciences, The Univ., Reading RG6 2AS, England.*