



University of Groningen

**Preparation and characterization of the disjoint diradical 4,4'-bis(1,2,3,5-dithiadiazolyl) [S<sub>2</sub>N<sub>2</sub>C-CN<sub>2</sub>S<sub>2</sub>] and its iodine charge transfer salt [S<sub>2</sub>N<sub>2</sub>C-CN<sub>2</sub>S<sub>2</sub>]**

Bryan, C.D.; Cordes, A.W.; Goddard, J.D.; Haddon, R.C.; Hicks, R.G.; MacKinnon, C.D.; Mawhinney, R.C.; Oakley, R.T.; Palstra, T.T.M.; Perel, A.S.

*Published in:*  
Journal of the American Chemical Society

*DOI:*  
[10.1021/ja952144x](https://doi.org/10.1021/ja952144x)

**IMPORTANT NOTE: You are advised to consult the publisher's version (publisher's PDF) if you wish to cite from it. Please check the document version below.**

*Document Version*  
Publisher's PDF, also known as Version of record

*Publication date:*  
1996

[Link to publication in University of Groningen/UMCG research database](#)

*Citation for published version (APA):*

Bryan, C. D., Cordes, A. W., Goddard, J. D., Haddon, R. C., Hicks, R. G., MacKinnon, C. D., ... Perel, A. S. (1996). Preparation and characterization of the disjoint diradical 4,4'-bis(1,2,3,5-dithiadiazolyl) [S<sub>2</sub>N<sub>2</sub>C-CN<sub>2</sub>S<sub>2</sub>] and its iodine charge transfer salt [S<sub>2</sub>N<sub>2</sub>C-CN<sub>2</sub>S<sub>2</sub>]. *Journal of the American Chemical Society*, 118(2), 330 - 338. <https://doi.org/10.1021/ja952144x>

**Copyright**

Other than for strictly personal use, it is not permitted to download or to forward/distribute the text or part of it without the consent of the author(s) and/or copyright holder(s), unless the work is under an open content license (like Creative Commons).

**Take-down policy**

If you believe that this document breaches copyright please contact us providing details, and we will remove access to the work immediately and investigate your claim.

*Downloaded from the University of Groningen/UMCG research database (Pure): <http://www.rug.nl/research/portal>. For technical reasons the number of authors shown on this cover page is limited to 10 maximum.*

# Preparation and Characterization of the Disjoint Diradical 4,4'-Bis(1,2,3,5-dithiadiazolyl) [S<sub>2</sub>N<sub>2</sub>C–CN<sub>2</sub>S<sub>2</sub>] and Its Iodine Charge Transfer Salt [S<sub>2</sub>N<sub>2</sub>C–CN<sub>2</sub>S<sub>2</sub>][I]

C. D. Bryan,<sup>1a</sup> A. W. Cordes,<sup>\*,1a</sup> J. D. Goddard,<sup>1b</sup> R. C. Haddon,<sup>\*,1c</sup> R. G. Hicks,<sup>1b</sup> C. D. MacKinnon,<sup>1b</sup> R. C. Mawhinney,<sup>1b</sup> R. T. Oakley,<sup>\*,1b</sup> T. T. M. Palstra,<sup>1c</sup> and A. S. Perel<sup>1c</sup>

Contribution from the Department of Chemistry and Biochemistry, University of Arkansas, Fayetteville, Arkansas 72701, Guelph-Waterloo Centre for Graduate Work in Chemistry, Department of Chemistry and Biochemistry, University of Guelph, Guelph, Ontario N1G 2W1, Canada, and AT&T Bell Laboratories, 600 Mountain Avenue, Murray Hill, New Jersey, 07974

Received June 29, 1995. Revised Manuscript Received November 7, 1995<sup>⊗</sup>

**Abstract:** Condensation of oxamidrazone with sulfur dichloride in acetonitrile affords 4,4'-bis(1,2,3,5-dithiadiazolium) dichloride in moderate yield. Reduction of this salt with triphenylantimony yields the diradical 4,4'-bis(1,2,3,5-dithiadiazolyl) [S<sub>2</sub>N<sub>2</sub>C–CN<sub>2</sub>S<sub>2</sub>], which has been isolated and characterized in the solid state as its dimer [S<sub>2</sub>N<sub>2</sub>C–CN<sub>2</sub>S<sub>2</sub>]<sub>2</sub>. The diradical is disjoint, and *ab initio* molecular orbital methods confirm a very small energy gap (<0.5 kcal/mol) between the triplet and diradical singlet states, regardless of the torsion angle about the central C–C bond. In accord with these theoretical predictions the ESR spectrum of the diradical consists (in CHCl<sub>3</sub> at 273 K) of a simple five-line pattern (*a*<sub>N</sub> = 0.50 mT, *g* = 2.011), i.e., there is no observable exchange coupling between the two centers. In the solid state, the dimer [S<sub>2</sub>N<sub>2</sub>C–CN<sub>2</sub>S<sub>2</sub>]<sub>2</sub> forms a slipped stack structure, with a mean intradimer S–S distance of 3.078 Å and mean interdimer S–S contact of 3.761 Å. Cosublimation of the diradical with iodine produces the charge-transfer salt [S<sub>2</sub>N<sub>2</sub>C–CN<sub>2</sub>S<sub>2</sub>][I], orthorhombic space group *Ccmm*, *a* = 11.909(3) Å, *b* = 3.271(2) Å, *c* = 19.860(6) Å, *Z* = 4 (at 293 K). In this structure the heterocyclic rings form perfectly superimposed and evenly spaced stacks along the *y* direction, with channels of disordered iodines. The iodine-doped material is metallic at ambient temperatures, with a single-crystal conductivity of 460 S cm<sup>-1</sup> at 300 K; variable temperature conductivity and magnetic measurements reveal a phase transition near 270 K, with the onset of semiconducting behavior. Transport data for the neutral and doped materials are discussed in the light of extended Hückel band calculations.

## Introduction

In the past decade the molecular and solid state properties of heterocyclic thiazyl radicals have been actively investigated.<sup>2</sup> We have concentrated our efforts on derivatives of the 1,2,3,5-dithiadiazolyl and -diselenadiazolyl ring systems **1** (E = S, Se),<sup>3</sup> with the intent of using these neutral  $\pi$ -radicals as templates for the design of low-dimensional (stacked) molecular conductors.<sup>4</sup> A wide variety of mono-,<sup>5</sup> di-,<sup>6</sup> and trifunctional<sup>7</sup> radicals have been prepared and characterized, and their solid state features have been probed with a combination of experimental and theoretical techniques. Several of the selenium variants have been found to be small band gap semiconductors (e.g., **2** and **3**, E = Se).<sup>6a,b</sup> Metallic behavior has yet to be observed in the neutral radicals, a consequence of the Peierls instability associated with a half-filled energy band. More recently we

have discovered that oxidation of dithiadiazolyl radicals, e.g., **1** (E = S; R = H, Ph), **2**, and **3**, with iodine affords stacked charge-transfer (CT) salts.<sup>8,9</sup> Doping of the radicals away from the half-filled energy band leads to improved transport proper-

(5) (a) Cordes, A. W.; Haddon, R. C.; Hicks, R. G.; Oakley, R. T.; Palstra, T. T. M. *Inorg. Chem.* **1992**, *31*, 1802. (b) Cordes, A. W.; Chamchouis, C. M.; Hicks, R. G.; Oakley, R. T.; Young, K. M.; Haddon, R. C. *Can. J. Chem.* **1992**, *70*, 919. (c) Davis, W. M.; Hicks, R. G.; Oakley, R. T.; Zhao, B.; Taylor, N. J. *Can. J. Chem.* **1993**, *71*, 180. (d) Cordes, A. W.; Glarum, S. H.; Haddon, R. C.; Hallford, R.; Hicks, R. G.; Kennepohl, D. K.; Oakley, R. T.; Palstra, T. T. M.; Scott, S. R. *J. Chem. Soc., Chem. Commun.* **1992**, 1265. (e) Cordes, A. W.; Bryan, C. D.; Davis, W. M.; DeLaat, R. H.; Glarum, S. H.; Goddard, J. D.; Haddon, R. C.; Hicks, R. G.; Kennepohl, D. K.; Oakley, R. T.; Scott, S. R.; Westwood, N. P. C. *J. Am. Chem. Soc.* **1993**, *115*, 7232.

(6) (a) Cordes, A. W.; Haddon, R. C.; Oakley, R. T.; Schneemeyer, L. F.; Waszczak, J. V.; Young, K. M.; Zimmerman, N. M. *J. Am. Chem. Soc.* **1991**, *113*, 582. (b) Andrews, M. P.; Cordes, A. W.; Douglass, D. C.; Fleming, R. M.; Glarum, S. H.; Haddon, R. C.; Marsh, P.; Oakley, R. T.; Palstra, T. T. M.; Schneemeyer, L. F.; Trucks, G. W.; Tycko, R.; Waszczak, J. V.; Young, K. M.; Zimmerman, N. M. *J. Am. Chem. Soc.* **1991**, *113*, 3559. (c) Cordes, A. W.; Haddon, R. C.; Hicks, R. G.; Kennepohl, D. K.; Oakley, R. T.; Palstra, T. T. M.; Schneemeyer, L. F.; Scott, S. R.; Waszczak, J. V. *Chem. Mater.* **1993**, *5*, 820.

(7) (a) Cordes, A. W.; Haddon, R. C.; Hicks, R. G.; Oakley, R. T.; Palstra, T. T. M.; Schneemeyer, L. F.; Waszczak, J. V. *J. Am. Chem. Soc.* **1992**, *114*, 5000. (b) Cordes, A. W.; Haddon, R. C.; Hicks, R. G.; Kennepohl, D. K.; Oakley, R. T.; Schneemeyer, L. F.; Waszczak, J. V. *Inorg. Chem.* **1993**, *32*, 1554.

(8) (a) Cordes, A. W.; Haddon, R. C.; Hicks, R. G.; Kennepohl, D. K.; MacKinnon, C. D.; Oakley, R. T.; Palstra, T. T. M.; Perel, A. S.; Scott, S. R.; Schneemeyer, L. F.; Waszczak, J. V. *J. Am. Chem. Soc.* **1994**, *116*, 1205. (b) Bryan, C. D.; Cordes, A. W.; Fleming, R. W.; George, N. A.; Glarum, S. H.; Haddon, R. C.; Oakley, R. T.; Palstra, T. T. M.; Perel, A. S.; Schneemeyer, L. F.; Waszczak, J. V. *Nature* **1993**, *365*, 821. (c) Bryan, C. D.; Cordes, A. W.; Haddon, R. C.; Hicks, R. G.; Oakley, R. T.; Palstra, T. T. M.; Perel, A. S.; Scott, S. R. *Chem. Mater.* **1994**, *6*, 508.

<sup>⊗</sup> Abstract published in *Advance ACS Abstracts*, December 15, 1995.

(1) (a) University of Arkansas. (b) University of Guelph. (c) AT&T Bell Laboratories.

(2) (a) Scherer, O. J.; Wolmershäuser, G.; Jotter, R. *Z. Naturforsch.* **1982**, *87b*, 432. (b) Wolmershäuser, G.; Schnauber, M.; Wilhelm, T. *J. Chem. Soc., Chem. Commun.* **1984**, 573. (c) Dormann, E.; Nowak, M. J.; Williams, K. A.; Angus, R. O.; Wudl, F. *J. Am. Chem. Soc.* **1987**, *109*, 2594. (d) Wolmershäuser, G.; Wortmann, G.; Schnauber, M. *J. Chem. Res., Synop.* **1988**, 358. (e) Banister, A. J.; Rawson, J. M. In *The Chemistry of Inorganic Ring Systems*; Steudel, R., Ed.; Elsevier: Amsterdam, 1992; p 323. (f) Parsons, S.; Passmore, J. *Acc. Chem. Res.* **1994**, *27*, 101. (g) Preston, K. F.; Sutcliffe, L. H. *Magn. Reson. Chem.* **1990**, *28*, 189.

(3) Cordes, A. W.; Haddon, R. C.; Oakley, R. T. In *The Chemistry of Inorganic Ring Systems*; Steudel, R., Ed.; Elsevier: Amsterdam, 1992; p 295.

(4) (a) Haddon, R. C. *Nature (London)* **1975**, *256*, 394. (b) Haddon, R. C. *Aust. J. Chem.* **1975**, *28*, 2343.

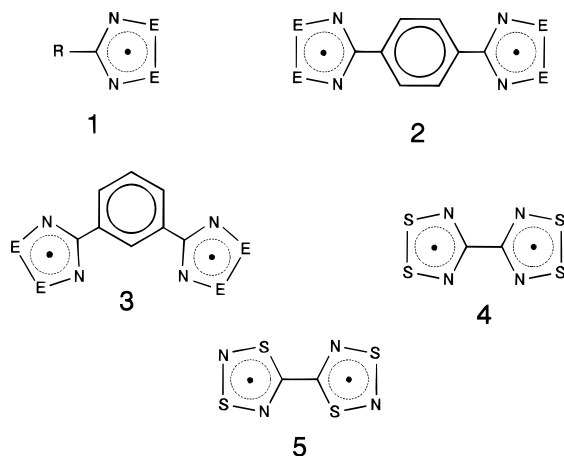

ties, and in some cases, room-temperature metallic conductivity has been observed. However, like the neutral materials, these CT salts are susceptible to charge density wave (CDW)-driven instabilities, and all the conductive materials studied to date fall into insulating states at low temperatures.

Suppression of charge density waves in the stacked structures, to afford a metallic ground state, requires the design of materials with more two- and three-dimensional electronic structures. At the simplest level of theory the dimensionality of the electronic structure and consequent transport properties are directly related to both intra- and interstack overlap. Extended Hückel band calculations have shown that crystal orbital dispersion along the stacking direction is considerable. Lateral, interstack overlap is, by comparison, considerably weaker but has been shown to have important effects on the properties of the neutral radicals by influencing (i) the magnitude of the band gap in the undoped materials<sup>5c</sup> and (ii) the stability of the metallic state in the doped compounds.<sup>9</sup> On the basis of previous structure–property correlations, interstack overlap can be enhanced in derivatives bearing very small R groups in the 4-position of the heterocyclic ring. In this context the directly linked diradical **4** has been a synthetic target for some time. The isomeric 1,3,2,4-dithiadiazolyl diradical **5** has been isolated but, to date, no structural information has been reported.<sup>10</sup> The difficulties encountered with this latter material may be a consequence of the known tendency of the 1,3,2,4-dithiadiazolyls to isomerize to the more stable 1,2,3,5-isomers.<sup>11</sup> In addition to displaying potentially strong multidimensional interactions in the solid state, diradical **4** itself also provides an intriguing opportunity to study the extent of intramolecular electronic (exchange) effects arising from the presence of two directly linked radical units. A preliminary report of the synthesis and structure of **4** has been published.<sup>12</sup> In this paper we present the results of both theoretical and experimental investigations on the molecular and solid state properties of the diradical **4**, as well as the preparation and solid state properties of the highly conducting charge-transfer salt [**4**][I] formed by the reaction of the diradical with iodine.

## Results and Discussion

**Synthesis.** The most versatile synthetic route to the dithia- and diselenadiazolyl rings involves condensation of a persilylated amidine with sulfur or selenium dichloride (eq 1; E = S, Se). The amidines are prepared by the “Sanger” reaction, i.e., nucleophilic addition of lithium bis(trimethylsilyl)amide to a nitrile followed by transmetalation with  $Me_3SiCl$ .<sup>13,14</sup> Initial attempts to synthesize diradical **4** followed this approach. However, the addition of  $LiN(SiMe_3)_2$  to cyanogen did not proceed to give the expected persilylated oxamidine—instead the major product was *N,N'*-bis(trimethylsilyl)carbodiimide. Apparently the lithium amide reacts *via* substitution rather than addition to give lithium cyanide and cyanobis(trimethylsilyl)amine, which then tautomerizes to its more stable symmetric isomer, the carbodiimide (eq 2).<sup>15</sup>

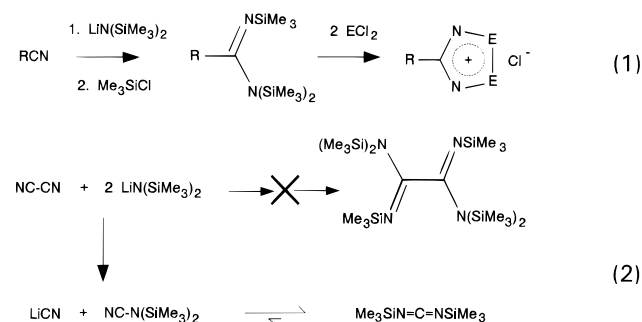

Subsequent synthetic efforts focused on the unsubstituted oxamidine. A wide variety of *N*-substituted oxamidines are known but conspicuously absent from this list is the unsubstituted prototypal derivative.<sup>16</sup> We first attempted to generate oxamidine *via* the Pinner methodology (eq 3).<sup>17</sup> The reaction of diethyl oximidate<sup>18</sup> with a mixture of ammonium chloride and ammonia gas afforded impure oxamidine dihydrochloride (identified by mass spectrometry) that was contaminated with small amounts of ammonium salts. Surprisingly, however, this compound did not react with sulfur dichloride at room temperature, and heating the reaction mixture only caused extensive decomposition.

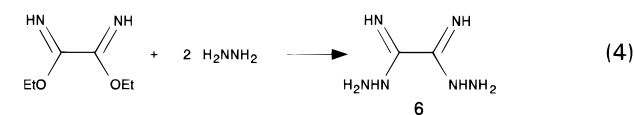
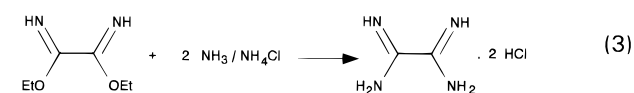

In view of the difficulties encountered in preparing the dication of **4** from either a persilylated or unsubstituted oxamidine, we sought other potential precursors. The compound *N,N'*-diaminoxamidine, or “oxamidrazone” (**6**) was identified

(13) Boeré, R. T.; Oakley, R. T.; Reed, R. W. *J. Organomet. Chem.* **1987**, *331*, 161.

(14) Edelman, F. T. *Coord. Chem. Rev.* **1995**, *137*, 403.

(15) Gordestov, A. S.; Vostokov, V. P.; Sheludyalkova, S. V.; Dergunov, Y. I.; Mironov, V. F. *Russ. Chem. Rev.* **1982**, *51*, 485.

(16) One claim has been made for the preparation of oxamidine as its phosphate salt [Ito, M. *Chem. Abstr.* **1973**, *78*, 57800a], but in our hands, the reaction of cyanogen with ammonia and phosphoric acid was unsuccessful.

(17) Gautier, J. A.; Miocque, M.; Farnoux, C. C. In *The Chemistry of Amidines and Imidates*; Patai, S., Ed.; John Wiley & Sons: London, 1975; pp 283–348 and references cited therein.

(18) Diethyl oximidate has been prepared using a modified literature procedure (see the Experimental Section): Behun, J. D. *Chem. Abstr.* **1961**, *60*, 5342c,d.

(9) Bryan, C. D.; Cordes, A. W.; Fleming, R. M.; George, N. A.; Glarum, S. H.; Haddon, R. C.; Oakley, R. T.; Palstra, T. T. M.; Perel, A. S. *J. Am. Chem. Soc.* **1995**, *117*, 6880.

(10) (a) Parsons, S.; Passmore, J.; Schriver, M. J.; White, P. S. *J. Chem. Soc., Chem. Commun.* **1991**, 369. (b) Parsons, S.; Passmore, J.; White, P. S. *J. Chem. Soc., Dalton Trans.* **1993**, 1499.

(11) (a) Burford, N.; Passmore, J.; Schriver, M. J. *J. Chem. Soc., Chem. Commun.* **1986**, 140. (b) Aherne, C.; Banister, A. J.; Luke, A. W.; Rawson, J. M.; Whitehead, R. J. *J. Chem. Soc., Dalton Trans.* **1992**, 1277. (c) Passmore, J.; Sun, X. *Inorg. Chem.*, in press.

(12) Bryan, C. D.; Cordes, A. W.; Haddon, R. C.; Hicks, R. G.; Oakley, R. T.; Palstra, T. T. M.; Perel, A. S. *J. Chem. Soc., Chem. Commun.* **1994**, 1447.

## Scheme 1

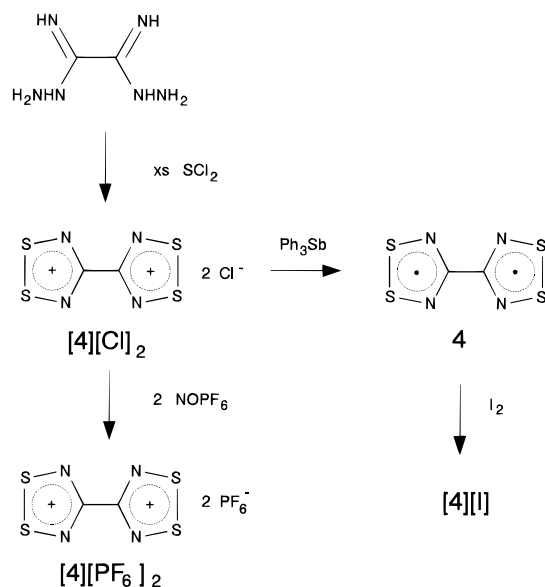

as a promising candidate. It possessed the necessary  $\text{C}_2\text{N}_4$  central core and also had reactive N–N bonds which might be cleaved under oxidizing conditions, e.g., reaction with  $\text{SCl}_2$ .<sup>19</sup> Oxamidrazone has traditionally been prepared by addition of hydrazine to cyanogen,<sup>20</sup> but we have found that the reaction of diethyl oximidate with 2 mol equiv of anhydrous hydrazine in hot ethanol provides a much easier route (eq 4). To our great satisfaction we then discovered that the dication of **4** could be synthesized by the reaction of oxamidrazone **6** with  $\text{SCl}_2$  (Scheme 1); addition of an excess of  $\text{SCl}_2$  to **6** in acetonitrile thus afforded  $[\text{4}][\text{Cl}]_2$  in 16% yield.<sup>21</sup> The dication was isolated in pure form by metathesis of the crude dichloride with  $\text{NOPF}_6$  to yield the hexafluorophosphate salt  $[\text{4}][\text{PF}_6]_2$ . Reduction of the dichloride by well-established procedures (triphenylantimony in refluxing acetonitrile) produced the dimer  $[\text{4}]_2$ , which was purified by vacuum sublimation at  $140^\circ\text{C}/10^{-2}$  Torr in a gradient tube furnace to afford blue/black needles in 52% yield.

Oxidative doping of **4** with iodine was effected with the cosublimation strategy used in the preparation of other doped dithiadiazolyls (e.g., **1**, R = H, Ph; **2**, E = S).<sup>8,9</sup> Thus, heating a 1:1 mixture of iodine and diradical **4** in an evacuated tube along a carefully monitored temperature gradient from 150 to  $110^\circ\text{C}$  afforded lustrous black crystalline needles of the CT salt  $[\text{4}][\text{I}]$  (Scheme 1).

**Crystal Structures.** Details of the crystal structure solution of  $[\text{4}]_2$  were reported in an earlier communication.<sup>12</sup> The structure is monoclinic, space group  $P2_1/c$ , with  $a = 6.7623(17)$  Å,  $b = 11.5180(8)$  Å,  $c = 8.3834(14)$  Å,  $\beta = 110.20(2)^\circ$ ,  $Z = 4$  (at 293 K) and consists of cofacial diradical dimers as the structural building block. The dimers form stacks parallel to the  $x$  axis, with neighboring dimers within the stacks translated parallel to the central C–C bond vector, producing stacks that are skewed by approximately  $18^\circ$  (as determined by the mean S–S–S bond angles). The packing of dimeric stacks produces a herringbone-like motif in the  $yz$  plane (Figure 1). The intradimer S–S distances (mean value 3.078 Å) and interdimer

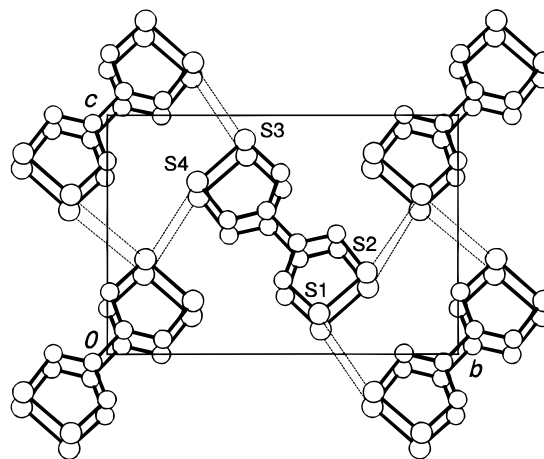

Figure 1. Packing of  $[\text{4}]_2$  in the  $yz$  plane.

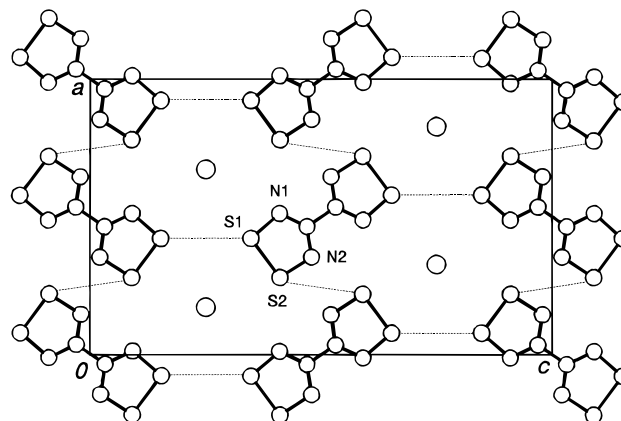

Figure 2. Packing of  $[\text{4}][\text{I}]$  in the  $xz$  plane. Intermolecular contacts are defined in the text.

S–S distances (mean value 3.761 Å) are comparable to those found in the parent monofunctional dithiadiazolyl **1** (E = S, R = H).<sup>5e,8a</sup> Neighboring stacks are slightly out-of-register and closely packed, producing a very tight web of interstack contacts (see Figure 1). These distances were defined in our earlier communication.<sup>12</sup>

Crystals of  $[\text{4}][\text{I}]$  belong to orthorhombic space group  $Ccmm$ ,<sup>22</sup>  $a = 11.909(3)$  Å,  $b = 3.271(2)$  Å,  $c = 19.860(6)$  Å,  $Z = 4$  (at 293 K). Molecules of **4** in  $[\text{4}][\text{I}]$  lie on a mirror plane and are centrosymmetric. The crystal structure consists of columns perfectly superimposed and regularly spaced molecules of **4** (as opposed to dimers) interspersed by columns of iodines, with a herringbone packing motif (Figure 2) qualitatively similar to that found for the iodine-doped diradical  $[\text{3}][\text{I}]$  (E = S) rather than the linear ribbons found in  $[\text{2}][\text{I}]$ . At 3.271(3) Å, the interannular repeat along the  $y$  direction is considerably closer than the interplanar separations in  $[\text{2}][\text{I}]$  (3.415(2) Å) and  $[\text{3}][\text{I}]$  (3.487(3) Å). The closer spacing in the present case could arise from the absence of an intervening benzene ring (present in  $[\text{2}][\text{I}]$  and  $[\text{3}][\text{I}]$ ), which would tend to impose an interannular separation near the graphite value of 3.35–3.37 Å.<sup>23</sup> The crystal symmetry requires that molecules within alternate stacks centered at, for example  $x = 0, 0.5, 1, 1.5$ , etc.; neighboring stacks are thus out-of-register. As observed in  $[\text{2}][\text{I}]$  and  $[\text{3}][\text{I}]$ , the iodines are disordered. The disorder model used places the dominant fractional iodine

(19) The oxidative cleavage of N–N bonds by sulfur dichloride as a route to SN-containing heterocycles has been used elsewhere. (a) Bestari, K. T.; Cordes, A. W.; Oakley, R. T. *J. Chem. Soc., Chem. Commun.* **1988**, 1328. (b) Roesky, H. W.; Müller, T. *Chem. Ber.* **1978**, *111*, 2960.

(20) Hergenrother, P. M. *J. Macromol. Sci.* **1973**, *A7*, 573.

(21) This reaction is in contrast to the condensation of  $\text{SCl}_2$  with oxamidoxime, which gives the fused ring compound bis(thiadiazole). See: Komin, A. P.; Street, R. W.; Carmack, M. *J. Org. Chem.* **1975**, *40*, 2749.

(22)  $Ccmm$  is a nonstandard setting of  $Cmcm$ ; in  $Cmcm$  the  $a$  and  $b$  cell dimensions would interchange.

(23) Laves, F.; Baskin, Y. Z. *Kristallogr.; Kristallgeom., Kristallphys., Kristallchem.* **1956**, *107*, 337.

**Table 1.** Mean Observed Intramolecular Distances (Å) in  $[4]_2$  and  $[4][I]$ 

	$[4]_2$	$[4][I]$
S-S	2.088(2)	2.088(11)
S-N	1.630(5)	1.628(12)
N-C	1.331(7)	1.335(16)
C-C	1.488(7)	1.473(24)

centers in the plane of its two nearest neighbor rings, in a pattern reminiscent of that found for  $[2][I]$  and  $[3][I]$ .<sup>24</sup>

A comparison of the internal structural distances with those of the undoped diradical dimer  $[4]_2$  are presented in Table 1. It is noteworthy that no significant differences are observed between the intramolecular S-S and S-N distances in the two structures. Typically, such changes are related to degree of CT by virtue of the fact that the SOMO, a strongly antibonding distribution over the S-S and S-N linkages, is unoccupied in the cationic state and filled in the neutral (radical) state.<sup>5e</sup> Thus the lack of structural differences between  $[4]_2$  and  $[4][I]$  is in contrast to those noted between **2** and **3** and their iodine CT salts<sup>9</sup> and suggests a significantly smaller degree of charge transfer from radical to iodine in the present case. The relatively short close cell repeat (see above) in comparison to those observed in  $[2][I]$  and  $[3][I]$  also points to smaller degree of charge transfer in the present system. Infrared spectroscopy provides further substantiation of this conclusion. On the basis of previous work,<sup>5e</sup> the band at  $543\text{ cm}^{-1}$  in  $[4][Cl]_2$  can be assigned to an intramolecular S-S vibration. As expected this shifts and splits into two bands at  $495$  and  $507\text{ cm}^{-1}$  in the dimer  $[4]_2$ . The IR spectrum of  $[4][I]$ , however, is severely weakened by scattering (the compound is conductive); there is, nonetheless, a weak line at  $508\text{ cm}^{-1}$  which may correspond to the intramolecular S-S stretching mode. If this assignment is correct, then the near equality of frequencies observed for  $[4]_2$  and  $[4][I]$  also support a very low degree of charge transfer from **4** to iodine.<sup>25</sup> We cannot, however, go much further than to provide these qualitative assessments of the degree of charge transfer. For  $[2][I]$  we were able to identify the low-temperature superlattice by X-ray diffraction and, hence, assign the degree of charge transfer as  $[2]^{+0.5}[I]^{-0.5}$ . In the case of  $[4][I]$  we have been unable to observe the CDW-driven superlattice formation by low-temperature crystallography, although clearly the magnetic and conductivity measurements (*vide infra*) signal its onset.

On the basis of the number and magnitude of the lateral interannular S-S contacts, the structure appears to be highly one-dimensional. The closest contact, which is well outside of the standard van der Waals separation<sup>26</sup> for two sulfurs ( $3.60\text{ Å}$ ), is the S1-S1' contact that spans adjacent heads across the bridging iodine channels (see Figure 2). The only other contact under  $4\text{ Å}$  is the lateral S2-S2' contact ( $3.985\text{ Å}$ ).

**Electronic Structure of 4.** Diradical **4** is a rare example of a disjoint diradical, i.e., one in which the molecular orbitals for

(24) For more general discussions of charge transfer in iodine containing low-dimensional conductors, see: (a) Coppens, P. In *Extended Linear Chain Compounds*; Miller, J. S., Ed.; Plenum Press: New York, 1982; pp 333-356. (b) Marks, T. J.; Kalina, D. W. In *Extended Linear Chain Compounds*; Miller, J. S., Ed.; Plenum Press: New York, 1982; pps 197-331. (c) Kertész, M.; Vonderviszt, F. *J. Am. Chem. Soc.* **1982**, *104*, 5889.

(25) We have also recorded the FT Raman spectra of  $[4]_2$  and  $[4][I]$  and have encountered interpretational difficulties very similar to those observed with  $[HCN_2S_2]$  and  $[HCN_2S_2][I]_{1.1}$  (see ref 8a).  $[4][I]$  fluoresces very strongly and exhibits only a single, very broad band near  $93\text{ cm}^{-1}$ . This could be attributed to an  $I_n^-$  species and some assignment made on the basis of past experience (ref 24a,b). However, in  $[4]_2$ , there are no less than three bands in this region (at  $182$ ,  $135$ , and  $85\text{ cm}^{-1}$ ). These correspond to interannular (interplate) S-S modes. We cannot therefore assign the observed band(s) in  $[4][I]$  (and hence provide some clue as to the nature of the  $I_n^-$  species) because we cannot identify them as I-I or S-S (or even S-I) modes.

(26) Bondi, A. *J. Phys. Chem.* **1964**, *68*, 441.

the two unpaired electrons can be localized to separate groups of atoms.<sup>27</sup> The two singly occupied molecular orbitals (SOMOs) are linear combinations of the localized orbitals **7** (a and b). These can be compared with those of the well-known tetramethyleneethane (TME) diradical, i.e., **8** (a and b).<sup>28-30</sup>

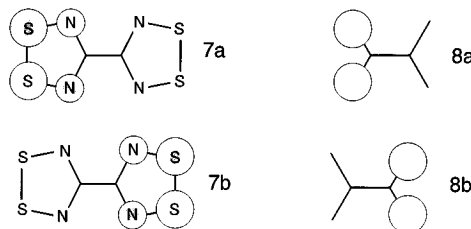

Since these localized orbitals are symmetry equivalent, the configurations of the four possible states arising can be described using the  $(a + b)$  and  $(a - b)$  combinations as<sup>31</sup>

diradical triplet	$^3(a + b)(a - b)$
diradical singlet	$^1(a + b)^2 - ^1(a - b)^2$
out-of-phase zwitterionic singlet	$^1(a + b)(a - b)$
in-phase zwitterionic singlet	$^1(a + b)^2 + ^1(a - b)^2$

For disjoint diradicals exchange interactions between the two centers are small, and the diradical triplet and singlet states which arise are essentially degenerate (as are the two zwitterionic states). Recent calculations on TME suggest the diradical triplet is lower in energy, by  $1.0$ – $1.5\text{ kcal mol}^{-1}$ , than the diradical singlet.<sup>32</sup>

In order to probe the energetic differences between the two diradical states possible for **4**, we have carried out a series of *ab initio* molecular orbital calculations.<sup>33</sup> The predicted bond lengths for the planar and perpendicular forms of **4** as well as the dimer can be found in Table 2. Full details of all geometries are provided in the supporting information. Comparison of the geometries corresponding to the diradical triplet and singlet states reveals that they are structurally very similar. This is a direct result of the nature of the two nearly degenerate SOMOs  $[(a + b)$  and  $(a - b)]$ . They are both C-C nonbonding and S-S and S-N antibonding, and so single occupation of both, or double occupation of only one, leads to little change in geometry. For both states the lack of interaction between the carbons is also manifested by the absence of any torsional preference (rotation angle  $\tau$  about the C-C bond); the geometries of planar ( $\tau = 0^\circ$ ) and perpendicular ( $\tau = 90^\circ$ ) structures differ by no more  $0.006\text{ Å}$  in any bond length and less than  $1^\circ$  in any bond angle. Rotation about the C-C bond is also relatively unhindered; the diradical singlet exhibits a barrier of *ca.*  $0.2\text{ kcal mol}^{-1}$ . The triplet, on the other hand, is found to have a minimum at  $\tau = 43.5^\circ$  which is  $0.59\text{ kcal mol}^{-1}$  more stable than either the planar or perpendicular minima. The

(27) (a) Borden, W. T.; Davidson, E. R. *J. Am. Chem. Soc.* **1977**, *99*, 4587. (b) Pranata, J. *J. Am. Chem. Soc.* **1992**, *114*, 10537. (c) Rajca, A. *Chem. Rev.* **1994**, *94*, 871.

(28) (a) Dowd, P.; Chang, W.; Paik, Y. H. *J. Am. Chem. Soc.* **1986**, *108*, 7416. (b) Dowd, P.; Chang, W.; Paik, Y. H. *J. Am. Chem. Soc.* **1987**, *109*, 5284.

(29) Du, P.; Borden, W. T. *J. Am. Chem. Soc.* **1987**, *109*, 930.

(30) Borden, W. T. In *Diradicals*; Borden, W. T., Ed.; J. Wiley and Sons: New York, 1982; p 24.

(31) (a) Salem, L. *Electrons in Chemical Reactions; First Principles*; Wiley Interscience: Chichester, U.K., 1982; Chapter 3. (b) Salem, L.; Rowland, C. *Angew. Chem., Int. Ed. Engl.* **1972**, *11*, 92.

(32) Nachtigall, P.; Jordan, K. D. *J. Am. Chem. Soc.* **1993**, *115*, 270.

(33) Using SCF methods we have also examined briefly one (the out-of-phase) combination of the two higher-lying zwitterionic singlet states and established that it lies much higher in energy than the diradicals. The in-phase zwitterionic singlet was not examined in any detail. A smaller basis set configuration interaction calculation placed it an energy similar to that of the out-of-phase zwitterionic singlet, as expected.

**Table 2.** Calculated bond distances (Å) for **4** and **[4]<sub>2</sub>**

	S-S	S-N	N-C	C-C
Planar ( $\tau = 0^\circ$ ) Triplet ( $D_{2h}$ )				
CEP-31G*	2.075	1.641	1.322	1.520
6-31G*	2.067	1.632	1.311	1.499
6-311G*	2.081	1.628	1.309	1.502
Planar ( $\tau = 0^\circ$ ) Open Shell Singlet ( $D_{2h}$ )				
CEP-31G*	2.075	1.641	1.322	1.518
6-31G*	2.067	1.632	1.310	1.497
6-311G*	2.082	1.629	1.309	1.500
Twisted ( $\tau = 90^\circ$ ) Triplet ( $D_{2d}$ )				
CEP-31G*	2.071	1.646	1.320	1.515
6-31G*	2.062	1.636	1.309	1.497
6-311G*	2.077	1.633	1.307	1.498
Twisted ( $\tau = 90^\circ$ ) Open Shell Singlet ( $D_{2d}$ )				
CEP-31G*	2.072	1.646	1.320	1.513
6-31G*	2.063	1.637	1.309	1.495
6-311G*	2.077	1.633	1.307	1.496
Closed Shell Singlet Dimer ( $D_{2h}$ )				
CEP-31G*	2.061	1.635	1.323	1.517
6-31G*	2.054	1.624	1.312	1.499
6-311G*	2.065	1.621	1.310	1.501

**Table 3.** Relative Energies (kcal mol<sup>-1</sup>) of Planar ( $\tau = 0^\circ$ ) and Twisted ( $\tau = 90^\circ$ ) **4**

state, $\tau$	CEP-31G*	6-31G*	6-311G*
singlet, 0°	0.53	0.00 <sup>a</sup>	0.00 <sup>a</sup>
singlet, 90°	0.00 <sup>a</sup>	0.28	0.03
triplet, 0°	1.03	0.46	0.50
triplet, 90°	0.54	0.77	0.58

<sup>a</sup> CEP-31G\*, -89.302 980; 6-31G\*, -1883.420 043; 6-311G\*, -1883.580 500.

energy difference between the triplet and diradical singlet states, as displayed for various levels of theory in Table 3, is very small. The planar diradical singlet is lowest in energy, with the corresponding triplet only very slightly higher in energy (ca. 0.5 kcal mol<sup>-1</sup>); allowance for torsion brings the two states even closer in energy.

Dimerization of the diradical, and consequent full orbital occupancy, effects only slight internal structural changes. By comparing the predicted bond lengths (Table 2) with those from the X-ray data (Table 1), we see that the isolated dimer treated theoretically has slightly shorter S-S, S-N, and N-C bonds, with the most noticeable contraction being in the N-C distance. By contrast the calculated C-C bonds are slightly longer. The intermolecular S-S distance is predicted to be 3.096 Å at the 6-311G\* SCF level, which is consistent with the experimental data (mean value 3.078 Å). These findings mirror the previously found results for the prototypal radical [HCN<sub>2</sub>S<sub>2</sub>] (**1**, E = S, R = H) system and its dimer.<sup>5c</sup> Investigation of the binding energies show that the dimer is unbound at the SCF level with respect to two triplet diradicals. However, with the inclusion of electron correlation (via MP2), it is bound by about 17 kcal mol<sup>-1</sup> relative to the triplet monomers. As seen in the prototypal system,<sup>5c</sup> the binding energy is probably overestimated at the MP2 level and would be expected to decrease somewhat at higher levels of Møller-Plesset theory.

**Cyclic Voltammetry and ESR Spectra.** The electronic structure of dithiadiazolyls **1** can be described in terms of a singly occupied molecular orbital (SOMO) that is nodal at carbon. The near invariance of many physical properties, e.g., ionization potentials and ESR hyperfine coupling constants, to the nature of the R group in the 4-position can be understood in that light.<sup>34</sup> Recent cyclic voltammetric (CV) studies on a series of monofunctional derivatives have led to similar

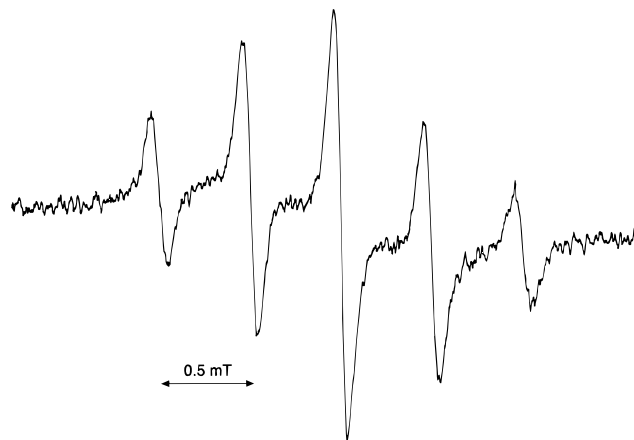
**Figure 3.** ESR spectrum of **[4]** at 273 K (in CHCl<sub>3</sub>).

interpretations and have established that both reduction and oxidation of the radicals are electrochemically reversible.<sup>35</sup> However, observation of a reversible reduction wave requires that the experiment be performed on the radical itself rather than its oxidized counterpart, i.e., the dithiadiazolium cation. If the latter is used, the reduction is irreversible, as the anion so formed reacts rapidly with excess cation in the bulk solution.

The low solubility of the dimer **[4]<sub>2</sub>** in organic media has prevented us from carrying out electrochemical measurements on the diradical itself. In seeking electrochemical data on **4** we have therefore been restricted to CV experiments on **[4]<sup>2+</sup>** (as its PF<sub>6</sub><sup>-</sup> salt in acetonitrile). The CV waves for this system are very similar in position and shape to those recently reported for the benzene-bridged dication **[2]<sup>2+</sup>** and **[3]<sup>2+</sup>**,<sup>36</sup> i.e., a reversible cation/radical wave at 0.68 V (*vs* SCE) and an irreversible radical/anion wave near -0.80 V (*vs* SCE). Analysis of the dication/diradical wave revealed a peak-to-peak separation (98 mV) slightly larger than those observed for the benzene-bridged species. This may be simply a concentration effect or may indicate two slightly interacting one-electron transfers rather than a single two-electron step.<sup>37</sup> In accord with the electrochemical work, and the conclusions of the *ab initio* studies described above, the ESR spectrum of **4** indicates virtually no exchange interactions between the two radical sites.<sup>38,39</sup> At 273 K (in CHCl<sub>3</sub>) a simple five-line pattern with  $g = 2.011$  and  $a_N = 0.50$  mT is observed (Figure 3). At 303 K there is a slight broadening of the spectrum and the incipient appearance of features associated with the onset of exchange coupling. This slight temperature dependence may be associated with subtle variations in the magnitude of exchange coupling with torsional motion about the C-C bond, although the theoretical results described above suggest that such changes would be small. In our previous studies on the ESR spectra of

(34) (a) Boeré, R. T.; Oakley, R. T.; Reed, R. W.; Westwood, N. P. C. *J. Am. Chem. Soc.* **1989**, *111*, 1180. (b) Cordes, A. W.; Goddard, J. D.; Oakley, R. T.; Westwood, N. P. C. *J. Am. Chem. Soc.* **1989**, *111*, 6147.

(35) (a) Boeré, R. T.; Moock, K.; Parvez, M. Z. *Anorg. Allg. Chem.* **1994**, *620*, 1589. (b) Aberne, C. M.; Banister, A. J.; Gorrell, I. B.; Hansford, M. I. Hauptman, Z. V.; Luke, A. W.; Rawson, J. M. *J. Chem. Soc., Dalton Trans.* **1993**, 976.

(36) Boeré, R. T.; Moock, K. H. *J. Am. Chem. Soc.* **1995**, *117*, 4755.

(37) (b) Polcyn, D. S.; Shain, I. *Anal. Chem.* **1966**, *38*, 370. (b) Ammar, F.; Savéant, J. M. *J. Electroanal. Chem.* **1973**, *47*, 215. (c) Bard, A. J.; Faulkner, L. R. In *Electrochemical Methods*; John Wiley and Sons: New York, 1980; p 232.

(38) (a) Weil, J. A.; Bolton, J. R.; Wertz, J. E. In *Electron Paramagnetic Resonance*; John Wiley and Sons: New York, 1993; Section 6.4. (b) Glarum, S. H.; Marshall, J. H. *J. Chem. Phys.* **1967**, *47*, 1374. (c) Brière, R.; Dupuyre, R. M.; Lemaire, H.; Morat, C.; Rassat, A.; Rey, P. *Bull. Soc. Chim. Fr.* **1965**, 3290.

(39) Bencini, A.; Gatteschi, D. In *EPR of Exchange Coupled Systems*; Springer-Verlag: New York, 1990; p 187.

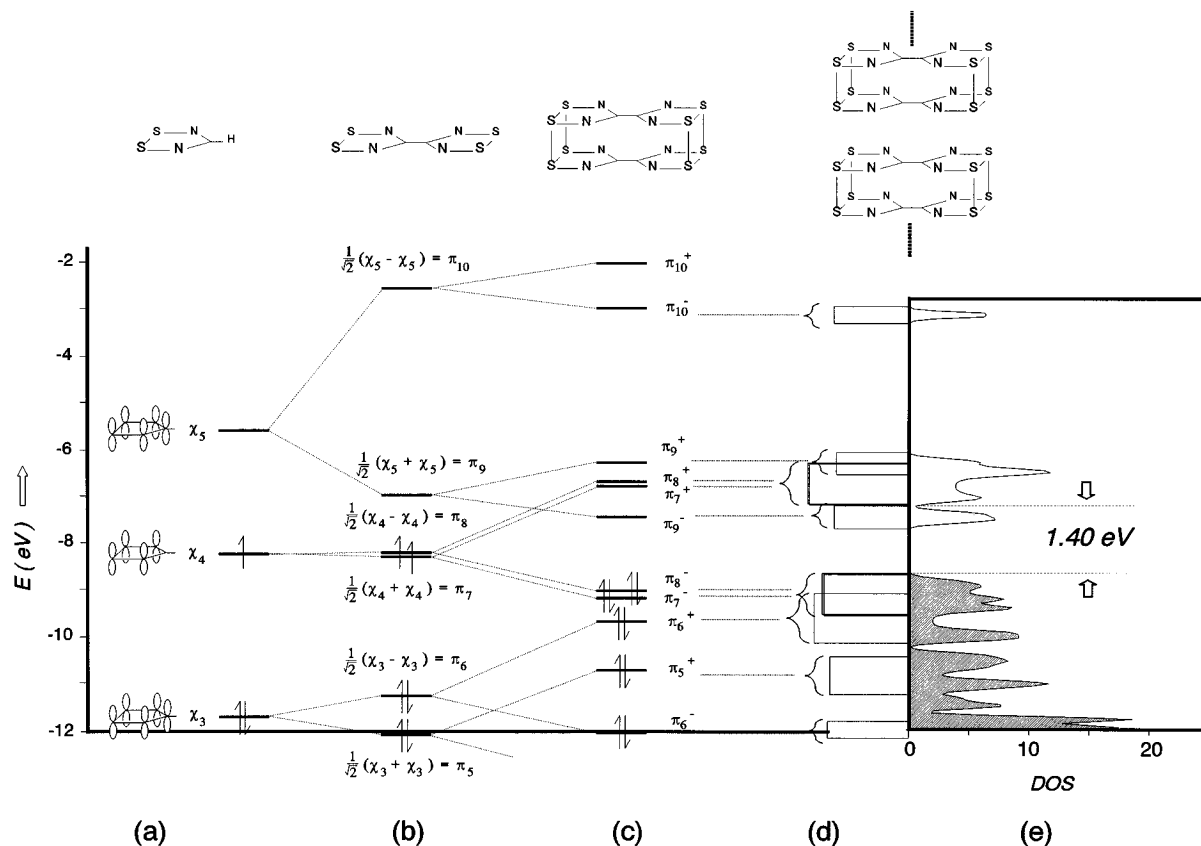

**Figure 4.** Evolution of frontier  $\pi$ -orbitals (EHMO) of **1** ( $R = H$ ) (a) to those of **4** (b) and  $[4]_2$  (isolated) (c) to the block band structure (d) of a single stack of  $[4]_2$  set at the observed spacing in the crystal structure. The band gap in the density of states (DOS, states/eV·cell) diagram (e) corresponds to the smallest  $(\pi_7/\pi_8)^+ - (\pi_7/\pi_8)^-$  difference.

**2** and **3** we noted stronger exchange interactions;<sup>6a,b</sup> indeed at 60 °C the spectrum was near the limiting case for which  $J_{ex} > a_N$ . The more extensive coupling observed for these latter systems presumably arises from the ability of the benzene bridge, particularly in the 1,3-substituted derivative, to mediate coupling.

**Band Structure Calculations.** In our previous studies on dithiadiazolyl-based materials we have tried to link solid state structure to transport properties by means of Extended Hückel band structure calculations. Our intent has been to interpret the degree of crystal orbital dispersion parallel and perpendicular to the stacking direction and to correlate this dispersion with the calculated valence-to-conduction band gap.<sup>40</sup> The present system proved more complicated than was originally anticipated, as the Extended Hückel method leads to a misordering of levels in the band gap region. The origin of this difficulty is illustrated in Figure 4, which shows the evolution of the  $\pi$ -orbital manifold of a single dithiadiazolyl radical **1** into the molecular orbitals of the diradical **4**, its dimer  $[4]_2$ , and the final density of states (DOS) for a one-dimensional stack of dimers. The progress of the radical SOMO ( $\chi_4$ ) through to the valence and conduction bands can be easily monitored in this diagram. Note, however, that the next highest  $\pi$ -orbital,  $\chi_5$ , is sharply split in the diradical and a component of this interaction,  $\pi_9^-$ , tracks across and crosses into the normal valence band region. On the basis of our *ab initio* calculations, we know that this occurrence is an artifact of the Extended Hückel method; the states arising from  $\pi_9$  are, in reality, much higher lying.<sup>41</sup> In contrast to the simple picture in Figure 4 the dimer  $[4]_2$  is predicted, at the *ab initio*

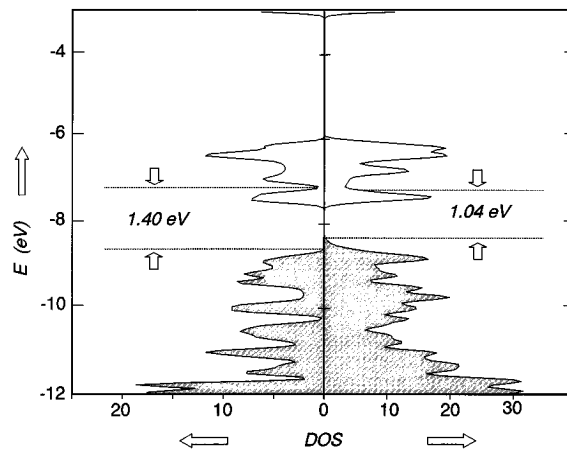
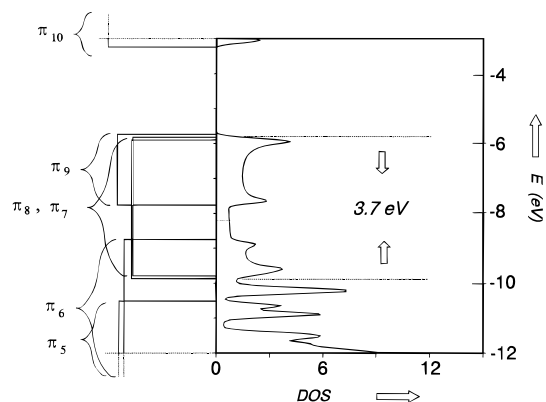

**Figure 5.** Density of states (DOS, states/(eV·cell)) for a one-dimensional stack of  $[4]_2$  (left) and the full three-dimensional structure (right). The band gaps specified correspond to the smallest  $(\pi_7/\pi_8)^+ - (\pi_7/\pi_8)^-$  difference.

level, to have  $\pi_9^-$  as LUMO+3. If we take this factor into account and assume that the band arising from the  $\pi_9^-$  orbitals should be at higher energy than the EHMO results indicate, then the calculated band gap, i.e., the  $(\pi_7/\pi_8)^+$  to  $(\pi_7/\pi_8)^-$  difference, for the one-dimensional structure is 1.40 eV. Figure 5 compares the DOS for a one-dimensional stack with that of the full three-dimensional structure. Band spreading in the latter, as a result of lateral interactions, is clearly quite pronounced. If we again use the  $(\pi_7/\pi_8)^+$  to  $(\pi_7/\pi_8)^-$  difference, as outlined

(40) Strictly speaking, such an approach requires that the unit cell vectors be orthogonal. For structures in which this does not hold, the argument is only of qualitative value.

(41) The problem stems from the use (in the band calculations) of a double- $\zeta$  basis set, which slightly overemphasizes the internal C–C overlap and, hence, the orbital splitting between  $\pi_9$  and  $\pi_{10}$  (Figure 4). We know explicitly from our *ab initio* work on  $[4]_2$  that the occupied states associated with  $\pi_9$  are, in reality, more high lying than the EHMO method suggests.



**Figure 6.** Density of states (DOS, states/(eV·cell)) for a one-dimensional stack of **[4]** in **[4][I]**. The energy difference specified corresponds to the  $\pi_7/\pi_8$  bandwidth. The hatched line at  $-8.2$  eV is included for reference purposes only; it corresponds to the Fermi level for zero charge transfer.

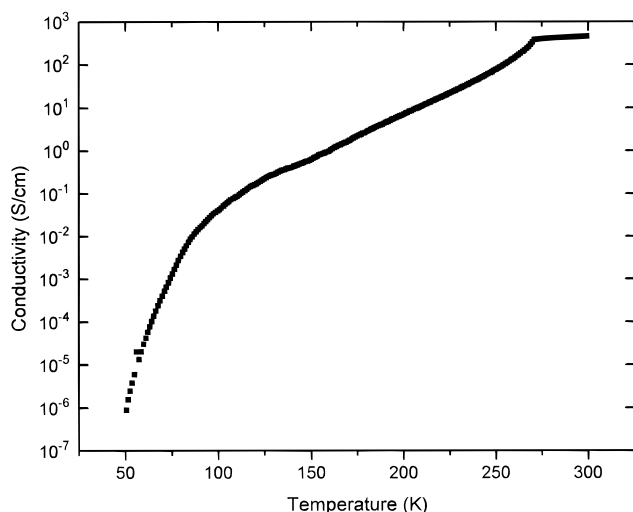
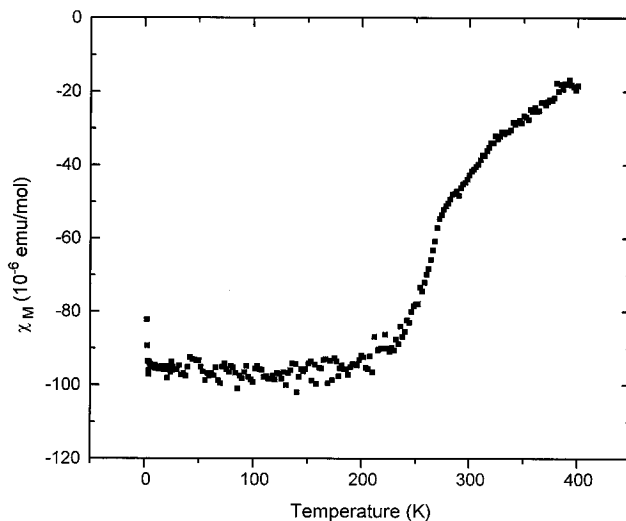

**Figure 7.** Conductivity of **[4][I]** as a function of temperature.

above, the calculated band gap is found to be near  $1.04$  eV, a value not far from that calculated for **3**.<sup>6b</sup>

Band structure calculations on the doped structure **[4][I]** confirm the qualitative conclusions drawn from the crystallographic results; the electronic structure is highly one-dimensional. The interpretation of the density of states data is again complicated by crossover of states, as shown in the DOS and block band diagrams (Figure 6) for a single stack of diradicals based on the lattice separation found in **[4][I]**. Analysis of the crystal orbitals reveals a conduction bandwidth of nearly  $3.7$  eV. This dispersion arises from interactions along the stacking direction ( $Y$ ). Dispersion calculations perpendicular to the stacking direction ( $\Gamma$  to  $\Sigma$  and  $\Gamma$  to  $Z$ ) reveal dispersion of less than  $0.1$  eV.

**Magnetic and Conductivity Measurements.** Magnetic susceptibility measurements on the dimer **[4]<sub>2</sub>** confirm that it is diamagnetic. Pressed pellet conductivity measurements point to a value of  $<10^{-6}$  S  $\text{cm}^{-1}$ . These results are similar to those obtained for other stacked polyfunctional dithiadiazolyls. By contrast the CT salt **[4][I]** is highly conductive, with a single-crystal conductivity of  $460$  S  $\text{cm}^{-1}$  at  $300$  K. The temperature dependence of the conductivity (Figure 7) shows weakly metallic behavior at room temperature, with the onset of a phase transition near  $270$  K; below this temperature conductivity is weakly activated. Magnetic susceptibility measurements on **[4][I]** (Figure 8) are consistent with the conductivity data. At low temperature the material is diamagnetic, with a measured



**Figure 8.** Magnetic susceptibility of **[4][I]** as a function of temperature.

diamagnetism of  $-97 \times 10^{-6}$  ppm  $\text{emu mol}^{-1}$  and a vanishingly small paramagnetic contribution. Above  $250$  K paramagnetism begins to rise, and carriers are still being generated at  $400$  K (the high-temperature limit of the experiment). This behavior is similar to that reported for **[2][I]** and **[3][I]**, although the maximum conductivity for present system is significantly higher. This we attribute to the close intracolumnar spacing (the stack repeat) and the consequently strong intermolecular overlap along the stacking direction. The high metal–insulation transition  $T_{\text{MI}}$  near  $270$  K is likewise a consequence of the absence of crystal orbital dispersion lateral to the stacking direction.

## Summary

The disjoint nature of the diradical **4** has been confirmed by the results of *ab initio* studies and ESR spectroscopy. In spite of a well-developed network of intermolecular interactions, which collectively lead to a small (by comparison with related systems) calculated band gap, the solid state dimer **[4]<sub>2</sub>** is a diamagnetic insulator. The CT salt **[4][I]** exhibits the highest conductivity yet reported for a dithiadiazolyl-based conductor. The material is, however, more one-dimensional than, for example, **[2][I]**, and the lack of lateral interactions, coupled with the strong intrastack contacts, leads to a greater susceptibility to a CDW-driven phase transition to an insulating state, i.e., a higher  $T_{\text{MI}}$ . One of our future goals is to produce materials in which the metallic state is stable at lower temperatures; this will require derivatives in which intrastack interactions are reduced and interstack interactions enhanced. Experiments to this end are in progress.

## Experimental Section

**General Procedures and Starting Materials.** Lithium bis(trimethylsilyl)amide, triphenylantimony, anhydrous hydrazine, chlorotrimethylsilane, sulfur dichloride (Aldrich), cyanogen (Matheson), nitrosyl hexafluorophosphate (Aesar), tetrabutylammonium hexafluorophosphate (Fluka), and ethanol (95%, Fisher) were obtained commercially. The solvents acetonitrile (Fisher, HPLC grade), chlorobenzene (Fisher), and methylene chloride (Fisher) were distilled from  $\text{P}_2\text{O}_5$  under a nitrogen atmosphere. Sulfur dichloride was also freshly distilled prior to use; iodine (Aldrich) was resublimed before use. The gas phase doping reactions with iodine were performed in an ATS series 3210 three-zone tube furnace, linked to a series 1400 temperature control system.  $^1\text{H}$  NMR spectra were recorded on a Varian Gemini 200 MHz NMR spectrometer; chemical shift values were internally referenced to TMS or the residual proton signals of the solvents ( $\delta$ ,  $\text{CHCl}_3$ ). Infrared spectra (Nujol mulls, CsI optics) were recorded on a Nicolet 20SX/C FTIR spectrometer at  $2$   $\text{cm}^{-1}$  resolution. X-band ESR spectra



were recorded on a Varian E-109 spectrometer with DPPH as a field marker. Cyclic voltammetry was performed on a PAR 273A electrochemical system (EG&G Instruments) using a two-compartment cell with Pt working, counter, and quasi-reference electrodes. Electrolyte solutions contained 2–5 mg of  $[4][PF_6]_2$  in 20 mL of 0.1 M tetra-*n*-butylammonium hexafluorophosphate in acetonitrile. Potentials were scanned from –2 to +1 V with respect to the quasi-reference electrode, which was later referenced to a standard Ag/AgCl electrode. The half-wave potentials are reported with reference to SCE. Mass spectra (70 eV, EI) were obtained on a Kratos MS890 spectrometer. Elemental analyses were performed by MHW Laboratories, Phoenix, AZ 85018.

**Reaction of Cyanogen with  $LiN(SiMe_3)_2$ .** Cyanogen (9.23 g, 0.177 mol) was slowly condensed onto a frozen solution of  $LiN(SiMe_3)_2$  (56.0 g, 0.345 mol) in 250 mL of toluene. The flask was allowed to warm to room temperature, producing a light brown slurry. The reaction was stirred for 2 h, during which time the mixture darkened considerably. Neat  $Me_3SiCl$  (40.2 g, 0.38 mol) was added, and the mixture was gently heated overnight. A light brown solid was filtered off, and the toluene was removed *in vacuo*. Slow vacuum distillation (with a 30-cm Vigreux column) of the residue afforded 31.0 g of a colorless liquid, bp 28–30 °C/10<sup>–2</sup> Torr. The infrared and <sup>1</sup>H NMR spectra of this compound were identical with those of authentic *N,N'*-bis-(trimethylsilyl)carbodiimide (Hüls America). The yield was 95% based on cyanogen. Subsequent reactions, which were performed with a 1:1 cyanogen: $LiN(SiMe_3)_2$  stoichiometry and without addition of chlorotrimethylsilane, also afforded the carbodiimide as the major product.

**Preparation of Diethyl Oximidate.** Sodium cyanide (40.0 g, 0.81 mol) was dissolved in a mixture of 200 mL of absolute ethanol and 350 mL of water, and the solution was cooled to –15 °C in a dry ice/ $CCl_4$  bath. Chlorine gas was slowly bubbled through the solution, and simultaneously, a solution of potassium hydroxide (1.5 g) in 100 mL of water was added dropwise. The reaction gradually turned yellow, then orange and solidified after approximately 45 min. The chlorine and KOH addition were halted, and the mixture was allowed to warm to room temperature over a 3-h period. The solution was extracted with three 40-mL portions of diethyl ether, the extracts were dried over  $K_2CO_3$ , and the ether solution was evaporated to a concentrated solution (ca. 100 mL) containing diethyl oximidate and ethanol. The remaining ethanol was removed *in vacuo*, leaving a semisolid light brown mass. Vacuum sublimation at 30–35 °C/10<sup>–2</sup> Torr afforded pure diethyl oximidate as white rodlike crystals, yield 34.0 g (68%). The product can also be isolated by direct crystallization from the concentrated ethanol solution. Infrared spectrum (4000–400  $cm^{-1}$ ): 3337 (s), 2958–2839 (vs), 1636 (vs), 1479 (w), 1463 (vs), 1384 (m), 1377 (m), 1366 (m), 1284 (vs), 1174 (m), 1158 (w), 1116 (s), 1083 (vs), 1016 (s), 1005 (s), 857 (s), 798 (w), 715 (w), 483 (w)  $cm^{-1}$ . <sup>1</sup>H NMR ( $\delta$ ,  $CDCl_3$ ): 8.30 (s, NH, 2H), 4.25 (q,  $CH_2$ , 4H), 1.36 (t,  $CH_3$ , 6H). Anal. Calcd for  $C_6H_{12}N_2O_2$ : C, 49.99; H, 8.39; N, 19.43%. Found: C, 49.73; H, 8.12; N, 19.63%.

**Preparation of Oxamidine Dihydrochloride.** Diethyl oximidate (9.82 g, 68.1 mmol) and ammonium chloride (7.45 g, 139 mmol) were slurried together in 60 mL of acetonitrile. Ammonia gas was slowly bubbled through the mixture for 90 min and the flask then sealed and the contents stirred at room temperature for 2 days to give a brick-red precipitate and a brown solution. The solid was filtered in air, rinsed with acetonitrile and dried *in vacuo*, yield 11.0 g. Infrared spectrum (4000–400  $cm^{-1}$ ): 3100 (s, br), 2950 (vs), 1654 (s), 1603 (s), 1460 (s), 1377 (s), 1252 (m), 1175 (m), 1060 (w), 858 (w), 795 (w), 723 (w), 680 (m), 590 (m)  $cm^{-1}$ . Mass spectrum: *m/e* 86 ( $C_2H_6N_4^+$ , M<sup>+</sup>, 29%), 70 ( $(M - NH_2)^+$ , 16%), 44 ( $(MH_2)^+$ , 100%).

**Reaction of Oxamidine Dihydrochloride with Sulfur Dichloride.** Oxamidine dihydrochloride (0.75 g, 4.7 mmol) was slurried in 20 mL of acetonitrile. To this was added an excess of  $SCl_2$  (2.0 mL). The mixture was stirred at room temperature for 1 h, after which no reaction had occurred. The mixture was then heated at gentle reflux, causing the mixture to turn dark green. The oxamidine dihydrochloride was consumed, producing a small amount of a green solid which was filtered off, rinsed with acetonitrile, and dried *in vacuo*. The infrared spectrum of this solid was not consistent with that of the desired dication  $[4]^{2+}$ . In addition the material did not react with triphenylantimony in acetonitrile.

**Preparation of Oxamidrazone 6.** Freshly sublimed diethyl oximidate (25.2 g, 0.175 mol) and hydrazine (12.0 mL, 0.38 mol; CAUTION! extremely toxic compound) were dissolved in 130 mL of absolute ethanol. The mixture was heated at 50 °C for 16 h, producing an off-white microcrystalline precipitate. The solid was filtered in air, rinsed with ethanol and diethyl ether, and air-dried to afford pure **6**, yield 19.5 g (96%), mp 177–80 °C dec. The compound was recrystallized from hot water as a hydrate; the water of hydration was removed by heating the material at 110 °C *in vacuo* for 16 h. Infrared spectrum (4000–400  $cm^{-1}$ ): 3352 (m), 3281 (w, br), 3137 (m, br), 2950 (s), 292 (s, br), 2845 (s), 1623 (m), 1570 (m), 1465 (s), 1377 (m), 1320 (w), 1262 (m), 1120 (w), 1030 (m), 876 (s), 739 (m)  $cm^{-1}$ . Mass spectrum: *m/e* 116 ( $M^+$ , 100%), 100 ( $(M - NH_2)^+$ , 9%), 85 ( $(M - N_2H_3)^+$ , 17%), 70 ( $C_2H_4N_3^+$ , 18%), 58 ( $M^{2+}$ , 36%), 43 ( $CH_3N_2^+$ , 57%). Anal. Calcd for  $C_2H_8N_6$ : C, 20.69; H, 6.94; N, 72.37%. Found: C, 20.60; H, 6.80; N, 72.33%.

**Preparation of 4,4'-Bis(1,2,3,5-dithiadiazolium) Dichloride,  $[4][Cl]_2$ .** A solution of freshly distilled  $SCl_2$  (20.0 mL, 0.314 mol) in 80 mL of acetonitrile was added slowly (over a 30-min period) to a slurry of oxamidrazone (6.39 g, 55.0 mmol) in 200 mL of acetonitrile cooled in an ice/water bath. After the  $SCl_2$  addition was complete the mixture was allowed to warm to room temperature and stirred for 2 h. During this time gentle gas evolution was observed. The resulting orange-brown solid so obtained was filtered, rinsed copiously with acetonitrile, and dried *in vacuo* to afford crude 4,4'-bis(1,2,3,5-dithiadiazolium) dichloride  $[4][Cl]_2$ . The crude dication was slurried in 40 mL of sulfur monochloride ( $S_2Cl_2$ ) and refluxed overnight to consume any unreacted ammonium salts. The mixture was cooled to room temperature and filtered off. The orange solid was then slurried in 30 mL of dichloromethane, and chlorine gas was rapidly bubbled through the solution for 15 min to convert any binary sulfur–nitrogen species to ( $CH_2Cl_2$  soluble)  $S_3N_3Cl_3$ . The remaining orange solid was filtered off, rinsed copiously with dichloromethane, and dried *in vacuo* to afford  $[4][Cl]_2$ , yield 2.55 g (16% based on oxamidrazone). Infrared spectrum (2000–200  $cm^{-1}$ ): 1695 (w), 1462 (vs), 1377 (s), 1367 (m), 1354 (w), 1341 (w), 1302 (s), 1261 (m), 1247 (m), 1094 (m, br), 1021 (m, br), 880 (s), 851 (s), 831 (w), 821 (s), 801 (m), 723 (w), 619 (s), 559 (w), 543 (s)  $cm^{-1}$ .

**Preparation of  $[4][PF_6]_2$ .** Nitrosyl hexafluorophosphate (2.26 g, 12.9 mmol) and  $[4][Cl]_2$  (1.80 g, 6.4 mmol) were heated in 20 mL of acetonitrile for 30 min, causing the dichloride salt to dissolve. The solvent was removed *in vacuo* and the residual yellow/brown solid pumped dry overnight to remove traces of NOCl. This material was triturated with 30 mL of 5:1 chlorobenzene/acetonitrile and the resulting slurry filtered to give crude  $[4][PF_6]_2$  as a white powder, yield 1.99 g (99%). Recrystallization from 1:1 mixture of chlorobenzene/acetonitrile afforded colorless crystalline blocks which were extremely air and moisture sensitive. Infrared spectrum (2000–200  $cm^{-1}$ ): 1705 (w), 1577 (w), 1460 (s), 1375 (s), 1366 (s), 1300 (w), 1262 (w), 1208 (w), 1123 (s), 924 (m), 840 (vs, br), 742 (m), 723 (w), 638 (w), 594 (w), 562 (s), 524 (w), 414 (w)  $cm^{-1}$ . Anal. Calcd for  $C_2F_{12}N_4P_2S_4$ : C, 4.82; N, 11.25%. Found: C, 5.06; N, 11.44%.

**Preparation of 4,4'-Bis(1,2,3,5-dithiadiazolyl) 4.** Solid triphenylantimony (3.40 g, 9.62 mmol) was added to a slurry of  $[4][Cl]_2$  (2.55 g, 9.13 mmol) in 50 mL of acetonitrile, immediately producing a black solid. The mixture was gently refluxed overnight and then cooled. The black precipitate was filtered off, rinsed with acetonitrile, and dried *in vacuo* to afford crude dimer  $[4]_2$ , yield 1.89 g. Vacuum sublimation at 140 °C/10<sup>–2</sup> Torr gave metallic blue-black needles of  $[4]_2$ , yield 0.97 g (51%). Mp 275–280 °C. Infrared spectrum (2000–200  $cm^{-1}$ ): 1460 (s), 1376 (s), 1294 (m), 1264 (m), 1244 (s), 1080 (m, br), 820 (w), 804 (s), 793 (s), 784 (s), 559 (m), 507 (s), 495 (m), 421 (m)  $cm^{-1}$ . Mass spectrum: *m/e* 208 ( $M^+$ , 84%), 182 ( $(M - NS)^+$ , 97%), 144 ( $(M - S_2)^+$ , 11%), 130 ( $(M - NS_2)^+$ , 31%), 116 ( $(M - N_2S_2)^+$ , 14%), 104 ( $M^{2+}$ , 45%), 64 ( $S_2^+$ , 100%), 46 ( $NS^+$ , 80%). Anal. Calcd for  $C_2N_4S_4$ : C, 11.53; N, 26.90%. Found: C, 11.92; N, 26.98%.

**Preparation of  $[4][I]$ .** Resublimed  $[4]_2$  (0.210 g, 1.01 mmol) and iodine (0.126 g, 1.00 mmol) were sealed in an evacuated (10<sup>–3</sup> Torr) Pyrex tube (25-mm diameter, 25-cm length). The contents of the tube were heated to 150 °C for 1 week, during which time metallic black needles grew at the far end of the tube (at 110 °C). The crystals were harvested in air but stored under an inert atmosphere. Yield of  $[4][I]$

**Table 4.** Crystal data for [4][I]

formula	S <sub>4</sub> N <sub>4</sub> C <sub>2</sub> I
fw	335.19
<i>a</i> , Å	11.909(3)
<i>b</i> , Å	3.271(2)
<i>c</i> , Å	19.860(6)
<i>V</i> , Å <sup>3</sup>	773.6(7)
space group	<i>Ccmm</i>
<i>Z</i>	4
temp, K	293
$\mu$ , mm <sup>-1</sup>	5.07
<i>R</i> ( <i>F</i> ), <i>R</i> <sub>w</sub> ( <i>F</i> ) <sup>a</sup>	0.059, 0.078

$$^a R = \frac{[\sum |F_o| - |F_c|]/[\sum |F_o|]}{[\sum (w|F_o|^2)]^{1/2}}; R_w = \frac{[\sum w|F_o| - |F_c|]^2}{[\sum (w|F_o|^2)]^{1/2}}$$

80 mg (23%). Anal. Calcd for C<sub>2</sub>N<sub>4</sub>S<sub>4</sub>I: C, 7.17; N, 16.71; I, 37.86%. Found: C, 7.25; N, 16.87; I, 37.68%. Infrared spectrum: as observed for other highly conductive CT iodides,<sup>9</sup> [4][I] scatters IR radiation very strongly; the IR spectrum of [4][I] is very weak and poorly resolved, revealing only three distinct bands at 1283, 819, and 508 cm<sup>-1</sup>.

**X-ray Measurements.** All X-ray data were collected on an ENRAF-Nonius CAD-4 diffractometer with monochromated Mo K $\alpha$  ( $\lambda = 0.71073$  Å) radiation. Crystals of [4][I] were mounted on a glass fiber with silicone rubber. Data were collected using a  $\theta/2\theta$  technique. The structures were solved using direct methods refined by full-matrix least squares which minimized  $\sum w(\Delta F)^2$ . A summary of crystallographic data is provided in Table 4.

**Computational Methods.** *Ab initio* predictions were made using the 1995 version of the GAMESS suite of programs.<sup>42</sup> For the triplet state restricted open shell (ROHF) methodology was used. The diradical singlet was described by the GVB-PP method, a two-configuration SCF approach, starting from the ROHF orbitals for the corresponding triplet. The basis sets used in this study consisted of the Pople split-valence sets, 6-31G\* and 6-311G\*,<sup>43</sup> and the SBK CEP-31G set included within GAMESS,<sup>44</sup> with the latter altered by the addition of d-type polarization functions with coefficients of 0.75 (C),

(42) Schmidt, M. W.; Baldrige, K. K.; Boatz, J. A.; Elbert, S. T.; Gordon, M. S.; Jensen, J. J.; Koseki, S.; Matsunaga, N.; Nguyen, K. A.; Su, S.; Windus, T. L.; Dupuis, M.; Montgomery, J. A. *J. Comput. Chem.* **1993**, *14*, 1347.

(43) (a) Dill, J. D.; Pople, J. A. *J. Chem. Phys.* **1975**, *56*, 5255. (b) Francl, M. W.; Pietro, W. J.; Hehre, W. J.; Binkley, J. S.; Gordon, M. S.; DeFrees, D. J.; Pople, J. A. *J. Chem. Phys.* **1982**, *77*, 3654. (c) Krishnan, R.; Binkley, J. S.; Seeger, R.; Pople, J. A. *J. Chem. Phys.* **1980**, *72*, 650. (d) Hariharan, P. C.; Pople, J. A. *Theor. Chim. Acta* **1973**, *28*, 213.

0.80 (N), and 0.532 (S). All geometries were optimized using gradient methods. The symmetry restrictions of *D*<sub>2h</sub> and *D*<sub>2d</sub> were imposed for most calculations.

The band structure calculations were carried out with the EHMACC suite of programs<sup>45</sup> using the parameters discussed previously.<sup>6a,46</sup> The off-diagonal elements of the Hamiltonian matrix were calculated with the standard weighting formula.<sup>47</sup>

**Magnetic Susceptibility Measurements.** The magnetic susceptibilities as a function temperature were measured using a SQUID magnetometer operating at 1 T.

**Conductivity Measurements.** Four-point conductivity measurements along the highly conducting axes were performed with a Keithley 236 unit. Wires were attached to the pads with gold paint. The measurements were carried out at constant voltage with an excitation voltage of 0.1 V. The conductivity was ohmic over at least 2 orders of magnitude.

**Acknowledgment.** Financial support at Guelph was provided by the Natural Sciences and Engineering Research Council of Canada (NSERC) and at Arkansas by the National Science Foundation (EPSCOR program). C.D.B. acknowledges a DOE/ASTA Traineeship, and both R.G.H. and C.D.M. acknowledge NSERC postgraduate scholarships.

**Supporting Information Available:** Tables of optimized (*ab initio*) geometries of **4** and [4]<sub>2</sub>, crystal data, structure solution and refinement, atomic coordinates, bond lengths and angles, and anisotropic thermal parameters and an ORTEP diagram for [S<sub>2</sub>N<sub>2</sub>C-CN<sub>2</sub>S<sub>2</sub>][I] (8 pages). This material is contained in many libraries on microfiche, immediately follows this article in the microfiche version of the journal, can be ordered from the ACS, and can be downloaded from the Internet; see any current masthead page for ordering information and Internet access instructions.

JA952144X

(44) (a) Stevens, W. J.; Basch, H.; Krauss, M. *J. Chem. Phys.* **1984**, *81*, 6026. (b) Stevens, W. J.; Basch, H.; Krauss, M.; Jasien, P. *Can. J. Chem.* **1992**, *70*, 612. (c) Cundari, T. R.; Stevens, W. J. *J. Chem. Phys.* **1993**, *98*, 5555.

(45) EHMACC, Quantum Chemistry Program Exchange, Program No. 571.

(46) Basch, H.; Viste, A.; Gray, H. B. *Theor. Chim. Acta* **1965**, *3*, 458.

(47) Ammeter, J. H.; Burghi, H. B.; Thibeault, J. C.; Hoffmann, R. *J. Am. Chem. Soc.* **1978**, *100*, 3686.