

University of Groningen

A high chronology for the early Iron Age in central Italy

Nijboer, A.J.; van der Plicht, J.; Bieti Sestieri, Anna Maria ; de Santis, Anna

Published in:
 Palaeohistoria

IMPORTANT NOTE: You are advised to consult the publisher's version (publisher's PDF) if you wish to cite from it. Please check the document version below.

Document Version
 Publisher's PDF, also known as Version of record

Publication date:
 2001

[Link to publication in University of Groningen/UMCG research database](#)

Citation for published version (APA):

Nijboer, A. J., van der Plicht, J., Bieti Sestieri, A. M., & de Santis, A. (2001). A high chronology for the early Iron Age in central Italy. In A. J. Nijboer, J. N. Lanting, P. A. J. Attema, M. Bierma, & M. Los-Weijns (editors), *Palaeohistoria* (Vol. 41/42, blz. 163 - 176)

Copyright

Other than for strictly personal use, it is not permitted to download or to forward/distribute the text or part of it without the consent of the author(s) and/or copyright holder(s), unless the work is under an open content license (like Creative Commons).

Take-down policy

If you believe that this document breaches copyright please contact us providing details, and we will remove access to the work immediately and investigate your claim.

Downloaded from the University of Groningen/UMCG research database (Pure): <http://www.rug.nl/research/portal>. For technical reasons the number of authors shown on this cover page is limited to 10 maximum.

A HIGH CHRONOLOGY FOR THE EARLY IRON AGE IN CENTRAL ITALY

A.J. NIJBOER

Groningen Institute of Archaeology, Groningen, Netherlands

J. VAN DER PLICHT

Centrum voor Isotopen Onderzoek, Groningen, Netherlands

A.M. BIETTI SESTIERI

Soprintendente Archeologica per l' Abruzzo, Chieti

A. DE SANTIS

Soprintendente Archeologica di Roma, Servizio di Protostoria, Roma

ABSTRACT: This paper presents evidence for a high chronology of the early Iron Age in central Italy. Four archaeological contexts from Fidene, *Satricum* and Castiglione are presented together with the associated range of artefacts and the radiocarbon dating. Especially the set of radiocarbon dates from the hut at Fidene functions as a reference point for the transition of Latial phase IIB to phase III. It is highly unlikely that the hut and its contents can be dated later than 820 BC. Thus, the absolute chronology of the transition from Latial phase IIB to phase III can be safely raised by 50 to 75 years. This would bring the Italian absolute chronology for the early Iron Age more in line with chronological developments in central Europe. In the Epilogue some consequences of a high chronology for the Italian early Iron Age in relation to Mediterranean archaeology are discussed.

KEYWORDS: Absolute chronology, radiocarbon dating, central Italy, early Iron Age.

1. INTRODUCTION

One of the main problems of Mediterranean archaeology is the chronology from the late Bronze Age to the Orientalising period (1200-700 BC). The present chronological framework reflects the subordination of indigenous cultural phases to imports from regions with a 'high culture' such as Egypt, Mycene, the Near East or Greece. These imports determine the absolute chronology of the local arrangements, even though the imported goods function outside their original context and their biography is hardly known. Especially during a period in which gift exchange involving high-value goods such as the overseas imports was prevalent, it is hard to know how long these goods circulated before they were deposited. Moreover, mixed assemblages with local goods and securely dated imported artefacts are extremely rare during the period 1200 to 800 BC. The danger of a circular argument is manifest; for instance, one can detect a clustering of events during the 8th century BC when interregional contacts once more became firmly established. However, the interval between the Mycenean imports during the 14th and 13th centuries BC and the recovery of transmarine trade during the 8th century BC is marked by scarce overseas contacts (cf. Aubet, 1993: pp. 167-184). This has led to scattered regional chronologies based on stylistic

sequences with hardly any sound links in terms of absolute years. Therefore it is recognized by archaeologists working on these centuries that "the search for absolute chronology is like crossing a minefield sown with hidden dangers, among them legendary events, relics of records, preconceived expectations and archaeological misinterpretations. One may attempt, but not necessarily expect to reach the other side in safety" (Hankey, 1988: pp. 33-34). Italy especially is in a curious position, because southern Italy is securely related to the Mediterranean chronology (cf. Morris, 1996) while northern Italy is attached to the chronology of central Europe (cf. Pacciarelli, 1996). As such it is stuck between the traditional 'historical' chronology of the Aegean and the adjusted absolute chronology of central Europe. The new chronology for central Europe is based on ¹⁴C (radiocarbon) and dendrochronological measurements. It has replaced the previous chronology based on stylistic sequences. Recently, Friedrich and Henning have confirmed the high chronology by publishing the dendrochronological investigation of Wehringen Tumulus 8. This tumulus marks the beginning of the Hallstatt C phase in southern Germany and the deposited goods in the tumulus have far-reaching supraregional implications. Wood used for the construction of the tumulus and for the deposited wagon yielded a felling date of 778±5 BC. As such this date

provides a reference point for the transition from the Urn Field culture to the earliest Hallstatt C1 graves (Friedrich & Hennig, 1996). Therefore recent chronological research has resulted in several discrepancies between the traditional Mediterranean chronology and the adjusted, absolute chronology of central Europe (table 1). This paper intends to add a new reference point for the transition of Latial phase II to phase III by presenting the radiocarbon dates of the early Iron Age hut at Fidene in relation with other archaeological contexts in central Italy that have been dated by the radiocarbon method.

Chronological research in archaeology can be subdivided into:

1. Relative chronologies based on the seriation of artefacts that are typologically classified, resulting in a typo-chronological sequence e.g. of pottery or brooches (*fibulae*);
2. Absolute chronologies based on historical or literary evidence;
3. Time measurements based on scientific dating methods such as ¹⁴C analysis and dendrochronology.

Relative chronologies describe cultural sequences. Most archaeologists consider these sequences correct since they are stratigraphically anchored. However, academic debate is fierce when methods for the determination of the absolute chronology are involved. The discussion should be about the validity of meth-

Table 1. Final Bronze Age and early Iron Age, Italian peninsula (based on Bietti Sestieri, 1996: pp. 185-193).

Traditional absolute chronology	Absolute chronology based on dendro-chronology and ¹⁴ C datings	Conventional classification into periods
c. 1200 BC	c. 1200 BC	Final Bronze Age Hallstatt A1 Hallstatt A2 Hallstatt B1
c. 900 BC	c. 1020 BC	Early Iron Age Hallstatt B2 Hallstatt B3
c. 700 BC	c. 780 BC	Advanced Iron Age Orientalising period (Transalpine early Iron Age) Hallstatt C

ods, that is methods employed to abstract 'historical' dates from literary sources *versus* the modern, scientific dating methods, but it often deteriorates into a confession of faith. Famous is the debate on the Thera eruption and its relation to the 'historical' chronology of the pharaohs list (cf. Kitchen, 1996a; 1996b) and the final years of the Minoan civilization

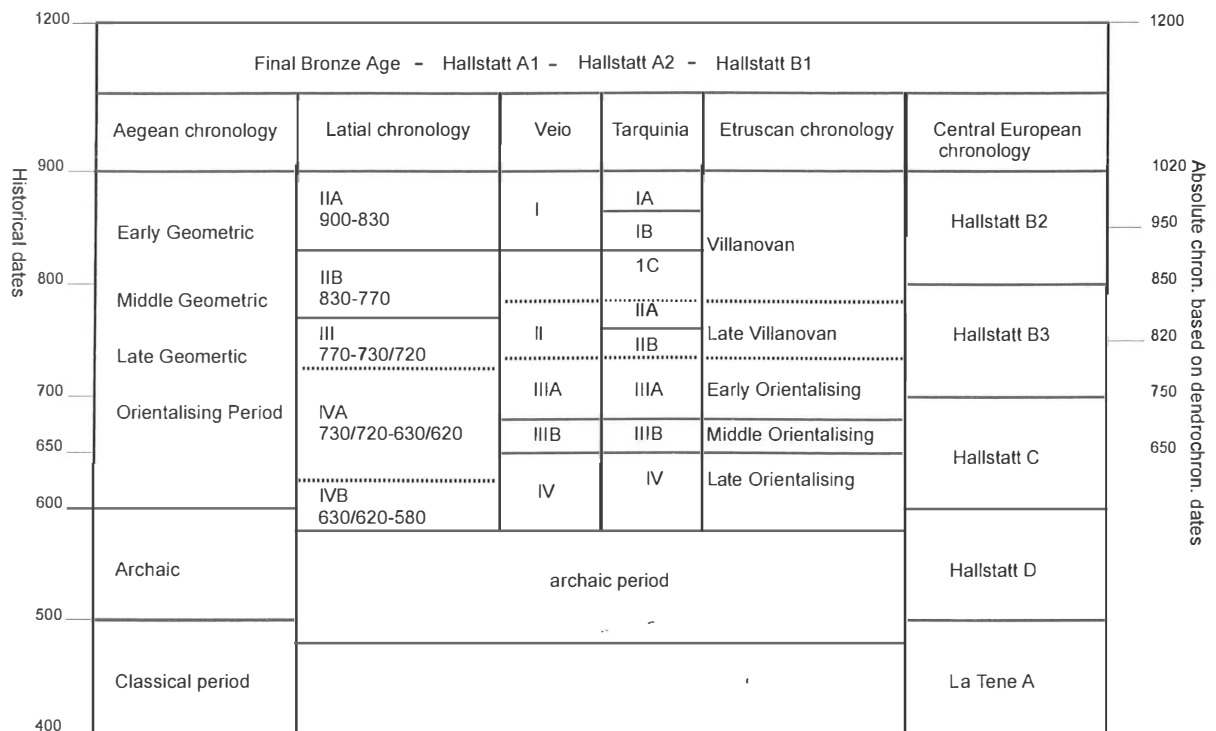

Fig. 1. Chronological chart of central Italy, the Aegean and central Europe with an indication of the historical dates as well as the dendrochronological dates.

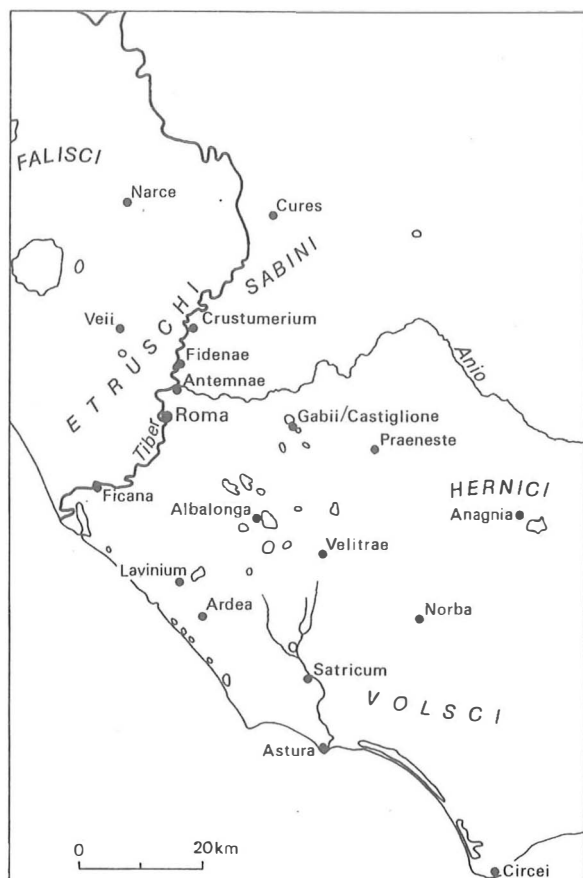

Fig. 2. Map of central Italy.

(Hardy & Renfrew, 1990; Manning, 1996). Another potential minefield is the absolute chronology of the transition from the late Bronze Age to the early Iron Age in the Mediterranean, because it touches the 'historical' dates of the Greek colonization process of southern Italy during the 8th century BC.

In recent years papers have been presented which cast doubt on the absolute chronology of the Italian late Bronze Age and early Iron Age (Randsborg, 1991; 1996; Peroni, 1994; Giardino, 1995; Bietti Sestieri, 1996; Nijboer, 1998). Table 1 illustrates that the differences between the traditional, 'historical' dates on the one hand and on the other the chronology based on dendro-dates from central Europe amount to more than a century. However, table 1 is based on scientific, absolute datings from central Europe and not on high-quality radiocarbon or dendrochronological research from Italy itself. Such research in Italy is scarce and therefore it is only in theory that the absolute dating of the Italian late Bronze Age and early Iron Age has become insecure.

This paper will present four well-defined archaeological contexts in terms of associated artefacts together with some ^{14}C datings, which indicate that the transition of Latial period II to period III can be

raised into the 9th century BC. The adjusted date for the transition from Latial period II to III would bring the Italian absolute chronology for the early Iron Age more in line with chronological developments in central Europe (fig. 1). The four described contexts are:

- a. the Iron Age hut at Fidene;
- b. the lowest fireplace of hut feature II at *Satricum*;
- c. the lowest level of hut VI at *Satricum*, and
- d. tombs 25 and 40 from Castiglione (fig. 2).

All four contexts are associated with a range of artefacts, which will be presented as well. These artefacts indicate that the contexts belong to Latial period II, to Latial period III or somewhere between the two periods. Therefore they are traditionally dated to the 9th and 8th centuries BC (fig. 1). In relative chronology the tombs from Castiglione are the oldest, followed by the hut at Fidene, the fireplace of hut feature II at *Satricum* and finally the lowest level of hut VI, also at *Satricum*. It is not our intention to discuss in any way the relative chronology of the early Iron Age in *Latium Vetus*. The stages of the cultural phases during the early Iron Age must be considered correct, since they are based on archaeological stratigraphies. It is merely the relation between relative and absolute chronology that has become controversial.

The limited number of contexts from central Italy examined in this paper does not permit the synthesis of a revised chronology for the whole of Italy from the late Bronze Age to the Orientalising period. At present numerous ^{14}C datings are known from Italy (Skeates & Whitehouse, 1994). These datings have not been interpreted and a preliminary analysis indicates that most of the datings are often: a) of poor quality and b) not directly associated with a range of archaeological artefacts. Much of the previous ^{14}C research turns out to be hardly suitable for a detailed discussion on chronology for the period 1200 to 700 BC. The quality of the research is poor both in terms of the radiocarbon datings themselves and in terms of archaeological context (cf. Manning, 1996: pp. 28-32 for a similar observation for the Aegean Bronze Age).

2. RADIOCARBON METHOD

Before the individual archaeological contexts are presented together with their ^{14}C datings, a few remarks must be made concerning the radiocarbon method, the datings themselves and the calibration method used.

Radiocarbon (^{14}C) is a radioactive isotope of carbon, which is naturally produced high in the atmosphere. Living plants, animals and people generally have the same ^{14}C content as the atmosphere they

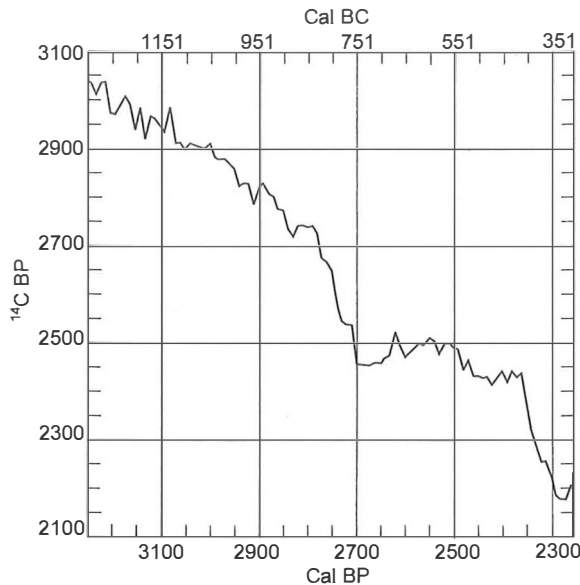

Fig. 3. Section of the calibration curve essential for the period discussed.

live in. The carbon exchange with the environment ceases after death, whereupon the ^{14}C concentration diminishes in time, owing to radioactive decay. The basic principle of the radiocarbon dating method is the determination of the age of carbon-containing organic matter (wood, peat, bone, charcoal etc.) by measuring the residual amount of ^{14}C left in the sample in relation to the half-life of ^{14}C , which is 5730 years. The radiocarbon content of samples can be measured by two methods based on different principles:

1. Measuring the ^{14}C radioactivity (the conventional dating method; at Groningen marked with a laboratory code number GrN: Mook & Streurman, 1983; Mook & Waterbolk, 1985), and
2. Measuring the ^{14}C concentration (by means of AMS, a form of mass spectrometry; at Groningen marked with a laboratory code number GrA: Gottang et al., 1995; Van der Plicht, 1993).

At the Centre for Isotope Research of the University of Groningen both techniques are used for the age determination of carbon-containing samples. The radiocarbon content can be measured accurately. However, the result of the analysis in radiocarbon years is related to historical age in a complicated way. Calibration is the establishment of the relation between radiocarbon age (reported in BP, Before Present defined as AD 1950) and historical age (BC/AD). Calibration takes into account natural ^{14}C fluctuations in the past and other variables. The ideal samples for calibration are tree rings because they can be dated absolutely by means of dendrochronology. Tree-ring chronologies are now available all

the way back into the Preboreal. A ^{14}C calibration curve has been constructed covering 9908 BC to the present (Stuiver et al., 1998). Figure 3 shows the section of the calibration curve essential for this article. Calibration means finding the correct calendar date corresponding to the measured BP-age by using a curve such as that shown in figure 3. It is the wiggly course of the calibration curve, which is due to solar fluctuations, that makes calibrating difficult. For instance, wiggles can cause a ^{14}C date to correspond to more than one calendar date. Illustrations of this principle can be found in Van der Plicht & Mook (1987). Calibration becomes even more complex if we also take into account the measurement error. Recently, programs working on Personal Computers have been distributed for calibration purposes. We here used the program CAL25 (Van der Plicht, 1993) upgraded with the INTCAL98 data (Stuiver et al., 1998). Many ^{14}C laboratories have adopted this program.

As can be seen from figure 3, there are periods in the calibration curve that are extremely problematic for calibration purposes. For instance, between 750 and 400 BC there is a 'plateau' in the curve, which is caused by an increased ^{14}C production in the atmosphere around 800 BC. This era is known as the 'Hallstatt disaster' and is a calibration nightmare indeed for this period of almost four centuries; the atmospheric ^{14}C level is virtually constant, so that very few ^{14}C years correspond to 350 calendar years. This means that one date (say 2450 BP) corresponds to 750-400 BC, even if the ^{14}C measurement has been done with very high precision. Obviously, the application of ^{14}C dating to chronological questions concerning this period is problematic. An example is to be found in the prehistory of the Scythians in the Russian territory (Zaitseva et al., 1998).

By contrast, an advantage of the uneven calibration curve is the steep decline of the curve between roughly 900 and 800 BC. This may lead to high-quality datings with a quite precise calibrated date. Thus the lowest level of hut VI at *Satricum* has a calibrated date with a 95.4% confidence level between 830 and 790 BC (GrN-16466; 2620 \pm 30 BP). Apart from being regarded as a calibration disaster, the 'wiggly' era is of interest because of possible connections between ^{14}C fluctuations (the peak at 850 cal BC), climate change and its consequences for prehistoric society (Van Geel et al., 1996; Becker & Kromer, 1993).

We present in this paper the most precisely measured ^{14}C datings, since only they are relevant for our purpose. The use of ^{14}C datings of the same archaeological context with a high measurement error would make our argument unnecessarily complicated. The precision of the ^{14}C measurement depends largely on the accuracy that can be obtained with a specific carbon sample. In order to illustrate this point in greater

Table 2. ^{14}C datings from the Iron Age hut at Fidene

Sample name	Material	Laboratory code	^{14}C age (BP)
Fidene 1	Charcoal (wood)	GrN-20125	2800±50
Fidene 2	Charcoal (wood)	GrN-20126	2790±50
Fidene 3	Charcoal (wood)	GrN-20127	2820±50
Fidene 4	Charcoal (wood)	GrN-20128	2780±60
Fidene 93-160	Seeds	GrA-5008	2760±50
Fidene 93-282	Seeds	GrA-5007	2770±50

detail, we discuss the various ^{14}C datings from Fidene (table 2).

The carbon samples from the Iron Age hut at Fidene derive from charcoal from a hearth and from charred seeds. There are at present six closely related radiocarbon datings from the hut at Fidene with results that range from 2820 to 2760 years BP. One of the six ^{14}C datings has an accuracy of ± 60 years (GrN-20128, 2780±60 BP) and hence will not be employed in this article, since calibration with a 95.4% confidence level gives a range from 1120 to 810 BC. Unfortunately the remaining five datings have a mediocre accuracy of ± 50 years. Even with this relatively high measurement error the calibrated dates indicate that the carbon cannot be younger than 820 BC. Imagine the precision if the Fidene samples had amounted to ± 30 years. The result with the lowest date from Fidene is labelled GrA-5008; 2760±50 BP.

Calibrated with a 95.4% confidence level this sample is dated between 1000 and 820 BC. If the accuracy had been 2760±30 BP then the sample would have been calibrated with a 95.4% confidence level to 970-830 BC. Therefore we primarily employ the samples that are dated most accurately with the radiocarbon method. Including the other ^{14}C datings of the same context with similar radiocarbon measurements but with larger measurement errors would unnecessarily confuse the discussion.

The presented calibrated dates in this article are rounded off to decades in order to illustrate that ^{14}C datings can never provide a 'historical' date, precise to the year. Besides, we want to stress that in pre- and proto-history any chronology can merely be approximate.

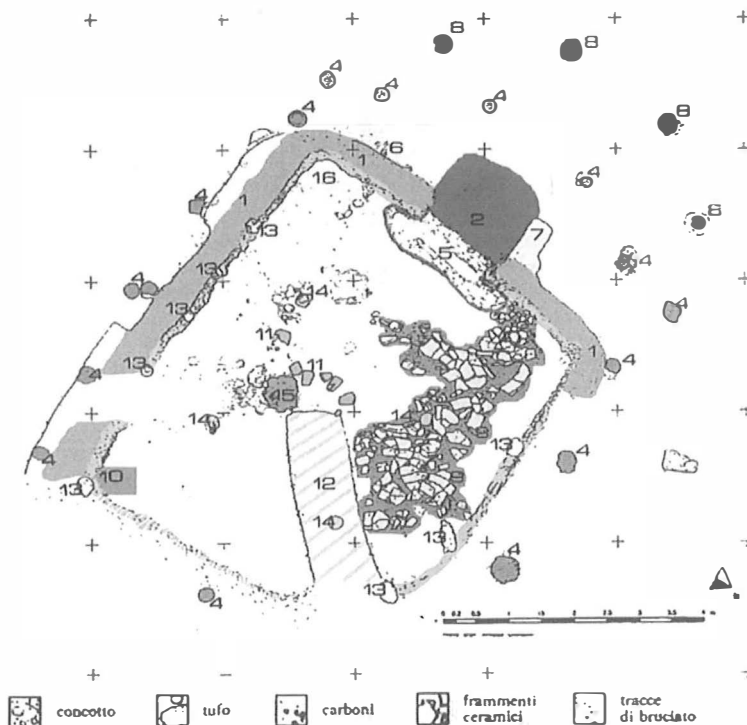

Fig. 4. Plan of the Iron Age hut at Fidene.

3. FIDENE

The hut at Fidene was excavated during various campaigns around 1990 and is one of the best preserved Iron Age buildings of central Italy (fig. 4). As such it has been reconstructed and can be visited in the Borgata Fidene on the eastern outskirts of Rome (fig. 5). The contents of the hut are exhibited in the recently refurbished 'Museo Nazionale Romano alle Terme di Diocleziano' in Rome.

The hut lies on the fringes of the Iron Age settlement of Fidene and measures approximately 5×6 m. It has a small portico and walls which collapsed in a fire of great intensity (Bietti Sestieri et al., 1992, 1998; De Santis et al., 1998). A man-made bank of tuff runs along the outside of the building on two sides. The portico protected the entrance on the western side and consisted of two parallel walls of loam. The hut walls were made with the *terra-pisé* technique, which employs parallel wooden planks in between which loam is pressed. Vertical posts at regular intervals along the outside of the wall impart rigidity to the hutwalls. Traces of the roof consist of burnt beams on the floor. The roof was probably thatched, with a frame of beams covered with branches and straw. It was supported by four posts, which

were set within the building. In the area around the building there are also regular rows of posts, which probably functioned as supports for the eaves. Inside the hut at least four storage jars were recovered as well as some truncated pyramids, which must have functioned as fire-dogs of some kind, since they were found around the central hearth. It is likely that a sudden fire destroyed the building while it was fully in use. A curious detail confirms this interpretation because a domestic cat was trapped inside the building by the fire and subsequent collapse. Its skeletal remains were excavated in the southeastern corner of the hut. Other faunal remains document the keeping of sheep/goats, cattle and pigs. There is hardly any evidence for game consumption. Botanical evidence indicates the cultivation of vegetables and cereals such as barley and wheat (*Triticum aestivum*).

The excavated pottery comprises storage jars, bowls, jars, cooking stands, amphorae, cups and mugs (fig. 6). It is hand-made *impasto* pottery occasionally decorated with simple, incised geometric patterns, which are characteristic of the Latial phase IIB and the beginning of phase III. Thus the pottery inside the hut represents the transition from Latial phase IIB to phase III, conventionally dated to around 770 BC by the conventional typo-chronological



Fig. 5. Reconstruction of the Iron Age hut in the Borgata Fidene, Rome.

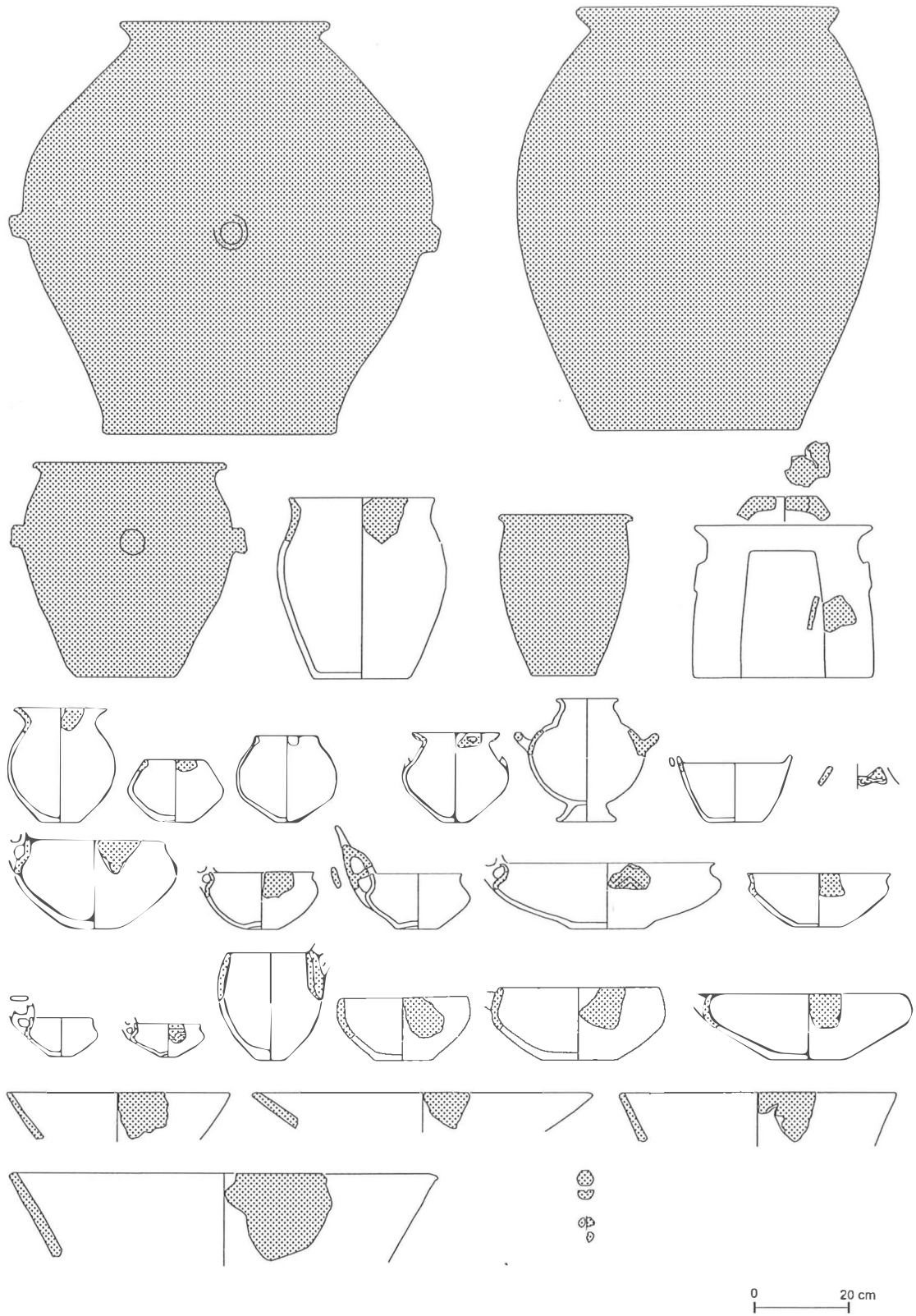

Fig. 6. Pottery recovered from the early Iron Age hut at Fidene, 3rd quarter of 9th century BC (850-825 BC).

method. However, a different, absolute date for the early Iron Age structure at Fidene was obtained by the radiocarbon method. We present five ^{14}C datings from the hut, which all indicate that its contents cannot be dated later than 820 BC. Two dates derive from samples of charred seeds. These are short-lived samples and can therefore not be subject to the 'old-wood effect' (Mook & Waterbolk, 1985: pp. 49-55; James, 1992: appendix 1). Moreover, the consistency of the five ^{14}C datings from the hut is an argument in favour of a high absolute chronology of the early Iron Age in central Italy. Combined, at 2σ (95.4%) confidence, the five determinations offer a calibrated range of 1120 to 820 BC:

- | | | |
|----|-----------------------|---|
| a. | GrN-20125; 2800±50 BP | 1120-1100 cal BC
1080-1060 cal BC
1050-830 cal BC
95.4% confidence level |
| b. | GrN-20126; 2790±50 BP | 1110-1100 cal BC
1050-830 cal BC
95.4% confidence level |
| c. | GrN-20127; 2820±50 BP | 1130-1100 cal BC
1090-890 cal BC
880-840 cal BC
95.4% confidence level |
| d. | GrA-5008; 2760±50 BP | 1000-820 cal BC
95.4% confidence level |
| e. | GrA-5007; 2770±50 BP | 1020-820 cal BC
95.4% confidence level |

The seeds (d and e) are short-lived samples and radiocarbon determination results in a calibrated date between 1020 and 820 BC. Thus with a confidence level of 95.4% the actual date of these samples should be somewhere in the 10th or 9th century BC. On archaeological and typological grounds one should however conclude that the hut and its contents must probably be dated to the lower end of the calibration range, that is to the third quarter of the 9th century BC. This means that we propose to raise the absolute date for the transition from Latial period II to III by about 50 to 75 years. This conclusion based on the radiocarbon datings of five organic samples from the Iron Age hut at Fidene, acts as a reference point for the transition of Latial phase II to phase III. In view of the combined evidence of the five radiocarbon datings, it is highly unlikely that this transition can be dated later than 820 BC. This date functions as a starting point for the chronological discussion of the subsequent contexts from central Italy presented in this paper.

4. SATRICUM: FIREPLACE IN HUT-FEATURE II

The ancient settlement of *Satricum* was located at present-day Borgo Le Ferriere near the Pontine plain, on the easternmost border of *Latium Vetus*. It is situated approximately 60 km southeast of Rome (fig.

2). The settlement originated during the early Iron Age on a number of tuff plateaux in the lower basin of the River Astura. The Astura, the most important river in *Latium* south of the Tiber, connects *Satricum* with the sea. During the 7th and 6th centuries BC the site functioned within a system of large, late Iron Age and Archaic centres, of which Ardea, *Lavinium* and Ficana are mentioned. So far, various Iron Age hut features have been excavated around a central pond (Maaskant-Kleibrink, 1992: pp. 108-146). A functional differentiation has been suggested among the excavated hut features according to their size and form. Thus the hut features are classified as cooking sheds or as square/oval huts. The huts can be fairly large. Some measure up to 30-40 m². The cooking sheds are smaller and measure about 2/2.5×2.5/3 m. Their fill is dark, owing to large amounts of charcoal, and they contain many sherds of cooking pots as well as bones. A characteristic of the cooking sheds is that they contain rubbish pits dug deep into the ground and that they are all surrounded by small post-holes. Hut feature II is somewhat larger, but otherwise it has all the characteristics of an average cooking shed. It has a diameter of 3.40 m and was partly surrounded by small postholes. Its dominant feature is a fireplace about 1 m in diameter at the lowest level. From this level a charcoal sample was taken to be dated by the radiocarbon method. Faunal remains near the fireplace are identified as bones of sheep/goat and pigs. The associated pottery from this context consists of hand-made, *impasto* pottery such as cooking-stands, storage jars, jars, bowls, lids, mugs and cups (fig. 7). There was one fragment of a ware made from depurated clay. The pottery is traditionally dated to 800-750 BC though Beijer suggests a date around 750 BC mainly on account of the cups (Beijer, in: Maaskant-Kleibrink, 1987: pp. 61-64, 175-84, 285-302). For descriptions of the pottery we refer to Maaskant-Kleibrink (1987: Cat.Nos: 581, 585, 592, 596, 598, 605, 610, 620, 624, 628, 631, 644, 645, 650, 652, 653, 656, 657, 663, 664, 667, 670-672, 674, 681, 687, 688, 720 and 727).

Charcoal from this context was dated with the radiocarbon method. The calibration of the ^{14}C date entails an older absolute date for this context (9th century BC):

- | | |
|-------------------------|--|
| GrN 11669; 2670 ± 30 BP | 900-880 cal BC
860-850 cal BC
840-800 cal BC
95.4% confidence level |
|-------------------------|--|

The typology of the pottery associated with the fireplace assigns it to Latial phase III. The pottery is typologically somewhat later than the pottery associated with the hut at Fidene. Therefore we suggest dating the pottery from hut feature II at *Satricum* to the late 9th century BC.

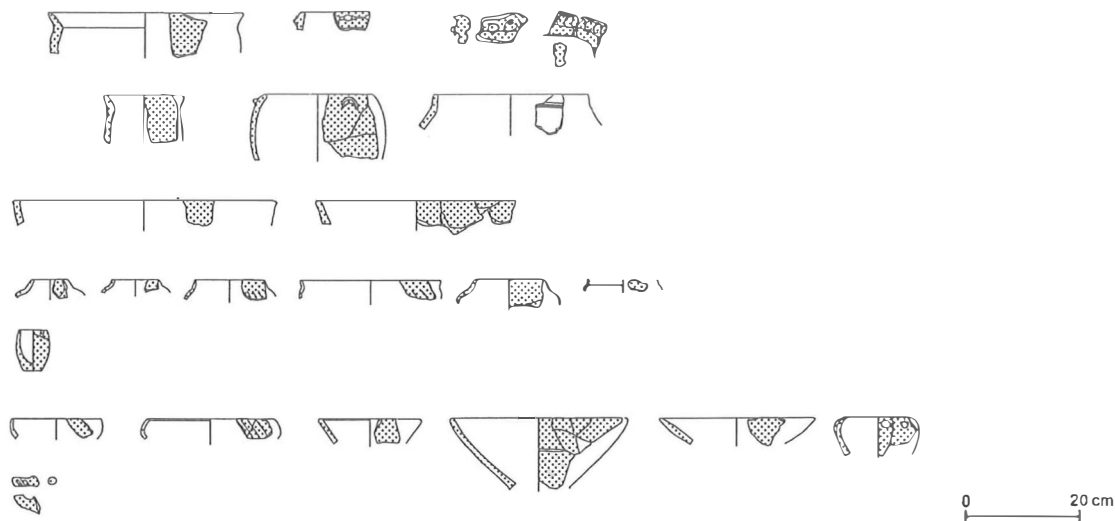

Fig. 7. Pottery from hut feature II at Satricum, late 9th century BC.

5. SATRICUM: LOWEST LEVEL OF HUT VI

Hut VI at *Satricum* is a rectangular hut with rounded corners. The sunken floor of the hut measures 5×3.3 m (Maaskant-Kleibrink, 1992: pp. 54-59). Stratum 1A is the lowest level of hut VI and consists of a black, charcoal-rich deposit at the bottom of the hut, beneath the floor and a layer of daub. It contained bones of pigs, sheep/goats, cattle and a fox. The number of excavated sherds from this level amounts to 1750, of which 281 were diagnostic. A relatively large number of sherds had been secondarily burnt. Stratum 1A contained hand-made, *impasto* pottery such as storage jars, jars, cooking-stands, mugs, bowls, cups, lids and weaving implements (fig. 8). On typological grounds the pottery is assigned to Latial phase III while some of the jars and bowls point to the lower end of this phase, that is the third quarter of the 8th century BC, according to the conventional chronology (Maaskant-Kleibrink, 1992: pp. 42-45, 54-59, 173-182, 278-289).

Charcoal from the lowest level of hut VI was dated by the radiocarbon method. The calibration of the most precise radiocarbon dating indicates an older absolute date than the conventional dating since it gives a range from 830 to 790 cal BC:

GrN-16466; 2620±30 BP 830-790 cal BC
95.4% confidence level

The typology tells us that this context should be younger than the hut at Fidene and the fireplace of hutfeature II at *Satricum*. Therefore we suggest dating the pottery from the lowest level of hut VI to the early 8th century BC, about half a century older than the conventional typo-chronological date.

There are other radiocarbon datings from archaeological contexts at *Satricum*, which do not comply with the traditional typo-chronological dates. For ex-

ample, the lowest fireplace of hut feature III contains pottery such as cooking-stands, storage jar, jar and bowls (Maaskant-Kleibrink, 1987: pp. 66-70, 184-189, 303-309; Cat.Nos: 740, 744, 751, 752, 754, 756, 757, 761, 763, 766, 770 and 744). The pottery is conventionally dated to the transition of Latial phase III to phase IV, around 725 BC. The calibration of the radiocarbon dating indicates a much higher date:

GrN-11668; 2705±30 BP 900-810 cal BC
95.4% confidence level

Because this high calibrated radiocarbon date can only be explained by the 'old-wood effect', we do not include the lowest fireplace of hut feature III in our discussion, though in general terms it does support our proposal to raise the absolute chronology of the early Iron Age in central Italy.

6. CASTIGLIONE: TOMBS 25 AND 40

The Castiglione Necropolis is located near a small volcanic crater about 20 km to the east of Rome (fig. 2). The geographical location, connecting various land and fluvial routes, is probably one of the reasons for the density of archaeological remains. Besides the Castiglione Necropolis there are several archaeological sites around the crater such as settlement traces from the middle Bronze Age onwards and another Iron Age cemetery. There are various clusters of small, early Iron Age settlement units, which subsequently developed into the Latin town of Gabii on the southeastern edge of the crater during the 8th and 7th centuries BC. The sanctuary of Juno-Gabina, which was in use for many centuries, started possibly as an open-air sanctuary during the 8th/7th century BC (Almagro Gorbea, 1982: pp. 599-610). One of the two Iron Age cemeteries, the Osteria

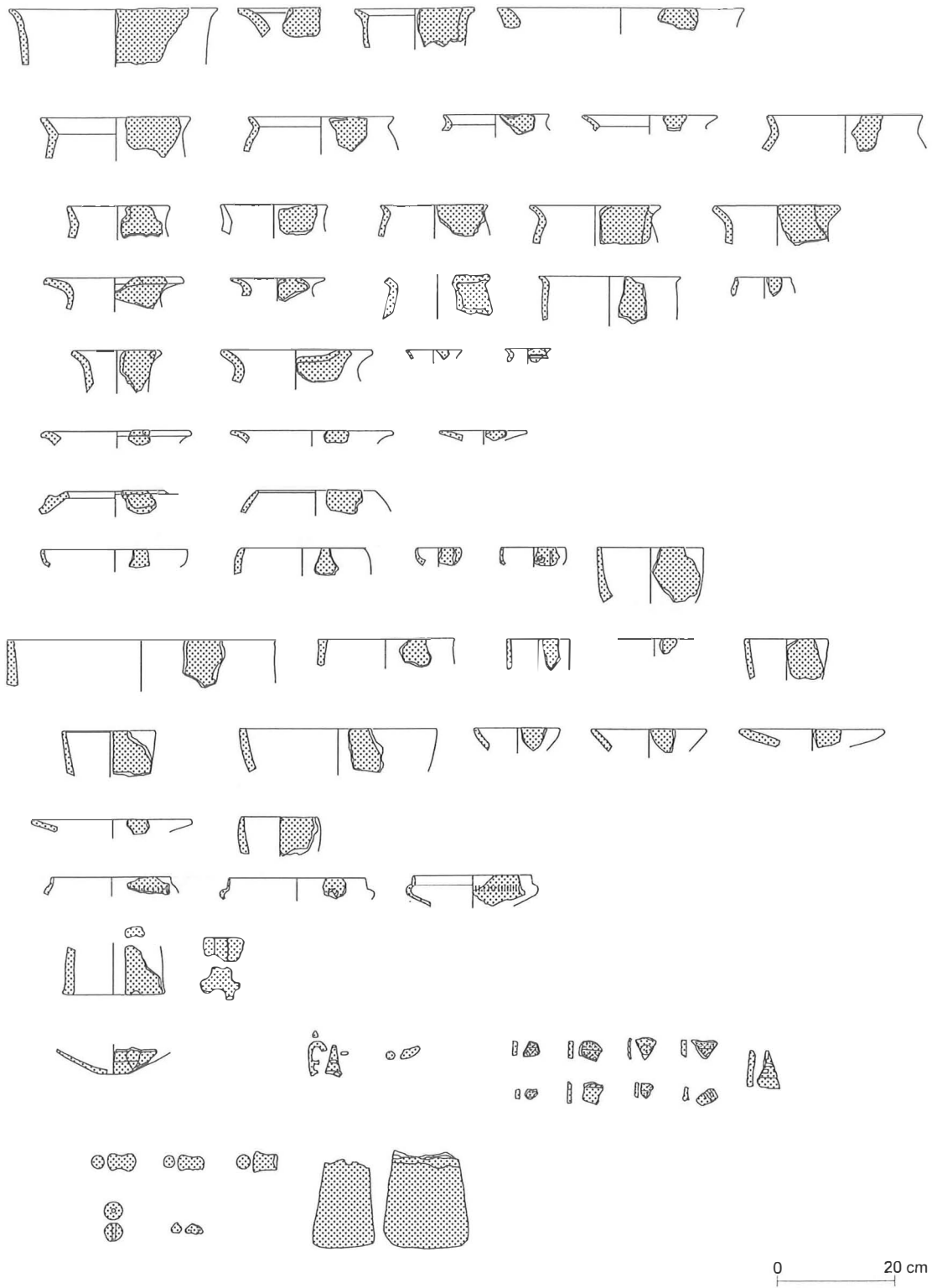

Fig. 8. Pottery from the lowest level of hut VI at Satricum, early 8th century BC.¹

dell' Osa Necropolis is well known. It contained almost 600 tombs, which have been carefully analysed and published (Bietti Sestieri, 1992a). The Castiglione Cemetery is located about 1.8 km to the east of the Osteria dell' Osa Necropolis. It is smaller than the Osteria dell' Osa Necropolis and the tombs are furnished with a more limited range of grave goods.

So far 90 tombs have been excavated at the Castiglione Necropolis, which cut through and thus destroyed a previous settlement dated to the middle Bronze Age. The typology of the grave goods indicates that the majority of the finds date to Latial phase IIa2 and IIb1, which is conventionally dated to roughly the second half of the 9th century BC (approximately 870/860-800 BC). Until now, hardly any tombs have been dated to phase IIa1 while none is assigned to phase IIb2. The burial ground was occupied by distinct grave clusters with predominantly female burials and inhumations. In comparison with the Osteria dell' Osa Cemetery, the homogeneity of grave goods as related to gender and age is especially remarkable. The difference in funerary assemblages between these two contemporary and nearby cemeteries points to local variability in burial customs. However, in this case the difference may point to a hierarchy among the Osteria dell' Osa and Castiglione communities. The associations of the grave goods and other funerary indicators seem to imply that the community that buried its dead at Castiglione was less organized than the community nearby that buried its dead at Osteria dell' Osa (Bietti Sestieri, 1986, 1992a, 1992b; Bietti Sestieri & De Santis, 2000: pp. 74-84).

Two ^{14}C datings of the Castiglione Cemetery will be presented. The human bones from tombs 25 and 40 were dated separately, which gave to both the following calibrated results:

GrN-23475 and GrN-23478; 2670 ± 30 BP
 900-880 cal BC
 860-850 cal BC
 840-800 cal BC
 95.4% confidence level

The associated finds of both tombs probably belong to Latial phase IIa2 and phase IIb1, 870/860-800 BC, though the associated artefacts are typologically not very indicative (fig. 9). The ^{14}C datings seem to confirm the dating of Latial period II. However, on account of the radiocarbon analyses of the hut at Fidene, both tombs must be dated to the early 9th century BC. This consideration has been taken into account in the ^{14}C calibration and is necessary if the transition from Latial period II to III is dated to the third quarter of the 9th century BC as all the radiocarbon datings from Fidene indicate. Subject to a final, typo-chronological analysis of the Castiglione Cemetery, the absolute dates assigned to tombs 25 and 40 probably have to be raised by a few decades to the early 9th century BC.

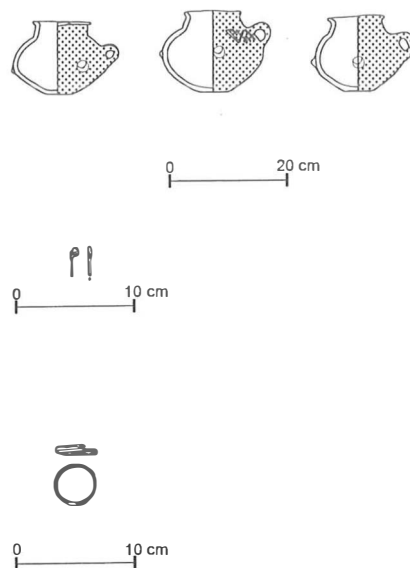

Fig. 9. The artefacts from tombs 25 and 40 at Castiglione, early 9th century BC.

At present other tombs from the Castiglione Necropolis are being dated by the radiocarbon method. The results of these analyses will be incorporated in a general assessment of the Italian chronology. The unpublished results available so far indicate that the Castiglione tombs belonging to Latial phase IIa2-IIb1 are unlikely to be younger than the first half of the 9th century BC.

7. EPILOGUE

In this paper we have presented several well-documented archaeological contexts with their associated finds in combination with their radiocarbon datings. Especially the ^{14}C datings of short-lived samples such as the charred seeds from the hut at Fidene demonstrate that the absolute chronology of the early Iron Age in central Italy has to be raised. Traditionally the transition from Latial period II to Latial period III is dated to around 770 BC. The combined evidence of the ^{14}C datings from the early Iron Age hut at Fidene provides a reference point for this transition and it seems highly unlikely that the hut and its contents were still in use after the third quarter of the 9th century BC (850-825 BC). Thus we propose to raise the absolute chronology for the transition from Latial period II to Latial period III by about 50 to 75 years, to the third quarter of the 9th century BC.

At present the discussed contexts are the only examples from central Italy during the early Iron Age that indicate that the absolute chronology of the early Iron Age can be adjusted in line with the recent absolute chronology for central Europe.

The difference between the absolute chronology of our proposal and that based on the conventional typo-chronological sequence is caused by the difference in methodology. Our proposal results from a careful use of radiocarbon dating methods. We used short-lived samples and bone when possible. In addition, we employed the 95.4% confidence level ($2\text{-}\sigma$ rather than the more usual $1\text{-}\sigma$), as a conservative approach. Even by this criterion our conclusion concerning the high chronology is obvious. Moreover, our proposal employs mainly the lower end of the calibration ranges presented. Only with the Castiglione tombs did we have to resort to the upper end of the calibration range for archaeological and typological reasons. However, recent, unpublished radiocarbon datings of human bones from five different tombs at Castiglione corroborate our proposal for a higher absolute chronology for Latial phase II.

On the other hand, the conventional absolute dating of the typo-chronology is based mainly on the dates given by the ancient author Thucydides for the 'Greek' colonies in southern Italy (cf. Morris, 1996; James, 1992; Ross Holloway, 1996: pp. 37-50). His account, which was written more than three centuries after the emergence of the 'Greek' colonization movement, forms the framework for the conventional absolute dating of the early Iron Age in the western Mediterranean. Since most archaeologists in the past adhered to this 'historical' account, one can detect a clustering of events during the 8th century BC. An example of this clustering is the present absolute chronology of the Levantine diaspora towards the western Mediterranean. Currently the Phoenician and Greek advances towards the west are considered to be simultaneous and are dated from 770 BC onwards (Aubet, 1993: pp. 167-184; Ridgway, 1998). This date is based on typo-chronological research, which employs mainly Greek pottery as guide artefacts (Docter, forthcoming). Thus, it should not come as a surprise if the Phoenician and Greek expansion towards the west is found to be simultaneous, as a result of circular reasoning. If one accepts Thucydides' dates for the foundation of the Greek colonies in southern Italy, one should also accept the reconstructed absolute dates of other ancient authors for the Phoenician diaspora, which gave the Levantines a head start of about 50 years. Besides, by accepting Thucydides' colonial dates, one is almost obliged to accept also his account of the 'Greek colonisation' of Sicily. He specifically states that the Phoenicians were already occupying coastal promontories and islets before the arrival of Greek communities (Thucydides 6:2, 6). Employing a scientific dating method such as the radiocarbon method or preferably dendrochronology may eventually dissociate the Phoenician from the Greek diaspora towards the west.

Nevertheless, our proposal to raise the absolute chronology for the transition of Latial phase II to

phase III by about 50 to 75 years need not, at present, imply that the absolute chronology of the 'Greek', Geometric pottery has to be adjusted. After all, the presented archaeological contexts from central Italy did not contain any late Geometric sherds except maybe one sherd from *Satricum* that is not very distinctive. However, the reconstructed absolute dating based on Thucydides' account, has to remain as it is since it is 'historically' documented. It is the context of the early Greek colonization movement that alters if our conclusion is accepted. Though this paper merely presents evidence for readjusting the absolute chronology during the early Iron Age of some sites in central Italy, the consequences may be significant, owing to the correlation of regional typo-chronologies (cf. fig. 1). This is known as the 'knock-on effect' of chronological research, due to the insignificant number of supraregional archaeological contexts which could act as a reference point for the absolute chronology. It is highly unlikely that ancient history will provide us with any further reconstructed 'historical' dates. However, the radiocarbon method and dendrochronology could in theory be employed ad infinitum to suitable archaeological contexts, thus giving us more information on the absolute chronology of the Mediterranean during the 2nd and 1st millennium BC. In this way our proposal could eventually result in a revision of the substages of Late Helladic, Submycenaean and Greek Geometric pottery. Other effects could be:

- A longer period of precolonial contacts, e.g. from the 9th to the early 8th century BC;
- Less abrupt socio-economic transitions in Italy during the 8th century BC because in absolute years the Iron Age in Italy (lasting until 700 BC) could be extended with about 100 years;
- A lengthening of the proto-urban phase during the urbanization process of central Italy;
- Synchronous evolution of the Italian and Greek Orientalising periods, which currently are somewhat dissociated in time; and
- A revision of the historical Greek colonization process in that, as mentioned above, the 'historical' dates for this process given by the ancient author Thucydides remain as they are, while their context will be altered (cf. Morris, 1996; James, 1991).

These consequences should not however be inferred from the above-mentioned knock-on effect, but from new research in radiocarbon dating and dendrochronology.

8. REFERENCES

- AERTS-BIJMA, A.Th., H.A.J. MEIJER & J. VAN DER PLICHT, 1997. AMS sample handling in Groningen. *Nuclear Instruments and Methods B* 123, pp. 221-225.
- ALMAGRO-GORBEA, M., 1982. *El Santuario de Juno en Gabii* (= Bibliotheca Italica 17, Monografías de la Escuela Española

- de Historia y Arqueología en Roma del CSIC). Roma.
- AUBET, M.E., 1993. *The Phoenicians and the west*. Cambridge University Press, Cambridge.
- BAILLIE, M.G.L., 1995. *A slice through time: dendrochronology and precision dating*. Batsford, London.
- BECKER, B. & B. KROMER, 1993. The continental tree-ring record: absolute chronology, ^{14}C calibration and climatic change at 11 ka. *Paleogeography, Paleoclimatology, Paleocology* 103, pp. 67-71.
- BECKERATH, J. VON, 1994. *Chronologie des ägyptischen neuen Reiches* (= Hildesheimer Ägyptologische Beiträge, 39). Gerstenberg Verlag, Hildesheim.
- BEIJER, A.J., BIETTI SESTIERI, A.M., 1986. I dati archeologici di Fronte alla Teoria. *Dialoghi Archeologia* 2, pp. 249-263.
- BIETTI SESTIERI, A.M. (a cura di), 1992a. *La necropoli laziale di Osteria dell' Osa*. Quasar, Roma.
- BIETTI SESTIERI, A.M., 1992b. *The Iron Age community of Osteria dell' Osa*. Cambridge University Press, Cambridge.
- BIETTI SESTIERI, A.M., 1996. *Protostoria, teoria e pratica*. La nuova Italia Scientifica, Roma.
- BIETTI SESTIERI, A.M., J. DE GROSSI MAZZORIN & A. DE SANTIS, 1992. Fidene: The Iron Age building. *Caecvlvs* 1 (= Images of Ancient Latin Culture), pp. 77-85.
- BIETTI SESTIERI, A.M., I. DAMIANI, J. DE GROSSI MAZZORIN, A. DE SANTIS, G. RECCHIA & E. REMOTTI, 1998. Un edificio della I Età del Ferro nell' abitato di Fidene (Roma): Posizione stratigrafica, caratteristiche strutturali, materiali. In: *Proceedings of the XIII U.I.S.P.P. Congress*, Vol. IV, Forlì, 8-14 September 1996, International Union of Prehistoric and Protohistoric Sciences, A.B.A.C.O. s.r.l., Forlì, pp. 595-604.
- BIETTI SESTIERI, A.M. & A. DE SANTIS, 2000. *Protostoria dei Popoli Latini*. Museo Nazionale Romano Terme di Diocleziano, Ministero per i Beni e le Attività Culturali, Electa, Milano.
- BOWMAN, S., 1994. Using radiocarbon: an update. *Antiquity* 68, pp. 838-843.
- BRUINS, H.J. & J. VAN DER PLICHT, 1995. Tell es-Sultan (Jericho): Radiocarbon results of short-lived cereal and multi-year charcoal samples from the end of the Middle Bronze Age. *Radiocarbon* 37, pp. 213-220.
- BRUINS, H.J. & J. VAN DER PLICHT, 1996. The exodus Enigma. *Nature* 382, pp. 213-214.
- CLINE, E.H., 1994. *Sailing the wine-dark sea: international trade and the Late Bronze Age Aegean* (= BAR International Series 591). Tempus Reparatum, Oxford.
- DE SAMA, ENTIS, A., R. MERLO & J. DE GROSSI MAZZORIN, 1998. *Fidene, una casa dell' Età del Ferro*. Ministero dei Beni Culturali e Ambientali, Soprintendenza Archeologica di Rolecta, Milano.
- DOCTER, R.F., forthcoming. East Greek fine wares and transport amphorae of the 8th-5th century B.C. from Carthage and Toscanos. In: Mesa Rotonda: *Cerámicas jonias de época arcaica. Centros de producción y comercialización en el Mediterráneo occidental* (Empuries, 26-28 mayo 1999).
- EVANS, C., 1998. Historicism, chronology and straw men: situating Hawkes' 'Ladder of inference'. *Antiquity* 72, pp. 398-404.
- FRIEDRICH, M. & H. HENNIG, 1996. Dendrodate for the Wehringen Iron Age wagon grave (778±5 BC). *Journal of European Archaeology* 4, pp. 281-303.
- GEEL, B. VAN, J. BUURMA & H.T. WATERBOLK, 1996. Archaeological and palaeoecological indications for an abrupt climatic change in the Netherlands, and evidence for climatological teleconnections around 2650 BP. *Journal of Quaternary Sciences* 11, pp. 451-460.
- GIARDINO, C., 1995. *Il Mediterraneo Occidentale fra XIV ed VIII secolo a.C.: Cerchie minerarie e metallurgia* (= BAR International Series 612). Tempus Reparatum, Oxford.
- GODWYN, H., 1962. Half-life of radiocarbon; decisions of the 5th Radiocarbon Dating Conference, Cambridge 1962. *Nature* 195, p. 984.
- GOTTDANG, A., D.W. MOUS & J. VAN DER PLICHT, 1995. The HVEE ^{14}C system at Groningen. *Radiocarbon* 37 (= Proceedings of the 15th International ^{14}C Conference), pp. 649-656.
- HANKEY, V., 1988. Note on the chronology of LH IIIC Late and Submycenaean. *Jahrbuch des Deutschen Archäologischen Instituts* 103, pp. 33-37.
- HARDY, D.A. & A.C. RENFREW (eds), 1990. *Thera and the Aegean World III. Volume three: chronology*. The Thera Foundation, London.
- HAWKES, C., 1954. Archaeological theory and method: Some suggestions from the Old World. *American Anthropologist* 56, pp. 155-168.
- HENNIG, H., 1995. Zur Frage der Datierung des Grabhügels 8 'Hexembergh' von Wehringen, Lkr. Augsburg, Bayerisch-Schwaben. In: *Trans Europam* (Festschrift M. Primas). R. Habelt, Bonn, pp. 129-140.
- HERRING, E., 1993. Radiocarbon dating and South Italian early geometric pottery. *Accordia Research Papers. The Journal of the Accordia Research Centre* 3, pp. 55-65.
- JAMES, P., 1992. *Centuries of darkness*. Jonathan Cape, London.
- KITCHEN, K.A., 1996a. The historical chronology of Ancient Egypt. A current assessment. In: K. Randsborg (ed.), *Absolute chronology; archaeological Europe 2500-500 BC. Acta Archaeologica Supplementa* 1, pp. 1-13.
- KITCHEN, K.A., 1996b. *The third Intermediate Period in Egypt (1100-650 BC)*. Aris & Phillips Ltd., Warminster.
- KUNIHOLM, P.I., 1997, 1998. December 1997, December 1998 Progress Reports.
- KUNIHOLM, P.I., B. KROMER, S.W. MANNING, M. NEWTON, C.E. LATINI & M.J. BRUCE, 1996. Anatolian tree rings and the absolute chronology of the eastern Mediterranean, 2220-718 BC. *Nature* 381, pp. 780-783.
- MAASKANT-KLEIBRINK, M., 1987. *Settlement excavations at Borgo le Ferriere <Satricum>*, Vol. 1. Egbert Forsten, Groningen.
- MAASKANT-KLEIBRINK, M., 1992. *Settlement excavations at Borgo le Ferriere <Satricum>*, Vol. 2. Egbert Forsten, Groningen.
- MANNING, S., 1996. Dating the Aegean Bronze Age: without, with and beyond, radiocarbon. *Acta Archaeologica* 67 (= Acta Archaeologica Supplementa Vol. 1-1996, Absolute Chronology, Archaeological Europe, 2500-500 BC), pp. 15-37.
- MOOK, W.G. & H.J. STREURMAN, 1983. Physical and chemical aspects of radiocarbon dating. In: W.G. Mook & H.T. Waterbolk (eds), *Proceedings Groningen Symposium ^{14}C and Archaeology* (= PACT Publication 8), pp. 31-55.
- MOOK, W.G. & H.T. WATERBOLK, 1985. *Handbook for archaeologists, No. 3, Radiocarbon dating*. European Science Foundation, Strasbourg.
- MORRIS, I., 1996. The absolute chronology of the Greek Colonies in Sicily. *Acta Archaeologica* 67 (= Acta Archaeologica Supplementa Vol. 1, Absolute chronology, archaeological Europe, 2500-500 BC), pp. 51-59.
- MOUNTJOY, P.A., 1994. *Mycenaean pottery; an introduction* (= Oxford University Committee for Archaeology, Monograph 36, Oxbow Books). Oxford.

- NIJBOER, A.J., 1998. *From household production to workshops*. Groningen Institute of Archaeology, Groningen.
- OLDE DUBBELINK, R.A. & J. VAN DER PLICHT, 1989. Satricum en de ¹⁴C-datering. *Tijdschrift voor Mediterrane Archeologie* 4, pp. 4-13.
- OLDE DUBBELINK, R.A. & J. VAN DER PLICHT, 1990. Le capanne II e VI a Borgo le Ferriere (Satricum) e le datazioni al Radiocarbonio. *Archeologia Laziale* 19, pp. 234-237.
- PACCIARELLI, M., 1996. Nota sulla cronologia assoluta della prima età del ferro in Italia. *OCNUS, Quaderni della Scuola di Specializzazione in Archeologia, Università degli Studi di Bologna* 4, pp. 185-189.
- PERONI, R., 1994. *Introduzione alla protostoria Italiana*. Editori Laterza, Roma.
- PLICHT, J. VAN DER, 1993. The Groningen radiocarbon calibration program. *Radiocarbon* 35, pp. 231-237.
- PLICHT, J. VAN DER & W.G. MOOK, 1987. Automatic radiocarbon calibration: Illustrative examples. *Palaeohistoria* 29, pp. 173-182.
- RANDSBORG, K., 1991. Historical implications; chronological studies in European archaeology c. 2000-500 BC. *Acta Archeologica* 62, pp. 89-109.
- RANDSBORG, K. (ed.), 1996. *Absolute chronology, archaeological Europe, 2500-500 BC* (= Acta Archeologica Supplementa Vol. 1). København.
- RENFREW, C., 1996. Kings, tree-rings and the Old World. *Nature* 381, pp. 733-734.
- RIDGWAY, D., 1998. The Carthaginian connection: A view from San Montano. In: R. Rolle & K. Schmidt (eds), *Archäologische Studien in Kontaktzonen der antiken Welt*. Vandenhoeck & Ruprecht, Göttingen, pp. 301-318.
- RÖLLIG, W., 1992. Asia Minor as a bridge between East and West: The role of the Phoenicians and Aramaeans in the transfer of culture. In: G. Kopcke & I. Tokumaru (eds), *Greece between East and West: 10th to 8th centuries BC*. Verlag Philipp von Zabern, Mainz/Rhine, pp. 93-102.
- ROSS HOLLOWAY, R., 1996. *The archaeology of early Rome and Latium*. Routledge, London/New York.
- SKEATES, R. & R. WHITEHOUSE (eds.), 1994. *Radiocarbon dating and Italian prehistory* (= Accordia Specialist Studies on Italy, Vol. 3). Accordia Research Centre, University of London.
- STRØM, I., 1995. The early sanctuary of the Argive Heraion and its external relations. *Proceedings of the Danish Institute at Athens* 1, pp. 37-127.
- STUIVER, M., P.J. REIMER, E. BARD, J.W. BECK, G.S. BURR, K.A. HUGHEN, B. KROMER, G. MCGORMAC, J. VAN DER PLICHT & M. SPURK, 1998. INTCAL98 radiocarbon age calibration, 24,000-0 cal BP. *Radiocarbon* 40, pp. 1041-1083.
- Suess, 1970. The 3 causes of secular carbon-14 fluctuations, their amplitudes and time constants. *Proc. 12th Nobel Symposium 'Radiocarbon variations and the absolute chronology'*. Uppsala, pp. 595-605.
- TAMBURINI, P., 1998. *Un museo e il suo territorio. Dalle origini al periodo Etrusco*. Comune di Bolsena, Regione Lazio, Bolsena.
- TUSA, S. (a cura di), 1997. *Prima Sicilia, alle origini della società siciliana*. Albergo dei Poveri, Palermo, 18 ottobre-22 dicembre 1997. Ediprint, Palermo.
- WATERBOLK, H.T., 1971. Working with radiocarbon dates. *Proceedings of the Prehistoric Society* 37, pp. 15-33.
- WHITE, F.A. & G.M. WOOD, 1986. *Mass spectrometry: applications in science and engineering*. New York, Wiley.
- ZAITSEVA, G.I., S.S. VASILIEV, L.S. MARSADOLOV, J. VAN DER PLICHT, A.A. SEMENTSOV, V.A. DERGACHEV & L.M. LEBEDAVA, 1998. A tree-ring and ¹⁴C chronology of the key Sayan-Altai monuments. *Radiocarbon* 40, pp. 571-580.
- ZANINI, A. (ed.), 1997. *Dal Bronzo al Ferro: il II millennio a.C. nella Toscana centro-occidentale*. Livorno, Museo di Storia Naturale del Mediterraneo. Pacini Editore, Ospedaletto.