

Spring 1991

Development of a classification and coding system for computer-aided process planning

Shilpan K. Patel

New Jersey Institute of Technology

Follow this and additional works at: <https://digitalcommons.njit.edu/theses>



Part of the [Manufacturing Commons](#)

Recommended Citation

Patel, Shilpan K., "Development of a classification and coding system for computer-aided process planning" (1991). *Theses*. 1287.
<https://digitalcommons.njit.edu/theses/1287>

This Thesis is brought to you for free and open access by the Theses and Dissertations at Digital Commons @ NJIT. It has been accepted for inclusion in Theses by an authorized administrator of Digital Commons @ NJIT. For more information, please contact digitalcommons@njit.edu.

Copyright Warning & Restrictions

The copyright law of the United States (Title 17, United States Code) governs the making of photocopies or other reproductions of copyrighted material.

Under certain conditions specified in the law, libraries and archives are authorized to furnish a photocopy or other reproduction. One of these specified conditions is that the photocopy or reproduction is not to be “used for any purpose other than private study, scholarship, or research.” If a user makes a request for, or later uses, a photocopy or reproduction for purposes in excess of “fair use” that user may be liable for copyright infringement,

This institution reserves the right to refuse to accept a copying order if, in its judgment, fulfillment of the order would involve violation of copyright law.

Please Note: The author retains the copyright while the New Jersey Institute of Technology reserves the right to distribute this thesis or dissertation

Printing note: If you do not wish to print this page, then select “Pages from: first page # to: last page #” on the print dialog screen

The Van Houten library has removed some of the personal information and all signatures from the approval page and biographical sketches of theses and dissertations in order to protect the identity of NJIT graduates and faculty.

DEVELOPMENT OF A CLASSIFICATION AND CODING SYSTEM

FOR

COMPUTER AIDED PROCESS PLANNING

by
Shilpan Patel

Thesis submitted to the Faculty of the Graduate School of the
New Jersey Institute of Technology in partial fulfillment of the
requirements for the degree of Master of Science in Manufacturing
Engineering

1991

APPROVAL SHEET

Title of Thesis: Development of a Classification and Coding System for
Computer aided Process Planning.

Name of Candidate: Shilpan Patel
Master of Manufacturing Engineering, 1991

Thesis and Abstract Approved:

Dr. Nouri Levy
Associate Professor
Mechanical Engineering Dept.

Date

Signature of other members of the
thesis committee.

Dr. Raj Sodhi
Director
Manufacturing Engineering Dept.
Assistant Professor
Mechanical Engineering Dept.

Date

Dr. Meng Chu Zhou
Assistant Professor
Electrical and Computer Engineering Dept.

Date

VITA

Name: Shilpan K. Patel

Degree and date

be conferred: M.S. Manufacturing Engineering, May 1991

Secondary Education: Experimental High School, Baroda, Gujarat

Collegiate institutions attended	Date	Degree	Date of Degree
----------------------------------	------	--------	----------------

New Jersey Institute of Technology	Jan 1990- May 1991	MSMnE	May 1991
------------------------------------	-----------------------	-------	----------

M.S.University	Aug 1981- Dec.1985	BSME	Jan.1986
----------------	-----------------------	------	----------

Major: Manufacturing Engineering

ABSTRACT

Title of Thesis: Development of a Classification and Coding System for Computer Aided Process Planning.

Shilpan K. Patel, Master of Science in Manufacturing Engineering, 1991

Thesis directed by: Dr. Nouri Levy, Professor in Mechanical Engineering Department, New Jersey Institute of Technology

The chore of this work was to develop a Group Technology Classification Code which can represent the full gamut of simple, rotational parts. The automated coding plan is developed to alleviate the endeavor of the process planner to plan the tasks related to the manufacturing of a specific part. The 15 digits were devised from the Japanese KK - 3 Classification and Coding system. The KK- 3 System contains 21 digits. Our aim is to minimize the code length, and concurrently to eliminate the redundancies. As a result, a 15 digit G.T. Code is created. The proposed plan also generates the operation logic with the aid of the 15 digit G. T. Code and the machines available in the database of the system. The program is designed to run on vax/vms 5.1. The program for the work has been written in Fortran - 77.

DEDICATION

To my parents and my wife krishna

ACKNOWLEDGEMENTS

I take this opportunity to express my deep gratitude to Dr. Nouri Levi, professor, Mechanical Engineering Department of N.J.I.T. for his valuable guidance and help throughout the course of this work. It was his immaculate advise, which led my work to the set mark of culmination.

I am also very thankful to Dr. Raj Sodhi and Dr. Zhou for spending their precious time to review my work and to provide constructive suggestions for enhancing my work.

Finally, I would like to thank my wife Krishna for her passion, help and understanding during the epoch of my study.

CONTENTS

	DEDICATION	ii
	ACKNOWLEDGEMENTS	iii
CHAPTER I	INTRODUCTION	1
	A. Introduction to Group Technology	1
	B. Part families	2
	C. Introduction to classification and coding	6
	1. Concept of monocode	7
	2. Concept of polycode	8
	D. Benefits of classification and coding	10

E. Significance of classification and coding in manufacturing	11
F. Process planning	13
G. Need for automated process planning	15
H. Variant and Generative process planning	19
1. Variant approach	19
2. Generative approach	21
I. Methods of generative process planning	22
J. Benefits of automated process planning	24
K. Implications of Group technology in factory automation planning	25
L. Future prospects of Group Technology	26
M. An outline of what to follow	29
CHAPTER II LITERATURE REVIEW	30
A. Classification and coding systems	30

1. Origins and background of the coding systems	34
2. Opitz system	35
3. The code system	36
4. The KK - 3 system	38
5. The MICLASS system	40
6. DCLASS system	43
7. COFORM	45
8. Brisch system	51
B. Process planning systems	54
1. CAM-I CAPP	54
2. MIPLAN	58
3. Computerized production process planning	59
CHAPTER III CLASSIFICATION AND CODING PLAN	62
A. Statement of work	62
B. Comparative study of the KK-3 System and ACPLAN	63

	C. The system overview	65
	1. Classification and coding module	66
	2. Machines available with their specifications	67
	3. Process sequence and operation logic	67
	4. Part specifications	67
	5. Operation logic module	67
	D. Program illustration - Part: Sleeve	79
	E. Operation Logic: Part: Sleeve	92
	F. Program illustration - Part: Bushing	93
	F. Operation Logic: Part: Bushing	103
CHAPTER IV	EPILOGUE	104
APPENDIX A	AN OVERVIEW OF THE KK-3 CLASSIFICATION AND CODING SYSTEM	107
APPENDIX B	MACHINES AVAILABLE	121
	BIBLIOGRAPHY	124

LIST OF FIGURES

Fig. No.	Description	Page
1.1	Percentage of the life of the average workpiece in the batch - type metal cutting production shop	28
2.1	Mapping from the population space to the code space	32
2.2	MICLASS code structure	42
2.3	Brisch code hierarchy	53
2.4	CAPP system: Flow diagram	57
2.5	Flow diagram of the MIPLAN system	60
3.1	ACPLAN: Schematic diagram	70
3.2	ACPLAN: flow diagram of the operation logic	74
3.3	Part for illustration: Sleeve	81
3.4	Part for illustration: Bushing	94

LIST OF TABLES

No.	Description	Page
1.1	Success rate of different sectors of manufacturing	18
2.1	Different code representation schemes	33
2.2	Structure of the Code system	37
2.3	Structure of the KK - 3 system	38
2.4	The DCLASS code structure	43
2.5	DCLASS structure: An example	48
3.1	Structure of the ACPLAN	71
3.2	Structure of the KK - 3 system	72

INTRODUCTION

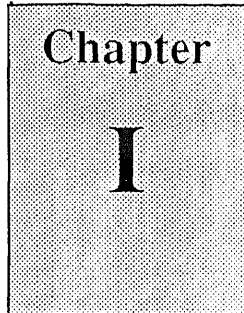

*Transcendence transpires innovations
to the heart of cognizance.*

A. An Introduction to Group Technology

Group technology is a system of many names and definitions. It is also known as Part Family Manufacturing, Family Planning, Family Grouping, and by a number of other names in U.S.A., Germany, Japan, Russia, the U.K., and other countries.

Definition of Group Technology

“Group Technology is the realization that many problems are similar, and that, by grouping similar problems, a single solution can be found to a set of problems thus saving time and effort[10].”

“Group Technology is a method of manufacturing piece parts by classification of these parts into groups and subsequently applying to each group similar technological operations. The major result of these methods of manufacture is to obtain eco-

nomics which are normally associated with large scale production in the small scale situation and it is therefore of fundamental importance in the batch producing and jobbing sections of industry.”

Historical background of Group Technology

Group Technology has been practiced in numerous ways since the beginning of the century. In Europe, the Germans used it somewhat in World War II and then the Swedes used it in around 1948. In 1954 the Russians took renewed interests in G.T. and its development as a manufacturing technique culminated by S.P. Mitrofanov in his classification method for production purposes. His work was followed closely by H. Opitz of West Germany and E. Brisch of the United Kingdom. Today, over 30 systems are available. Many of the classification and coding systems that support Group Technology are available in public domain and others are marketed by various commercial enterprises. Certainly with estimates that batch production represents up to 75% of all manufactured parts, it is understandable that group technology is finding more and more application in industry [16].

B. Part families

A part family or group is defined as a collection of related parts which are nearly identical or similar. They are related by geometric shape and/or size and require similar machining operations. Alternatively, they may be dissimilar in shape, but related by having all or some common machining operations.

Parts said to be similar in respect to production technique when the type, sequence and number of operations are similar. This similarity is therefore related to the basic shape of the parts or to a number of shape elements which are contained within the part shape. The type of operation is determined by the method of machining, the method of holding the part, tooling required and conditions of cutting. Also, if parts are to be manufactured together, the number of frequency with which they occur must be taken into account. The more similar the production requirements, the easier it is to define the part family.

The grouping of related parts into families is the key to the Group Technology concept. These families may be constructed in one of the two ways as follows:

(A) The first type of part family consists of parts which are similar in shape within a certain dimensional range, and have most or perhaps all machining operations in common.

(B) The second type of part family consists of parts of dissimilar geometry, but has one or more machining operations in common. This is a similarity in production process rather than form or size.

The problem which immediately presents itself is how the parts are to be efficiently grouped into these families

There are three basic methods exist to resolve this enigma.

- (a) Peripatetic and ocular method
- (b) Production flow analysis and
- (c) Classification and coding system.

The Peripatetic method is used for very limited results. Practically, this method is confined to a small range of results as it has many shortcomings[5].

Production flow analysis is a technique to analyze the operation sequence and the routing of the component through the machines in the plant. Parts with common operations and routines are grouped and identified as a manufacturing part family. Similarly, the machines used to produce the part family can be grouped to form the machine group or cell. Of course, for successful use of this production flow analysis method, it should be assumed that the majority of parts in a company belongs to clearly defined families and the machines to clearly defined groups. One of the advantages of this method is to form part family without using classification and coding system, since it establishes part families using data from operation sheets. There are a number of disadvantages in practice due to its reliance on the existing production data and routing methods and also due to difficulties in manufacturing and sorting of production data by manual means.

The classification system allows a comprehensive examination of all active parts in the process of forming groups of parts or part families allowing these groups to be formed regardless of the origin or the use of the parts. Using a suitable classifi-

cation and coding system, there are a number of approaches to the formation of part families. Those approaches could be depicted as follows:

(a) A Part occurring within defined time period is classified and coded, examined with respect to similarity of their production processes, and collected into part families for sequential manufacture in a functional layout machine shop. The advantage of this approach is that only parts actually required for production are considered. The major disadvantage is the expense involved in incessantly forming part families which exist only for the defined production period. Besides, this method does not allow the establishment of part families and permanent machine groups.

(b) The second approach concerns with formation of part families from one of the company's products. This has the advantage of working in the defined area, and obtaining drawings and production data for classification and coding exercise is simplified. However, the part families formed may be more complex. This approach can be used as a short-term measure to create a pilot machine group and each product can be dealt with in order of priority.

(c) The third approach requires the part families to be based on a total analysis of parts from the company's complete product range. This presupposes that all parts have been classified and coded. This is the most preferable method. The drawings and associated production data of the selected parts are collected together

and coded according to the classification system and sorted in code number order.

C. Introduction to Classification and Coding

Classification is a means of retrieval. A designer needs to retrieve designs to obtain relevant information and to utilize existing components in the new products. A provision must be made for performing such tasks efficiently. From such provisions, there will be significant economic gains, since unnecessary new designs will be avoided and the use of the existing designs will produce an additional return on past investment. Retrieval is also necessary in connection with costing, re-fluxing, planning and standardization, and in each instance, comparisons need to be made in order to avoid errors and anomalies which leads to unnecessary varieties.

Classification categories are symbolized by *codes*.

Classification leads to the identification of an item and the code provides a unique item identity. A code is one or more symbols to which an arbitrarily assigned meaning and/or arrangement has been given, which, when deciphered, communicates specific information or intelligence[2]. Industrial coding may takes several forms. There are codes that are applied to classification which integrate a number of parameters within a single code character- entitled MONOCODES. Another type of code that relates to a single parameter, feature or descriptor, is entitled

POLYCODE. The combination of the two codes is called MULTIPLEX CODES (MULTICODES).

Monocode

Monocode [2] is an integrated code of fewest characters to distribute evenly a classification of a population of items where each code character is qualified by the preceding code and, in turn, qualifies the succeeding code.

Polycode

Polycodes [2] are one or more code symbols assigned to one or more features or characteristics predicted to occur in a population of items for specific needs.

1. Concept of Monocode

The monocode is designed to satisfy 90% of the data retrieval needs for any organization. The selection of the parameters, i.e., number and order of placement while subjective to some extent --primarily serves to provide engineering needs for data visibility to prevent proliferation of variety of materials and components in the product. Manufacturing has slightly different needs. The significance of monocode could be explained in concise for the typical factory scenario. A product engineer will want to see the variety of classified components which are similar in shape or function with little concern for the process for manufacturing the part. The manufacturing engineer, on the other hand, will want to see the operation se-

quence, with the shape and /or function of the part of secondary importance. Similarities in process can exist even though the parts may be classified in several different families. The major significance of monocode exists for its extensive use for product research, design improvement, engineering change(s) which affect multiple parts, as well as design variety control. There is an average of 4.3 to 4.8 retrievals in product engineering for every part number released in the life of the part. Another consideration is that almost every part can be processed in more than one way due to conditions which are themselves non permanent. The fact is, that within any family of monocoded parts, one process may suffice for all-- or there may be two, three, or even four different processes. On the other hand, one process routing sheet with provision to reflect predictable variations may serve many families.

2. Concept of Polycode

Where additional or specific data are required that are highly desirable for one functional user but of little or no consequence to any other, such data are best coded using polycodes in conjunction with the monocode identifier of the whole part. Polycodes are used by trailing them behind the Monocode. Polycodes deal with a single detail each, usually with one code for each. In some cases, several code positions may be required due to the variation or degree of specificity. One vital difference between Polycode and Monocode needs to be taken in to account. Polycode (*feature or descriptor*) enables a horizontal search across the board, irre-

spective of other characteristics. In contrast, the Monocode is a vertical search and analysis tool. Most coding schemes are Polycode, but do not include the Monocode as the unique identifier. Polycoding requires no specific coding skill to develop. Polycodes-- variously referred to as feature codes, trailer codes, may take a variety of forms and formats. While they may have their differences i.e., more than one code position, alpha, or alpha-numeric, or all numeric, even direct read: e.g., 0=one, 2=two, and so on, they do have one thing in common. They deal with a single feature-- each code, expressed schematically, a Polycode formatted code is represented by the following:

POLYCODE

$$\begin{array}{ccc} \uparrow & \uparrow & \uparrow \\ \textit{First} & \textit{Second} & \textit{Xth} \\ \textit{feature} & \textit{feature} & \textit{feature} \\ \hline \textit{N1/A1} + \textit{N2/A2} + \dots + \textit{NX/AX} \end{array}$$

A true manufacturing process-oriented polycode would reflect set-up and holding data, surface finish, and accuracy; the actual process, lot quantity and the like. The aim of these codes is to standardize the technological process and/or to reflect lot size variations.

D. Benefits of Classification and Coding

There are numerous classification and coding systems in existence today. The best coding system is one which is adapted specifically to the industry or company where it is used. To insure this, a company can devise its own classification system based upon either universal systems or some other tailor-made system installed by outside consultants or experts. This is one of the key features which needs to be considered for achieving culmination.

Summary of benefits[3] derived from a well designed classification and coding system could be depicted as follows:

- (1) Formation of groups of parts (part family) and machine groups.
 - (2) Quick retrieval of designs, drawings and production plans.
 - (3) Design rationalization and reduction of design costs.
 - (4) Secure reliable work piece statistics.
 - (5) Accurate estimation of machine tool requirements, rationalized machine loading and optimized capital expenditure.
 - (6) Rationalization of tooling set-up and reduction of set-up time and overall production time.
-

-
- (7) Rationalization and improvement of tool design and reduction of tool design time and cost, and fabrication time and cost.
 - (8) Rationalization of production planning procedures and scheduling.
 - (9) Accurate cost accounting and cost estimation.
 - (10) Better utilization of machine tools, workholding devices and manpower.
 - (11) Improvement for NC programming and effective uses of NC machines.

E. Significance of Classification and Coding in Manufacturing

The key area of application of classification and coding systems is through *design data retrieval and rationalization*. Not only design information, but material requirements, production planning and other production information will be readily available, so that all relevant production information can be retrieved for scheduling, group machining, tooling and set-up. A classification and coding system also facilitates an extensive variety of reduction and standardization on programs which is valuable to the company itself as well as a great aid to G.T. application. It has been reported[16] that an average cost of introducing a new part into engineering and manufacturing system is around \$1,300 to \$2,500 (average \$1,900) per part. For example, a company reported that about 2,500 new parts were released annually (thus an average of ten new parts every day), while about 30,000 active parts were in their design files. Therefore, it can easily be estimated that the annu-

al cost of new part introduction becomes \$4,750,000 per year (=2,500 parts X\$1,900 per part). So it makes clear how much one can save by eliminating duplication of parts and thus reducing the number of new parts. It has also been reported that about 5-10% of annual new parts output could be avoided by the proper use of classification and coding systems. Thus, a company can save about \$237,500 to \$475,000 in reduction of duplicated design alone.

Activities affected by introduction of a new part

Activities affected by introduction of a new part can be divided in to two major groups. they are ascribed as follows.

1. Engineering activities

- (a) Design and detail drafting
 - (b) Protocol building
 - (c) Testing and experimentation
 - (d) Auditing and costing
 - (e) Records and documentation
-

2. Manufacturing and Finance activities

- (a) Advance manufacturing engineering (central)
- (b) Manufacturing engineering (plant)
- (c) Tool design and tools & gages
- (d) Time study and standards
- (e) Production control and scheduling
- (f) cost accounting
- (g) Purchasing and inventory
- (h) Quality control

F. Process Planning

“Process planning is a subsystem responsible for the conversion of design data to work instruction [6].” In profound explanation process planning could be defined as that function within manufacturing facility that establishes the machining processes and parameters to be used (as well as those machines capable of performing these process) in order to convert (machine) a piece-part from its initial form to its final form predetermined (usually by a design engineer) on a detailed engineering drawing. The initial material may take a number of forms; the most common of

which are bar stock, castings, forgings or maybe just a slab of metal. This slab of material is normally a burn-out (a part produced by a flame cutting operation) cut to some rough dimension. This slab might have almost any shape.

With these types of raw materials as a base, the process planner must prepare a list of those (machining) processes needed to convert this normally predetermined material into a specified final geometry. The most common processes that a process planner has at his disposal are turning, facing, milling, drilling, reaming, planing, sawing, trepanning, brushing, punching, and grinding. Some manufacturing people may consider some of the operations as subsets of a major category. Others may define further categories. A few examples of this are: Reaming is often considered a subset of drilling, and trepanning is often considered a type of gun-drilling.

With above processes and specific set of machine tools at his disposal, the process planner relies on his experience to develop that set of processes capable of producing a part. The selection of processes is not an entirely random phenomenon. As a matter of fact, there are usually more than one process capable of producing specific surface; therefore, the process planner must choose what he feels is the best process. This is normally done by recalling similar parts or at least similar surfaces and recalling the means utilized in machining this part. In this way, the planner compares specific processes used to obtain some final specification

and chooses what he feels is the best alternative. This sort of planning is known as man-variant planning.

G. Need for Automated Process Planning

Process plan creation is a central activity in the orderly and efficient operation of a manufacturing enterprise. Once a product has been designed, the process planner's work probably has more impact on the cost, quality and rates of production than any other company activity. A Well-formulated process plan can provide products that meet quality, quantity, timing and cost objectives. If a process plan mismatches process capabilities with product requirements, however, the result can be excessive scrap and rework, low output, excessive in-process inventory, and high production costs.

Most problems with current manual planning methods exist [22] because the methods depend on such subjective factors as the planner's previous experience, personal preference, extent of shop knowledge, interpretation of design requirements, and judgment. At worst, this subjectivity results in inaccurate or inconsistent plans and/or high production costs.

In addition, manual process planning requires continual education of planners as new processes and equipments are introduced. The current shortage of experienced and dexterous planners is another critical issue in consideration. The future

seems agonies as experienced planners retire. The loss of this knowledge base could seriously jeopardize industry.

Studies [7] have shown that it generally costs between \$13,00 and \$2,500 in preparation costs to introduce a new part to manufacturing. Mistakes, such as routing a part across inappropriate machine tools, can be very expensive. Systems designed to eliminate unnecessary errors and increase production efficiency are being used in many manufacturing environments. One such system is computer aided process planning.

The innovation of the computers promised significant reduction in manual clerical work, in part by making possible the use of electronic rather than paper filing systems. The initial application of the computer to process planning was as a file system and printing machine. The process planner would prepare the plan in the usual manual way and then turn it over to some one who would key punch the text into the computer. It was stored in the computer, almost always by part number, and printed when needed. The process planner could retrieve the process plan at a later date, provided that he or she remembered that the part has been manufactured and knew the part number.

This use of computers may help to reduce the time and effort required to produce a process plan but its contribution is marginal. In fact, it amounts to using a very expensive computer as a printing machine. However, with the proper part num-

bering scheme it is possible to take advantage of retrieval possibilities of such a computerized system.

Computer aided process planning (CAPP) goes well beyond the computer retrieval. The major feature of CAPP is that the planner can use the computer not only to retrieve the existing plan, but also to perform other, even more important tasks, such as creation of standardized process plans which reflect optimal routings and process operations. With a proper CAPP system it is also possible to retrieve existing process plans using more than one identifier. Combined with coding and classification, group technology and standardization of process plans, it can have a tremendous impact on manufacturing costs and on the time required to design and produce manufacturing parts. The ultimate aim of this system is to help improve productivity in manufacturing, albeit the reduction in clerical time and other savings involved in actual creation of plan is also vital.

CAPP is more a production tool than a *management information system*. In its simplest configuration, CAPP is a means of storing and writing process plans electronically. The most vivid element of an effective CAPP system is its ability to retrieve information. System that retrieve information based on part numbers are quite common, but they have serious limitations. A part number is an arbitrary identifier. For retrieval, the system user must know that the part in the file is similar to or the same as the part entering manufacturing. A part family code number on the other hand, contains information about part attributes (shape, holes, cones, di

ameter, tolerances, etc.), and the user can code a new part and compare its number to code number in the file. This is usually done through an interactive procedure with the computer. The computer asks simple questions about the attributes of the part, and the user replies. When the computer has enough information, it generates a code number. Next, the code found can be used in the retrieval process for parts which have similar manufacturing characteristics. The former step shown is the aim of this thesis. It provides a classification and coding scheme, which would help user coding parts of similar attributes. Later step involves formation of part families. This step indicates the area of major expansion of the work done in the present thesis.

Table 1.1: Success rate of different sectors of manufacturing[10]

	SUCCESS RATE	RETURN
MATERIAL REQUIREMENT PLANNING	25%	100%
GROUP TECHNOLOGY	MORE THAN 50%	150%
COMPUTER AIDED PROCESS PLANNING	MORE THAN 80%	500%
COMPUTER AIDED DESIGN	90%	100%
NUMERICAL CONTROL	90%	150%

H. Variant and Generative Process Planning

Conceptually, a generative process planning system makes it possible to automatically create process plans from scratch using only the part descriptions stored in the data base. The process plan is generated without any human intervention.

On the other hand, variant process planning is generally defined as the retrieval of a best (or standardized) manufacturing plan developed in the past, and the varying of the plan to suit the occasion. It is a means of process plan retrieval for a part for editing of the existing plan for the specific requirements of the part.

1. Variant Approach

The variant approach is limited to modifying standard process plans—that is, to producing variant of existing process plans. This system uses the similarity among the components to retrieve the existing process plans. A process plan that could be used by a family of components is called a *standard plan*. A standard plan is stored permanently in the data base with a family number as its key. There is no limitation as far as the range of information contained in the standard plan is concerned, however, it should contain the sequence of operations involved. When a standard plan is retrieved, a certain number of changes are obvious in order to use the existing plan for the new part. The mechanism of standard plan retrieval is

based on *part families*. A part family is usually represented by the means of family matrix which includes all the member of the family.

The variant approach has two stages of development: Preparatory stage and Production stage

(A) Preparatory stage

In this stage, existing components are coded, classified, and finally grouped into families. A family matrix is then evolved for each family. Next, processes are summarized for each component contained in the family. A standard plan is then prepared and stored in the database and indexed by family matrices. This stage requires enormous time for its completion.

(B) Production stage

This stage is needed at the time of production of the components. Novice component can easily be coded now, code is then input to part family search routine in order to find the family to which the new component belongs. The family number can then be utilized to retrieve the existing plan. If required, the planner may append the existing plan to make it suitable for the new component design.

The major disadvantages [5] of the variant approach can be summarized as follows:

-
- (a) The endeavor needed to develop a suitable standard plan
 - (b) The difficulty of maintaining consistency in editing practices
 - (c) Inability to adequately accommodate combination of geometry, precision, material, quality, and shop loading
 - (d) The rather extensive keyboard activity is required to enter and modify plans

The major advantages of the variant approach can be summarized as follows:

- (a) The production stage is fairly stable
- (b) Lot size is medium high (the range depending on the product)
- (c) Parts within a family are of similar size
- (d) Material type is the same for all members of the family

Few engineering changes normally occur.

2. Generative Approach

The generative approach can be depicted as a system for rapid creation of consistent, repeatable process plans based on a series of predefined algorithms.

These predefined algorithms may include decision-tree logic, classification theory, key words, mathematical models, and formatting routines. The major advantages

of generative process planning are the rapidity and consistency of plan generation and the ease of incorporating new processes, equipments, methods, and tooling into the plans. In the generative approach, process plans are created from information available in a manufacturing database without man intervention. Upon receiving the design model, the system can generate the required operations and operations sequence for the component. Knowledge of manufacturing must be encoded into efficient software. The generative approach requires following vital developments:

- (1) The logic of the process planning must be identified and stored appropriately.
- (2) The parts to be manufactured must be profoundly defined in computer compatible format (e.g. G.T. code).

Ideally, a generative process planning system is a turnkey system with the all decision logic contained in the software. In other words, system contains all required information for automatic process plan generation, which precludes the necessity of the preparatory stage.

I. Methods of Generative Process Planning Systems

The usual methods employed are called forward and backward methods. Each will be explained in concise as follows:

In generative process planning system, when a process plan is generated, the system must define the initial stage in order to reach the final stage or say goal. The path taken (initial -> final or final -> initial) represents the sequence of processes. If a planner works on modifying the raw workpiece until it takes on the final design qualities, the process employed is called *forward planning*.

Backward planning uses a reverse process. Assuming that we have a finished component, the goal is to fill it to the unmachined workpiece shape. Each machining process is considered a filling process. For example, a drilling process can fill a hole; a reaming process can fill a thin wall (cylinder); and so on.

Forward and backward planning methods have some distinct differences between them. They usually affect the way of planning the process. Planning each process can be characterized by a precondition of the surface to be machined and postcondition of machining (its results). For the forward planning, we must know the successor surface before we select a process, because a postcondition of the first process becomes the precondition of second process. As an illustration, when we select the drilling, for the threaded hole, we know that the thread is going to be cut. Therefore, we rough drilled the hole using the smaller drill. Otherwise we might have used larger drill and no thread could be produced. Backward planning eliminates this problem due to the path it takes for the planning. It commence with the final surface form and processes are selected to satisfy the initial condition or something less accurate in nature, while in the forward planning, the goal or the

objective surface needs always to be maintained eventhough several operations must be taken to guarantee the final result.

J. Benefits of Automated Process Planning Systems

An automated process planning method promises many interesting benefits. A few of these are a reduction of indirect labor, a decrease in lead time, and a completeness of manufacturing information. The reduction of indirect labor is the result of automating a basically manual effort. Automation can help avoiding the humdrum tasks which are basically depends on the skill level of the individual. The decrease in lead time is also the result of automation. The process planning and selection time will not only be reduced considerably by use of computer, but design of the parts difficult to manufacture can be recognized early in its revolutionary process. Obviously, it is usual to miss the detail when planning is done manually. When planning is computer controlled, complete planning information would be expected.

One of the advantages includes reduction of tooling. By scrupulously planning parts and part families, special tooling can be reduced considerably. As a supplement, this benefit could be used as a design aid for machine tools. Frequency of operations, required axis, force requirements are all output of a typical automated process planning chore.

Automation of process planning activities promises all of above mentioned benefits, but one has to follow the norms stated as follow:

- (a) Use only data available on the drawing
- (b) Elimination of all subjective choices
- (c) Consistency in production of the same plan for the same part
- (d) Require minimal training and typing skills
- (e) Allow manual intervention for the complex parts
- (f) Easily incorporate new production techniques in the system logic
- (g) Permit system operation on a small-to-medium-sized computer

K. Implications of Group Technology in Factory Automation

The role of the group technology in the factory automation planning has clear implications to the system engineering portion of the planning effort. If we are able to carefully examine each unit of the existing production system and to determine how it is currently set up and operated; what it is good and what it is not good at; and, how it needs to be modified to perform the integrated manufacturing tasks, we are on our way to understand the requirements of a new factory system.

With the hands on knowledge gained by this analysis we are in position to redesign the individual units of production to become part of better focused and less complex manufacturing system. By focusing the group technology tasks to the most critical area of the completion of a job, its chances of success and ultimate payback have been greatly enhanced.

The group technology has the potential [16] to reduce the capital equipments tooling expenditure, eliminate unnecessary complex and oversized computer and control system installation, and reduce large support structure necessary to maintain and update the system capabilities.

L. Future Prospects of Group Technology

One of the major enigmas in increasing manufacturing productivity is economic incentives. Manufacturing usually [10] contributes approximately 30% of the gross national product of modern industrialized countries. Paradoxically, manufacturing activity is not highly productive as it seems to be. For example, this is absolutely true for batch-type mechanical manufacturing systems (e.g. automotive transfer line) accounts for less than 25% of mechanical parts manufacture. As a matter of fact, 75% of such parts are manufactured in lots consisting of less than *fifty pieces*. It has been reported that in batch type metal cutting production shops, only about 5% of its time is actually spent on machine tools, and of that 5%, only 30% (or say actually 1.5% of the overall time) is spent as productive time in removing metal. This phenomenon is depicted in the figure on page 28.

This is a sermon for the industries expecting higher productivity. The expected higher productivity could be gained by means of employing group technology and also computer integrated manufacturing.

The efficient utilization of machine tools is a prerequisite for the establishment of an automated manufacturing. This can be feasible by the implementation of group technology.

A forecast for the future production advancement has been done by two prominent organizations [6] named University of Michigan and International Institute for Production Engineering Research (CIRP). The forecast shows [13] that the automated factory could be in full fledge in the future. It is of interest to note that, by 1988 more than 50% of the industry will use group technology in the manufacture (Report from the University of Michigan), by 1990 70% of the industry will use group technology in manufacture (Report by CIRP). The new technological innovations like DNC, CNC, ROBOT are very important for integration of manufacturing systems involving CAD/CAM. The group technology will become the key factor for achievement of integration of manufacturing systems. The prolific innovations in the group technology concept will help us make proper adaptation of the CAD/CAM systems in the automated manufacture.

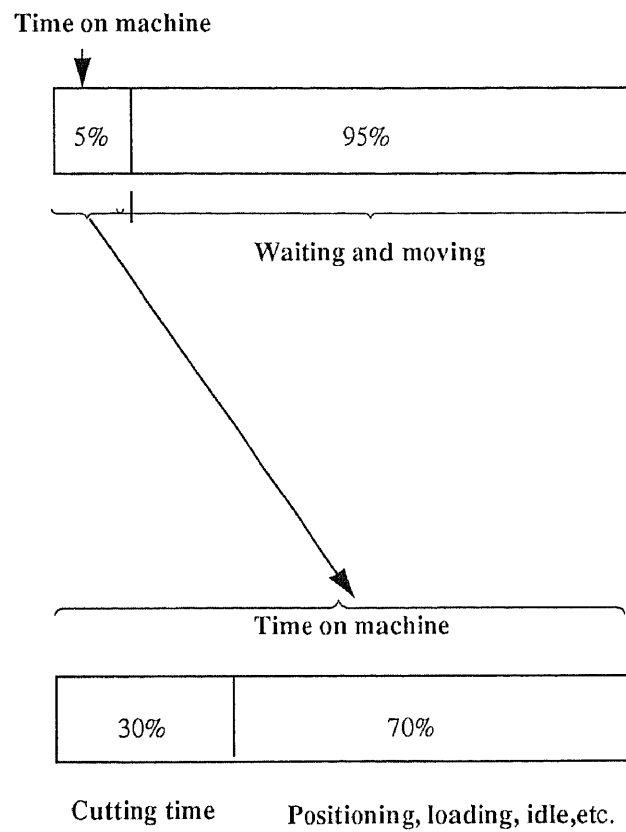

Figure 1.1: Percentage of the life of the average workpiece in the batch-type metal cutting production shop

M. An outline of what to follow

Chapter 2 is a literature survey of the existing classification and coding systems. It also provides focus on the existing computer aided process planning systems.

The aim is not to go into the nitty-gritty detail of the systems, but to give a flavor of the different existing systems.

Chapter 3 ascribes the proposed classification and coding plan and its related operation logic mechanism. Numerous illustrations are given for user's quick reference.

Chapter 4 presents conclusion of the work and shows the area of improvement for the future research.

LITERATURE REVIEW

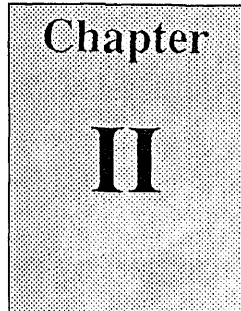
A rectangular box with a halftone background. The word "Chapter" is written in a serif font at the top, and the Roman numeral "II" is centered below it in a larger, bold serif font.

Chapter
II

“As knowledge increases,

wonder deepens. “

-Charles Morgan.

This chapter primarily does literature survey of the existing classification and coding systems as well as automated process planning systems. Its purpose is to give a panorama of the existing methodologies of the above mentioned systems.

A. Classification and Coding Systems

There are numerous classification and coding systems available in the present time. Before we get into the survey of those different systems, let us go through the concept of group technology coding. When constructing a coding system for a component's representation, we need to consider several factors. They are as follows[3]:

(1) The population of the components (i.e. rotational, prismatic, deep drawn, sheet metal, etc.)

-
- (2) The detail the code should represent
 - (3) The code structure: chain, hierarchical, or hybrid and
 - (4) The digital representation (i.e. binary, octal, decimal, alphanumeric, hexadecimal, etc.)

All of these factors have to be taken in to consideration at the infant stage of designing a coding system for a particular component for getting better output from the system.

In component coding, it is also true that only those features that *vary* needs to be included in the code. When one designs or uses a coding scheme, two properties must hold true:

- (a) The code must be unambiguous and
- (b) The code must be complete

We can define code [3] as a function H , which maps components from a population space P in to a coded space C as shown in the figure on the next page.

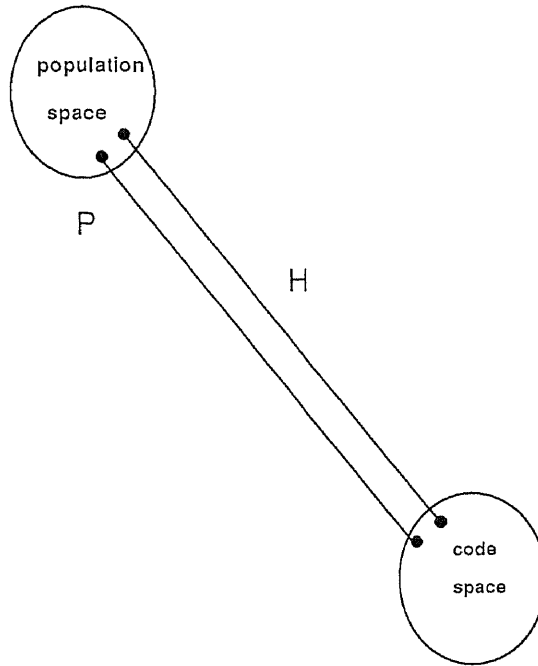

*Figure 2.1: Mapping from the population space
to the code space*

The above mentioned properties suggest that each component in a population has its own unique code. The code always needs to be concise, however when vast information is required, it is advisable to construct a longer code. One of the prominent considerations in the coding system construction is the code digits. Several positional alternatives can be selected. However, this selection yields different precision for the different schemes. For illustration, an N-digit code with [8] - different coding features yields the following combinations of the code.

Table 2.1 : Different code representation schemes

Binary	2	(0,1)
Octal	8	(0,1,.....,8)
Decimal	10	(0,1,.....,9)
Hexadecimal	16	(0,1,.....,9, A,.....F)
Alphanumeric	(25+10)	(0,1,.....,9, A,.....Z)

Alphanumeric system is the most compact, but it is difficult to handle both alpha and numeric characters.

It is of most concern to represent the basic features of the design while designing a coding system for a component. An engineering component can be represented [11] by its basic shape, secondary features, size, tolerance, critical dimensions, material and so on.

(a) Most components of similar shape can be produced by the same set of processes but the opposite is not true in all the cases.

(b) Secondary features such as auxiliary holes, gear teeth, threads, chamfers and so on, are also important and can dictate a different set of process plans and

(c) The workpiece material is equally important. Tools for machining cast iron are not appropriate for machining alloy steel. Feeds and speeds used for machining also depend on the material.

1. Origins and Background of the Coding System

Classification and coding in industry is known since the advent of the scientific management. Taylor [15] espoused the technique and, in fact, his mnemonic code for tools was the basis of the Twist Drill Manufacturers Association code for perishable tools. This code was used during world war I and until world war II, when an explosion of variety caused it to break down.

“A classification is essential to an orderly arrangement of the facts relating to a business and to the orderly conduct of its activities. During the period of the devel-

opment and installation of a system of scientific management, it is especially helpful to a proper visualization and understanding of the business and its problems as well as to the conduct of the work [15].”

Modern industrial classification and coding, dates back to a day in September, 1948, when Edward Brisch and Joseph Gombinski [14] agreed to pool their extensive knowledge and engineering experience to resolve the problem of engineering information and technical data retrieval.

In October 1948, English Numbering Machine, Ltd. became the first client of the U.K chartered firm, E. G. Brisch and partners Ltd., and industrial classification and coding.

Now, we will discuss the different coding systems: Optz system, the Code system, the KK-3 system, the MICLASS system, COFORM, and the Brisch system.

2. Opitz System

The Opitz coding system [20] was developed by H. Opitz of Aachen Tech. University in West Germany. The Opitz code uses mixed code structure. It consists of a geometric code and a supplementary code. The geometric code can represent parts of different variety like rotational, flat, long, and cubic. A dimension ratio is used in classifying the geometry; the length/diameter ratio is used to classify rotational components, and length/width and length/height ratios are used to classify the nonrotational parts. The Opitz geometric code uses five decimal digits, each

representing component class, basic shape, rotational surface machining, plane surface machining, auxiliary holes, gear teeth, and forming. Primary, secondary, and auxiliary shapes can be represented using the five geometric digits.

Opitz code, in addition to a geometric code, usually consists a supplement code of four digits. The first digit represents the major dimension (diameter or length). The approximate component size can then be figured out using the dimension ratio specified in the geometric code. The dimension range is specified from 0.9 to 80. Dimensions of less than 0.8 and greater than 80 are represented by 0 or 9 code, respectively. The material type, raw material shape, and accuracy are represented by digits 2, 3 and 4.

This coding system is currently used at Lockheed-Georgia company in their automated process planning system.

3. The Code System

This system has been concocted [2] by the Manufacturing data system. Inc. (MDSI). It as an eight digit, mixed code structure. The significance of the system is that each code can be represented by a hexadecimal value. Hexadecimal value allows more information to be presented with the same number of digits. Code brings together like things by shape, relative size, material and other data base items. The Code system describes the manufacturing processes in an orderly manner. The system is based on the *polycode principle*. During the actual classifica-

tion process, an eight digit code is first selected step-by-step for each design. The general description of each digit is shown in the table 2.2.

Table 2.2 : Structure of the Code system

first digit	describes part's basic shape
second digit	O.D. or section
third digit	center hole
fourth digit	holes (other than center hole)
fifth digit	grooves (external-internal)
sixth digit	miscellaneous
seventh digit	maximum O.D.
eighth digit	maximum overall length

The interesting feature of the Code lies in its capability to store information related to the part, such as design data, process plan etc. This is possible as the system works not only as the coding system but also as a data base system.

4. The KK-3 System

This is a coding system [10] designed for machining parts. This was developed by the Japan Society for the Promotion of the Machining Industry. This system contains *21 digit decimal system*. More number of digits enables the system to represent more information. The general description of each code is shown in the table 2.3.

Table 2.3: Structure of the KK-3 system

DIGIT	CLASSIFICATION ITEMS
1	general name of the part
2	detailed name of the part
3	general classification of material
4	detailed classification of material
5	length of the part
6	diameter of the part
7	primary shapes and ratio of major
8	external surface and outer primary

Table 2.3 (Continued)

9	concentric screw threaded parts
10	functional cut-off parts
11	extraordinary shaped parts
12	forming
13	cylindrical surface
14	internal primary shape
15	internal curved surface
16	internal flat surface and cylindrical surface
17	end surface
18	regularly located holes
19	special holes
20	noncutting process
21	accuracy

5. The MICLASS System

This system was developed [17] by TNO of Holland, and is currently maintained in United States by Organization for Industrial Research. It is a chain structured code of 12 digits. The code is designed in such a manner that it includes both design and manufacturing information. The types of information include main shape, shape elements, position of the elements, main dimension, ratio of the dimension, auxiliary dimension, form tolerance, and the machinability of the material. Some of the significant features [10] of the system are as follows:

(1) Reliability:

It has been observed that most of the classification systems starts accurately but within a short horizon of period errors may run as high as 30 to 40%. MICLASS has a usual error rate of 2 to 5%.

(2) Special products:

It has capability to accommodate special products as well as those which are common to the user's operations.

(3) Operation and shape:

It does not only tracks the shape of the workpiece but also describes the workshop operational requirements to produce a specific product. Thus it helps the task of production, planning and control.

This system classifies the different characteristics of the product. Those characteristics includes,

- (a) main shape
- (b) Shape element
- (c) Position of the shape element
- (d) Main dimension
- (e) Ratio of dimension
- (f) Auxiliary dimension
- (g) Dimensional tolerance and roughness
- (h) Form tolerance
- (i) Material

The system can be adapted to include additional features like,

- (a) Company drawing number
 - (b) Company nomenclature
 - (c) Lot size
-

:

1	MAIN SHAPE
2	SHAPE ELEMENTS
3	
4	POSITION OF SHAPE ELEMENT
5	MAIN DIMENSIONS
6	
7	DIMENSION RATIO
8	AUXILIARY DIMENSION
9	TOLERANCE CODES
10	
11	MATERIAL CODES
12	

Figure 2.2: MICLASS code structure

(d) Set up time

6. DCLASS System

This system was developed by [8] the Allen D. K. at the Brigham Young University. It is a decision-logic handling system that assists generative process planning system. The main feature of the system is that it is a manu driven system, so it can be used by a process planner who is not acquaint with the science of computer. It is a tree structure system which can generate codes for components, materials, processes, machines, and tools. The eight digit code structure is shown in the table 2.4.

Table 2.4 : Structure of the DCLASS system

Digits 1-3	Basic shape
Digit 4	Form feature
Digit 5	Size
Digit 6	Precision
Digit 7 & 8	Material

In DCLASS, each branch represents a condition, and a code can be found at the terminal of the respective branch. Multiple passes of the decision tree allow a complete code to be found. The code construction is accomplished using certain

roots (N nodes and E nodes). At N nodes, all branches can be true, while at the E nodes, only one branch can be true.

DCLASS system supports generative process planning system. The generative process planning uses DCLASS 's decision-logic for:

- (a) Collection of input parameters
- (b) Decision-logic manipulation
- (c) Sequencing of output codes
- (d) Output of codes and numeric variables used to generate process-plan text

The process planner reviews the engineering drawing to answer questions displayed during the tutorial data input session. For an illustration, let us take metal fabrication process. The major groups of questions asked to collect the design and production parameters for a specific part are as follows:

- (a) Definition of raw material
 - (b) Definition of basic geometry
 - (c) Identification of special features
 - (d) Identification of finish-process requirements
-

(e) Identification of production quantity

DCLASS includes mechanisms that can capture, represent, and store input parameters as well as other mechanisms that can execute automatic branching based on the captured parameters. The parameters are then passed to the final section of the user defined decision-logic structure for processing. The final section automatically generates a set of sequence of output codes, which are then translated into discrete units of process plan text. Units of the text are then presented for final editing. The process planner can edit the text if he desires to do so. Texas instrument is successfully using this system as supporting system for the generative process planning.

7. COFORM

COFORM stand for COding FOR Machining. This was developed [22] by Rose at Purdue University. This is the coded input system used by a generative process planning system. This code, rather than dealing with the entire part geometry, limits itself to the description individual machined surfaces. The code describes each surface in terms of attributes needed to select the appropriate machining processes and the related parameters (feed, speed, and depth of cut). One of the constraints of COFORM is that it does not contain a description of nonmachined features, so it cannot be used for a CAD system. The list of the attribute required to describe a slot is as follows:

ATTRIB(1)	slot number
ATTRIB(2)	surface type
ATTRIB(3)	SLOT TYPE
	=1; <i>SIMPLE</i>
	=2; <i>DOVETAIL</i>
	=3; <i>RADIUS (WIDTH)</i>
	=4; <i>RECTANGULAR</i>
	=5; <i>RADIUS (LENGTH)</i>
	=6; <i>RECTANGULAR W/RADIUS(WID.)</i>
	=7; <i>T-SLOT</i>
	=8; <i>Y-SLOT</i>
	=9; <i>V-BOTTOM</i>
	=10; <i>COMPOUND</i>
	=11; <i>OTHER</i>

-
- ATTRIB(4) = SURFACE FINISH (BOTTOM)*
- ATTRIB(5) = PRECAST INDICATOR*
- =0; WITH CASTING SKIN*
- =1; W/O CASTING SKIN*
- ATTRIB(6) = MAXIMUM STOCK REMOVAL*
- ATTRIB(7) = MATERIAL TYPE*
- =1; CAST IRON*
- =2; MALLEABLE IRON*
- =3; STEEL*
- =4; STEEL FORGING*
- ATTRIB(8) = BHN*
- ATTRIB(9) = DIRECTIONAL VECTOR*
- =1; LINEAR*
- =2; CIRCULAR*
- =3; ELIPTICAL*
-

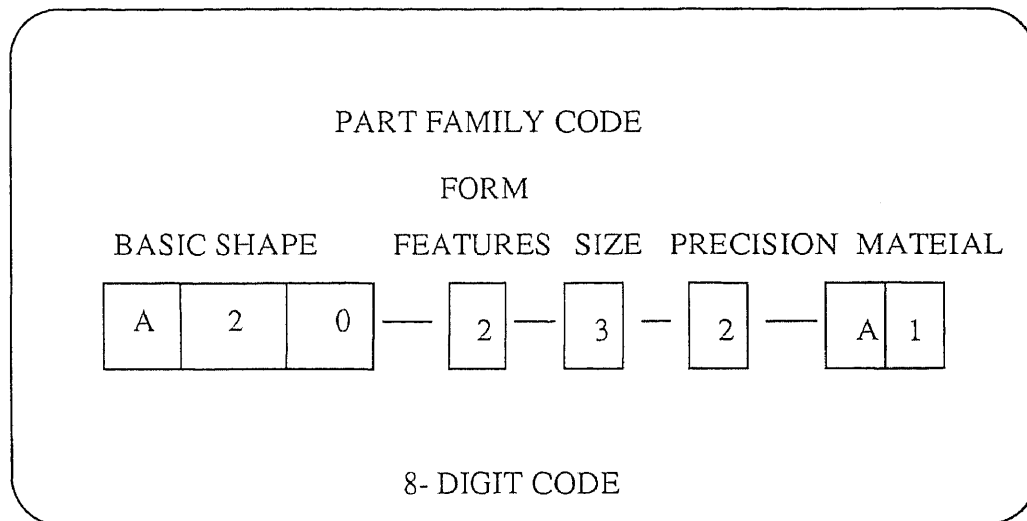
Table 2.5: DCLASS Structure: An example

=4; *HELICAL*

=5; *OTHER*

ATTRIB(10) = *THRU OR BLIND INDICATOR*

=1; *THRU BOTH ENDS*

=2; *THRU ONE END*

=3; *BLIND BOTH ENDS*

ATTRIB(11) = *BOTTOM SLOT INDICATOR*

=1; *FLAT*

=2; *RADIUS WODTH*

=3; *RADIUS LENGTH*

=4; *BOTTOM ANGLE*

=5; *RADIUSED BOTH LENGHT AND*

WIDTH

ATTRIB(12) = *LENGTH*

ATTRIB(13) = *DEPTH*

-
- ATTRIB(14) = WIDTH (AT TOP OF SLOT)*
- ATTRIB(15) = DEPTH OR AT BOTTOM TO START*
- ATTRIB(16) = ANGLE OF DOVETAIL OR Y*
- ATTRIB(17) = RADIUS (LENGTH) OR ANGLE FOR
BOTTOM INDICATOR*
- ATTRIB(18) = MAX. END RADIUS FOR
RECTANGULAR SLOT*
- ATTRIB(19) = WIDTH AT BOTTOM OF T OR Y
SLOT*
- ATTRIB(20) = MAX. DEPTH*
- ATTRIB(21) = MIN. DEPTH*
- ATTRIB(22) = PARALLELISM*
- ATTRIB(23) = FLATNESS*
- ATTRIB(24) = ANGULARITY*
- ATTRIB(25) = PROFILE OF A LINE*
-

<i>ATTRIB(26)</i>	<i>= PROFILE OF A SURFACE</i>
<i>ATTRIB(27)</i>	<i>= SPECIFIED CUTTER DIAMETER</i>
<i>ATTRIB(28)</i>	<i>= REFERENCE SURFACE</i>
<i>ATTRIB(29)</i>	<i>= SURFACE FINISH</i>
<i>ATTRIB(30)</i>	<i>= ACCESS SIDE INDICATOR</i>
<i>ATTRIB(31)</i>	<i>= # OF SLOTS TO BE PRODUCED</i>
	<i>PER TOOL</i>

8. Brisch System

This is one of the oldest coding systems is [14] developed by E. G. Brisch & Partners in United Kingdom. This system is so designed that any or all aspects of an industrial organization can be classified and coded.

The Brisch principles of classification are summarized as follows[15].

(1) All embracing

A classification must embrace all existing items and be able to accept necessary new items into the defined population of items, corollary-- there must be space to accommodate inclusions for the next 25 years, but be tailored to provide balance.

(2) Mutually exclusive

A classification must be mutually exclusive i.e., include like things while excluding unlike things, using clearly defined parameters, corollary-- there must be one place and one place only for any one item.

(3) Based on permanent characteristics

A classification must be based upon visible attributes or easily confirmed permanent and unchanging characteristics, corollary-- fortuitous, ambiguous and non permanent characteristics must not be used.

(4) From user's viewpoint

A classification should be developed from a single point of view-- that of the user and not the classifier, corollary-- pre-conceived, or otherwise set ideas on a solution not dictated by the facts at hand destroy the necessary overview perspective to solve any one firm's management need. The Brisch code hierarchy is shown in figure 2.3.

The part described by the number is as follows.

3- component

4- Not specified, metallic; form regular, straight, round

4-O/D single, long without through going center hole

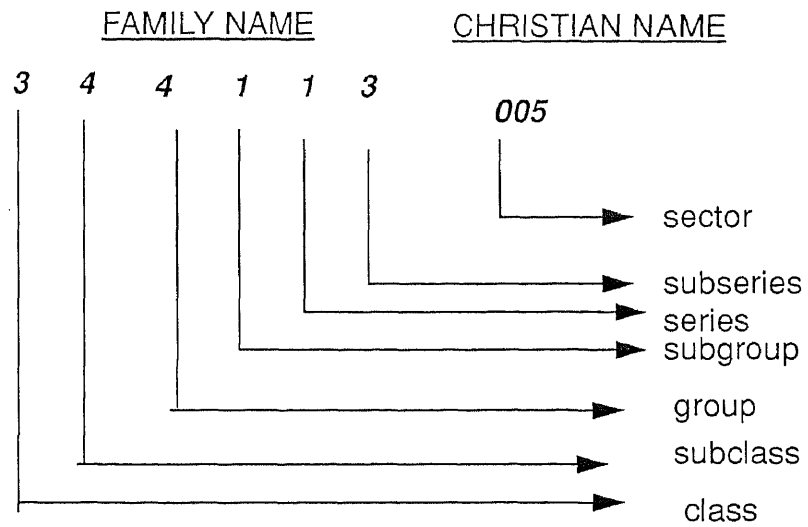
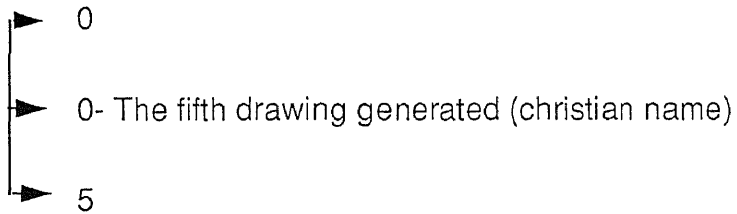

Figure 2.3: Brisch code hierarchy

1- plain

1- O/D-- 0.5 to 1.0 inch

3- Length-- 1.0 to 1.5 inch



B. Process Planning Systems

This section deals with the different types of computer aided process planning systems in detail.

1. CAM-I CAPP

This is the most widely used process planning system. It is a variant type [1] of a process planning system developed by McDonnell Douglas Automation Company under the contract from CAM-I. This process planning system has been written in ANSI standard FORTRAN. This process planning system does not contain any module for part coding, and it requires the user to provide a custom made coding system. This feature enhances the flexibility of the system. There are four basic purposes [18] behind the development of CAM-I CAPP. They are as follows:

- (1) This was the first endeavor towards development of an automated process planning system. So, its purpose was to check the feasibility of such a system and also to see the probable benefits as well as the shortcomings of such a system.
 - (2) The second purpose was more detailed one. It was to create a stage for the development of a totally integrated process planning system.
 - (3) The third purpose was to reveal the immediate needs of process planning in a vehement manner. Its basic aim was to centralize the master planning source data, reduction of manual tasks, and skill improvement and
-

(4) The last purport was to provide the common manufacturing technology data base for process planning. Process planning is considered to be the major source of database in manufacturing. Capturing the brains of experienced process planners in the common database for future reference, was one of the goals of development of this system.

The data structure of the system [18] contains six files: part family matrix file, standard sequence file, operation code table, operation plan file, part family set up file, and a process plan store file. The flow diagram of the system has been provided on the next page. The header menu has been shown below:

OS S1 SC RR FS DS MM PD PU F1 L0

FILL IN THE FOLLOWING FOR STORAGE AND RETRIEVAL PURPOSES

PLANNING I. D. = /

PLANNING REVISION NO. = /

PLANNING TYPE = /

FAMILY NUMBER=001/

G/T CODE = /

NOW PAGE DOWN TO FILL IN THE ACTUAL HEADER DATA

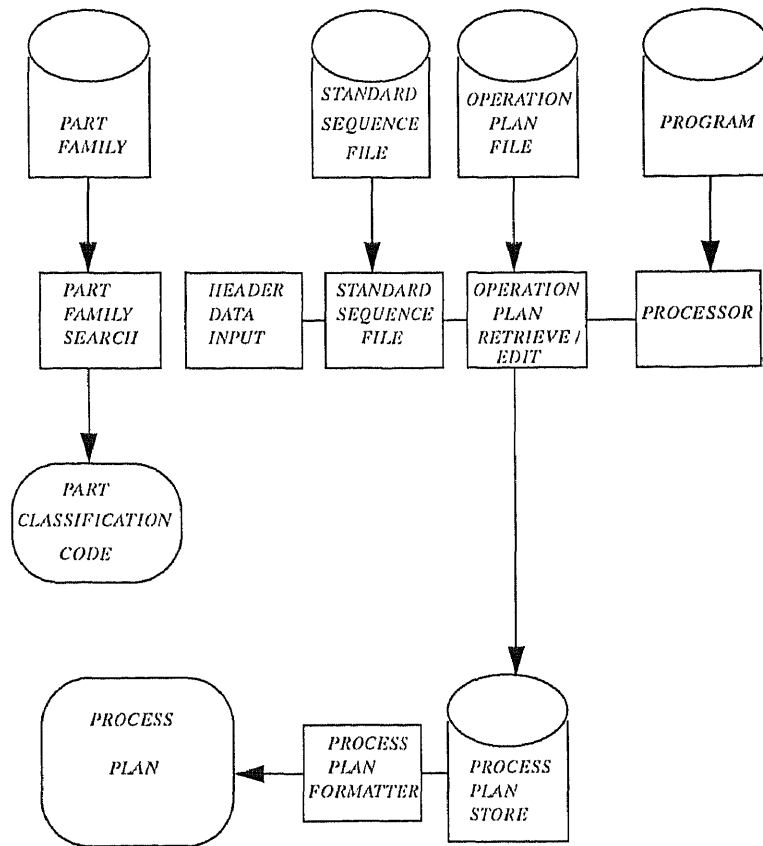

Figure 2.4: CAPP System: Flow diagram

EO'S	=	/
SCH	=	/
EO'S	=	/
NEXT ASSY=		/

HEADER MENU (PAGE 2)

The code used in this system is a five digit code. The code can be utilized to retrieve the standard plan by means of part family search. The plan is structured in such manner that it also returns the standard sequence for the part. This sequence is recognized as OPsequence in the CAPP terminology. In OPsequence, the operations are represented by OP codes which are alphanumeric codes. For each OP code in sequence, there is an operation plan consisting of the description of the detailed steps, machines, tools, fixtures, operation time, and so on, all of which can be retrieved. The complete process plan is the plan with operation plans imbedded in the sequence.

2. MIPLAN

This system was developed by [7] the Organization for Industrial Research (OIR). It's a variant system. MIPLAN does not require that Group Technology be implemented prior to its use by the process planner. Plans may be planned, saved and retrieved based solely on part numbers. Of course, by this methodology, the plan-

ner does not have any standard process sequence from which to work. He is enforced to create the plan from the scratch, using standard operation plan in the system's file.

It is appropriate to imbed GT concepts in MIPLAN to gain the most benefit from its use. Once this is done, i.e., part families are formed and standard operation sequence specified, MIPLAN is expected to work analogously with CAPP. The flow diagram of the system is shown on the *next page*.

Organization for Industrial Research has also developed a GT coding package called MICLASS. MICLASS has been described already in the section of the survey of coding system. This package can be utilized in conjunction with MIPLAN for interactive coding of the parts.

3. Computerized Production Process Planning

This system was developed by [11] United Technologies Research Center under U. S. Army contract. CPPP is a semi-generative system which is also devised on Group Technology, or family of parts concepts. It can be used successfully with any kind of machined cylindrical parts.

CPPP data base consists of the following.

(1) The process decision rule file-

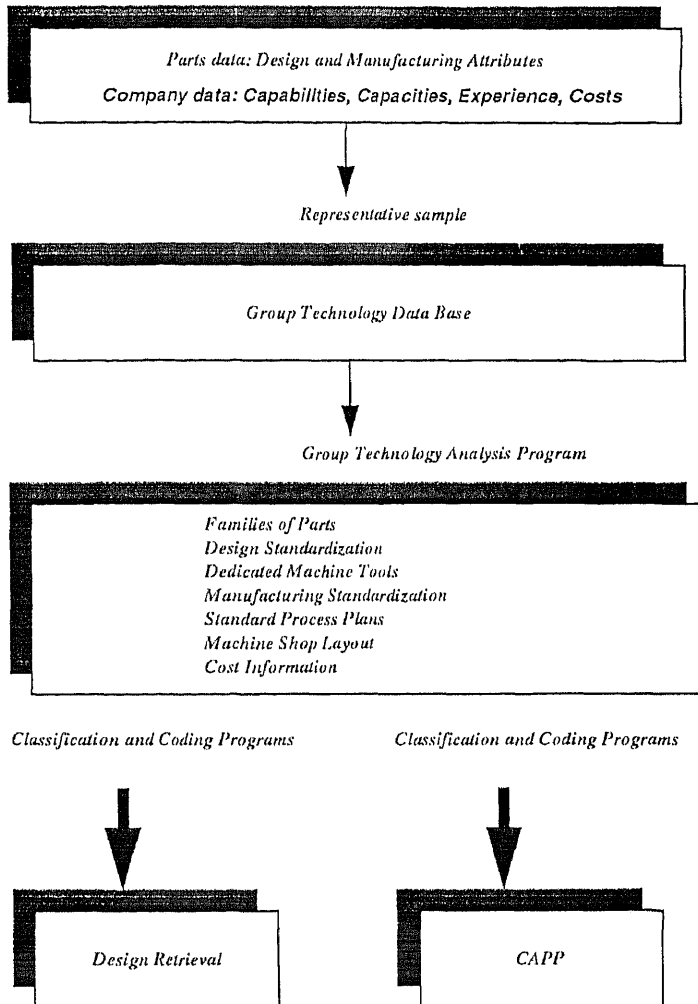

Fig. 2.5: Flow diagram of the MIPLAN system

This file contains process models unique to each part family. The model consists of series of tests and conditional branches, using the parts design data as input. This provides for a very flexible and generalized “standard plan “.

(2) A machine tool file- this file consists of data for each machine tool, including its name, number, setup times, burden rates, tool change times, horse power, maximum and minimum part dimensions, tolerances specified, etc.

(3) A cut application file-

This contains scrupulous list of the types of cuts each machine tool will support, and the tool(s) to be used for the cut.

(4) A cut parameter file-

This file contains certain machining parameters for each machine/material combination. e. g., tolerances, surface finish, and maximum allowable depth of cut.

(5) A machinability file-

This file gives recommendation for feeds and speeds for machining and tool life estimates.

CLASSIFICATION AND CODING PLAN

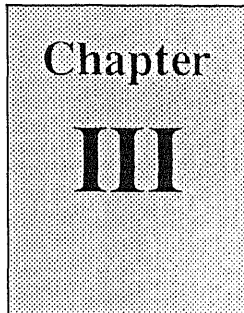

Work is worship

- God Krishna

A. Statement of work

The chore of this work is to devise a classification and coding system of concise nature. The proposed classification and coding system has been developed from the Japanese KK-3 classification and coding system. KK-3 was developed by Japanese Society for the Promotion of Machinery Industry (JSPMI). This is a 21 digit coding system which obviously represents more information than OPITZ or CODE system. During the scrupulous study of this system, some redundancies have been found for coding the rotational parts only. These redundancies are attemptedly eliminated. This makes the classification and coding system more simplified and pellucid.

A 15 digit coding system is designed for coding rotational machining parts only. This system contains the same amount of information as that can be represented by 21 digit KK-3 system.

The present scope of work is confined to the simple, rotational parts only. A simple, rotational part can be defined as a part with symmetrical geometry and a part which can rotate about its axis.

B. Comparative Study of the KK - 3 System and the ACPLAN

The 15 digits code is designed for the simple, rotational parts only. This coding session is only applicable for machining operations. Keeping this work scope in mind, we have eliminated six digits of the 21 digits KK-3 classification and coding system. Justification of the work is as follows:

(1) Digit 7 of the 21 digits system shows the ratio of the major dimensions. This digit could be eliminated as it is not necessary for our coding session. The system prompts the user to feed in the major dimensions in the digits 5 and 6, which is good enough to serve the purpose of getting information regarding major dimensions of the part. Our system is designed for rotational parts only, so only the diameter and the length of the part needs to be considered.

(2) Digits 8-11 of the 21 digits system deals with general external shape information. These digits serves the purpose of capturing general shape information like wether the part has center hole or not, wether the part is stepped to one or to both ends or not. Information regarding the center hole of the part is being taken care of in the Digit 8 of our system. The Digit 8 of our system covers the general external shape information which is being covered in the Digits 8-11 of the 21 digits system. The 21 digits system goes in to a detailed description of different external shape information like what kind of functional groove the part has, what kind of the irregular shape the part has. Our system has the digit 8 which captures general external shape information. Our system does not deal with the detailed description of the above mentioned general external shape attributes. Albeit, the Digit 8 can code the general external shape attributes, which is good enough to fit in our system.

(3) Digit 12 and Digit 13 of the 21 digits system are same as those of digits 12 and 13 of our system.

(4) Digit 14 of the 21 digits system ascribes the information concerning type of the hole part has. The general types of holes are ascribed in the Digit 9 of our system.

(5) Digit 15 of the 21 digits system has been eliminated as it contains information of the non rotational part. Non rotational parts are not in the scope of our work.

(6) Digit 20 of the 21 digits system contains information regarding non machining operations. Our system is designed only for machining operations, which helps us eliminate the Digit 20 of the 21 digits system.

We have adopted rest of the digits of the 21 digits system in our system in order to make our system code the general types of rotational parts.

“It requires enormous endeavor to reduce the number of digits while keeping the same amount of information representation[22].”

C. The System Overview

The basic structure of the Automated Coding PLAN (ACPLAN) and the KK-3 system have been depicted in the table 3.1 and table 3.2 respectively, for a quick reference.

The system overview is as follows:

1. Classification and coding module

Classification separates items into classes based on their differences and /or groups items into classes based on their similarities. Coding is the assignment of symbols such as number and/or letters to the specific classes of items used in the information processing. The classification and coding system groups and differentiates based on their differences.

The classification and coding system can be installed by three methods: first, by purchasing a commercial package from a vendor; second, by modifying a publicly available system to fit the required purposes; and third, by developing an original system based on the analysis of sample parts.

The ACPLAN belongs to the second category.

ACPLAN coding system establishes a coding scheme that meets most of needs of simple, rotational parts from the view point of the process planning. This code does not replace the existing part number and its name, but is simply a coded representation of the part's design and manufacturing specifications. The classification and coding session is shown on the pages 79-103 for Sleeve and Bushing respectively.

2. Machines available with their specifications

This system assigns the machines, to accomplish a specific process, from the database of the system. The detailed specifications of various machines is given in appendix B.

3. Process sequence and operation logic

This depends on the part's geometry, its overall dimensions and its internal and external features as represented in the G.T. code.

4. Part specifications

It is fed to the ACPLAN interactively to assign a 15 digit G.T. code to the part. After the part geometry and its featured parameters are examined, a G.T. code is assigned.

5. Operation logic module:

The created G.T. code for a part is used for assigning operations and required machines to accomplish the respective operations on the part. The system creates an operation logic based on the machines available in the database. The operation and machine are assigned based on the respective attribute of the part. The first and second digits represent general and detailed name of the part, respec-

tively, which is of no use in the operation logic session. So, digits one and two are not being used in this module.

An illustrative session for a Sleeve has been shown on the page 92 and for Bushing on page 103.

The schematic diagram of the ACPLAN is shown in figure 3.1 on the page 70. The operation logic flowchart is depicted in figure 3.2 on the pages 74-78.

This module starts interpreting each digit of the code created by the classification and coding module. This module testifies the material needed to manufacture the part and assigns the suitable lathe machine for rough turning for the specific material type.

Next, the module interprets the code digit which deals with the external surface type attribute of the part and assigns required machine and the operation required to obtain the specific attribute of the part.

Third, the module goes into the detail interpretation of the hole type of the part. It interprets the specific digit which deals with the hole information of the part, and assigns the required machine and operation for the respective attribute like thorough hole, pattern of holes(Axial hole, Radial hole, Complex hole) and auxiliary holes.

Fourth, the module interprets the digit which pertains to the internal surface attribute of the part and assigns the respective machine and operation for that attribute.

Finally, the module interprets the code digit which deals with the milled or cyclic surface attribute and assigns the appropriate machine and the operation required to obtain the respective attribute on the part. The module assigns the machines available in the database of the system.

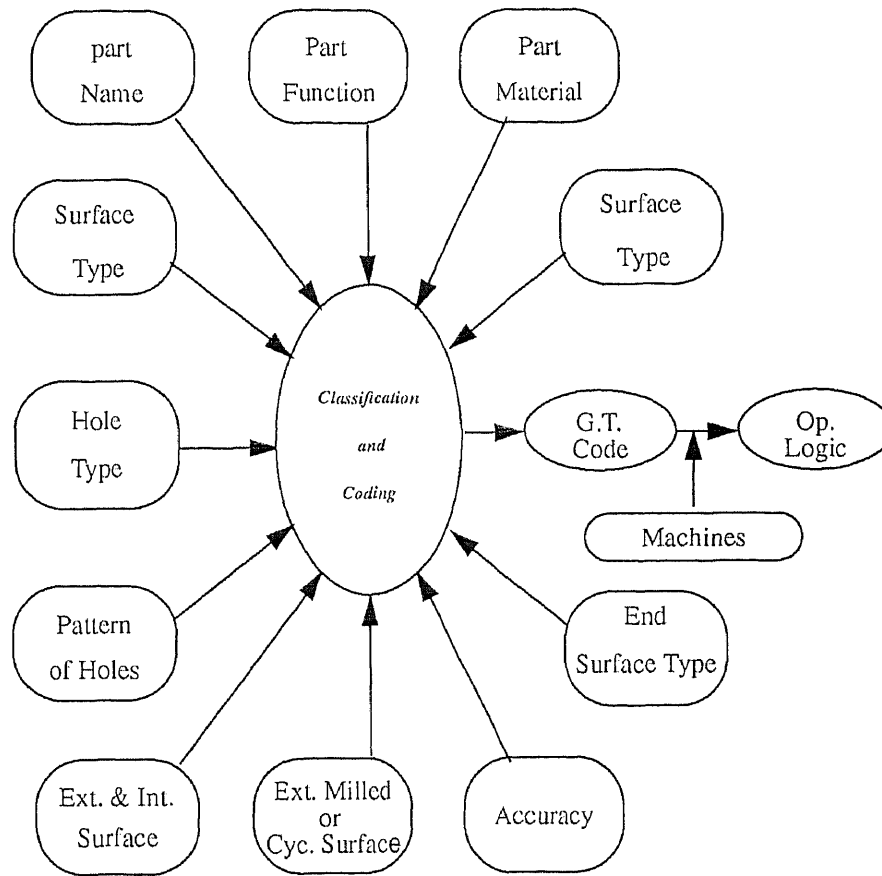

Figure 3.1 ACPLAN: Schematic diagram

Table 3.1: Structure of the ACPLAN

COL.	CLASSIFICATION ITEMS	
I	FUNCTION	GENERAL NAME
II	FUNCTION	DETAILED NAME
III	MATERIALS	GENERAL CLASS
IV	MATERIALS	DETAILED CLASS
V	DIMENSIONS	LENGTH (L)
VI	DIMENSIONS	DIAMETER (D)
VII		EXTERNAL SHAPE
VIII	HOLES	CENTER
IX	HOLES	PATTERN
X	HOLES	AUXILIARY
XI		INTERNAL PLANE AND CYCLIC
		SURFACE
XII	EX.SURFACE	MILLED
XIII	EX.SURFACE	CYCLIC
XIV		END SURFACE FEATURES
XV		ACCURACY

Table 3.2: Structure of the KK-3 system [3]

Digit	Items (Rotational components)		
1	Parts name	General classification	
2		Detail classification	
3	Materials	General classification	
4		Detail classification	
5	Chief dimensions	Length	
6		Diameter	
7	Primary shapes and ratio of major dimensions		
8	Shape details and kinds of processes	External surface and outer primary shape	
9		External surface	Concentric screw threaded parts
10			Functional cut-off parts
11			Extraordinary shaped parts
12			Forming
13			Cylindrical surface
14		Internal surface	Internal primary shape
15			Internal curved surface
16			Internal flat surface and cylindrical surface
17		End surface	
18		Nonconcentric holes	Regularly located holes
19			Special holes
20		Noncutting process	
21		Accuracy	



PROGRAM

ILLUSTRATIONS

1

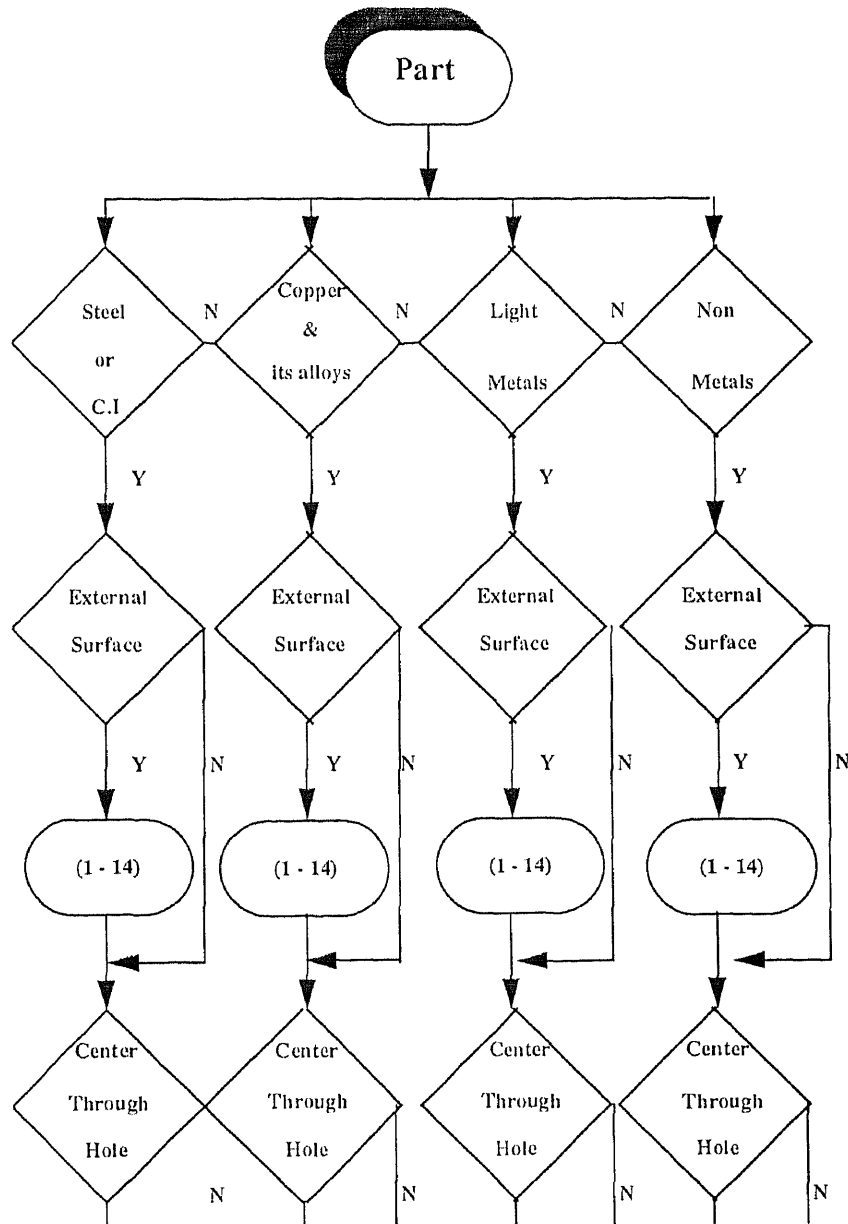
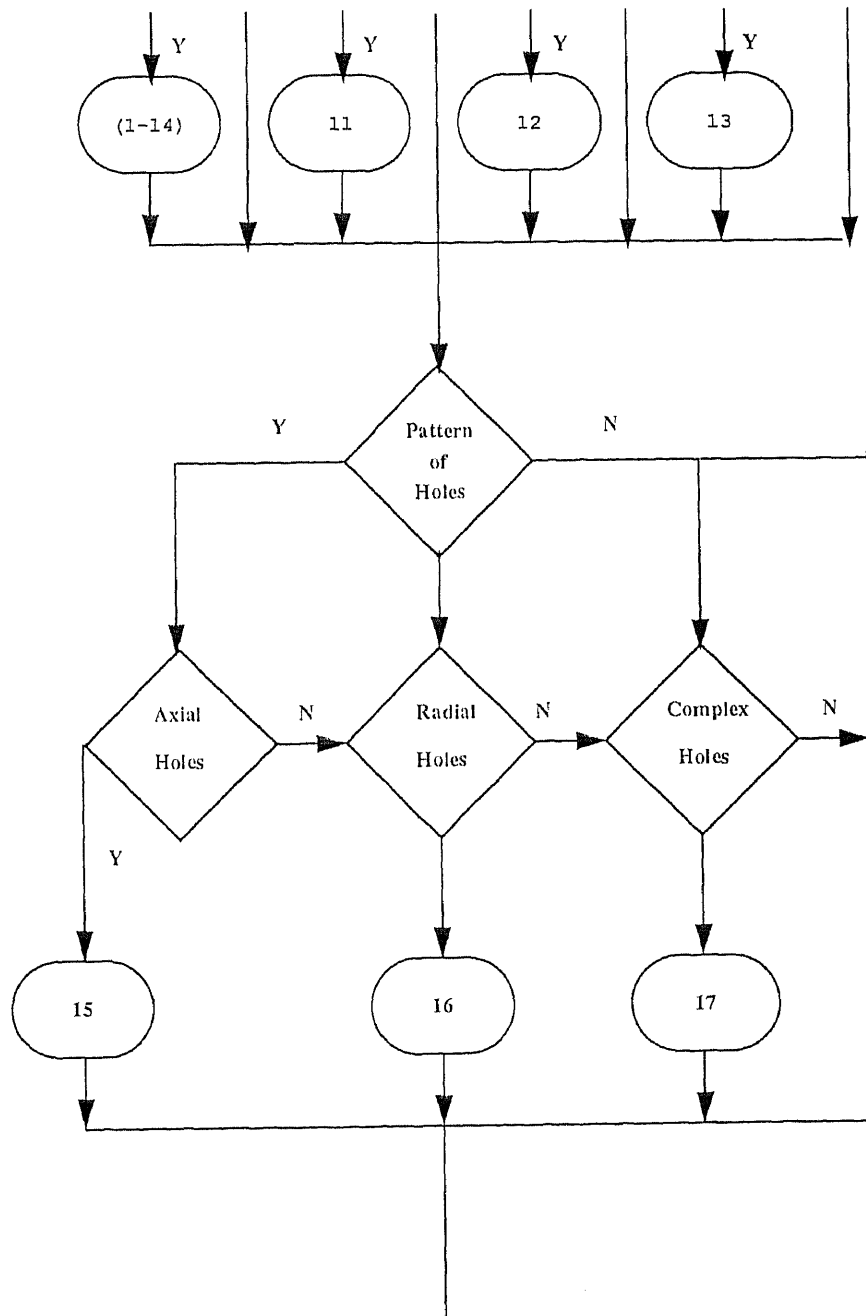
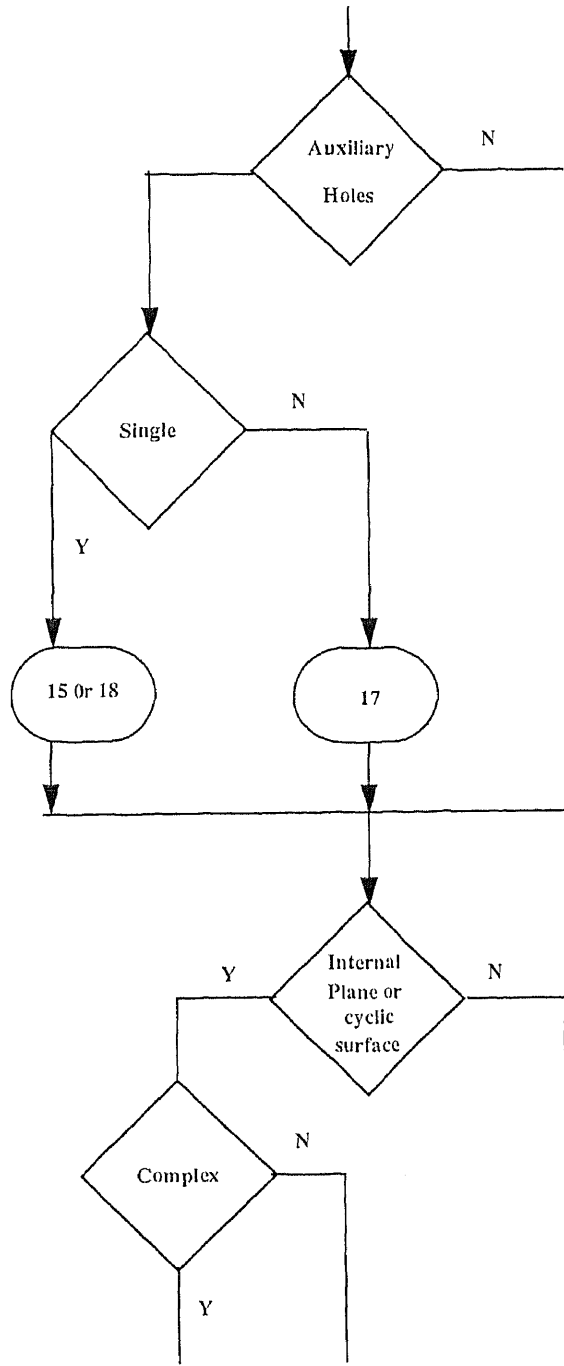
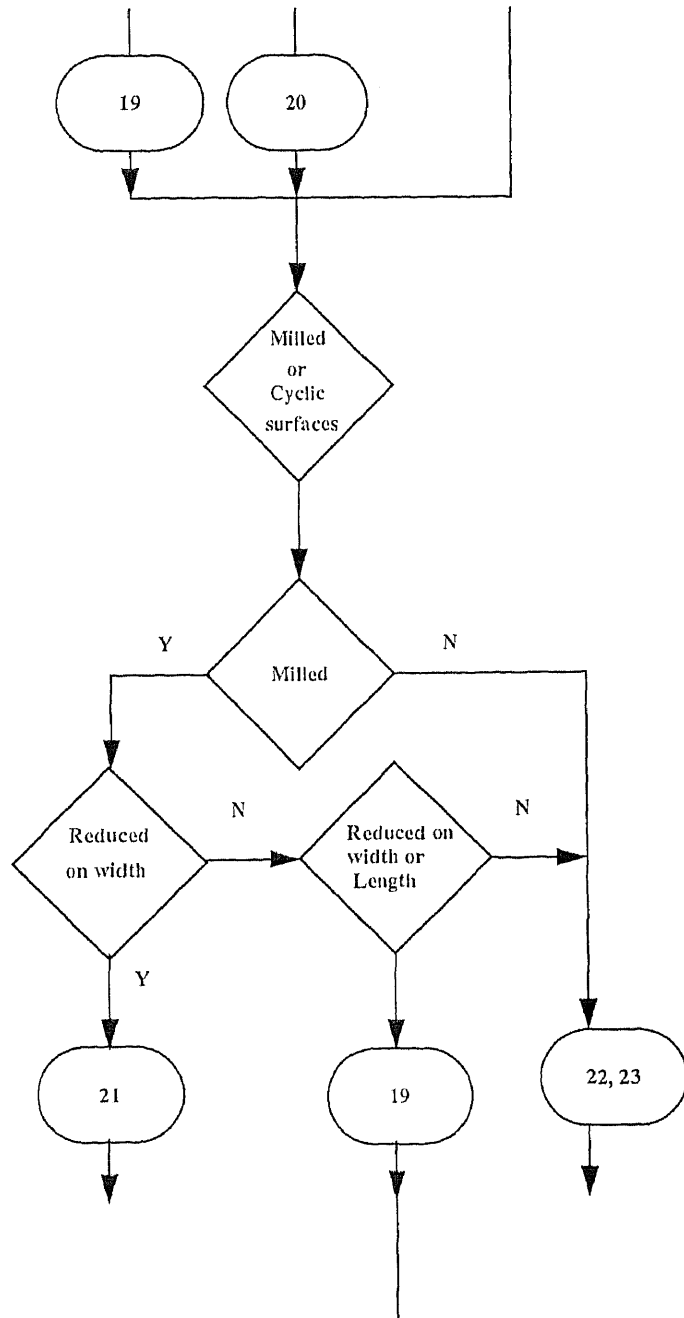
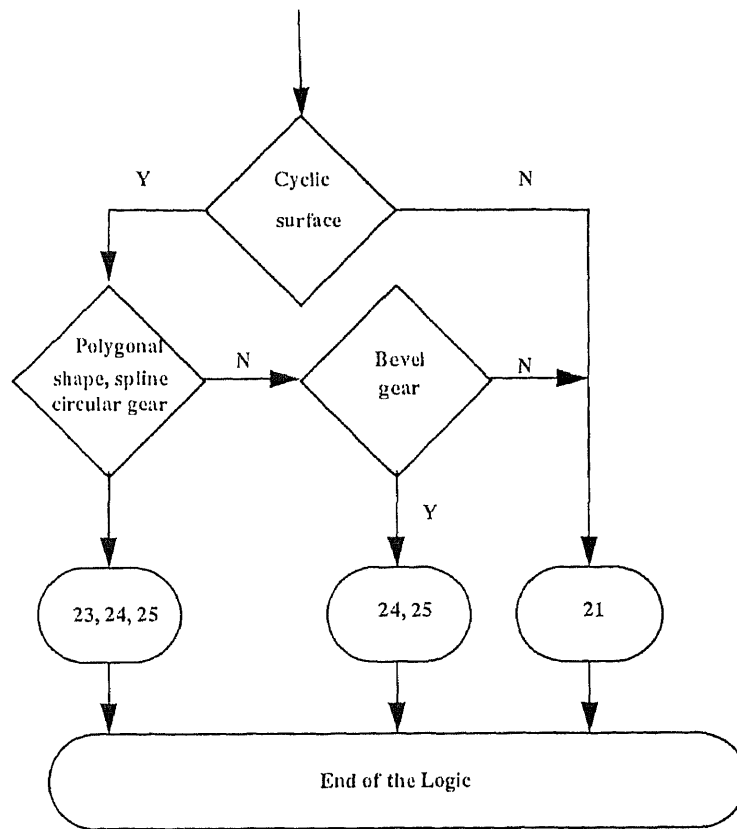

Figure 3.2: Flow diagram of operation logic









PROGRAM

ILLUSTRATIONS

1

PART: SLEEVE

C. PROGRAM ILLUSTRATION - PART: SLEEVE

The part under consideration has been shown in the figure 3.3. Program runs on an interactive fashion. It asks the user to feed in the required information on each step. Program begins with the name of the part and the drawing number to which the part belongs. Actual coding session starts thereafter. The user is asked to feed in the header information which includes part number, material code, make from description, name of the user and date. This coding plan is designed only for the rotational parts. So, the user has to be specific about the shape of the part.

The first column of the system deals with the general function of the part. Sleeve is the guiding part, so option 3 has been chosen by the user. Then the detailed functional name of the part has to be selected from the sub-menu furnished by the system. For Sleeve, the obvious selection would be 0.

The third column deals with the material to be used for the manufacture of the Sleeve. Option 5 has been chosen by the user as the user wants the Sleeve to be manufactured from steel. The fourth column deals with the type of surface treatment required for the material of the part. The user has selected carburized surface treatment for the steel.

The fifth column of the system asks the user to feed in the value of the length of the part and the sixth column asks the user to feed in the value of the diameter of the part. The dimensions of the part have to be fed either in inches or mm. The seventh column deals with the external shape feature of the part. Sleeve needs to be straight turned. So, the option one

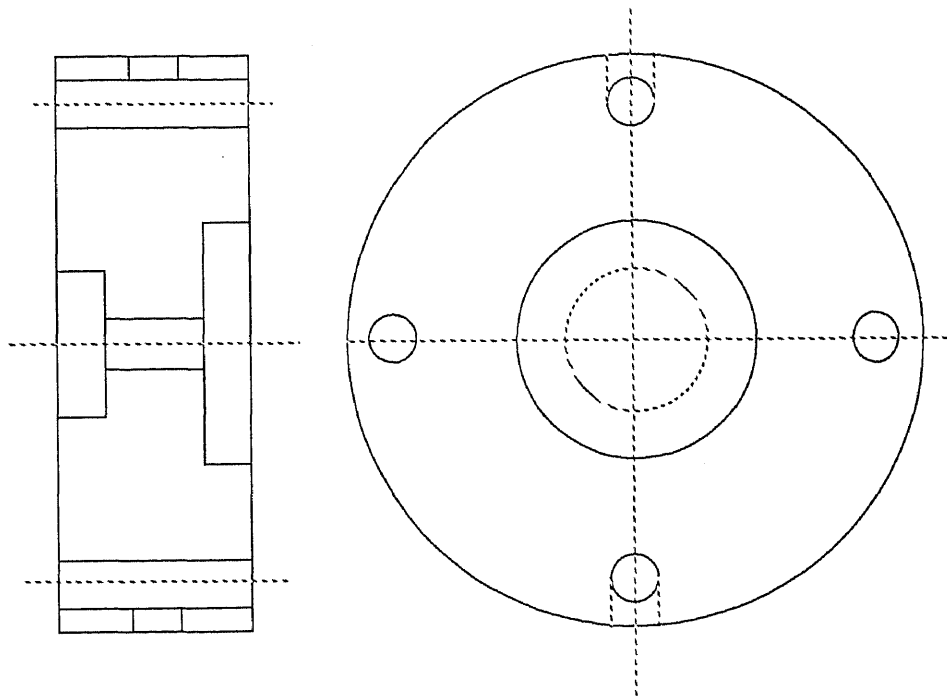

Fig. 3.3: Part for illustration: Sleeve

has been selected for the external shape feature.

Now, the program seeks the detail of the types of holes the part has. The Sleeve has a center hole, a thorough hole, but does not have the constant inner diameter. This makes the system furnish a sub-menu to the user. The option 3 has been selected by the user as the Sleeve has recesses on both the sides. This information has been required by the eighth column of the system.

The column nine seeks the information of the pattern of holes the part has. Sleeve has radial holes along its axis line, so the user has selected option 3 for the column nine. The column ten seeks the details of any auxiliary holes of the part. Sleeve has a single auxiliary hole. The column eleven seeks information pertaining to the internal surface type of the part. Sleeve does not have any internal plane or cyclic surface.

The column twelve seeks information pertaining to any externally milled slots or grooves of the part. Sleeve does not have any milled slots or grooves. The column thirteen deals with the type of external cyclic surface of the part under consideration. The Sleeve does not have any spline, gear or other types of external cyclic surface feature.

The column fourteen deals with the end surface feature of the Sleeve. The Sleeve does not have any end surface feature. The last column deals with the machining accuracy required for the manufacture of the Sleeve. The sleeve has to have grinding accuracy specified for its manufacture, which makes the user choose the option 6 for the last column of the coding session.

Program displays a 15 digits code at the end of the interactive session. The user has the option to save the code for the future reference. Next, the operation logic is being created by the system. The system utilizes two resources for creation of the operation logic. It utilizes the code created by itself and the machines available in the database for accomplishing the task. The system analyzes the different attributes of the Sleeve and assigns the machines required in order to accomplish the required operation for the respective attribute of the Sleeve. The system creates a sequence of operation and stores it in the database file.

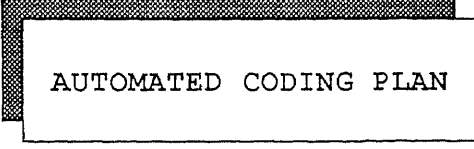

AUTOMATED CODING PLAN

PART NAME: Sleeve

DRAWING NUMBER: 1

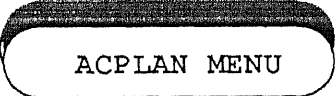

ACPLAN MENU

1-CLASSIFICATION AND CODING

2-QUIT

->1

HEADER INFORMATION:

PART NUMBER: 1

MATERIAL CODE: 12

MAKE FROM DESCRIPTION: steel

PREP.BY: shilpan patel

DATE: 4/1/91

CODING SYSYTEM

ALL RESPONSES ARE TO BE EITHER Y,N OR A NUMERICAL VALUE.
ALL DIMENSIONS ARE TO BE IN DECIMAL FORM; OTHERS INTEGER.

PARTNAME: sleeve

DRAWING NUMBER: 1

ROTATIONAL PART?(Y OR N): y

PART: SLEEVE

DRAWING NO.: 1

NEXT COLUMN IS: 1

PART FUNCTION:

- 0.GEAR
 - 1.SHAFT, SPIND LE, ROD
 - 2.MAIN DRIVING OR MOVING PART
 - 3.GUIDING PART
 - 4.FIXING PART
 - 5.VESSEL OR CONTAINER
 - 6.BODY
 - 7.SUPPORTING PART
 - 8.CONTROLLING PART
 - 9.AUXILIARY DRIVING OR MOVING PART
-

-> 3

PART: SLEEVE

DRAWING NO.: 1

NEXT COLUMN IS: 2

GUIDING PART:

0.SLEEVE OR BUSHING

1.HOUSING

2.BEARING

3.ROLLER

4.CYLINDER

5. GUAGE OR OTHER

-> 0

PART: SLEEVE

DRAWING NO.: 1

NEXT COLUMN IS: 3

MATERIAL:

0.CAST IRON

PLAIN CARBON STEELS:

1.FREE MACHINING

2.LOW CARBON

3.MEDIUM CARBON

4.HIGH CARBON

5.STEEL, SURFACE TREATED

6.ALLOY STEEL OR TOOL MATERIAL

7.COPPER ALLOY

8.LIGHT METAL

9.OTHER METAL, NONMETAL

> 5

PART: SLEEVE

DRAWING NO.: 1

NEXT COLUMN IS: 4

STEEL FORGING? n

SURFACE TREATMENT:

0.HI FREQ ELECT OR FLAME HARD ENED

1.CARBURIZED

2.NITRIDING

3.OTHER H.T.

4.PLATING OR OTHER

> 1

PART: SLEEVE

DRAWING NO.: 1

NEXT COLUMN IS: 5

ROTATIONAL PART; LENGTH= 0.8

LARGEST DIA.= 1

MM OR IN? in

PART: SLEEVE

DRAWING NO.: 1

NEXT COLUMN IS:7

ANY EXTERNAL SURFACE FEATURE?(Y OR N): y

SURFACE TYPE:

1.STRAIGHT TURN

2.TAPER TURN

3.FUNCTIONAL GROOVE

4.EXTERNAL THREADS

5.STEPPED TO ONE END

6.STEPPED TO BOTH ENDS

7.IRREGULAR SHAPE

8.CUTOFF

9.OTHER

> 1

PART: SLEEVE

DRAWING NO.:

1

NEXT COLUMN IS: 8

IS THERE A CENTER HOLE? y

THROUGH HOLE? y

IS THE I.D. CONSTANT? n

RECESSES:

1.RIGHT END ONLY

2.LEFT END ONLY

3.BOTH ENDS

4.W/FUNCTIONAQL GROOVES

-> 3

PART: SLEEVE

DRAWING NO.:

1

NEXT COLUMN IS: 9

IS THERE A PATTERN OF HOLES? y

1.AXIAL HOLES

2.RADIAL HOLES ALONG AXIS LINE

3.RADIAL HOLES ALONG CIRCUMFERENCE

4.1 AND 2

5.1 AND 3

6. 2 AND 3

7.ALL OF ABOVE

8. OTHER
9. COMBINATION
> 2

PART: SLEEVE
DRAWING NO.: 1

NEXT COLUMN IS: 10

ANY AUXILIARY HOLES? y

1. SINGLE HOLE
2. COUNTERSUNK, THREADED OR TAPERED HOLE
3. DEEP HOLE
4. ODD SHAPED HOLE
5. 1 AND 2
6. 1 AND 3
7. 2 AND 3
8. ALL OF ABOVE
9. OTHERS

> 1
PART: SLEEVE
DRAWING NO.: 1

NEXT COLUMN IS: 11

IS THERE AN INTERNAL PLANE OR CYCLIC SURFACE? n

PART: SLEEVE
DRAWING NO.: 1

NEXT COLUMN IS: 12

EXTERNAL SURFACE:

ANY MILLED SLOTS OR GROOVES? n

PART: SLEEVE
DRAWING NO.: 1

NEXT COLUMN IS: 13

ARE THERE EXTERNAL CYCLIC SURFACES? n

PART: SLEEVE
DRAWING NO.: 1

NEXT COLUMN IS: 14

ANY END SURFACE FEATURES? n
14

PART: SLEEVE DRAWING NO.: 1

NEXT COLUMN IS: 15

IS MACHINING ACCURACY SPECIFIED? y

CUTTING ACCURACY ONLY:

- 1.INTERNAL SURFACE
- 2.EXTERNAL SURFACE
- 3.PLANE SURFACE
- 4.CIRCULAR AND PLANE SURFACE

GRINDING ACCURACY:

- 5.INTERNAL SURFACE
 - 6.EXTERNAL SURFACE
 - 7.PLANE SURFACE
 - 8.CIRCULAR AND PLANE SURFACE
-

9.HIGHER ACUURACY POSITIONING

-> 6

DO YOU WANT TO SAVE CODE NUMBER?(Y OR N): y

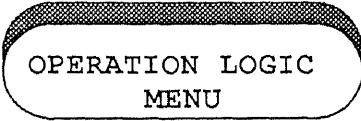

OPERATION LOGIC
MENU

SELECT ONE:1-OPERATION SEQUENCE

2 - QUIT

> 1

****1. PLEASE EXIT FROM THE PROGRAM AND TYPE APKODE.DAT TO
SEE THE OPERATIONAL SEQUENCE ****

**** 2. EXIT FROM THE OPERATION LOGIC

-> 1

DRAWING NO: 1 PART NAME: SLEEVE
FINAL GROUP TECHNOLOGY CODE:

3 1 5 6 1 1 1 4 2 1 0 0 0 0 6

****** OPERATION LOGIC ******

**STEP 1: PLEASE USE LATHE 1-14 (DEPENDING ON D AND L)FOR ROUGH
TURNING**

**STEP 2: PLEASE USE LATHE 1-14 (DEPENDING ON D AND L) FOR CENTER
THROUGH HOLE**

STEP 3: PLEASE USE DRILL NO.1 FOR AXIAL HOLES

**STEP 4: PLEASE USE DRILL NO.15 OR DRILL NO.18 (DEPENDING ON D AND
L) FOR AUXILIARY HOLES**

**STEP 5: PLEASE USE MACHINING CENTER NO.1 FOR INTERNAL PLANE
OR CYCLIC SURFACE**

**STEP 6: PLEASE USE MILL NO.22 OR 23 (DEPENDING ON D AND L)FOR
SLOTS OR GROOVES ON THE PART**

STEP 7: USE MACHINING CENTER NO. 3 FOR TOO COMPLEX PARTS

PROGRAM

ILLUSTRATIONS

2

PART: BUSHING

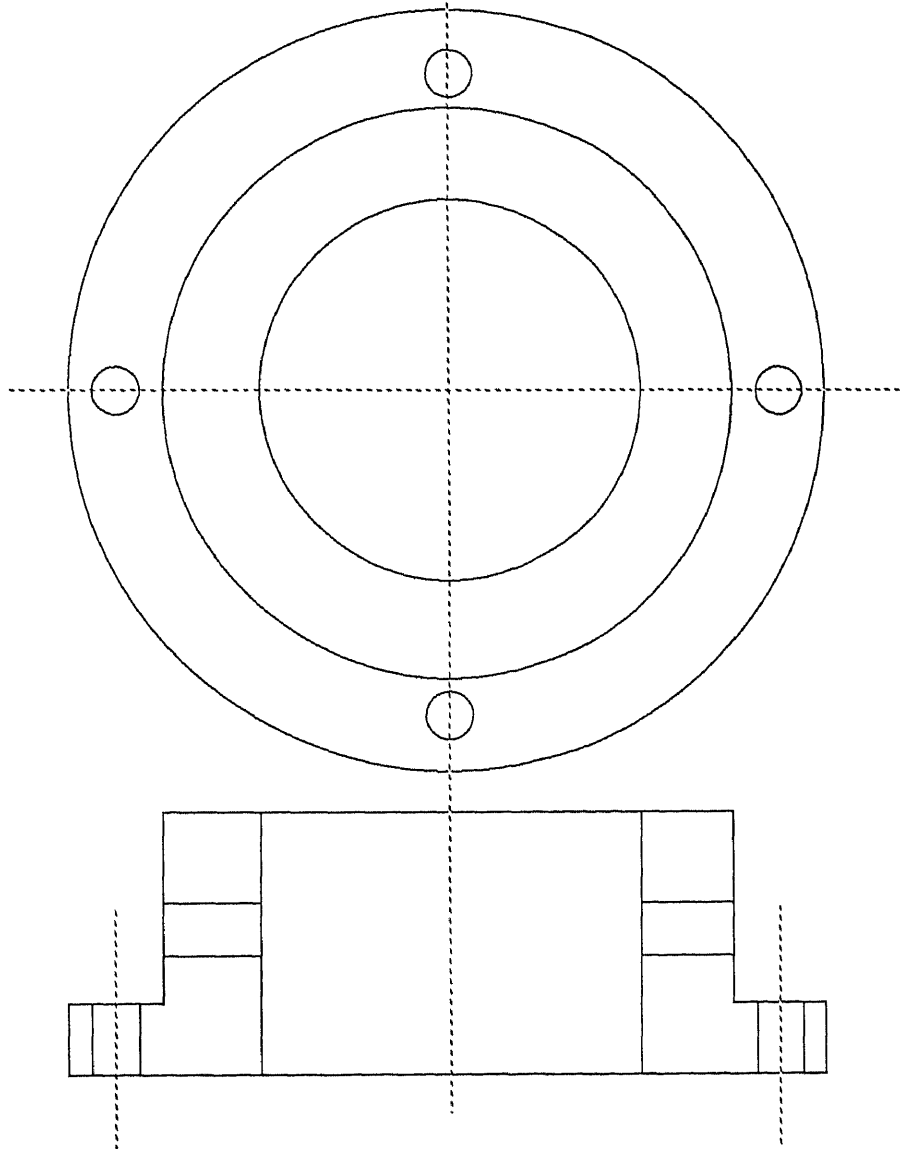

Figure 3.4: part for illustration: Bushing

AUTOMATED CODING PLAN

PART NAME: Bushing

DRAWING NUMBER: 2

ACPLAN MENU

1-CLASSIFICATION AND CODING
2-QUIT

->1

HEADER INFORMATION:

PART NUMBER: 2

MATERIAL CODE: 123

MAKE FROM DESCRIPTION: steel

PREP.BY: shilpan patel

DATE: 4/1/91

CODING SYSTEM

ALL RESPONSES ARE TO BE EITHER Y,N OR A NUMERICAL VALUE.
ALL DIMENSIONS ARE TO BE IN DECIMAL FORM; OTHERS INTEGER.

PARTNAME: Bushing

DRAWING NUMBER: 2

ROTATIONAL PART?(Y OR N): y

PART: Bushing

DRAWING NO.: 1

NEXT COLUMN IS: 1

PART FUNCTION:

- 0.GEAR
- 1.SHAFT, SPIND LE, ROD
- 2.MAIN DRIVING OR MOVING PART
- 3.GUIDING PART
- 4.FIXING PART
- 5.VESSEL OR CONTAINER
- 6.BODY
- 7.SUPPORTING PART
- 8.CONTROLLING PART
- 9.AUXILIARY DRIVING OR MOVING PART

-> 3

PART: BUSHING

DRAWING NO.: 2

PART: BUSHING

DRAWING NO.: 2

NEXT COLUMN IS: 8

IS THERE A CENTER HOLE? y

THROUGH HOLE? y

IS THE I.D. CONSTANT? n

RECESSES:

1. RIGHT END ONLY
 2. LEFT END ONLY
 3. BOTH ENDS
 4. W/FUNCTIONAL GROOVES
- > 3

PART: BUSHING

DRAWING NO.: 2

NEXT COLUMN IS: 9

IS THERE A PATTERN OF HOLES? y

1. AXIAL HOLES
 2. RADIAL HOLES ALONG AXIS LINE
 3. RADIAL HOLES ALONG CIRCUMFERENCE
 4. 1 AND 2
 5. 1 AND 3
 6. 2 AND 3
 7. ALL OF ABOVE
 8. OTHER
 9. COMBINATION
-

STEEL FORGING? n

SURFACE TREATMENT:

0.HI FREQ ELECT OR FLAME HARD ENED

1.CARBURIZED

2.NITRIDING

3.OTHER H.T.

4.PLATING OR OTHER

> 1

PART: BUSHING

DRAWING NO. : 2

NEXT COLUMN IS: 5

ROTATIONAL PART; LENGTH= 1.4

LARGEST DIA.= 1

MM OR IN? in

PART: BUSHING

DRAWING NO. : 2

NEXT COLUMN IS:7

ANY EXTERNAL SURFACE FEATURE?(Y OR N): y

SURFACE TYPE:

1.STRAIGHT TURN

2.TAPER TURN

3.FUNCTIONAL GROOVE

4.EXTERNAL THREADS

5.STEPPED TO ONE END

6.STEPPED TO BOTH ENDS

7.IRREGULAR SHAPE

8.CUTOFF

9.OTHER

> 1

NEXT COLUMN IS: 2

GUIDING PART:

- 0.SLEEVE OR BUSHING
- 1.HOUSING
- 2.BEARING
- 3.ROLLER
- 4.CYLINDER
- 5. GUAGE OR OTHER

-> 0

PART: BUSHING

DRAWING NO.: 2

NEXT COLUMN IS: 3

MATERIAL:

- 0.CAST IRON
- PLAIN CARBON STEELS:
- 1.FREE MACHINING
- 2.LOW CARBON
- 3.MEDIUM CARBON
- 4.HIGH CARBON
- 5.STEEL, SURFACE TREATED
- 6.ALLOY STEEL OR TOOL MATERIAL
- 7.COPPER ALLOY
- 8.LIGHT METAL
- 9.OTHER METAL, NONMETAL

> 5

PART: BUSHING

DRAWING NO.: 2

NEXT COLUMN IS: 4

> 2

PART: BUSHING

DRAWING NO.: 2

NEXT COLUMN IS: 10

ANY AUXILIARY HOLES? y

1.SINGLE HOLE

2.COUNTERSUNK, THREADED OR TAPERED HOLE

3.DEEP HOLE

4.ODD SHAPED HOLE

5.1 AND 2

6 1 AND 3

7. 2 AND 3

8.ALL OF ABOVE

9.OTHERS

> 1

PART: BUSHING

DRAWING NO.: 2

NEXT COLUMN IS: 11

IS THERE AN INTRNAL PLANE OR CYCLIC SURFACE? n

PART: BUSHING

DRAWING NO.: 2

NEXT COLUMN IS: 12

EXTERNAL SURFACE:

ANY MILLED SLOTS OR GROOVES? n

PART: BUSHING

DRAWING NO.: 2

NEXT COLUMN IS: 13

ARE THERE EXTERNAL CYCLIC SURFACES? n

PART: BUSHING

DRAWING NO.: 2

NEXT COLUMN IS: 14

ANYEND SURFACE FEATURES? n

PART: BUSHING

DRAWING NO.: 2

NEXT COLUMN IS: 15

IS MACHINING ACCURACY SPECIFIED? y

CUTTING ACCURACY ONLY:

- 1.INTERNAL SURFACE
- 2.EXTERNAL SURFACE
- 3.PLANE SURFACE
- 4.CIRCULAR AND PLANE SURFACE

GRINDING ACCURACY:

- 5.INTERNAL SURFACE
- 6.EXTERNAL SURFACE
- 7.PLANE SURFACE
- 8.CIRCULAR AND PLANE SURFACE
- 9.HIGHER ACUURACY POSITIONING

-> 6

DO YOU WANT TO SAVE CODE NUMBER?(Y OR N): Y

OPERATION LOGIC
MENU

SELECT ONE:1-OPERATION SEQUENCE
2 - QUIT

> 1

***1. PLEASE EXIT FROM THE PROGRAM AND TYPE APKODE.DAT TO
SEE THE OPERATION LOGIC

*** 2. EXIT FROM THE OPERATION LOGIC
-> 1

**DRAWING NO: 2 PART NAME: BUSHING
FINAL GROUP TECHNOLOGY CODE:**

31561114210006

****** OPERATION LOGIC ******

**STEP 1: PLEASE USE LATHE 1-14 (DEPENDING ON D AND L)FOR ROUGH
TURNING**

**STEP 2: PLEASE USE LATHE 1-14 (DEPENDING ON D AND L) FOR CENTER
THROUGH HOLE**

STEP 3: PLEASE USE DRILL NO.1 FOR AXIAL HOLES

**STEP 4: PLEASE USE DRILL NO.15 OR DRILL NO.18 (DEPENDING ON D AND
L) FOR AUXILIARY HOLES**

**STEP 5: PLEASE USE MACHINING CENTER NO.1 FOR INTERNAL PLANE
OR CYCLIC SURFACE**

**STEP 6: PLEASE USE MILL NO.22 OR 23 (DEPENDING ON D AND L)FOR
SLOTS OR GROOVES ON THE PART**

STEP 7: USE MACHINING CENTER NO. 3 FOR TOO COMPLEX PARTS

EPILOGUE

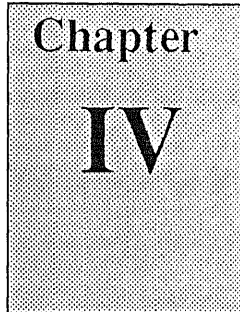
A rectangular box with a halftone background. Inside the box, the word "Chapter" is written in a serif font at the top, and the Roman numeral "IV" is written in a large, bold serif font below it.

Chapter
IV

*Progress is the realization of
utopias.*

The coding plan is successful in assigning G.T. code to various rotational parts.

The prime advantages of the system are as follows:

- (1) Part coding can be accomplished in an interactive fashion by using 15 digit coding scheme. The program is interactive. This feature makes it easier for the coder to generate the code.
- (2) The G.T. code for the part can be saved for the future reference.
- (3) The coding scheme groups parts based on their similarities. This grouping of parts based on their similarities can be a great asset for a process planner with the view point of reducing man-machine hours and thus reducing the manufacturing cost of the product.

Statement of limitations of this work

The present work is lacking some of the enchanting features which could have made the work more prolific. These features can be included in the scope of potential research for the future research work in this same area.

The areas of potential research can be ascribed as follows:

- (1) The part family routine can be developed based on similarities of process sequence requirements.
- (2) The coding scheme can be expanded to include non-rotational parts.

The 21 digits system also has a separate 21 digit definition for coding non symmetrical, non rotational parts. Each of the 21 digits representation could be programmed by creating a subroutine for each digit of the system. A user can choose from either a coding scheme for rotational parts or a coding scheme for non rotational part based on the geometry of the part. Different subroutines for coding rotational parts have already been written in the present work, which could be enhanced by writing subroutines for coding non rotational parts.

- (3) The coding scheme should be generalized in order to interface with various process planning systems.

From the two illustrations given in the Chapter III, it is apparent that the parts of the similar attributes can be grouped together in a single family. A process plan associated with the

respective part family can be utilized, may be with meager rectifications, for the upcoming new part of the same family. Sleeve and bushing fall in to the same part family and therefore their operational logic is identical. This operational logic does not represent the full fledged process plan. It only suggests the operations to be performed on the part under consideration and the machine to be utilized for a respective operation. Process planner has to come up with the detailed plan depending on the existing constraints of the manufacturing set up. Albeit, the logic mechanism renders insinuations concerning the required operation and the respective machine to complete the operation. The proposed work has indicated that the window is open to carry on the enhancement in the same research area. Process planning requires tremendous amount of the knowledge base in order to create an algorithm which can select the best sequence of the processes required to get the part manufactured. Lack of practical experience was one of the pitfalls encountered during this work. Experience in the real manufacturing environment could have changed the entire scenario of the present work.

Appendix

A







AN OVERVIEW OF THE KK - 3 CLASSIFICATION

AND

CODING SYSTEM

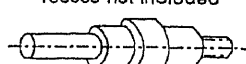
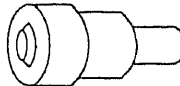
CODE DIGIT DEFINITION OF THE ROTATIONAL PARTS

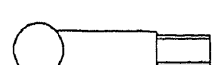
*Column VIII : Geometrical shape and machining.
(R)- External surface, General external shape*

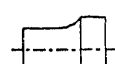
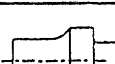
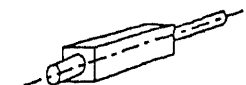

0	no center hole		recess  same diameter  this is a recess
1	Stepped	stepped to one end or smooth	stepped to one end  non functional taper
2		stepped to both ends or multiple changes	recess not included 
3	W/functional tapered plane	stepped to one end or smooth	
4		stepped to both ends or multiple changes	
5	W/spherical shape	stepped to one end or smooth	
6		stepped to both ends or multiple changes	
7	Various curved rotational shapes	stepped to one end or smooth	
8		stepped to both ends or multiple changes	
9	segment and others		

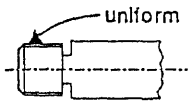
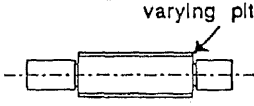
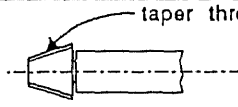
*Column IX : Geometrical shape and machining.
(R)- External surface, Concentric screw thread*



0	none	
1	cylindrical thread	uniform pitch thread 
2		non-uniform pitch thread 
3	cone shaped thread 	
4	(1) + (2)	
5	(1) + (3)	
6	(2) + (3)	
7	(1) + (2) + (3)	
8	other concentric screw thread	
9	(1 ~ 3) + (8)	

Column X : Geometrical shape and machining.

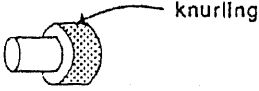

(R)- External surface, Functional groove

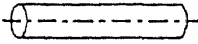
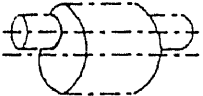
0	none	
1	angular groove	
2	generated groove	
3	rolled	
4	(1) + (2)	
5	(1) + (3)	
6	(2) + (3)	
7	(1) + (2) + (3)	
8	other functional grooves	
9	(1 - 7) + (8)	

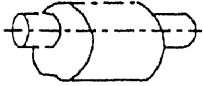



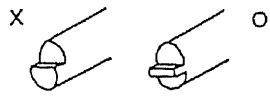

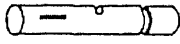

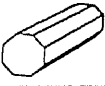

Column XI : Geometrical shape and machining.
(R)- External surface, Irregular shape

0	none	
1	eccentric	
2	branches	
3	non-cylindrical cross-section	
4	(1) + (2)	
5	(1) + (3)	
6	(2) + (3)	
7	(1) + (2) + (3)	
8	other irregular shapes	
9	(1 - 7) + (8)	





*Column XII : Geometrical shape and machining.
(R)- External surface, shaped surface*

0	none	
1	precessed or notched	
2	slot	
3	groove	
4	(1) + (2)	
5	(1) + (3)	
6	(2) + (3)	
7	(1) + (2) + (3)	
8	other shaped surface	
9	(1 ~ 7) + (8)	



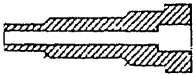
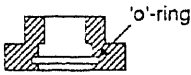
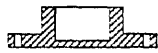
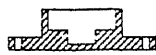
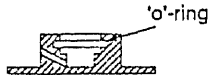

Column XIII : Geometrical shape and machining.
(R)- External surface, Cyclic surface

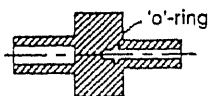
0	none	
1	polygonal shape	  extruded
2	spline	
3	circular gear	
4	bevel gear	
5	special gear	 e.g. non-circular
6	combination gear	
7	rack	
8	indexing plate	
9	others	



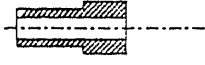

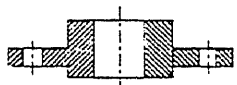
*Column XIV : Geometrical shape and machining.
(R)- Internal surface, General internal shape*

0	no through hole				
1	With axial hole	With through hole	no diameter change		
2			with diameter changes	no functional groove	
3			with diameter changes	w/functional groove	
4		Stepped to one end	with diameter changes	no diameter change	
5				no functional groove	
6				w/functional groove	
7		Stepped to both ends	with diameter changes	no diameter change	
8				no functional groove	
9				w/functional	





*Column XV : Geometrical shape and machining,
(R)- Internal surface, Curved internal shape*

0	none	
1	functional taper/rotational curved surface	
2	eccentric cylindrical surface	
3	thread	 thread
4	(1) + (2)	
5	(1) + (3)	
6	(2) + (3)	
7	(1) + (2) + (3)	
8	other curved internal shapes	
9	(1 - 7) + (8)	



*Column XVI : Geometrical shape and machining.
(R)- Internal surface, Internal plane surface and
cyclic surface*

0	none	
1	groove	 e.g. keyway
2	cyclic internal plane surface	 e.g. spline on polygon
3	gear	 e.g. gear
4	(1) + (2)	
5	(1) + (3)	
6	(2) + (3)	
7	(1) + (2) + (3)	
8	other internal plane surface/cyclic surface	
9	(1 ~ 7) + (8)	



Column XVII : Geometrical shape and machining.
(R)- End surface

0	flat	
1	concentric rotational surface	
2	recess/groove	
3	curved surface cyclic surface	
4	(1) + (2)	
5	(1) + (2)	
6	(2) + (3)	
7	(1) + (2) + (3)	
8	other end surface	
9	(1 - 7) + (8)	

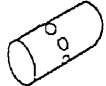
*Column XVIII : Geometrical shape and machining.
(R)- Nonconcentric hole, Pattern of hole(s).*

0		none	
1		axial hole	
2	Radial hole	on base line	
3		on circumference	
4		(1) + (2)	
5		(1) + (3)	
6		(2) + (3)	
7		(1) + (2) + (3)	
8		other regularly arranged holes	
9		(1 - 7) + (8)	

*Column XIX : Geometrical shape and machining.
(R)- Nonconcentric hole, Special hole.*

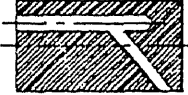
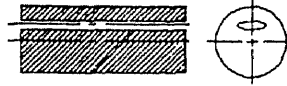
0	none	 <p>e.g. single hole and irregular hole inc.</p>
1	countersunk hole/hole with thread/thread hole	
2	deep hole	
3	odd shaped hole	
4	(1) + (2)	
5	(1) + (3)	
6	(2) + (3)	
7	(1) + (2) + (3)	
8	other special holes	
9	(1 ~ 7) + (8)	

Column XX : Geometrical shape and machining.
(R)- Nonmachining operations.

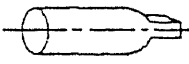
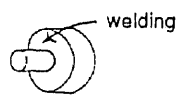
0	none	
1	bending	
2	pressing, forming	
3	welding	
4	(1) + (2)	
5	(1) + (3)	
6	(2) + (3)	
7	(1) + (2) + (3)	
8	other non-machining	
9	(1 ~ 7) + (8)	

Appendix
B

MACHINES

AVAILABLE

NO.	MACHINE	SPECIFICATIONS
1	LATHE # 1	L = 0-50, D = 0-20
2	LATHE # 2	L = 0-20, D = 20-50
3	LATHE # 3	L = 20-150, D = 20-50
4	LATHE # 4	L = 0-50, D = 50-240
5	LATHE # 5	L = 50-240, D = 0-50
6	LATHE # 6	L = 240-1000, D = 0-50
7	LATHE # 7	L = 150-2000, D = 0-400
8	LATHE # 8	L = 0-2000, D = 240-1000
9	LATHE # 9	L = 0-2000, D = 1000-2000
10	LATHE # 10	L = 20-240, D = 0-50-240
11	LATHE # 11	FOR COPPER METAL
12	LATHE # 12	FOR LIGHT METAL
13	LATHE # 13	FOR NON METAL
14	LATHE # 14	FOR TOO BIG PARTS
15	DRILL # 1	TURRET, L = 0-600, D = 0-600
16	DRILL # 2	RADIAL, L = 0-100, D = 0-2000
17	DRILL # 3	FOR SPECIAL HOLES

18	DRILL # 4	FOR TOO BIG PARTS
19	MCG. # 1	INT. FOR TOO BIG PARTS
20	MCG. # 2	INT. L = 0-150, D = 0-1000
21	MCG. # 1	EXT. FOR COMPLEX FEATURES
22	MILL # 1	L = 0-240, D = 0-50
23	MILL # 2	L = 0-2000, D = 0-2000
24	GEAR CUT # 1	L = 0-2000, D = 0-2000
25	GEAR CUT # 2	EXT. SPLI/CYCLIC. FOR TOO BIG PARTS

BIBLIOGRAPHY

-
- (1) CAM-I, CAPP , Users Manual, PS-76-PPP-03, Version 2.1A, CAM-I inc., Arlington, Texas.
 - (2) CAM-I, "*Proceedings of the coding and classification workshop*," P-75-PPP-01, Arlington, Texas, June 23-24, 1975.
 - (3) T.C. Chang and R.A. Wysk., "*An introduction to automated process planning systems*," Prentice hall inc., Englewood Cliffs, N J 07632, 1984.
 - (4) T.C. Chang and R.A. Wysk, "CAD/ Generative Process Planning with TIPPS , "*Journal of Manufacturing Systems*, vol.II, no.2, pp129-135.
 - (5) T.C. Chang, R.A. Wysk and Inyong Ham, "Automated Process Planning Systems -
-

An overview of ten years of activities “.

- (6) Peter W. Chevalier, “ Group Technology- The connecting link to integration of CAD and CAM, ” CASA/SME Autofact Europe Conference, Organization for Industrial Research Europe inc. , September 1983.
 - (7) David Marion, J.Rubinovich and Inyong Ham, “ Development of group technology coding and classification scheme ,” *System Integration Series, Part #3, IE transactions*, pp. 90-97, July 1986.
 - (8) Allen K. Dell, “Automated Process Planning Systems: Design and use , “*Computers in Manufacturing Series*, 1985.
 - (9) Y. Descotte and J.C. Latombe, “GARI: A Problem Solver that plan how to machine mechanical parts , “*Proc. of Seventh Intenational Joint conf. of Artificial Intelligence* , August 1981.
 - (10) Richard L. Desslin, “ Group Technology , “ IIT Research Institute, Chicago, Illinois.
 - (11) Mark S. Dunn , Jr., and Wilbur S. Mann , “ Computerized Production Process Plan
-

-
- ning (CAPP) by , “ United Technologies Research corp., Report# R 77-942625-14,
November 1977.
- (12) C.D. Emerson, Vincent Bond, and Inyong Ham , “ Automated Coding and Process
Selection (ACAPS), “ Society of Manufacturing Engineers, May 1981.
- (13) Edward J. Edlard, “ The new role of Group Technology in factory automation by ,”
Litton Integrated Systems Technology, Florence, Kentucky.
- (14) J. Gombinski , “ Component Classification- Why and How ?,” *Summery of a Paper
presented in Machinery and Production Engineering*, pp. 547-550, March 20, 1968.
- (15) W.J. Hallett, “ Classifying 250,000 drawings by Brisch system , “ *Machine Design*,
February 13, 1964.
- (16) Inyong Ham, “ Introduction to Group Technology , “ *SME Technical paper #
MMR76-03*, 1976.
- (17) Alexander Houtzeel, “ Computer Assisted Process Planning minimizes Design and
Manufacturing costs, “ *Organization for Industrial Research inc., IE Transactions*,
pp. 60-64, November 1981.
-

-
- (18) C.H. Link, "CAM-I Automated Process Planning Systems , " *SME Technical Paper* # MS78-213, 1978 .
- (19) Meenakshi R. Sundaram, " Applying Group Technology - A case study , " *Autofact* 1986, pp. 300-317.
- (20) Joe Tulkoff, " CAM-I CAPP system , " Lockheed-Georgia Company, U.S.A.
- (21) Hsu-pin Wang , " Micro CAPP," Ph. D. Thesis, Pennsylvania State University, University Park, PA-16801
- (22) Richard A. Wysk, " Automated Process Planning and Selection Program(APPAS), " Ph. D. Thesis , Purdue University, West Lafayette, Indiana, 1977
-